

1 Bolts



2 Hexagon socket products



3 Nuts, rivet nuts & inserts



4 Threaded rods & studbolts



5 Hook & eye products



6 Screws

I Index



7 Washers & O-rings

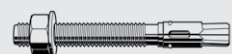

8 Anchoring products

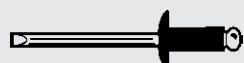

9 Rivets, pins & keys



10 Systems, furniture & security fasteners



11 Assortments & storage systems

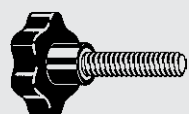



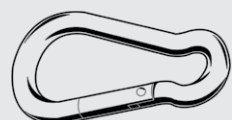



12 Engineering parts & machine parts



13 Maritime products

T Fastening technology

Bolts 1

 Page 1-2 ISO 4014 Metric	 Page 1-18 DIN 601/555 (1987) With hexagon nut Metric	 Page 1-19 ISO 4017 Metric	 Page 1-35 DIN ≈933 With slot Metric	 Page 1-36 ISO 8765 Metric fine
 Page 1-39 ISO 8676 Metric fine	 Page 1-41 ASME ≈B18.2.1 UNC	 Page 1-52 ASME ≈B18.2.1 UNF	 Page 1-58 DIN ≈931 (1954) BSW	 Page 1-59 BS ≈1083 (1965) BSF
 Page 1-60 DIN ≈933 (1954) BSW	 Page 1-61 BS ≈1083 (1965) BSF	 Page 1-62 RIPP self-locking Metric	 Page 1-64 Self-locking Metric	 Page 1-66 DIN 6921 Metric
 Page 1-67 DIN ≈6921 Fully threaded Metric	 Page 1-68 DIN ≈6921 Serrated fully threaded Metric	 Page 1-70 DIN 6921 Metric fine	 Page 1-71 DIN 609 With long thread Metric	 Page 1-72 DIN 603 Without hexagon nut Metric
 Page 1-74 DIN ≈603 Without hexagon nut Metric fully threaded	 Page 1-75 DIN 603/555 (1987) With hexagon nut Metric	 Page 1-77 ASME B18.5.2.3M Carriage bolts UNC	 Page 1-80 DIN ≈608 With short square neck Metric	 Page 1-80 DIN - / 555 (1987) SEHA Metric
 Page 1-81 DIN 604/555 (1987) With hexagon nut Metric	 Page 1-82 DIN 605/555 (1987) With square neck and hexagon nut Metric	 Page 1-82 DIN 15237 Seating screw Metric	 Page 1-83 DIN 15237 For seating screws	 Page 1-84 DIN 479 With short dog point Metric
 Page 1-85 Square head bolt low UNC	 Page 1-86 DIN 561 With small hexagon and dog point Metric	 Page 1-87 Trackshoe bolt UNF	 Page 1-89 EN 14399-4 PEINER HV	 Page 1-91 EN 14399-4 PEINER HV
 Page 1-92 EN 14399-6 PEINER HV	 Page 1-93 DIN 6917 PEINER I-sections HV	 Page 1-93 DIN 6918 PEINER U-sections HV	 Page 1-94 EN 15048 Structural assembly set, CE marking	 Page 1-96 EN 15048 Structural assembly set, CE marking
 Page 1-98 Plastic				

Hexagon head bolt

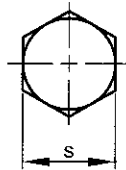
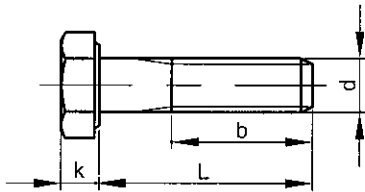

ISO 4014
 DIN 931
 NEN 1555
 ASME B18.2.3.1M
 NF E25-112

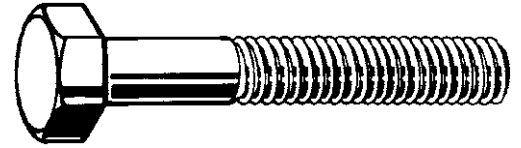

Technical Data

d	b (min.): L≤125mm	b (min.): 125mm<L≤200mm	b (min.): L>200mm	k	P	s
M4	14	-	-	2.8	0.7	7
M5	16	22	-	3.5	0.8	8
M6	18	24	-	4	1	10
M7	20	26	-	4.8	1	11
M8	22	28	-	5.3	1.25	13
M10 (DIN)	26	32	45	6.4	1.5	17
M10	26	-	-	6.4	1.5	16
M12 (DIN)	30	36	49	7.5	1.75	19
M12	30	36	-	7.5	1.75	18
M14 (DIN)	34	40	53	8.8	2	22
M14	34	40	-	8.8	2	21
M16	38	44	57	10	2	24
M18	42	48	61	11.5	2.5	27
M20	46	52	65	12.5	2.5	30
M22 (DIN)	50	56	69	14	2.5	32
M22	50	56	69	14	2.5	34
M24	54	60	73	15	3	36
M27	60	66	79	17	3	41
M30	66	72	85	18.7	3.5	46
M33	72	78	91	21	3.5	50
M36	78	84	97	22.5	4	55
M39	84	90	103	25	4	60
M42	90	96	109	26	4.5	65
M45	96	102	115	28	4.5	70
M48	102	108	121	30	5	75
M52	-	116	119	33	5	80
M56	-	124	137	35	5.5	85
M60	-	132	145	38	5.5	90
M64	-	140	153	40	6	95

• Size 'b' is a guide value, it indicates on the minimum length of the threaded part.

Article groups

Thread	Driving features	Material	Class	Surface treatment	Color	Code	Page
M	Hexagon	St	8.8			01000	1-3
M	Hexagon	St	8.8	Zipl		01200	1-5
M	Hexagon	St	8.8	Zipl yell.p.		01220	1-6
M	Hexagon	St	8.8	FLZNNC-NC6		01226	1-7
M	Hexagon	St	8.8	Hot d.g.	ISO metric	01400	1-8
M	Hexagon	St	8.8	Hot d.g.	oversized	01420	1-9
M	Hexagon	St	10.9			04100	1-10
M	Hexagon	St	10.9	FLZNNC-NC6		04105	1-11
M	Hexagon	St	12.9			04108	1-11
M	Hexagon	St	5.6		for pressure vessels	08750	1-12
M	Hexagon	St.St. A2	70			51000	1-12
M	Hexagon	St.St. A4	70			55000	1-14
M	Hexagon	St.St. A4	80			53510	1-16
M	Hexagon	St 25CrMo4+QT	KG			23010	1-17
M	Hexagon	Plastic PA	PA 6.6		White	56090	1-17

01000 Hexagon head bolt		A01A	
Thread	Metric thread		
Material	Steel		
Class	8.8		

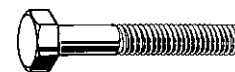

d x L	☒	Art.number	d x L	☒	Art.number	d x L	☒	Art.number
M4X25	500	01000.040.025	M12X45/S=19	100	01000.120.045	M16X380	10	01000.160.380
M4X30	500	01000.040.030	M12X50/S=19	100	01000.120.050	M16X400	10	01000.160.400
M4X40	500	01000.040.040	M12X55/S=19	100	01000.120.055			
M5X30	200	01000.050.030	M12X60/S=19	100	01000.120.060	M18X55	25	01000.180.055
M5X35	200	01000.050.035	M12X65/S=19	50	01000.120.065	M18X60	25	01000.180.060
M5X40	200	01000.050.040	M12X70/S=19	50	01000.120.070	M18X65	25	01000.180.065
M5X45	200	01000.050.045	M12X75/S=19	50	01000.120.075	M18X70	25	01000.180.070
M5X50	200	01000.050.050	M12X80/S=19	50	01000.120.080	M18X75	25	01000.180.075
M5X55	200	01000.050.055	M12X85/S=19	50	01000.120.085	M18X80	25	01000.180.080
M5X60	200	01000.050.060	M12X90/S=19	50	01000.120.090	M18X85	25	01000.180.085
M5X70	200	01000.050.070	M12X100/S=19	50	01000.120.100	M18X90	25	01000.180.090
			M12X110/S=19	50	01000.120.110	M18X100	25	01000.180.100
			M12X120/S=19	50	01000.120.120	M18X110	25	01000.180.110
M6X30	200	01000.060.030	M12X130/S=19	50	01000.120.130	M18X120	25	01000.180.120
M6X35	200	01000.060.035	M12X140/S=19	50	01000.120.140	M18X130	25	01000.180.130
M6X40	200	01000.060.040	M12X150/S=19	50	01000.120.150	M18X140	25	01000.180.140
M6X45	200	01000.060.045	M12X160/S=19	25	01000.120.160	M18X150	25	01000.180.150
M6X50	200	01000.060.050	M12X170/S=19	25	01000.120.170	M18X160	25	01000.180.160
M6X55	200	01000.060.055	M12X180/S=19	25	01000.120.180	M18X170	25	01000.180.170
M6X60	200	01000.060.060	M12X190/S=19	25	01000.120.190	M18X180	10	01000.180.180
M6X65	200	01000.060.065	M12X200/S=19	25	01000.120.200	M18X200	10	01000.180.200
M6X70	200	01000.060.070	M12X220/S=19	25	01000.120.220	M18X220	10	01000.180.220
M6X75	200	01000.060.075	M12X240/S=19	25	01000.120.240	M18X240	10	01000.180.240
M6X80	200	01000.060.080	M12X260/S=19	25	01000.120.260	M18X260	10	01000.180.260
M6X90	200	01000.060.090	M12X280/S=19	25	01000.120.280	M18X280	10	01000.180.280
						M18X300	10	01000.180.300
						M18X320	10	01000.180.320
M7X30	200	01000.070.030	M14X50/S=22	50	01000.140.050	M20X60	50	01000.200.060
M7X35	200	01000.070.035	M14X55/S=22	50	01000.140.055	M20X65	25	01000.200.065
M7X40	200	01000.070.040	M14X60/S=22	50	01000.140.060	M20X70	25	01000.200.070
M7X50	200	01000.070.050	M14X65/S=22	50	01000.140.065	M20X75	25	01000.200.075
M7X60	200	01000.070.060	M14X70/S=22	50	01000.140.070	M20X80	25	01000.200.080
			M14X75/S=22	50	01000.140.075	M20X85	25	01000.200.085
M8X35	200	01000.080.035	M14X80/S=22	50	01000.140.080	M20X90	25	01000.200.090
M8X40	200	01000.080.040	M14X90/S=22	50	01000.140.090	M20X100	25	01000.200.100
M8X45	200	01000.080.045	M14X100/S=22	50	01000.140.100	M20X110	25	01000.200.110
M8X50	200	01000.080.050	M14X110/S=22	50	01000.140.110	M20X120	25	01000.200.120
M8X55	200	01000.080.055	M14X120/S=22	50	01000.140.120	M20X130	25	01000.200.130
M8X60	200	01000.080.060	M14X130/S=22	25	01000.140.130	M20X140	25	01000.200.140
M8X65	200	01000.080.065	M14X140/S=22	25	01000.140.140	M20X150	25	01000.200.150
M8X70	200	01000.080.070	M14X150/S=22	25	01000.140.150	M20X160	10	01000.200.160
M8X75	200	01000.080.075	M14X160/S=22	25	01000.140.160	M20X170	10	01000.200.170
M8X80	200	01000.080.080	M14X180/S=22	25	01000.140.180	M20X180	10	01000.200.180
M8X85	100	01000.080.085	M14X200/S=22	25	01000.140.200	M20X190	10	01000.200.190
M8X90	100	01000.080.090				M20X200	10	01000.200.200
M8X100	100	01000.080.100	M16X50	100	01000.160.050	M20X220	10	01000.200.220
M8X110	100	01000.080.110	M16X55	50	01000.160.055	M20X230	10	01000.200.230
M8X120	100	01000.080.120	M16X60	50	01000.160.060	M20X240	10	01000.200.240
M8X130	100	01000.080.130	M16X65	25	01000.160.065	M20X250	10	01000.200.250
M8X140	50	01000.080.140	M16X70	25	01000.160.070	M20X260	10	01000.200.260
M8X150	50	01000.080.150	M16X75	25	01000.160.075	M20X280	10	01000.200.280
			M16X80	25	01000.160.080	M20X300	10	01000.200.300
M10X35/S=17	100	01000.100.035	M16X85	25	01000.160.085	M20X320	5	01000.200.320
M10X40/S=17	100	01000.100.040	M16X90	25	01000.160.090	M20X340	5	01000.200.340
M10X45/S=17	100	01000.100.045	M16X100	25	01000.160.100	M20X360	5	01000.200.360
M10X50/S=17	100	01000.100.050	M16X110	25	01000.160.110	M20X380	5	01000.200.380
M10X55/S=17	100	01000.100.055	M16X120	25	01000.160.120	M20X400	5	01000.200.400
M10X60/S=17	100	01000.100.060	M16X130	25	01000.160.130			
M10X65/S=17	100	01000.100.065	M16X140	25	01000.160.140			
M10X70/S=17	100	01000.100.070	M16X150	25	01000.160.150			
M10X75/S=17	100	01000.100.075	M16X160	25	01000.160.160	M22X70/S=32	25	01000.220.070
M10X80/S=17	100	01000.100.080	M16X170	25	01000.160.170	M22X75/S=32	25	01000.220.075
M10X85/S=17	100	01000.100.085	M16X180	25	01000.160.180	M22X80/S=32	25	01000.220.080
M10X90/S=17	100	01000.100.090	M16X190	25	01000.160.190	M22X90/S=32	25	01000.220.090
M10X100/S=17	100	01000.100.100	M16X200	25	01000.160.200	M22X100/S=32	10	01000.220.100
M10X110/S=17	50	01000.100.110	M16X210	25	01000.160.210	M22X110/S=32	10	01000.220.110
M10X120/S=17	50	01000.100.120	M16X220	25	01000.160.220	M22X120/S=32	10	01000.220.120
M10X130/S=17	50	01000.100.130	M16X230	25	01000.160.230	M22X130/S=32	10	01000.220.130
M10X140/S=17	50	01000.100.140	M16X240	10	01000.160.240	M22X140/S=32	10	01000.220.140
M10X150/S=17	50	01000.100.150	M16X260	10	01000.160.260	M22X150/S=32	10	01000.220.150
M10X160/S=17	50	01000.100.160	M16X270	10	01000.160.270	M22X160/S=32	10	01000.220.160
M10X170/S=17	50	01000.100.170	M16X280	10	01000.160.280	M22X170/S=32	10	01000.220.170
M10X180/S=17	50	01000.100.180	M16X300	10	01000.160.300	M22X180/S=32	10	01000.220.180
M10X200/S=17	50	01000.100.200	M16X320	10	01000.160.320	M22X190/S=32	10	01000.220.190
			M16X340	10	01000.160.340	M22X200/S=32	5	01000.220.200
M12X40/S=19	100	01000.120.040	M16X360	10	01000.160.360	M22X220/S=32	5	01000.220.220

01000 Hexagon head bolt								
d x L	☒	Art.number	d x L	☒	Art.number	d x L	☒	Art.number
M22X240/S=32	5	01000.220.240	M30X400	2	01000.300.400	M42X200	1	01000.420.200
M22X260/S=32	5	01000.220.260	M30X420	2	01000.300.420	M42X220	1	01000.420.220
M22X280/S=32	5	01000.220.280	M30X440	2	01000.300.440	M42X240	1	01000.420.240
M22X300/S=32	5	01000.220.300	M30X480	2	01000.300.480	M42X260	1	01000.420.260
M24X70	25	01000.240.070	M33X100	5	01000.330.100	M42X280	1	01000.420.280
M24X75	25	01000.240.075	M33X110	5	01000.330.110	M42X300	1	01000.420.300
M24X80	25	01000.240.080	M33X120	5	01000.330.120	M42X320	1	01000.420.320
M24X85	25	01000.240.085	M33X130	5	01000.330.130	M42X340	1	01000.420.340
M24X90	10	01000.240.090	M33X140	5	01000.330.140	M42X360	1	01000.420.360
M24X100	10	01000.240.100	M33X150	5	01000.330.150	M42X400	1	01000.420.400
M24X110	10	01000.240.110	M33X160	5	01000.330.160	M42X420	1	01000.420.420
M24X120	10	01000.240.120	M33X170	2	01000.330.170	M42X460	1	01000.420.460
M24X130	10	01000.240.130	M33X180	2	01000.330.180	M42X480	1	01000.420.480
M24X140	10	01000.240.140	M33X190	2	01000.330.190	M42X500	1	01000.420.500
M24X150	10	01000.240.150	M33X200	2	01000.330.200	M45X120	1	01000.450.120
M24X160	10	01000.240.160	M33X220	2	01000.330.220	M45X140	1	01000.450.140
M24X170	10	01000.240.170	M33X240	2	01000.330.240	M45X160	1	01000.450.160
M24X180	10	01000.240.180	M33X250	2	01000.330.250	M45X180	1	01000.450.180
M24X190	10	01000.240.190	M33X260	2	01000.330.260	M45X200	1	01000.450.200
M24X200	10	01000.240.200	M33X280	2	01000.330.280	M45X220	1	01000.450.220
M24X210	10	01000.240.210	M33X300	2	01000.330.300	M45X240	1	01000.450.240
M24X220	10	01000.240.220	M33X320	2	01000.330.320	M45X280	1	01000.450.280
M24X240	10	01000.240.240	M33X340	2	01000.330.340	M45X300	1	01000.450.300
M24X250	10	01000.240.250	M33X360	2	01000.330.360	M45X320	1	01000.450.320
M24X260	10	01000.240.260				M45X360	1	01000.450.360
M24X280	10	01000.240.280	M36X100	5	01000.360.100			
M24X300	10	01000.240.300	M36X110	5	01000.360.110	M48X140	1	01000.480.140
M24X320	5	01000.240.320	M36X120	5	01000.360.120	M48X150	1	01000.480.150
M24X340	5	01000.240.340	M36X130	5	01000.360.130	M48X160	1	01000.480.160
M24X360	5	01000.240.360	M36X140	5	01000.360.140	M48X170	1	01000.480.170
M24X380	5	01000.240.380	M36X150	5	01000.360.150	M48X180	1	01000.480.180
M24X400	5	01000.240.400	M36X160	5	01000.360.160	M48X200	1	01000.480.200
M24X420	5	01000.240.420	M36X170	2	01000.360.170	M48X220	1	01000.480.220
M24X440	5	01000.240.440	M36X180	2	01000.360.180	M48X240	1	01000.480.240
M24X450	5	01000.240.450	M36X190	2	01000.360.190	M48X260	1	01000.480.260
			M36X200	2	01000.360.200	M48X280	1	01000.480.280
M27X80	10	01000.270.080	M36X220	2	01000.360.220	M48X300	1	01000.480.300
M27X90	10	01000.270.090	M36X240	2	01000.360.240	M48X320	1	01000.480.320
M27X100	10	01000.270.100	M36X250	2	01000.360.250	M48X360	1	01000.480.360
M27X110	10	01000.270.110	M36X260	2	01000.360.260	M48X400	1	01000.480.400
M27X120	10	01000.270.120	M36X270	2	01000.360.270	M48X500	1	01000.480.500
M27X130	10	01000.270.130	M36X280	2	01000.360.280			
M27X140	10	01000.270.140	M36X300	2	01000.360.300	M52X160	1	01000.520.160
M27X150	10	01000.270.150	M36X320	1	01000.360.320	M52X180	1	01000.520.180
M27X160	10	01000.270.160	M36X340	1	01000.360.340	M52X200	1	01000.520.200
M27X170	5	01000.270.170	M36X360	1	01000.360.360	M52X240	1	01000.520.240
M27X180	5	01000.270.180	M36X380	1	01000.360.380	M52X280	1	01000.520.280
M27X190	5	01000.270.190	M36X400	1	01000.360.400	M52X320	1	01000.520.320
M27X200	5	01000.270.200	M36X420	1	01000.360.420	M52X360	1	01000.520.360
M27X220	5	01000.270.220	M36X440	1	01000.360.440	M52X400	1	01000.520.400
M27X240	5	01000.270.240	M36X460	1	01000.360.460	M52X500	1	01000.520.500
M27X260	5	01000.270.260	M36X480	1	01000.360.480			
M27X280	5	01000.270.280	M36X500	1	01000.360.500	M56X160	1	01000.560.160
M27X300	5	01000.270.300				M56X180	1	01000.560.180
M27X320	5	01000.270.320	M39X110	1	01000.390.110	M56X200	1	01000.560.200
M27X340	5	01000.270.340	M39X120	1	01000.390.120	M56X240	1	01000.560.240
M27X360	5	01000.270.360	M39X130	1	01000.390.130	M56X260	1	01000.560.260
M27X380	5	01000.270.380	M39X140	1	01000.390.140	M56X280	1	01000.560.280
M27X400	5	01000.270.400	M39X150	1	01000.390.150	M56X320	1	01000.560.320
			M39X160	1	01000.390.160	M56X360	1	01000.560.360
M30X90	10	01000.300.090	M39X170	1	01000.390.170	M56X400	1	01000.560.400
M30X100	10	01000.300.100	M39X180	1	01000.390.180	M56X440	1	01000.560.440
M30X110	10	01000.300.110	M39X190	1	01000.390.190			
M30X120	10	01000.300.120	M39X200	1	01000.390.200	M60X160	1	01000.600.160
M30X130	10	01000.300.130	M39X220	1	01000.390.220	M60X180	1	01000.600.180
M30X140	10	01000.300.140	M39X240	1	01000.390.240	M60X200	1	01000.600.200
M30X150	10	01000.300.150	M39X260	1	01000.390.260	M60X240	1	01000.600.240
M30X160	10	01000.300.160	M39X280	1	01000.390.280	M60X280	1	01000.600.280
M30X170	5	01000.300.170	M39X300	1	01000.390.300	M60X320	1	01000.600.320
M30X180	5	01000.300.180	M39X320	1	01000.390.320	M60X360	1	01000.600.360
M30X190	5	01000.300.190	M39X340	1	01000.390.340			
M30X200	5	01000.300.200	M39X360	1	01000.390.360	M64X180	1	01000.640.180
M30X220	5	01000.300.220	M39X400	1	01000.390.400	M64X200	1	01000.640.200
M30X240	5	01000.300.240				M64X240	1	01000.640.240
M30X260	5	01000.300.260	M42X120	1	01000.420.120	M64X280	1	01000.640.280
M30X280	5	01000.300.280	M42X130	1	01000.420.130	M64X320	1	01000.640.320
M30X300	5	01000.300.300	M42X140	1	01000.420.140	M64X360	1	01000.640.360
M30X320	2	01000.300.320	M42X150	1	01000.420.150	M64X400	1	01000.640.400
M30X340	2	01000.300.340	M42X160	1	01000.420.160			
M30X360	2	01000.300.360	M42X180	1	01000.420.180			

01200	Hexagon head bolt	A05A
Thread	Metric thread	 
Material	Steel	
Class	8.8	
Surface treatment	Zinc plated	

d x L	☒	Art.number	d x L	☒	Art.number	d x L	☒	Art.number
M4X25	500	01200.040.025	M10X55/S=16	100	01200.100.056	M14X50/S=22	50	01200.140.050
M4X30	500	01200.040.030	M10X60/S=17	100	01200.100.060	M14X50/S=21	50	01200.140.051
M4X35	500	01200.040.035	M10X60/S=16	100	01200.100.061	M14X55/S=22	50	01200.140.055
M4X40	500	01200.040.040	M10X65/S=17	100	01200.100.065	M14X55/S=21	50	01200.140.056
M4X50	500	01200.040.050	M10X65/S=16	100	01200.100.066	M14X60/S=22	50	01200.140.060
			M10X70/S=17	100	01200.100.070	M14X60/S=21	50	01200.140.061
M5X30	200	01200.050.030	M10X70/S=16	100	01200.100.071	M14X65/S=22	50	01200.140.065
M5X35	200	01200.050.035	M10X75/S=17	100	01200.100.075	M14X70/S=22	50	01200.140.070
M5X40	200	01200.050.040	M10X75/S=16	100	01200.100.076	M14X75/S=22	50	01200.140.075
M5X45	200	01200.050.045	M10X80/S=17	100	01200.100.080	M14X80/S=22	50	01200.140.080
M5X50	200	01200.050.050	M10X80/S=16	100	01200.100.081	M14X80/S=21	50	01200.140.081
M5X55	200	01200.050.055	M10X85/S=17	100	01200.100.085	M14X85/S=22	50	01200.140.085
M5X60	200	01200.050.060	M10X85/S=16	100	01200.100.086	M14X90/S=22	50	01200.140.090
M5X65	200	01200.050.065	M10X90/S=17	100	01200.100.090	M14X100/S=22	50	01200.140.100
M5X70	200	01200.050.070	M10X90/S=16	100	01200.100.091	M14X100/S=21	50	01200.140.101
M5X80	200	01200.050.080	M10X95/S=17	100	01200.100.095	M14X110/S=22	50	01200.140.110
			M10X100/S=17	100	01200.100.100	M14X110/S=21	50	01200.140.111
M6X30	200	01200.060.030	M10X100/S=16	100	01200.100.101	M14X120/S=22	50	01200.140.120
M6X35	200	01200.060.035	M10X110/S=17	50	01200.100.110	M14X130/S=22	25	01200.140.130
M6X40	200	01200.060.040	M10X110/S=16	50	01200.100.111	M14X140/S=22	25	01200.140.140
M6X45	200	01200.060.045	M10X120/S=17	50	01200.100.120	M14X150/S=22	25	01200.140.150
M6X50	200	01200.060.050	M10X120/S=16	50	01200.100.121	M14X160/S=22	25	01200.140.160
M6X55	200	01200.060.055	M10X130/S=17	50	01200.100.130	M14X180/S=22	25	01200.140.180
M6X60	200	01200.060.060	M10X140/S=17	50	01200.100.140	M14X200/S=22	25	01200.140.200
M6X65	200	01200.060.065	M10X150/S=17	50	01200.100.150	M14X220/S=22	25	01200.140.220
M6X70	200	01200.060.070	M10X155/S=17	50	01200.100.155	M14X240/S=22	25	01200.140.240
M6X75	200	01200.060.075	M10X160/S=17	50	01200.100.160	M14X260/S=22	25	01200.140.260
M6X80	200	01200.060.080	M10X170/S=17	50	01200.100.170			
M6X90	100	01200.060.090	M10X180/S=17	50	01200.100.180	M16X50	50	01200.160.050
M6X100	100	01200.060.100	M10X190/S=17	50	01200.100.190	M16X55	50	01200.160.055
M6X110	100	01200.060.110	M10X200/S=17	50	01200.100.200	M16X60	50	01200.160.060
M6X120	100	01200.060.120	M10X210/S=17	25	01200.100.210	M16X65	25	01200.160.065
M6X130	100	01200.060.130	M10X220/S=17	25	01200.100.220	M16X70	25	01200.160.070
M6X140	100	01200.060.140	M10X240/S=17	25	01200.100.240	M16X75	25	01200.160.075
						M16X80	25	01200.160.080
M7X30	200	01200.070.030	M12X40/S=19	100	01200.120.040	M16X85	25	01200.160.085
M7X35	200	01200.070.035	M12X45/S=19	100	01200.120.045	M16X90	25	01200.160.090
M7X40	200	01200.070.040	M12X45/S=18	100	01200.120.046	M16X95	50	01200.160.095
M7X45	200	01200.070.045	M12X50/S=19	100	01200.120.050	M16X100	25	01200.160.100
M7X50	200	01200.070.050	M12X50/S=18	100	01200.120.051	M16X110	25	01200.160.110
M7X60	200	01200.070.060	M12X55/S=19	100	01200.120.055	M16X120	25	01200.160.120
M7X70	200	01200.070.070	M12X55/S=18	100	01200.120.056	M16X130	25	01200.160.130
M7X80	200	01200.070.080	M12X60/S=19	100	01200.120.060	M16X140	25	01200.160.140
			M12X60/S=18	100	01200.120.061	M16X150	25	01200.160.150
M8X35	200	01200.080.035	M12X65/S=19	50	01200.120.065	M16X160	25	01200.160.160
M8X40	200	01200.080.040	M12X65/S=18	50	01200.120.066	M16X170	25	01200.160.170
M8X45	200	01200.080.045	M12X70/S=19	50	01200.120.070	M16X180	25	01200.160.180
M8X50	200	01200.080.050	M12X70/S=18	50	01200.120.071	M16X190	25	01200.160.190
M8X55	200	01200.080.055	M12X75/S=19	50	01200.120.075	M16X200	25	01200.160.200
M8X60	200	01200.080.060	M12X75/S=18	50	01200.120.076	M16X210	25	01200.160.210
M8X65	200	01200.080.065	M12X80/S=19	50	01200.120.080	M16X220	25	01200.160.220
M8X70	200	01200.080.070	M12X80/S=18	50	01200.120.081	M16X230	25	01200.160.230
M8X75	200	01200.080.075	M12X85/S=19	50	01200.120.085	M16X240	10	01200.160.240
M8X80	200	01200.080.080	M12X90/S=19	50	01200.120.090	M16X250	10	01200.160.250
M8X85	200	01200.080.085	M12X90/S=18	50	01200.120.091	M16X260	10	01200.160.260
M8X90	100	01200.080.090	M12X100/S=19	50	01200.120.100	M16X280	10	01200.160.280
M8X95	100	01200.080.095	M12X100/S=18	50	01200.120.101	M16X300	10	01200.160.300
M8X100	100	01200.080.100	M12X110/S=19	50	01200.120.110	M16X320	10	01200.160.320
M8X105	100	01200.080.105	M12X110/S=18	50	01200.120.111	M16X340	10	01200.160.340
M8X110	100	01200.080.110	M12X120/S=19	50	01200.120.120	M16X360	10	01200.160.360
M8X120	100	01200.080.120	M12X120/S=18	50	01200.120.121	M16X380	10	01200.160.380
M8X130	100	01200.080.130	M12X130/S=19	50	01200.120.130	M16X400	10	01200.160.400
M8X140	50	01200.080.140	M12X140/S=19	50	01200.120.140			
M8X150	50	01200.080.150	M12X150/S=19	50	01200.120.150	M18X60	25	01200.180.060
M8X160	50	01200.080.160	M12X160/S=19	25	01200.120.160	M18X65	25	01200.180.065
M8X180	50	01200.080.180	M12X170/S=19	25	01200.120.170	M18X70	25	01200.180.070
M8X200	50	01200.080.200	M12X180/S=19	25	01200.120.180	M18X75	25	01200.180.075
			M12X190/S=19	25	01200.120.190	M18X80	25	01200.180.080
M10X40/S=17	100	01200.100.040	M12X200/S=19	25	01200.120.200	M18X90	25	01200.180.090
M10X40/S=16	100	01200.100.041	M12X220/S=19	25	01200.120.220	M18X100	25	01200.180.100
M10X45/S=17	100	01200.100.045	M12X240/S=19	25	01200.120.240	M18X110	25	01200.180.110
M10X45/S=16	100	01200.100.046	M12X260/S=19	25	01200.120.260	M18X120	25	01200.180.120
M10X50/S=17	100	01200.100.050	M12X280/S=19	25	01200.120.280	M18X130	25	01200.180.130
M10X50/S=16	100	01200.100.051	M12X300/S=19	25	01200.120.300	M18X140	25	01200.180.140
M10X55/S=17	100	01200.100.055				M18X150	25	01200.180.150

01200 Hexagon head bolt								
d x L	☒	Art.number	d x L	☒	Art.number	d x L	☒	Art.number
M18X160	25	01200.180.160	M24X90	10	01200.240.090	M30X130	10	01200.300.130
M18X180	10	01200.180.180	M24X100	10	01200.240.100	M30X140	10	01200.300.140
M18X200	10	01200.180.200	M24X110	10	01200.240.110	M30X150	10	01200.300.150
			M24X120	10	01200.240.120	M30X160	10	01200.300.160
M20X60	25	01200.200.060	M24X130	10	01200.240.130	M30X170	5	01200.300.170
M20X65	25	01200.200.065	M24X140	10	01200.240.140	M30X180	5	01200.300.180
M20X70	25	01200.200.070	M24X150	10	01200.240.150	M30X200	5	01200.300.200
M20X75	25	01200.200.075	M24X160	10	01200.240.160	M30X220	5	01200.300.220
M20X80	25	01200.200.080	M24X170	10	01200.240.170	M30X240	5	01200.300.240
M20X85	25	01200.200.085	M24X180	10	01200.240.180	M30X260	5	01200.300.260
M20X90	25	01200.200.090	M24X190	10	01200.240.190	M30X280	5	01200.300.280
M20X100	25	01200.200.100	M24X200	10	01200.240.200	M30X300	5	01200.300.300
M20X110	25	01200.200.110	M24X210	10	01200.240.210	M30X320	2	01200.300.320
M20X120	25	01200.200.120	M24X220	10	01200.240.220	M30X340	2	01200.300.340
M20X130	25	01200.200.130	M24X230	10	01200.240.230	M30X360	2	01200.300.360
M20X140	25	01200.200.140	M24X240	10	01200.240.240	M30X400	2	01200.300.400
M20X150	25	01200.200.150	M24X260	10	01200.240.260			
M20X160	10	01200.200.160	M24X280	10	01200.240.280	M33X100	5	01200.330.100
M20X170	10	01200.200.170	M24X300	10	01200.240.300	M33X110	5	01200.330.110
M20X180	10	01200.200.180	M24X320	5	01200.240.320	M33X120	5	01200.330.120
M20X190	10	01200.200.190	M24X340	5	01200.240.340	M33X130	5	01200.330.130
M20X200	10	01200.200.200	M24X360	5	01200.240.360	M33X140	5	01200.330.140
M20X220	10	01200.200.220	M24X380	5	01200.240.380	M33X150	5	01200.330.150
M20X240	10	01200.200.240	M24X400	5	01200.240.400	M33X160	5	01200.330.160
M20X260	10	01200.200.260				M33X180	2	01200.330.180
M20X280	10	01200.200.280	M27X80	10	01200.270.080	M33X200	2	01200.330.200
M20X300	10	01200.200.300	M27X90	10	01200.270.090	M33X280	1	01200.330.280
M20X320	5	01200.200.320	M27X100	10	01200.270.100			
			M27X110	10	01200.270.110	M36X100	5	01200.360.100
M22X70/S=32	25	01200.220.070	M27X120	10	01200.270.120	M36X110	5	01200.360.110
M22X75/S=32	25	01200.220.075	M27X130	10	01200.270.130	M36X120	5	01200.360.120
M22X80/S=32	25	01200.220.080	M27X140	10	01200.270.140	M36X130	5	01200.360.130
M22X90/S=32	25	01200.220.090	M27X150	10	01200.270.150	M36X140	5	01200.360.140
M22X100/S=32	10	01200.220.100	M27X160	10	01200.270.160	M36X150	5	01200.360.150
M22X110/S=32	10	01200.220.110	M27X180	5	01200.270.180	M36X160	5	01200.360.160
M22X120/S=32	10	01200.220.120	M27X190	5	01200.270.190	M36X170	5	01200.360.170
M22X130/S=32	10	01200.220.130	M27X200	5	01200.270.200	M36X180	2	01200.360.180
M22X140/S=32	10	01200.220.140	M27X220	5	01200.270.220	M36X200	2	01200.360.200
M22X150/S=32	10	01200.220.150	M27X240	5	01200.270.240	M36X220	2	01200.360.220
M22X160/S=32	10	01200.220.160	M27X260	5	01200.270.260	M36X240	2	01200.360.240
M22X180/S=32	10	01200.220.180	M27X280	5	01200.270.280	M36X260	2	01200.360.260
M22X200/S=32	5	01200.220.200	M27X300	5	01200.270.300	M36X280	2	01200.360.280
						M36X300	2	01200.360.300
M24X70	25	01200.240.070	M30X90	10	01200.300.090			
M24X75	25	01200.240.075	M30X100	10	01200.300.100	M39X160	1	01200.390.160
M24X80	25	01200.240.080	M30X110	10	01200.300.110			
M24X85	10	01200.240.085	M30X120	10	01200.300.120			

01220 Hexagon head bolt		A06A
Thread	Metric thread	
Material	Steel	
Class	8.8	
Surface treatment	Zinc plated yellow passivated	

d x L	☒	Art.number	d x L	☒	Art.number	d x L	☒	Art.number
M4X25	500	01220.040.025	M6X80	200	01220.060.080	M8X150	100	01220.080.150
M4X30	500	01220.040.030	M6X90	100	01220.060.090	M8X160	50	01220.080.160
M4X40	500	01220.040.040	M6X100	100	01220.060.100	M8X180	50	01220.080.180
M4X50	500	01220.040.050	M6X110	100	01220.060.110			
			M6X120	100	01220.060.120	M10X40/S=17	100	01220.100.040
M5X30	200	01220.050.030	M6X130	100	01220.060.130	M10X45/S=17	100	01220.100.045
M5X35	200	01220.050.035				M10X50/S=17	100	01220.100.050
M5X40	200	01220.050.040	M8X35	200	01220.080.035	M10X55/S=17	100	01220.100.055
M5X45	200	01220.050.045	M8X40	200	01220.080.040	M10X60/S=17	100	01220.100.060
M5X50	200	01220.050.050	M8X45	200	01220.080.045	M10X65/S=17	100	01220.100.065
M5X55	200	01220.050.055	M8X50	200	01220.080.050	M10X70/S=17	100	01220.100.070
M5X60	200	01220.050.060	M8X55	200	01220.080.055	M10X75/S=17	100	01220.100.075
M5X70	200	01220.050.070	M8X60	200	01220.080.060	M10X80/S=17	100	01220.100.080
M5X80	200	01220.050.080	M8X65	200	01220.080.065	M10X85/S=17	100	01220.100.085
			M8X70	200	01220.080.070	M10X90/S=17	100	01220.100.090
M6X30	200	01220.060.030	M8X75	200	01220.080.075	M10X100/S=17	100	01220.100.100
M6X35	200	01220.060.035	M8X80	200	01220.080.080	M10X110/S=17	50	01220.100.110
M6X40	200	01220.060.040	M8X90	100	01220.080.090	M10X120/S=17	50	01220.100.120
M6X45	200	01220.060.045	M8X100	100	01220.080.100	M10X130/S=17	50	01220.100.130
M6X50	200	01220.060.050	M8X110	100	01220.080.110	M10X140/S=17	50	01220.100.140
M6X55	200	01220.060.055	M8X120	100	01220.080.120	M10X150/S=17	50	01220.100.150
M6X60	200	01220.060.060	M8X130	100	01220.080.130	M10X160/S=17	50	01220.100.160
M6X70	200	01220.060.070	M8X140	100	01220.080.140	M10X170/S=17	50	01220.100.170

01220 Hexagon head bolt								
d x L	☒	Art.number	d x L	☒	Art.number	d x L	☒	Art.number
M10X180/S=17	50	01220.100.180	M16X60	50	01220.160.060	M24X80	25	01220.240.080
M10X200/S=17	50	01220.100.200	M16X65	25	01220.160.065	M24X90	10	01220.240.090
M10X220/S=17	50	01220.100.220	M16X70	25	01220.160.070	M24X100	10	01220.240.100
M12X45/S=19	100	01220.120.045	M16X75	25	01220.160.075	M24X110	10	01220.240.110
M12X50/S=19	100	01220.120.050	M16X80	25	01220.160.080	M24X120	10	01220.240.120
M12X55/S=19	100	01220.120.055	M16X90	25	01220.160.090	M24X130	10	01220.240.130
M12X60/S=19	100	01220.120.060	M16X100	25	01220.160.100	M24X140	10	01220.240.140
M12X65/S=19	50	01220.120.065	M16X110	25	01220.160.110	M24X150	10	01220.240.150
M12X70/S=19	50	01220.120.070	M16X120	25	01220.160.120	M24X160	10	01220.240.160
M12X75/S=19	50	01220.120.075	M16X130	25	01220.160.130	M24X180	10	01220.240.180
M12X80/S=19	50	01220.120.080	M16X140	25	01220.160.140	M24X200	10	01220.240.200
M12X90/S=19	50	01220.120.090	M16X150	25	01220.160.150	M24X220	10	01220.240.220
M12X100/S=19	50	01220.120.100	M16X160	25	01220.160.160	M24X240	10	01220.240.240
M12X110/S=19	50	01220.120.110	M16X180	25	01220.160.180	M24X260	10	01220.240.260
M12X120/S=19	50	01220.120.120	M16X200	25	01220.160.200	M24X280	10	01220.240.280
M12X120/S=19	50	01220.120.120	M16X220	25	01220.160.220	M24X300	10	01220.240.300
M12X130/S=19	50	01220.120.130	M16X240	25	01220.160.240	M27X100	10	01220.270.100
M12X140/S=19	50	01220.120.140	M20X65	25	01220.200.065	M27X110	10	01220.270.110
M12X150/S=19	50	01220.120.150	M20X70	25	01220.200.070	M27X120	10	01220.270.120
M12X160/S=19	50	01220.120.160	M20X75	25	01220.200.075	M27X140	10	01220.270.140
M12X180/S=19	50	01220.120.180	M20X80	25	01220.200.080	M27X160	10	01220.270.160
M12X200/S=19	50	01220.120.200	M20X90	25	01220.200.090	M27X180	5	01220.270.180
M12X220/S=19	50	01220.120.220	M20X100	25	01220.200.100	M27X200	5	01220.270.200
M12X240/S=19	50	01220.120.240	M20X110	25	01220.200.110	M30X100	10	01220.300.100
M14X50/S=22	50	01220.140.050	M20X120	25	01220.200.120	M30X120	10	01220.300.120
M14X55/S=22	50	01220.140.055	M20X130	25	01220.200.130	M30X130	10	01220.300.130
M14X60/S=22	50	01220.140.060	M20X140	25	01220.200.140	M30X140	10	01220.300.140
M14X70/S=22	50	01220.140.070	M20X150	25	01220.200.150	M30X160	10	01220.300.160
M14X80/S=22	50	01220.140.080	M20X160	10	01220.200.160	M30X180	5	01220.300.180
M14X90/S=22	50	01220.140.090	M20X180	10	01220.200.180	M30X200	5	01220.300.200
M14X100/S=22	50	01220.140.100	M20X190	10	01220.200.190	M33X100	10	01220.330.100
M14X110/S=22	50	01220.140.110	M20X200	10	01220.200.200	M33X120	5	01220.330.120
M14X120/S=22	50	01220.140.120	M20X220	10	01220.200.220	M33X140	5	01220.330.140
M14X130/S=22	25	01220.140.130	M20X240	10	01220.200.240	M33X160	5	01220.330.160
M14X140/S=22	25	01220.140.140	M20X260	10	01220.200.260	M33X180	5	01220.330.180
M14X150/S=22	25	01220.140.150	M20X280	10	01220.200.280	M33X200	5	01220.330.200
M14X160/S=22	25	01220.140.160	M20X300	10	01220.200.300	M36X120	5	01220.360.120
M14X180/S=22	25	01220.140.180	M22X120/S=32	25	01220.220.120	M36X180	5	01220.360.180
M14X200/S=22	25	01220.140.200	M22X130/S=32	25	01220.220.130			
M16X55	50	01220.160.055						

01226 Hexagon head bolt			A96A		
Thread	Metric thread				
Material	Steel				
Class	8.8				
Surface treatment	Zinc flake Cr ⁶⁺ free - ISO 10683 flZnnc				

d x L	☒	Art.number	d x L	☒	Art.number	d x L	☒	Art.number
M6X30	200	01226.060.030	M12X45/S=19	100	01226.120.045	M16X160	25	01226.160.160
M6X35	200	01226.060.035	M12X50/S=19	100	01226.120.050	M16X180	25	01226.160.180
M6X40	200	01226.060.040	M12X55/S=19	100	01226.120.055	M18X60	25	01226.180.060
M6X45	200	01226.060.045	M12X60/S=19	100	01226.120.060	M18X80	25	01226.180.080
M6X50	200	01226.060.050	M12X65/S=19	50	01226.120.065	M18X90	25	01226.180.090
M6X60	200	01226.060.060	M12X70/S=19	50	01226.120.070	M20X65	25	01226.200.065
M8X35	200	01226.080.035	M12X80/S=19	50	01226.120.080	M20X70	25	01226.200.070
M8X40	200	01226.080.040	M12X90/S=19	50	01226.120.090	M20X75	25	01226.200.075
M8X45	200	01226.080.045	M12X100/S=19	50	01226.120.100	M20X80	25	01226.200.080
M8X50	200	01226.080.050	M12X110/S=19	50	01226.120.110	M20X85	25	01226.200.085
M8X55	200	01226.080.055	M12X120/S=19	50	01226.120.120	M20X90	25	01226.200.090
M8X60	200	01226.080.060	M12X140/S=19	50	01226.120.140	M20X100	25	01226.200.100
M8X70	200	01226.080.070	M12X150/S=19	50	01226.120.150	M20X110	25	01226.200.110
M8X80	200	01226.080.080	M12X170/S=19	25	01226.120.170	M20X120	25	01226.200.120
M8X90	100	01226.080.090	M16X55	50	01226.160.055	M20X130	25	01226.200.130
M8X110	100	01226.080.110	M16X60	50	01226.160.060	M20X140	25	01226.200.140
M10X40/S=17	100	01226.100.040	M16X65	25	01226.160.065	M20X150	25	01226.200.150
M10X45/S=17	100	01226.100.045	M16X70	25	01226.160.070	M20X160	10	01226.200.160
M10X50/S=17	100	01226.100.050	M16X75	25	01226.160.075	M20X180	10	01226.200.180
M10X60/S=17	100	01226.100.060	M16X80	25	01226.160.080	M20X200	10	01226.200.200
M10X70/S=17	100	01226.100.070	M16X90	25	01226.160.090	M24X70	25	01226.240.070
M10X80/S=17	100	01226.100.080	M16X100	25	01226.160.100	M24X80	25	01226.240.080
M10X90/S=17	100	01226.100.090	M16X110	25	01226.160.110	M24X90	10	01226.240.090
M10X100/S=17	100	01226.100.100	M16X120	25	01226.160.120	M24X100	10	01226.240.100
M10X120/S=17	50	01226.100.120	M16X130	25	01226.160.130	M24X110	10	01226.240.110
			M16X140	25	01226.160.140			
			M16X150	25	01226.160.150			



01226 Hexagon head bolt								
d x L	☒	Art.number	d x L	☒	Art.number	d x L	☒	Art.number
M24X130	10	01226.240.130	M24X160	10	01226.240.160	M24X200	10	01226.240.200
M24X140	10	01226.240.140	M24X180	10	01226.240.180			

• A ISO 10683 Zinc Flake surface coating eliminates the possibilities of damage which can arise due to hydrogen embrittlement.

01400 Hexagon head bolt ISO-Metric fitting thread								A08A
Thread	Metric thread							
Material	Steel							
Class	8.8							
Surface treatment	Hot dip galvanized							
								

d x L	☒	Art.number	d x L	☒	Art.number	d x L	☒	Art.number
M8X35	100	01400.080.035	M16X75	25	01400.160.075	M24X80	25	01400.240.080
M8X40	100	01400.080.040	M16X80	25	01400.160.080	M24X90	10	01400.240.090
M8X45	100	01400.080.045	M16X90	25	01400.160.090	M24X100	10	01400.240.100
M8X50	100	01400.080.050	M16X100	25	01400.160.100	M24X110	10	01400.240.110
M8X55	100	01400.080.055	M16X110	25	01400.160.110	M24X120	10	01400.240.120
M8X60	100	01400.080.060	M16X120	25	01400.160.120	M24X130	10	01400.240.130
M8X65	100	01400.080.065	M16X130	25	01400.160.130	M24X140	10	01400.240.140
M8X70	100	01400.080.070	M16X140	25	01400.160.140	M24X150	10	01400.240.150
M8X75	100	01400.080.075	M16X150	25	01400.160.150	M24X160	10	01400.240.160
M8X80	100	01400.080.080	M16X160	25	01400.160.160	M24X180	10	01400.240.180
M8X90	100	01400.080.090	M16X180	25	01400.160.180	M24X200	10	01400.240.200
M8X100	50	01400.080.100	M16X200	25	01400.160.200	M24X220	10	01400.240.220
			M16X220	25	01400.160.220	M24X240	10	01400.240.240
M10X40/S=17	100	01400.100.040	M16X240	25	01400.160.240	M24X260	10	01400.240.260
M10X45/S=17	100	01400.100.045	M16X260	25	01400.160.260	M24X280	10	01400.240.280
M10X50/S=17	50	01400.100.050				M24X300	10	01400.240.300
M10X55/S=17	50	01400.100.055	M18X60	25	01400.180.060	M24X320	5	01400.240.320
M10X60/S=17	50	01400.100.060	M18X70	25	01400.180.070	M24X340	5	01400.240.340
M10X65/S=17	50	01400.100.065	M18X80	25	01400.180.080	M24X360	5	01400.240.360
M10X70/S=17	50	01400.100.070	M18X90	25	01400.180.090			
M10X75/S=17	50	01400.100.075	M18X100	25	01400.180.100	M27X80	10	01400.270.080
M10X80/S=17	50	01400.100.080	M18X110	25	01400.180.110	M27X90	10	01400.270.090
M10X90/S=17	50	01400.100.090	M18X120	25	01400.180.120	M27X100	10	01400.270.100
M10X100/S=17	50	01400.100.100	M18X130	25	01400.180.130	M27X110	10	01400.270.110
M10X110/S=17	50	01400.100.110	M18X140	25	01400.180.140	M27X120	10	01400.270.120
M10X110/S=16	50	01400.100.111	M18X150	25	01400.180.150	M27X130	10	01400.270.130
M10X120/S=17	50	01400.100.120				M27X140	10	01400.270.140
M10X120/S=16	50	01400.100.121	M20X65	25	01400.200.065	M27X150	10	01400.270.150
M10X130/S=16	50	01400.100.131	M20X70	25	01400.200.070	M27X160	10	01400.270.160
M10X140/S=16	50	01400.100.141	M20X75	25	01400.200.075			
M10X150/S=16	50	01400.100.151	M20X80	25	01400.200.080	M30X90	10	01400.300.090
M10X160/S=16	50	01400.100.161	M20X90	25	01400.200.090	M30X100	10	01400.300.100
M10X180/S=16	50	01400.100.181	M20X100	25	01400.200.100	M30X110	10	01400.300.110
M10X200/S=16	50	01400.100.201	M20X110	25	01400.200.110	M30X120	10	01400.300.120
			M20X120	25	01400.200.120	M30X130	10	01400.300.130
M12X45/S=19	50	01400.120.045	M20X130	25	01400.200.130	M30X140	10	01400.300.140
M12X50/S=19	50	01400.120.050	M20X140	25	01400.200.140	M30X150	10	01400.300.150
M12X55/S=19	25	01400.120.055	M20X150	25	01400.200.150	M30X160	10	01400.300.160
M12X60/S=19	25	01400.120.060	M20X160	10	01400.200.160	M30X180	10	01400.300.180
M12X65/S=19	25	01400.120.065	M20X180	10	01400.200.180	M30X200	10	01400.300.200
M12X70/S=19	25	01400.120.070	M20X200	10	01400.200.200	M30X220	5	01400.300.220
M12X75/S=19	25	01400.120.075	M20X220	10	01400.200.220	M30X240	5	01400.300.240
M12X80/S=19	25	01400.120.080	M20X240	10	01400.200.240	M30X260	5	01400.300.260
M12X90/S=19	25	01400.120.090	M20X260	10	01400.200.260			
M12X100/S=19	25	01400.120.100	M20X280	10	01400.200.280	M33X100	5	01400.330.100
M12X110/S=19	25	01400.120.110	M20X300	10	01400.200.300	M33X120	5	01400.330.120
M12X120/S=19	25	01400.120.120				M33X140	5	01400.330.140
M12X130/S=19	25	01400.120.130	M22X70/S=34	25	01400.220.071	M33X160	5	01400.330.160
M12X140/S=19	25	01400.120.140	M22X75/S=34	25	01400.220.076			
M12X150/S=19	25	01400.120.150	M22X80/S=34	25	01400.220.081	M36X110	5	01400.360.110
M12X160/S=19	25	01400.120.160	M22X90/S=34	25	01400.220.091	M36X120	5	01400.360.120
M12X180/S=19	25	01400.120.180	M22X100/S=34	10	01400.220.101	M36X140	5	01400.360.140
M12X200/S=19	25	01400.120.200	M22X110/S=34	10	01400.220.111	M36X160	2	01400.360.160
			M22X120/S=34	10	01400.220.121	M36X180	2	01400.360.180
M16X55	25	01400.160.055	M22X140/S=34	10	01400.220.141	M36X200	2	01400.360.200
M16X60	25	01400.160.060	M22X150/S=34	10	01400.220.151	M36X220	2	01400.360.220
M16X65	25	01400.160.065				M36X240	2	01400.360.240
M16X70	25	01400.160.070	M24X75	25	01400.240.075			

- For hot dip galvanized bolts with ISO-METRIC FITTING thread, the thread is rolled undersize so that it will meet the go-gauge with tolerance class h AFTER galvanizing.
- The advantage of this way of manufacturing is that the bolts can be used in any threaded hole without any problem.
- The corresponding ISO-METRIC FITTING nuts have been threaded according to the tolerance class 6H AFTER galvanizing so that they perfectly fit onto the bolts.

01420 Hexagon head bolt oversized thread		A08A
Thread	Metric thread	
Material	Steel	
Class	8.8	
Surface treatment	Hot dip galvanized	
		

d x L	☒	Art.number	d x L	☒	Art.number	d x L	☒	Art.number
M10X40/S=17	100	01420.100.040	M18X70	50	01420.180.070	M24X260	5	01420.240.260
M10X50/S=17	50	01420.100.050	M18X80	25	01420.180.080	M24X280	5	01420.240.280
M10X55/S=17	50	01420.100.055	M18X90	25	01420.180.090	M24X300	5	01420.240.300
M10X60/S=17	50	01420.100.060	M18X100	25	01420.180.100			
M10X80/S=17	50	01420.100.080	M18X120	25	01420.180.120	M27X80	10	01420.270.080
M10X100/S=17	50	01420.100.100	M18X140	25	01420.180.140	M27X85	10	01420.270.085
M10X130/S=17	50	01420.100.130				M27X90	10	01420.270.090
			M20X65	25	01420.200.065	M27X100	10	01420.270.100
M12X45/S=19	100	01420.120.045	M20X70	25	01420.200.070	M27X110	10	01420.270.110
M12X50/S=19	100	01420.120.050	M20X75	25	01420.200.075	M27X120	10	01420.270.120
M12X55/S=19	100	01420.120.055	M20X80	25	01420.200.080	M27X130	10	01420.270.130
M12X60/S=19	100	01420.120.060	M20X85	25	01420.200.085	M27X140	10	01420.270.140
M12X65/S=19	100	01420.120.065	M20X90	25	01420.200.090	M27X150	10	01420.270.150
M12X70/S=19	100	01420.120.070	M20X95	25	01420.200.095	M27X160	10	01420.270.160
M12X75/S=19	50	01420.120.075	M20X100	25	01420.200.100	M27X180	10	01420.270.180
M12X80/S=19	50	01420.120.080	M20X110	25	01420.200.110	M27X200	10	01420.270.200
M12X90/S=19	50	01420.120.090	M20X120	25	01420.200.120			
M12X100/S=19	50	01420.120.100	M20X130	25	01420.200.130	M30X90	10	01420.300.090
M12X110/S=19	50	01420.120.110	M20X140	25	01420.200.140	M30X100	10	01420.300.100
M12X120/S=19	50	01420.120.120	M20X150	25	01420.200.150	M30X110	10	01420.300.110
M12X130/S=19	50	01420.120.130	M20X160	10	01420.200.160	M30X120	10	01420.300.120
M12X140/S=19	50	01420.120.140	M20X180	10	01420.200.180	M30X130	10	01420.300.130
M12X150/S=19	50	01420.120.150	M20X200	10	01420.200.200	M30X140	10	01420.300.140
M12X160/S=19	25	01420.120.160	M20X220	10	01420.200.220	M30X150	5	01420.300.150
M12X180/S=19	25	01420.120.180	M20X240	10	01420.200.240	M30X160	10	01420.300.160
M12X200/S=19	25	01420.120.200	M20X260	10	01420.200.260	M30X180	5	01420.300.180
M12X240/S=19	25	01420.120.240	M20X280	10	01420.200.280	M30X200	5	01420.300.200
M12X260/S=19	25	01420.120.260	M20X300	10	01420.200.300	M30X220	5	01420.300.220
			M20X320	5	01420.200.320			
M14X50/S=22	50	01420.140.050	M20X360	5	01420.200.360	M33X110	5	01420.330.110
M14X60/S=22	50	01420.140.060				M33X120	5	01420.330.120
M14X70/S=22	50	01420.140.070	M22X70/S=32	25	01420.220.070	M33X140	5	01420.330.140
M14X80/S=22	25	01420.140.080	M22X75/S=32	25	01420.220.075			
M14X90/S=22	25	01420.140.090	M22X80/S=32	25	01420.220.080	M36X100	5	01420.360.100
M14X100/S=22	25	01420.140.100	M22X90/S=32	10	01420.220.090	M36X110	5	01420.360.110
M14X120/S=22	25	01420.140.120	M22X100/S=32	10	01420.220.100	M36X120	5	01420.360.120
M14X140/S=22	25	01420.140.140	M22X120/S=32	10	01420.220.120	M36X130	5	01420.360.130
			M22X140/S=32	10	01420.220.140	M36X140	5	01420.360.140
M16X55	50	01420.160.055	M22X160/S=32	10	01420.220.160	M36X150	5	01420.360.150
M16X60	50	01420.160.060	M22X180/S=32	10	01420.220.180	M36X160	5	01420.360.160
M16X65	50	01420.160.065	M22X190/S=32	10	01420.220.190	M36X180	5	01420.360.180
M16X70	50	01420.160.070	M22X200/S=32	10	01420.220.200	M36X200	5	01420.360.200
M16X75	25	01420.160.075				M36X220	1	01420.360.220
M16X80	25	01420.160.080	M24X70	25	01420.240.070	M36X320	1	01420.360.320
M16X90	25	01420.160.090	M24X75	25	01420.240.075			
M16X100	25	01420.160.100	M24X80	25	01420.240.080	M39X180	1	01420.390.180
M16X110	25	01420.160.110	M24X85	10	01420.240.085	M39X200	1	01420.390.200
M16X120	25	01420.160.120	M24X90	10	01420.240.090			
M16X130	25	01420.160.130	M24X95	10	01420.240.095	M42X140	1	01420.420.140
M16X140	25	01420.160.140	M24X100	10	01420.240.100	M42X150	1	01420.420.150
M16X150	25	01420.160.150	M24X110	10	01420.240.110	M42X160	1	01420.420.160
M16X160	25	01420.160.160	M24X120	10	01420.240.120			
M16X180	25	01420.160.180	M24X130	10	01420.240.130	M45X200	1	01420.450.200
M16X200	25	01420.160.200	M24X140	10	01420.240.140			
M16X220	25	01420.160.220	M24X150	10	01420.240.150	M48X120	1	01420.480.120
M16X240	25	01420.160.240	M24X160	10	01420.240.160			
M16X260	10	01420.160.260	M24X180	10	01420.240.180	M52X200	1	01420.520.200
M16X300	10	01420.160.300	M24X200	10	01420.240.200			
			M24X220	10	01420.240.220	M64X280	1	01420.640.280
M18X60	50	01420.180.060	M24X240	10	01420.240.240			

- For hot dip galvanized bolts with OVERSIZED thread the zinc layer is applied ON the normal thread, so AFTER galvanizing these bolts are no longer ISO-metric mating, but thicker: so called OVERSIZED.
- They cannot be used in normal threaded holes.
- The corresponding OVERSIZED nuts have been Oversize tapped according to ISO 965-5 AFTER galvanizing running perfectly onto these bolts.

04100	Hexagon head bolt	C01A
Thread	Metric thread	 
Material	Steel	
Class	10.9	

d x L	☒	Art.number	d x L	☒	Art.number	d x L	☒	Art.number
M6X30	200	04100.060.030	M14X130/S=22	50	04100.140.130	M24X110	10	04100.240.110
M6X35	200	04100.060.035	M14X140/S=22	50	04100.140.140	M24X120	10	04100.240.120
M6X40	200	04100.060.040	M14X150/S=22	25	04100.140.150	M24X130	10	04100.240.130
M6X45	200	04100.060.045	M14X160/S=22	25	04100.140.160	M24X140	10	04100.240.140
M6X50	200	04100.060.050				M24X150	10	04100.240.150
M6X55	200	04100.060.055	M16X50	50	04100.160.050	M24X160	10	04100.240.160
M6X60	200	04100.060.060	M16X55	50	04100.160.055	M24X170	10	04100.240.170
M6X70	200	04100.060.070	M16X60	50	04100.160.060	M24X180	10	04100.240.180
M6X80	200	04100.060.080	M16X65	25	04100.160.065	M24X200	10	04100.240.200
			M16X70	25	04100.160.070	M24X220	10	04100.240.220
M8X30	200	04100.080.030	M16X75	25	04100.160.075	M24X240	10	04100.240.240
M8X35	200	04100.080.035	M16X80	25	04100.160.080	M24X260	10	04100.240.260
M8X40	200	04100.080.040	M16X90	25	04100.160.090	M24X280	10	04100.240.280
M8X45	200	04100.080.045	M16X95	25	04100.160.095			
M8X50	200	04100.080.050	M16X100	25	04100.160.100	M27X80	10	04100.270.080
M8X60	200	04100.080.060	M16X110	25	04100.160.110	M27X90	10	04100.270.090
M8X70	200	04100.080.070	M16X120	25	04100.160.120	M27X100	10	04100.270.100
M8X80	200	04100.080.080	M16X130	25	04100.160.130	M27X110	10	04100.270.110
M8X90	100	04100.080.090	M16X140	25	04100.160.140	M27X120	10	04100.270.120
M8X100	100	04100.080.100	M16X150	25	04100.160.150	M27X130	10	04100.270.130
M8X110	100	04100.080.110	M16X160	25	04100.160.160	M27X140	10	04100.270.140
M8X120	100	04100.080.120	M16X170	25	04100.160.170	M27X150	10	04100.270.150
			M16X180	25	04100.160.180	M27X160	10	04100.270.160
M10X40/S=17	100	04100.100.040	M16X190	25	04100.160.190	M27X170	5	04100.270.170
M10X45/S=17	100	04100.100.045	M16X200	25	04100.160.200	M27X180	5	04100.270.180
M10X50/S=17	100	04100.100.050	M16X220	25	04100.160.220	M27X190	5	04100.270.190
M10X55/S=17	100	04100.100.055	M16X240	10	04100.160.240	M27X200	5	04100.270.200
M10X60/S=17	100	04100.100.060	M16X250	10	04100.160.250			
M10X65/S=17	100	04100.100.065				M30X90	10	04100.300.090
M10X70/S=17	100	04100.100.070	M18X60	25	04100.180.060	M30X100	10	04100.300.100
M10X75/S=17	100	04100.100.075	M18X65	25	04100.180.065	M30X110	10	04100.300.110
M10X80/S=17	100	04100.100.080	M18X70	25	04100.180.070	M30X120	10	04100.300.120
M10X90/S=17	100	04100.100.090	M18X80	25	04100.180.080	M30X130	10	04100.300.130
M10X100/S=17	100	04100.100.100	M18X85	100	04100.180.085	M30X140	10	04100.300.140
M10X110/S=17	50	04100.100.110	M18X90	25	04100.180.090	M30X150	10	04100.300.150
M10X120/S=17	50	04100.100.120	M18X100	25	04100.180.100	M30X160	10	04100.300.160
M10X130/S=17	50	04100.100.130	M18X110	25	04100.180.110	M30X170	5	04100.300.170
M10X140/S=17	50	04100.100.140	M18X120	25	04100.180.120	M30X180	5	04100.300.180
M10X150/S=17	50	04100.100.150				M30X200	5	04100.300.200
M10X160/S=17	50	04100.100.160	M20X65	25	04100.200.065	M30X220	5	04100.300.220
M10X180/S=17	50	04100.100.180	M20X70	25	04100.200.070	M30X240	5	04100.300.240
			M20X75	25	04100.200.075	M30X260	5	04100.300.260
M12X45/S=19	100	04100.120.045	M20X80	25	04100.200.080	M30X280	5	04100.300.280
M12X50/S=19	100	04100.120.050	M20X85	25	04100.200.085	M30X300	5	04100.300.300
M12X55/S=19	100	04100.120.055	M20X90	25	04100.200.090			
M12X60/S=19	100	04100.120.060	M20X95	25	04100.200.095	M33X100	5	04100.330.100
M12X65/S=19	50	04100.120.065	M20X100	25	04100.200.100	M33X110	5	04100.330.110
M12X70/S=19	50	04100.120.070	M20X110	25	04100.200.110	M33X120	5	04100.330.120
M12X75/S=19	100	04100.120.075	M20X120	25	04100.200.120	M33X130	5	04100.330.130
M12X80/S=19	50	04100.120.080	M20X130	25	04100.200.130	M33X140	5	04100.330.140
M12X85/S=19	50	04100.120.085	M20X140	25	04100.200.140	M33X150	5	04100.330.150
M12X90/S=19	50	04100.120.090	M20X150	25	04100.200.150	M33X160	5	04100.330.160
M12X100/S=19	50	04100.120.100	M20X160	10	04100.200.160	M33X180	2	04100.330.180
M12X110/S=19	50	04100.120.110	M20X170	10	04100.200.170	M33X200	2	04100.330.200
M12X120/S=19	50	04100.120.120	M20X180	10	04100.200.180	M33X240	2	04100.330.240
M12X130/S=19	25	04100.120.130	M20X190	10	04100.200.190			
M12X140/S=19	25	04100.120.140	M20X200	10	04100.200.200	M36X100	5	04100.360.100
M12X150/S=19	25	04100.120.150	M20X220	10	04100.200.220	M36X110	5	04100.360.110
M12X160/S=19	25	04100.120.160	M20X230	10	04100.200.230	M36X120	5	04100.360.120
M12X180/S=19	25	04100.120.180	M20X240	10	04100.200.240	M36X130	5	04100.360.130
M12X200/S=19	25	04100.120.200	M20X260	10	04100.200.260	M36X140	5	04100.360.140
M12X220/S=19	25	04100.120.220				M36X150	5	04100.360.150
			M22X70/S=32	10	04100.220.070	M36X160	5	04100.360.160
M14X45/S=22	50	04100.140.045	M22X75/S=32	10	04100.220.075	M36X180	2	04100.360.180
M14X50/S=22	50	04100.140.050	M22X80/S=32	10	04100.220.080	M36X200	2	04100.360.200
M14X55/S=22	50	04100.140.055	M22X90/S=32	10	04100.220.090	M36X220	2	04100.360.220
M14X60/S=22	50	04100.140.060	M22X100/S=32	10	04100.220.100	M36X240	2	04100.360.240
M14X65/S=22	50	04100.140.065	M22X110/S=32	10	04100.220.110	M36X260	2	04100.360.260
M14X70/S=22	50	04100.140.070	M22X120/S=32	10	04100.220.120	M36X300	2	04100.360.300
M14X75/S=22	50	04100.140.075	M22X130/S=32	10	04100.220.130			
M14X80/S=22	50	04100.140.080				M39X120	1	04100.390.120
M14X85/S=22	50	04100.140.085	M24X75	25	04100.240.075	M39X140	1	04100.390.140
M14X90/S=22	50	04100.140.090	M24X80	25	04100.240.080	M39X150	5	04100.390.150
M14X100/S=22	50	04100.140.100	M24X90	10	04100.240.090	M39X160	1	04100.390.160
M14X120/S=22	50	04100.140.120	M24X100	10	04100.240.100	M39X180	1	04100.390.180

04100 Hexagon head bolt								
d x L	☒	Art.number	d x L	☒	Art.number	d x L	☒	Art.number
M39X190	1	04100.390.190	M42X200	1	04100.420.200	M45X200	1	04100.450.200
M39X200	1	04100.390.200	M42X220	1	04100.420.220	M45X220	1	04100.450.220
M42X160	1	04100.420.160	M42X240	1	04100.420.240	M45X240	1	04100.450.240
M42X180	1	04100.420.180	M45X160	1	04100.450.160			

- Warning: electro-galvanizing of these products may cause hydrogen embrittlement.

04105 Hexagon head bolt		C95A
Thread	Metric thread	
Material	Steel	
Class	10.9	
Surface treatment	Zinc flake Cr ⁶⁺ free - ISO 10683 flZnnc	



d x L	☒	Art.number	d x L	☒	Art.number	d x L	☒	Art.number
M6X30	200	04105.060.030	M10X120	50	04105.100.120	M16X120	25	04105.160.120
M6X35	200	04105.060.035				M16X130	25	04105.160.130
M6X40	200	04105.060.040	M12X45	100	04105.120.045	M16X140	25	04105.160.140
M6X50	200	04105.060.050	M12X50	100	04105.120.050	M16X150	10	04105.160.150
M6X60	200	04105.060.060	M12X60	100	04105.120.060	M16X160	10	04105.160.160
M6X70	200	04105.060.070	M12X70	50	04105.120.070			
M6X80	200	04105.060.080	M12X80	50	04105.120.080	M20X70	25	04105.200.070
			M12X90	50	04105.120.090	M20X80	25	04105.200.080
M8X35	200	04105.080.035	M12X100	50	04105.120.100	M20X90	25	04105.200.090
M8X40	200	04105.080.040	M12X120	50	04105.120.120	M20X100	25	04105.200.100
M8X45	200	04105.080.045				M20X120	25	04105.200.120
M8X50	200	04105.080.050	M14X50	50	04105.140.050	M20X140	25	04105.200.140
M8X60	200	04105.080.060	M14X60	50	04105.140.060	M20X160	10	04105.200.160
M8X70	200	04105.080.070	M14X80	50	04105.140.080	M20X200	10	04105.200.200
			M14X90	50	04105.140.090			
M10X40	100	04105.100.040	M14X100	50	04105.140.100	M24X80	25	04105.240.080
M10X45	100	04105.100.045				M24X90	10	04105.240.090
M10X50	100	04105.100.050	M16X55	50	04105.160.055	M24X100	10	04105.240.100
M10X60	100	04105.100.060	M16X60	50	04105.160.060	M24X120	10	04105.240.120
M10X70	100	04105.100.070	M16X65	25	04105.160.065	M24X140	10	04105.240.140
M10X80	100	04105.100.080	M16X70	25	04105.160.070	M24X160	10	04105.240.160
M10X90	100	04105.100.090	M16X80	25	04105.160.080	M24X180	10	04105.240.180
M10X100	100	04105.100.100	M16X90	25	04105.160.090	M24X200	10	04105.240.200
M10X110	50	04105.100.110	M16X100	25	04105.160.100			

- A ISO 10683 Zinc Flake surface coating eliminates the possibilities of damage which can arise due to hydrogen embrittlement.

04108 Hexagon head bolt		C01A
Thread	Metric thread	
Material	Steel	
Class	12.9	



d x L	☒	Art.number	d x L	☒	Art.number	d x L	☒	Art.number
M6X30	200	04108.060.030	M12X60/S=19	100	04108.120.060	M16X120	25	04108.160.120
M6X40	200	04108.060.040	M12X70/S=19	50	04108.120.070	M16X130	25	04108.160.130
M6X50	200	04108.060.050	M12X80/S=19	50	04108.120.080	M16X140	25	04108.160.140
M6X60	200	04108.060.060	M12X90/S=19	50	04108.120.090	M16X160	25	04108.160.160
			M12X100/S=19	50	04108.120.100			
M8X40	200	04108.080.040	M12X110/S=19	50	04108.120.110	M20X70	25	04108.200.070
M8X50	200	04108.080.050	M12X120/S=19	50	04108.120.120	M20X80	25	04108.200.080
M8X60	200	04108.080.060				M20X90	25	04108.200.090
M8X80	200	04108.080.080	M14X50/S=22	50	04108.140.050	M20X100	25	04108.200.100
M8X100	100	04108.080.100	M14X60/S=22	50	04108.140.060	M20X110	25	04108.200.110
			M14X70/S=22	50	04108.140.070	M20X140	25	04108.200.140
M10X40/S=17	100	04108.100.040	M14X80/S=22	50	04108.140.080	M20X160	10	04108.200.160
M10X45/S=17	100	04108.100.045	M14X90/S=22	50	04108.140.090			
M10X50/S=17	100	04108.100.050	M14X100/S=22	50	04108.140.100	M24X80	25	04108.240.080
M10X60/S=17	100	04108.100.060	M14X120/S=22	50	04108.140.120	M24X90	10	04108.240.090
M10X70/S=17	100	04108.100.070				M24X100	10	04108.240.100
M10X80/S=17	100	04108.100.080	M16X60	50	04108.160.060			
M10X100/S=17	100	04108.100.100	M16X70	25	04108.160.070	M30X90	10	04108.300.090
M10X120/S=17	50	04108.100.120	M16X80	25	04108.160.080	M30X100	10	04108.300.100
			M16X90	25	04108.160.090	M30X110	10	04108.300.110
M12X45/S=19	100	04108.120.045	M16X100	25	04108.160.100	M30X120	10	04108.300.120
M12X50/S=19	100	04108.120.050	M16X110	25	04108.160.110			

- Warning: electro-galvanizing of these products may cause hydrogen embrittlement.

08750		Hexagon head bolt for pressure vessels etc.				E11A	
Thread	Metric thread						
Material	Steel						
Class	5.6						

d x L	☒	Art.number	d x L	☒	Art.number	d x L	☒	Art.number
M12X50/S=18	100	08750.120.051	M16X160	25	08750.160.160	M24X110	10	08750.240.110
M12X55/S=18	100	08750.120.056	M16X180	25	08750.160.180	M24X120	10	08750.240.120
M12X60/S=18	100	08750.120.061				M24X150	10	08750.240.150
M12X65/S=18	50	08750.120.066	M20X75	25	08750.200.075	M24X160	10	08750.240.160
M12X70/S=18	50	08750.120.071	M20X80	25	08750.200.080	M24X180	10	08750.240.180
M12X80/S=18	50	08750.120.081	M20X90	25	08750.200.090	M24X200	10	08750.240.200
			M20X100	25	08750.200.100	M24X220	10	08750.240.220
M16X60	50	08750.160.060	M20X110	25	08750.200.110			
M16X65	25	08750.160.065	M20X120	25	08750.200.120	M27X90	10	08750.270.090
M16X70	25	08750.160.070	M20X130	25	08750.200.130	M27X100	10	08750.270.100
M16X75	25	08750.160.075	M20X140	25	08750.200.140	M27X110	10	08750.270.110
M16X80	25	08750.160.080	M20X150	25	08750.200.150	M27X120	10	08750.270.120
M16X90	25	08750.160.090	M20X160	10	08750.200.160	M27X130	10	08750.270.130
M16X100	25	08750.160.100	M20X180	10	08750.200.180	M27X240	5	08750.270.240
M16X110	25	08750.160.110						
M16X120	25	08750.160.120	M24X90	10	08750.240.090	M30X120	10	08750.300.120
M16X140	25	08750.160.140	M24X100	10	08750.240.100			

- Special features hexagon head bolts for pressure vessels etc.:
- Are intended for use in pressure vessels, steam apparatus, equipment and flanged joints at temperatures from -10°C up to +300°C, overpressures max. 40 bar and sizes up to and including M30.
- Meets the requirements of AD-Merkblatt W7, TRD 106 of the TÜV (Technischer Überwachungsverein) and DIN 267-13.
- According to TÜV-Merkblatt Werkstoffe 1253, the manufacturer has been certified to deliver these bolts without a 3.1 certificate, the trade-mark and class designation are sufficient.
- This certification is also accepted by "Lloyd's Register Energy".

51000		Hexagon head bolt				Q01A	
Thread	Metric thread						
Material	Stainless steel A2						
Class	70						

d x L	☒	Art.number	d x L	☒	Art.number	d x L	☒	Art.number
M5X25	200	51000.050.025	M6X180	50	51000.060.180	M10X45/S=17	100	51000.100.045
M5X30	100	51000.050.030	M6X190*	100	51000.060.190	M10X50/S=17	100	51000.100.050
M5X35	100	51000.050.035	M6X200*	100	51000.060.200	M10X55/S=17	100	51000.100.055
M5X40	100	51000.050.040				M10X60/S=17	100	51000.100.060
M5X45	100	51000.050.045	M8X30	200	51000.080.030	M10X65/S=17	50	51000.100.065
M5X50	100	51000.050.050	M8X35	100	51000.080.035	M10X70/S=17	50	51000.100.070
M5X55	100	51000.050.055	M8X40	100	51000.080.040	M10X75/S=17	50	51000.100.075
M5X60	100	51000.050.060	M8X45	100	51000.080.045	M10X80/S=17	50	51000.100.080
M5X65*	200	51000.050.065	M8X50	100	51000.080.050	M10X85/S=17	50	51000.100.085
M5X70	100	51000.050.070	M8X55	100	51000.080.055	M10X90/S=17	50	51000.100.090
M5X75*	100	51000.050.075	M8X60	100	51000.080.060	M10X95/S=17	50	51000.100.095
M5X80*	100	51000.050.080	M8X65	100	51000.080.065	M10X100/S=17	50	51000.100.100
M5X85*	100	51000.050.085	M8X70	100	51000.080.070	M10X110/S=17	50	51000.100.110
M5X90*	100	51000.050.090	M8X75	100	51000.080.075	M10X120/S=17	25	51000.100.120
M5X95*	100	51000.050.095	M8X80	100	51000.080.080	M10X130/S=17	25	51000.100.130
M5X100*	100	51000.050.100	M8X85*	50	51000.080.085	M10X140/S=17	25	51000.100.140
			M8X90	100	51000.080.090	M10X150/S=17*	25	51000.100.150
M6X25	200	51000.060.025	M8X95*	50	51000.080.095	M10X160/S=17	25	51000.100.160
M6X30	200	51000.060.030	M8X100	100	51000.080.100	M10X170/S=17	25	51000.100.170
M6X35	100	51000.060.035	M8X110	50	51000.080.110	M10X180/S=17	25	51000.100.180
M6X40	100	51000.060.040	M8X120	50	51000.080.120	M10X190/S=17	25	51000.100.190
M6X45	100	51000.060.045	M8X130	50	51000.080.130	M10X200/S=17	10	51000.100.200
M6X50	100	51000.060.050	M8X140	50	51000.080.140	M10X210/S=17*	10	51000.100.210
M6X55	100	51000.060.055	M8X150	50	51000.080.150	M10X220/S=17*	10	51000.100.220
M6X60	100	51000.060.060	M8X160	25	51000.080.160	M10X230/S=17*	10	51000.100.230
M6X65	100	51000.060.065	M8X170	25	51000.080.170	M10X240/S=17*	10	51000.100.240
M6X70	100	51000.060.070	M8X180	25	51000.080.180	M10X250/S=17*	10	51000.100.250
M6X75	100	51000.060.075	M8X190	25	51000.080.190	M10X260*	10	51000.100.260
M6X80	100	51000.060.080	M8X200	10	51000.080.200	M10X270/S=17*	10	51000.100.270
M6X85*	100	51000.060.085	M8X210*	25	51000.080.210	M10X280/S=17*	10	51000.100.280
M6X90	100	51000.060.090	M8X220	25	51000.080.220	M10X290/S=17*	10	51000.100.290
M6X95	100	51000.060.095	M8X230*	25	51000.080.230	M10X300*	10	51000.100.300
M6X100	100	51000.060.100	M8X240*	25	51000.080.240	M10X320/S=17*	10	51000.100.320
M6X110	50	51000.060.110	M8X250*	25	51000.080.250	M10X340*	10	51000.100.340
M6X120	50	51000.060.120	M8X260*	25	51000.080.260	M10X360/S=17*	10	51000.100.360
M6X130	50	51000.060.130	M8X270*	25	51000.080.270	M10X380*	10	51000.100.380
M6X140	50	51000.060.140	M8X280*	25	51000.080.280	M10X400*	10	51000.100.400
M6X150	50	51000.060.150				M10X420*	10	51000.100.420
M6X160*	100	51000.060.160	M10X35/S=17	100	51000.100.035	M10X440*	10	51000.100.440
M6X170*	100	51000.060.170	M10X40/S=17	100	51000.100.040	M10X480*	10	51000.100.480

51000		Hexagon head bolt						
d x L	☒	Art.number	d x L	☒	Art.number	d x L	☒	Art.number
M12X40/S=19	50	51000.120.040	M16X140	10	51000.160.140	M20X290*	10	51000.200.290
M12X45/S=19	50	51000.120.045	M16X150	10	51000.160.150	M20X300*	5	51000.200.300
M12X50/S=19	50	51000.120.050	M16X160	10	51000.160.160	M20X320*	5	51000.200.320
M12X55/S=19	50	51000.120.055	M16X170	10	51000.160.170	M20X340*	5	51000.200.340
M12X60/S=19	50	51000.120.060	M16X180	5	51000.160.180	M20X360*	5	51000.200.360
M12X65/S=19	50	51000.120.065	M16X190	5	51000.160.190	M20X380*	5	51000.200.380
M12X70/S=19	50	51000.120.070	M16X200	5	51000.160.200	M20X400*	5	51000.200.400
M12X75/S=19	50	51000.120.075	M16X210	5	51000.160.210	M20X420*	5	51000.200.420
M12X80/S=19	50	51000.120.080	M16X220	5	51000.160.220	M20X440*	5	51000.200.440
M12X85/S=19	25	51000.120.085	M16X230	5	51000.160.230	M20X460*	5	51000.200.460
M12X90/S=19	50	51000.120.090	M16X240	5	51000.160.240	M20X480*	5	51000.200.480
M12X95/S=19*	25	51000.120.095	M16X250	5	51000.160.250	M20X500*	5	51000.200.500
M12X100/S=19	50	51000.120.100	M16X260	5	51000.160.260	M20X520*	5	51000.200.520
M12X110/S=19	25	51000.120.110	M16X270*	10	51000.160.270	M20X540*	5	51000.200.540
M12X120/S=19	25	51000.120.120	M16X280	5	51000.160.280	M20X560*	5	51000.200.560
M12X130/S=19	25	51000.120.130	M16X290*	10	51000.160.290	M20X580*	5	51000.200.580
M12X140/S=19	25	51000.120.140	M16X300*	10	51000.160.300	M20X600*	5	51000.200.600
M12X150/S=19	25	51000.120.150	M16X320*	10	51000.160.320			
M12X160/S=19	25	51000.120.160	M16X330*	10	51000.160.330	M22X70/S=32	10	51000.220.070
M12X170/S=19	25	51000.120.170	M16X340*	10	51000.160.340	M22X75/S=32*	25	51000.220.075
M12X180/S=19	25	51000.120.180	M16X360*	10	51000.160.360	M22X80/S=32	10	51000.220.080
M12X190/S=19	25	51000.120.190	M16X370	10	51000.160.370	M22X85/S=32*	25	51000.220.085
M12X200/S=19	10	51000.120.200	M16X380*	10	51000.160.380	M22X90/S=32	10	51000.220.090
M12X210/S=19*	10	51000.120.210	M16X400*	10	51000.160.400	M22X95/S=32*	25	51000.220.095
M12X220/S=19*	10	51000.120.220	M16X420*	10	51000.160.420	M22X100/S=32	10	51000.220.100
M12X230/S=19*	10	51000.120.230	M16X440*	10	51000.160.440	M22X110/S=32	5	51000.220.110
M12X240/S=19*	10	51000.120.240	M16X460*	10	51000.160.460	M22X120/S=32	5	51000.220.120
M12X250/S=19*	10	51000.120.250	M16X480*	10	51000.160.480	M22X130/S=32*	20	51000.220.130
M12X260/S=19*	10	51000.120.260	M16X500*	10	51000.160.500	M22X140/S=32	5	51000.220.140
M12X270/S=19*	10	51000.120.270	M16X520*	10	51000.160.520	M22X150/S=32	5	51000.220.150
M12X280/S=19*	10	51000.120.280	M16X560*	10	51000.160.560	M22X160/S=32*	10	51000.220.160
M12X290/S=19*	10	51000.120.290	M16X580*	10	51000.160.580	M22X170/S=32*	10	51000.220.170
M12X300/S=19*	10	51000.120.300				M22X180/S=32	5	51000.220.180
M12X320/S=19*	10	51000.120.320	M18X60	25	51000.180.060	M22X190/S=32*	10	51000.220.190
M12X340/S=19*	10	51000.120.340	M18X65	25	51000.180.065	M22X200/S=32*	10	51000.220.200
M12X360/S=19*	10	51000.120.360	M18X70	25	51000.180.070			
M12X380/S=19*	10	51000.120.380	M18X75*	25	51000.180.075	M24X65*	10	51000.240.065
M12X400/S=19*	10	51000.120.400	M18X80	10	51000.180.080	M24X70	10	51000.240.070
M12X420/S=19*	10	51000.120.420	M18X85*	25	51000.180.085	M24X75	10	51000.240.075
M12X440/S=19*	10	51000.120.440	M18X90	10	51000.180.090	M24X80	5	51000.240.080
M12X460/S=19*	10	51000.120.460	M18X95*	25	51000.180.095	M24X85*	10	51000.240.085
M12X480/S=19*	10	51000.120.480	M18X100	10	51000.180.100	M24X90	5	51000.240.090
M12X500/S=19*	10	51000.120.500	M18X110	10	51000.180.110	M24X95*	10	51000.240.095
			M18X120	10	51000.180.120	M24X100	5	51000.240.100
M14X50/S=22	50	51000.140.050	M18X130	10	51000.180.130	M24X110	5	51000.240.110
M14X55/S=22	50	51000.140.055	M18X140	10	51000.180.140	M24X120	5	51000.240.120
M14X60/S=22	50	51000.140.060	M18X150	10	51000.180.150	M24X130	5	51000.240.130
M14X65/S=22*	50	51000.140.065	M18X160*	25	51000.180.160	M24X140	5	51000.240.140
M14X70/S=22	50	51000.140.070	M18X170*	25	51000.180.170	M24X150	5	51000.240.150
M14X75/S=22*	25	51000.140.075	M18X180*	25	51000.180.180	M24X160	5	51000.240.160
M14X80/S=22	10	51000.140.080	M18X190*	25	51000.180.190	M24X170*	10	51000.240.170
M14X85/S=22*	25	51000.140.085	M18X200	5	51000.180.200	M24X180	5	51000.240.180
M14X90/S=22	10	51000.140.090				M24X190*	10	51000.240.190
M14X95/S=22*	25	51000.140.095	M20X55*	25	51000.200.055	M24X200	5	51000.240.200
M14X100/S=22	10	51000.140.100	M20X60	25	51000.200.060	M24X210*	5	51000.240.210
M14X110/S=22*	25	51000.140.110	M20X65	25	51000.200.065	M24X220	5	51000.240.220
M14X120/S=22	10	51000.140.120	M20X70	25	51000.200.070	M24X230*	5	51000.240.230
M14X130/S=22	10	51000.140.130	M20X75	10	51000.200.075	M24X240	5	51000.240.240
M14X140/S=22	10	51000.140.140	M20X80	25	51000.200.080	M24X250*	5	51000.240.250
M14X150/S=22	10	51000.140.150	M20X85	25	51000.200.085	M24X260	5	51000.240.260
M14X160/S=22	10	51000.140.160	M20X90	25	51000.200.090	M24X270*	5	51000.240.270
M14X170/S=22*	10	51000.140.170	M20X95*	25	51000.200.095	M24X280*	5	51000.240.280
M14X180/S=22	10	51000.140.180	M20X100	25	51000.200.100	M24X290*	5	51000.240.290
M14X190/S=22*	10	51000.140.190	M20X105*	25	51000.200.105	M24X300*	5	51000.240.300
M14X200/S=22	10	51000.140.200	M20X110	25	51000.200.110	M24X320*	5	51000.240.320
			M20X120	10	51000.200.120	M24X340*	5	51000.240.340
M16X45	25	51000.160.045	M20X130	10	51000.200.130	M24X360*	5	51000.240.360
M16X50	50	51000.160.050	M20X140	10	51000.200.140	M24X380*	5	51000.240.380
M16X55	50	51000.160.055	M20X150	10	51000.200.150	M24X400*	5	51000.240.400
M16X60	25	51000.160.060	M20X160	10	51000.200.160	M24X420*	5	51000.240.420
M16X65	25	51000.160.065	M20X170	10	51000.200.170	M24X440*	5	51000.240.440
M16X70	25	51000.160.070	M20X180	10	51000.200.180	M24X460*	5	51000.240.460
M16X75	25	51000.160.075	M20X190	10	51000.200.190	M24X480*	5	51000.240.480
M16X80	25	51000.160.080	M20X200	5	51000.200.200	M24X500*	5	51000.240.500
M16X85	25	51000.160.085	M20X210*	10	51000.200.210	M24X520*	5	51000.240.520
M16X90	25	51000.160.090	M20X220	5	51000.200.220	M24X540*	5	51000.240.540
M16X95*	25	51000.160.095	M20X230	5	51000.200.230	M24X560*	5	51000.240.560
M16X100	25	51000.160.100	M20X240	5	51000.200.240			
M16X110	25	51000.160.110	M20X250*	10	51000.200.250	M27X70*	10	51000.270.070
M16X120	10	51000.160.120	M20X260	5	51000.200.260	M27X75*	10	51000.270.075
M16X130	10	51000.160.130	M20X270*	10	51000.200.270	M27X80*	10	51000.270.080
			M20X280*	10	51000.200.280	M27X85*	10	51000.270.085

51000 Hexagon head bolt								
d x L	☒	Art.number	d x L	☒	Art.number	d x L	☒	Art.number
M27X90	3	51000.270.090	M30X230*	5	51000.300.230	M36X230*	5	51000.360.230
M27X95*	10	51000.270.096	M30X240	1	51000.300.240	M36X240	1	51000.360.240
M27X100	3	51000.270.100	M30X250*	5	51000.300.250	M36X250*	5	51000.360.250
M27X110	3	51000.270.110	M30X260	1	51000.300.260	M36X260	1	51000.360.260
M27X120	3	51000.270.120	M30X270*	5	51000.300.270	M36X270*	5	51000.360.270
M27X130	3	51000.270.130	M30X280*	5	51000.300.280	M36X280*	5	51000.360.280
M27X140	3	51000.270.140	M30X290*	5	51000.300.290	M36X300*	5	51000.360.300
M27X150	3	51000.270.150	M30X300*	5	51000.300.300			
M27X160	3	51000.270.160				M39X120*	10	51000.390.120
M27X170*	5	51000.270.170	M33X90	1	51000.330.090	M39X130*	10	51000.390.130
M27X180	3	51000.270.180	M33X100	1	51000.330.100	M39X140*	10	51000.390.140
M27X190*	5	51000.270.190	M33X110	1	51000.330.110	M39X150*	5	51000.390.150
M27X200	3	51000.270.200	M33X120	1	51000.330.120	M39X160*	5	51000.390.160
M27X210*	5	51000.270.210	M33X130	1	51000.330.130	M39X170*	5	51000.390.170
M27X220	3	51000.270.220	M33X140	1	51000.330.140	M39X180*	5	51000.390.180
M27X230*	5	51000.270.230	M33X150	1	51000.330.150	M39X190*	5	51000.390.190
M27X240	3	51000.270.240	M33X160	1	51000.330.160	M39X200*	5	51000.390.200
M27X250	3	51000.270.250	M33X170	1	51000.330.170			
M27X260*	5	51000.270.260	M33X180	1	51000.330.180	M42X120*	5	51000.420.120
M27X270*	5	51000.270.270	M33X190	1	51000.330.190	M42X130*	5	51000.420.130
M27X280*	5	51000.270.280	M33X200	1	51000.330.200	M42X140*	5	51000.420.140
M27X290*	5	51000.270.290	M33X210*	5	51000.330.210	M42X150*	5	51000.420.150
M27X300*	5	51000.270.300	M33X220	1	51000.330.220	M42X160*	5	51000.420.160
			M33X230*	5	51000.330.230	M42X170*	5	51000.420.170
M30X80	1	51000.300.080	M33X240	1	51000.330.240	M42X180*	5	51000.420.180
M30X85*	10	51000.300.085	M33X260*	5	51000.330.260	M42X200*	5	51000.420.200
M30X90	1	51000.300.090	M33X300*	5	51000.330.300			
M30X95*	10	51000.300.095				M45X140*	5	51000.450.140
M30X100	1	51000.300.100	M36X100	1	51000.360.100	M45X150*	5	51000.450.150
M30X110	1	51000.300.110	M36X110	1	51000.360.110	M45X160*	5	51000.450.160
M30X120	1	51000.300.120	M36X120	1	51000.360.120	M45X170*	5	51000.450.170
M30X130	1	51000.300.130	M36X130	1	51000.360.130	M45X180*	5	51000.450.180
M30X140	1	51000.300.140	M36X140	1	51000.360.140			
M30X150	1	51000.300.150	M36X150	1	51000.360.150	M48X150*	5	51000.480.150
M30X160	1	51000.300.160	M36X160	1	51000.360.160	M48X200*	5	51000.480.200
M30X170	1	51000.300.170	M36X170	1	51000.360.170			
M30X180	1	51000.300.180	M36X180	1	51000.360.180	M52X160*	5	51000.520.160
M30X190	1	51000.300.190	M36X190	1	51000.360.190	M52X180*	5	51000.520.180
M30X200	1	51000.300.200	M36X200	1	51000.360.200	M52X200*	5	51000.520.200
M30X210*	5	51000.300.210	M36X210*	5	51000.360.210			
M30X220	1	51000.300.220	M36X220	1	51000.360.220			

* Sizes with a diameter > M24 and sizes with a length > 8xd are minimal property class 50.

55000 Hexagon head bolt								Q41A
Thread	Metric thread							
Material	Stainless steel A4							
Class	70							
d x L	☒	Art.number	d x L	☒	Art.number	d x L	☒	Art.number
M5X25*	200	55000.050.025	M6X85*	100	55000.060.085	M8X95*	50	55000.080.095
M5X30	100	55000.050.030	M6X90	100	55000.060.090	M8X100	100	55000.080.100
M5X35	100	55000.050.035	M6X95*	100	55000.060.095	M8X110	50	55000.080.110
M5X40	100	55000.050.040	M6X100	100	55000.060.100	M8X120	50	55000.080.120
M5X45	100	55000.050.045	M6X110	50	55000.060.110	M8X130	50	55000.080.130
M5X50	100	55000.050.050	M6X120	50	55000.060.120	M8X140	50	55000.080.140
M5X55	100	55000.050.055	M6X130	50	55000.060.130	M8X150	50	55000.080.150
M5X60*	200	55000.050.060	M6X140	50	55000.060.140	M8X160	25	55000.080.160
M5X65*	200	55000.050.065	M6X150	50	55000.060.150	M8X170	25	55000.080.170
M5X70*	100	55000.050.070	M6X160	50	55000.060.160	M8X180	25	55000.080.180
M5X75*	100	55000.050.075	M6X170	50	55000.060.170	M8X190	25	55000.080.190
M5X80*	100	55000.050.080	M6X180	50	55000.060.180	M8X200	10	55000.080.200
M5X90*	100	55000.050.090	M6X200*	100	55000.060.200	M8X210*	25	55000.080.210
M5X100*	100	55000.050.100				M8X220	10	55000.080.220
			M8X30	100	55000.080.030	M8X230*	25	55000.080.230
M6X25*	200	55000.060.025	M8X35	100	55000.080.035	M8X240*	25	55000.080.240
M6X30	200	55000.060.030	M8X40	100	55000.080.040	M8X260*	25	55000.080.260
M6X35	100	55000.060.035	M8X45	100	55000.080.045	M8X270*	25	55000.080.270
M6X40	100	55000.060.040	M8X50	100	55000.080.050	M8X300*	25	55000.080.300
M6X45	100	55000.060.045	M8X55	100	55000.080.055			
M6X50	100	55000.060.050	M8X60	100	55000.080.060	M10X35/S=17	100	55000.100.035
M6X55	100	55000.060.055	M8X65	100	55000.080.065	M10X40/S=17	100	55000.100.040
M6X60	100	55000.060.060	M8X70	100	55000.080.070	M10X45/S=17	100	55000.100.045
M6X65	100	55000.060.065	M8X75	100	55000.080.075	M10X50/S=17	100	55000.100.050
M6X70	100	55000.060.070	M8X80	100	55000.080.080	M10X55/S=17	100	55000.100.055
M6X75	100	55000.060.075	M8X85	50	55000.080.085	M10X60/S=17	100	55000.100.060
M6X80	100	55000.060.080	M8X90	100	55000.080.090	M10X65/S=17	50	55000.100.065

55000		Hexagon head bolt						
d x L	☒	Art.number	d x L	☒	Art.number	d x L	☒	Art.number
M10X70/S=17	50	55000.100.070	M14X120/S=22	10	55000.140.120	M20X100	25	55000.200.100
M10X75/S=17	50	55000.100.075	M14X130/S=22*	25	55000.140.130	M20X110	25	55000.200.110
M10X80/S=17	50	55000.100.080	M14X140/S=22	10	55000.140.140	M20X120	10	55000.200.120
M10X85/S=17	50	55000.100.085	M14X150/S=22	10	55000.140.150	M20X130	10	55000.200.130
M10X90/S=17	50	55000.100.090	M14X160/S=22	10	55000.140.160	M20X140	10	55000.200.140
M10X95/S=17	50	55000.100.095	M14X170/S=22*	10	55000.140.170	M20X150	10	55000.200.150
M10X100/S=17	50	55000.100.100	M14X180/S=22	10	55000.140.180	M20X160	10	55000.200.160
M10X110/S=17	50	55000.100.110	M14X190/S=22*	10	55000.140.190	M20X170*	10	55000.200.170
M10X120/S=17	25	55000.100.120	M14X200/S=22	10	55000.140.200	M20X180	10	55000.200.180
M10X130/S=17	25	55000.100.130				M20X190*	10	55000.200.190
M10X140/S=17	25	55000.100.140	M16X45*	25	55000.160.045	M20X200	5	55000.200.200
M10X150/S=17	25	55000.100.150	M16X50*	25	55000.160.050	M20X210*	10	55000.200.210
M10X160/S=17	25	55000.100.160	M16X55	50	55000.160.055	M20X220	5	55000.200.220
M10X170/S=17	25	55000.100.170	M16X60	25	55000.160.060	M20X230*	10	55000.200.230
M10X180/S=17	25	55000.100.180	M16X65	25	55000.160.065	M20X240	5	55000.200.240
M10X190/S=17	25	55000.100.190	M16X70	25	55000.160.070	M20X250*	10	55000.200.250
M10X200/S=17	10	55000.100.200	M16X75	25	55000.160.075	M20X260	5	55000.200.260
M10X210/S=17*	10	55000.100.210	M16X80	25	55000.160.080	M20X270*	10	55000.200.270
M10X220/S=17	10	55000.100.220	M16X85	25	55000.160.085	M20X280	5	55000.200.280
M10X230/S=17*	10	55000.100.230	M16X90	25	55000.160.090	M20X290*	10	55000.200.290
M10X240/S=17*	10	55000.100.240	M16X95*	25	55000.160.095	M20X300	5	55000.200.300
M10X250/S=17*	10	55000.100.250	M16X100	25	55000.160.100	M20X320*	5	55000.200.320
M10X260/S=17*	10	55000.100.260	M16X110	25	55000.160.110	M20X340*	5	55000.200.340
M10X270/S=17*	10	55000.100.270	M16X120	10	55000.160.120	M20X360*	5	55000.200.360
M10X280/S=17*	10	55000.100.280	M16X130	10	55000.160.130	M20X380*	5	55000.200.380
M10X290/S=17*	10	55000.100.290	M16X140	10	55000.160.140	M20X400*	5	55000.200.400
M10X300/S=17*	10	55000.100.300	M16X150	10	55000.160.150	M20X420*	5	55000.200.420
M10X360/S=17*	10	55000.100.360	M16X160	10	55000.160.160	M20X440*	5	55000.200.440
M10X400/S=17*	10	55000.100.400	M16X170	10	55000.160.170	M20X460*	5	55000.200.460
			M16X180	5	55000.160.180	M20X500*	5	55000.200.500
M12X40/S=19	50	55000.120.040	M16X190	10	55000.160.190			
M12X45/S=19	50	55000.120.045	M16X200	5	55000.160.200	M22X70/S=32*	25	55000.220.070
M12X50/S=19	50	55000.120.050	M16X210*	10	55000.160.210	M22X75/S=32*	25	55000.220.075
M12X55/S=19	50	55000.120.055	M16X220	5	55000.160.220	M22X80/S=32	10	55000.220.080
M12X60/S=19	50	55000.120.060	M16X230*	10	55000.160.230	M22X85/S=32*	25	55000.220.085
M12X65/S=19	50	55000.120.065	M16X240	5	55000.160.240	M22X90/S=32	10	55000.220.090
M12X70/S=19	50	55000.120.070	M16X250*	10	55000.160.250	M22X95/S=32*	25	55000.220.095
M12X75/S=19	50	55000.120.075	M16X260	5	55000.160.260	M22X100/S=32	10	55000.220.100
M12X80/S=19	50	55000.120.080	M16X270*	10	55000.160.270	M22X110/S=32*	20	55000.220.110
M12X85/S=19	25	55000.120.085	M16X280	5	55000.160.280	M22X120/S=32	5	55000.220.120
M12X90/S=19	50	55000.120.090	M16X290*	10	55000.160.290	M22X130/S=32	5	55000.220.130
M12X95/S=19	25	55000.120.095	M16X300	5	55000.160.300	M22X140/S=32	5	55000.220.140
M12X100/S=19	50	55000.120.100	M16X320*	10	55000.160.320	M22X150/S=32	5	55000.220.150
M12X110/S=19	25	55000.120.110	M16X340*	10	55000.160.340	M22X160/S=32*	10	55000.220.160
M12X120/S=19	25	55000.120.120	M16X360*	10	55000.160.360	M22X170/S=32*	10	55000.220.170
M12X130/S=19	25	55000.120.130	M16X380*	10	55000.160.380	M22X180/S=32*	10	55000.220.180
M12X140/S=19	25	55000.120.140	M16X400*	10	55000.160.400	M22X200/S=32*	10	55000.220.200
M12X150/S=19	25	55000.120.150	M16X420*	10	55000.160.420			
M12X160/S=19	25	55000.120.160	M16X440*	10	55000.160.440	M24X65*	10	55000.240.065
M12X170/S=19	25	55000.120.170	M16X460*	10	55000.160.460	M24X70	10	55000.240.070
M12X180/S=19	25	55000.120.180	M16X480*	10	55000.160.480	M24X75*	10	55000.240.075
M12X190/S=19	25	55000.120.190	M16X500*	10	55000.160.500	M24X80	5	55000.240.080
M12X200/S=19	10	55000.120.200				M24X85*	10	55000.240.085
M12X210/S=19	10	55000.120.210	M18X60*	25	55000.180.060	M24X90	5	55000.240.090
M12X220/S=19	10	55000.120.220	M18X65	25	55000.180.065	M24X95*	10	55000.240.095
M12X230/S=19*	10	55000.120.230	M18X70	25	55000.180.070	M24X100	5	55000.240.100
M12X240/S=19	10	55000.120.240	M18X75*	25	55000.180.075	M24X110	5	55000.240.110
M12X250/S=19*	10	55000.120.250	M18X80	10	55000.180.080	M24X120	5	55000.240.120
M12X260/S=19*	10	55000.120.260	M18X85*	25	55000.180.085	M24X130	5	55000.240.130
M12X270/S=19*	10	55000.120.270	M18X90	10	55000.180.090	M24X140	5	55000.240.140
M12X280/S=19*	10	55000.120.280	M18X95*	25	55000.180.095	M24X150	5	55000.240.150
M12X290/S=19*	10	55000.120.290	M18X100	10	55000.180.100	M24X160	5	55000.240.160
M12X300/S=19*	10	55000.120.300	M18X110	10	55000.180.110	M24X170*	10	55000.240.170
M12X320/S=19*	10	55000.120.320	M18X120	10	55000.180.120	M24X180	5	55000.240.180
M12X340/S=19*	10	55000.120.340	M18X130*	25	55000.180.130	M24X190*	10	55000.240.190
M12X360/S=19*	10	55000.120.360	M18X140*	25	55000.180.140	M24X200	5	55000.240.200
M12X380/S=19*	10	55000.120.380	M18X150	10	55000.180.150	M24X210*	5	55000.240.210
M12X400/S=19*	10	55000.120.400	M18X160*	25	55000.180.160	M24X220	5	55000.240.220
			M18X170*	25	55000.180.170	M24X230	5	55000.240.230
M14X45/S=22*	50	55000.140.045	M18X180*	25	55000.180.180	M24X240	5	55000.240.240
M14X50/S=22*	50	55000.140.050	M18X190*	25	55000.180.190	M24X250*	5	55000.240.250
M14X55/S=22*	50	55000.140.055	M18X200*	25	55000.180.200	M24X260	5	55000.240.260
M14X60/S=22	50	55000.140.060				M24X270	5	55000.240.270
M14X65/S=22*	50	55000.140.065	M20X55*	25	55000.200.055	M24X280*	5	55000.240.280
M14X70/S=22	50	55000.140.070	M20X60	25	55000.200.060	M24X290*	5	55000.240.290
M14X75/S=22*	25	55000.140.075	M20X65	25	55000.200.065	M24X300*	5	55000.240.300
M14X80/S=22	10	55000.140.080	M20X70	25	55000.200.070	M24X320*	5	55000.240.320
M14X85/S=22*	25	55000.140.085	M20X75	25	55000.200.075	M24X340*	5	55000.240.340
M14X90/S=22	10	55000.140.090	M20X80	25	55000.200.080	M24X360*	5	55000.240.360
M14X95/S=22*	25	55000.140.095	M20X85	25	55000.200.085	M24X380*	5	55000.240.380
M14X100/S=22	10	55000.140.100	M20X90	25	55000.200.090	M24X400*	5	55000.240.400
M14X110/S=22	10	55000.140.110	M20X95*	25	55000.200.095	M24X440*	5	55000.240.440

55000 Hexagon head bolt								
d x L	☒	Art.number	d x L	☒	Art.number	d x L	☒	Art.number
M24X480*	5	55000.240.480	M30X150	1	55000.300.150	M36X120	1	55000.360.120
M24X500*	5	55000.240.500	M30X160	1	55000.300.160	M36X130	1	55000.360.130
M27X70*	10	55000.270.070	M30X170*	5	55000.300.170	M36X140	1	55000.360.140
M27X75*	10	55000.270.075	M30X180	1	55000.300.180	M36X150	1	55000.360.150
M27X80	3	55000.270.080	M30X190*	5	55000.300.190	M36X160	1	55000.360.160
M27X85*	10	55000.270.085	M30X200	1	55000.300.200	M36X170	1	55000.360.170
M27X90	3	55000.270.090	M30X210	1	55000.300.210	M36X180	1	55000.360.180
M27X95*	10	55000.270.095	M30X220	1	55000.300.220	M36X190	1	55000.360.190
M27X100	3	55000.270.100	M30X230*	5	55000.300.230	M36X200	1	55000.360.200
M27X110	3	55000.270.110	M30X240	1	55000.300.240	M36X210*	5	55000.360.210
M27X120	3	55000.270.120	M30X250	1	55000.300.250	M36X220	1	55000.360.220
M27X130	3	55000.270.130	M30X260*	5	55000.300.260	M36X230*	5	55000.360.230
M27X140	3	55000.270.140	M30X270*	5	55000.300.270	M36X240	1	55000.360.240
M27X150	3	55000.270.150	M30X280*	5	55000.300.280	M36X250*	5	55000.360.250
M27X160	3	55000.270.160	M30X290*	5	55000.300.290	M36X260*	5	55000.360.260
M27X170*	5	55000.270.170	M30X300*	5	55000.300.300	M36X300*	5	55000.360.300
M27X180	3	55000.270.180	M33X90	1	55000.330.090	M39X120*	10	55000.390.120
M27X190*	5	55000.270.190	M33X100	1	55000.330.100	M39X130*	10	55000.390.130
M27X200	3	55000.270.200	M33X110	1	55000.330.110	M39X140*	10	55000.390.140
M27X210*	5	55000.270.210	M33X120	1	55000.330.120	M39X150*	5	55000.390.150
M27X220	3	55000.270.220	M33X130	1	55000.330.130	M39X160*	5	55000.390.160
M27X230*	5	55000.270.230	M33X140	1	55000.330.140	M39X170*	5	55000.390.170
M27X240	3	55000.270.240	M33X150	1	55000.330.150	M39X180*	5	55000.390.180
M27X250*	5	55000.270.250	M33X160	1	55000.330.160	M39X200*	5	55000.390.200
M27X260*	5	55000.270.260	M33X170	1	55000.330.170	M42X120*	5	55000.420.120
M27X270*	5	55000.270.270	M33X180	1	55000.330.180	M42X130*	5	55000.420.130
M27X280*	5	55000.270.280	M33X190	1	55000.330.190	M42X140*	5	55000.420.140
M27X290*	5	55000.270.290	M33X200	1	55000.330.200	M42X150*	5	55000.420.150
M27X300*	5	55000.270.300	M33X210*	5	55000.330.210	M42X160*	5	55000.420.160
M30X80*	10	55000.300.080	M33X220	1	55000.330.220	M42X190*	5	55000.420.190
M30X85*	10	55000.300.085	M33X230*	5	55000.330.230	M42X200*	5	55000.420.200
M30X90	1	55000.300.090	M33X240	1	55000.330.240	M45X140*	5	55000.450.140
M30X95*	10	55000.300.095	M33X250*	5	55000.330.250	M45X180*	5	55000.450.180
M30X100	1	55000.300.100	M33X260	1	55000.330.260	M48X150*	5	55000.480.150
M30X110	1	55000.300.110	M33X290*	5	55000.330.290	M48X180*	5	55000.480.180
M30X120	1	55000.300.120	M33X300*	5	55000.330.300	M48X200*	5	55000.480.200
M30X130	1	55000.300.130	M36X100	1	55000.360.100			
M30X140	1	55000.300.140	M36X110	1	55000.360.110			

• Sizes with a diameter > M24 and sizes with a length > 8xd are minimal property class 50.

53510 Hexagon head bolt		R11A
Thread	Metric thread	
Material	Stainless steel A4	
Class	80	
		

d x L	☒	Art.number	d x L	☒	Art.number	d x L	☒	Art.number
M5X25	200	53510.050.025	M6X90*	100	53510.060.090	M8X100	50	53510.080.100
M5X30*	200	53510.050.030	M6X95*	100	53510.060.095	M8X110*	50	53510.080.110
M5X35*	200	53510.050.035	M6X100	100	53510.060.100	M8X120*	50	53510.080.120
M5X40*	200	53510.050.040	M6X110*	100	53510.060.110	M8X130*	50	53510.080.130
M5X45*	200	53510.050.045	M6X120*	100	53510.060.120	M8X140*	50	53510.080.140
M5X50*	200	53510.050.050	M6X130*	100	53510.060.130	M8X150*	50	53510.080.150
M5X55*	200	53510.050.055	M6X140*	100	53510.060.140	M8X160*	25	53510.080.160
M5X60*	200	53510.050.060	M6X150*	100	53510.060.150	M8X170*	25	53510.080.170
M5X65*	200	53510.050.065	M6X160*	100	53510.060.160	M8X180*	25	53510.080.180
M5X70*	100	53510.050.070	M6X170*	100	53510.060.170	M8X190*	25	53510.080.190
M5X75*	100	53510.050.075	M6X180*	100	53510.060.180	M8X200*	25	53510.080.200
M5X80*	100	53510.050.080	M6X190*	100	53510.060.190	M8X220*	25	53510.080.220
M5X90*	100	53510.050.090	M6X200*	100	53510.060.200	M10X35/S=17*	100	53510.100.035
M5X100*	100	53510.050.100	M8X30*	100	53510.080.030	M10X40/S=17	50	53510.100.040
M6X25*	200	53510.060.025	M8X35*	100	53510.080.035	M10X45/S=17	50	53510.100.045
M6X30	100	53510.060.030	M8X40	50	53510.080.040	M10X50/S=17	50	53510.100.050
M6X35	100	53510.060.035	M8X45	50	53510.080.045	M10X55/S=17*	50	53510.100.055
M6X40	100	53510.060.040	M8X50	50	53510.080.050	M10X60/S=17	50	53510.100.060
M6X45*	100	53510.060.045	M8X55*	100	53510.080.055	M10X65/S=17*	50	53510.100.065
M6X50	100	53510.060.050	M8X60	50	53510.080.060	M10X70/S=17	50	53510.100.070
M6X55*	100	53510.060.055	M8X65*	100	53510.080.065	M10X75/S=17*	50	53510.100.075
M6X60	100	53510.060.060	M8X70	50	53510.080.070	M10X80/S=17	50	53510.100.080
M6X65	100	53510.060.065	M8X75*	50	53510.080.075	M10X85/S=17*	50	53510.100.085
M6X70	100	53510.060.070	M8X80	50	53510.080.080	M10X90/S=17	50	53510.100.090
M6X75*	100	53510.060.075	M8X85*	50	53510.080.085	M10X95/S=17*	50	53510.100.095
M6X80	100	53510.060.080	M8X90*	50	53510.080.090	M10X100/S=17	50	53510.100.100
M6X85*	100	53510.060.085	M8X95*	50	53510.080.095	M10X110/S=17*	50	53510.100.110

53510 Hexagon head bolt								
d x L	☒	Art.number	d x L	☒	Art.number	d x L	☒	Art.number
M10X120/S=17*	50	53510.100.120	M14X70/S=22*	50	53510.140.070	M20X90	10	53510.200.090
M10X130/S=17*	50	53510.100.130	M14X75/S=22*	25	53510.140.075	M20X95*	25	53510.200.095
M10X140/S=17*	50	53510.100.140	M14X80/S=22*	25	53510.140.080	M20X100	10	53510.200.100
M10X150/S=17*	50	53510.100.150	M14X90/S=22*	25	53510.140.090	M20X110*	25	53510.200.110
M10X160/S=17*	25	53510.100.160	M14X95/S=22*	25	53510.140.095	M20X120	10	53510.200.120
M10X170/S=17*	25	53510.100.170	M14X100/S=22*	25	53510.140.100	M20X130*	25	53510.200.130
M10X180/S=17*	25	53510.100.180	M14X110/S=22*	25	53510.140.110	M20X140*	25	53510.200.140
M10X190/S=17*	25	53510.100.190	M14X120/S=22*	25	53510.140.120	M20X150	10	53510.200.150
M10X200/S=17*	25	53510.100.200	M14X130/S=22*	25	53510.140.130	M20X160*	10	53510.200.160
M10X210/S=17*	10	53510.100.210	M14X140/S=22*	25	53510.140.140	M20X170*	10	53510.200.170
M10X220/S=17*	10	53510.100.220	M14X160/S=22*	10	53510.140.160	M20X180*	10	53510.200.180
M10X230/S=17*	10	53510.100.230	M14X180/S=22*	10	53510.140.180	M20X190*	10	53510.200.190
M10X240/S=17*	10	53510.100.240				M20X200*	10	53510.200.200
M10X250/S=17*	10	53510.100.250	M16X50	25	53510.160.050	M20X210*	10	53510.200.210
			M16X55	25	53510.160.055	M20X220*	10	53510.200.220
M12X40/S=19	50	53510.120.040	M16X60	25	53510.160.060	M20X230*	10	53510.200.230
M12X45/S=19	25	53510.120.045	M16X65	25	53510.160.065	M20X240*	10	53510.200.240
M12X50/S=19	25	53510.120.050	M16X70	25	53510.160.070	M20X250*	10	53510.200.250
M12X55/S=19	25	53510.120.055	M16X75	25	53510.160.075			
M12X60/S=19	25	53510.120.060	M16X80	25	53510.160.080	M24X70*	10	53510.240.070
M12X65/S=19	25	53510.120.065	M16X85*	25	53510.160.085	M24X75*	10	53510.240.075
M12X70/S=19	25	53510.120.070	M16X90	25	53510.160.090	M24X80	10	53510.240.080
M12X75/S=19	25	53510.120.075	M16X95*	25	53510.160.095	M24X85*	10	53510.240.085
M12X80/S=19	25	53510.120.080	M16X100	25	53510.160.100	M24X90	10	53510.240.090
M12X85/S=19*	25	53510.120.085	M16X110	25	53510.160.110	M24X95*	10	53510.240.095
M12X90/S=19	25	53510.120.090	M16X120	25	53510.160.120	M24X100	10	53510.240.100
M12X95/S=19*	25	53510.120.095	M16X130*	25	53510.160.130	M24X110*	10	53510.240.110
M12X100/S=19	25	53510.120.100	M16X140	25	53510.160.140	M24X120	10	53510.240.120
M12X110/S=19*	25	53510.120.110	M16X150	25	53510.160.150	M24X130*	10	53510.240.130
M12X120/S=19	25	53510.120.120	M16X160*	10	53510.160.160	M24X140*	10	53510.240.140
M12X130/S=19*	25	53510.120.130	M16X170*	10	53510.160.170	M24X150	10	53510.240.150
M12X140/S=19*	25	53510.120.140	M16X180*	10	53510.160.180	M24X160*	10	53510.240.160
M12X150/S=19*	25	53510.120.150	M16X190*	10	53510.160.190	M24X170*	10	53510.240.170
M12X160/S=19*	10	53510.120.160	M16X200*	10	53510.160.200	M24X180*	10	53510.240.180
M12X170/S=19*	10	53510.120.170	M16X210*	10	53510.160.210	M24X190*	10	53510.240.190
M12X180/S=19*	10	53510.120.180	M16X220*	10	53510.160.220	M24X200*	10	53510.240.200
M12X190/S=19*	10	53510.120.190	M16X230*	10	53510.160.230	M24X220*	5	53510.240.220
M12X200/S=19*	10	53510.120.200	M16X240*	10	53510.160.240	M24X230*	5	53510.240.230
M12X210/S=19*	10	53510.120.210	M16X250*	10	53510.160.250	M24X240*	5	53510.240.240
M12X220/S=19*	10	53510.120.220	M16X260*	10	53510.160.260	M24X250*	5	53510.240.250
M12X230/S=19*	10	53510.120.230				M24X260*	5	53510.240.260
M12X240/S=19*	10	53510.120.240	M20X55*	25	53510.200.055	M24X280*	5	53510.240.280
M12X250/S=19*	10	53510.120.250	M20X60*	25	53510.200.060	M24X300*	5	53510.240.300
			M20X65*	25	53510.200.065			
M14X50/S=22*	50	53510.140.050	M20X70	10	53510.200.070	M27X130*	10	53510.270.130
M14X55/S=22*	50	53510.140.055	M20X75*	25	53510.200.075			
M14X60/S=22*	50	53510.140.060	M20X80	10	53510.200.080	M30X90*	10	53510.300.090
M14X65/S=22*	50	53510.140.065	M20X85*	25	53510.200.085			

23010 Hexagon head bolt				G90A			
Thread	Metric thread						
Material	Steel 25CrMo4+QT						
Class	KG						
							
							

d x L	☒	Art.number	d x L	☒	Art.number	d x L	☒	Art.number
M20X100	10	23010.200.100	M24X120	10	23010.240.120	M30X150	5	23010.300.150
M20X120	10	23010.200.120	M24X140	10	23010.240.140			

Special features hexagon head bolts:

- Made of steel St 25CrMo4+QT materialnumber: 1.7218.
- Intended for use at high temperatures up to 400°C.
- Thread lengths differ from ISO 4014.
- Mechanical properties acc. to EN 10269.
- The bolt head is marked with sign KG, acc. to DIN 267-13.

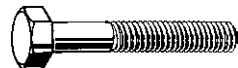
56090 Hexagon head bolt plastic				W02A			
Thread	Metric thread			DIN	≈931		
Material	Plastic Polyamide (nylon)			ISO	≈4014		
Class	PA 6.6			NEN	≈1555		
Color	White			ASME	≈B18.2.3.1M		
				NF	≈E25-112		

d x L/b	☒	Art.number	d x L/b	☒	Art.number	d x L/b	☒	Art.number
M8X70	50	56090.080.070	M12X40/30	25	56090.120.040	M12X60/50	25	56090.120.060
M10X60/50	25	56090.100.060	M12X50/50	25	56090.120.050	M12X80/30	25	56090.120.080

Hexagon head bolt with hexagon nut

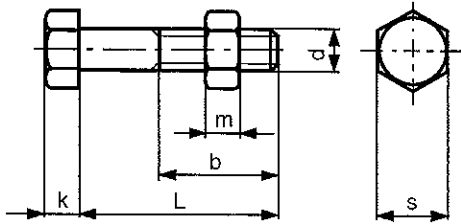

DIN 601/555 (1987)
ISO 4016/-
NEN 102/697
NF E25-115-1/E25-402

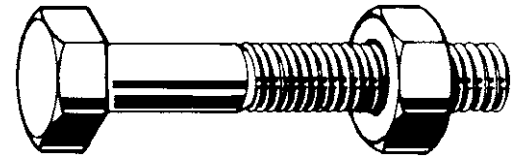

Technical Data

d	b (min.): L≤125mm	b (min.): 125mm<L≤200mm	b (min.): L>200mm	k	m	P	s
M6	18	24	37	4	5	1	10
M8	22	28	41	5.3	6.5	1.25	13
M10	26	32	45	6.4	8	1.5	17
M12	30	36	49	7.5	10	1.75	19
M14	34	40	53	8.8	11	2	22
M16	38	44	57	10	13	2	24
M20	46	52	65	12.5	16	2.5	30
M24	54	60	73	15	19	3	36

• The corresponding hexagon nuts have a property class ≥ I4I.

08200 Hexagon head bolt with hexagon nut

E03A

Thread Metric thread
Material Steel
Class ≥4.6
Surface treatment Zinc plated



d x L	☒	Art.number	d x L	☒	Art.number	d x L	☒	Art.number
M6X16	500	08200.060.016	M10X100	100	08200.100.100	M16X110	25	08200.160.110
M6X20	500	08200.060.020	M10X110	50	08200.100.110	M16X120	25	08200.160.120
M6X25	500	08200.060.025	M10X120	50	08200.100.120	M16X130	25	08200.160.130
M6X30	500	08200.060.030	M10X140	50	08200.100.140	M16X140	25	08200.160.140
M6X40	200	08200.060.040				M16X160	25	08200.160.160
M6X50	200	08200.060.050	M12X25	100	08200.120.025	M16X180	25	08200.160.180
M6X60	200	08200.060.060	M12X30	100	08200.120.030	M16X200	25	08200.160.200
M6X70	200	08200.060.070	M12X35	100	08200.120.035			
M6X80	200	08200.060.080	M12X40	100	08200.120.040	M20X40	25	08200.200.040
M6X100	100	08200.060.100	M12X45	100	08200.120.045	M20X50	25	08200.200.050
			M12X50	100	08200.120.050	M20X60	25	08200.200.060
M8X16	200	08200.080.016	M12X55	100	08200.120.055	M20X65	25	08200.200.065
M8X20	200	08200.080.020	M12X60	100	08200.120.060	M20X70	25	08200.200.070
M8X25	200	08200.080.025	M12X70	50	08200.120.070	M20X75	25	08200.200.075
M8X30	200	08200.080.030	M12X80	50	08200.120.080	M20X80	25	08200.200.080
M8X40	200	08200.080.040	M12X100	50	08200.120.100	M20X90	25	08200.200.090
M8X45	200	08200.080.045	M12X110	50	08200.120.110	M20X100	25	08200.200.100
M8X50	200	08200.080.050	M12X130	50	08200.120.130	M20X110	25	08200.200.110
M8X55	200	08200.080.055	M12X150	50	08200.120.150	M20X120	25	08200.200.120
M8X60	200	08200.080.060	M12X180	25	08200.120.180	M20X130	25	08200.200.130
M8X70	200	08200.080.070	M12X260	25	08200.120.260	M20X140	25	08200.200.140
M8X80	200	08200.080.080				M20X150	10	08200.200.150
M8X90	100	08200.080.090	M16X35	50	08200.160.035	M20X160	10	08200.200.160
M8X100	100	08200.080.100	M16X40	50	08200.160.040	M20X180	10	08200.200.180
			M16X45	50	08200.160.045	M20X200	10	08200.200.200
M10X25	200	08200.100.025	M16X50	50	08200.160.050	M20X220	10	08200.200.220
M10X30	200	08200.100.030	M16X55	50	08200.160.055	M20X240	10	08200.200.240
M10X35	100	08200.100.035	M16X60	50	08200.160.060			
M10X40	100	08200.100.040	M16X65	25	08200.160.065	M24X70	25	08200.240.070
M10X45	100	08200.100.045	M16X70	25	08200.160.070	M24X80	25	08200.240.080
M10X50	100	08200.100.050	M16X80	25	08200.160.080	M24X90	10	08200.240.090
M10X70	100	08200.100.070	M16X90	25	08200.160.090	M24X100	10	08200.240.100
M10X90	100	08200.100.090	M16X100	25	08200.160.100	M24X110	10	08200.240.110

Hexagon head screw

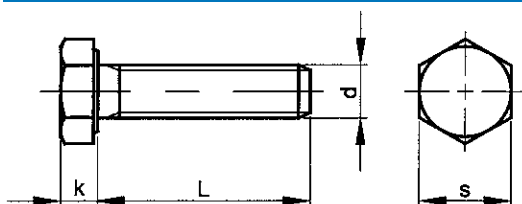

ISO 4017
 DIN 933
 NEN 1568
 ASME B18.2.3.1M
 NF E25-114

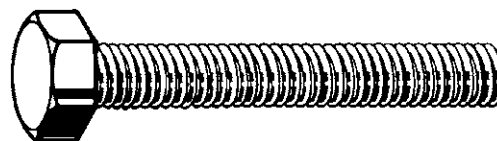

Technical Data

d	k	P	s
M2	1.4	0.4	4
M2.5	1.7	0.45	5
M3	2	0.5	5.5
M4	2.8	0.7	7
M5	3.5	0.8	8
M6	4	1	10
M7	4.8	1	11
M8	5.3	1.25	13
M10 (DIN)	6.4	1.5	17
M10	6.4	1.5	16
M12 (DIN)	7.5	1.75	19
M12	7.5	1.75	18
M14 (DIN)	8.8	2	22
M14	8.8	2	21
M16	10	2	24
M18	11.5	2.5	27
M20	12.5	2.5	30
M22 (DIN)	14	2.5	32
M22	14	2.5	34
M24	15	3	36
M27	17	3	41
M30	18.7	3.5	46
M33	21	3.5	50
M36	22.5	4	55
M39	25	4	60
M42	26	4.5	65
M45	28	4.5	70
M48	30	5	75
M52	33	5	80
M64	40	6	95

Article groups

Thread	Driving features	Material	Class	Surface treatment	Color	Code	Page
M	Hexagon	St	8.8			01010	1-20
M	Hexagon	St	8.8	Zipl		01210	1-21
M	Hexagon	St	8.8	Zipl yell.p.		01230	1-22
M	Hexagon	St	8.8	FLZNNC-NC6		01236	1-24
M	Hexagon	St	8.8	Hot d.g.	ISO metric	01410	1-24
M	Hexagon	St	8.8	Hot d.g.	oversized	01430	1-25
M	Hexagon	St	10.9			04110	1-26
M	Hexagon	St	10.9	FLZNNC-NC6		04116	1-26
M	Hexagon	St	12.9			04118	1-27
M	Hexagon	St	5.6		for pressure vessels	08760	1-27
M	Hexagon	St.St. A2	70			51010	1-27
M	Hexagon	St.St. A4	70			55010	1-29
M	Hexagon	St.St. A4	80			53520	1-31
M	Hexagon	St.St. A5	70			53521	1-32
M	Hexagon	Al P40				45010	1-33
M	Hexagon	Al P60				45210	1-33
M	Hexagon	Kuprodur Cu5	60			45810	1-33
M	Hexagon	Br Cu2/Cu3				46010	1-33
M	Hexagon	Br Cu2/Cu3		Ni.pl.		46060	1-34
M	Hexagon	Ti ASTM	Gr.2			45910	1-34
M	Hexagon	Plastic PA	PA 6.6		White	56100	1-34

01010 Hexagon head screw		A01A	
Thread	Metric thread		
Material	Steel		
Class	8.8		
			

d x L	☒	Art.number	d x L	☒	Art.number	d x L	☒	Art.number
M4X8	500	01010.040.008	M8X120	100	01010.080.120	M16X50	50	01010.160.050
M4X10	500	01010.040.010				M16X55	50	01010.160.055
M4X12	500	01010.040.012	M10X12/S=17	200	01010.100.012	M16X60	50	01010.160.060
M4X16	500	01010.040.016	M10X16/S=17	200	01010.100.016	M16X65	25	01010.160.065
M4X20	500	01010.040.020	M10X20/S=17	200	01010.100.020	M16X70	25	01010.160.070
M4X25	500	01010.040.025	M10X22/S=17	200	01010.100.022	M16X75	25	01010.160.075
M4X30	500	01010.040.030	M10X25/S=17	200	01010.100.025	M16X80	25	01010.160.080
M4X35	500	01010.040.035	M10X28/S=17	200	01010.100.028	M16X90	25	01010.160.090
M4X40	500	01010.040.040	M10X30/S=17	200	01010.100.030	M16X100	25	01010.160.100
M4X50	500	01010.040.050	M10X35/S=17	100	01010.100.035	M16X110	25	01010.160.110
			M10X40/S=17	100	01010.100.040	M16X120	25	01010.160.120
M5X8	200	01010.050.008	M10X45/S=17	100	01010.100.045	M16X130	25	01010.160.130
M5X10	200	01010.050.010	M10X50/S=17	100	01010.100.050	M16X140	25	01010.160.140
M5X12	200	01010.050.012	M10X55/S=17	100	01010.100.055	M16X150	25	01010.160.150
M5X16	200	01010.050.016	M10X60/S=17	100	01010.100.060	M16X160	25	01010.160.160
M5X18	200	01010.050.018	M10X65/S=17	100	01010.100.065	M16X180	25	01010.160.180
M5X20	200	01010.050.020	M10X70/S=17	100	01010.100.070	M16X200	25	01010.160.200
M5X25	200	01010.050.025	M10X75/S=17	100	01010.100.075			
M5X30	200	01010.050.030	M10X80/S=17	100	01010.100.080	M18X30	50	01010.180.030
M5X35	200	01010.050.035	M10X90/S=17	100	01010.100.090	M18X35	50	01010.180.035
M5X40	200	01010.050.040	M10X100/S=17	100	01010.100.100	M18X40	50	01010.180.040
M5X50	200	01010.050.050	M10X110/S=17	50	01010.100.110	M18X45	50	01010.180.045
M5X60	200	01010.050.060	M10X120/S=17	50	01010.100.120	M18X50	50	01010.180.050
			M10X130/S=17	50	01010.100.130	M18X55	25	01010.180.055
			M10X140/S=17	50	01010.100.140	M18X60	25	01010.180.060
			M10X150/S=17	50	01010.100.150	M18X70	25	01010.180.070
						M18X80	25	01010.180.080
M6X8	200	01010.060.008	M12X16/S=19	100	01010.120.016	M18X90	25	01010.180.090
M6X10	200	01010.060.010	M12X20/S=19	100	01010.120.020	M18X100	25	01010.180.100
M6X12	200	01010.060.012	M12X25/S=19	100	01010.120.025	M18X110	25	01010.180.110
M6X14	200	01010.060.014	M12X28/S=19	100	01010.120.028	M18X120	25	01010.180.120
M6X16	200	01010.060.016	M12X30/S=19	100	01010.120.030			
M6X18	200	01010.060.018	M12X35/S=19	100	01010.120.035	M20X30	25	01010.200.030
M6X20	200	01010.060.020	M12X40/S=19	100	01010.120.040	M20X35	25	01010.200.035
M6X22	200	01010.060.022	M12X45/S=19	100	01010.120.045	M20X40	25	01010.200.040
M6X25	200	01010.060.025	M12X50/S=19	100	01010.120.050	M20X45	25	01010.200.045
M6X30	200	01010.060.030	M12X55/S=19	100	01010.120.055	M20X50	25	01010.200.050
M6X35	200	01010.060.035	M12X60/S=19	100	01010.120.060	M20X55	25	01010.200.055
M6X40	200	01010.060.040	M12X65/S=19	50	01010.120.065	M20X60	25	01010.200.060
M6X45	200	01010.060.045	M12X70/S=19	50	01010.120.070	M20X65	25	01010.200.065
M6X50	200	01010.060.050	M12X75/S=19	50	01010.120.075	M20X70	25	01010.200.070
M6X55	200	01010.060.055	M12X80/S=19	50	01010.120.080	M20X75	25	01010.200.075
M6X60	200	01010.060.060	M12X90/S=19	50	01010.120.090	M20X80	25	01010.200.080
M6X70	200	01010.060.070	M12X100/S=19	50	01010.120.100	M20X90	25	01010.200.090
M6X80	200	01010.060.080	M12X110/S=19	50	01010.120.110	M20X100	25	01010.200.100
			M12X120/S=19	50	01010.120.120	M20X110	25	01010.200.110
M7X12	200	01010.070.012	M12X130/S=19	50	01010.120.130	M20X120	25	01010.200.120
M7X16	200	01010.070.016	M12X140/S=19	50	01010.120.140	M20X130	25	01010.200.130
M7X20	200	01010.070.020	M12X150/S=19	50	01010.120.150	M20X140	25	01010.200.140
M7X25	200	01010.070.025	M12X160/S=19	50	01010.120.160	M20X150	10	01010.200.150
M7X30	200	01010.070.030	M12X180/S=19	50	01010.120.180	M20X160	10	01010.200.160
M7X35	200	01010.070.035				M20X180	10	01010.200.180
M7X40	200	01010.070.040				M20X200	10	01010.200.200
M7X45	200	01010.070.045						
M7X50	200	01010.070.050						
			M14X20/S=22	100	01010.140.020			
M8X10	200	01010.080.010	M14X25/S=22	100	01010.140.025			
M8X12	200	01010.080.012	M14X30/S=22	100	01010.140.030	M22X40/S=32	25	01010.220.040
M8X14	200	01010.080.014	M14X35/S=22	100	01010.140.035	M22X50/S=32	25	01010.220.050
M8X16	200	01010.080.016	M14X40/S=22	100	01010.140.040	M22X55/S=32	25	01010.220.055
M8X18	200	01010.080.018	M14X45/S=22	50	01010.140.045	M22X60/S=32	25	01010.220.060
M8X20	200	01010.080.020	M14X50/S=22	50	01010.140.050	M22X65/S=32	25	01010.220.065
M8X22	200	01010.080.022	M14X55/S=22	50	01010.140.055	M22X70/S=32	25	01010.220.070
M8X25	200	01010.080.025	M14X60/S=22	50	01010.140.060	M22X80/S=32	25	01010.220.080
M8X30	200	01010.080.030	M14X65/S=22	50	01010.140.065	M22X90/S=32	25	01010.220.090
M8X35	200	01010.080.035	M14X70/S=22	50	01010.140.070	M22X100/S=32	10	01010.220.100
M8X40	200	01010.080.040	M14X75/S=22	50	01010.140.075	M22X120/S=32	25	01010.220.120
M8X45	200	01010.080.045	M14X80/S=22	50	01010.140.080	M22X150/S=32	10	01010.220.150
M8X50	200	01010.080.050	M14X90/S=22	50	01010.140.090			
M8X55	200	01010.080.055	M14X100/S=22	50	01010.140.100	M24X40	25	01010.240.040
M8X60	200	01010.080.060	M14X120/S=22	50	01010.140.120	M24X45	25	01010.240.045
M8X65	200	01010.080.065				M24X50	25	01010.240.050
M8X70	200	01010.080.070	M16X20	50	01010.160.020	M24X55	25	01010.240.055
M8X75	200	01010.080.075	M16X25	50	01010.160.025	M24X60	25	01010.240.060
M8X80	200	01010.080.080	M16X30	50	01010.160.030	M24X65	25	01010.240.065
M8X90	100	01010.080.090	M16X35	50	01010.160.035	M24X70	25	01010.240.070
M8X100	100	01010.080.100	M16X40	50	01010.160.040	M24X75	25	01010.240.075
M8X110	100	01010.080.110	M16X45	50	01010.160.045	M24X80	25	01010.240.080

01010 Hexagon head screw								
d x L	☒	Art.number	d x L	☒	Art.number	d x L	☒	Art.number
M24X90	10	01010.240.090	M30X80	10	01010.300.080	M36X140	5	01010.360.140
M24X100	10	01010.240.100	M30X90	10	01010.300.090	M36X160	5	01010.360.160
M24X110	10	01010.240.110	M30X100	10	01010.300.100	M36X180	5	01010.360.180
M24X120	10	01010.240.120	M30X110	10	01010.300.110			
M24X130	10	01010.240.130	M30X120	10	01010.300.120	M39X80	1	01010.390.080
M24X140	10	01010.240.140	M30X130	10	01010.300.130	M39X90	1	01010.390.090
M24X150	10	01010.240.150	M30X140	5	01010.300.140	M39X100	1	01010.390.100
M24X160	10	01010.240.160	M30X160	5	01010.300.160	M39X150	1	01010.390.150
M24X200	10	01010.240.200	M30X180	5	01010.300.180			
			M30X200	5	01010.300.200	M42X80	1	01010.420.080
M27X50	10	01010.270.050				M42X90	1	01010.420.090
M27X60	10	01010.270.060	M33X60	5	01010.330.060	M42X100	1	01010.420.100
M27X70	10	01010.270.070	M33X70	5	01010.330.070	M42X120	1	01010.420.120
M27X75	10	01010.270.075	M33X80	5	01010.330.080			
M27X80	10	01010.270.080	M33X90	5	01010.330.090	M45X90	1	01010.450.090
M27X90	10	01010.270.090	M33X100	5	01010.330.100	M45X100	1	01010.450.100
M27X100	10	01010.270.100	M33X140	5	01010.330.140			
M27X110	10	01010.270.110				M48X100	1	01010.480.100
M27X120	10	01010.270.120	M36X50	5	01010.360.050	M48X110	1	01010.480.110
			M36X60	5	01010.360.060	M48X120	1	01010.480.120
M30X40	10	01010.300.040	M36X70	5	01010.360.070	M48X180	5	01010.480.180
M30X50	10	01010.300.050	M36X80	5	01010.360.080			
M30X60	10	01010.300.060	M36X90	5	01010.360.090	M52X100	1	01010.520.100
M30X65	10	01010.300.065	M36X100	5	01010.360.100	M52X120	1	01010.520.120
M30X70	10	01010.300.070	M36X110	5	01010.360.110			
M30X75	10	01010.300.075	M36X130	5	01010.360.130	M64X160	1	01010.640.160

01210 Hexagon head screw			A05A				
Thread	Metric thread						
Material	Steel						
Class	8.8						
Surface treatment	Zinc plated						
							

d x L	☒	Art.number	d x L	☒	Art.number	d x L	☒	Art.number
M3X6	500	01210.030.006	M6X12	200	01210.060.012	M8X35	200	01210.080.035
M3X8	500	01210.030.008	M6X14	200	01210.060.014	M8X40	200	01210.080.040
M3X10	500	01210.030.010	M6X16	200	01210.060.016	M8X45	200	01210.080.045
M3X12	500	01210.030.012	M6X18	200	01210.060.018	M8X50	200	01210.080.050
M3X16	500	01210.030.016	M6X20	200	01210.060.020	M8X55	200	01210.080.055
M3X20	500	01210.030.020	M6X22	200	01210.060.022	M8X60	200	01210.080.060
M3X25	500	01210.030.025	M6X25	200	01210.060.025	M8X65	200	01210.080.065
M3X30	500	01210.030.030	M6X30	200	01210.060.030	M8X70	200	01210.080.070
M3X40	500	01210.030.040	M6X35	200	01210.060.035	M8X75	200	01210.080.075
			M6X40	200	01210.060.040	M8X80	200	01210.080.080
M4X6	500	01210.040.006	M6X45	200	01210.060.045	M8X90	100	01210.080.090
M4X8	500	01210.040.008	M6X50	200	01210.060.050	M8X100	100	01210.080.100
M4X10	500	01210.040.010	M6X55	200	01210.060.055	M8X110	100	01210.080.110
M4X12	500	01210.040.012	M6X60	200	01210.060.060	M8X120	100	01210.080.120
M4X16	500	01210.040.016	M6X65	200	01210.060.065	M8X130	100	01210.080.130
M4X20	500	01210.040.020	M6X70	200	01210.060.070	M8X140	100	01210.080.140
M4X25	500	01210.040.025	M6X75	200	01210.060.075	M8X150	50	01210.080.150
M4X30	500	01210.040.030	M6X80	200	01210.060.080			
M4X35	500	01210.040.035	M6X90	100	01210.060.090	M10X10/S=17	200	01210.100.010
M4X40	500	01210.040.040	M6X100	100	01210.060.100	M10X12/S=17	200	01210.100.012
M4X45	500	01210.040.045	M6X120	100	01210.060.120	M10X14/S=17	200	01210.100.014
M4X50	500	01210.040.050				M10X16/S=17	200	01210.100.016
M4X60	200	01210.040.060	M7X10	200	01210.070.010	M10X16/S=16	200	01210.100.017
			M7X12	200	01210.070.012	M10X20/S=17	200	01210.100.020
M5X6	200	01210.050.006	M7X16	200	01210.070.016	M10X20/S=16	200	01210.100.021
M5X8	200	01210.050.008	M7X20	200	01210.070.020	M10X22/S=17	200	01210.100.022
M5X10	200	01210.050.010	M7X25	200	01210.070.025	M10X25/S=17	200	01210.100.025
M5X12	200	01210.050.012	M7X30	200	01210.070.030	M10X25/S=16	200	01210.100.026
M5X16	200	01210.050.016	M7X35	200	01210.070.035	M10X30/S=17	200	01210.100.030
M5X18	200	01210.050.018	M7X40	200	01210.070.040	M10X30/S=16	200	01210.100.031
M5X20	200	01210.050.020	M7X45	200	01210.070.045	M10X35/S=17	100	01210.100.035
M5X22	200	01210.050.022	M7X50	200	01210.070.050	M10X35/S=16	100	01210.100.036
M5X25	200	01210.050.025	M7X60	200	01210.070.060	M10X40/S=17	100	01210.100.040
M5X30	200	01210.050.030	M7X70	200	01210.070.070	M10X40/S=16	100	01210.100.041
M5X35	200	01210.050.035				M10X45/S=17	100	01210.100.045
M5X40	200	01210.050.040	M8X10	200	01210.080.010	M10X45/S=16	100	01210.100.046
M5X45	200	01210.050.045	M8X12	200	01210.080.012	M10X50/S=17	100	01210.100.050
M5X50	200	01210.050.050	M8X14	200	01210.080.014	M10X50/S=16	100	01210.100.051
M5X55	200	01210.050.055	M8X16	200	01210.080.016	M10X55/S=17	100	01210.100.055
M5X60	200	01210.050.060	M8X18	200	01210.080.018	M10X60/S=17	100	01210.100.060
M5X70	200	01210.050.070	M8X20	200	01210.080.020	M10X60/S=16	100	01210.100.061
			M8X22	200	01210.080.022	M10X65/S=17	100	01210.100.065
M6X8	200	01210.060.008	M8X25	200	01210.080.025	M10X65/S=16	100	01210.100.066
M6X10	200	01210.060.010	M8X30	200	01210.080.030	M10X70/S=17	100	01210.100.070

01210 Hexagon head screw								
d x L	☒	Art.number	d x L	☒	Art.number	d x L	☒	Art.number
M10X75/S=17	100	01210.100.075	M14X90/S=22	50	01210.140.090	M22X70/S=32	25	01210.220.070
M10X80/S=17	100	01210.100.080	M14X100/S=22	50	01210.140.100	M22X80/S=32	25	01210.220.080
M10X90/S=17	100	01210.100.090	M14X110/S=22	50	01210.140.110	M22X90/S=32	25	01210.220.090
M10X100/S=17	100	01210.100.100	M14X120/S=22	50	01210.140.120	M22X100/S=32	10	01210.220.100
M10X110/S=17	50	01210.100.110						
M10X120/S=17	50	01210.100.120	M16X20	50	01210.160.020	M24X30	25	01210.240.030
M10X130/S=17	50	01210.100.130	M16X25	50	01210.160.025	M24X35	25	01210.240.035
M10X140/S=17	50	01210.100.140	M16X30	50	01210.160.030	M24X40	25	01210.240.040
M10X150/S=17	50	01210.100.150	M16X35	50	01210.160.035	M24X45	25	01210.240.045
M10X170/S=17	50	01210.100.170	M16X40	50	01210.160.040	M24X50	25	01210.240.050
			M16X45	50	01210.160.045	M24X55	25	01210.240.055
M12X12/S=19	100	01210.120.012	M16X50	50	01210.160.050	M24X60	25	01210.240.060
M12X16/S=19	100	01210.120.016	M16X55	50	01210.160.055	M24X65	25	01210.240.065
M12X20/S=19	100	01210.120.020	M16X60	50	01210.160.060	M24X70	25	01210.240.070
M12X20/S=18	100	01210.120.021	M16X65	25	01210.160.065	M24X75	25	01210.240.075
M12X22/S=19	100	01210.120.022	M16X70	25	01210.160.070	M24X80	25	01210.240.080
M12X25/S=19	100	01210.120.025	M16X75	25	01210.160.075	M24X90	10	01210.240.090
M12X25/S=18	100	01210.120.026	M16X80	25	01210.160.080	M24X100	10	01210.240.100
M12X30/S=19	100	01210.120.030	M16X90	25	01210.160.090	M24X110	10	01210.240.110
M12X30/S=18	100	01210.120.031	M16X100	25	01210.160.100	M24X120	10	01210.240.120
M12X35/S=19	100	01210.120.035	M16X110	25	01210.160.110	M24X130	10	01210.240.130
M12X35/S=18	100	01210.120.036	M16X120	25	01210.160.120	M24X140	10	01210.240.140
M12X40/S=19	100	01210.120.040	M16X130	25	01210.160.130	M24X150	10	01210.240.150
M12X40/S=18	100	01210.120.041	M16X140	25	01210.160.140	M24X160	10	01210.240.160
M12X45/S=19	100	01210.120.045	M16X150	25	01210.160.150	M24X180	10	01210.240.180
M12X45/S=18	100	01210.120.046	M16X160	25	01210.160.160	M24X200	10	01210.240.200
M12X50/S=19	100	01210.120.050	M16X180	25	01210.160.180			
M12X50/S=18	100	01210.120.051	M16X200	25	01210.160.200	M27X50	10	01210.270.050
M12X55/S=19	100	01210.120.055				M27X60	10	01210.270.060
M12X60/S=19	100	01210.120.060	M18X30	50	01210.180.030	M27X70	10	01210.270.070
M12X60/S=18	100	01210.120.061	M18X35	50	01210.180.035	M27X80	10	01210.270.080
M12X65/S=19	50	01210.120.065	M18X40	50	01210.180.040	M27X90	10	01210.270.090
M12X70/S=19	50	01210.120.070	M18X45	50	01210.180.045	M27X100	10	01210.270.100
M12X70/S=18	50	01210.120.071	M18X50	50	01210.180.050	M27X120	10	01210.270.120
M12X75/S=19	50	01210.120.075	M18X55	25	01210.180.055	M27X140	10	01210.270.140
M12X80/S=19	50	01210.120.080	M18X60	25	01210.180.060	M27X160	10	01210.270.160
M12X80/S=18	50	01210.120.081	M18X70	25	01210.180.070			
M12X85/S=19	50	01210.120.085	M18X80	25	01210.180.080	M30X40	10	01210.300.040
M12X90/S=19	50	01210.120.090	M18X90	25	01210.180.090	M30X50	10	01210.300.050
M12X100/S=19	50	01210.120.100	M18X100	25	01210.180.100	M30X60	10	01210.300.060
M12X110/S=19	50	01210.120.110				M30X65	10	01210.300.065
M12X120/S=19	50	01210.120.120	M20X30	25	01210.200.030	M30X70	10	01210.300.070
M12X130/S=19	50	01210.120.130	M20X35	25	01210.200.035	M30X75	10	01210.300.075
M12X140/S=19	50	01210.120.140	M20X40	25	01210.200.040	M30X80	10	01210.300.080
M12X150/S=19	50	01210.120.150	M20X45	25	01210.200.045	M30X90	10	01210.300.090
M12X160/S=19	25	01210.120.160	M20X50	25	01210.200.050	M30X100	10	01210.300.100
M12X180/S=19	25	01210.120.180	M20X55	25	01210.200.055	M30X110	10	01210.300.110
			M20X60	25	01210.200.060	M30X120	10	01210.300.120
M14X20/S=22	100	01210.140.020	M20X65	25	01210.200.065	M30X140	10	01210.300.140
M14X20/S=21	100	01210.140.021	M20X70	25	01210.200.070	M30X150	10	01210.300.150
M14X25/S=22	100	01210.140.025	M20X75	25	01210.200.075	M30X160	10	01210.300.160
M14X25/S=21	100	01210.140.026	M20X80	25	01210.200.080	M30X200	10	01210.300.200
M14X30/S=22	100	01210.140.030	M20X90	25	01210.200.090			
M14X35/S=22	100	01210.140.035	M20X100	25	01210.200.100	M33X60	5	01210.330.060
M14X35/S=21	100	01210.140.036	M20X110	25	01210.200.110	M33X70	5	01210.330.070
M14X40/S=22	100	01210.140.040	M20X120	25	01210.200.120	M33X80	5	01210.330.080
M14X40/S=21	100	01210.140.041	M20X130	25	01210.200.130	M33X90	5	01210.330.090
M14X45/S=22	50	01210.140.045	M20X140	25	01210.200.140	M33X100	5	01210.330.100
M14X45/S=21	50	01210.140.046	M20X150	10	01210.200.150			
M14X50/S=22	50	01210.140.050	M20X160	10	01210.200.160	M36X50	5	01210.360.050
M14X50/S=21	50	01210.140.051	M20X180	10	01210.200.180	M36X70	5	01210.360.070
M14X55/S=22	50	01210.140.055	M20X200	10	01210.200.200	M36X80	5	01210.360.080
M14X60/S=22	50	01210.140.060				M36X90	5	01210.360.090
M14X60/S=21	50	01210.140.061	M22X40/S=32	25	01210.220.040	M36X100	5	01210.360.100
M14X65/S=22	50	01210.140.065	M22X50/S=32	25	01210.220.050	M36X110	5	01210.360.110
M14X70/S=22	50	01210.140.070	M22X55/S=32	25	01210.220.055	M36X120	5	01210.360.120
M14X75/S=22	50	01210.140.075	M22X60/S=32	25	01210.220.060	M36X140	5	01210.360.140
M14X80/S=22	50	01210.140.080	M22X65/S=32	25	01210.220.065	M36X160	5	01210.360.160

01230 Hexagon head screw								A06A
Thread	Metric thread							
Material	Steel							
Class	8.8							
Surface treatment	Zinc plated yellow passivated							



d x L	☒	Art.number	d x L	☒	Art.number	d x L	☒	Art.number
M3X8	500	01230.030.008	M3X12	500	01230.030.012	M3X20	500	01230.030.020
M3X10	500	01230.030.010	M3X16	500	01230.030.016	M3X25	500	01230.030.025

01230 Hexagon head screw								
d x L	☒	Art.number	d x L	☒	Art.number	d x L	☒	Art.number
M3X30	500	01230.030.030	M8X100	100	01230.080.100	M16X70	25	01230.160.070
M4X6	500	01230.040.006	M8X110	100	01230.080.110	M16X80	25	01230.160.080
M4X8	500	01230.040.008	M8X120	100	01230.080.120	M16X90	25	01230.160.090
M4X10	500	01230.040.010	M10X12/S=17	200	01230.100.012	M16X100	25	01230.160.100
M4X12	500	01230.040.012	M10X16/S=17	200	01230.100.016	M16X110	25	01230.160.110
M4X16	500	01230.040.016	M10X20/S=17	200	01230.100.020	M16X120	25	01230.160.120
M4X20	500	01230.040.020	M10X25/S=17	200	01230.100.025	M16X130	25	01230.160.130
M4X25	500	01230.040.025	M10X30/S=17	200	01230.100.030	M16X140	25	01230.160.140
M4X30	500	01230.040.030	M10X35/S=17	100	01230.100.035	M16X150	25	01230.160.150
M4X35	200	01230.040.035	M10X40/S=17	100	01230.100.040	M16X160	25	01230.160.160
M4X40	200	01230.040.040	M10X45/S=17	100	01230.100.045	M16X180	25	01230.160.180
M4X50	200	01230.040.050	M10X50/S=17	100	01230.100.050	M16X200	25	01230.160.200
M4X60	200	01230.040.060	M10X55/S=17	100	01230.100.055	M18X40	50	01230.180.040
M5X8	500	01230.050.008	M10X60/S=17	100	01230.100.060	M18X45	50	01230.180.045
M5X10	500	01230.050.010	M10X65/S=17	100	01230.100.065	M18X50	50	01230.180.050
M5X12	500	01230.050.012	M10X70/S=17	100	01230.100.070	M20X30	25	01230.200.030
M5X16	500	01230.050.016	M10X75/S=17	100	01230.100.075	M20X35	25	01230.200.035
M5X20	500	01230.050.020	M10X80/S=17	100	01230.100.080	M20X40	25	01230.200.040
M5X22	500	01230.050.022	M10X90/S=17	100	01230.100.090	M20X45	25	01230.200.045
M5X25	500	01230.050.025	M10X100/S=17	100	01230.100.100	M20X50	25	01230.200.050
M5X30	500	01230.050.030	M10X110/S=17	50	01230.100.110	M20X55	25	01230.200.055
M5X35	200	01230.050.035	M10X120/S=17	50	01230.100.120	M20X60	25	01230.200.060
M5X40	200	01230.050.040	M10X130/S=17	50	01230.100.130	M20X65	25	01230.200.065
M5X45	200	01230.050.045	M10X140/S=17	50	01230.100.140	M20X70	25	01230.200.070
M5X50	200	01230.050.050	M10X150/S=17	50	01230.100.150	M20X75	25	01230.200.075
M5X60	200	01230.050.060	M12X16/S=19	100	01230.120.016	M20X80	25	01230.200.080
M6X8	500	01230.060.008	M12X20/S=19	100	01230.120.020	M20X85	25	01230.200.085
M6X10	500	01230.060.010	M12X25/S=19	100	01230.120.025	M20X90	25	01230.200.090
M6X12	500	01230.060.012	M12X30/S=19	100	01230.120.030	M20X100	25	01230.200.100
M6X14	500	01230.060.014	M12X35/S=19	100	01230.120.035	M20X110	25	01230.200.110
M6X16	500	01230.060.016	M12X40/S=19	100	01230.120.040	M20X120	25	01230.200.120
M6X20	500	01230.060.020	M12X45/S=19	100	01230.120.045	M20X130	25	01230.200.130
M6X25	500	01230.060.025	M12X50/S=19	100	01230.120.050	M20X140	25	01230.200.140
M6X30	500	01230.060.030	M12X55/S=19	100	01230.120.055	M20X150	25	01230.200.150
M6X35	200	01230.060.035	M12X60/S=19	100	01230.120.060	M20X160	10	01230.200.160
M6X40	200	01230.060.040	M12X65/S=19	100	01230.120.065	M20X180	10	01230.200.180
M6X45	200	01230.060.045	M12X70/S=19	50	01230.120.070	M20X200	10	01230.200.200
M6X50	200	01230.060.050	M12X75/S=19	50	01230.120.075	M24X40	25	01230.240.040
M6X60	200	01230.060.060	M12X80/S=19	50	01230.120.080	M24X45	25	01230.240.045
M6X70	200	01230.060.070	M12X90/S=19	50	01230.120.090	M24X50	25	01230.240.050
M6X80	200	01230.060.080	M12X100/S=19	50	01230.120.100	M24X55	25	01230.240.055
M6X100	200	01230.060.100	M12X110/S=19	50	01230.120.110	M24X60	25	01230.240.060
M7X10	200	01230.070.010	M12X120/S=19	50	01230.120.120	M24X65	25	01230.240.065
M7X12	200	01230.070.012	M12X130/S=19	50	01230.120.130	M24X70	25	01230.240.070
M7X16	200	01230.070.016	M12X140/S=19	50	01230.120.140	M24X75	25	01230.240.075
M7X20	200	01230.070.020	M12X150/S=19	50	01230.120.150	M24X80	25	01230.240.080
M7X25	200	01230.070.025	M14X20/S=22	100	01230.140.020	M24X85	25	01230.240.085
M7X30	200	01230.070.030	M14X25/S=22	100	01230.140.025	M24X90	25	01230.240.090
M7X35	200	01230.070.035	M14X30/S=22	100	01230.140.030	M24X100	10	01230.240.100
M7X40	200	01230.070.040	M14X35/S=22	100	01230.140.035	M24X110	10	01230.240.110
M7X45	200	01230.070.045	M14X40/S=22	100	01230.140.040	M24X120	10	01230.240.120
M7X50	200	01230.070.050	M14X45/S=22	50	01230.140.045	M24X130	10	01230.240.130
M8X10	200	01230.080.010	M14X50/S=22	50	01230.140.050	M24X140	10	01230.240.140
M8X12	200	01230.080.012	M14X60/S=22	50	01230.140.060	M24X150	10	01230.240.150
M8X16	200	01230.080.016	M14X70/S=22	50	01230.140.070	M24X160	10	01230.240.160
M8X20	200	01230.080.020	M14X75/S=22	50	01230.140.075	M24X180	10	01230.240.180
M8X25	200	01230.080.025	M14X80/S=22	50	01230.140.080	M24X200	10	01230.240.200
M8X30	200	01230.080.030	M14X90/S=22	50	01230.140.090	M27X50	10	01230.270.050
M8X35	200	01230.080.035	M14X100/S=22	50	01230.140.100	M27X60	10	01230.270.060
M8X40	200	01230.080.040	M16X20	50	01230.160.020	M27X70	10	01230.270.070
M8X45	200	01230.080.045	M16X25	50	01230.160.025	M27X80	10	01230.270.080
M8X50	200	01230.080.050	M16X30	50	01230.160.030	M27X90	10	01230.270.090
M8X55	200	01230.080.055	M16X35	50	01230.160.035	M27X100	10	01230.270.100
M8X60	200	01230.080.060	M16X40	50	01230.160.040	M27X120	10	01230.270.120
M8X70	200	01230.080.070	M16X45	50	01230.160.045	M30X60	10	01230.300.060
M8X75	200	01230.080.075	M16X50	50	01230.160.050	M33X80	5	01230.330.080
M8X80	200	01230.080.080	M16X55	50	01230.160.055	M33X90	5	01230.330.090
M8X90	100	01230.080.090	M16X60	50	01230.160.060	M33X100	5	01230.330.100
M8X90	100	01230.080.090	M16X65	50	01230.160.065	M36X80	5	01230.360.080
						M36X90	5	01230.360.090
						M36X100	5	01230.360.100

01236 Hexagon head screw		A96A
Thread	Metric thread	 
Material	Steel	
Class	8.8	
Surface treatment	Zinc flake Cr ⁶⁺ free - ISO 10683 flZnnc	

d x L	☒	Art.number	d x L	☒	Art.number	d x L	☒	Art.number
M4X10	500	01236.040.010	M8X40	200	01236.080.040	M14X65/S=22	50	01236.140.065
M4X12	500	01236.040.012	M8X45	200	01236.080.045	M14X70/S=22	50	01236.140.070
M4X16	500	01236.040.016	M8X50	200	01236.080.050			
M4X20	500	01236.040.020	M8X60	200	01236.080.060	M16X20	50	01236.160.020
M4X25	500	01236.040.025	M8X70	200	01236.080.070	M16X25	50	01236.160.025
M4X30	500	01236.040.030	M8X80	200	01236.080.080	M16X30	50	01236.160.030
						M16X35	50	01236.160.035
M5X10	500	01236.050.010	M10X16/S=17	200	01236.100.016	M16X40	50	01236.160.040
M5X12	500	01236.050.012	M10X20/S=17	200	01236.100.020	M16X45	50	01236.160.045
M5X16	500	01236.050.016	M10X25/S=17	200	01236.100.025	M16X50	50	01236.160.050
M5X20	500	01236.050.020	M10X30/S=17	200	01236.100.030	M16X60	50	01236.160.060
M5X25	500	01236.050.025	M10X35/S=17	100	01236.100.035	M16X65	25	01236.160.065
M5X30	500	01236.050.030	M10X40/S=17	100	01236.100.040	M16X70	25	01236.160.070
M5X35	200	01236.050.035	M10X45/S=17	100	01236.100.045	M16X80	25	01236.160.080
M5X40	200	01236.050.040	M10X50/S=17	100	01236.100.050	M16X100	25	01236.160.100
M5X45	200	01236.050.045	M10X55/S=17	100	01236.100.055	M16X110	25	01236.160.110
M5X50	200	01236.050.050	M10X60/S=17	100	01236.100.060			
			M10X70/S=17	100	01236.100.070	M18X45	25	01236.180.045
M6X10	500	01236.060.010	M10X80/S=17	100	01236.100.080	M18X50	50	01236.180.050
M6X12	500	01236.060.012	M10X90/S=17	100	01236.100.090	M18X55	25	01236.180.055
M6X16	500	01236.060.016				M18X60	25	01236.180.060
M6X20	500	01236.060.020	M12X20/S=19	100	01236.120.020	M18X65	25	01236.180.065
M6X25	500	01236.060.025	M12X25/S=19	100	01236.120.025			
M6X30	500	01236.060.030	M12X30/S=19	100	01236.120.030	M20X40	25	01236.200.040
M6X35	200	01236.060.035	M12X35/S=19	100	01236.120.035	M20X45	25	01236.200.045
M6X40	200	01236.060.040	M12X40/S=19	100	01236.120.040	M20X50	25	01236.200.050
M6X50	200	01236.060.050	M12X45/S=19	100	01236.120.045	M20X55	25	01236.200.055
M6X60	200	01236.060.060	M12X50/S=19	100	01236.120.050	M20X60	25	01236.200.060
M6X70	200	01236.060.070	M12X60/S=19	100	01236.120.060	M20X65	25	01236.200.065
			M12X70/S=19	50	01236.120.070	M20X70	25	01236.200.070
M8X10	200	01236.080.010	M12X80/S=19	50	01236.120.080	M20X80	25	01236.200.080
M8X12	200	01236.080.012				M20X90	25	01236.200.090
M8X16	200	01236.080.016	M14X30/S=22	100	01236.140.030			
M8X20	200	01236.080.020	M14X35/S=22	100	01236.140.035	M24X50	25	01236.240.050
M8X25	200	01236.080.025	M14X40/S=22	100	01236.140.040	M24X60	25	01236.240.060
M8X30	200	01236.080.030	M14X45/S=22	50	01236.140.045	M24X70	25	01236.240.070
M8X35	200	01236.080.035	M14X60/S=22	50	01236.140.060	M24X80	25	01236.240.080

• A ISO 10683 Zinc Flake surface coating eliminates the possibilities of damage which can arise due to hydrogen embrittlement.

01410 Hexagon head screw ISO-Metric fitting thread		A08A
Thread	Metric thread	 
Material	Steel	
Class	8.8	
Surface treatment	Hot dip galvanized	

d x L	☒	Art.number	d x L	☒	Art.number	d x L	☒	Art.number
M6X16	100	01410.060.016	M10X50/S=17	100	01410.100.050	M16X45	50	01410.160.045
M6X20	100	01410.060.020	M10X60/S=17	100	01410.100.060	M16X50	50	01410.160.050
M6X25	100	01410.060.025	M10X70/S=17	100	01410.100.070	M16X55	50	01410.160.055
M6X30	500	01410.060.030	M10X80/S=17	100	01410.100.080	M16X60	50	01410.160.060
M6X40	200	01410.060.040	M10X100/S=17	100	01410.100.100	M16X65	50	01410.160.065
						M16X70	50	01410.160.070
M8X12	100	01410.080.012	M12X20/S=19	100	01410.120.020	M16X80	50	01410.160.080
M8X16	100	01410.080.016	M12X25/S=19	100	01410.120.025	M16X90	25	01410.160.090
M8X20	100	01410.080.020	M12X30/S=19	100	01410.120.030	M16X100	25	01410.160.100
M8X25	100	01410.080.025	M12X35/S=19	100	01410.120.035	M16X110	25	01410.160.110
M8X30	100	01410.080.030	M12X40/S=19	100	01410.120.040	M16X120	25	01410.160.120
M8X35	100	01410.080.035	M12X45/S=19	100	01410.120.045			
M8X40	100	01410.080.040	M12X50/S=19	100	01410.120.050	M18X40	25	01410.180.040
M8X45	100	01410.080.045	M12X55/S=19	100	01410.120.055	M18X45	25	01410.180.045
M8X50	100	01410.080.050	M12X60/S=19	100	01410.120.060	M18X50	25	01410.180.050
M8X60	100	01410.080.060	M12X70/S=19	50	01410.120.070	M18X55	25	01410.180.055
M8X80	100	01410.080.080	M12X80/S=19	50	01410.120.080			
			M12X90/S=19	50	01410.120.090	M20X30	25	01410.200.030
M10X16/S=17	100	01410.100.016	M12X100/S=19	50	01410.120.100	M20X35	25	01410.200.035
M10X20/S=17	100	01410.100.020	M12X120/S=19	50	01410.120.120	M20X40	25	01410.200.040
M10X25/S=17	100	01410.100.025				M20X45	25	01410.200.045
M10X30/S=17	100	01410.100.030	M16X25	50	01410.160.025	M20X50	25	01410.200.050
M10X35/S=17	100	01410.100.035	M16X30	50	01410.160.030	M20X55	25	01410.200.055
M10X40/S=17	100	01410.100.040	M16X35	50	01410.160.035	M20X60	25	01410.200.060
M10X45/S=17	100	01410.100.045	M16X40	50	01410.160.040	M20X65	25	01410.200.065

01410 Hexagon head screw ISO-Metric fitting thread								
d x L	☒	Art.number	d x L	☒	Art.number	d x L	☒	Art.number
M20X70	25	01410.200.070	M24X70	25	01410.240.070	M30X70	10	01410.300.070
M20X80	25	01410.200.080	M24X80	25	01410.240.080	M30X80	10	01410.300.080
M20X90	25	01410.200.090	M24X90	10	01410.240.090	M30X90	10	01410.300.090
M20X100	25	01410.200.100	M24X100	10	01410.240.100	M30X100	10	01410.300.100
M20X120	25	01410.200.120	M24X110	10	01410.240.110	M30X120	10	01410.300.120
			M24X180	5	01410.240.180			
M22X50/S=34	25	01410.220.051				M33X80	5	01410.330.080
M22X60/S=34	25	01410.220.061	M27X50	10	01410.270.050	M33X90	5	01410.330.090
M22X65/S=34	25	01410.220.066	M27X60	10	01410.270.060	M33X100	5	01410.330.100
			M27X65	10	01410.270.065			
M24X40	25	01410.240.040	M27X70	10	01410.270.070	M36X80	5	01410.360.080
M24X45	25	01410.240.045	M27X80	10	01410.270.080	M36X90	5	01410.360.090
M24X50	25	01410.240.050	M27X90	10	01410.270.090	M36X100	5	01410.360.100
M24X55	25	01410.240.055	M27X100	10	01410.270.100	M36X130	5	01410.360.130
M24X60	25	01410.240.060						
M24X65	25	01410.240.065	M30X60	10	01410.300.060			

- For hot dip galvanized bolts with ISO-METRIC FITTING thread, the thread is rolled undersize so that it will meet the go-gauge with tolerance class h AFTER galvanizing.
- The advantage of this way of manufacturing is that the bolts can be used in any threaded hole without any problem.
- The corresponding ISO-METRIC FITTING nuts have been threaded according to the tolerance class 6H AFTER galvanizing so that they perfectly fit onto the bolts.

01430 Hexagon head screw oversized thread		A08A
Thread	Metric thread	
Material	Steel	
Class	8.8	
Surface treatment	Hot dip galvanized	
		

d x L	☒	Art.number	d x L	☒	Art.number	d x L	☒	Art.number
M8X25	200	01430.080.025	M16X45	50	01430.160.045	M22X50/S=32	25	01430.220.050
M10X20/S=17	100	01430.100.020	M16X50	50	01430.160.050	M22X60/S=32	25	01430.220.060
M10X25/S=17	100	01430.100.025	M16X55	50	01430.160.055	M22X70/S=32	25	01430.220.070
M10X30/S=17	100	01430.100.030	M16X60	50	01430.160.060	M22X80/S=32	25	01430.220.080
M10X35/S=17	100	01430.100.035	M16X65	25	01430.160.065			
M10X40/S=17	100	01430.100.040	M16X70	25	01430.160.070	M24X40	25	01430.240.040
M10X50/S=17	100	01430.100.050	M16X80	25	01430.160.080	M24X50	25	01430.240.050
M10X60/S=17	100	01430.100.060	M16X90	25	01430.160.090	M24X55	25	01430.240.055
			M16X100	25	01430.160.100	M24X60	25	01430.240.060
M12X20/S=19	100	01430.120.020	M16X110	25	01430.160.110	M24X65	25	01430.240.065
M12X25/S=19	100	01430.120.025	M16X120	25	01430.160.120	M24X70	25	01430.240.070
M12X30/S=19	100	01430.120.030				M24X75	25	01430.240.075
M12X35/S=19	100	01430.120.035	M18X30	50	01430.180.030	M24X80	25	01430.240.080
M12X40/S=19	100	01430.120.040	M18X40	50	01430.180.040	M24X80	25	01430.240.080
M12X45/S=19	100	01430.120.045	M18X50	25	01430.180.050	M24X90	10	01430.240.090
M12X50/S=19	100	01430.120.050	M18X60	25	01430.180.060	M24X100	10	01430.240.100
M12X55/S=19	100	01430.120.055	M18X70	25	01430.180.070			
M12X60/S=19	100	01430.120.060	M18X80	25	01430.180.080	M27X60	10	01430.270.060
M12X70/S=19	50	01430.120.070	M18X100	25	01430.180.100	M27X65	10	01430.270.065
M12X80/S=19	50	01430.120.080				M27X70	10	01430.270.070
M12X100/S=19	50	01430.120.100	M20X35	25	01430.200.035	M27X75	10	01430.270.075
M12X120/S=19	50	01430.120.120	M20X40	25	01430.200.040	M27X80	10	01430.270.080
			M20X45	25	01430.200.045			
M14X30/S=22	100	01430.140.030	M20X50	25	01430.200.050	M30X60	10	01430.300.060
M14X35/S=22	100	01430.140.035	M20X55	25	01430.200.055	M30X70	10	01430.300.070
M14X40/S=22	100	01430.140.040	M20X60	25	01430.200.060	M30X80	10	01430.300.080
M14X50/S=22	50	01430.140.050	M20X65	25	01430.200.065	M30X90	10	01430.300.090
M14X60/S=22	50	01430.140.060	M20X70	25	01430.200.070	M30X100	10	01430.300.100
			M20X75	25	01430.200.075	M30X110	10	01430.300.110
M16X25	50	01430.160.025	M20X80	25	01430.200.080	M30X120	10	01430.300.120
M16X30	50	01430.160.030	M20X90	25	01430.200.090			
M16X35	50	01430.160.035	M20X100	25	01430.200.100	M36X80	5	01430.360.080
M16X40	50	01430.160.040	M20X110	25	01430.200.110	M36X90	5	01430.360.090
			M20X130	25	01430.200.130			

- For hot dip galvanized bolts with OVERSIZED thread the zinc layer is applied ON the normal thread, so AFTER galvanizing these bolts are no longer ISO-metric mating, but thicker: so called OVERSIZED.
- They cannot be used in normal threaded holes.
- The corresponding OVERSIZED nuts have been Oversize tapped according to ISO 965-5 AFTER galvanizing running perfectly onto these bolts.

04110 Hexagon head screw		C01A	
Thread	Metric thread		
Material	Steel		
Class	10.9		

d x L	☒	Art.number	d x L	☒	Art.number	d x L	☒	Art.number
M6X10	200	04110.060.010	M12X40/S=19	100	04110.120.040	M20X30	25	04110.200.030
M6X12	200	04110.060.012	M12X45/S=19	100	04110.120.045	M20X35	25	04110.200.035
M6X16	200	04110.060.016	M12X50/S=19	100	04110.120.050	M20X40	25	04110.200.040
M6X20	200	04110.060.020	M12X55/S=19	100	04110.120.055	M20X45	25	04110.200.045
M6X25	200	04110.060.025	M12X60/S=19	100	04110.120.060	M20X50	25	04110.200.050
M6X30	200	04110.060.030	M12X70/S=19	100	04110.120.070	M20X55	25	04110.200.055
M6X35	200	04110.060.035	M12X75/S=19	100	04110.120.075	M20X60	25	04110.200.060
M6X40	200	04110.060.040	M12X80/S=19	100	04110.120.080	M20X70	25	04110.200.070
M6X45	200	04110.060.045	M12X90/S=19	50	04110.120.090	M20X80	25	04110.200.080
M6X50	200	04110.060.050	M12X100/S=19	50	04110.120.100	M20X90	25	04110.200.090
M6X60	200	04110.060.060	M12X120/S=19	50	04110.120.120	M20X100	25	04110.200.100
M6X70	200	04110.060.070				M20X120	25	04110.200.120
M8X10	200	04110.080.010	M14X30/S=22	100	04110.140.030	M22X50/S=32	25	04110.220.050
M8X12	200	04110.080.012	M14X35/S=22	100	04110.140.035	M22X60/S=32	25	04110.220.060
M8X16	200	04110.080.016	M14X40/S=22	100	04110.140.040	M22X70/S=32	25	04110.220.070
M8X20	200	04110.080.020	M14X45/S=22	50	04110.140.045	M22X80/S=32	25	04110.220.080
M8X25	200	04110.080.025	M14X50/S=22	50	04110.140.050			
M8X30	200	04110.080.030	M14X55/S=22	50	04110.140.055	M24X40	25	04110.240.040
M8X35	200	04110.080.035	M14X60/S=22	50	04110.140.060	M24X45	25	04110.240.045
M8X40	200	04110.080.040	M14X70/S=22	50	04110.140.070	M24X50	25	04110.240.050
M8X50	200	04110.080.050	M14X80/S=22	50	04110.140.080	M24X55	25	04110.240.055
M8X60	200	04110.080.060	M14X90/S=22	50	04110.140.090	M24X60	25	04110.240.060
M8X70	200	04110.080.070	M14X100/S=22	50	04110.140.100	M24X65	25	04110.240.065
M8X80	200	04110.080.080	M16X25	50	04110.160.025	M24X70	25	04110.240.070
M8X110	200	04110.080.110	M16X30	50	04110.160.030	M24X80	25	04110.240.080
M10X16/S=17	200	04110.100.016	M16X35	50	04110.160.035	M24X90	10	04110.240.090
M10X20/S=17	200	04110.100.020	M16X40	50	04110.160.040	M24X100	10	04110.240.100
M10X25/S=17	200	04110.100.025	M16X45	50	04110.160.045	M24X120	10	04110.240.120
M10X30/S=17	200	04110.100.030	M16X50	50	04110.160.050			
M10X35/S=17	100	04110.100.035	M16X55	50	04110.160.055	M27X60	10	04110.270.060
M10X40/S=17	100	04110.100.040	M16X60	25	04110.160.060	M27X70	10	04110.270.070
M10X45/S=17	100	04110.100.045	M16X65	25	04110.160.065	M27X80	10	04110.270.080
M10X50/S=17	100	04110.100.050	M16X70	25	04110.160.070			
M10X55/S=17	100	04110.100.055	M16X80	25	04110.160.080	M30X60	10	04110.300.060
M10X60/S=17	100	04110.100.060	M16X90	25	04110.160.090	M30X70	10	04110.300.070
M10X70/S=17	100	04110.100.070	M16X100	25	04110.160.100	M30X80	10	04110.300.080
M10X80/S=17	100	04110.100.080	M16X120	25	04110.160.120	M30X90	10	04110.300.090
M10X90/S=17	100	04110.100.090	M16X140	100	04110.160.140	M30X100	10	04110.300.100
M10X100/S=17	100	04110.100.100				M30X110	10	04110.300.110
M12X16/S=19	100	04110.120.016	M18X30	50	04110.180.030	M36X70	5	04110.360.070
M12X20/S=19	100	04110.120.020	M18X35	50	04110.180.035	M36X80	5	04110.360.080
M12X25/S=19	100	04110.120.025	M18X40	50	04110.180.040	M36X90	5	04110.360.090
M12X30/S=19	100	04110.120.030	M18X45	50	04110.180.045	M36X100	5	04110.360.100
M12X35/S=19	100	04110.120.035	M18X50	50	04110.180.050	M36X110	5	04110.360.110



• Warning: electro-galvanizing of these products may cause hydrogen embrittlement.

04116 Hexagon head screw		C02C	
Thread	Metric thread		
Material	Steel		
Class	10.9		
Surface treatment	Zinc flake Cr ⁶⁺ free - ISO 10683 flZnnc		

d x L	☒	Art.number	d x L	☒	Art.number	d x L	☒	Art.number
M6X10	200	04116.060.010	M10X25/S=17	200	04116.100.025	M14X40/S=22	100	04116.140.040
M6X12	200	04116.060.012	M10X30/S=17	200	04116.100.030	M14X45/S=22	50	04116.140.045
M6X16	200	04116.060.016	M10X35/S=17	100	04116.100.035	M14X50/S=22	50	04116.140.050
M6X20	200	04116.060.020	M10X60/S=17	100	04116.100.060			
M6X25	200	04116.060.025				M16X30	50	04116.160.030
M6X30	200	04116.060.030	M12X20/S=19	100	04116.120.020	M16X35	50	04116.160.035
M8X16	200	04116.080.016	M12X25/S=19	100	04116.120.025	M16X40	50	04116.160.040
M8X20	200	04116.080.020	M12X30/S=19	100	04116.120.030	M16X45	50	04116.160.045
M8X25	200	04116.080.025	M12X35/S=19	100	04116.120.035	M16X50	50	04116.160.050
M8X30	200	04116.080.030	M12X40/S=19	100	04116.120.040	M16X60	25	04116.160.060
M10X16/S=17	200	04116.100.016	M12X45/S=19	100	04116.120.045			
M10X20/S=17	200	04116.100.020	M12X50/S=19	100	04116.120.050	M20X40	25	04116.200.040
			M12X60/S=19	100	04116.120.060	M20X45	25	04116.200.045
						M20X50	25	04116.200.050

04116 Hexagon head screw								
d x L	☒	Art.number	d x L	☒	Art.number	d x L	☒	Art.number
M20X60	25	04116.200.060				M24X60	25	04116.240.060
M20X70	25	04116.200.070	M24X50	25	04116.240.050	M24X70	25	04116.240.070

- A ISO 10683 Zinc Flake surface coating eliminates the possibilities of damage which can arise due to hydrogen embrittlement.

04118 Hexagon head screw		C01A
Thread	Metric thread	 
Material	Steel	
Class	12.9	

d x L	☒	Art.number	d x L	☒	Art.number	d x L	☒	Art.number
M8X20	200	04118.080.020	M16X30	50	04118.160.030	M20X90	25	04118.200.090
M8X25	200	04118.080.025	M16X35	50	04118.160.035	M20X100	25	04118.200.100
M8X30	200	04118.080.030	M16X40	50	04118.160.040	M24X50	25	04118.240.050
M10X20/S=17	200	04118.100.020	M16X45	50	04118.160.045	M24X60	25	04118.240.060
M10X25/S=17	200	04118.100.025	M16X50	50	04118.160.050	M24X70	25	04118.240.070
M10X30/S=17	200	04118.100.030	M16X60	50	04118.160.060	M24X80	25	04118.240.080
M10X35/S=17	100	04118.100.035	M16X70	25	04118.160.070	M24X90	10	04118.240.090
M10X40/S=17	100	04118.100.040	M16X80	25	04118.160.080	M24X100	10	04118.240.100
M12X25/S=19	100	04118.120.025	M20X40	25	04118.200.040	M30X60	10	04118.300.060
M12X30/S=19	100	04118.120.030	M20X50	25	04118.200.050	M30X70	10	04118.300.070
M12X35/S=19	100	04118.120.035	M20X60	25	04118.200.060	M30X80	10	04118.300.080
M12X40/S=19	100	04118.120.040	M20X70	25	04118.200.070	M30X90	10	04118.300.090
M12X45/S=19	100	04118.120.045	M20X80	25	04118.200.080	M30X100	10	04118.300.100

- Warning: electro-galvanizing of these products may cause hydrogen embrittlement.

08760 Hexagon head screw for pressure vessels etc.		E11A
Thread	Metric thread	 
Material	Steel	
Class	5.6	

d x L	☒	Art.number	d x L	☒	Art.number	d x L	☒	Art.number
M10X25/S=16	200	08760.100.026	M16X35	50	08760.160.035	M20X65	25	08760.200.065
			M16X45	50	08760.160.045	M20X70	25	08760.200.070
M12X25/S=18	100	08760.120.026	M16X50	50	08760.160.050			
M12X30/S=18	100	08760.120.031	M16X55	50	08760.160.055	M24X55	25	08760.240.055
M12X35/S=18	100	08760.120.036	M16X60	50	08760.160.060	M24X70	25	08760.240.070
M12X40/S=18	100	08760.120.041				M24X80	25	08760.240.080
M12X45/S=18	100	08760.120.046	M20X50	25	08760.200.050			
			M20X60	25	08760.200.060	M27X65	10	08760.270.065

- Special features hexagon head screws for pressure vessels etc.:
- Are intended for use in pressure vessels, steam apparatus, equipment and flanged joints at temperatures from -10°C up to +300°C, overpressures max. 40 bar and sizes up to and including M30.
- Meets the requirements of AD-Merkblatt W7, TRD 106 of the TÜV (Technischer Überwachungsverein) and DIN 267-13.
- According to TÜV-Merkblatt Werkstoffe 1253, the manufacturer has been certified to deliver these screws without a 3.1 certificate, the trademark and class designation are sufficient.
- This certification is also accepted by "Lloyd's Register Energy".

51010 Hexagon head screw		Q01A
Thread	Metric thread	 
Material	Stainless steel A2	
Class	70	

d x L	☒	Art.number	d x L	☒	Art.number	d x L	☒	Art.number
M2X3*	1000	51010.020.003	M2,5X5*	1000	51010.025.005	M3X5*	1000	51010.030.005
M2X4*	1000	51010.020.004	M2,5X6*	1000	51010.025.006	M3X6	200	51010.030.006
M2X5*	1000	51010.020.005	M2,5X8*	1000	51010.025.008	M3X8	200	51010.030.008
M2X6*	1000	51010.020.006	M2,5X10*	1000	51010.025.010	M3X10	200	51010.030.010
M2X8*	1000	51010.020.008	M2,5X12*	1000	51010.025.012	M3X12	200	51010.030.012
M2X10*	1000	51010.020.010	M2,5X14*	1000	51010.025.014	M3X14	1000	51010.030.014
M2X12*	1000	51010.020.012	M2,5X16*	1000	51010.025.016	M3X16	200	51010.030.016
M2X14*	1000	51010.020.014	M2,5X18*	1000	51010.025.018	M3X18*	1000	51010.030.018
M2X16*	1000	51010.020.016	M2,5X20*	1000	51010.025.020	M3X20	200	51010.030.020
M2X20*	1000	51010.020.020				M3X22*	1000	51010.030.022
			M3X4*	1000	51010.030.004	M3X25	200	51010.030.025

51010 Hexagon head screw								
d x L	☒	Art.number	d x L	☒	Art.number	d x L	☒	Art.number
M3X30	200	51010.030.030	M6X120*	50	51010.060.120	M12X40/S=19	50	51010.120.040
M3X35*	500	51010.030.035	M6X130*	50	51010.060.130	M12X45/S=19	50	51010.120.045
M3X40	200	51010.030.040	M6X140*	50	51010.060.140	M12X50/S=19	50	51010.120.050
M3X45*	500	51010.030.045	M6X150	50	51010.060.150	M12X55/S=19	50	51010.120.055
M3X50	200	51010.030.050				M12X60/S=19	50	51010.120.060
			M8X8*	500	51010.080.008	M12X65/S=19	50	51010.120.065
M4X4*	1000	51010.040.004	M8X10	200	51010.080.010	M12X70/S=19	50	51010.120.070
M4X5*	1000	51010.040.005	M8X12	200	51010.080.012	M12X75/S=19	25	51010.120.075
M4X6	200	51010.040.006	M8X14	200	51010.080.014	M12X80/S=19	50	51010.120.080
M4X8	200	51010.040.008	M8X16	200	51010.080.016	M12X85/S=19	25	51010.120.085
M4X10	200	51010.040.010	M8X18	200	51010.080.018	M12X90/S=19	25	51010.120.090
M4X12	200	51010.040.012	M8X20	200	51010.080.020	M12X95/S=19*	25	51010.120.095
M4X14	1000	51010.040.014	M8X22	200	51010.080.022	M12X100/S=19	25	51010.120.100
M4X16	200	51010.040.016	M8X25	200	51010.080.025	M12X110/S=19	25	51010.120.110
M4X18*	1000	51010.040.018	M8X30	200	51010.080.030	M12X120/S=19	25	51010.120.120
M4X20	200	51010.040.020	M8X35	200	51010.080.035	M12X130/S=19	25	51010.120.130
M4X22*	500	51010.040.022	M8X40	100	51010.080.040	M12X140/S=19	25	51010.120.140
M4X25	200	51010.040.025	M8X45	100	51010.080.045	M12X150/S=19	10	51010.120.150
M4X30	200	51010.040.030	M8X50	100	51010.080.050	M12X160/S=19	10	51010.120.160
M4X35	200	51010.040.035	M8X55	100	51010.080.055	M12X170/S=19*	10	51010.120.170
M4X40	200	51010.040.040	M8X60	100	51010.080.060	M12X180/S=19	10	51010.120.180
M4X45	200	51010.040.045	M8X65	100	51010.080.065	M12X190/S=19*	10	51010.120.190
M4X50	200	51010.040.050	M8X70	50	51010.080.070	M12X200/S=19	10	51010.120.200
M4X55*	200	51010.040.055	M8X75	50	51010.080.075	M12X250/S=19	10	51010.120.250
M4X60	200	51010.040.060	M8X80	50	51010.080.080			
M4X65*	100	51010.040.065	M8X85	50	51010.080.085	M14X20/S=22*	50	51010.140.020
M4X70*	100	51010.040.070	M8X90	50	51010.080.090	M14X25/S=22	50	51010.140.025
M4X75*	100	51010.040.075	M8X95	50	51010.080.095	M14X30/S=22	50	51010.140.030
M4X80*	100	51010.040.080	M8X100	50	51010.080.100	M14X35/S=22	50	51010.140.035
			M8X110	25	51010.080.110	M14X40/S=22	50	51010.140.040
M5X5*	500	51010.050.005	M8X120	25	51010.080.120	M14X45/S=22	50	51010.140.045
M5X6	200	51010.050.006	M8X130*	50	51010.080.130	M14X50/S=22	50	51010.140.050
M5X8	200	51010.050.008	M8X140	50	51010.080.140	M14X55/S=22	50	51010.140.055
M5X10	200	51010.050.010	M8X150	50	51010.080.150	M14X60/S=22	50	51010.140.060
M5X12	200	51010.050.012	M8X160*	25	51010.080.160	M14X65/S=22	50	51010.140.065
M5X14	500	51010.050.014	M8X170*	25	51010.080.170	M14X70/S=22	50	51010.140.070
M5X16	200	51010.050.016	M8X180*	25	51010.080.180	M14X75/S=22*	50	51010.140.075
M5X18	200	51010.050.018	M8X190*	25	51010.080.190	M14X80/S=22	25	51010.140.080
M5X20	200	51010.050.020	M8X200*	25	51010.080.200	M14X85/S=22*	50	51010.140.085
M5X22*	500	51010.050.022				M14X90/S=22	50	51010.140.090
M5X25	200	51010.050.025	M10X10/S=17	100	51010.100.010	M14X100/S=22	10	51010.140.100
M5X30	200	51010.050.030	M10X12/S=17	100	51010.100.012	M14X110/S=22*	25	51010.140.110
M5X35	200	51010.050.035	M10X14/S=17	100	51010.100.014	M14X120/S=22*	25	51010.140.120
M5X40	200	51010.050.040	M10X16/S=17	100	51010.100.016	M14X130/S=22*	25	51010.140.130
M5X45	200	51010.050.045	M10X18/S=17*	100	51010.100.018	M14X140/S=22*	25	51010.140.140
M5X50	200	51010.050.050	M10X20/S=17	100	51010.100.020	M14X150/S=22*	25	51010.140.150
M5X55	200	51010.050.055	M10X22/S=17*	100	51010.100.022			
M5X60	200	51010.050.060	M10X25/S=17	100	51010.100.025	M16X16*	25	51010.160.016
M5X65*	200	51010.050.065	M10X30/S=17	100	51010.100.030	M16X20	25	51010.160.020
M5X70	200	51010.050.070	M10X35/S=17	100	51010.100.035	M16X25	50	51010.160.025
M5X75*	100	51010.050.075	M10X40/S=17	100	51010.100.040	M16X30	50	51010.160.030
M5X80	100	51010.050.080	M10X45/S=17	100	51010.100.045	M16X35	50	51010.160.035
M5X85*	100	51010.050.085	M10X50/S=17	100	51010.100.050	M16X40	50	51010.160.040
M5X90*	100	51010.050.090	M10X55/S=17	50	51010.100.055	M16X45	50	51010.160.045
M5X100*	100	51010.050.100	M10X60/S=17	50	51010.100.060	M16X50	50	51010.160.050
			M10X65/S=17	50	51010.100.065	M16X55	25	51010.160.055
M6X6	500	51010.060.006	M10X70/S=17	50	51010.100.070	M16X60	25	51010.160.060
M6X8	200	51010.060.008	M10X75/S=17	50	51010.100.075	M16X65	25	51010.160.065
M6X10	200	51010.060.010	M10X80/S=17	50	51010.100.080	M16X70	25	51010.160.070
M6X12	200	51010.060.012	M10X85/S=17	50	51010.100.085	M16X75	25	51010.160.075
M6X14	200	51010.060.014	M10X90/S=17	25	51010.100.090	M16X80	25	51010.160.080
M6X16	200	51010.060.016	M10X95/S=17*	50	51010.100.095	M16X85	25	51010.160.085
M6X18	200	51010.060.018	M10X100/S=17	25	51010.100.100	M16X90	10	51010.160.090
M6X20	200	51010.060.020	M10X110/S=17	25	51010.100.110	M16X95*	25	51010.160.095
M6X22	200	51010.060.022	M10X120/S=17	25	51010.100.120	M16X100	10	51010.160.100
M6X25	200	51010.060.025	M10X130/S=17	25	51010.100.130	M16X110	10	51010.160.110
M6X30	200	51010.060.030	M10X135/S=17*	50	51010.100.135	M16X120	10	51010.160.120
M6X35	200	51010.060.035	M10X140/S=17	25	51010.100.140	M16X130	25	51010.160.130
M6X40	200	51010.060.040	M10X150/S=17	10	51010.100.150	M16X140	25	51010.160.140
M6X45	100	51010.060.045	M10X160/S=17	10	51010.100.160	M16X150	25	51010.160.150
M6X50	100	51010.060.050	M10X170/S=17	25	51010.100.170	M16X160	25	51010.160.160
M6X55	100	51010.060.055	M10X180/S=17	25	51010.100.180	M16X170*	25	51010.160.170
M6X60	100	51010.060.060	M10X190/S=17*	25	51010.100.190	M16X180*	10	51010.160.180
M6X65	100	51010.060.065	M10X200/S=17*	25	51010.100.200	M16X190*	10	51010.160.190
M6X70	100	51010.060.070				M16X200	10	51010.160.200
M6X75	100	51010.060.075	M12X16/S=19	100	51010.120.016			
M6X80	100	51010.060.080	M12X18/S=19*	50	51010.120.018	M18X30	25	51010.180.030
M6X85*	100	51010.060.085	M12X20/S=19	100	51010.120.020	M18X35	25	51010.180.035
M6X90	100	51010.060.090	M12X22/S=19*	50	51010.120.022	M18X40	25	51010.180.040
M6X95	100	51010.060.095	M12X25/S=19	100	51010.120.025	M18X45	25	51010.180.045
M6X100	100	51010.060.100	M12X30/S=19	100	51010.120.030	M18X50	25	51010.180.050
M6X110	100	51010.060.110	M12X35/S=19	100	51010.120.035	M18X55	25	51010.180.055

51010 Hexagon head screw								
d x L	☒	Art.number	d x L	☒	Art.number	d x L	☒	Art.number
M18X60	25	51010.180.060	M22X85/S=32*	25	51010.220.085	M27X190*	5	51010.270.190
M18X65*	25	51010.180.065	M22X90/S=32	10	51010.220.090	M27X200*	5	51010.270.200
M18X70	25	51010.180.070	M22X95/S=32*	25	51010.220.095			
M18X75*	25	51010.180.075	M22X100/S=32	5	51010.220.100	M30X60	1	51010.300.060
M18X80	25	51010.180.080	M22X110/S=32*	20	51010.220.110	M30X65*	10	51010.300.065
M18X85*	25	51010.180.085	M22X120/S=32*	20	51010.220.120	M30X70	1	51010.300.070
M18X90	25	51010.180.090	M22X130/S=32*	20	51010.220.130	M30X75*	10	51010.300.075
M18X95*	25	51010.180.095	M22X140/S=32*	20	51010.220.140	M30X80	1	51010.300.080
M18X100	25	51010.180.100	M22X150/S=32*	10	51010.220.150	M30X85*	10	51010.300.085
M18X110*	25	51010.180.110				M30X90	1	51010.300.090
M18X120*	25	51010.180.120	M24X40	10	51010.240.040	M30X95*	10	51010.300.095
M18X130*	25	51010.180.130	M24X45*	10	51010.240.045	M30X100	1	51010.300.100
M18X140*	25	51010.180.140	M24X50	5	51010.240.050	M30X110	1	51010.300.110
M18X150*	25	51010.180.150	M24X55	5	51010.240.055	M30X120	1	51010.300.120
			M24X60	5	51010.240.060	M30X130*	10	51010.300.130
M20X25	25	51010.200.025	M24X65	5	51010.240.065	M30X140*	10	51010.300.140
M20X30	25	51010.200.030	M24X70	5	51010.240.070	M30X150*	10	51010.300.150
M20X35	25	51010.200.035	M24X75*	10	51010.240.075	M30X160*	5	51010.300.160
M20X40	25	51010.200.040	M24X80	5	51010.240.080	M30X170*	5	51010.300.170
M20X45	25	51010.200.045	M24X85	10	51010.240.085	M30X180*	5	51010.300.180
M20X50	25	51010.200.050	M24X90	5	51010.240.090	M30X190*	5	51010.300.190
M20X55	25	51010.200.055	M24X95*	10	51010.240.095	M30X200*	5	51010.300.200
M20X60	25	51010.200.060	M24X100	5	51010.240.100			
M20X65	25	51010.200.065	M24X110	5	51010.240.110	M33X70*	10	51010.330.070
M20X70	25	51010.200.070	M24X120	5	51010.240.120	M33X80	1	51010.330.080
M20X75	10	51010.200.075	M24X130	5	51010.240.130	M33X85*	10	51010.330.085
M20X80	10	51010.200.080	M24X140	5	51010.240.140	M33X90	1	51010.330.090
M20X85*	25	51010.200.085	M24X150	5	51010.240.150	M33X95*	10	51010.330.095
M20X90	10	51010.200.090	M24X160*	10	51010.240.160	M33X100	1	51010.330.100
M20X95*	25	51010.200.095	M24X170*	10	51010.240.170	M33X110	1	51010.330.110
M20X100	10	51010.200.100	M24X180*	5	51010.240.180	M33X120	1	51010.330.120
M20X110	5	51010.200.110	M24X190*	5	51010.240.190	M33X130*	5	51010.330.130
M20X120	5	51010.200.120	M24X200*	5	51010.240.200	M33X140*	5	51010.330.140
M20X130	5	51010.200.130				M33X150*	5	51010.330.150
M20X140	5	51010.200.140	M27X50	3	51010.270.050	M33X160*	5	51010.330.160
M20X150	5	51010.200.150	M27X55*	10	51010.270.055	M33X170*	5	51010.330.170
M20X160	5	51010.200.160	M27X60	3	51010.270.060	M33X180*	5	51010.330.180
M20X170*	25	51010.200.170	M27X65*	10	51010.270.065			
M20X180	20	51010.200.180	M27X70	3	51010.270.070	M36X80	1	51010.360.080
M20X190*	20	51010.200.190	M27X75*	10	51010.270.075	M36X85*	5	51010.360.085
M20X200*	20	51010.200.200	M27X80	3	51010.270.080	M36X90	1	51010.360.090
M20X250*	20	51010.200.250	M27X85*	10	51010.270.085	M36X95*	5	51010.360.095
			M27X90	3	51010.270.090	M36X100	1	51010.360.100
M22X30/S=32	25	51010.220.030	M27X95*	10	51010.270.095	M36X110	1	51010.360.110
M22X40/S=32*	25	51010.220.040	M27X100	3	51010.270.100	M36X120	1	51010.360.120
M22X45/S=32*	25	51010.220.045	M27X110	3	51010.270.110	M36X130	1	51010.360.130
M22X50/S=32	10	51010.220.050	M27X120	3	51010.270.120	M36X140	1	51010.360.140
M22X55/S=32*	25	51010.220.055	M27X130*	10	51010.270.130	M36X150	1	51010.360.150
M22X60/S=32	10	51010.220.060	M27X140*	10	51010.270.140	M36X160*	5	51010.360.160
M22X65/S=32*	25	51010.220.065	M27X150*	10	51010.270.150	M36X170*	5	51010.360.170
M22X70/S=32	10	51010.220.070	M27X160*	5	51010.270.160	M36X180*	5	51010.360.180
M22X75/S=32*	25	51010.220.075	M27X170*	5	51010.270.170	M36X200*	5	51010.360.200
M22X80/S=32	10	51010.220.080	M27X180*	5	51010.270.180			

* Sizes with a diameter > M24 and sizes with a length > 8xd are minimal property class 50.

55010 Hexagon head screw		Q41A	
Thread	Metric thread		
Material	Stainless steel A4		
Class	70		



d x L	☒	Art.number	d x L	☒	Art.number	d x L	☒	Art.number
M2X4*	1000	55010.020.004	M2,5X12*	1000	55010.025.012	M3X22*	1000	55010.030.022
M2X5*	1000	55010.020.005	M2,5X14*	1000	55010.025.014	M3X25	200	55010.030.025
M2X6*	1000	55010.020.006	M2,5X16*	1000	55010.025.016	M3X30	200	55010.030.030
M2X8*	1000	55010.020.008	M2,5X20*	1000	55010.025.020	M3X35	500	55010.030.035
M2X10*	1000	55010.020.010				M3X40*	500	55010.030.040
M2X12*	1000	55010.020.012	M3X4*	1000	55010.030.004	M3X50*	200	55010.030.050
M2X14*	1000	55010.020.014	M3X5*	1000	55010.030.005			
M2X16*	1000	55010.020.016	M3X6*	1000	55010.030.006	M4X6	1000	55010.040.006
M2X20*	1000	55010.020.020	M3X8	200	55010.030.008	M4X8	200	55010.040.008
			M3X10	200	55010.030.010	M4X10	200	55010.040.010
M2,5X4*	1000	55010.025.004	M3X12	200	55010.030.012	M4X12	200	55010.040.012
M2,5X5*	1000	55010.025.005	M3X14*	1000	55010.030.014	M4X14	1000	55010.040.014
M2,5X6*	1000	55010.025.006	M3X16	200	55010.030.016	M4X16	200	55010.040.016
M2,5X8*	1000	55010.025.008	M3X18*	1000	55010.030.018	M4X18	1000	55010.040.018
M2,5X10*	1000	55010.025.010	M3X20	200	55010.030.020	M4X20	200	55010.040.020

55010 Hexagon head screw								
d x L	☒	Art.number	d x L	☒	Art.number	d x L	☒	Art.number
M4X22*	500	55010.040.022	M8X40	100	55010.080.040	M12X150/S=19	10	55010.120.150
M4X25	200	55010.040.025	M8X45	100	55010.080.045	M12X160/S=19	10	55010.120.160
M4X30	200	55010.040.030	M8X50	100	55010.080.050	M12X170/S=19*	10	55010.120.170
M4X35	200	55010.040.035	M8X55	100	55010.080.055	M12X180/S=19	10	55010.120.180
M4X40	200	55010.040.040	M8X60	100	55010.080.060	M12X190/S=19*	10	55010.120.190
M4X45	200	55010.040.045	M8X65	100	55010.080.065	M12X200/S=19	10	55010.120.200
M4X50	200	55010.040.050	M8X70	50	55010.080.070	M12X250/S=19*	10	55010.120.250
M4X55*	200	55010.040.055	M8X75	50	55010.080.075			
M4X60	100	55010.040.060	M8X80	50	55010.080.080	M14X20/S=22*	50	55010.140.020
M4X70*	100	55010.040.070	M8X85*	50	55010.080.085	M14X25/S=22	50	55010.140.025
M4X75*	100	55010.040.075	M8X90	50	55010.080.090	M14X30/S=22	50	55010.140.030
M4X80*	100	55010.040.080	M8X95*	50	55010.080.095	M14X35/S=22	50	55010.140.035
			M8X100	50	55010.080.100	M14X40/S=22	50	55010.140.040
M5X5*	500	55010.050.005	M8X110	25	55010.080.110	M14X45/S=22	50	55010.140.045
M5X6*	500	55010.050.006	M8X120	25	55010.080.120	M14X50/S=22	50	55010.140.050
M5X8	200	55010.050.008	M8X130*	50	55010.080.130	M14X55/S=22*	50	55010.140.055
M5X10	200	55010.050.010	M8X140	25	55010.080.140	M14X60/S=22	50	55010.140.060
M5X12	200	55010.050.012	M8X150*	50	55010.080.150	M14X65/S=22	50	55010.140.065
M5X14	500	55010.050.014	M8X160	25	55010.080.160	M14X70/S=22	50	55010.140.070
M5X16	200	55010.050.016	M8X170*	25	55010.080.170	M14X75/S=22*	50	55010.140.075
M5X18	200	55010.050.018	M8X180	25	55010.080.180	M14X80/S=22	25	55010.140.080
M5X20	200	55010.050.020	M8X190*	25	55010.080.190	M14X85/S=22*	50	55010.140.085
M5X22	500	55010.050.022	M8X200*	25	55010.080.200	M14X90/S=22	25	55010.140.090
M5X25	200	55010.050.025				M14X100/S=22	10	55010.140.100
M5X30	200	55010.050.030	M10X10/S=17	100	55010.100.010	M14X110/S=22*	25	55010.140.110
M5X35	200	55010.050.035	M10X12/S=17	100	55010.100.012	M14X120/S=22	10	55010.140.120
M5X40	200	55010.050.040	M10X14/S=17*	100	55010.100.014	M14X130/S=22*	25	55010.140.130
M5X45	200	55010.050.045	M10X16/S=17	100	55010.100.016	M14X140/S=22	10	55010.140.140
M5X50	200	55010.050.050	M10X18/S=17	100	55010.100.018	M14X150/S=22*	25	55010.140.150
M5X55	200	55010.050.055	M10X20/S=17	100	55010.100.020			
M5X60	200	55010.050.060	M10X22/S=17	100	55010.100.022	M16X20	25	55010.160.020
M5X65*	200	55010.050.065	M10X25/S=17	100	55010.100.025	M16X25	50	55010.160.025
M5X70	100	55010.050.070	M10X30/S=17	100	55010.100.030	M16X30	50	55010.160.030
M5X75*	100	55010.050.075	M10X35/S=17	100	55010.100.035	M16X35	50	55010.160.035
M5X80*	100	55010.050.080	M10X40/S=17	100	55010.100.040	M16X40	50	55010.160.040
M5X85*	100	55010.050.085	M10X45/S=17	100	55010.100.045	M16X45	50	55010.160.045
M5X90*	100	55010.050.090	M10X50/S=17	100	55010.100.050	M16X50	25	55010.160.050
M5X95*	100	55010.050.095	M10X55/S=17	50	55010.100.055	M16X55	25	55010.160.055
M5X100*	100	55010.050.100	M10X60/S=17	50	55010.100.060	M16X60	25	55010.160.060
			M10X65/S=17	50	55010.100.065	M16X65	25	55010.160.065
M6X6*	500	55010.060.006	M10X70/S=17	50	55010.100.070	M16X70	25	55010.160.070
M6X8	200	55010.060.008	M10X75/S=17	50	55010.100.075	M16X75	25	55010.160.075
M6X10	200	55010.060.010	M10X80/S=17	50	55010.100.080	M16X80	25	55010.160.080
M6X12	200	55010.060.012	M10X85/S=17*	50	55010.100.085	M16X85	25	55010.160.085
M6X14	200	55010.060.014	M10X90/S=17	25	55010.100.090	M16X90	10	55010.160.090
M6X16	200	55010.060.016	M10X95/S=17*	50	55010.100.095	M16X95*	25	55010.160.095
M6X18	200	55010.060.018	M10X100/S=17	25	55010.100.100	M16X100	10	55010.160.100
M6X20	200	55010.060.020	M10X110/S=17	25	55010.100.110	M16X110	10	55010.160.110
M6X22	200	55010.060.022	M10X120/S=17	25	55010.100.120	M16X120	10	55010.160.120
M6X25	200	55010.060.025	M10X130/S=17*	50	55010.100.130	M16X130	10	55010.160.130
M6X30	200	55010.060.030	M10X135/S=17*	50	55010.100.135	M16X140	10	55010.160.140
M6X35	200	55010.060.035	M10X140/S=17	25	55010.100.140	M16X150	10	55010.160.150
M6X40	200	55010.060.040	M10X150/S=17	25	55010.100.150	M16X160	10	55010.160.160
M6X45	100	55010.060.045	M10X160/S=17	10	55010.100.160	M16X170*	25	55010.160.170
M6X50	100	55010.060.050	M10X170/S=17*	25	55010.100.170	M16X180	10	55010.160.180
M6X55	100	55010.060.055	M10X180/S=17	10	55010.100.180	M16X190*	10	55010.160.190
M6X60	100	55010.060.060	M10X190/S=17*	25	55010.100.190	M16X200	10	55010.160.200
M6X65	100	55010.060.065	M10X200/S=17	10	55010.100.200			
M6X70	100	55010.060.070				M18X30*	25	55010.180.030
M6X75	100	55010.060.075	M12X16/S=19	100	55010.120.016	M18X35	25	55010.180.035
M6X80	100	55010.060.080	M12X18/S=19*	50	55010.120.018	M18X40	25	55010.180.040
M6X85*	100	55010.060.085	M12X20/S=19	100	55010.120.020	M18X45	25	55010.180.045
M6X90	100	55010.060.090	M12X25/S=19	100	55010.120.025	M18X50	25	55010.180.050
M6X95*	100	55010.060.095	M12X30/S=19	100	55010.120.030	M18X55*	25	55010.180.055
M6X100	100	55010.060.100	M12X35/S=19	100	55010.120.035	M18X60	25	55010.180.060
M6X110*	50	55010.060.110	M12X40/S=19	50	55010.120.040	M18X65*	25	55010.180.065
M6X120	50	55010.060.120	M12X45/S=19	50	55010.120.045	M18X70	25	55010.180.070
M6X130*	50	55010.060.130	M12X50/S=19	50	55010.120.050	M18X75*	25	55010.180.075
M6X140*	50	55010.060.140	M12X55/S=19	50	55010.120.055	M18X80	25	55010.180.080
M6X150*	50	55010.060.150	M12X60/S=19	50	55010.120.060	M18X85*	25	55010.180.085
			M12X65/S=19	50	55010.120.065	M18X90	25	55010.180.090
M8X8*	500	55010.080.008	M12X70/S=19	50	55010.120.070	M18X100	25	55010.180.100
M8X10	200	55010.080.010	M12X75/S=19	25	55010.120.075	M18X110*	25	55010.180.110
M8X12	200	55010.080.012	M12X80/S=19	50	55010.120.080	M18X120*	25	55010.180.120
M8X14*	200	55010.080.014	M12X85/S=19*	25	55010.120.085	M18X130*	25	55010.180.130
M8X16	200	55010.080.016	M12X90/S=19	25	55010.120.090	M18X140*	25	55010.180.140
M8X18	200	55010.080.018	M12X95/S=19*	25	55010.120.095	M18X150*	25	55010.180.150
M8X20	200	55010.080.020	M12X100/S=19	25	55010.120.100			
M8X22	200	55010.080.022	M12X110/S=19	25	55010.120.110	M20X25*	25	55010.200.025
M8X25	200	55010.080.025	M12X120/S=19	25	55010.120.120	M20X30	25	55010.200.030
M8X30	200	55010.080.030	M12X130/S=19*	25	55010.120.130	M20X35	25	55010.200.035
M8X35	200	55010.080.035	M12X140/S=19	25	55010.120.140	M20X40	25	55010.200.040

55010 Hexagon head screw								
d x L	☒	Art.number	d x L	☒	Art.number	d x L	☒	Art.number
M20X45	25	55010.200.045	M24X45*	10	55010.240.045	M30X70	1	55010.300.070
M20X50	25	55010.200.050	M24X50	5	55010.240.050	M30X75*	10	55010.300.075
M20X55	25	55010.200.055	M24X55	5	55010.240.055	M30X80	1	55010.300.080
M20X60	25	55010.200.060	M24X60	5	55010.240.060	M30X85*	10	55010.300.085
M20X65	25	55010.200.065	M24X65	5	55010.240.065	M30X90	1	55010.300.090
M20X70	25	55010.200.070	M24X70	5	55010.240.070	M30X100	1	55010.300.100
M20X75	10	55010.200.075	M24X75*	10	55010.240.075	M30X110	1	55010.300.110
M20X80	10	55010.200.080	M24X80	5	55010.240.080	M30X120	1	55010.300.120
M20X85	10	55010.200.085	M24X85*	10	55010.240.085	M30X130*	10	55010.300.130
M20X90	10	55010.200.090	M24X90	5	55010.240.090	M30X140*	10	55010.300.140
M20X95*	25	55010.200.095	M24X95*	10	55010.240.095	M30X150	1	55010.300.150
M20X100	10	55010.200.100	M24X100	5	55010.240.100	M30X160*	5	55010.300.160
M20X110	5	55010.200.110	M24X110	5	55010.240.110	M30X170*	5	55010.300.170
M20X120	5	55010.200.120	M24X120	5	55010.240.120	M30X180*	5	55010.300.180
M20X125*	25	55010.200.125	M24X130	5	55010.240.130	M30X190*	5	55010.300.190
M20X130	5	55010.200.130	M24X140	5	55010.240.140	M30X200*	5	55010.300.200
M20X140	5	55010.200.140	M24X150	5	55010.240.150			
M20X150	5	55010.200.150	M24X160	3	55010.240.160	M33X70	1	55010.330.070
M20X160	5	55010.200.160	M24X170*	10	55010.240.170	M33X75*	10	55010.330.075
M20X170*	25	55010.200.170	M24X180	3	55010.240.180	M33X80	1	55010.330.080
M20X180	5	55010.200.180	M24X190*	5	55010.240.190	M33X85*	10	55010.330.085
M20X190*	20	55010.200.190	M24X200	3	55010.240.200	M33X90	1	55010.330.090
M20X200	5	55010.200.200				M33X100	1	55010.330.100
M20X250*	20	55010.200.250	M27X50	3	55010.270.050	M33X110	1	55010.330.110
			M27X55*	10	55010.270.055	M33X120	1	55010.330.120
M22X30/S=32*	25	55010.220.030	M27X60	3	55010.270.060	M33X130*	5	55010.330.130
M22X35/S=32*	25	55010.220.035	M27X65*	10	55010.270.065	M33X140*	5	55010.330.140
M22X40/S=32*	25	55010.220.040	M27X70	3	55010.270.070	M33X150*	5	55010.330.150
M22X45/S=32*	25	55010.220.045	M27X75*	10	55010.270.075	M33X160*	5	55010.330.160
M22X50/S=32	10	55010.220.050	M27X80	3	55010.270.080	M33X180*	5	55010.330.180
M22X55/S=32*	25	55010.220.055	M27X85*	10	55010.270.085	M33X190*	5	55010.330.190
M22X60/S=32	10	55010.220.060	M27X90	3	55010.270.090			
M22X65/S=32*	25	55010.220.065	M27X95*	10	55010.270.095	M36X80	1	55010.360.080
M22X70/S=32	10	55010.220.070	M27X100	3	55010.270.100	M36X90	1	55010.360.090
M22X75/S=32*	25	55010.220.075	M27X110*	10	55010.270.110	M36X100	1	55010.360.100
M22X80/S=32	10	55010.220.080	M27X120	3	55010.270.120	M36X110	1	55010.360.110
M22X85/S=32*	25	55010.220.085	M27X130*	10	55010.270.130	M36X120	1	55010.360.120
M22X90/S=32*	25	55010.220.090	M27X140*	10	55010.270.140	M36X130*	5	55010.360.130
M22X100/S=32*	25	55010.220.100	M27X150*	10	55010.270.150	M36X140*	5	55010.360.140
M22X110/S=32*	20	55010.220.110	M27X160*	5	55010.270.160	M36X150*	5	55010.360.150
M22X120/S=32*	20	55010.220.120	M27X170*	5	55010.270.170	M36X160*	5	55010.360.160
M22X130/S=32*	20	55010.220.130	M27X180*	5	55010.270.180	M36X180*	5	55010.360.180
M22X140/S=32*	20	55010.220.140	M27X190*	5	55010.270.190	M36X190*	5	55010.360.190
M22X150/S=32*	10	55010.220.150				M36X200*	5	55010.360.200
M24X40	10	55010.240.040	M30X60	1	55010.300.060			
			M30X65*	10	55010.300.065			



* Sizes with a diameter > M24 and sizes with a length > 8xd are minimal property class 50.

53520 Hexagon head screw		R11A	
Thread	Metric thread		
Material	Stainless steel A4		
Class	80		





d x L	☒	Art.number	d x L	☒	Art.number	d x L	☒	Art.number
M4X8	100	53520.040.008	M5X20	100	53520.050.020	M6X20	100	53520.060.020
M4X10	100	53520.040.010	M5X22*	500	53520.050.022	M6X22*	200	53520.060.022
M4X12	100	53520.040.012	M5X25	100	53520.050.025	M6X25	100	53520.060.025
M4X14*	1000	53520.040.014	M5X30	100	53520.050.030	M6X30	100	53520.060.030
M4X16	100	53520.040.016	M5X35*	200	53520.050.035	M6X35*	200	53520.060.035
M4X18*	1000	53520.040.018	M5X40	100	53520.050.040	M6X40	100	53520.060.040
M4X20	100	53520.040.020	M5X45*	200	53520.050.045	M6X45*	100	53520.060.045
M4X22*	500	53520.040.022	M5X50*	200	53520.050.050	M6X50	100	53520.060.050
M4X25	100	53520.040.025	M5X55*	200	53520.050.055	M6X55*	100	53520.060.055
M4X35*	200	53520.040.035	M5X60*	200	53520.050.060	M6X60*	100	53520.060.060
M4X40*	200	53520.040.040	M5X70*	100	53520.050.070	M6X65*	100	53520.060.065
M4X45*	200	53520.040.045	M5X80*	100	53520.050.080	M6X70*	100	53520.060.070
M4X50*	200	53520.040.050	M5X85*	100	53520.050.085	M6X75*	100	53520.060.075
M4X60*	100	53520.040.060	M5X90*	100	53520.050.090	M6X80*	100	53520.060.080
M4X70*	100	53520.040.070	M5X100*	100	53520.050.100	M6X85*	100	53520.060.085
						M6X90*	100	53520.060.090
M5X8*	500	53520.050.008	M6X8*	500	53520.060.008	M6X100*	100	53520.060.100
M5X10	100	53520.050.010	M6X10	100	53520.060.010	M6X110*	100	53520.060.110
M5X12	100	53520.050.012	M6X12	100	53520.060.012	M6X120*	50	53520.060.120
M5X14*	500	53520.050.014	M6X14*	200	53520.060.014	M6X150*	50	53520.060.150
M5X16	100	53520.050.016	M6X16	100	53520.060.016			
M5X18*	500	53520.050.018	M6X18*	200	53520.060.018	M8X10*	500	53520.080.010

53520 Hexagon head screw								
d x L	☒	Art.number	d x L	☒	Art.number	d x L	☒	Art.number
M8X12	50	53520.080.012	M12X35/S=19	25	53520.120.035	M16X100*	25	53520.160.100
M8X14*	200	53520.080.014	M12X40/S=19	25	53520.120.040	M16X110	25	53520.160.110
M8X16	50	53520.080.016	M12X45/S=19	100	53520.120.045	M16X120*	25	53520.160.120
M8X18*	200	53520.080.018	M12X50/S=19	25	53520.120.050	M16X130*	25	53520.160.130
M8X20	50	53520.080.020	M12X55/S=19	25	53520.120.055	M16X140*	25	53520.160.140
M8X22*	200	53520.080.022	M12X60/S=19	25	53520.120.060	M16X150*	25	53520.160.150
M8X25	50	53520.080.025	M12X65/S=19	25	53520.120.065	M16X160*	25	53520.160.160
M8X30	50	53520.080.030	M12X70/S=19	25	53520.120.070	M16X170*	25	53520.160.170
M8X35	50	53520.080.035	M12X75/S=19*	25	53520.120.075	M16X180*	10	53520.160.180
M8X40	50	53520.080.040	M12X80/S=19*	25	53520.120.080	M16X190*	10	53520.160.190
M8X45*	100	53520.080.045	M12X85/S=19*	25	53520.120.085	M16X200*	10	53520.160.200
M8X50	50	53520.080.050	M12X90/S=19*	25	53520.120.090			
M8X55*	100	53520.080.055	M12X95/S=19*	25	53520.120.095	M20X30*	25	53520.200.030
M8X60*	100	53520.080.060	M12X100/S=19*	25	53520.120.100	M20X35*	25	53520.200.035
M8X65*	100	53520.080.065	M12X110/S=19*	25	53520.120.110	M20X40	10	53520.200.040
M8X70*	50	53520.080.070	M12X120/S=19*	25	53520.120.120	M20X45*	25	53520.200.045
M8X75*	50	53520.080.075	M12X130/S=19*	25	53520.120.130	M20X50	10	53520.200.050
M8X80*	50	53520.080.080	M12X140/S=19*	25	53520.120.140	M20X55	10	53520.200.055
M8X85*	50	53520.080.085	M12X150/S=19*	25	53520.120.150	M20X60	10	53520.200.060
M8X90*	50	53520.080.090	M12X160/S=19*	10	53520.120.160	M20X65*	25	53520.200.065
M8X95*	50	53520.080.095	M12X170/S=19*	10	53520.120.170	M20X70*	25	53520.200.070
M8X100*	50	53520.080.100	M12X180/S=19*	10	53520.120.180	M20X75*	25	53520.200.075
M8X110*	50	53520.080.110	M12X190/S=19*	10	53520.120.190	M20X80	25	53520.200.080
M8X120*	50	53520.080.120	M12X200/S=19*	10	53520.120.200	M20X85*	25	53520.200.085
M8X130*	50	53520.080.130				M20X90	25	53520.200.090
M8X140*	50	53520.080.140	M14X20/S=22*	50	53520.140.020	M20X95*	25	53520.200.095
M8X150*	50	53520.080.150	M14X25/S=22*	50	53520.140.025	M20X100*	25	53520.200.100
M8X160*	50	53520.080.160	M14X30/S=22*	50	53520.140.030	M20X110*	25	53520.200.110
M8X170*	50	53520.080.170	M14X35/S=22*	50	53520.140.035	M20X120*	25	53520.200.120
			M14X40/S=22*	50	53520.140.040	M20X130*	25	53520.200.130
M10X12/S=17*	100	53520.100.012	M14X45/S=22*	50	53520.140.045	M20X140*	25	53520.200.140
M10X16/S=17	50	53520.100.016	M14X50/S=22	50	53520.140.050	M20X150*	25	53520.200.150
M10X20/S=17	50	53520.100.020	M14X55/S=22*	50	53520.140.055	M20X160*	25	53520.200.160
M10X25/S=17	50	53520.100.025	M14X60/S=22*	50	53520.140.060	M20X170*	25	53520.200.170
M10X30/S=17	50	53520.100.030	M14X65/S=22*	50	53520.140.065	M20X180*	20	53520.200.180
M10X35/S=17	50	53520.100.035	M14X70/S=22*	50	53520.140.070	M20X200*	20	53520.200.200
M10X40/S=17	50	53520.100.040	M14X75/S=22*	50	53520.140.075			
M10X45/S=17	100	53520.100.045	M14X80/S=22*	50	53520.140.080	M24X40*	10	53520.240.040
M10X50/S=17	50	53520.100.050	M14X90/S=22*	50	53520.140.090	M24X45*	10	53520.240.045
M10X55/S=17*	50	53520.100.055	M14X100/S=22*	50	53520.140.100	M24X50	10	53520.240.050
M10X60/S=17*	50	53520.100.060	M14X110/S=22*	25	53520.140.110	M24X55*	10	53520.240.055
M10X65/S=17*	50	53520.100.065	M14X120/S=22*	25	53520.140.120	M24X60	10	53520.240.060
M10X70/S=17*	100	53520.100.070	M14X130/S=22*	25	53520.140.130	M24X65*	10	53520.240.065
M10X75/S=17*	50	53520.100.075	M14X150/S=22*	25	53520.140.150	M24X70	10	53520.240.070
M10X80/S=17*	50	53520.100.080				M24X75*	10	53520.240.075
M10X85/S=17*	50	53520.100.085	M16X20*	25	53520.160.020	M24X80	10	53520.240.080
M10X90/S=17*	50	53520.100.090	M16X25*	25	53520.160.025	M24X85*	10	53520.240.085
M10X100/S=17*	50	53520.100.100	M16X30	25	53520.160.030	M24X90*	10	53520.240.090
M10X110/S=17*	50	53520.100.110	M16X35	25	53520.160.035	M24X95*	10	53520.240.095
M10X120/S=17*	50	53520.100.120	M16X40	25	53520.160.040	M24X100*	10	53520.240.100
M10X130/S=17*	50	53520.100.130	M16X45	25	53520.160.045	M24X110*	10	53520.240.110
M10X140/S=17*	50	53520.100.140	M16X50	25	53520.160.050	M24X120*	10	53520.240.120
M10X150/S=17*	50	53520.100.150	M16X55	25	53520.160.055	M24X130*	10	53520.240.130
M10X160/S=17*	25	53520.100.160	M16X60	25	53520.160.060	M24X140*	10	53520.240.140
M10X180/S=17*	25	53520.100.180	M16X65	25	53520.160.065	M24X150*	10	53520.240.150
M10X200/S=17*	25	53520.100.200	M16X70	25	53520.160.070	M24X160*	10	53520.240.160
			M16X75*	25	53520.160.075	M24X180*	5	53520.240.180
M12X16/S=19*	50	53520.120.016	M16X80*	25	53520.160.080	M24X190*	5	53520.240.190
M12X20/S=19	25	53520.120.020	M16X85*	25	53520.160.085	M24X200*	5	53520.240.200
M12X25/S=19	25	53520.120.025	M16X90*	25	53520.160.090			
M12X30/S=19	25	53520.120.030	M16X95*	25	53520.160.095			



53521 Hexagon head screw								Q41A
Thread	Metric thread							
Material	Stainless steel A5							
Class	70							
								
d x L	☒	Art.number	d x L	☒	Art.number	d x L	☒	Art.number
M8X20*	200	53521.080.020	M8X50*	100	53521.080.050	M10X30*	100	53521.100.030
M8X25*	100	53521.080.025				M10X40*	100	53521.100.040
M8X30*	100	53521.080.030	M10X20*	100	53521.100.020	M10X50*	50	53521.100.050
M8X40*	100	53521.080.040	M10X25*	100	53521.100.025			

45010 Hexagon head screw		W01A
Thread	Metric thread	
Material	Aluminium P40	



d x L	☒	Art.number	d x L	☒	Art.number	d x L	☒	Art.number
M6X10	100	45010.060.010	M8X16	100	45010.080.016	M8X60	100	45010.080.060
M6X16	100	45010.060.016	M8X25	100	45010.080.025	M8X70	100	45010.080.070
M6X25	100	45010.060.025	M8X30	100	45010.080.030	M10X30/S=17	100	45010.100.030
M6X30	100	45010.060.030	M8X35	100	45010.080.035	M10X40/S=17	100	45010.100.040
M6X40	100	45010.060.040	M8X50	100	45010.080.050	M10X50/S=17	100	45010.100.050
M6X50	100	45010.060.050						

45210 Hexagon head screw		W01A
Thread	Metric thread	
Material	Aluminium P60	

d x L	☒	Art.number	d x L	☒	Art.number	d x L	☒	Art.number
M5X16	200	45210.050.016	M8X20	100	45210.080.020	M12X40/S=19	50	45210.120.040
M5X25	200	45210.050.025	M8X25	100	45210.080.025	M12X50/S=19	50	45210.120.050
M5X30	200	45210.050.030	M8X30	100	45210.080.030	M12X60/S=19	50	45210.120.060
M5X40	200	45210.050.040	M8X40	100	45210.080.040	M12X70/S=19	25	45210.120.070
M6X25	200	45210.060.025	M10X20/S=17	100	45210.100.020	M12X80/S=19	25	45210.120.080
M6X30	200	45210.060.030	M10X30/S=17	100	45210.100.030	M16X30	25	45210.160.030
M6X40	200	45210.060.040	M10X35/S=17	100	45210.100.035	M16X35	25	45210.160.035
M8X15	100	45210.080.015	M10X70/S=17	50	45210.100.070			

45810 Hexagon head screw		M11A
Thread	Metric thread	
Material	Kuprodur Cu5	
Class	60	

d x L	☒	Art.number	d x L	☒	Art.number	d x L	☒	Art.number
M6X16	100	45810.060.016	M8X40	100	45810.080.040	M12X30/S=19	25	45810.120.030
M6X20	100	45810.060.020	M10X20/S=17	50	45810.100.020	M12X35/S=19	25	45810.120.035
M6X25	100	45810.060.025	M10X25/S=17	50	45810.100.025	M12X40/S=19	25	45810.120.040
M6X30	100	45810.060.030	M10X30/S=17	50	45810.100.030	M12X50/S=19	25	45810.120.050
M8X20	100	45810.080.020	M10X35/S=17	50	45810.100.035	M12X60/S=19	25	45810.120.060
M8X25	100	45810.080.025	M10X40/S=17	50	45810.100.040	M16X35	10	45810.160.035
M8X30	100	45810.080.030	M10X45/S=17	50	45810.100.045	M16X40	10	45810.160.040
M8X35	100	45810.080.035				M16X50	10	45810.160.050



46010 Hexagon head screw		M01A
Thread	Metric thread	
Material	Brass Cu2/Cu3	
		

d x L	☒	Art.number	d x L	☒	Art.number	d x L	☒	Art.number
M4X10	200	46010.040.010	M5X40	200	46010.050.040	M8X20	100	46010.080.020
M4X12	200	46010.040.012	M6X10	200	46010.060.010	M8X25	100	46010.080.025
M4X16	200	46010.040.016	M6X12	200	46010.060.012	M8X30	100	46010.080.030
M4X20	200	46010.040.020	M6X16	200	46010.060.016	M8X35	100	46010.080.035
M4X25	200	46010.040.025	M6X20	200	46010.060.020	M8X40	100	46010.080.040
M4X30	200	46010.040.030	M6X25	200	46010.060.025	M8X45	100	46010.080.045
M4X50	200	46010.040.050	M6X30	200	46010.060.030	M8X50	100	46010.080.050
M5X10	200	46010.050.010	M6X30	200	46010.060.030	M8X60	100	46010.080.060
M5X12	200	46010.050.012	M6X40	200	46010.060.040	M8X70	100	46010.080.070
M5X16	200	46010.050.016	M6X45	200	46010.060.045	M10X16/S=17	100	46010.100.016
M5X20	200	46010.050.020	M6X50	200	46010.060.050	M10X20/S=17	50	46010.100.020
M5X25	200	46010.050.025	M6X60	100	46010.060.060	M10X25/S=17	50	46010.100.025
M5X30	200	46010.050.030	M8X16	100	46010.080.016	M10X30/S=17	50	46010.100.030

46010 Hexagon head screw								
d x L	☒	Art.number	d x L	☒	Art.number	d x L	☒	Art.number
M10X35/S=17	50	46010.100.035	M12X30/S=19	50	46010.120.030	M16X30	25	46010.160.030
M10X40/S=17	50	46010.100.040	M12X35/S=19	50	46010.120.035	M16X40	25	46010.160.040
M10X45/S=17	50	46010.100.045	M12X40/S=19	25	46010.120.040	M16X50	10	46010.160.050
M10X50/S=17	50	46010.100.050	M12X50/S=19	25	46010.120.050	M16X60	10	46010.160.060
M10X60/S=17	50	46010.100.060	M12X60/S=19	25	46010.120.060	M16X70	10	46010.160.070
M10X70/S=17	50	46010.100.070	M12X70/S=19	25	46010.120.070	M16X80	10	46010.160.080
M12X20/S=19	50	46010.120.020	M12X80/S=19	25	46010.120.080	M16X90	10	46010.160.090
M12X25/S=19	50	46010.120.025	M12X90/S=19	25	46010.120.090	M16X100	10	46010.160.100
			M12X100/S=19	25	46010.120.100			



46060 Hexagon head screw			M01A	
Thread	Metric thread			
Material	Brass Cu2/Cu3			
Surface treatment	Nickel plated			
			 	

d x L	☒	Art.number	d x L	☒	Art.number	d x L	☒	Art.number
M4X8	200	46060.040.008	M5X50	200	46060.050.050	M8X40	100	46060.080.040
M4X10	200	46060.040.010	M6X10	200	46060.060.010	M8X45	100	46060.080.045
M4X12	200	46060.040.012	M6X12	200	46060.060.012	M8X50	100	46060.080.050
M4X16	200	46060.040.016	M6X16	200	46060.060.016	M8X60	100	46060.080.060
M4X20	200	46060.040.020	M6X20	200	46060.060.020	M8X70	100	46060.080.070
M4X25	200	46060.040.025	M6X25	200	46060.060.025	M10X16/S=17	50	46060.100.016
M4X30	200	46060.040.030	M6X30	200	46060.060.030	M10X20/S=17	50	46060.100.020
M4X35	200	46060.040.035	M6X35	200	46060.060.035	M10X25/S=17	50	46060.100.025
M4X40	200	46060.040.040	M6X40	200	46060.060.040	M10X30/S=17	50	46060.100.030
M5X8	200	46060.050.008	M6X50	200	46060.060.050	M10X35/S=17	50	46060.100.035
M5X10	200	46060.050.010	M6X60	100	46060.060.060	M10X40/S=17	50	46060.100.040
M5X12	200	46060.050.012	M8X12	100	46060.080.012	M10X45/S=17	50	46060.100.045
M5X16	200	46060.050.016	M8X16	100	46060.080.016	M10X50/S=17	50	46060.100.050
M5X20	200	46060.050.020	M8X20	100	46060.080.020	M10X60/S=17	50	46060.100.060
M5X25	200	46060.050.025	M8X25	100	46060.080.025	M10X70/S=17	25	46060.100.070
M5X30	200	46060.050.030	M8X30	100	46060.080.030	M12X40/S=19	25	46060.120.040
M5X40	200	46060.050.040	M8X35	100	46060.080.035			
M5X45	200	46060.050.045						

45910 Hexagon head screw			W01A	
Thread	Metric thread		ISO	≈4017
Material	Titanium ASTM		DIN	≈933
Class	Gr.2		NEN	≈1568
			NF	≈E25-114
			 	

d x L	☒	Art.number	d x L	☒	Art.number	d x L	☒	Art.number
M6X20	10	45910.060.020	M8X30	10	45910.080.030	M10X20/S=17	10	45910.100.020
M6X30	10	45910.060.030	M8X40	10	45910.080.040	M10X30/S=17	10	45910.100.030
M6X40	10	45910.060.040	M8X50	10	45910.080.050	M10X40/S=17	5	45910.100.040
M8X20	10	45910.080.020				M10X50/S=17	5	45910.100.050

- Titanium ASTM Grade 2 (materialnumber 3.7035) with a high percentage of pure titanium, ensures product stability and -suitability in extremely corrosive environments where other materials i.e. stainless steel fail.
- Titanium Grade 2 is also suitable for other light loaded applications.

56100 Hexagon head screw plastic			W02A	
Thread	Metric thread		ISO	≈4017
Material	Plastic Polyamide (nylon)		DIN	≈933
Class	PA 6.6		NEN	≈1568
Color	White		ASME	≈B18.2.3.1M
			NF	≈E25-114
			 	

d x L	☒	Art.number	d x L	☒	Art.number	d x L	☒	Art.number
M3X10	200	56100.030.010	M4X30	200	56100.040.030	M6X10	50	56100.060.010
M3X16	200	56100.030.016	M5X10	100	56100.050.010	M6X12	50	56100.060.012
M3X20	200	56100.030.020	M5X12	100	56100.050.012	M6X16	50	56100.060.016
M3X25	200	56100.030.025	M5X16	100	56100.050.016	M6X20	50	56100.060.020
M4X10	200	56100.040.010	M5X20	100	56100.050.020	M6X25	50	56100.060.025
M4X12	200	56100.040.012	M5X25	100	56100.050.025	M6X30	50	56100.060.030
M4X16	200	56100.040.016	M5X30	100	56100.050.030	M6X40	50	56100.060.040
M4X20	200	56100.040.020	M5X50	100	56100.050.050	M6X50	50	56100.060.050

56100 Hexagon head screw plastic								
d x L	☒	Art.number	d x L	☒	Art.number	d x L	☒	Art.number
M8X16	50	56100.080.016	M10X20/S=17	25	56100.100.020	M12X50/S=19	25	56100.120.050
M8X20	50	56100.080.020	M10X25/S=17	25	56100.100.025	M12X60/S=19	25	56100.120.060
M8X25	50	56100.080.025	M10X30/S=17	25	56100.100.030	M12X80/S=19	25	56100.120.080
M8X30	50	56100.080.030	M10X40/S=17	25	56100.100.040	M16X30	25	56100.160.030
M8X35	50	56100.080.035	M10X50/S=17	25	56100.100.050	M16X40	25	56100.160.040
M8X40	50	56100.080.040	M10X60/S=17	25	56100.100.060	M16X50	25	56100.160.050
M8X50	50	56100.080.050	M12X20/S=19	25	56100.120.020	M16X60	25	56100.160.060
M8X60	50	56100.080.060	M12X30/S=19	25	56100.120.030	M20X35	1	56100.200.035
M8X70	50	56100.080.070	M12X35/S=19	25	56100.120.035			
			M12X40/S=19	25	56100.120.040			

Slotted hexagon head screw

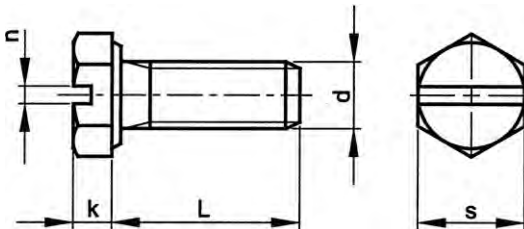

DIN ≈933
 ISO ≈4017
 NEN ≈1568
 ASME ≈B18.2.3.1M
 NF ≈E25-137

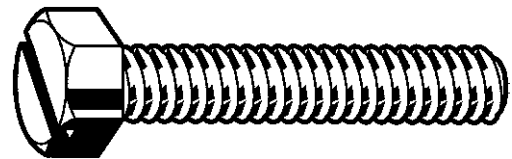

Technical Data				
d	k	n	P	s
M3	2	0.8	0.5	5.5
M4	2.8	1	0.7	7
M5	3.5	1.2	0.8	8
M6	4	1.6	1	10
M8	5.3	2	1.25	13
M10	6.4	2.5	1.5	17

• Slot acc. to DIN 962 SZ.

Article groups					
Thread	Driving features	Material	Class	Code	Page
M	Hexagon	St.St. A2	70	51012	1-35
M	Hexagon	St.St. A4	70	55012	1-36

51012 Slotted hexagon head screw		Q01A
Thread	Metric thread	
Material	Stainless steel A2	
Class	70	

d x L	☒	Art.number	d x L	☒	Art.number	d x L	☒	Art.number
M3X8*	1000	51012.030.008	M5X12*	500	51012.050.012	M6X20	200	51012.060.020
M4X6*	500	51012.040.006	M5X16	200	51012.050.016	M6X25	200	51012.060.025
M4X8	200	51012.040.008	M5X18*	500	51012.050.018	M6X30	200	51012.060.030
M4X10	200	51012.040.010	M5X20	200	51012.050.020	M6X35	200	51012.060.035
M4X12	200	51012.040.012	M5X25	200	51012.050.025	M6X40	200	51012.060.040
M4X16*	500	51012.040.016	M5X30	200	51012.050.030	M6X50*	200	51012.060.050
M4X20	500	51012.040.020	M5X35*	500	51012.050.035	M8X16*	200	51012.080.016
M4X25*	500	51012.040.025	M5X40*	500	51012.050.040	M8X20*	200	51012.080.020
M4X30*	500	51012.040.030	M6X10*	500	51012.060.010	M8X25*	100	51012.080.025
M4X60*	500	51012.040.060	M6X12	200	51012.060.012	M8X30*	100	51012.080.030
M5X8*	500	51012.050.008	M6X14*	500	51012.060.014	M8X40*	100	51012.080.040
M5X10*	500	51012.050.010	M6X16	200	51012.060.016	M10X50*	200	51012.100.050
			M6X18*	200	51012.060.018			

55012	Slotted hexagon head screw	Q41A
Thread	Metric thread	
Material	Stainless steel A4	
Class	70	
		 

d x L	☒	Art.number	d x L	☒	Art.number	d x L	☒	Art.number
M5X10*	500	55012.050.010	M6X12*	500	55012.060.012	M6X30*	200	55012.060.030
M5X12*	500	55012.050.012	M6X14*	500	55012.060.014	M6X40*	200	55012.060.040
M5X16*	500	55012.050.016	M6X16*	200	55012.060.016			
M5X20*	500	55012.050.020	M6X18*	200	55012.060.018	M8X20*	200	55012.080.020
M5X25*	500	55012.050.025	M6X20*	200	55012.060.020	M8X25*	100	55012.080.025
M5X30*	500	55012.050.030	M6X22*	200	55012.060.022	M8X30*	100	55012.080.030
			M6X25*	200	55012.060.025			

Hexagon head bolt MF

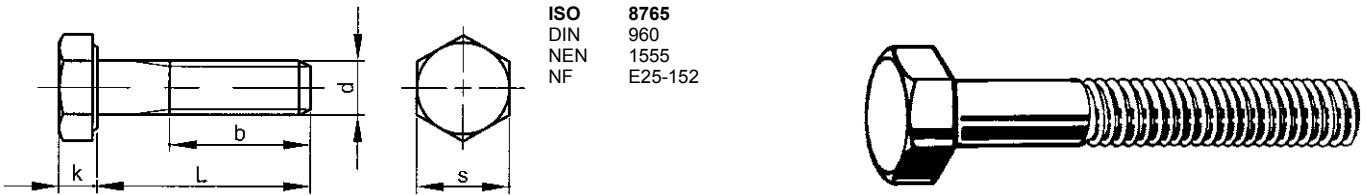

ISO 8765
 DIN 960
 NEN 1555
 NF E25-152

Technical Data					
d	b (min.): L≤125mm	b (min.): 125mm<L≤200mm	b (min.): L>200mm	k	s
M8	22	28	41	5.3	13
M10 (DIN)	26	32	45	6.4	17
M12 (DIN)	30	36	49	7.5	19
M14 (DIN)	34	40	53	8.8	22
M16	38	44	57	10	24
M18	42	48	61	11.5	27
M20	46	52	65	12.5	30
M24	54	60	73	15	36
M27	60	66	79	17	41
M30	66	72	85	18.7	46

Article groups						
Thread	Driving features	Material	Class	Surface treatment	Code	Page
MF	Hexagon	St	8.8		01060	1-36
MEF	Hexagon	St	8.8		01061	1-37
MF	Hexagon	St	8.8	Zipl yell.p.	01240	1-37
MEF	Hexagon	St	8.8	Zipl yell.p.	01241	1-37
MF	Hexagon	St	10.9		04160	1-38
MEF	Hexagon	St	10.9		04161	1-38

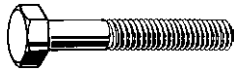
01060	Hexagon head bolt MF	A09A
Thread	Metric fine thread	
Material	Steel	
Class	8.8	
		 

d x P x L	☒	Art.number	d x P x L	☒	Art.number	d x P x L	☒	Art.number
M8X1,00X35	200	01060.080.035	M10X1,25X80/S=17	100	01060.100.080	M12X1,50X100/S=19	50	01060.120.100
M8X1,00X40	200	01060.080.040	M10X1,25X90/S=17	100	01060.100.090	M12X1,50X120/S=19	100	01060.120.120
M8X1,00X50	200	01060.080.050	M10X1,25X100/S=17	100	01060.100.100			
M8X1,00X60	200	01060.080.060	M10X1,25X120/S=17	100	01060.100.120	M14X1,50X50/S=22	50	01060.140.050
M8X1,00X70	200	01060.080.070				M14X1,50X55/S=22	50	01060.140.055
M8X1,00X80	200	01060.080.080	M12X1,50X45/S=19	100	01060.120.045	M14X1,50X60/S=22	50	01060.140.060
M8X1,00X90	100	01060.080.090	M12X1,50X50/S=19	100	01060.120.050	M14X1,50X65/S=22	50	01060.140.065
			M12X1,50X55/S=19	100	01060.120.055	M14X1,50X70/S=22	50	01060.140.070
M10X1,25X35/S=17	100	01060.100.035	M12X1,50X60/S=19	100	01060.120.060	M14X1,50X75/S=22	50	01060.140.075
M10X1,25X40/S=17	100	01060.100.040	M12X1,50X65/S=19	50	01060.120.065	M14X1,50X80/S=22	50	01060.140.080
M10X1,25X50/S=17	100	01060.100.050	M12X1,50X70/S=19	50	01060.120.070	M14X1,50X90/S=22	50	01060.140.090
M10X1,25X60/S=17	100	01060.100.060	M12X1,50X75/S=19	50	01060.120.075	M14X1,50X100/S=22	50	01060.140.100
M10X1,25X70/S=17	100	01060.100.070	M12X1,50X80/S=19	50	01060.120.080			
M10X1,25X75/S=17	100	01060.100.075	M12X1,50X90/S=19	50	01060.120.090	M16X1,50X55	50	01060.160.055

01060 Hexagon head bolt MF

d x P x L	☒	Art.number	d x P x L	☒	Art.number	d x P x L	☒	Art.number
M16X1,50X60	50	01060.160.060	M16X1,50X90	25	01060.160.090	M16X1,50X140	25	01060.160.140
M16X1,50X65	25	01060.160.065	M16X1,50X100	25	01060.160.100	M16X1,50X150	25	01060.160.150
M16X1,50X70	25	01060.160.070	M16X1,50X110	25	01060.160.110			
M16X1,50X75	25	01060.160.075	M16X1,50X120	25	01060.160.120	M24X2,00X100	5	01060.240.100
M16X1,50X80	25	01060.160.080	M16X1,50X130	25	01060.160.130			

01061 Hexagon head bolt MEF A09A

Thread Metric extra fine thread
Material Steel
Class 8.8

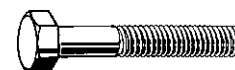

d x P x L	☒	Art.number	d x P x L	☒	Art.number	d x P x L	☒	Art.number
M10X1,00X40/S=17	100	01061.100.040	M12X1,25X80/S=19	50	01061.120.080	M18X1,50X160	10	01061.180.160
M10X1,00X45/S=17	100	01061.100.045	M12X1,25X90/S=19	50	01061.120.090	M18X1,50X170	10	01061.180.170
M10X1,00X50/S=17	100	01061.100.050	M12X1,25X100/S=19	50	01061.120.100	M18X1,50X180	10	01061.180.180
M10X1,00X60/S=17	100	01061.100.060	M12X1,25X110/S=19	100	01061.120.110	M18X1,50X190	10	01061.180.190
M10X1,00X70/S=17	100	01061.100.070	M12X1,25X140/S=19	100	01061.120.140	M18X1,50X200	10	01061.180.200
M10X1,00X80/S=17	100	01061.100.080						
M10X1,00X90/S=17	100	01061.100.090	M18X1,50X70	25	01061.180.070	M20X1,50X70	25	01061.200.070
M10X1,00X100/S=17	100	01061.100.100	M18X1,50X80	25	01061.180.080	M20X1,50X80	25	01061.200.080
			M18X1,50X90	25	01061.180.090	M20X1,50X90	25	01061.200.090
M12X1,25X45/S=19	100	01061.120.045	M18X1,50X100	25	01061.180.100	M20X1,50X100	25	01061.200.100
M12X1,25X50/S=19	100	01061.120.050	M18X1,50X120	25	01061.180.120	M20X1,50X120	25	01061.200.120
M12X1,25X55/S=19	100	01061.120.055	M18X1,50X130	25	01061.180.130	M20X1,50X130	25	01061.200.130
M12X1,25X60/S=19	100	01061.120.060	M18X1,50X140	25	01061.180.140	M20X1,50X140	25	01061.200.140
M12X1,25X70/S=19	50	01061.120.070	M18X1,50X150	25	01061.180.150	M20X1,50X150	25	01061.200.150

01240 Hexagon head bolt MF A09A

Thread Metric fine thread
Material Steel
Class 8.8
Surface treatment Zinc plated yellow passivated

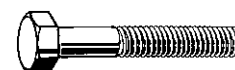

d x P x L	☒	Art.number	d x P x L	☒	Art.number	d x P x L	☒	Art.number
M8X1,00X35	200	01240.080.035	M12X1,50X50/S=19	100	01240.120.050	M14X1,50X110/S=22	50	01240.140.110
M8X1,00X40	200	01240.080.040	M12X1,50X55/S=19	100	01240.120.055	M14X1,50X120/S=22	50	01240.140.120
M8X1,00X50	200	01240.080.050	M12X1,50X60/S=19	100	01240.120.060	M14X1,50X140/S=22	50	01240.140.140
M8X1,00X60	200	01240.080.060	M12X1,50X65/S=19	50	01240.120.065			
M8X1,00X70	200	01240.080.070	M12X1,50X70/S=19	50	01240.120.070	M16X1,50X55	50	01240.160.055
M8X1,00X80	200	01240.080.080	M12X1,50X80/S=19	50	01240.120.080	M16X1,50X60	50	01240.160.060
M8X1,00X90	100	01240.080.090	M12X1,50X90/S=19	50	01240.120.090	M16X1,50X65	25	01240.160.065
			M12X1,50X100/S=19	50	01240.120.100	M16X1,50X70	25	01240.160.070
M10X1,25X40/S=17	100	01240.100.040				M16X1,50X75	25	01240.160.075
M10X1,25X50/S=17	100	01240.100.050	M14X1,50X50/S=22	50	01240.140.050	M16X1,50X80	25	01240.160.080
M10X1,25X60/S=17	100	01240.100.060	M14X1,50X55/S=22	50	01240.140.055	M16X1,50X90	25	01240.160.090
M10X1,25X70/S=17	100	01240.100.070	M14X1,50X60/S=22	50	01240.140.060	M16X1,50X100	25	01240.160.100
M10X1,25X80/S=17	100	01240.100.080	M14X1,50X65/S=22	50	01240.140.065	M16X1,50X110	25	01240.160.110
M10X1,25X90/S=17	100	01240.100.090	M14X1,50X70/S=22	50	01240.140.070	M16X1,50X120	25	01240.160.120
M10X1,25X100/S=17	100	01240.100.100	M14X1,50X75/S=22	50	01240.140.075	M16X1,50X130	25	01240.160.130
M10X1,25X110/S=17	100	01240.100.110	M14X1,50X80/S=22	50	01240.140.080	M16X1,50X140	25	01240.160.140
			M14X1,50X90/S=22	50	01240.140.090	M16X1,50X150	25	01240.160.150
M12X1,50X45/S=19	100	01240.120.045	M14X1,50X100/S=22	50	01240.140.100			

01241 Hexagon head bolt MEF A09A

Thread Metric extra fine thread
Material Steel
Class 8.8
Surface treatment Zinc plated yellow passivated

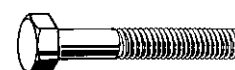

d x P x L	☒	Art.number	d x P x L	☒	Art.number	d x P x L	☒	Art.number
M10X1,00X40/S=17	100	01241.100.040	M12X1,25X45/S=19	100	01241.120.045	M18X1,50X60	25	01241.180.060
M10X1,00X45/S=17	100	01241.100.045	M12X1,25X50/S=19	100	01241.120.050	M18X1,50X70	25	01241.180.070
M10X1,00X50/S=17	100	01241.100.050	M12X1,25X60/S=19	100	01241.120.060	M18X1,50X80	25	01241.180.080
M10X1,00X60/S=17	100	01241.100.060	M12X1,25X70/S=19	50	01241.120.070	M18X1,50X90	25	01241.180.090
M10X1,00X70/S=17	100	01241.100.070	M12X1,25X80/S=19	50	01241.120.080	M18X1,50X100	25	01241.180.100
M10X1,00X80/S=17	100	01241.100.080	M12X1,25X90/S=19	50	01241.120.090	M18X1,50X110	25	01241.180.110
M10X1,00X90/S=17	100	01241.100.090	M12X1,25X100/S=19	50	01241.120.100	M18X1,50X120	25	01241.180.120
M10X1,00X100/S=17	100	01241.100.100	M12X1,25X110/S=19	50	01241.120.110			
						M20X1,50X70	25	01241.200.070

01241 Hexagon head bolt MEF								
d x P x L	☒	Art.number	d x P x L	☒	Art.number	d x P x L	☒	Art.number
M20X1,50X80	25	01241.200.080	M20X1,50X110	25	01241.200.110	M20X1,50X150	25	01241.200.150
M20X1,50X90	25	01241.200.090	M20X1,50X120	25	01241.200.120			
M20X1,50X100	25	01241.200.100	M20X1,50X140	25	01241.200.140			



04160 Hexagon head bolt MF		C02A
Thread	Metric fine thread	
Material	Steel	
Class	10.9	



d x P x L	☒	Art.number	d x P x L	☒	Art.number	d x P x L	☒	Art.number
M8X1,00X35	200	04160.080.035	M12X1,50X120/S=19	25	04160.120.120	M16X1,50X120	25	04160.160.120
M8X1,00X40	200	04160.080.040	M14X1,50X50/S=22	50	04160.140.050	M16X1,50X130	20	04160.160.130
M8X1,00X50	200	04160.080.050	M14X1,50X60/S=22	50	04160.140.060	M16X1,50X140	20	04160.160.140
M8X1,00X60	200	04160.080.060	M14X1,50X65/S=22	50	04160.140.065	M16X1,50X150	20	04160.160.150
M8X1,00X70	100	04160.080.070	M14X1,50X70/S=22	50	04160.140.070	M16X1,50X160	20	04160.160.160
M8X1,00X80	100	04160.080.080	M14X1,50X80/S=22	25	04160.140.080	M24X2,00X80	15	04160.240.080
M8X1,00X90	100	04160.080.090	M14X1,50X90/S=22	25	04160.140.090	M24X2,00X90	15	04160.240.090
M10X1,25X45/S=17	100	04160.100.045	M14X1,50X100/S=22	25	04160.140.100	M24X2,00X100	10	04160.240.100
M10X1,25X50/S=17	100	04160.100.050	M14X1,50X110/S=22	25	04160.140.110	M24X2,00X110	10	04160.240.110
M10X1,25X60/S=17	100	04160.100.060	M14X1,50X120/S=22	25	04160.140.120	M24X2,00X120	10	04160.240.120
M10X1,25X70/S=17	100	04160.100.070	M16X1,50X50	25	04160.160.050	M24X2,00X130	10	04160.240.130
M10X1,25X80/S=17	100	04160.100.080	M16X1,50X55	25	04160.160.055	M24X2,00X140	10	04160.240.140
M10X1,25X90/S=17	100	04160.100.090	M16X1,50X60	25	04160.160.060	M24X2,00X150	10	04160.240.150
M10X1,25X100/S=17	100	04160.100.100	M16X1,50X65	25	04160.160.065	M24X2,00X160	10	04160.240.160
M12X1,50X50/S=19	50	04160.120.050	M16X1,50X70	25	04160.160.070	M24X2,00X180	10	04160.240.180
M12X1,50X60/S=19	50	04160.120.060	M16X1,50X80	25	04160.160.080	M24X2,00X200	10	04160.240.200
M12X1,50X70/S=19	50	04160.120.070	M16X1,50X90	25	04160.160.090	M27X2,00X190	10	04160.270.190
M12X1,50X80/S=19	50	04160.120.080	M16X1,50X100	25	04160.160.100	M30X2,00X140	5	04160.300.140
M12X1,50X90/S=19	50	04160.120.090	M16X1,50X110	25	04160.160.110			
M12X1,50X100/S=19	50	04160.120.100						

• Warning: electro-galvanizing of these products may cause hydrogen embrittlement.

04161 Hexagon head bolt MEF		C02A
Thread	Metric extra fine thread	
Material	Steel	
Class	10.9	

d x P x L	☒	Art.number	d x P x L	☒	Art.number	d x P x L	☒	Art.number
M10X1,00X50/S=17	100	04161.100.050	M18X1,50X80	25	04161.180.080	M20X1,50X70	25	04161.200.070
M10X1,00X60/S=17	100	04161.100.060	M18X1,50X90	25	04161.180.090	M20X1,50X80	25	04161.200.080
M10X1,00X70/S=17	100	04161.100.070	M18X1,50X100	25	04161.180.100	M20X1,50X90	25	04161.200.090
M10X1,00X80/S=17	100	04161.100.080	M18X1,50X110	15	04161.180.110	M20X1,50X100	25	04161.200.100
M10X1,00X90/S=17	50	04161.100.090	M18X1,50X120	15	04161.180.120	M20X1,50X110	10	04161.200.110
M10X1,00X100/S=17	50	04161.100.100	M18X1,50X130	15	04161.180.130	M20X1,50X120	10	04161.200.120
M18X1,50X60	25	04161.180.060	M18X1,50X140	10	04161.180.140	M20X1,50X130	10	04161.200.130
M18X1,50X70	25	04161.180.070	M18X1,50X150	10	04161.180.150	M20X1,50X140	10	04161.200.140
M18X1,50X75	25	04161.180.075	M18X1,50X160	10	04161.180.160	M20X1,50X150	10	04161.200.150
						M20X1,50X160	10	04161.200.160

• Warning: electro-galvanizing of these products may cause hydrogen embrittlement.

Hexagon head screw MF

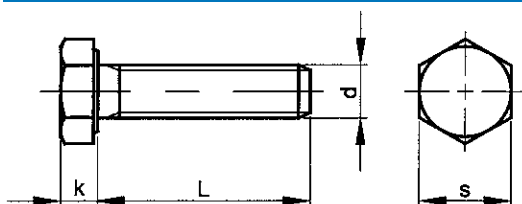

ISO 8676
DIN 961
NEN 1568
NF E25-151

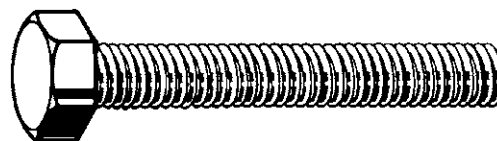

Technical Data

d	k	s	d	k	s
M8	5.3	13	M18	11.5	27
M10 (DIN)	6.4	17	M20	12.5	30
M12 (DIN)	7.5	19	M22 (DIN)	14	32
M14 (DIN)	8.8	22	M24	15	36
M16	10	24			

Article groups

Thread	Driving features	Material	Class	Surface treatment	Code	Page
MF	Hexagon	St	8.8		01070	1-39
MEF	Hexagon	St	8.8		01071	1-39
MF	Hexagon	St	8.8	Zipl yell.p.	01250	1-40
MEF	Hexagon	St	8.8	Zipl yell.p.	01251	1-40
MF	Hexagon	St	10.9		04170	1-40
MEF	Hexagon	St	10.9		04171	1-41

01070 Hexagon head screw MF

A09A

Thread Metric fine thread
Material Steel
Class 8.8



d x P x L	Art.number	d x P x L	Art.number	d x P x L	Art.number
M8X1,00X16	200 01070.080.016	M12X1,50X20/S=19	100 01070.120.020	M14X1,50X45/S=22	50 01070.140.045
M8X1,00X20	200 01070.080.020	M12X1,50X25/S=19	100 01070.120.025	M14X1,50X50/S=22	50 01070.140.050
M8X1,00X25	200 01070.080.025	M12X1,50X30/S=19	100 01070.120.030	M14X1,50X60/S=22	50 01070.140.060
M8X1,00X30	200 01070.080.030	M12X1,50X35/S=19	100 01070.120.035	M16X1,50X20	50 01070.160.020
M8X1,00X35	200 01070.080.035	M12X1,50X40/S=19	100 01070.120.040	M16X1,50X25	50 01070.160.025
M8X1,00X40	200 01070.080.040	M12X1,50X45/S=19	100 01070.120.045	M16X1,50X30	50 01070.160.030
M10X1,25X20/S=17	200 01070.100.020	M12X1,50X50/S=19	100 01070.120.050	M16X1,50X35	50 01070.160.035
M10X1,25X25/S=17	200 01070.100.025	M12X1,50X60/S=19	100 01070.120.060	M16X1,50X40	50 01070.160.040
M10X1,25X30/S=17	200 01070.100.030	M14X1,50X20/S=22	100 01070.140.020	M16X1,50X45	50 01070.160.045
M10X1,25X35/S=17	100 01070.100.035	M14X1,50X25/S=22	100 01070.140.025	M16X1,50X50	50 01070.160.050
M10X1,25X40/S=17	100 01070.100.040	M14X1,50X30/S=22	100 01070.140.030	M16X1,50X60	50 01070.160.060
M10X1,25X45/S=17	100 01070.100.045	M14X1,50X35/S=22	100 01070.140.035	M16X1,50X70	25 01070.160.070
M10X1,25X50/S=17	100 01070.100.050	M14X1,50X40/S=22	100 01070.140.040	M16X1,50X80	25 01070.160.080
M10X1,25X60/S=17	100 01070.100.060			M16X1,50X120	25 01070.160.120

01071 Hexagon head screw MEF

A09A

Thread Metric extra fine thread
Material Steel
Class 8.8



d x P x L	Art.number	d x P x L	Art.number	d x P x L	Art.number
M10X1,00X20/S=17	200 01071.100.020	M12X1,25X40/S=19	100 01071.120.040	M18X1,50X80	25 01071.180.080
M10X1,00X25/S=17	200 01071.100.025	M12X1,25X50/S=19	100 01071.120.050	M20X1,50X40	25 01071.200.040
M10X1,00X30/S=17	200 01071.100.030	M18X1,50X35	50 01071.180.035	M20X1,50X45	25 01071.200.045
M10X1,00X35/S=17	100 01071.100.035	M18X1,50X40	50 01071.180.040	M20X1,50X50	25 01071.200.050
M10X1,00X40/S=17	100 01071.100.040	M18X1,50X45	50 01071.180.045	M20X1,50X60	25 01071.200.060
M12X1,25X25/S=19	100 01071.120.025	M18X1,50X50	50 01071.180.050	M20X1,50X70	25 01071.200.070
M12X1,25X30/S=19	100 01071.120.030	M18X1,50X60	25 01071.180.060	M20X1,50X80	25 01071.200.080
M12X1,25X35/S=19	100 01071.120.035	M18X1,50X70	25 01071.180.070		

01250 Hexagon head screw MF		A09A
Thread	Metric fine thread	
Material	Steel	
Class	8.8	
Surface treatment	Zinc plated yellow passivated	

d x P x L	☒	Art.number	d x P x L	☒	Art.number	d x P x L	☒	Art.number
M8X1,00X20	200	01250.080.020	M12X1,50X20/S=19	100	01250.120.020	M14X1,50X45/S=22	50	01250.140.045
M8X1,00X25	200	01250.080.025	M12X1,50X25/S=19	100	01250.120.025	M14X1,50X50/S=22	50	01250.140.050
M8X1,00X30	200	01250.080.030	M12X1,50X30/S=19	100	01250.120.030	M14X1,50X60/S=22	50	01250.140.060
M8X1,00X35	200	01250.080.035	M12X1,50X35/S=19	100	01250.120.035			
M8X1,00X40	200	01250.080.040	M12X1,50X40/S=19	100	01250.120.040	M16X1,50X20	50	01250.160.020
			M12X1,50X45/S=19	100	01250.120.045	M16X1,50X25	50	01250.160.025
M10X1,25X20/S=17	200	01250.100.020	M12X1,50X50/S=19	100	01250.120.050	M16X1,50X30	50	01250.160.030
M10X1,25X25/S=17	200	01250.100.025	M12X1,50X60/S=19	100	01250.120.060	M16X1,50X35	50	01250.160.035
M10X1,25X30/S=17	200	01250.100.030				M16X1,50X40	50	01250.160.040
M10X1,25X35/S=17	100	01250.100.035	M14X1,50X20/S=22	100	01250.140.020	M16X1,50X45	50	01250.160.045
M10X1,25X40/S=17	100	01250.100.040	M14X1,50X25/S=22	100	01250.140.025	M16X1,50X50	50	01250.160.050
M10X1,25X45/S=17	100	01250.100.045	M14X1,50X30/S=22	100	01250.140.030	M16X1,50X60	50	01250.160.060
M10X1,25X50/S=17	100	01250.100.050	M14X1,50X35/S=22	100	01250.140.035	M16X1,50X70	25	01250.160.070
			M14X1,50X40/S=22	100	01250.140.040			

01251 Hexagon head screw MEF		A09A
Thread	Metric extra fine thread	
Material	Steel	
Class	8.8	
Surface treatment	Zinc plated yellow passivated	

d x P x L	☒	Art.number	d x P x L	☒	Art.number	d x P x L	☒	Art.number
M10X1,00X20/S=17	200	01251.100.020	M12X1,25X40/S=19	100	01251.120.040	M18X1,50X70	25	01251.180.070
M10X1,00X25/S=17	200	01251.100.025	M12X1,25X45/S=19	100	01251.120.045	M18X1,50X80	25	01251.180.080
M10X1,00X30/S=17	200	01251.100.030	M12X1,25X50/S=19	100	01251.120.050			
M10X1,00X35/S=17	100	01251.100.035				M20X1,50X40	25	01251.200.040
M10X1,00X40/S=17	100	01251.100.040	M18X1,50X35	50	01251.180.035	M20X1,50X50	25	01251.200.050
			M18X1,50X40	50	01251.180.040	M20X1,50X60	25	01251.200.060
M12X1,25X25/S=19	100	01251.120.025	M18X1,50X45	50	01251.180.045	M20X1,50X70	25	01251.200.070
M12X1,25X30/S=19	100	01251.120.030	M18X1,50X50	50	01251.180.050	M20X1,50X80	25	01251.200.080
M12X1,25X35/S=19	100	01251.120.035	M18X1,50X60	25	01251.180.060			

04170 Hexagon head screw MF		C02A
Thread	Metric fine thread	
Material	Steel	
Class	10.9	



d x P x L	☒	Art.number	d x P x L	☒	Art.number	d x P x L	☒	Art.number
M8X1,00X20	200	04170.080.020	M12X1,50X25/S=19	100	04170.120.025	M16X1,50X30	50	04170.160.030
M8X1,00X25	200	04170.080.025	M12X1,50X30/S=19	100	04170.120.030	M16X1,50X35	50	04170.160.035
M8X1,00X30	200	04170.080.030	M12X1,50X35/S=19	100	04170.120.035	M16X1,50X40	50	04170.160.040
M8X1,00X35	200	04170.080.035	M12X1,50X40/S=19	100	04170.120.040	M16X1,50X45	50	04170.160.045
M8X1,00X40	200	04170.080.040				M16X1,50X50	25	04170.160.050
			M14X1,50X25/S=22	50	04170.140.025	M16X1,50X55	25	04170.160.055
M10X1,25X20/S=17	200	04170.100.020	M14X1,50X30/S=22	50	04170.140.030	M16X1,50X60	25	04170.160.060
M10X1,25X25/S=17	200	04170.100.025	M14X1,50X35/S=22	50	04170.140.035			
M10X1,25X30/S=17	100	04170.100.030	M14X1,50X40/S=22	50	04170.140.040	M24X2,00X45	25	04170.240.045
M10X1,25X35/S=17	100	04170.100.035	M14X1,50X45/S=22	50	04170.140.045	M24X2,00X50	25	04170.240.050
M10X1,25X40/S=17	100	04170.100.040	M14X1,50X50/S=22	50	04170.140.050	M24X2,00X60	25	04170.240.060
			M14X1,50X60/S=22	50	04170.140.060	M24X2,00X70	25	04170.240.070

• Warning: electro-galvanizing of these products may cause hydrogen embrittlement.

04171 Hexagon head screw MEF		C02A
Thread	Metric extra fine thread	
Material	Steel	
Class	10.9	
		 

d x P x L	☒	Art.number	d x P x L	☒	Art.number	d x P x L	☒	Art.number
M10X1,00X20/S=17	100	04171.100.020	M12X1,25X30/S=19	50	04171.120.030	M18X1,50X60	25	04171.180.060
M10X1,00X25/S=17	100	04171.100.025	M12X1,25X35/S=19	50	04171.120.035	M20X1,50X40	25	04171.200.040
M10X1,00X30/S=17	100	04171.100.030	M12X1,25X40/S=19	50	04171.120.040	M20X1,50X45	25	04171.200.045
M10X1,00X35/S=17	100	04171.100.035	M18X1,50X40	25	04171.180.040	M20X1,50X50	25	04171.200.050
M10X1,00X40/S=17	100	04171.100.040	M18X1,50X50	25	04171.180.050	M20X1,50X60	25	04171.200.060
M12X1,25X25/S=19	50	04171.120.025						

• Warning: electro-galvanizing of these products may cause hydrogen embrittlement.

Hexagon head bolt UNC

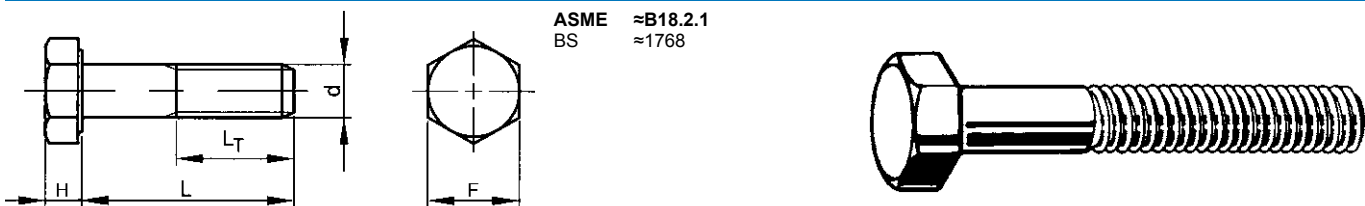

ASME ≈B18.2.1
BS ≈1768

Technical Data					
d	L _T (min.): L≤6 Inch	L _T (min.): L>6 Inch	F	H	Threads per inch
1/4	0.75	1	7/16	5/32	20
5/16	0.875	1.125	1/2	13/64	18
3/8	1	1.25	9/16	15/64	16
7/16	1.125	1.375	5/8	9/32	14
1/2	1.25	1.5	3/4	5/16	13
9/16	1.375	1.625	13/16	23/64	12
5/8	1.5	1.75	15/16	25/64	11
3/4	1.75	2	1.1/8	15/32	10
7/8	2	2.25	1.5/16	35/64	9
1 Inch	2.25	2.5	1.1/2	39/64	8
1.1/8	2.5	2.75	1.11/16	11/16	7
1.1/4	2.75	3	1.7/8	25/32	7
1.1/2	3.25	3.5	2.1/4	15/16	6

Article groups						
Thread	Driving features	Material	Class	Surface treatment	Code	Page
UNC	Hexagon	St	Grade 2		U08200	1-41
UNC	Hexagon	St	Grade 2	Zipl	U08210	1-42
UNC	Hexagon	St	Grade 5		U01000	1-43
UNC	Hexagon	St	Grade 5	Zipl	U01200	1-44
UNC	Hexagon	St	Grade 8		U04104	1-46
UNC	Hexagon	St	Grade 8	Zipl yell.p.	U04100	1-47
UNC	Hexagon	St.St. A2 (AISI304/18-8)	F593		U51000	1-49
UNC	Hexagon	St.St. A4 (AISI316/18-10)	F593		U55000	1-50

U08200 Hexagon head bolt UNC		X01A
Thread	Unified National Coarse	
Material	Steel	
Class	Grade 2	
		 

d x L	☒	Art.number	d x L	☒	Art.number	d x L	☒	Art.number
1/2-13X3/4 ft *	25	U08200.050.0075	1/2-13X2.1/4 *	10	U08200.050.0225	1/2-13X3.3/4 *	10	U08200.050.0375
1/2-13X1 Inch ft *	25	U08200.050.0100	1/2-13X2.1/2 *	10	U08200.050.0250	1/2-13X4 Inch *	5	U08200.050.0400
1/2-13X1.1/4 ft *	25	U08200.050.0125	1/2-13X2.3/4 *	10	U08200.050.0275	1/2-13X4.1/2 *	5	U08200.050.0450
1/2-13X1.1/2 *	25	U08200.050.0150	1/2-13X3 Inch *	10	U08200.050.0300	1/2-13X5 Inch *	5	U08200.050.0500
1/2-13X1.3/4 *	25	U08200.050.0175	1/2-13X3.1/4 *	10	U08200.050.0325	1/2-13X5.1/2 *	5	U08200.050.0550
1/2-13X2 Inch *	10	U08200.050.0200	1/2-13X3.1/2 *	10	U08200.050.0350	1/2-13X6 Inch *	5	U08200.050.0600

U08200 Hexagon head bolt UNC ←

d x L	☒	Art.number	d x L	☒	Art.number	d x L	☒	Art.number
1/2-13X7 Inch *	5	U08200.050.0700	3/4-10X6 Inch *	5	U08200.075.0600	5/16-18X4 Inch *	25	U08200.031.0400
1/4-20X1/2 ft *	100	U08200.025.0050	3/8-16X1/2 ft *	50	U08200.037.0050	5/16-18X4.1/2 *	25	U08200.031.0450
1/4-20X5/8 ft *	100	U08200.025.0062	3/8-16X5/8 ft *	50	U08200.037.0062	5/16-18X5 Inch *	25	U08200.031.0500
1/4-20X3/4 ft *	100	U08200.025.0075	3/8-16X3/4 ft *	50	U08200.037.0075	5/16-18X5.1/2 *	25	U08200.031.0550
1/4-20X7/8 *	100	U08200.025.0087	3/8-16X7/8 ft *	50	U08200.037.0087	5/16-18X6 Inch *	25	U08200.031.0600
1/4-20X1 Inch *	100	U08200.025.0100	3/8-16X1 Inch ft *	50	U08200.037.0100	5/8-11X1 Inch ft *	10	U08200.062.0100
1/4-20X1.1/4 *	100	U08200.025.0125	3/8-16X1.1/4 *	50	U08200.037.0125	5/8-11X1.1/4 ft *	10	U08200.062.0125
1/4-20X1.1/2 *	100	U08200.025.0150	3/8-16X1.1/2 *	50	U08200.037.0150	5/8-11X1.1/2 ft *	10	U08200.062.0150
1/4-20X1.3/4 *	100	U08200.025.0175	3/8-16X1.3/4 *	50	U08200.037.0175	5/8-11X1.3/4 *	10	U08200.062.0175
1/4-20X2 Inch *	50	U08200.025.0200	3/8-16X2 Inch *	25	U08200.037.0200	5/8-11X2 Inch *	5	U08200.062.0200
1/4-20X2.1/4 *	50	U08200.025.0225	3/8-16X2.1/4 *	25	U08200.037.0225	5/8-11X2.1/4 *	5	U08200.062.0225
1/4-20X2.1/2 *	50	U08200.025.0250	3/8-16X2.1/2 *	25	U08200.037.0250	5/8-11X2.1/2 *	5	U08200.062.0250
1/4-20X2.3/4 *	50	U08200.025.0275	3/8-16X2.3/4 *	25	U08200.037.0275	5/8-11X2.3/4 *	5	U08200.062.0275
1/4-20X3 Inch *	50	U08200.025.0300	3/8-16X3 Inch *	25	U08200.037.0300	5/8-11X3 Inch *	5	U08200.062.0300
1/4-20X3.1/4 *	50	U08200.025.0325	3/8-16X3.1/4 *	25	U08200.037.0325	5/8-11X3.1/4 *	5	U08200.062.0325
1/4-20X3.1/2 *	50	U08200.025.0350	3/8-16X3.1/2 *	25	U08200.037.0350	5/8-11X3.1/2 *	5	U08200.062.0350
1/4-20X3.3/4 *	50	U08200.025.0375	3/8-16X3.3/4 *	25	U08200.037.0375	5/8-11X3.3/4 *	5	U08200.062.0375
1/4-20X4 Inch *	25	U08200.025.0400	3/8-16X4 Inch *	10	U08200.037.0400	5/8-11X4 Inch *	5	U08200.062.0400
1/4-20X4.1/2 *	25	U08200.025.0450	3/8-16X4.1/2 *	10	U08200.037.0450	5/8-11X4.1/2 *	5	U08200.062.0450
1/4-20X5 Inch *	25	U08200.025.0500	3/8-16X5 Inch *	10	U08200.037.0500	5/8-11X5 Inch *	5	U08200.062.0500
1/4-20X5.1/2 *	25	U08200.025.0550	3/8-16X5.1/2 *	10	U08200.037.0550	5/8-11X5.1/2 *	5	U08200.062.0550
1/4-20X6 Inch *	25	U08200.025.0600	3/8-16X6 Inch *	10	U08200.037.0600	5/8-11X6 Inch *	5	U08200.062.0600
3/4-10X1 Inch ft *	10	U08200.075.0100	5/16-18X1/2 ft *	100	U08200.031.0050	7/16-14X1 Inch ft *	25	U08200.043.0100
3/4-10X1.1/4 ft *	10	U08200.075.0125	5/16-18X5/8 ft *	100	U08200.031.0062	7/16-14X1.1/4 *	25	U08200.043.0125
3/4-10X1.1/2 ft *	10	U08200.075.0150	5/16-18X3/4 ft *	100	U08200.031.0075	7/16-14X1.1/2 *	25	U08200.043.0150
3/4-10X1.3/4 ft *	10	U08200.075.0175	5/16-18X7/8 ft *	100	U08200.031.0087	7/16-14X1.3/4 *	25	U08200.043.0175
3/4-10X2 Inch *	5	U08200.075.0200	5/16-18X1 Inch *	100	U08200.031.0100	7/16-14X2 Inch *	25	U08200.043.0200
3/4-10X2.1/4 *	5	U08200.075.0225	5/16-18X1.1/4 *	100	U08200.031.0125	7/16-14X2.1/4 *	10	U08200.043.0225
3/4-10X2.1/2 *	5	U08200.075.0250	5/16-18X1.1/2 *	100	U08200.031.0150	7/16-14X2.1/2 *	10	U08200.043.0250
3/4-10X2.3/4 *	5	U08200.075.0275	5/16-18X1.3/4 *	50	U08200.031.0175	7/16-14X2.3/4 *	10	U08200.043.0275
3/4-10X3 Inch *	5	U08200.075.0300	5/16-18X2 Inch *	50	U08200.031.0200	7/16-14X3 Inch *	10	U08200.043.0300
3/4-10X3.1/4 *	5	U08200.075.0325	5/16-18X2.1/4 *	50	U08200.031.0225	7/16-14X3.1/4 *	10	U08200.043.0325
3/4-10X3.1/2 *	5	U08200.075.0350	5/16-18X2.1/2 *	50	U08200.031.0250	7/16-14X3.1/2 *	10	U08200.043.0350
3/4-10X3.3/4 *	5	U08200.075.0375	5/16-18X2.3/4 *	50	U08200.031.0275	7/16-14X3.3/4 *	10	U08200.043.0375
3/4-10X4 Inch *	5	U08200.075.0400	5/16-18X3 Inch *	50	U08200.031.0300	7/16-14X4 Inch *	10	U08200.043.0400
3/4-10X4.1/2 *	5	U08200.075.0450	5/16-18X3.1/4 *	50	U08200.031.0325	7/16-14X4.1/2 *	10	U08200.043.0450
3/4-10X5 Inch *	5	U08200.075.0500	5/16-18X3.1/2 *	50	U08200.031.0350	7/16-14X5 Inch *	10	U08200.043.0500
3/4-10X5.1/2 *	5	U08200.075.0550	5/16-18X3.3/4 *	25	U08200.031.0375	7/16-14X5.1/2 *	10	U08200.043.0550
						7/16-14X6 Inch *	5	U08200.043.0600

• ft = fully threaded

U08210 Hexagon head bolt UNC X01A

Thread Unified National Coarse
Material Steel
Class Grade 2
Surface treatment Zinc plated

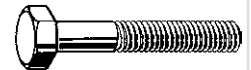

d x L	☒	Art.number	d x L	☒	Art.number	d x L	☒	Art.number
1/4-20X1/2 ft *	100	U08210.025.0050	5/16-18X1.3/4*	50	U08210.031.0175	3/8-16X3.1/2*	25	U08210.037.0350
1/4-20X5/8 ft *	100	U08210.025.0062	5/16-18X2 Inch*	50	U08210.031.0200	3/8-16X3.3/4*	25	U08210.037.0375
1/4-20X3/4 ft *	100	U08210.025.0075	5/16-18X2.1/4 *	50	U08210.031.0225	3/8-16X4 Inch*	10	U08210.037.0400
1/4-20X7/8 *	100	U08210.025.0087	5/16-18X2.1/2 *	50	U08210.031.0250	3/8-16X4.1/2*	10	U08210.037.0450
1/4-20X1 Inch*	100	U08210.025.0100	5/16-18X2.3/4 *	50	U08210.031.0275	3/8-16X5 Inch*	10	U08210.037.0500
1/4-20X1.1/4*	100	U08210.025.0125	5/16-18X3 Inch*	50	U08210.031.0300	3/8-16X5.1/2*	10	U08210.037.0550
1/4-20X1.1/2*	100	U08210.025.0150	5/16-18X3.1/4*	50	U08210.031.0325	3/8-16X6 Inch*	10	U08210.037.0600
1/4-20X1.3/4*	100	U08210.025.0175	5/16-18X3.1/2*	50	U08210.031.0350			
1/4-20X2 Inch*	50	U08210.025.0200	5/16-18X3.3/4*	25	U08210.031.0375	7/16-14X3/4 ft*	25	U08210.043.0075
1/4-20X2.1/4*	50	U08210.025.0225	5/16-18X4 Inch*	25	U08210.031.0400	7/16-14X1 Inch ft*	25	U08210.043.0100
1/4-20X2.1/2*	50	U08210.025.0250	5/16-18X4.1/2*	25	U08210.031.0450	7/16-14X1.1/4*	25	U08210.043.0125
1/4-20X2.3/4*	50	U08210.025.0275	5/16-18X5 Inch*	25	U08210.031.0500	7/16-14X1.1/2*	25	U08210.043.0150
1/4-20X3 Inch*	50	U08210.025.0300	5/16-18X5.1/2*	25	U08210.031.0550	7/16-14X1.3/4*	25	U08210.043.0175
1/4-20X3.1/4*	50	U08210.025.0325	5/16-18X6 Inch*	25	U08210.031.0600	7/16-14X2 Inch*	25	U08210.043.0200
1/4-20X3.1/2*	50	U08210.025.0350				7/16-14X2.1/4*	10	U08210.043.0225
1/4-20X3.3/4*	50	U08210.025.0375	3/8-16X1/2 ft*	50	U08210.037.0050	7/16-14X2.1/2*	10	U08210.043.0250
1/4-20X4 Inch*	25	U08210.025.0400	3/8-16X5/8 ft*	50	U08210.037.0062	7/16-14X2.3/4*	10	U08210.043.0275
1/4-20X4.1/2*	25	U08210.025.0450	3/8-16X3/4 ft*	50	U08210.037.0075	7/16-14X3 Inch*	10	U08210.043.0300
1/4-20X5 Inch*	25	U08210.025.0500	3/8-16X7/8 ft*	50	U08210.037.0087	7/16-14X3.1/2*	10	U08210.043.0350
1/4-20X5.1/2*	25	U08210.025.0550	3/8-16X1 Inch ft*	50	U08210.037.0100	7/16-14X4 Inch*	10	U08210.043.0400
1/4-20X6 Inch*	25	U08210.025.0600	3/8-16X1.1/4*	50	U08210.037.0125	7/16-14X4.1/2*	10	U08210.043.0450
			3/8-16X1.1/2*	50	U08210.037.0150	7/16-14X5 Inch*	10	U08210.043.0500
5/16-18X1/2 ft*	100	U08210.031.0050	3/8-16X1.3/4*	50	U08210.037.0175	7/16-14X5.1/2*	10	U08210.043.0550
5/16-18X5/8 ft*	100	U08210.031.0062	3/8-16X2 Inch*	25	U08210.037.0200	7/16-14X6 Inch*	5	U08210.043.0600
5/16-18X3/4 ft*	100	U08210.031.0075	3/8-16X2.1/4*	25	U08210.037.0225			
5/16-18X7/8 ft*	100	U08210.031.0087	3/8-16X2.1/2*	25	U08210.037.0250	1/2-13X3/4 ft*	25	U08210.050.0075
5/16-18X1 Inch*	100	U08210.031.0100	3/8-16X2.3/4*	25	U08210.037.0275	1/2-13X1 Inch ft*	25	U08210.050.0100
5/16-18X1.1/4*	100	U08210.031.0125	3/8-16X3 Inch*	25	U08210.037.0300	1/2-13X1.1/4 ft*	25	U08210.050.0125
5/16-18X1.1/2*	100	U08210.031.0150	3/8-16X3.1/4*	25	U08210.037.0325	1/2-13X1.1/2*	25	U08210.050.0150

U08210 Hexagon head bolt UNC								
d x L	☒	Art.number	d x L	☒	Art.number	d x L	☒	Art.number
1/2-13X1.3/4*	25	U08210.050.0175	5/8-11X1.1/2 ft*	10	U08210.062.0150	3/4-10X1.1/4 ft*	10	U08210.075.0125
1/2-13X2 Inch*	10	U08210.050.0200	5/8-11X1.3/4*	10	U08210.062.0175	3/4-10X1.1/2 ft*	10	U08210.075.0150
1/2-13X2.1/4*	10	U08210.050.0225	5/8-11X2 Inch*	5	U08210.062.0200	3/4-10X1.3/4 ft*	10	U08210.075.0175
1/2-13X2.1/2*	10	U08210.050.0250	5/8-11X2.1/4*	5	U08210.062.0225	3/4-10X2 Inch*	5	U08210.075.0200
1/2-13X2.3/4*	10	U08210.050.0275	5/8-11X2.1/2*	5	U08210.062.0250	3/4-10X2.1/4*	5	U08210.075.0225
1/2-13X3 Inch*	10	U08210.050.0300	5/8-11X2.3/4*	5	U08210.062.0275	3/4-10X2.1/2*	5	U08210.075.0250
1/2-13X3.1/4*	10	U08210.050.0325	5/8-11X3 Inch*	5	U08210.062.0300	3/4-10X2.3/4*	5	U08210.075.0275
1/2-13X3.1/2*	10	U08210.050.0350	5/8-11X3.1/4*	5	U08210.062.0325	3/4-10X3 Inch*	5	U08210.075.0300
1/2-13X3.3/4*	10	U08210.050.0375	5/8-11X3.1/2*	5	U08210.062.0350	3/4-10X3.1/4*	5	U08210.075.0325
1/2-13X4 Inch*	5	U08210.050.0400	5/8-11X3.3/4*	5	U08210.062.0375	3/4-10X3.1/2*	5	U08210.075.0350
1/2-13X4.1/2*	5	U08210.050.0450	5/8-11X4 Inch*	5	U08210.062.0400	3/4-10X3.3/4*	5	U08210.075.0375
1/2-13X5 Inch*	5	U08210.050.0500	5/8-11X4.1/2*	5	U08210.062.0450	3/4-10X4 Inch*	5	U08210.075.0400
1/2-13X5.1/2*	5	U08210.050.0550	5/8-11X5 Inch*	5	U08210.062.0500	3/4-10X4.1/2*	5	U08210.075.0450
1/2-13X6 Inch*	5	U08210.050.0600	5/8-11X5.1/2*	5	U08210.062.0550	3/4-10X5 Inch*	5	U08210.075.0500
			5/8-11X6 Inch*	5	U08210.062.0600	3/4-10X5.1/2*	5	U08210.075.0550
5/8-11X1 Inch ft*	10	U08210.062.0100				3/4-10X6 Inch*	5	U08210.075.0600
5/8-11X1.1/4 ft*	10	U08210.062.0125	3/4-10X1 Inch ft*	10	U08210.075.0100			

* ft = fully threaded

U01000 Hexagon head bolt UNC		X01A
Thread	Unified National Coarse	
Material	Steel	
Class	Grade 5	





d x L	☒	Art.number	d x L	☒	Art.number	d x L	☒	Art.number
1/4-20X1/2 ft*	100	U01000.025.0050	3/8-16X1/2 ft*	50	U01000.037.0050	7/16-14X7 Inch*	5	U01000.043.0700
1/4-20X5/8 ft*	100	U01000.025.0062	3/8-16X5/8 ft*	50	U01000.037.0062	7/16-14X8 Inch*	5	U01000.043.0800
1/4-20X3/4 ft*	100	U01000.025.0075	3/8-16X3/4 ft*	50	U01000.037.0075	7/16-14X9 Inch*	5	U01000.043.0900
1/4-20X7/8*	100	U01000.025.0087	3/8-16X7/8 ft*	50	U01000.037.0087	7/16-14X10 Inch*	5	U01000.043.1000
1/4-20X1 Inch*	100	U01000.025.0100	3/8-16X1 Inch ft*	50	U01000.037.0100	7/16-14X12 Inch*	5	U01000.043.1200
1/4-20X1.1/4*	100	U01000.025.0125	3/8-16X1.1/4*	50	U01000.037.0125			
1/4-20X1.3/8*	100	U01000.025.0137	3/8-16X1.1/2*	50	U01000.037.0150	1/2-13X3/4 ft*	25	U01000.050.0075
1/4-20X1.1/2*	100	U01000.025.0150	3/8-16X1.3/4*	50	U01000.037.0175	1/2-13X7/8 ft*	25	U01000.050.0087
1/4-20X1.5/8*	100	U01000.025.0162	3/8-16X2 Inch*	25	U01000.037.0200	1/2-13X1 Inch ft*	25	U01000.050.0100
1/4-20X1.3/4*	100	U01000.025.0175	3/8-16X2.1/4*	25	U01000.037.0225	1/2-13X1.1/4 ft*	25	U01000.050.0125
1/4-20X2 Inch*	50	U01000.025.0200	3/8-16X2.1/2*	25	U01000.037.0250	1/2-13X1.1/2*	25	U01000.050.0150
1/4-20X2.1/4*	50	U01000.025.0225	3/8-16X2.3/4*	25	U01000.037.0275	1/2-13X1.3/4*	25	U01000.050.0175
1/4-20X2.1/2*	50	U01000.025.0250	3/8-16X3 Inch*	25	U01000.037.0300	1/2-13X2 Inch*	10	U01000.050.0200
1/4-20X2.3/4*	50	U01000.025.0275	3/8-16X3.1/4*	25	U01000.037.0325	1/2-13X2.1/4*	10	U01000.050.0225
1/4-20X3 Inch*	50	U01000.025.0300	3/8-16X3.1/2*	25	U01000.037.0350	1/2-13X2.1/2*	10	U01000.050.0250
1/4-20X3.1/4*	50	U01000.025.0325	3/8-16X3.3/4*	25	U01000.037.0375	1/2-13X2.3/4*	10	U01000.050.0275
1/4-20X3.1/2*	50	U01000.025.0350	3/8-16X4 Inch*	10	U01000.037.0400	1/2-13X3 Inch*	10	U01000.050.0300
1/4-20X3.3/4*	50	U01000.025.0375	3/8-16X4.1/4*	10	U01000.037.0425	1/2-13X3.1/4*	10	U01000.050.0325
1/4-20X4 Inch*	25	U01000.025.0400	3/8-16X4.1/2*	10	U01000.037.0450	1/2-13X3.1/2*	10	U01000.050.0350
1/4-20X4.1/4*	25	U01000.025.0425	3/8-16X4.3/4*	10	U01000.037.0475	1/2-13X3.3/4*	10	U01000.050.0375
1/4-20X4.1/2*	25	U01000.025.0450	3/8-16X5 Inch*	10	U01000.037.0500	1/2-13X4 Inch*	5	U01000.050.0400
1/4-20X5 Inch*	25	U01000.025.0500	3/8-16X5.1/2*	10	U01000.037.0550	1/2-13X4.1/4*	5	U01000.050.0425
1/4-20X5.1/2*	25	U01000.025.0550	3/8-16X5.3/4*	10	U01000.037.0575	1/2-13X4.1/2*	5	U01000.050.0450
1/4-20X6 Inch*	25	U01000.025.0600	3/8-16X6 Inch*	10	U01000.037.0600	1/2-13X4.3/4*	5	U01000.050.0475
			3/8-16X6.1/2*	10	U01000.037.0650	1/2-13X5 Inch*	5	U01000.050.0500
5/16-18X1/2 ft*	100	U01000.031.0050	3/8-16X7 Inch*	10	U01000.037.0700	1/2-13X5.1/4*	5	U01000.050.0525
5/16-18X5/8 ft*	100	U01000.031.0062	3/8-16X8 Inch*	5	U01000.037.0800	1/2-13X5.1/2*	5	U01000.050.0550
5/16-18X3/4 ft*	100	U01000.031.0075	3/8-16X8.1/2*	5	U01000.037.0850	1/2-13X6 Inch*	5	U01000.050.0600
5/16-18X7/8 ft*	100	U01000.031.0087	3/8-16X9 Inch*	5	U01000.037.0900	1/2-13X6.1/2*	5	U01000.050.0650
5/16-18X1 Inch*	100	U01000.031.0100	3/8-16X10 Inch*	5	U01000.037.1000	1/2-13X7 Inch*	5	U01000.050.0700
5/16-18X1.1/4*	100	U01000.031.0125	3/8-16X12 Inch*	5	U01000.037.1200	1/2-13X7.1/2*	5	U01000.050.0750
5/16-18X1.3/8*	100	U01000.031.0137				1/2-13X8 Inch*	5	U01000.050.0800
5/16-18X1.1/2*	100	U01000.031.0150	7/16-14X3/4 ft*	25	U01000.043.0075	1/2-13X8.1/2*	5	U01000.050.0850
5/16-18X1.5/8*	100	U01000.031.0162	7/16-14X7/8 ft*	25	U01000.043.0087	1/2-13X9 Inch*	5	U01000.050.0900
5/16-18X1.3/4*	50	U01000.031.0175	7/16-14X1 Inch ft*	25	U01000.043.0100	1/2-13X9.1/2*	5	U01000.050.0950
5/16-18X2 Inch*	50	U01000.031.0200	7/16-14X1.1/4*	25	U01000.043.0125	1/2-13X10 Inch*	5	U01000.050.1000
5/16-18X2.1/4*	50	U01000.031.0225	7/16-14X1.1/2*	25	U01000.043.0150	1/2-13X11 Inch*	5	U01000.050.1100
5/16-18X2.1/2*	50	U01000.031.0250	7/16-14X1.3/4*	25	U01000.043.0175	1/2-13X12 Inch*	5	U01000.050.1200
5/16-18X2.3/4*	50	U01000.031.0275	7/16-14X2 Inch*	25	U01000.043.0200			
5/16-18X3 Inch*	50	U01000.031.0300	7/16-14X2.1/4*	10	U01000.043.0225	9/16-12X1 Inch ft*	25	U01000.056.0100
5/16-18X3.1/4*	50	U01000.031.0325	7/16-14X2.1/2*	10	U01000.043.0250	9/16-12X1.1/4 ft*	25	U01000.056.0125
5/16-18X3.1/2*	50	U01000.031.0350	7/16-14X2.3/4*	10	U01000.043.0275	9/16-12X1.1/2*	25	U01000.056.0150
5/16-18X3.3/4*	25	U01000.031.0375	7/16-14X3 Inch*	10	U01000.043.0300	9/16-12X1.3/4*	10	U01000.056.0175
5/16-18X4 Inch*	25	U01000.031.0400	7/16-14X3.1/4*	10	U01000.043.0325	9/16-12X2 Inch*	10	U01000.056.0200
5/16-18X4.1/4*	25	U01000.031.0425	7/16-14X3.1/2*	10	U01000.043.0350	9/16-12X2.1/4*	10	U01000.056.0225
5/16-18X4.1/2*	25	U01000.031.0450	7/16-14X3.3/4*	10	U01000.043.0375	9/16-12X2.1/2*	10	U01000.056.0250
5/16-18X5 Inch*	25	U01000.031.0500	7/16-14X4 Inch*	10	U01000.043.0400	9/16-12X2.3/4*	10	U01000.056.0275
5/16-18X5.1/2*	25	U01000.031.0550	7/16-14X4.1/2*	10	U01000.043.0450	9/16-12X3 Inch*	10	U01000.056.0300
5/16-18X6 Inch*	25	U01000.031.0600	7/16-14X5 Inch*	10	U01000.043.0500	9/16-12X3.1/4*	10	U01000.056.0325
5/16-18X7 Inch*	10	U01000.031.0700	7/16-14X5.1/2*	10	U01000.043.0550	9/16-12X3.1/2*	10	U01000.056.0350
5/16-18X8 Inch*	5	U01000.031.0800	7/16-14X6 Inch*	5	U01000.043.0600	9/16-12X3.3/4*	10	U01000.056.0375
			7/16-14X6.1/2*	5	U01000.043.0650	9/16-12X4 Inch*	5	U01000.056.0400

U01000 Hexagon head bolt UNC								
d x L	☒	Art.number	d x L	☒	Art.number	d x L	☒	Art.number
9/16-12X4.1/2*	5	U01000.056.0450	3/4-10X5.1/2*	5	U01000.075.0550	1.-8X8 Inch*	1	U01000.100.0800
9/16-12X5 Inch*	5	U01000.056.0500	3/4-10X6 Inch*	5	U01000.075.0600	1.-8X8.1/2*	1	U01000.100.0850
9/16-12X5.1/2*	5	U01000.056.0550	3/4-10X6.1/2*	1	U01000.075.0650	1.-8X9 Inch*	1	U01000.100.0900
9/16-12X6 Inch*	5	U01000.056.0600	3/4-10X7 Inch*	1	U01000.075.0700	1.-8X9.1/2*	1	U01000.100.0950
			3/4-10X7.1/2*	1	U01000.075.0750	1.-8X10 Inch*	1	U01000.100.1000
5/8-11X1 Inch ft*	10	U01000.062.0100	3/4-10X8 Inch*	1	U01000.075.0800	1.-8X12 Inch*	1	U01000.100.1200
5/8-11X1.1/4 ft*	10	U01000.062.0125	3/4-10X8.1/2*	1	U01000.075.0850			
5/8-11X1.1/2 ft*	10	U01000.062.0150	3/4-10X9 Inch*	1	U01000.075.0900	1.1/8-7X2. ft*	1	U01000.112.0200
5/8-11X1.3/4*	10	U01000.062.0175	3/4-10X9.1/2*	1	U01000.075.0950	1.1/8-7X2.1/2 ft*	1	U01000.112.0250
5/8-11X2 Inch*	5	U01000.062.0200	3/4-10X10 Inch*	1	U01000.075.1000	1.1/8-7X3 Inch*	1	U01000.112.0300
5/8-11X2.1/4*	5	U01000.062.0225	3/4-10X11 Inch*	1	U01000.075.1100	1.1/8-7X3.1/2*	1	U01000.112.0350
5/8-11X2.1/2*	5	U01000.062.0250	3/4-10X12 Inch*	1	U01000.075.1200	1.1/8-7X4 Inch*	1	U01000.112.0400
5/8-11X2.3/4*	5	U01000.062.0275	3/4-10X14 Inch*	1	U01000.075.1400	1.1/8-7X4.1/2*	1	U01000.112.0450
5/8-11X3 Inch*	5	U01000.062.0300				1.1/8-7X5 Inch*	1	U01000.112.0500
5/8-11X3.1/4*	5	U01000.062.0325	7/8-9X1.1/2 ft*	5	U01000.087.0150	1.1/8-7X5.1/2*	1	U01000.112.0550
5/8-11X3.1/2*	5	U01000.062.0350	7/8-9X1.3/4 ft*	5	U01000.087.0175	1.1/8-7X6 Inch*	1	U01000.112.0600
5/8-11X3.3/4*	5	U01000.062.0375	7/8-9X2 Inch ft*	5	U01000.087.0200	1.1/8-7X6.1/2*	1	U01000.112.0650
5/8-11X4 Inch*	5	U01000.062.0400	7/8-9X2.1/4*	5	U01000.087.0225	1.1/8-7X7 Inch*	1	U01000.112.0700
5/8-11X4.1/4*	5	U01000.062.0425	7/8-9X2.1/2*	5	U01000.087.0250	1.1/8-7X7.1/2*	1	U01000.112.0750
5/8-11X4.1/2*	5	U01000.062.0450	7/8-9X2.3/4*	5	U01000.087.0275	1.1/8-7X8 Inch*	1	U01000.112.0800
5/8-11X4.3/4*	5	U01000.062.0475	7/8-9X3 Inch*	5	U01000.087.0300	1.1/8-7X8.1/2*	1	U01000.112.0850
5/8-11X5 Inch*	5	U01000.062.0500	7/8-9X3.1/4*	5	U01000.087.0325	1.1/8-7X9 Inch*	1	U01000.112.0900
5/8-11X5.1/2*	5	U01000.062.0550	7/8-9X3.1/2*	5	U01000.087.0350	1.1/8-7X10 Inch*	1	U01000.112.1000
5/8-11X6 Inch*	5	U01000.062.0600	7/8-9X3.3/4*	5	U01000.087.0375			
5/8-11X6.1/2*	5	U01000.062.0650	7/8-9X4 Inch*	5	U01000.087.0400	1.1/4-7X2 Inch ft*	1	U01000.125.0200
5/8-11X7 Inch*	5	U01000.062.0700	7/8-9X4.1/4*	5	U01000.087.0425	1.1/4-7X2.1/2 ft*	1	U01000.125.0250
5/8-11X7.1/2*	5	U01000.062.0750	7/8-9X4.1/2*	5	U01000.087.0450	1.1/4-7X3 Inch*	1	U01000.125.0300
5/8-11X8 Inch*	5	U01000.062.0800	7/8-9X5 Inch*	5	U01000.087.0500	1.1/4-7X3.1/2*	1	U01000.125.0350
5/8-11X8.1/2*	5	U01000.062.0850	7/8-9X5.1/2*	5	U01000.087.0550	1.1/4-7X4 Inch*	1	U01000.125.0400
5/8-11X9 Inch*	5	U01000.062.0900	7/8-9X6 Inch*	1	U01000.087.0600	1.1/4-7X4.1/2*	1	U01000.125.0450
5/8-11X9.1/2*	5	U01000.062.0950	7/8-9X6.1/2*	1	U01000.087.0650	1.1/4-7X5 Inch*	1	U01000.125.0500
5/8-11X10 Inch*	5	U01000.062.1000	7/8-9X7 Inch*	1	U01000.087.0700	1.1/4-7X5.1/2*	1	U01000.125.0550
5/8-11X11 Inch*	5	U01000.062.1100	7/8-9X8 Inch*	1	U01000.087.0800	1.1/4-7X6 Inch*	1	U01000.125.0600
5/8-11X12 Inch*	5	U01000.062.1200	7/8-9X8.1/2*	1	U01000.087.0850	1.1/4-7X6.1/2*	1	U01000.125.0650
5/8-11X13 Inch*	1	U01000.062.1300	7/8-9X9 Inch*	1	U01000.087.0900	1.1/4-7X7 Inch*	1	U01000.125.0700
5/8-11X14 Inch*	1	U01000.062.1400	7/8-9X9.1/2*	1	U01000.087.0950	1.1/4-7X7.1/2*	1	U01000.125.0750
5/8-11X15 Inch*	1	U01000.062.1500	7/8-9X10 Inch*	1	U01000.087.1000	1.1/4-7X8 Inch*	1	U01000.125.0800
						1.1/4-7X8.1/2*	1	U01000.125.0850
3/4-10X1 Inch ft*	10	U01000.075.0100	1.-8X1.1/2 ft*	5	U01000.100.0150	1.1/4-7X9 Inch*	1	U01000.125.0900
3/4-10X1.1/4 ft*	10	U01000.075.0125	1.-8X1.3/4 ft*	5	U01000.100.0175	1.1/4-7X10 Inch*	1	U01000.125.1000
3/4-10X1.1/2 ft*	10	U01000.075.0150	1.-8X2 Inch ft*	5	U01000.100.0200			
3/4-10X1.3/4 ft*	10	U01000.075.0175	1.-8X2.1/4 ft*	5	U01000.100.0225	1.1/2-6X3 Inch ft*	1	U01000.150.0300
3/4-10X2 Inch*	5	U01000.075.0200	1.-8X2.1/2*	5	U01000.100.0250	1.1/2-6X3.1/2*	1	U01000.150.0350
3/4-10X2.1/4*	5	U01000.075.0225	1.-8X2.3/4*	5	U01000.100.0275	1.1/2-6X4 Inch*	1	U01000.150.0400
3/4-10X2.1/2*	5	U01000.075.0250	1.-8X3 Inch*	5	U01000.100.0300	1.1/2-6X4.1/2*	1	U01000.150.0450
3/4-10X2.3/4*	5	U01000.075.0275	1.-8X3.1/4*	5	U01000.100.0325	1.1/2-6X5 Inch*	1	U01000.150.0500
3/4-10X3 Inch*	5	U01000.075.0300	1.-8X3.1/2*	5	U01000.100.0350	1.1/2-6X5.1/2*	1	U01000.150.0550
3/4-10X3.1/4*	5	U01000.075.0325	1.-8X3.3/4*	5	U01000.100.0375	1.1/2-6X6 Inch*	1	U01000.150.0600
3/4-10X3.1/2*	5	U01000.075.0350	1.-8X4 Inch*	5	U01000.100.0400	1.1/2-6X6.1/2*	1	U01000.150.0650
3/4-10X3.3/4*	5	U01000.075.0375	1.-8X4.1/2*	5	U01000.100.0450	1.1/2-6X7 Inch*	1	U01000.150.0700
3/4-10X4 Inch*	5	U01000.075.0400	1.-8X5 Inch*	5	U01000.100.0500	1.1/2-6X7.1/2*	1	U01000.150.0750
3/4-10X4.1/4*	5	U01000.075.0425	1.-8X5.1/2*	5	U01000.100.0550	1.1/2-6X8 Inch*	1	U01000.150.0800
3/4-10X4.1/2*	5	U01000.075.0450	1.-8X6 Inch*	1	U01000.100.0600	1.1/2-6X8.1/2*	1	U01000.150.0850
3/4-10X4.3/4*	5	U01000.075.0475	1.-8X6.1/2*	1	U01000.100.0650	1.1/2-6X9 Inch*	1	U01000.150.0900
3/4-10X5 Inch*	5	U01000.075.0500	1.-8X7 Inch*	1	U01000.100.0700	1.1/2-6X10 Inch*	1	U01000.150.1000
3/4-10X5.1/4*	5	U01000.075.0525	1.-8X7.1/2*	1	U01000.100.0750			

* ft = fully threaded

U01200 Hexagon head bolt UNC			X01A
Thread	Unified National Coarse		
Material	Steel		
Class	Grade 5		
Surface treatment	Zinc plated		





d x L	☒	Art.number	d x L	☒	Art.number	d x L	☒	Art.number
1/4-20X1/2 ft*	100	U01200.025.0050	1/4-20X2.3/4*	50	U01200.025.0275	1/4-20X8 Inch*	5	U01200.025.0800
1/4-20X5/8 ft*	100	U01200.025.0062	1/4-20X3 Inch*	50	U01200.025.0300			
1/4-20X3/4 ft*	100	U01200.025.0075	1/4-20X3.1/4*	50	U01200.025.0325	5/16-18X1/2 ft*	100	U01200.031.0050
1/4-20X7/8*	100	U01200.025.0087	1/4-20X3.1/2*	50	U01200.025.0350	5/16-18X5/8 ft*	100	U01200.031.0062
1/4-20X1 Inch*	100	U01200.025.0100	1/4-20X3.3/4*	50	U01200.025.0375	5/16-18X3/4 ft*	100	U01200.031.0075
1/4-20X1.1/4*	100	U01200.025.0125	1/4-20X4 Inch*	25	U01200.025.0400	5/16-18X7/8 ft*	100	U01200.031.0087
1/4-20X1.3/8*	100	U01200.025.0137	1/4-20X4.1/4*	25	U01200.025.0425	5/16-18X1 Inch*	100	U01200.031.0100
1/4-20X1.1/2*	100	U01200.025.0150	1/4-20X4.1/2*	25	U01200.025.0450	5/16-18X1.1/4*	100	U01200.031.0125
1/4-20X1.5/8*	100	U01200.025.0162	1/4-20X5 Inch*	25	U01200.025.0500	5/16-18X1.3/8*	100	U01200.031.0137
1/4-20X1.3/4*	100	U01200.025.0175	1/4-20X5.1/2*	25	U01200.025.0550	5/16-18X1.1/2*	100	U01200.031.0150
1/4-20X2 Inch*	50	U01200.025.0200	1/4-20X6 Inch*	25	U01200.025.0600	5/16-18X1.5/8*	100	U01200.031.0162
1/4-20X2.1/4*	50	U01200.025.0225	1/4-20X6.1/2*	10	U01200.025.0650	5/16-18X1.3/4*	50	U01200.031.0175
1/4-20X2.1/2*	50	U01200.025.0250	1/4-20X7 Inch*	10	U01200.025.0700	5/16-18X2 Inch*	50	U01200.031.0200

U01200		Hexagon head bolt UNC						
d x L	☒	Art.number	d x L	☒	Art.number	d x L	☒	Art.number
5/16-18X2.1/4*	50	U01200.031.0225	1/2-13X2.1/4*	10	U01200.050.0225	3/4-10X3 Inch*	5	U01200.075.0300
5/16-18X2.1/2*	50	U01200.031.0250	1/2-13X2.1/2*	10	U01200.050.0250	3/4-10X3.1/4*	5	U01200.075.0325
5/16-18X2.3/4*	50	U01200.031.0275	1/2-13X2.3/4*	10	U01200.050.0275	3/4-10X3.1/2*	5	U01200.075.0350
5/16-18X3 Inch*	50	U01200.031.0300	1/2-13X3 Inch*	10	U01200.050.0300	3/4-10X3.3/4*	5	U01200.075.0375
5/16-18X3.1/2*	50	U01200.031.0350	1/2-13X3.1/4*	10	U01200.050.0325	3/4-10X4 Inch*	5	U01200.075.0400
5/16-18X3.3/4*	25	U01200.031.0375	1/2-13X3.1/2*	10	U01200.050.0350	3/4-10X4.1/4*	5	U01200.075.0425
5/16-18X4 Inch*	25	U01200.031.0400	1/2-13X3.3/4*	10	U01200.050.0375	3/4-10X4.1/2*	5	U01200.075.0450
5/16-18X4.1/4*	25	U01200.031.0425	1/2-13X4 Inch*	5	U01200.050.0400	3/4-10X4.3/4*	5	U01200.075.0475
5/16-18X4.1/2*	25	U01200.031.0450	1/2-13X4.1/4*	5	U01200.050.0425	3/4-10X5 Inch*	5	U01200.075.0500
5/16-18X5 Inch*	25	U01200.031.0500	1/2-13X4.1/2*	5	U01200.050.0450	3/4-10X5.1/4*	5	U01200.075.0525
5/16-18X5.1/2*	25	U01200.031.0550	1/2-13X4.3/4*	5	U01200.050.0475	3/4-10X5.1/2*	5	U01200.075.0550
5/16-18X6 Inch*	25	U01200.031.0600	1/2-13X5 Inch*	5	U01200.050.0500	3/4-10X6 Inch*	5	U01200.075.0600
5/16-18X7 Inch*	10	U01200.031.0700	1/2-13X5.1/4*	5	U01200.050.0525	3/4-10X6.1/2*	1	U01200.075.0650
5/16-18X8 Inch*	5	U01200.031.0800	1/2-13X5.1/2*	5	U01200.050.0550	3/4-10X7 Inch*	1	U01200.075.0700
			1/2-13X6 Inch*	5	U01200.050.0600	3/4-10X7.1/2*	1	U01200.075.0750
			1/2-13X6.1/2*	5	U01200.050.0650	3/4-10X8 Inch*	1	U01200.075.0800
3/8-16X1/2 ft*	50	U01200.037.0050	1/2-13X6.1/2*	5	U01200.050.0700	3/4-10X8.1/2*	1	U01200.075.0850
3/8-16X5/8 ft*	50	U01200.037.0062	1/2-13X7 Inch*	5	U01200.050.0750	3/4-10X9 Inch*	1	U01200.075.0900
3/8-16X3/4 ft*	50	U01200.037.0075	1/2-13X7.1/2*	5	U01200.050.0800	3/4-10X9.1/2*	1	U01200.075.0950
3/8-16X7/8 ft*	50	U01200.037.0087	1/2-13X8 Inch*	5	U01200.050.0850	3/4-10X10 Inch*	1	U01200.075.1000
3/8-16X1 Inch ft*	50	U01200.037.0100	1/2-13X8.1/2*	5	U01200.050.0900	3/4-10X11 Inch*	1	U01200.075.1100
3/8-16X1.1/4*	50	U01200.037.0125	1/2-13X9 Inch*	5	U01200.050.1000	3/4-10X12 Inch*	1	U01200.075.1200
3/8-16X1.1/2*	50	U01200.037.0150	1/2-13X10 Inch*	5	U01200.050.1100	3/4-10X14 Inch*	1	U01200.075.1400
3/8-16X1.3/4*	50	U01200.037.0175	1/2-13X11 Inch*	5	U01200.050.1200			
3/8-16X2 Inch*	25	U01200.037.0200	1/2-13X12 Inch*	5				
3/8-16X2.1/4*	25	U01200.037.0225						
3/8-16X2.1/2*	25	U01200.037.0250	9/16-12X1 Inch ft*	25	U01200.056.0100	7/8-9X1.1/2 ft*	5	U01200.087.0150
3/8-16X2.3/4*	25	U01200.037.0275	9/16-12X1.1/4 ft*	25	U01200.056.0125	7/8-9X1.3/4 ft*	5	U01200.087.0175
3/8-16X3 Inch*	25	U01200.037.0300	9/16-12X1.1/2*	25	U01200.056.0150	7/8-9X2 Inch ft*	5	U01200.087.0200
3/8-16X3.1/4*	25	U01200.037.0325	9/16-12X1.3/4*	10	U01200.056.0175	7/8-9X2.1/4*	5	U01200.087.0225
3/8-16X3.1/2*	25	U01200.037.0350	9/16-12X2 Inch*	10	U01200.056.0200	7/8-9X2.1/2*	5	U01200.087.0250
3/8-16X3.3/4*	25	U01200.037.0375	9/16-12X2.1/4*	10	U01200.056.0225	7/8-9X2.3/4*	5	U01200.087.0275
3/8-16X4 Inch*	10	U01200.037.0400	9/16-12X2.1/2*	10	U01200.056.0250	7/8-9X3 Inch*	5	U01200.087.0300
3/8-16X4.1/4*	10	U01200.037.0425	9/16-12X2.3/4*	10	U01200.056.0275	7/8-9X3.1/4*	5	U01200.087.0325
3/8-16X4.1/2*	10	U01200.037.0450	9/16-12X3 Inch*	10	U01200.056.0300	7/8-9X3.1/2*	5	U01200.087.0350
3/8-16X4.3/4*	10	U01200.037.0475	9/16-12X3.1/4*	10	U01200.056.0325	7/8-9X3.3/4*	5	U01200.087.0375
3/8-16X5 Inch*	10	U01200.037.0500	9/16-12X3.1/2*	10	U01200.056.0350	7/8-9X4 Inch*	5	U01200.087.0400
3/8-16X5.1/2*	10	U01200.037.0550	9/16-12X3.3/4*	10	U01200.056.0375	7/8-9X4.1/4*	5	U01200.087.0425
3/8-16X5.3/4*	10	U01200.037.0575	9/16-12X4 Inch*	5	U01200.056.0400	7/8-9X4.1/2*	5	U01200.087.0450
3/8-16X6 Inch*	10	U01200.037.0600	9/16-12X4.1/2*	5	U01200.056.0450	7/8-9X5 Inch*	5	U01200.087.0500
3/8-16X6.1/2*	10	U01200.037.0650	9/16-12X5 Inch*	5	U01200.056.0500	7/8-9X5.1/2*	5	U01200.087.0550
3/8-16X7 Inch*	10	U01200.037.0700	9/16-12X5.1/2*	5	U01200.056.0550	7/8-9X6 Inch*	1	U01200.087.0600
3/8-16X7.1/2*	5	U01200.037.0750	9/16-12X6 Inch*	5	U01200.056.0600	7/8-9X6.1/2*	1	U01200.087.0650
3/8-16X8 Inch*	5	U01200.037.0800				7/8-9X7 Inch*	1	U01200.087.0700
3/8-16X8.1/2*	5	U01200.037.0850	5/8-11X1 Inch ft*	10	U01200.062.0100	7/8-9X7.1/2*	1	U01200.087.0750
3/8-16X9 Inch*	5	U01200.037.0900	5/8-11X1.1/4 ft*	10	U01200.062.0125	7/8-9X8 Inch*	1	U01200.087.0800
3/8-16X10 Inch*	5	U01200.037.1000	5/8-11X1.1/2 ft*	10	U01200.062.0150	7/8-9X8.1/2*	1	U01200.087.0850
3/8-16X12 Inch*	5	U01200.037.1200	5/8-11X1.3/4*	10	U01200.062.0175	7/8-9X9 Inch*	1	U01200.087.0900
			5/8-11X2 Inch*	5	U01200.062.0200	7/8-9X9.1/2*	1	U01200.087.0950
			5/8-11X2.1/4*	5	U01200.062.0225	7/8-9X10 Inch*	1	U01200.087.1000
			5/8-11X2.1/2*	5	U01200.062.0250			
			5/8-11X2.3/4*	5	U01200.062.0275	1.-8X1.1/2 ft*	5	U01200.100.0150
			5/8-11X3 Inch*	5	U01200.062.0300	1.-8X1.3/4 ft*	5	U01200.100.0175
			5/8-11X3.1/4*	5	U01200.062.0325	1.-8X2 Inch ft*	5	U01200.100.0200
			5/8-11X3.1/2*	5	U01200.062.0350	1.-8X2.1/4 ft*	5	U01200.100.0225
			5/8-11X3.3/4*	5	U01200.062.0375	1.-8X2.1/2*	5	U01200.100.0250
			5/8-11X4 Inch*	5	U01200.062.0400	1.-8X2.3/4*	5	U01200.100.0275
			5/8-11X4.1/4*	5	U01200.062.0425	1.-8X3 Inch*	5	U01200.100.0300
			5/8-11X4.1/2*	5	U01200.062.0450	1.-8X3.1/4*	5	U01200.100.0325
			5/8-11X4.3/4*	5	U01200.062.0475	1.-8X3.1/2*	5	U01200.100.0350
			5/8-11X5 Inch*	5	U01200.062.0500	1.-8X3.3/4*	5	U01200.100.0375
			5/8-11X5.1/2*	5	U01200.062.0550	1.-8X4 Inch*	5	U01200.100.0400
			5/8-11X6 Inch*	5	U01200.062.0600	1.-8X4.1/4*	5	U01200.100.0425
			5/8-11X6.1/2*	5	U01200.062.0650	1.-8X4.1/2*	5	U01200.100.0450
			5/8-11X7 Inch*	5	U01200.062.0700	1.-8X5 Inch*	5	U01200.100.0500
			5/8-11X7.1/2*	5	U01200.062.0750	1.-8X5.1/2*	5	U01200.100.0550
			5/8-11X8 Inch*	5	U01200.062.0800	1.-8X6 Inch*	1	U01200.100.0600
			5/8-11X8.1/2*	5	U01200.062.0850	1.-8X6.1/2*	1	U01200.100.0650
			5/8-11X9 Inch*	5	U01200.062.0900	1.-8X7 Inch*	1	U01200.100.0700
			5/8-11X9.1/2*	5	U01200.062.0950	1.-8X7.1/2*	1	U01200.100.0750
			5/8-11X10 Inch*	5	U01200.062.1000	1.-8X8 Inch*	1	U01200.100.0800
			5/8-11X11 Inch*	5	U01200.062.1100	1.-8X8.1/2*	1	U01200.100.0850
			5/8-11X12 Inch*	5	U01200.062.1200	1.-8X9 Inch*	1	U01200.100.0900
			5/8-11X14 Inch*	1	U01200.062.1400	1.-8X9.1/2*	1	U01200.100.0950
						1.-8X10 Inch*	1	U01200.100.1000
			3/4-10X1 Inch ft*	10	U01200.075.0100			
1/2-13X3/4 ft*	25	U01200.050.0075	3/4-10X1.1/4 ft*	10	U01200.075.0125	1.1/8-7X2.1/2 ft*	1	U01200.112.0250
1/2-13X7/8 ft*	25	U01200.050.0087	3/4-10X1.1/2 ft*	10	U01200.075.0150	1.1/8-7X3 Inch*	1	U01200.112.0300
1/2-13X1 Inch ft*	25	U01200.050.0100	3/4-10X1.3/4 ft*	10	U01200.075.0175	1.1/8-7X3.1/2*	1	U01200.112.0350
1/2-13X1.1/4 ft*	25	U01200.050.0125	3/4-10X2 Inch*	5	U01200.075.0200	1.1/8-7X4 Inch*	1	U01200.112.0400
1/2-13X1.1/2*	25	U01200.050.0150	3/4-10X2.1/4*	5	U01200.075.0225	1.1/8-7X4.1/2*	1	U01200.112.0450
1/2-13X1.3/4*	25	U01200.050.0175	3/4-10X2.1/2*	5	U01200.075.0250	1.1/8-7X5 Inch*	1	U01200.112.0500
1/2-13X2 Inch*	10	U01200.050.0200	3/4-10X2.3/4*	5	U01200.075.0275	1.1/8-7X5.1/2*	1	U01200.112.0550
						1.1/8-7X6 Inch*	1	U01200.112.0600

U01200 Hexagon head bolt UNC								
d x L	☒	Art.number	d x L	☒	Art.number	d x L	☒ Art.number	
1.1/8-7X6.1/2*	1	U01200.112.0650	1.1/4-7X4.1/2*	1	U01200.125.0450	1.1/2-6X3 Inch ft*	1	U01200.150.0300
1.1/8-7X7 Inch*	1	U01200.112.0700	1.1/4-7X5.1/2*	1	U01200.125.0500	1.1/2-6X3.1/2*	1	U01200.150.0350
1.1/8-7X7.1/2*	1	U01200.112.0750	1.1/4-7X6 Inch*	1	U01200.125.0600	1.1/2-6X4 Inch*	1	U01200.150.0400
1.1/8-7X8 Inch*	1	U01200.112.0800	1.1/4-7X6.1/2*	1	U01200.125.0650	1.1/2-6X4.1/2*	1	U01200.150.0450
1.1/8-7X8.1/2*	1	U01200.112.0850	1.1/4-7X7 Inch*	1	U01200.125.0700	1.1/2-6X5 Inch*	1	U01200.150.0500
1.1/8-7X9 Inch*	1	U01200.112.0900	1.1/4-7X7.1/2*	1	U01200.125.0750	1.1/2-6X5.1/2*	1	U01200.150.0550
1.1/8-7X10 Inch*	1	U01200.112.1000	1.1/4-7X8 Inch*	1	U01200.125.0800	1.1/2-6X6 Inch*	1	U01200.150.0600
1.1/4-7X2 Inch ft*	1	U01200.125.0200	1.1/4-7X8.1/2*	1	U01200.125.0850	1.1/2-6X6.1/2*	1	U01200.150.0650
1.1/4-7X2.1/2 ft*	1	U01200.125.0250	1.1/4-7X9 Inch*	1	U01200.125.0900	1.1/2-6X7 Inch*	1	U01200.150.0700
1.1/4-7X3 Inch*	1	U01200.125.0300	1.1/4-7X10 Inch*	1	U01200.125.1000	1.1/2-6X7.1/2*	1	U01200.150.0750
1.1/4-7X3.1/2*	1	U01200.125.0350	1.1/4-7X12 Inch*	1	U01200.125.1200	1.1/2-6X8 Inch*	1	U01200.150.0800
1.1/4-7X4 Inch*	1	U01200.125.0400	1.1/4-7X14 Inch*	1	U01200.125.1400	1.1/2-6X10 Inch*	1	U01200.150.1000

* ft = fully threaded

U04104 Hexagon head bolt UNC			X01A
Thread	Unified National Coarse		
Material	Steel		
Class	Grade 8		
			

d x L	☒	Art.number	d x L	☒	Art.number	d x L	☒ Art.number	
1/4-20X1/2 ft*	100	U04104.025.0050	3/8-16X1 Inch ft*	50	U04104.037.0100	1/2-13X3/4 ft*	25	U04104.050.0075
1/4-20X5/8 ft*	100	U04104.025.0062	3/8-16X1.1/4*	50	U04104.037.0125	1/2-13X1 Inch ft*	25	U04104.050.0100
1/4-20X3/4 ft*	100	U04104.025.0075	3/8-16X1.1/2*	50	U04104.037.0150	1/2-13X1.1/4 ft*	25	U04104.050.0125
1/4-20X7/8*	100	U04104.025.0087	3/8-16X1.3/4*	50	U04104.037.0175	1/2-13X1.1/2*	25	U04104.050.0150
1/4-20X1 Inch*	100	U04104.025.0100	3/8-16X2 Inch*	25	U04104.037.0200	1/2-13X1.3/4*	25	U04104.050.0175
1/4-20X1.1/4*	100	U04104.025.0125	3/8-16X2.1/4*	25	U04104.037.0225	1/2-13X2 Inch*	10	U04104.050.0200
1/4-20X1.3/8*	100	U04104.025.0137	3/8-16X2.1/2*	25	U04104.037.0250	1/2-13X2.1/4*	10	U04104.050.0225
1/4-20X1.1/2*	100	U04104.025.0150	3/8-16X2.3/4*	25	U04104.037.0275	1/2-13X2.1/2*	10	U04104.050.0250
1/4-20X1.5/8*	100	U04104.025.0162	3/8-16X3 Inch*	25	U04104.037.0300	1/2-13X2.3/4*	10	U04104.050.0275
1/4-20X1.3/4*	100	U04104.025.0175	3/8-16X3.1/4*	25	U04104.037.0325	1/2-13X3 Inch*	10	U04104.050.0300
1/4-20X2 Inch*	50	U04104.025.0200	3/8-16X3.1/2*	25	U04104.037.0350	1/2-13X3.1/4*	10	U04104.050.0325
1/4-20X2.1/4*	50	U04104.025.0225	3/8-16X3.3/4*	25	U04104.037.0375	1/2-13X3.1/2*	10	U04104.050.0350
1/4-20X2.1/2*	50	U04104.025.0250	3/8-16X4 Inch*	10	U04104.037.0400	1/2-13X3.3/4*	10	U04104.050.0375
1/4-20X2.3/4*	50	U04104.025.0275	3/8-16X4.1/4*	10	U04104.037.0425	1/2-13X4 Inch*	5	U04104.050.0400
1/4-20X3 Inch*	50	U04104.025.0300	3/8-16X4.1/2*	10	U04104.037.0450	1/2-13X4.1/4*	5	U04104.050.0425
1/4-20X3.1/4*	50	U04104.025.0325	3/8-16X4.3/4*	10	U04104.037.0475	1/2-13X4.1/2*	5	U04104.050.0450
1/4-20X3.1/2*	50	U04104.025.0350	3/8-16X5 Inch*	10	U04104.037.0500	1/2-13X4.3/4*	5	U04104.050.0475
1/4-20X3.3/4*	50	U04104.025.0375	3/8-16X5.1/2*	10	U04104.037.0550	1/2-13X5 Inch*	5	U04104.050.0500
1/4-20X4 Inch*	25	U04104.025.0400	3/8-16X5.3/4*	10	U04104.037.0575	1/2-13X5.1/4*	5	U04104.050.0525
1/4-20X4.1/4*	25	U04104.025.0425	3/8-16X6 Inch*	10	U04104.037.0600	1/2-13X5.1/2*	5	U04104.050.0550
1/4-20X4.1/2*	25	U04104.025.0450	3/8-16X6.1/2*	10	U04104.037.0650	1/2-13X6 Inch*	5	U04104.050.0600
1/4-20X5 Inch*	25	U04104.025.0500	3/8-16X7 Inch*	10	U04104.037.0700	1/2-13X6.1/2*	5	U04104.050.0650
1/4-20X5.1/2*	25	U04104.025.0550	3/8-16X7.1/2*	5	U04104.037.0750	1/2-13X7 Inch*	5	U04104.050.0700
1/4-20X6 Inch*	25	U04104.025.0600	3/8-16X8 Inch*	5	U04104.037.0800	1/2-13X7.1/2*	5	U04104.050.0750
			3/8-16X8.1/2*	5	U04104.037.0850	1/2-13X8 Inch*	5	U04104.050.0800
5/16-18X1/2 ft*	100	U04104.031.0050	3/8-16X9 Inch*	5	U04104.037.0900	1/2-13X8.1/2*	5	U04104.050.0850
5/16-18X5/8 ft*	100	U04104.031.0062	3/8-16X10 Inch*	5	U04104.037.1000	1/2-13X9 Inch*	5	U04104.050.0900
5/16-18X3/4 ft*	100	U04104.031.0075	3/8-16X12 Inch*	5	U04104.037.1200	1/2-13X10 Inch*	5	U04104.050.1000
5/16-18X7/8 ft*	100	U04104.031.0087				1/2-13X11 Inch*	5	U04104.050.1100
5/16-18X1 Inch*	100	U04104.031.0100	7/16-14X3/4 ft*	25	U04104.043.0075	1/2-13X12 Inch*	5	U04104.050.1200
5/16-18X1.1/4*	100	U04104.031.0125	7/16-14X7/8 ft*	25	U04104.043.0087			
5/16-18X1.3/8*	100	U04104.031.0137	7/16-14X1 Inch ft*	25	U04104.043.0100	9/16-12X1 Inch ft*	25	U04104.056.0100
5/16-18X1.1/2*	100	U04104.031.0150	7/16-14X1.1/4*	25	U04104.043.0125	9/16-12X1.1/4 ft*	25	U04104.056.0125
5/16-18X1.5/8*	100	U04104.031.0162	7/16-14X1.3/8*	25	U04104.043.0137	9/16-12X1.1/2*	25	U04104.056.0150
5/16-18X1.3/4*	50	U04104.031.0175	7/16-14X1.1/2*	25	U04104.043.0150	9/16-12X1.3/4*	10	U04104.056.0175
5/16-18X2 Inch*	50	U04104.031.0200	7/16-14X1.3/4*	25	U04104.043.0175	9/16-12X2 Inch*	10	U04104.056.0200
5/16-18X2.1/4*	50	U04104.031.0225	7/16-14X2 Inch*	25	U04104.043.0200	9/16-12X2.1/4*	10	U04104.056.0225
5/16-18X2.1/2*	50	U04104.031.0250	7/16-14X2.1/4*	10	U04104.043.0225	9/16-12X2.1/2*	10	U04104.056.0250
5/16-18X2.3/4*	50	U04104.031.0275	7/16-14X2.1/2*	10	U04104.043.0250	9/16-12X2.3/4*	10	U04104.056.0275
5/16-18X3 Inch*	50	U04104.031.0300	7/16-14X2.3/4*	10	U04104.043.0275	9/16-12X3 Inch*	10	U04104.056.0300
5/16-18X3.1/4*	50	U04104.031.0325	7/16-14X3 Inch*	10	U04104.043.0300	9/16-12X3.1/4*	10	U04104.056.0325
5/16-18X3.1/2*	50	U04104.031.0350	7/16-14X3.1/4*	10	U04104.043.0325	9/16-12X3.1/2*	10	U04104.056.0350
5/16-18X3.3/4*	25	U04104.031.0375	7/16-14X3.1/2*	10	U04104.043.0350	9/16-12X3.3/4*	10	U04104.056.0375
5/16-18X4 Inch*	25	U04104.031.0400	7/16-14X3.3/4*	10	U04104.043.0375	9/16-12X4 Inch*	5	U04104.056.0400
5/16-18X4.1/4*	25	U04104.031.0425	7/16-14X4 Inch*	10	U04104.043.0400	9/16-12X4.1/2*	5	U04104.056.0450
5/16-18X4.1/2*	25	U04104.031.0450	7/16-14X4.1/2*	10	U04104.043.0450	9/16-12X5 Inch*	5	U04104.056.0500
5/16-18X5 Inch*	25	U04104.031.0500	7/16-14X5 Inch*	10	U04104.043.0500	9/16-12X5.1/2*	5	U04104.056.0550
5/16-18X5.1/2*	25	U04104.031.0550	7/16-14X5.1/2*	10	U04104.043.0550	9/16-12X6 Inch*	5	U04104.056.0600
5/16-18X6 Inch*	25	U04104.031.0600	7/16-14X6 Inch*	5	U04104.043.0600			
5/16-18X7 Inch*	10	U04104.031.0700	7/16-14X6.1/2*	5	U04104.043.0650	5/8-11X1 Inch ft*	10	U04104.062.0100
5/16-18X8 Inch*	5	U04104.031.0800	7/16-14X7 Inch*	5	U04104.043.0700	5/8-11X1.1/4 ft*	10	U04104.062.0125
			7/16-14X8 Inch*	5	U04104.043.0800	5/8-11X1.1/2 ft*	10	U04104.062.0150
3/8-16X1/2 ft*	50	U04104.037.0050	7/16-14X9 Inch*	5	U04104.043.0900	5/8-11X1.3/4*	10	U04104.062.0175
3/8-16X5/8 ft*	50	U04104.037.0062	7/16-14X10 Inch*	5	U04104.043.1000	5/8-11X2 Inch*	5	U04104.062.0200
3/8-16X3/4 ft*	50	U04104.037.0075	7/16-14X12 Inch*	5	U04104.043.1200	5/8-11X2.1/4*	5	U04104.062.0225
3/8-16X7/8 ft*	50	U04104.037.0087				5/8-11X2.1/2*	5	U04104.062.0250

U04104 Hexagon head bolt UNC								
d x L	☒	Art.number	d x L	☒	Art.number	d x L	☒	Art.number
5/8-11X2.3/4*	5	U04104.062.0275	3/4-10X12 Inch*	1	U04104.075.1200	1.-8X12 Inch*	1	U04104.100.1200
5/8-11X3 Inch*	5	U04104.062.0300	3/4-10X13 Inch*	1	U04104.075.1300	1.1/8-7X2.1/2 ft*	1	U04104.112.0250
5/8-11X3.1/4*	5	U04104.062.0325	3/4-10X14 Inch*	1	U04104.075.1400	1.1/8-7X3 Inch*	1	U04104.112.0300
5/8-11X3.1/2*	5	U04104.062.0350				1.1/8-7X3.1/2*	1	U04104.112.0350
5/8-11X3.3/4*	5	U04104.062.0375	7/8-9X1.1/2 ft*	5	U04104.087.0150	1.1/8-7X4 Inch*	1	U04104.112.0400
5/8-11X4 Inch*	5	U04104.062.0400	7/8-9X1.3/4 ft*	5	U04104.087.0175	1.1/8-7X4.1/2*	1	U04104.112.0450
5/8-11X4.1/4*	5	U04104.062.0425	7/8-9X2 Inch ft*	5	U04104.087.0200	1.1/8-7X5 Inch*	1	U04104.112.0500
5/8-11X4.1/2*	5	U04104.062.0450	7/8-9X2.1/4*	5	U04104.087.0225	1.1/8-7X5.1/2*	1	U04104.112.0550
5/8-11X4.3/4*	5	U04104.062.0475	7/8-9X2.1/2*	5	U04104.087.0250	1.1/8-7X6 Inch*	1	U04104.112.0600
5/8-11X5 Inch*	5	U04104.062.0500	7/8-9X2.3/4*	5	U04104.087.0275	1.1/8-7X6.1/2*	1	U04104.112.0650
5/8-11X5.1/2*	5	U04104.062.0550	7/8-9X3 Inch*	5	U04104.087.0300	1.1/8-7X7 Inch*	1	U04104.112.0700
5/8-11X6 Inch*	5	U04104.062.0600	7/8-9X3.1/4*	5	U04104.087.0325	1.1/8-7X7.1/2*	1	U04104.112.0750
5/8-11X6.1/2*	5	U04104.062.0650	7/8-9X3.1/2*	5	U04104.087.0350	1.1/8-7X8 Inch*	1	U04104.112.0800
5/8-11X7 Inch*	5	U04104.062.0700	7/8-9X3.3/4*	5	U04104.087.0375	1.1/8-7X8.1/2*	1	U04104.112.0850
5/8-11X7.1/2*	5	U04104.062.0750	7/8-9X4 Inch*	5	U04104.087.0400	1.1/8-7X9 Inch*	1	U04104.112.0900
5/8-11X8 Inch*	5	U04104.062.0800	7/8-9X4.1/4*	5	U04104.087.0425	1.1/8-7X10 Inch*	1	U04104.112.1000
5/8-11X8.1/2*	5	U04104.062.0850	7/8-9X4.1/2*	5	U04104.087.0450			
5/8-11X9 Inch*	5	U04104.062.0900	7/8-9X5 Inch*	5	U04104.087.0500	1.1/4-7X2 Inch ft*	1	U04104.125.0200
5/8-11X9.1/2*	5	U04104.062.0950	7/8-9X5.1/2*	5	U04104.087.0550	1.1/4-7X2.1/2 ft*	1	U04104.125.0250
5/8-11X10 Inch*	5	U04104.062.1000	7/8-9X6 Inch*	1	U04104.087.0600	1.1/4-7X3 Inch*	1	U04104.125.0300
5/8-11X11 Inch*	5	U04104.062.1100	7/8-9X6.1/2*	1	U04104.087.0650	1.1/4-7X3.1/2*	1	U04104.125.0350
5/8-11X12 Inch*	5	U04104.062.1200	7/8-9X7 Inch*	1	U04104.087.0700	1.1/4-7X4 Inch*	1	U04104.125.0400
5/8-11X14 Inch*	1	U04104.062.1400	7/8-9X7.1/2*	1	U04104.087.0750	1.1/4-7X4.1/2*	1	U04104.125.0450
			7/8-9X8 Inch*	1	U04104.087.0800	1.1/4-7X5 Inch*	1	U04104.125.0500
3/4-10X1 Inch ft*	10	U04104.075.0100	7/8-9X8.1/2*	1	U04104.087.0850	1.1/4-7X5.1/2*	1	U04104.125.0550
3/4-10X1.1/4 ft*	10	U04104.075.0125	7/8-9X9 Inch*	1	U04104.087.0900	1.1/4-7X6 Inch*	1	U04104.125.0600
3/4-10X1.1/2 ft*	10	U04104.075.0150	7/8-9X9.1/2*	1	U04104.087.0950	1.1/4-7X6.1/2*	1	U04104.125.0650
3/4-10X1.3/4 ft*	10	U04104.075.0175	7/8-9X10 Inch*	1	U04104.087.1000	1.1/4-7X7 Inch*	1	U04104.125.0700
3/4-10X2 Inch*	5	U04104.075.0200				1.1/4-7X7.1/2*	1	U04104.125.0750
3/4-10X2.1/4*	5	U04104.075.0225	1.-8X1.1/2 ft*	5	U04104.100.0150	1.1/4-7X8 Inch*	1	U04104.125.0800
3/4-10X2.1/2*	5	U04104.075.0250	1.-8X1.3/4 ft*	5	U04104.100.0175	1.1/4-7X8.1/2*	1	U04104.125.0850
3/4-10X2.3/4*	5	U04104.075.0275	1.-8X2 Inch ft*	5	U04104.100.0200	1.1/4-7X9 Inch*	1	U04104.125.0900
3/4-10X3 Inch*	5	U04104.075.0300	1.-8X2.1/4 ft*	5	U04104.100.0225	1.1/4-7X10 Inch*	1	U04104.125.1000
3/4-10X3.1/4*	5	U04104.075.0325	1.-8X2.1/2*	5	U04104.100.0250	1.1/4-7X12 Inch*	1	U04104.125.1200
3/4-10X3.1/2*	5	U04104.075.0350	1.-8X2.3/4*	5	U04104.100.0275	1.1/4-7X14 Inch*	1	U04104.125.1400
3/4-10X3.3/4*	5	U04104.075.0375	1.-8X3 Inch*	5	U04104.100.0300			
3/4-10X4 Inch*	5	U04104.075.0400	1.-8X3.1/4*	5	U04104.100.0325	1.1/2-6X3 Inch ft*	1	U04104.150.0300
3/4-10X4.1/4*	5	U04104.075.0425	1.-8X3.1/2*	5	U04104.100.0350	1.1/2-6X3.1/2*	1	U04104.150.0350
3/4-10X4.1/2*	5	U04104.075.0450	1.-8X3.3/4*	5	U04104.100.0375	1.1/2-6X4 Inch*	1	U04104.150.0400
3/4-10X4.3/4*	5	U04104.075.0475	1.-8X4 Inch*	5	U04104.100.0400	1.1/2-6X4.1/2*	1	U04104.150.0450
3/4-10X5 Inch*	5	U04104.075.0500	1.-8X4.1/4*	5	U04104.100.0425	1.1/2-6X5 Inch*	1	U04104.150.0500
3/4-10X5.1/4*	5	U04104.075.0525	1.-8X4.1/2*	5	U04104.100.0450	1.1/2-6X5.1/2*	1	U04104.150.0550
3/4-10X5.1/2*	5	U04104.075.0550	1.-8X5 Inch*	5	U04104.100.0500	1.1/2-6X6 Inch*	1	U04104.150.0600
3/4-10X6 Inch*	5	U04104.075.0600	1.-8X5.1/2*	5	U04104.100.0550	1.1/2-6X6.1/2*	1	U04104.150.0650
3/4-10X6.1/2*	1	U04104.075.0650	1.-8X6 Inch*	1	U04104.100.0600	1.1/2-6X7 Inch*	1	U04104.150.0700
3/4-10X7 Inch*	1	U04104.075.0700	1.-8X6.1/2*	1	U04104.100.0650	1.1/2-6X7.1/2*	1	U04104.150.0750
3/4-10X7.1/2*	1	U04104.075.0750	1.-8X7 Inch*	1	U04104.100.0700	1.1/2-6X8 Inch*	1	U04104.150.0800
3/4-10X8 Inch*	1	U04104.075.0800	1.-8X7.1/2*	1	U04104.100.0750	1.1/2-6X8.1/2*	1	U04104.150.0850
3/4-10X8.1/2*	1	U04104.075.0850	1.-8X8 Inch*	1	U04104.100.0800	1.1/2-6X9 Inch*	1	U04104.150.0900
3/4-10X9 Inch*	1	U04104.075.0900	1.-8X8.1/2*	1	U04104.100.0850	1.1/2-6X10 Inch*	1	U04104.150.1000
3/4-10X9.1/2*	1	U04104.075.0950	1.-8X9 Inch*	1	U04104.100.0900			
3/4-10X10 Inch*	1	U04104.075.1000	1.-8X9.1/2*	1	U04104.100.0950			
3/4-10X11 Inch*	1	U04104.075.1100	1.-8X10 Inch*	1	U04104.100.1000			

* ft = fully threaded

U04100 Hexagon head bolt UNC				X01A
Thread	Unified National Coarse			
Material	Steel			
Class	Grade 8			
Surface treatment	Zinc plated yellow passivated			

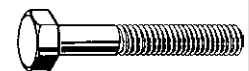



d x L	☒	Art.number	d x L	☒	Art.number	d x L	☒	Art.number
1/4-20X1/2 ft*	100	U04100.025.0050	1/4-20X3.1/2*	50	U04100.025.0350	5/16-18X1 Inch*	100	U04100.031.0100
1/4-20X5/8 ft*	100	U04100.025.0062	1/4-20X3.3/4*	50	U04100.025.0375	5/16-18X1.1/4*	100	U04100.031.0125
1/4-20X3/4 ft*	100	U04100.025.0075	1/4-20X4 Inch*	25	U04100.025.0400	5/16-18X1.3/8*	100	U04100.031.0137
1/4-20X7/8*	100	U04100.025.0087	1/4-20X4.1/4*	25	U04100.025.0425	5/16-18X1.1/2*	100	U04100.031.0150
1/4-20X1 Inch*	100	U04100.025.0100	1/4-20X4.1/2*	25	U04100.025.0450	5/16-18X1.5/8*	100	U04100.031.0162
1/4-20X1.1/4*	100	U04100.025.0125	1/4-20X5 Inch*	25	U04100.025.0500	5/16-18X1.3/4*	50	U04100.031.0175
1/4-20X1.1/2*	100	U04100.025.0150	1/4-20X5.1/2*	25	U04100.025.0550	5/16-18X2 Inch*	50	U04100.031.0200
1/4-20X1.3/8*	100	U04100.025.0137	1/4-20X6 Inch*	25	U04100.025.0600	5/16-18X2.1/4*	50	U04100.031.0225
1/4-20X1.1/2*	100	U04100.025.0150	1/4-20X6.1/2*	10	U04100.025.0650	5/16-18X2.3/8*	50	U04100.031.0237
1/4-20X1.5/8*	100	U04100.025.0162	1/4-20X7 Inch*	10	U04100.025.0700	5/16-18X2.1/2*	50	U04100.031.0250
1/4-20X1.3/4*	100	U04100.025.0175	1/4-20X8 Inch*	5	U04100.025.0800	5/16-18X2.3/4*	50	U04100.031.0275
1/4-20X2 Inch*	50	U04100.025.0200				5/16-18X3 Inch*	50	U04100.031.0300
1/4-20X2.1/4*	50	U04100.025.0225				5/16-18X3.1/4*	50	U04100.031.0325
1/4-20X2.1/2*	50	U04100.025.0250	5/16-18X1/2 ft*	100	U04100.031.0050	5/16-18X3.1/2*	50	U04100.031.0350
1/4-20X2.3/4*	50	U04100.025.0275	5/16-18X5/8 ft*	100	U04100.031.0062	5/16-18X3.3/4*	25	U04100.031.0375
1/4-20X3 Inch*	50	U04100.025.0300	5/16-18X3/4 ft*	100	U04100.031.0075	5/16-18X4 Inch*	25	U04100.031.0400
1/4-20X3.1/4*	50	U04100.025.0325	5/16-18X7/8 ft*	100	U04100.031.0087			

U04100 Hexagon head bolt UNC								
d x L	☒	Art.number	d x L	☒	Art.number	d x L	☒	Art.number
5/16-18X4.1/4*	25	U04100.031.0425	1/2-13X4 Inch*	5	U04100.050.0400	3/4-10X4 Inch*	5	U04100.075.0400
5/16-18X4.1/2*	25	U04100.031.0450	1/2-13X4.1/4*	5	U04100.050.0425	3/4-10X4.1/4*	5	U04100.075.0425
5/16-18X5 Inch*	25	U04100.031.0500	1/2-13X4.1/2*	5	U04100.050.0450	3/4-10X4.1/2*	5	U04100.075.0450
5/16-18X5.1/2*	25	U04100.031.0550	1/2-13X4.3/4*	5	U04100.050.0475	3/4-10X4.3/4*	5	U04100.075.0475
5/16-18X6 Inch*	25	U04100.031.0600	1/2-13X5 Inch*	5	U04100.050.0500	3/4-10X5 Inch*	5	U04100.075.0500
5/16-18X6.1/2*	10	U04100.031.0650	1/2-13X5.1/4*	5	U04100.050.0525	3/4-10X5.1/4*	5	U04100.075.0525
5/16-18X7 Inch*	10	U04100.031.0700	1/2-13X5.1/2*	5	U04100.050.0550	3/4-10X5.1/2*	5	U04100.075.0550
5/16-18X8 Inch*	5	U04100.031.0800	1/2-13X5.3/4*	5	U04100.050.0575	3/4-10X6 Inch*	5	U04100.075.0600
			1/2-13X6 Inch*	5	U04100.050.0600	3/4-10X6.1/2*	1	U04100.075.0650
3/8-16X1/2 ft*	50	U04100.037.0050	1/2-13X6.1/2*	5	U04100.050.0650	3/4-10X7 Inch*	1	U04100.075.0700
3/8-16X5/8 ft*	50	U04100.037.0062	1/2-13X7 Inch*	5	U04100.050.0700	3/4-10X7.1/2*	1	U04100.075.0750
3/8-16X3/4 ft*	50	U04100.037.0075	1/2-13X7.1/2*	5	U04100.050.0750	3/4-10X8 Inch*	1	U04100.075.0800
3/8-16X7/8 ft*	50	U04100.037.0087	1/2-13X8 Inch*	5	U04100.050.0800	3/4-10X8.1/2*	1	U04100.075.0850
3/8-16X1 Inch ft*	50	U04100.037.0100	1/2-13X8.1/2*	5	U04100.050.0850	3/4-10X9 Inch*	1	U04100.075.0900
3/8-16X1.1/4*	50	U04100.037.0125	1/2-13X9 Inch*	5	U04100.050.0900	3/4-10X9.1/2*	1	U04100.075.0950
3/8-16X1.1/2*	50	U04100.037.0150	1/2-13X9.1/2*	5	U04100.050.0950	3/4-10X10 Inch*	1	U04100.075.1000
3/8-16X1.3/4*	50	U04100.037.0175	1/2-13X10 Inch*	5	U04100.050.1000	3/4-10X11 Inch*	1	U04100.075.1100
3/8-16X2 Inch*	25	U04100.037.0200	1/2-13X11 Inch*	5	U04100.050.1100	3/4-10X12 Inch*	1	U04100.075.1200
3/8-16X2.1/4*	25	U04100.037.0225	1/2-13X12 Inch*	5	U04100.050.1200	3/4-10X13 Inch*	1	U04100.075.1300
3/8-16X2.1/2*	25	U04100.037.0250	1/2-13X14 Inch*	1	U04100.050.1400	3/4-10X14 Inch*	1	U04100.075.1400
3/8-16X2.3/4*	25	U04100.037.0275						
3/8-16X3 Inch*	25	U04100.037.0300	9/16-12X1 Inch ft*	25	U04100.056.0100	7/8-9X1.1/2 ft*	5	U04100.087.0150
3/8-16X3.1/4*	25	U04100.037.0325	9/16-12X1.1/4 ft*	25	U04100.056.0125	7/8-9X1.3/4 ft*	5	U04100.087.0175
3/8-16X3.1/2*	25	U04100.037.0350	9/16-12X1.1/2*	25	U04100.056.0150	7/8-9X2 Inch ft*	5	U04100.087.0200
3/8-16X3.3/4*	25	U04100.037.0375	9/16-12X1.3/4*	10	U04100.056.0175	7/8-9X2.1/4*	5	U04100.087.0225
3/8-16X4 Inch*	10	U04100.037.0400	9/16-12X2 Inch*	10	U04100.056.0200	7/8-9X2.1/2*	5	U04100.087.0250
3/8-16X4.1/4*	10	U04100.037.0425	9/16-12X2.1/4*	10	U04100.056.0225	7/8-9X2.3/4*	5	U04100.087.0275
3/8-16X4.1/2*	10	U04100.037.0450	9/16-12X2.1/2*	10	U04100.056.0250	7/8-9X3 Inch*	5	U04100.087.0300
3/8-16X4.3/4*	10	U04100.037.0475	9/16-12X2.3/4*	10	U04100.056.0275	7/8-9X3.1/4*	5	U04100.087.0325
3/8-16X5 Inch*	10	U04100.037.0500	9/16-12X3 Inch*	10	U04100.056.0300	7/8-9X3.1/2*	5	U04100.087.0350
3/8-16X5.1/2*	10	U04100.037.0550	9/16-12X3.1/4*	10	U04100.056.0325	7/8-9X3.3/4*	5	U04100.087.0375
3/8-16X5.3/4*	10	U04100.037.0575	9/16-12X3.1/2*	10	U04100.056.0350	7/8-9X4 Inch*	5	U04100.087.0400
3/8-16X6 Inch*	10	U04100.037.0600	9/16-12X3.3/4*	10	U04100.056.0375	7/8-9X4.1/4*	5	U04100.087.0425
3/8-16X6.1/2*	10	U04100.037.0650	9/16-12X4 Inch*	5	U04100.056.0400	7/8-9X4.1/2*	5	U04100.087.0450
3/8-16X7 Inch*	10	U04100.037.0700	9/16-12X4.1/2*	5	U04100.056.0450	7/8-9X5 Inch*	5	U04100.087.0500
3/8-16X7.1/2*	5	U04100.037.0750	9/16-12X5 Inch*	5	U04100.056.0500	7/8-9X5.1/2*	5	U04100.087.0550
3/8-16X8 Inch*	5	U04100.037.0800	9/16-12X5.1/2*	5	U04100.056.0550	7/8-9X6 Inch*	1	U04100.087.0600
3/8-16X8.1/2*	5	U04100.037.0850	9/16-12X6 Inch*	5	U04100.056.0600	7/8-9X6.1/2*	1	U04100.087.0650
3/8-16X9 Inch*	5	U04100.037.0900				7/8-9X7 Inch*	1	U04100.087.0700
3/8-16X10 Inch*	5	U04100.037.1000	5/8-11X1 Inch ft*	10	U04100.062.0100	7/8-9X7.1/2*	1	U04100.087.0750
3/8-16X12 Inch*	5	U04100.037.1200	5/8-11X1.1/4 ft*	10	U04100.062.0125	7/8-9X8 Inch*	1	U04100.087.0800
			5/8-11X1.1/2 ft*	10	U04100.062.0150	7/8-9X8.1/2*	1	U04100.087.0850
			5/8-11X1.3/4*	10	U04100.062.0175	7/8-9X9 Inch*	1	U04100.087.0900
			5/8-11X2 Inch*	5	U04100.062.0200	7/8-9X9.1/2*	1	U04100.087.0950
			5/8-11X2.1/4*	5	U04100.062.0225	7/8-9X10 Inch*	1	U04100.087.1000
			5/8-11X2.1/2*	5	U04100.062.0250	7/8-9X11 Inch*	1	U04100.087.1100
			5/8-11X2.3/4*	5	U04100.062.0275			
			5/8-11X3 Inch*	5	U04100.062.0300	1.-8X1.1/2 ft*	5	U04100.100.0150
			5/8-11X3.1/4*	5	U04100.062.0325	1.-8X1.3/4 ft*	5	U04100.100.0175
			5/8-11X3.1/2*	5	U04100.062.0350	1.-8X2 Inch ft*	5	U04100.100.0200
			5/8-11X3.3/4*	5	U04100.062.0375	1.-8X2.1/4 ft*	5	U04100.100.0225
			5/8-11X4 Inch*	5	U04100.062.0400	1.-8X2.1/2*	5	U04100.100.0250
			5/8-11X4.1/4*	5	U04100.062.0425	1.-8X2.3/4*	5	U04100.100.0275
			5/8-11X4.1/2*	5	U04100.062.0450	1.-8X3 Inch*	5	U04100.100.0300
			5/8-11X4.3/4*	5	U04100.062.0475	1.-8X3.1/4*	5	U04100.100.0325
			5/8-11X5 Inch*	5	U04100.062.0500	1.-8X3.1/2*	5	U04100.100.0350
			5/8-11X5.1/2*	5	U04100.062.0550	1.-8X3.3/4*	5	U04100.100.0375
			5/8-11X6 Inch*	5	U04100.062.0600	1.-8X4 Inch*	5	U04100.100.0400
			5/8-11X6.1/2*	5	U04100.062.0650	1.-8X4.1/4*	5	U04100.100.0425
			5/8-11X7 Inch*	5	U04100.062.0700	1.-8X4.1/2*	5	U04100.100.0450
			5/8-11X7.1/2*	5	U04100.062.0750	1.-8X5 Inch*	5	U04100.100.0500
			5/8-11X8 Inch*	5	U04100.062.0800	1.-8X5.1/2*	5	U04100.100.0550
			5/8-11X8.1/2*	5	U04100.062.0850	1.-8X6 Inch*	1	U04100.100.0600
			5/8-11X9 Inch*	5	U04100.062.0900	1.-8X6.1/2*	1	U04100.100.0650
			5/8-11X9.1/2*	5	U04100.062.0950	1.-8X7 Inch*	1	U04100.100.0700
			5/8-11X10 Inch*	5	U04100.062.1000	1.-8X7.1/2*	1	U04100.100.0750
			5/8-11X11 Inch*	5	U04100.062.1100	1.-8X8 Inch*	1	U04100.100.0800
			5/8-11X12 Inch*	5	U04100.062.1200	1.-8X8.1/2*	1	U04100.100.0850
			5/8-11X14 Inch*	1	U04100.062.1400	1.-8X9 Inch*	1	U04100.100.0900
						1.-8X9.1/2*	1	U04100.100.0950
1/2-13X3/4 ft*	25	U04100.050.0075	3/4-10X1 Inch ft*	10	U04100.075.0100	1.-8X10 Inch*	1	U04100.100.1000
1/2-13X1 Inch ft*	25	U04100.050.0100	3/4-10X1.1/4 ft*	10	U04100.075.0125	1.-8X12 Inch*	1	U04100.100.1200
1/2-13X1.1/4 ft*	25	U04100.050.0125	3/4-10X1.1/2 ft*	10	U04100.075.0150			
1/2-13X1.1/2*	25	U04100.050.0150	3/4-10X1.3/4 ft*	10	U04100.075.0175	1.1/8-7X2.1/2 ft*	1	U04100.112.0250
1/2-13X1.3/4*	25	U04100.050.0175	3/4-10X2 Inch*	5	U04100.075.0200	1.1/8-7X3 Inch*	1	U04100.112.0300
1/2-13X2 Inch*	10	U04100.050.0200	3/4-10X2.1/4*	5	U04100.075.0225	1.1/8-7X3.1/2*	1	U04100.112.0350
1/2-13X2.1/4*	10	U04100.050.0225	3/4-10X2.1/2*	5	U04100.075.0250	1.1/8-7X4 Inch*	1	U04100.112.0400
1/2-13X2.1/2*	10	U04100.050.0250	3/4-10X2.3/4*	5	U04100.075.0275	1.1/8-7X4.1/2*	1	U04100.112.0450
1/2-13X2.3/4*	10	U04100.050.0275	3/4-10X3 Inch*	5	U04100.075.0300	1.1/8-7X5 Inch*	1	U04100.112.0500
1/2-13X3 Inch*	10	U04100.050.0300	3/4-10X3.1/4*	5	U04100.075.0325	1.1/8-7X5.1/2*	1	U04100.112.0550
1/2-13X3.1/4*	10	U04100.050.0325	3/4-10X3.1/2*	5	U04100.075.0350	1.1/8-7X6 Inch*	1	U04100.112.0600
1/2-13X3.1/2*	10	U04100.050.0350	3/4-10X3.3/4*	5	U04100.075.0375	1.1/8-7X6.1/2*	1	U04100.112.0650
1/2-13X3.3/4*	10	U04100.050.0375						

U04100 Hexagon head bolt UNC								
d x L	☒	Art.number	d x L	☒	Art.number	d x L	☒	Art.number
1.1/8-7X7 Inch*	1	U04100.112.0700	1.1/4-7X5.1/2*	1	U04100.125.0550	1.1/2-6X3.1/2*	1	U04100.150.0350
1.1/8-7X7.1/2*	1	U04100.112.0750	1.1/4-7X6 Inch*	1	U04100.125.0600	1.1/2-6X4 Inch*	1	U04100.150.0400
1.1/8-7X8 Inch*	1	U04100.112.0800	1.1/4-7X6.1/2*	1	U04100.125.0650	1.1/2-6X4.1/2*	1	U04100.150.0450
1.1/8-7X8.1/2*	1	U04100.112.0850	1.1/4-7X7 Inch*	1	U04100.125.0700	1.1/2-6X5 Inch*	1	U04100.150.0500
1.1/8-7X9 Inch*	1	U04100.112.0900	1.1/4-7X7.1/2*	1	U04100.125.0750	1.1/2-6X5.1/2*	1	U04100.150.0550
1.1/8-7X10 Inch*	1	U04100.112.1000	1.1/4-7X8 Inch*	1	U04100.125.0800	1.1/2-6X6 Inch*	1	U04100.150.0600
			1.1/4-7X8.1/2*	1	U04100.125.0850	1.1/2-6X6.1/2*	1	U04100.150.0650
1.1/4-7X2.1/2 ft*	1	U04100.125.0250	1.1/4-7X9 Inch*	1	U04100.125.0900	1.1/2-6X7 Inch*	1	U04100.150.0700
1.1/4-7X3 Inch*	1	U04100.125.0300	1.1/4-7X10 Inch*	1	U04100.125.1000	1.1/2-6X7.1/2*	1	U04100.150.0750
1.1/4-7X3.1/2*	1	U04100.125.0350	1.1/4-7X12 Inch*	1	U04100.125.1200	1.1/2-6X8 Inch*	1	U04100.150.0800
1.1/4-7X4 Inch*	1	U04100.125.0400	1.1/4-7X14 Inch*	1	U04100.125.1400	1.1/2-6X8.1/2*	1	U04100.150.0850
1.1/4-7X4.1/2*	1	U04100.125.0450				1.1/2-6X9 Inch*	1	U04100.150.0900
1.1/4-7X5 Inch*	1	U04100.125.0500	1.1/2-6X3 Inch ft*	1	U04100.150.0300	1.1/2-6X10 Inch*	1	U04100.150.1000

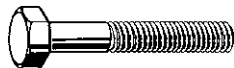
* ft = fully threaded

U51000 Hexagon head bolt UNC		X15A
Thread	Unified National Coarse	
Material	Stainless steel A2 (AISI 304/18-8)	
Class	F593	



d x L	☒	Art.number	d x L	☒	Art.number	d x L	☒	Art.number
1/4-20X1/2 ft*	100	U51000.025.0050	3/8-16X3/4 ft*	50	U51000.037.0075	1/2-13X1.1/2*	10	U51000.050.0150
1/4-20X5/8 ft*	100	U51000.025.0062	3/8-16X7/8 ft*	50	U51000.037.0087	1/2-13X1.3/4*	10	U51000.050.0175
1/4-20X3/4 ft*	100	U51000.025.0075	3/8-16X1 Inch ft*	50	U51000.037.0100	1/2-13X2 Inch*	10	U51000.050.0200
1/4-20X7/8*	100	U51000.025.0087	3/8-16X1.1/8	25	U51000.037.0112	1/2-13X2.1/4*	10	U51000.050.0225
1/4-20X1 Inch*	100	U51000.025.0100	3/8-16X1.1/4*	50	U51000.037.0125	1/2-13X2.1/2*	10	U51000.050.0250
1/4-20X1.1/8	25	U51000.025.0112	3/8-16X1.3/8	25	U51000.037.0137	1/2-13X2.3/4*	10	U51000.050.0275
1/4-20X1.1/4*	100	U51000.025.0125	3/8-16X1.1/2*	25	U51000.037.0150	1/2-13X3 Inch*	5	U51000.050.0300
1/4-20X1.3/8*	100	U51000.025.0137	3/8-16X1.3/4*	25	U51000.037.0175	1/2-13X3.1/4*	5	U51000.050.0325
1/4-20X1.1/2*	100	U51000.025.0150	3/8-16X2 Inch*	25	U51000.037.0200	1/2-13X3.1/2*	5	U51000.050.0350
1/4-20X1.3/4*	100	U51000.025.0175	3/8-16X2.1/4*	25	U51000.037.0225	1/2-13X3.3/4*	5	U51000.050.0375
1/4-20X1.7/8	25	U51000.025.0187	3/8-16X2.1/2*	25	U51000.037.0250	1/2-13X4 Inch*	5	U51000.050.0400
1/4-20X2 Inch*	50	U51000.025.0200	3/8-16X2.3/4*	25	U51000.037.0275	1/2-13X4.1/4*	5	U51000.050.0425
1/4-20X2.1/4*	50	U51000.025.0225	3/8-16X3 Inch*	10	U51000.037.0300	1/2-13X4.1/2*	5	U51000.050.0450
1/4-20X2.1/2*	50	U51000.025.0250	3/8-16X3.1/4*	10	U51000.037.0325	1/2-13X4.3/4*	5	U51000.050.0475
1/4-20X2.3/4*	50	U51000.025.0275	3/8-16X3.1/2*	10	U51000.037.0350	1/2-13X5 Inch*	5	U51000.050.0500
1/4-20X3 Inch*	25	U51000.025.0300	3/8-16X3.3/4*	10	U51000.037.0375	1/2-13X5.1/2*	5	U51000.050.0550
1/4-20X3.1/4*	25	U51000.025.0325	3/8-16X4 Inch*	10	U51000.037.0400	1/2-13X6 Inch*	5	U51000.050.0600
1/4-20X3.1/2*	25	U51000.025.0350	3/8-16X4.1/4*	10	U51000.037.0425	1/2-13X6.1/2*	5	U51000.050.0650
1/4-20X3.3/4*	25	U51000.025.0375	3/8-16X4.1/2*	10	U51000.037.0450	1/2-13X7 Inch*	5	U51000.050.0700
1/4-20X4 Inch*	25	U51000.025.0400	3/8-16X4.3/4*	10	U51000.037.0475	1/2-13X7.1/2*	5	U51000.050.0750
1/4-20X4.1/4*	25	U51000.025.0425	3/8-16X5 Inch*	10	U51000.037.0500	1/2-13X8 Inch*	5	U51000.050.0800
1/4-20X4.1/2*	25	U51000.025.0450	3/8-16X5.1/2*	10	U51000.037.0550	1/2-13X8.1/2*	1	U51000.050.0850
1/4-20X5 Inch*	25	U51000.025.0500	3/8-16X5.3/4*	10	U51000.037.0575	1/2-13X9 Inch*	1	U51000.050.0900
1/4-20X5.1/2*	10	U51000.025.0550	3/8-16X6 Inch*	10	U51000.037.0600	1/2-13X10 Inch*	1	U51000.050.1000
1/4-20X6 Inch*	10	U51000.025.0600	3/8-16X6.1/2*	5	U51000.037.0650	1/2-13X11 Inch*	1	U51000.050.1100
1/4-20X6.1/2*	5	U51000.025.0650	3/8-16X7 Inch*	5	U51000.037.0700	1/2-13X12 Inch*	1	U51000.050.1200
1/4-20X7 Inch*	5	U51000.025.0700	3/8-16X7.1/2*	5	U51000.037.0750			
1/4-20X8 Inch*	5	U51000.025.0800	3/8-16X8 Inch*	5	U51000.037.0800			
			3/8-16X9 Inch	1	U51000.037.0900	9/16-12X1.1/2*	10	U51000.056.0150
			3/8-16X10 Inch	1	U51000.037.1000	9/16-12X1.3/4*	10	U51000.056.0175
5/16-18X1/2 ft*	100	U51000.031.0050	7/16-14X3/4 ft*	25	U51000.043.0075	9/16-12X2 Inch*	5	U51000.056.0200
5/16-18X5/8 ft*	100	U51000.031.0062	7/16-14X7/8 ft*	25	U51000.043.0087	9/16-12X2.1/4*	5	U51000.056.0225
5/16-18X3/4 ft*	100	U51000.031.0075	7/16-14X1 Inch ft*	25	U51000.043.0100	9/16-12X2.1/2*	5	U51000.056.0250
5/16-18X7/8 ft*	50	U51000.031.0087	7/16-14X1.1/4*	25	U51000.043.0125	9/16-12X2.3/4*	5	U51000.056.0275
5/16-18X1 Inch*	50	U51000.031.0100	7/16-14X1.1/2*	25	U51000.043.0150	9/16-12X3 Inch*	5	U51000.056.0300
5/16-18X1.1/8	25	U51000.031.0112	7/16-14X1.3/4*	10	U51000.043.0175	9/16-12X3.1/4*	5	U51000.056.0325
5/16-18X1.1/4*	50	U51000.031.0125	7/16-14X2 Inch*	10	U51000.043.0200	9/16-12X3.1/2*	5	U51000.056.0350
5/16-18X1.3/8*	50	U51000.031.0137	7/16-14X2.1/4*	10	U51000.043.0225	9/16-12X3.3/4*	5	U51000.056.0375
5/16-18X1.1/2*	50	U51000.031.0150	7/16-14X2.1/2*	10	U51000.043.0250	9/16-12X4 Inch*	5	U51000.056.0400
5/16-18X1.3/4*	50	U51000.031.0175	7/16-14X2.3/4*	10	U51000.043.0275	9/16-12X4.1/2*	5	U51000.056.0450
5/16-18X2 Inch*	50	U51000.031.0200	7/16-14X3 Inch*	10	U51000.043.0300	9/16-12X5 Inch*	5	U51000.056.0500
5/16-18X2.1/4*	25	U51000.031.0225	7/16-14X3.1/2*	5	U51000.043.0350	9/16-12X5.1/2*	5	U51000.056.0550
5/16-18X2.1/2*	25	U51000.031.0250	7/16-14X4 Inch*	5	U51000.043.0400	9/16-12X6 Inch*	5	U51000.056.0600
5/16-18X2.3/4*	25	U51000.031.0275	7/16-14X4.1/2*	5	U51000.043.0450			
5/16-18X3 Inch*	25	U51000.031.0300	7/16-14X5 Inch*	5	U51000.043.0500	5/8-11X1 Inch ft*	10	U51000.062.0100
5/16-18X3.1/4*	25	U51000.031.0325	7/16-14X6 Inch*	5	U51000.043.0600	5/8-11X1.1/4 ft*	10	U51000.062.0125
5/16-18X3.1/2*	25	U51000.031.0350	7/16-14X7 Inch*	5	U51000.043.0700	5/8-11X1.1/2 ft*	10	U51000.062.0150
5/16-18X3.3/4*	25	U51000.031.0375	7/16-14X8 Inch*	5	U51000.043.0800	5/8-11X1.3/4*	10	U51000.062.0175
5/16-18X4 Inch*	10	U51000.031.0400				5/8-11X2 Inch*	5	U51000.062.0200
5/16-18X4.1/2*	10	U51000.031.0450				5/8-11X2.1/4*	5	U51000.062.0225
5/16-18X5 Inch*	10	U51000.031.0500				5/8-11X2.1/2*	5	U51000.062.0250
5/16-18X5.1/2*	10	U51000.031.0550				5/8-11X2.3/4*	5	U51000.062.0275
5/16-18X6 Inch*	10	U51000.031.0600	1/2-13X1/2 ft	25	U51000.050.0050	5/8-11X3 Inch*	5	U51000.062.0300
5/16-18X7 Inch*	5	U51000.031.0700	1/2-13X5/8 ft	1	U51000.050.0062	5/8-11X3.1/4*	5	U51000.062.0325
			1/2-13X3/4 ft*	10	U51000.050.0075	5/8-11X3.1/2*	5	U51000.062.0350
			1/2-13X7/8 ft*	10	U51000.050.0087	5/8-11X3.3/4*	5	U51000.062.0375
3/8-16X1/2 ft*	50	U51000.037.0050	1/2-13X1 Inch ft*	10	U51000.050.0100	5/8-11X4 Inch*	5	U51000.062.0400
3/8-16X5/8 ft*	50	U51000.037.0062	1/2-13X1.1/4 ft*	10	U51000.050.0125			

U51000 Hexagon head bolt UNC								
d x L	☒	Art.number	d x L	☒	Art.number	d x L	☒	Art.number
5/8-11X4.1/4*	5	U51000.062.0425	3/4-10X5.1/2*	5	U51000.075.0550	1.-8X2.1/2*	5	U51000.100.0250
5/8-11X4.1/2*	5	U51000.062.0450	3/4-10X6 Inch*	5	U51000.075.0600	1.-8X2.3/4*	5	U51000.100.0275
5/8-11X4.3/4*	5	U51000.062.0475	3/4-10X6.1/2*	5	U51000.075.0650	1.-8X3 Inch*	5	U51000.100.0300
5/8-11X5 Inch*	5	U51000.062.0500	3/4-10X7 Inch*	5	U51000.075.0700	1.-8X3.1/4*	5	U51000.100.0325
5/8-11X5.1/4	5	U51000.062.0525	3/4-10X7.1/2*	5	U51000.075.0750	1.-8X3.1/2*	5	U51000.100.0350
5/8-11X5.1/2*	5	U51000.062.0550	3/4-10X8 Inch*	5	U51000.075.0800	1.-8X4 Inch*	5	U51000.100.0400
5/8-11X6 Inch*	5	U51000.062.0600	3/4-10X9 Inch	1	U51000.075.0900	1.-8X4.1/4*	5	U51000.100.0425
5/8-11X6.1/2*	5	U51000.062.0650	3/4-10X10 Inch	1	U51000.075.1000	1.-8X4.1/2*	5	U51000.100.0450
5/8-11X7 Inch*	5	U51000.062.0700				1.-8X5 Inch*	5	U51000.100.0500
5/8-11X7.1/2*	5	U51000.062.0750	7/8-9X1.1/2 ft*	5	U51000.087.0150	1.-8X5.1/2*	5	U51000.100.0550
5/8-11X8 Inch*	5	U51000.062.0800	7/8-9X1.3/4 ft*	5	U51000.087.0175	1.-8X6 Inch*	5	U51000.100.0600
5/8-11X8.1/2*	1	U51000.062.0850	7/8-9X2 Inch ft*	5	U51000.087.0200	1.-8X6.1/2*	1	U51000.100.0650
5/8-11X9 Inch*	1	U51000.062.0900	7/8-9X2.1/4*	5	U51000.087.0225	1.-8X7 Inch*	1	U51000.100.0700
5/8-11X9.1/2*	1	U51000.062.0950	7/8-9X2.1/2*	5	U51000.087.0250	1.-8X8 Inch*	1	U51000.100.0800
5/8-11X10 Inch*	1	U51000.062.1000	7/8-9X2.3/4*	5	U51000.087.0275	1.-8X9 Inch*	1	U51000.100.0900
5/8-11X11 Inch*	1	U51000.062.1100	7/8-9X3 Inch*	5	U51000.087.0300	1.-8X10 Inch*	1	U51000.100.1000
5/8-11X12 Inch*	1	U51000.062.1200	7/8-9X3.1/4*	5	U51000.087.0325			
			7/8-9X3.1/2*	5	U51000.087.0350	1.1/8-7X2.1/2 ft*	1	U51000.112.0250
3/4-10X1 Inch ft*	5	U51000.075.0100	7/8-9X3.3/4*	5	U51000.087.0375	1.1/8-7X3 Inch*	1	U51000.112.0300
3/4-10X1.1/4 ft*	5	U51000.075.0125	7/8-9X4 Inch*	5	U51000.087.0400	1.1/8-7X3.1/2*	1	U51000.112.0350
3/4-10X1.1/2 ft*	5	U51000.075.0150	7/8-9X4.1/4*	5	U51000.087.0425	1.1/8-7X4 Inch*	1	U51000.112.0400
3/4-10X1.3/4 ft*	5	U51000.075.0175	7/8-9X4.1/2*	5	U51000.087.0450	1.1/8-7X5 Inch*	1	U51000.112.0500
3/4-10X2 Inch*	5	U51000.075.0200	7/8-9X4.3/4	1	U51000.087.0475	1.1/8-7X6 Inch*	1	U51000.112.0600
3/4-10X2.1/4*	5	U51000.075.0225	7/8-9X5 Inch*	5	U51000.087.0500	1.1/8-7X7 Inch*	1	U51000.112.0700
3/4-10X2.1/2*	5	U51000.075.0250	7/8-9X5.1/2*	5	U51000.087.0550	1.1/8-7X8 Inch*	1	U51000.112.0800
3/4-10X2.3/4*	5	U51000.075.0275	7/8-9X6 Inch*	5	U51000.087.0600			
3/4-10X3 Inch*	5	U51000.075.0300	7/8-9X6.1/2*	5	U51000.087.0650	1.1/4-7X2.1/2 ft*	1	U51000.125.0250
3/4-10X3.1/4*	5	U51000.075.0325	7/8-9X7 Inch*	5	U51000.087.0700	1.1/4-7X3 Inch*	1	U51000.125.0300
3/4-10X3.1/2*	5	U51000.075.0350	7/8-9X7.1/2*	1	U51000.087.0750	1.1/4-7X4 Inch*	1	U51000.125.0400
3/4-10X3.3/4*	5	U51000.075.0375	7/8-9X8 Inch*	1	U51000.087.0800	1.1/4-7X5 Inch*	1	U51000.125.0500
3/4-10X4 Inch*	5	U51000.075.0400	7/8-9X9 Inch*	1	U51000.087.0900	1.1/4-7X6 Inch*	1	U51000.125.0600
3/4-10X4.1/4*	5	U51000.075.0425	7/8-9X10 Inch*	1	U51000.087.1000	1.1/4-7X7 Inch*	1	U51000.125.0700
3/4-10X4.1/2*	5	U51000.075.0450				1.1/4-7X8 Inch*	1	U51000.125.0800
3/4-10X4.3/4*	5	U51000.075.0475	1.-8X2 Inch ft*	5	U51000.100.0200	1.1/4-7X9 Inch*	1	U51000.125.0900
3/4-10X5 Inch*	5	U51000.075.0500	1.-8X2.1/4 ft*	5	U51000.100.0225			

* ft = fully threaded

U55000 Hexagon head bolt UNC		X15A
Thread	Unified National Coarse	
Material	Stainless steel A4 (AISI 316/18-10)	
Class	F593	
		

d x L	☒	Art.number	d x L	☒	Art.number	d x L	☒	Art.number
1/4-20X1/2 ft*	100	U55000.025.0050	5/16-18X2.1/4*	25	U55000.031.0225	3/8-16X6.1/2*	5	U55000.037.0650
1/4-20X5/8 ft*	100	U55000.025.0062	5/16-18X2.1/2*	25	U55000.031.0250	3/8-16X7 Inch*	5	U55000.037.0700
1/4-20X3/4 ft*	100	U55000.025.0075	5/16-18X2.3/4*	25	U55000.031.0275	3/8-16X7.1/2*	5	U55000.037.0750
1/4-20X7/8*	100	U55000.025.0087	5/16-18X3 Inch*	25	U55000.031.0300	3/8-16X8 Inch*	5	U55000.037.0800
1/4-20X1 Inch*	100	U55000.025.0100	5/16-18X3.1/2*	25	U55000.031.0350			
1/4-20X1.1/4*	100	U55000.025.0125	5/16-18X4 Inch*	10	U55000.031.0400	7/16-14X1 Inch ft*	25	U55000.043.0100
1/4-20X1.3/8*	100	U55000.025.0137	5/16-18X5 Inch*	10	U55000.031.0500	7/16-14X1.1/4*	25	U55000.043.0125
1/4-20X1.1/2*	100	U55000.025.0150	5/16-18X6 Inch*	10	U55000.031.0600	7/16-14X1.1/2*	25	U55000.043.0150
1/4-20X1.3/4*	100	U55000.025.0175				7/16-14X2 Inch*	10	U55000.043.0200
1/4-20X1.7/8	10	U55000.025.0187	3/8-16X1/2 ft*	50	U55000.037.0050	7/16-14X2.1/2*	10	U55000.043.0250
1/4-20X2 Inch*	50	U55000.025.0200	3/8-16X5/8 ft*	50	U55000.037.0062	7/16-14X3 Inch*	10	U55000.043.0300
1/4-20X2.1/4*	50	U55000.025.0225	3/8-16X3/4 ft*	50	U55000.037.0075	7/16-14X3.1/2*	5	U55000.043.0350
1/4-20X2.1/2*	50	U55000.025.0250	3/8-16X7/8 ft*	50	U55000.037.0087	7/16-14X4 Inch*	5	U55000.043.0400
1/4-20X2.3/4*	50	U55000.025.0275	3/8-16X1 Inch ft*	50	U55000.037.0100			
1/4-20X3 Inch*	25	U55000.025.0300	3/8-16X1.1/8	10	U55000.037.0112	1/2-13X3/4 ft*	10	U55000.050.0075
1/4-20X3.1/4*	25	U55000.025.0325	3/8-16X1.1/4*	50	U55000.037.0125	1/2-13X7/8 ft*	10	U55000.050.0087
1/4-20X3.1/2*	25	U55000.025.0350	3/8-16X1.1/2*	25	U55000.037.0150	1/2-13X1 Inch ft*	10	U55000.050.0100
1/4-20X3.3/4*	25	U55000.025.0375	3/8-16X1.3/4*	25	U55000.037.0175	1/2-13X1.1/4 ft*	10	U55000.050.0125
1/4-20X4 Inch*	25	U55000.025.0400	3/8-16X2 Inch*	25	U55000.037.0200	1/2-13X1.1/2*	10	U55000.050.0150
1/4-20X4.1/4*	25	U55000.025.0425	3/8-16X2.1/4*	25	U55000.037.0225	1/2-13X1.3/4*	10	U55000.050.0175
1/4-20X4.1/2*	25	U55000.025.0450	3/8-16X2.1/2*	25	U55000.037.0250	1/2-13X2 Inch*	10	U55000.050.0200
1/4-20X5 Inch*	25	U55000.025.0500	3/8-16X2.3/4*	25	U55000.037.0275	1/2-13X2.1/4*	10	U55000.050.0225
1/4-20X5.1/2*	10	U55000.025.0550	3/8-16X3 Inch*	10	U55000.037.0300	1/2-13X2.1/2*	10	U55000.050.0250
1/4-20X6 Inch*	10	U55000.025.0600	3/8-16X3.1/4*	10	U55000.037.0325	1/2-13X2.3/4*	10	U55000.050.0275
			3/8-16X3.1/2*	10	U55000.037.0350	1/2-13X3 Inch*	5	U55000.050.0300
5/16-18X1/2 ft*	100	U55000.031.0050	3/8-16X3.3/4*	10	U55000.037.0375	1/2-13X3.1/4*	5	U55000.050.0325
5/16-18X5/8 ft*	100	U55000.031.0062	3/8-16X4 Inch*	10	U55000.037.0400	1/2-13X3.1/2*	5	U55000.050.0350
5/16-18X3/4 ft*	100	U55000.031.0075	3/8-16X4.1/4*	10	U55000.037.0425	1/2-13X3.3/4*	5	U55000.050.0375
5/16-18X7/8 ft*	50	U55000.031.0087	3/8-16X4.1/2*	10	U55000.037.0450	1/2-13X4 Inch*	5	U55000.050.0400
5/16-18X1 Inch*	50	U55000.031.0100	3/8-16X4.3/4*	10	U55000.037.0475	1/2-13X4.1/4*	5	U55000.050.0425
5/16-18X1.1/4*	50	U55000.031.0125	3/8-16X5 Inch*	10	U55000.037.0500	1/2-13X4.1/2*	5	U55000.050.0450
5/16-18X1.1/2*	50	U55000.031.0150	3/8-16X5.1/2*	10	U55000.037.0550	1/2-13X4.3/4*	5	U55000.050.0475
5/16-18X1.3/4*	50	U55000.031.0175	3/8-16X5.3/4*	10	U55000.037.0575	1/2-13X5 Inch*	5	U55000.050.0500
5/16-18X2 Inch*	50	U55000.031.0200	3/8-16X6 Inch*	10	U55000.037.0600	1/2-13X5.1/2*	5	U55000.050.0550

U55000 Hexagon head bolt UNC								
d x L	☒	Art.number	d x L	☒	Art.number	d x L	☒	Art.number
1/2-13X6 Inch*	5	U55000.050.0600	3/4-10X1.1/4 ft*	5	U55000.075.0125	7/8-9X9 Inch*	1	U55000.087.0900
1/2-13X6.1/2*	5	U55000.050.0650	3/4-10X1.1/2 ft*	5	U55000.075.0150	7/8-9X10 Inch*	1	U55000.087.1000
1/2-13X7 Inch*	5	U55000.050.0700	3/4-10X1.3/4 ft*	5	U55000.075.0175			
1/2-13X7.1/2*	5	U55000.050.0750	3/4-10X2 Inch*	5	U55000.075.0200	1.-8X2 Inch ft*	5	U55000.100.0200
1/2-13X8 Inch*	5	U55000.050.0800	3/4-10X2.1/4*	5	U55000.075.0225	1.-8X2.1/4 ft*	5	U55000.100.0225
1/2-13X8.1/2*	1	U55000.050.0850	3/4-10X2.1/2*	5	U55000.075.0250	1.-8X2.1/2*	5	U55000.100.0250
1/2-13X9 Inch*	1	U55000.050.0900	3/4-10X2.3/4*	5	U55000.075.0275	1.-8X2.3/4*	5	U55000.100.0275
1/2-13X10 Inch*	1	U55000.050.1000	3/4-10X3 Inch*	5	U55000.075.0300	1.-8X3 Inch*	5	U55000.100.0300
1/2-13X11 Inch*	1	U55000.050.1100	3/4-10X3.1/4*	5	U55000.075.0325	1.-8X3.1/4*	5	U55000.100.0325
1/2-13X12 Inch*	1	U55000.050.1200	3/4-10X3.1/2*	5	U55000.075.0350	1.-8X3.1/2*	5	U55000.100.0350
			3/4-10X3.3/4*	5	U55000.075.0375	1.-8X3.3/4*	5	U55000.100.0375
5/8-11X1 Inch ft*	10	U55000.062.0100	3/4-10X4 Inch*	5	U55000.075.0400	1.-8X4 Inch*	5	U55000.100.0400
5/8-11X1.1/4 ft*	10	U55000.062.0125	3/4-10X4.1/4*	5	U55000.075.0425	1.-8X4.1/4*	5	U55000.100.0425
5/8-11X1.1/2 ft*	10	U55000.062.0150	3/4-10X4.1/2*	5	U55000.075.0450	1.-8X4.1/2*	5	U55000.100.0450
5/8-11X1.3/4*	10	U55000.062.0175	3/4-10X4.3/4*	5	U55000.075.0475	1.-8X5 Inch*	5	U55000.100.0500
5/8-11X2 Inch*	5	U55000.062.0200	3/4-10X5 Inch*	5	U55000.075.0500	1.-8X5.1/2*	5	U55000.100.0550
5/8-11X2.1/4*	5	U55000.062.0225	3/4-10X5.1/2*	5	U55000.075.0550	1.-8X6 Inch*	5	U55000.100.0600
5/8-11X2.1/2*	5	U55000.062.0250	3/4-10X6 Inch*	5	U55000.075.0600	1.-8X6.1/2*	1	U55000.100.0650
5/8-11X2.3/4*	5	U55000.062.0275	3/4-10X6.1/2*	5	U55000.075.0650	1.-8X7 Inch*	1	U55000.100.0700
5/8-11X3 Inch*	5	U55000.062.0300	3/4-10X7 Inch*	5	U55000.075.0700	1.-8X7.1/2*	1	U55000.100.0750
5/8-11X3.1/4*	5	U55000.062.0325	3/4-10X7.1/2*	5	U55000.075.0750	1.-8X8 Inch*	1	U55000.100.0800
5/8-11X3.1/2*	5	U55000.062.0350	3/4-10X8 Inch*	5	U55000.075.0800	1.-8X9 Inch*	1	U55000.100.0900
5/8-11X3.3/4*	5	U55000.062.0375				1.-8X10 Inch*	1	U55000.100.1000
5/8-11X4 Inch*	5	U55000.062.0400	7/8-9X1.1/2 ft*	5	U55000.087.0150			
5/8-11X4.1/4*	5	U55000.062.0425	7/8-9X1.3/4 ft*	5	U55000.087.0175	1.1/8-7X2.1/2 ft*	1	U55000.112.0250
5/8-11X4.1/2*	5	U55000.062.0450	7/8-9X2 Inch ft*	5	U55000.087.0200	1.1/8-7X3 Inch*	1	U55000.112.0300
5/8-11X4.3/4*	5	U55000.062.0475	7/8-9X2.1/4*	5	U55000.087.0225	1.1/8-7X3.1/2*	1	U55000.112.0350
5/8-11X5 Inch*	5	U55000.062.0500	7/8-9X2.1/2*	5	U55000.087.0250	1.1/8-7X4 Inch*	1	U55000.112.0400
5/8-11X51/4	5	U55000.062.0525	7/8-9X2.3/4*	5	U55000.087.0275	1.1/8-7X5 Inch*	1	U55000.112.0500
5/8-11X5.1/2*	5	U55000.062.0550	7/8-9X3 Inch*	5	U55000.087.0300	1.1/8-7X6 Inch*	1	U55000.112.0600
5/8-11X6 Inch*	5	U55000.062.0600	7/8-9X3.1/4*	5	U55000.087.0325	1.1/8-7X7 Inch*	1	U55000.112.0700
5/8-11X6.1/2*	5	U55000.062.0650	7/8-9X3.1/2*	5	U55000.087.0350	1.1/8-7X8 Inch*	1	U55000.112.0800
5/8-11X7 Inch*	5	U55000.062.0700	7/8-9X3.3/4*	5	U55000.087.0375			
5/8-11X7.1/2*	5	U55000.062.0750	7/8-9X4 Inch*	5	U55000.087.0400	1.1/4-7X2.1/2 ft*	1	U55000.125.0250
5/8-11X8 Inch*	5	U55000.062.0800	7/8-9X4.1/4*	5	U55000.087.0425	1.1/4-7X3 Inch*	1	U55000.125.0300
5/8-11X8.1/2*	1	U55000.062.0850	7/8-9X4.1/2*	5	U55000.087.0450	1.1/4-7X4 Inch*	1	U55000.125.0400
5/8-11X9 Inch*	1	U55000.062.0900	7/8-9X5 Inch*	5	U55000.087.0500	1.1/4-7X5 Inch*	1	U55000.125.0500
5/8-11X9.1/2*	1	U55000.062.0950	7/8-9X5.1/2*	5	U55000.087.0550	1.1/4-7X6 Inch*	1	U55000.125.0600
5/8-11X10 Inch*	1	U55000.062.1000	7/8-9X6 Inch*	5	U55000.087.0600	1.1/4-7X7 Inch*	1	U55000.125.0700
5/8-11X11 Inch*	1	U55000.062.1100	7/8-9X6.1/2*	5	U55000.087.0650	1.1/4-7X8 Inch*	1	U55000.125.0800
5/8-11X12 Inch*	1	U55000.062.1200	7/8-9X7 Inch*	5	U55000.087.0700	1.1/4-7X9 Inch*	1	U55000.125.0900
			7/8-9X7.1/2*	1	U55000.087.0750			
3/4-10X1 Inch ft	5	U55000.075.0100	7/8-9X8 Inch*	1	U55000.087.0800			

• ft = fully threaded

1 Hexagon head bolt UNF

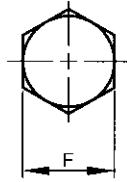
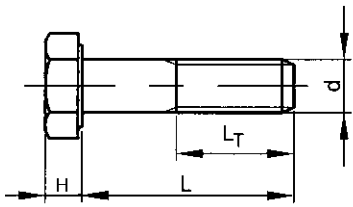

ASME ≈B18.2.1
BS ≈1768

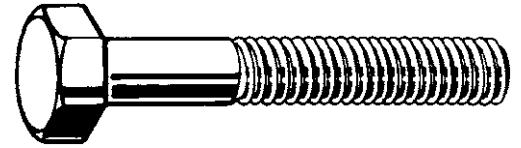

Technical Data

d	L _T (min.): L≤6 Inch	L _T (min.): L>6 Inch	F	H	Threads per inch
1/4	0.75	1	7/16	5/32	28
5/16	0.875	1.125	1/2	13/64	24
3/8	1	1.25	9/16	15/64	24
7/16	1.125	1.375	5/8	9/32	20
1/2	1.25	1.50	3/4	5/16	20
9/16	1.375	1.625	13/16	23/64	18
5/8	1.5	1.75	15/16	25/64	18
3/4	1.75	2	1.1/8	15/32	16
7/8	2	2.25	1.5/16	35/64	14
1 Inch	2.25	2.5	1.1/2	39/64	12
1.1/8	2.5	2.75	1.11/16	11/16	12
1.1/4	2.75	3	1.7/8	25/32	12
1.1/2	3.25	3.5	2.1/4	15/46	12

Article groups

Thread	Driving features	Material	Class	Surface treatment	Code	Page
UNF	Hexagon	St	Grade 5		U01060	1-52
UNF	Hexagon	St	Grade 5	Zipl	U01062	1-53
UNF	Hexagon	St	Grade 8		U04160	1-54
UNF	Hexagon	St	Grade 8	Zipl yell.p.	U04360	1-56
UNF	Hexagon	St.St. A2 (AISI304/18-8)	F593		U51007	1-57

U01060 Hexagon head bolt UNF

X01A

Thread Unified National Fine
Material Steel
Class Grade 5

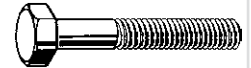

d x L	☒	Art.number	d x L	☒	Art.number	d x L	☒	Art.number
1/4-28X1/2 ft*	100	U01060.025.0050	5/16-24X1.1/4*	100	U01060.031.0125	3/8-24X3 Inch*	25	U01060.037.0300
1/4-28X5/8 ft*	100	U01060.025.0062	5/16-24X1.1/2*	100	U01060.031.0150	3/8-24X3.1/4*	25	U01060.037.0325
1/4-28X3/4 ft*	100	U01060.025.0075	5/16-24X1.3/4*	50	U01060.031.0175	3/8-24X3.1/2*	25	U01060.037.0350
1/4-28X7/8*	100	U01060.025.0087	5/16-24X2 Inch*	50	U01060.031.0200	3/8-24X3.3/4*	25	U01060.037.0375
1/4-28X1 Inch*	100	U01060.025.0100	5/16-24X2.1/4*	50	U01060.031.0225	3/8-24X4 Inch*	10	U01060.037.0400
1/4-28X1.1/4*	100	U01060.025.0125	5/16-24X2.1/2*	50	U01060.031.0250	3/8-24X4.1/4*	10	U01060.037.0425
1/4-28X1.3/8*	100	U01060.025.0137	5/16-24X2.3/4*	50	U01060.031.0275	3/8-24X4.1/2*	10	U01060.037.0450
1/4-28X1.1/2*	100	U01060.025.0150	5/16-24X3 Inch*	50	U01060.031.0300	3/8-24X4.3/4*	10	U01060.037.0475
1/4-28X1.3/4*	100	U01060.025.0175	5/16-24X3.1/4*	50	U01060.031.0325	3/8-24X5 Inch*	10	U01060.037.0500
1/4-28X2 Inch*	50	U01060.025.0200	5/16-24X3.1/2*	50	U01060.031.0350	3/8-24X5.1/4*	10	U01060.037.0525
1/4-28X2.1/4*	50	U01060.025.0225	5/16-24X3.3/4*	25	U01060.031.0375	3/8-24X5.1/2*	10	U01060.037.0550
1/4-28X2.1/2*	50	U01060.025.0250	5/16-24X4 Inch*	25	U01060.031.0400	3/8-24X5.3/4*	10	U01060.037.0575
1/4-28X2.3/4*	50	U01060.025.0275	5/16-24X4.1/2*	25	U01060.031.0450	3/8-24X6 Inch*	10	U01060.037.0600
1/4-28X3 Inch*	50	U01060.025.0300	5/16-24X5 Inch*	25	U01060.031.0500	3/8-24X6.1/2*	10	U01060.037.0650
1/4-28X3.1/4*	50	U01060.025.0325	5/16-24X5.1/2*	25	U01060.031.0550	3/8-24X8 Inch*	5	U01060.037.0800
1/4-28X3.1/2*	50	U01060.025.0350	5/16-24X6 Inch*	25	U01060.031.0600	3/8-24X10 Inch*	5	U01060.037.1000
1/4-28X3.3/4*	50	U01060.025.0375	5/16-24X7 Inch*	10	U01060.031.0700			
1/4-28X4 Inch*	25	U01060.025.0400						
1/4-28X4.1/2*	25	U01060.025.0450	3/8-24X1/2 ft*	50	U01060.037.0050	7/16-20X3/4 ft*	25	U01060.043.0075
1/4-28X5 Inch*	25	U01060.025.0500	3/8-24X5/8 ft*	50	U01060.037.0062	7/16-20X7/8 ft*	25	U01060.043.0087
1/4-28X5.1/2*	25	U01060.025.0550	3/8-24X3/4 ft*	50	U01060.037.0075	7/16-20X1 Inch ft*	25	U01060.043.0100
1/4-28X6 Inch*	25	U01060.025.0600	3/8-24X7/8 ft*	50	U01060.037.0087	7/16-20X1.1/4*	25	U01060.043.0125
1/4-28X7 Inch*	10	U01060.025.0700	3/8-24X1 Inch ft*	50	U01060.037.0100	7/16-20X1.1/2*	25	U01060.043.0150
1/4-28X8 Inch*	5	U01060.025.0800	3/8-24X1.1/4*	50	U01060.037.0125	7/16-20X1.3/4*	25	U01060.043.0175
			3/8-24X1.1/2*	50	U01060.037.0150	7/16-20X2 Inch*	25	U01060.043.0200
			3/8-24X1.3/4*	50	U01060.037.0175	7/16-20X2.1/4*	10	U01060.043.0225
5/16-24X1/2 ft*	100	U01060.031.0050	3/8-24X2 Inch*	25	U01060.037.0200	7/16-20X2.1/2*	10	U01060.043.0250
5/16-24X5/8 ft*	100	U01060.031.0062	3/8-24X2.1/4*	25	U01060.037.0225	7/16-20X2.3/4*	10	U01060.043.0275
5/16-24X3/4 ft*	100	U01060.031.0075	3/8-24X2.1/2*	25	U01060.037.0250	7/16-20X3 Inch*	10	U01060.043.0300
5/16-24X7/8 ft*	100	U01060.031.0087	3/8-24X2.3/4*	25	U01060.037.0275	7/16-20X3.1/4*	10	U01060.043.0325
5/16-24X1 Inch*	100	U01060.031.0100				7/16-20X3.1/2*	10	U01060.043.0350

U01062 Hexagon head bolt UNF								
d x L	☒	Art.number	d x L	☒	Art.number	d x L	☒	Art.number
5/16-24X5 Inch*	25	U01062.031.0500	1/2-20X3/4 ft*	25	U01062.050.0075	5/8-18X4.3/4*	5	U01062.062.0475
5/16-24X5.1/2*	25	U01062.031.0550	1/2-20X1 Inch ft*	25	U01062.050.0100	5/8-18X5 Inch*	5	U01062.062.0500
5/16-24X6 Inch*	25	U01062.031.0600	1/2-20X1.1/4 ft*	25	U01062.050.0125	5/8-18X5.1/2*	5	U01062.062.0550
3/8-24X1/2 ft*	50	U01062.037.0050	1/2-20X1.1/2*	25	U01062.050.0150	5/8-18X6 Inch*	5	U01062.062.0600
3/8-24X5/8 ft*	50	U01062.037.0062	1/2-20X2 Inch*	10	U01062.050.0200	5/8-18X7 Inch*	5	U01062.062.0700
3/8-24X3/4 ft*	50	U01062.037.0075	1/2-20X2.1/4*	10	U01062.050.0225	5/8-18X8 Inch*	5	U01062.062.0800
3/8-24X7/8 ft*	50	U01062.037.0087	1/2-20X2.1/2*	10	U01062.050.0250	5/8-18X8.1/2*	5	U01062.062.0850
3/8-24X1 Inch ft*	50	U01062.037.0100	1/2-20X2.3/4*	10	U01062.050.0275	5/8-18X9 Inch*	5	U01062.062.0900
3/8-24X1.1/4*	50	U01062.037.0125	1/2-20X3 Inch*	10	U01062.050.0300	5/8-18X10 Inch*	5	U01062.062.1000
3/8-24X1.1/2*	50	U01062.037.0150	1/2-20X3.1/2*	10	U01062.050.0350			
3/8-24X1.3/4*	50	U01062.037.0175	1/2-20X4 Inch*	5	U01062.050.0400	3/4-16X1 Inch ft*	10	U01062.075.0100
3/8-24X2 Inch*	25	U01062.037.0200	1/2-20X4.1/4*	5	U01062.050.0425	3/4-16X1.1/2 ft*	10	U01062.075.0150
3/8-24X2.1/4*	25	U01062.037.0225	1/2-20X4.1/2*	5	U01062.050.0450	3/4-16X2 Inch*	5	U01062.075.0200
3/8-24X2.1/2*	25	U01062.037.0250	1/2-20X4.3/4*	5	U01062.050.0475	3/4-16X2.1/4*	5	U01062.075.0225
3/8-24X2.3/4*	25	U01062.037.0275	1/2-20X5 Inch*	5	U01062.050.0500	3/4-16X2.1/2*	5	U01062.075.0250
3/8-24X3 Inch*	25	U01062.037.0300	1/2-20X5.1/2*	5	U01062.050.0550	3/4-16X2.3/4*	5	U01062.075.0275
3/8-24X3.1/2*	25	U01062.037.0350	1/2-20X6 Inch*	5	U01062.050.0600	3/4-16X3 Inch*	5	U01062.075.0300
3/8-24X4 Inch*	10	U01062.037.0400	1/2-20X7 Inch*	5	U01062.050.0700	3/4-16X3.1/2*	5	U01062.075.0350
3/8-24X4.1/4*	10	U01062.037.0425	1/2-20X8 Inch*	5	U01062.050.0800	3/4-16X4 Inch*	5	U01062.075.0400
3/8-24X4.1/2*	10	U01062.037.0450	1/2-20X10 Inch*	5	U01062.050.1000	3/4-16X4.1/4*	5	U01062.075.0425
3/8-24X4.3/4*	10	U01062.037.0475	1/2-20X12 Inch*	5	U01062.050.1200	3/4-16X4.1/2*	5	U01062.075.0450
3/8-24X5 Inch*	10	U01062.037.0500				3/4-16X4.3/4*	5	U01062.075.0475
3/8-24X5.1/4*	10	U01062.037.0525	9/16-18X1 Inch ft*	25	U01062.056.0100	3/4-16X5 Inch*	5	U01062.075.0500
3/8-24X5.1/2*	10	U01062.037.0550	9/16-18X1.1/2*	25	U01062.056.0150	3/4-16X5.1/2*	5	U01062.075.0550
3/8-24X5.3/4*	10	U01062.037.0575	9/16-18X1.3/4*	10	U01062.056.0175	3/4-16X6 Inch*	5	U01062.075.0600
3/8-24X6 Inch*	10	U01062.037.0600	9/16-18X2 Inch*	10	U01062.056.0200	3/4-16X6.1/2*	1	U01062.075.0650
3/8-24X6.1/2*	10	U01062.037.0650	9/16-18X2.1/2*	10	U01062.056.0250	3/4-16X8 Inch*	1	U01062.075.0800
3/8-24X8 Inch*	5	U01062.037.0800	9/16-18X3 Inch*	10	U01062.056.0300			
3/8-24X10 Inch*	5	U01062.037.1000	9/16-18X3.1/2*	10	U01062.056.0350	7/8-14X2 Inch ft*	5	U01062.087.0200
			9/16-18X4 Inch*	5	U01062.056.0400	7/8-14X2.1/2*	5	U01062.087.0250
			9/16-18X4.1/2*	5	U01062.056.0450	7/8-14X3 Inch*	5	U01062.087.0300
			9/16-18X5 Inch*	5	U01062.056.0500	7/8-14X3.1/2*	5	U01062.087.0350
			9/16-18X6 Inch*	5	U01062.056.0600	7/8-14X4 Inch*	5	U01062.087.0400
						7/8-14X5 Inch*	5	U01062.087.0500
			5/8-18X1 Inch ft*	10	U01062.062.0100	7/8-14X5.1/2*	5	U01062.087.0550
			5/8-18X1.1/2 ft*	10	U01062.062.0150	7/8-14X6 Inch*	1	U01062.087.0600
			5/8-18X1.3/4*	10	U01062.062.0175	7/8-14X7 Inch*	1	U01062.087.0700
			5/8-18X2 Inch*	5	U01062.062.0200	7/8-14X8 Inch*	1	U01062.087.0800
			5/8-18X2.1/4*	5	U01062.062.0225			
			5/8-18X2.1/2*	5	U01062.062.0250	1.-14X2 Inch ft*	5	U01062.101.0200
			5/8-18X2.3/4*	5	U01062.062.0275	1.-14X3.1/2*	5	U01062.101.0350
			5/8-18X3 Inch*	5	U01062.062.0300	1.-14X4 Inch*	5	U01062.101.0400
			5/8-18X3.1/4*	5	U01062.062.0325	1.-14X5 Inch*	5	U01062.101.0500
			5/8-18X3.1/2*	5	U01062.062.0350	1.-14X6 Inch*	1	U01062.101.0600
			5/8-18X4 Inch*	5	U01062.062.0400	1.-14X8 Inch*	1	U01062.101.0800
			5/8-18X4.1/4*	5	U01062.062.0425			
			5/8-18X4.1/2*	5	U01062.062.0450			

* ft = fully threaded

U04160 Hexagon head bolt UNF		X01A
Thread Material Class	Unified National Fine Steel Grade 8	
		

d x L	☒	Art.number	d x L	☒	Art.number	d x L	☒	Art.number
1/4-28X1/2 ft*	100	U04160.025.0050	1/4-28X7 Inch*	10	U04160.025.0700	5/16-24X6 Inch*	25	U04160.031.0600
1/4-28X5/8 ft*	100	U04160.025.0062				5/16-24X7 Inch*	10	U04160.031.0700
1/4-28X3/4 ft*	100	U04160.025.0075	5/16-24X1/2 ft*	100	U04160.031.0050			
1/4-28X7/8*	100	U04160.025.0087	5/16-24X5/8 ft*	100	U04160.031.0062	3/8-24X1/2 ft*	50	U04160.037.0050
1/4-28X1 Inch*	100	U04160.025.0100	5/16-24X3/4 ft*	100	U04160.031.0075	3/8-24X5/8 ft*	50	U04160.037.0062
1/4-28X1.1/4*	100	U04160.025.0125	5/16-24X7/8 ft*	100	U04160.031.0087	3/8-24X3/4 ft*	50	U04160.037.0075
1/4-28X1.3/8*	100	U04160.025.0137	5/16-24X1 Inch*	100	U04160.031.0100	3/8-24X7/8 ft*	50	U04160.037.0087
1/4-28X1.1/2*	100	U04160.025.0150	5/16-24X1.1/4*	100	U04160.031.0125	3/8-24X1 Inch ft*	50	U04160.037.0100
1/4-28X1.3/4*	100	U04160.025.0175	5/16-24X1.1/2*	100	U04160.031.0150	3/8-24X1.1/4*	50	U04160.037.0125
1/4-28X2 Inch*	50	U04160.025.0200	5/16-24X1.3/4*	50	U04160.031.0175	3/8-24X1.1/2*	50	U04160.037.0150
1/4-28X2.1/4*	50	U04160.025.0225	5/16-24X2 Inch*	50	U04160.031.0200	3/8-24X1.3/4*	50	U04160.037.0175
1/4-28X2.1/2*	50	U04160.025.0250	5/16-24X2.1/4*	50	U04160.031.0225	3/8-24X2 Inch*	25	U04160.037.0200
1/4-28X2.3/4*	50	U04160.025.0275	5/16-24X2.1/2*	50	U04160.031.0250	3/8-24X2.1/4*	25	U04160.037.0225
1/4-28X3 Inch*	50	U04160.025.0300	5/16-24X2.3/4*	50	U04160.031.0275	3/8-24X2.1/2*	25	U04160.037.0250
1/4-28X3.1/4*	50	U04160.025.0325	5/16-24X3 Inch*	50	U04160.031.0300	3/8-24X2.3/4*	25	U04160.037.0275
1/4-28X3.1/2*	50	U04160.025.0350	5/16-24X3.1/4*	50	U04160.031.0325	3/8-24X3 Inch*	25	U04160.037.0300
1/4-28X3.3/4*	50	U04160.025.0375	5/16-24X3.1/2*	50	U04160.031.0350	3/8-24X3.1/4*	25	U04160.037.0325
1/4-28X4 Inch*	25	U04160.025.0400	5/16-24X3.3/4*	25	U04160.031.0375	3/8-24X3.1/2*	25	U04160.037.0350
1/4-28X4.1/2*	25	U04160.025.0450	5/16-24X4 Inch*	25	U04160.031.0400	3/8-24X3.3/4*	25	U04160.037.0375
1/4-28X5 Inch*	25	U04160.025.0500	5/16-24X4.1/2*	25	U04160.031.0450	3/8-24X4 Inch*	10	U04160.037.0400
1/4-28X5.1/2*	25	U04160.025.0550	5/16-24X5 Inch*	25	U04160.031.0500	3/8-24X4.1/4*	10	U04160.037.0425
1/4-28X6 Inch*	25	U04160.025.0600	5/16-24X5.1/2*	25	U04160.031.0550	3/8-24X4.1/2*	10	U04160.037.0450

U04160 Hexagon head bolt UNF

d x L	☒	Art.number	d x L	☒	Art.number	d x L	☒	Art.number
3/8-24X4.3/4*	10	U04160.037.0475	9/16-18X5.1/2*	5	U04160.056.0550	7/8-14X4 Inch*	5	U04160.087.0400
3/8-24X5 Inch*	10	U04160.037.0500	9/16-18X6 Inch*	5	U04160.056.0600	7/8-14X4.1/2*	5	U04160.087.0450
3/8-24X5.1/4*	10	U04160.037.0525				7/8-14X5 Inch*	5	U04160.087.0500
3/8-24X5.1/2*	10	U04160.037.0550	5/8-18X1 Inch ft*	10	U04160.062.0100	7/8-14X5.1/2*	5	U04160.087.0550
3/8-24X5.3/4*	10	U04160.037.0575	5/8-18X1.1/4 ft*	10	U04160.062.0125	7/8-14X6 Inch*	1	U04160.087.0600
3/8-24X6 Inch*	10	U04160.037.0600	5/8-18X1.1/2 ft*	10	U04160.062.0150	7/8-14X6.1/2*	1	U04160.087.0650
3/8-24X6.1/2*	10	U04160.037.0650	5/8-18X1.3/4*	10	U04160.062.0175	7/8-14X7 Inch*	1	U04160.087.0700
3/8-24X8 Inch*	5	U04160.037.0800	5/8-18X2 Inch*	5	U04160.062.0200	7/8-14X7.1/2*	1	U04160.087.0750
3/8-24X10 Inch*	5	U04160.037.1000	5/8-18X2.1/4*	5	U04160.062.0225	7/8-14X8 Inch*	1	U04160.087.0800
			5/8-18X2.1/2*	5	U04160.062.0250	7/8-14X8.1/2*	1	U04160.087.0850
7/16-20X3/4 ft*	25	U04160.043.0075	5/8-18X2.3/4*	5	U04160.062.0275	7/8-14X9 Inch*	1	U04160.087.0900
7/16-20X1 Inch ft*	25	U04160.043.0100	5/8-18X3 Inch*	5	U04160.062.0300	7/8-14X10 Inch*	1	U04160.087.1000
7/16-20X1.1/4*	25	U04160.043.0125	5/8-18X3.1/4*	5	U04160.062.0325			
7/16-20X1.1/2*	25	U04160.043.0150	5/8-18X3.1/2*	5	U04160.062.0350	1.-14X1.1/2 ft*	5	U04160.101.0150
7/16-20X1.3/4*	25	U04160.043.0175	5/8-18X3.3/4*	5	U04160.062.0375	1.-14X1.3/4 ft*	5	U04160.101.0175
7/16-20X2 Inch*	25	U04160.043.0200	5/8-18X4 Inch*	5	U04160.062.0400	1.-14X2 Inch ft*	5	U04160.101.0200
7/16-20X2.1/4*	10	U04160.043.0225	5/8-18X4.1/4*	5	U04160.062.0425	1.-14X2.1/4 ft*	5	U04160.101.0225
7/16-20X2.1/2*	10	U04160.043.0250	5/8-18X4.1/2*	5	U04160.062.0450	1.-14X2.1/2*	5	U04160.101.0250
7/16-20X2.3/4*	10	U04160.043.0275	5/8-18X4.3/4*	5	U04160.062.0475	1.-14X2.3/4*	5	U04160.101.0275
7/16-20X3 Inch*	10	U04160.043.0300	5/8-18X5 Inch*	5	U04160.062.0500	1.-14X3 Inch*	5	U04160.101.0300
7/16-20X3.1/4*	10	U04160.043.0325	5/8-18X5.1/2*	5	U04160.062.0550	1.-14X3.1/4*	5	U04160.101.0325
7/16-20X3.1/2*	10	U04160.043.0350	5/8-18X6 Inch*	5	U04160.062.0600	1.-14X3.1/2*	5	U04160.101.0350
7/16-20X3.3/4*	10	U04160.043.0375	5/8-18X6.1/2*	5	U04160.062.0650	1.-14X3.3/4*	5	U04160.101.0375
7/16-20X4 Inch*	10	U04160.043.0400	5/8-18X7 Inch*	5	U04160.062.0700	1.-14X4 Inch*	5	U04160.101.0400
7/16-20X4.1/2*	10	U04160.043.0450	5/8-18X7.1/2*	5	U04160.062.0750	1.-14X4.1/2*	5	U04160.101.0450
7/16-20X5 Inch*	10	U04160.043.0500	5/8-18X8 Inch*	5	U04160.062.0800	1.-14X5 Inch*	5	U04160.101.0500
7/16-20X5.1/2*	10	U04160.043.0550	5/8-18X8.1/2*	5	U04160.062.0850	1.-14X5.1/2*	5	U04160.101.0550
7/16-20X6 Inch*	5	U04160.043.0600	5/8-18X9 Inch*	5	U04160.062.0900	1.-14X6 Inch*	1	U04160.101.0600
			5/8-18X9.1/2*	5	U04160.062.0950	1.-14X6.1/2*	1	U04160.101.0650
1/2-20X3/4 ft*	25	U04160.050.0075	5/8-18X10 Inch*	5	U04160.062.1000	1.-14X7 Inch*	1	U04160.101.0700
1/2-20X1 Inch ft*	25	U04160.050.0100	5/8-18X11 Inch*	5	U04160.062.1100	1.-14X7.1/2*	1	U04160.101.0750
1/2-20X1.1/4 ft*	25	U04160.050.0125	5/8-18X12 Inch*	5	U04160.062.1200	1.-14X8 Inch*	1	U04160.101.0800
1/2-20X1.1/2*	25	U04160.050.0150				1.-14X8.1/2*	1	U04160.101.0850
1/2-20X1.3/4*	25	U04160.050.0175	3/4-16X1 Inch ft*	10	U04160.075.0100	1.-14X9 Inch*	1	U04160.101.0900
1/2-20X2 Inch*	10	U04160.050.0200	3/4-16X1.1/4 ft*	10	U04160.075.0125	1.-14X9.1/2*	1	U04160.101.0950
1/2-20X2.1/4*	10	U04160.050.0225	3/4-16X1.1/2 ft*	10	U04160.075.0150	1.-14X10 Inch*	1	U04160.101.1000
1/2-20X2.1/2*	10	U04160.050.0250	3/4-16X1.3/4 ft*	10	U04160.075.0175			
1/2-20X2.3/4*	10	U04160.050.0275	3/4-16X2 Inch*	5	U04160.075.0200	1.1/8-12X2.1/2 ft*	1	U04160.112.0250
1/2-20X3 Inch*	10	U04160.050.0300	3/4-16X2.1/4*	5	U04160.075.0225	1.1/8-12X3 Inch*	1	U04160.112.0300
1/2-20X3.1/4*	10	U04160.050.0325	3/4-16X2.1/2*	5	U04160.075.0250	1.1/8-12X3.1/2*	1	U04160.112.0350
1/2-20X3.1/2*	10	U04160.050.0350	3/4-16X2.3/4*	5	U04160.075.0275	1.1/8-12X4 Inch*	1	U04160.112.0400
1/2-20X3.3/4*	10	U04160.050.0375	3/4-16X3 Inch*	5	U04160.075.0300	1.1/8-12X4.1/2*	1	U04160.112.0450
1/2-20X4 Inch*	5	U04160.050.0400	3/4-16X3.1/4*	5	U04160.075.0325	1.1/8-12X5 Inch*	1	U04160.112.0500
1/2-20X4.1/4*	5	U04160.050.0425	3/4-16X3.1/2*	5	U04160.075.0350	1.1/8-12X5.1/2*	1	U04160.112.0550
1/2-20X4.1/2*	5	U04160.050.0450	3/4-16X3.3/4*	5	U04160.075.0375	1.1/8-12X6 Inch*	1	U04160.112.0600
1/2-20X4.3/4*	5	U04160.050.0475	3/4-16X4 Inch*	5	U04160.075.0400	1.1/8-12X7 Inch*	1	U04160.112.0700
1/2-20X5 Inch*	5	U04160.050.0500	3/4-16X4.1/4*	5	U04160.075.0425	1.1/8-12X8 Inch*	1	U04160.112.0800
1/2-20X5.1/2*	5	U04160.050.0550	3/4-16X4.1/2*	5	U04160.075.0450	1.1/8-12X10 Inch*	1	U04160.112.1000
1/2-20X6 Inch*	5	U04160.050.0600	3/4-16X4.3/4*	5	U04160.075.0475			
1/2-20X6.1/2*	5	U04160.050.0650	3/4-16X5 Inch*	5	U04160.075.0500	1.1/4-12X2 Inch ft*	1	U04160.125.0200
1/2-20X7 Inch*	5	U04160.050.0700	3/4-16X5.1/2*	5	U04160.075.0550	1.1/4-12X3 Inch*	1	U04160.125.0300
1/2-20X7.1/2*	5	U04160.050.0750	3/4-16X6 Inch*	5	U04160.075.0600	1.1/4-12X3.1/2*	1	U04160.125.0350
1/2-20X8 Inch*	5	U04160.050.0800	3/4-16X6.1/2*	1	U04160.075.0650	1.1/4-12X4 Inch*	1	U04160.125.0400
1/2-20X8.1/2*	5	U04160.050.0850	3/4-16X7 Inch*	1	U04160.075.0700	1.1/4-12X4.1/2*	1	U04160.125.0450
1/2-20X10 Inch*	5	U04160.050.1000	3/4-16X7.1/2*	1	U04160.075.0750	1.1/4-12X5 Inch*	1	U04160.125.0500
1/2-20X12 Inch*	5	U04160.050.1200	3/4-16X8 Inch*	1	U04160.075.0800	1.1/4-12X5.1/2*	1	U04160.125.0550
			3/4-16X8.1/2*	1	U04160.075.0850	1.1/4-12X6 Inch*	1	U04160.125.0600
9/16-18X1 Inch ft*	25	U04160.056.0100	3/4-16X9 Inch*	1	U04160.075.0900	1.1/4-12X7 Inch*	1	U04160.125.0700
9/16-18X1.1/4 ft*	25	U04160.056.0125	3/4-16X9.1/2*	1	U04160.075.0950	1.1/4-12X7.1/2*	1	U04160.125.0750
9/16-18X1.1/2*	25	U04160.056.0150	3/4-16X10 Inch*	1	U04160.075.1000	1.1/4-12X8 Inch*	1	U04160.125.0800
9/16-18X1.3/4*	10	U04160.056.0175	3/4-16X11 Inch*	1	U04160.075.1100	1.1/4-12X9 Inch*	1	U04160.125.0900
9/16-18X2 Inch*	10	U04160.056.0200	3/4-16X12 Inch*	1	U04160.075.1200	1.1/4-12X10 Inch*	1	U04160.125.1000
9/16-18X2.1/4*	10	U04160.056.0225						
9/16-18X2.1/2*	10	U04160.056.0250	7/8-14X1.1/2 ft*	5	U04160.087.0150	1.1/2-12X3 Inch ft*	1	U04160.150.0300
9/16-18X2.3/4*	10	U04160.056.0275	7/8-14X2 Inch ft*	5	U04160.087.0200	1.1/2-12X3.1/2*	1	U04160.150.0350
9/16-18X3 Inch*	10	U04160.056.0300	7/8-14X2.1/4*	5	U04160.087.0225	1.1/2-12X4 Inch*	1	U04160.150.0400
9/16-18X3.1/4*	10	U04160.056.0325	7/8-14X2.1/2*	5	U04160.087.0250	1.1/2-12X4.1/2*	1	U04160.150.0450
9/16-18X3.1/2*	10	U04160.056.0350	7/8-14X2.3/4*	5	U04160.087.0275	1.1/2-12X5 Inch*	1	U04160.150.0500
9/16-18X4 Inch*	5	U04160.056.0400	7/8-14X3 Inch*	5	U04160.087.0300	1.1/2-12X6 Inch*	1	U04160.150.0600
9/16-18X4.1/2*	5	U04160.056.0450	7/8-14X3.1/4*	5	U04160.087.0325	1.1/2-12X7 Inch*	1	U04160.150.0700
9/16-18X5 Inch*	5	U04160.056.0500	7/8-14X3.1/2*	5	U04160.087.0350	1.1/2-12X10 Inch*	1	U04160.150.1000

* ft = fully threaded

U04360 Hexagon head bolt UNF		X01A	
Thread	Unified National Fine		
Material	Steel		
Class	Grade 8		
Surface treatment	Zinc plated yellow passivated		

d x L	☒	Art.number	d x L	☒	Art.number	d x L	☒	Art.number
1/4-28X1/2 ft*	100	U04360.025.0050	3/8-24X8 Inch*	5	U04360.037.0800	5/8-18X2 Inch*	5	U04360.062.0200
1/4-28X5/8 ft*	100	U04360.025.0062	3/8-24X10 Inch*	5	U04360.037.1000	5/8-18X2.1/4*	5	U04360.062.0225
1/4-28X3/4 ft*	100	U04360.025.0075				5/8-18X2.1/2*	5	U04360.062.0250
1/4-28X7/8*	100	U04360.025.0087	7/16-20X3/4 ft*	25	U04360.043.0075	5/8-18X2.3/4*	5	U04360.062.0275
1/4-28X1 Inch*	100	U04360.025.0100	7/16-20X7/8 ft*	25	U04360.043.0087	5/8-18X3 Inch*	5	U04360.062.0300
1/4-28X1.1/4*	100	U04360.025.0125	7/16-20X1 Inch ft*	25	U04360.043.0100	5/8-18X3.1/4*	5	U04360.062.0325
1/4-28X1.3/8*	100	U04360.025.0137	7/16-20X1.1/4*	25	U04360.043.0125	5/8-18X3.1/2*	5	U04360.062.0350
1/4-28X1.1/2*	100	U04360.025.0150	7/16-20X1.1/2*	25	U04360.043.0150	5/8-18X3.3/4*	5	U04360.062.0375
1/4-28X1.3/4*	100	U04360.025.0175	7/16-20X1.3/4*	25	U04360.043.0175	5/8-18X4 Inch*	5	U04360.062.0400
1/4-28X2 Inch*	50	U04360.025.0200	7/16-20X2 Inch*	25	U04360.043.0200	5/8-18X4.1/4*	5	U04360.062.0425
1/4-28X2.1/4*	50	U04360.025.0225	7/16-20X2.1/4*	10	U04360.043.0225	5/8-18X4.1/2*	5	U04360.062.0450
1/4-28X2.1/2*	50	U04360.025.0250	7/16-20X2.1/2*	10	U04360.043.0250	5/8-18X4.3/4*	5	U04360.062.0475
1/4-28X2.3/4*	50	U04360.025.0275	7/16-20X2.3/4*	10	U04360.043.0275	5/8-18X5 Inch*	5	U04360.062.0500
1/4-28X3 Inch*	50	U04360.025.0300	7/16-20X3 Inch*	10	U04360.043.0300	5/8-18X5.1/2*	5	U04360.062.0550
1/4-28X3.1/4*	50	U04360.025.0325	7/16-20X3.1/4*	10	U04360.043.0325	5/8-18X6 Inch*	5	U04360.062.0600
1/4-28X3.1/2*	50	U04360.025.0350	7/16-20X3.1/2*	10	U04360.043.0350	5/8-18X6.1/2*	5	U04360.062.0650
1/4-28X3.3/4*	50	U04360.025.0375	7/16-20X3.3/4*	10	U04360.043.0375	5/8-18X7 Inch*	5	U04360.062.0700
1/4-28X4 Inch*	25	U04360.025.0400	7/16-20X4 Inch*	10	U04360.043.0400	5/8-18X7.1/2*	5	U04360.062.0750
1/4-28X4.1/2*	25	U04360.025.0450	7/16-20X4.1/2*	10	U04360.043.0450	5/8-18X8 Inch*	5	U04360.062.0800
1/4-28X5 Inch*	25	U04360.025.0500	7/16-20X5 Inch*	10	U04360.043.0500	5/8-18X8.1/2*	5	U04360.062.0850
1/4-28X5.1/2*	25	U04360.025.0550	7/16-20X5.1/2*	10	U04360.043.0550	5/8-18X9 Inch*	5	U04360.062.0900
1/4-28X6 Inch*	25	U04360.025.0600	7/16-20X6 Inch*	5	U04360.043.0600	5/8-18X9.1/2*	5	U04360.062.0950
1/4-28X7 Inch*	10	U04360.025.0700				5/8-18X10 Inch*	5	U04360.062.1000
1/4-28X8 Inch*	5	U04360.025.0800	1/2-20X3/4 ft*	25	U04360.050.0075	5/8-18X11 Inch*	5	U04360.062.1100
			1/2-20X1 Inch ft*	25	U04360.050.0100	5/8-18X12 Inch*	5	U04360.062.1200
5/16-24X1/2 ft*	100	U04360.031.0050	1/2-20X1.1/4 ft*	25	U04360.050.0125			
5/16-24X5/8 ft*	100	U04360.031.0062	1/2-20X1.1/2*	25	U04360.050.0150	3/4-16X1 Inch ft*	10	U04360.075.0100
5/16-24X3/4 ft*	100	U04360.031.0075	1/2-20X1.3/4*	25	U04360.050.0175	3/4-16X1.1/4 ft*	10	U04360.075.0125
5/16-24X7/8 ft*	100	U04360.031.0087	1/2-20X2 Inch*	10	U04360.050.0200	3/4-16X1.1/2 ft*	10	U04360.075.0150
5/16-24X1 Inch*	100	U04360.031.0100	1/2-20X2.1/4*	10	U04360.050.0225	3/4-16X1.3/4 ft*	10	U04360.075.0175
5/16-24X1.1/4*	100	U04360.031.0125	1/2-20X2.1/2*	10	U04360.050.0250	3/4-16X2 Inch*	5	U04360.075.0200
5/16-24X1.1/2*	100	U04360.031.0150	1/2-20X2.3/4*	10	U04360.050.0275	3/4-16X2.1/4*	5	U04360.075.0225
5/16-24X1.3/4*	50	U04360.031.0175	1/2-20X3 Inch*	10	U04360.050.0300	3/4-16X2.1/2*	5	U04360.075.0250
5/16-24X2 Inch*	50	U04360.031.0200	1/2-20X3.1/4*	10	U04360.050.0325	3/4-16X2.3/4*	5	U04360.075.0275
5/16-24X2.1/4*	50	U04360.031.0225	1/2-20X3.1/2*	10	U04360.050.0350	3/4-16X3 Inch*	5	U04360.075.0300
5/16-24X2.1/2*	50	U04360.031.0250	1/2-20X3.3/4*	10	U04360.050.0375	3/4-16X3.1/4*	5	U04360.075.0325
5/16-24X2.3/4*	50	U04360.031.0275	1/2-20X4 Inch*	5	U04360.050.0400	3/4-16X3.1/2*	5	U04360.075.0350
5/16-24X3 Inch*	50	U04360.031.0300	1/2-20X4.1/4*	5	U04360.050.0425	3/4-16X3.3/4*	5	U04360.075.0375
5/16-24X3.1/4*	50	U04360.031.0325	1/2-20X4.1/2*	5	U04360.050.0450	3/4-16X4 Inch*	5	U04360.075.0400
5/16-24X3.1/2*	50	U04360.031.0350	1/2-20X4.3/4*	5	U04360.050.0475	3/4-16X4.1/4*	5	U04360.075.0425
5/16-24X3.3/4*	25	U04360.031.0375	1/2-20X5 Inch*	5	U04360.050.0500	3/4-16X4.1/2*	5	U04360.075.0450
5/16-24X4 Inch*	25	U04360.031.0400	1/2-20X5.1/2*	5	U04360.050.0550	3/4-16X4.3/4*	5	U04360.075.0475
5/16-24X4.1/2*	25	U04360.031.0450	1/2-20X6 Inch*	5	U04360.050.0600	3/4-16X5 Inch*	5	U04360.075.0500
5/16-24X5 Inch*	25	U04360.031.0500	1/2-20X6.1/2*	5	U04360.050.0650	3/4-16X5.1/2*	5	U04360.075.0550
5/16-24X5.1/2*	25	U04360.031.0550	1/2-20X7 Inch*	5	U04360.050.0700	3/4-16X6 Inch*	5	U04360.075.0600
5/16-24X6 Inch*	25	U04360.031.0600	1/2-20X7.1/2*	5	U04360.050.0750	3/4-16X6.1/2*	1	U04360.075.0650
5/16-24X7 Inch*	10	U04360.031.0700	1/2-20X8 Inch*	5	U04360.050.0800	3/4-16X7 Inch*	1	U04360.075.0700
			1/2-20X8.1/2*	5	U04360.050.0850	3/4-16X7.1/2*	1	U04360.075.0750
			1/2-20X9 Inch*	5	U04360.050.0900	3/4-16X8 Inch*	1	U04360.075.0800
3/8-24X1/2 ft*	50	U04360.037.0050	1/2-20X10 Inch*	5	U04360.050.1000	3/4-16X8.1/2*	5	U04360.075.0850
3/8-24X5/8 ft*	50	U04360.037.0062	1/2-20X11 Inch*	5	U04360.050.1100	3/4-16X9 Inch*	1	U04360.075.0900
3/8-24X3/4 ft*	50	U04360.037.0075	1/2-20X12 Inch*	5	U04360.050.1200	3/4-16X9.1/2*	5	U04360.075.0950
3/8-24X7/8 ft*	50	U04360.037.0087				3/4-16X10 Inch*	1	U04360.075.1000
3/8-24X1 Inch ft*	50	U04360.037.0100				3/4-16X11 Inch*	5	U04360.075.1100
3/8-24X1.1/4*	50	U04360.037.0125	9/16-18X1 Inch ft*	25	U04360.056.0100	3/4-16X12 Inch*	5	U04360.075.1200
3/8-24X1.1/2*	50	U04360.037.0150	9/16-18X1.1/4 ft*	25	U04360.056.0125			
3/8-24X1.3/4*	50	U04360.037.0175	9/16-18X1.1/2*	25	U04360.056.0150			
3/8-24X2 Inch*	25	U04360.037.0200	9/16-18X1.3/4*	10	U04360.056.0175	7/8-14X1.1/2 ft*	5	U04360.087.0150
3/8-24X2.1/4*	25	U04360.037.0225	9/16-18X2 Inch*	10	U04360.056.0200	7/8-14X2 Inch ft*	5	U04360.087.0200
3/8-24X2.1/2*	25	U04360.037.0250	9/16-18X2.1/4*	10	U04360.056.0225	7/8-14X2.1/4*	5	U04360.087.0225
3/8-24X2.3/4*	25	U04360.037.0275	9/16-18X2.1/2*	10	U04360.056.0250	7/8-14X2.1/2*	5	U04360.087.0250
3/8-24X3 Inch*	25	U04360.037.0300	9/16-18X2.3/4*	10	U04360.056.0275	7/8-14X2.3/4*	5	U04360.087.0275
3/8-24X3.1/4*	25	U04360.037.0325	9/16-18X3 Inch*	10	U04360.056.0300	7/8-14X3 Inch*	5	U04360.087.0300
3/8-24X3.1/2*	25	U04360.037.0350	9/16-18X3.1/4*	10	U04360.056.0325	7/8-14X3.1/4*	5	U04360.087.0325
3/8-24X3.3/4*	25	U04360.037.0375	9/16-18X3.1/2*	10	U04360.056.0350	7/8-14X3.1/2*	5	U04360.087.0350
3/8-24X4 Inch*	10	U04360.037.0400	9/16-18X3.3/4*	10	U04360.056.0375	7/8-14X3.3/4*	5	U04360.087.0375
3/8-24X4.1/4*	10	U04360.037.0425	9/16-18X4 Inch*	5	U04360.056.0400	7/8-14X4 Inch*	5	U04360.087.0400
3/8-24X4.1/2*	10	U04360.037.0450	9/16-18X4.1/2*	5	U04360.056.0450	7/8-14X4.1/2*	5	U04360.087.0450
3/8-24X4.3/4*	10	U04360.037.0475	9/16-18X5 Inch*	5	U04360.056.0500	7/8-14X5 Inch*	5	U04360.087.0500
3/8-24X5 Inch*	10	U04360.037.0500	9/16-18X5.1/2*	5	U04360.056.0550	7/8-14X5.1/2*	5	U04360.087.0550
3/8-24X5.1/4*	10	U04360.037.0525	9/16-18X6 Inch*	5	U04360.056.0600	7/8-14X6 Inch*	1	U04360.087.0600
3/8-24X5.1/2*	10	U04360.037.0550				7/8-14X6.1/2*	1	U04360.087.0650
3/8-24X5.3/4*	10	U04360.037.0575	5/8-18X1 Inch ft*	10	U04360.062.0100	7/8-14X7 Inch*	1	U04360.087.0700
3/8-24X6 Inch*	10	U04360.037.0600	5/8-18X1.1/4 ft*	10	U04360.062.0125	7/8-14X7.1/2*	1	U04360.087.0750
3/8-24X6.1/2*	10	U04360.037.0650	5/8-18X1.1/2 ft*	10	U04360.062.0150	7/8-14X8 Inch*	1	U04360.087.0800
3/8-24X7 Inch*	10	U04360.037.0700	5/8-18X1.3/4*	10	U04360.062.0175	7/8-14X8.1/2*	1	U04360.087.0850

U04360 Hexagon head bolt UNF ←

d x L	☒	Art.number	d x L	☒	Art.number	d x L	☒	Art.number
7/8-14X9 Inch*	1	U04360.087.0900	1.-14X8.1/2*	1	U04360.101.0850	1.1/4-12X3 Inch*	1	U04360.125.0300
7/8-14X10 Inch*	1	U04360.087.1000	1.-14X9 Inch*	1	U04360.101.0900	1.1/4-12X3.1/2*	1	U04360.125.0350
1.-14X1.1/2 ft*	5	U04360.101.0150	1.-14X9.1/2*	1	U04360.101.0950	1.1/4-12X4 Inch*	1	U04360.125.0400
1.-14X1.3/4 ft*	5	U04360.101.0175	1.-14X10 Inch*	1	U04360.101.1000	1.1/4-12X4.1/2*	1	U04360.125.0450
1.-14X2 Inch ft*	5	U04360.101.0200	1.1/8-12X2.1/2 ft*	5	U04360.112.0250	1.1/4-12X5 Inch*	1	U04360.125.0500
1.-14X2.1/4 ft*	5	U04360.101.0225	1.1/8-12X3 Inch*	1	U04360.112.0300	1.1/4-12X5.1/2*	1	U04360.125.0550
1.-14X2.1/2*	5	U04360.101.0250	1.1/8-12X3.1/2*	1	U04360.112.0350	1.1/4-12X6 Inch*	1	U04360.125.0600
1.-14X2.3/4*	5	U04360.101.0275	1.1/8-12X4 Inch*	1	U04360.112.0400	1.1/4-12X6.1/2*	1	U04360.125.0650
1.-14X3 Inch*	5	U04360.101.0300	1.1/8-12X4.1/2*	1	U04360.112.0450	1.1/4-12X7 Inch*	1	U04360.125.0700
1.-14X3.1/4*	5	U04360.101.0325	1.1/8-12X5.1/2*	1	U04360.112.0500	1.1/4-12X7.1/2*	1	U04360.125.0750
1.-14X3.1/2*	5	U04360.101.0350	1.1/8-12X5 Inch*	1	U04360.112.0550	1.1/4-12X8 Inch*	1	U04360.125.0800
1.-14X3.3/4*	5	U04360.101.0375	1.1/8-12X5.1/2*	1	U04360.112.0600	1.1/4-12X9 Inch*	1	U04360.125.0900
1.-14X4 Inch*	5	U04360.101.0400	1.1/8-12X6 Inch*	1	U04360.112.0650	1.1/4-12X10 Inch*	1	U04360.125.1000
1.-14X4.1/2*	5	U04360.101.0450	1.1/8-12X6.1/2*	1	U04360.112.0700	1.1/2-12X3 Inch ft*	1	U04360.150.0300
1.-14X5 Inch*	5	U04360.101.0500	1.1/8-12X7 Inch*	1	U04360.112.0750	1.1/2-12X4.1/2*	1	U04360.150.0450
1.-14X5.1/2*	5	U04360.101.0550	1.1/8-12X7.1/2*	1	U04360.112.0800	1.1/2-12X5 Inch*	1	U04360.150.0500
1.-14X6 Inch*	1	U04360.101.0600	1.1/8-12X8 Inch*	1	U04360.112.0900	1.1/2-12X6 Inch*	1	U04360.150.0600
1.-14X6.1/2*	1	U04360.101.0650	1.1/8-12X9 Inch*	1	U04360.112.1000	1.1/2-12X6.1/2*	1	U04360.150.0650
1.-14X7 Inch*	1	U04360.101.0700	1.1/8-12X10 Inch*	1	U04360.112.1000	1.1/2-12X7 Inch*	1	U04360.150.0700
1.-14X7.1/2*	1	U04360.101.0750	1.1/4-12X2 Inch ft*	1	U04360.125.0200	1.1/2-12X7.1/2*	1	U04360.150.0750
1.-14X8 Inch*	1	U04360.101.0800	1.1/4-12X2.1/2 ft*	1	U04360.125.0250	1.1/2-12X10 Inch*	1	U04360.150.1000

* ft = fully threaded

U51007 Hexagon head bolt UNF X15A

Thread	Unified National Fine
Material	Stainless steel A2 (AISI 304/18-8)
Class	F593





d x L	☒	Art.number	d x L	☒	Art.number	d x L	☒	Art.number
1/4-28X1/2 ft*	100	U51007.025.0050	3/8-24X2.3/4*	25	U51007.037.0275	9/16-18X2.1/2*	5	U51007.056.0250
1/4-28X5/8 ft*	100	U51007.025.0062	3/8-24X3 Inch*	10	U51007.037.0300	9/16-18X3 Inch*	5	U51007.056.0300
1/4-28X3/4 ft*	100	U51007.025.0075	3/8-24X3.1/2*	10	U51007.037.0350	9/16-18X3.1/2*	5	U51007.056.0350
1/4-28X7/8*	100	U51007.025.0087	3/8-24X4 Inch*	10	U51007.037.0400	9/16-18X4 Inch*	5	U51007.056.0400
1/4-28X1 Inch*	100	U51007.025.0100	3/8-24X4.1/2*	10	U51007.037.0450	9/16-18X4.1/2*	5	U51007.056.0450
1/4-28X1.1/4*	100	U51007.025.0125	3/8-24X5 Inch*	10	U51007.037.0500	9/16-18X5 Inch*	5	U51007.056.0500
1/4-28X1.3/8*	100	U51007.025.0137				9/16-18X5.1/2*	5	U51007.056.0550
1/4-28X1.1/2*	100	U51007.025.0150	7/16-20X1 Inch ft*	25	U51007.043.0100	9/16-18X6 Inch*	5	U51007.056.0600
1/4-28X1.3/4*	100	U51007.025.0175	7/16-20X1.1/4*	25	U51007.043.0125			
1/4-28X2 Inch*	50	U51007.025.0200	7/16-20X1.1/2*	25	U51007.043.0150	5/8-18X1 Inch ft*	10	U51007.062.0100
1/4-28X2.1/4*	50	U51007.025.0225	7/16-20X1.3/4*	10	U51007.043.0175	5/8-18X1.1/4 ft*	10	U51007.062.0125
1/4-28X2.1/2*	50	U51007.025.0250	7/16-20X2 Inch*	10	U51007.043.0200	5/8-18X1.1/2 ft*	10	U51007.062.0150
1/4-28X2.3/4*	50	U51007.025.0275	7/16-20X2.1/4*	10	U51007.043.0225	5/8-18X1.3/4*	10	U51007.062.0175
1/4-28X3 Inch*	50	U51007.025.0300	7/16-20X2.1/2*	10	U51007.043.0250	5/8-18X2 Inch*	5	U51007.062.0200
1/4-28X3.1/2*	25	U51007.025.0350	7/16-20X2.3/4*	10	U51007.043.0275	5/8-18X2.1/4*	5	U51007.062.0225
1/4-28X4 Inch*	25	U51007.025.0400	7/16-20X3 Inch*	10	U51007.043.0300	5/8-18X2.1/2*	5	U51007.062.0250
			7/16-20X3.1/2*	5	U51007.043.0350	5/8-18X3 Inch*	5	U51007.062.0300
			7/16-20X4 Inch*	5	U51007.043.0400	5/8-18X3.1/2*	5	U51007.062.0350
			7/16-20X4.1/2*	5	U51007.043.0450	5/8-18X4 Inch*	5	U51007.062.0400
			7/16-20X5 Inch*	5	U51007.043.0500	5/8-18X4.1/2*	5	U51007.062.0450
						5/8-18X5 Inch*	5	U51007.062.0500
			1/2-20X3/4 ft*	10	U51007.050.0075	5/8-18X5.1/2*	5	U51007.062.0550
			1/2-20X1 Inch ft*	10	U51007.050.0100	5/8-18X6 Inch*	5	U51007.062.0600
			1/2-20X1.1/4 ft*	10	U51007.050.0125	5/8-18X6.1/2*	5	U51007.062.0650
			1/2-20X1.1/2*	10	U51007.050.0150	5/8-18X7 Inch*	5	U51007.062.0700
			1/2-20X2 Inch*	10	U51007.050.0200	5/8-18X8 Inch*	5	U51007.062.0800
			1/2-20X2.1/4*	10	U51007.050.0225	5/8-18X9 Inch*	1	U51007.062.0900
			1/2-20X2.1/2*	10	U51007.050.0250			
			1/2-20X3 Inch*	5	U51007.050.0300	3/4-16X1 Inch ft*	5	U51007.075.0100
			1/2-20X3.1/4*	5	U51007.050.0325	3/4-16X1.1/4 ft*	5	U51007.075.0125
			1/2-20X3.1/2*	5	U51007.050.0350	3/4-16X1.1/2 ft*	5	U51007.075.0150
			1/2-20X4 Inch*	5	U51007.050.0400	3/4-16X1.3/4 ft*	5	U51007.075.0175
			1/2-20X4.1/2*	5	U51007.050.0450	3/4-16X2 Inch*	5	U51007.075.0200
			1/2-20X5 Inch*	5	U51007.050.0500	3/4-16X2.1/4*	5	U51007.075.0225
			1/2-20X5.1/2*	5	U51007.050.0550	3/4-16X2.1/2*	5	U51007.075.0250
			1/2-20X6 Inch*	5	U51007.050.0600	3/4-16X3 Inch*	5	U51007.075.0300
						3/4-16X3.1/2*	5	U51007.075.0350
			9/16-18X1 Inch ft*	10	U51007.056.0100	3/4-16X4 Inch*	5	U51007.075.0400
			9/16-18X1.1/4 ft*	10	U51007.056.0125	3/4-16X4.1/2*	5	U51007.075.0450
			9/16-18X1.1/2*	10	U51007.056.0150	3/4-16X5 Inch*	5	U51007.075.0500
			9/16-18X1.3/4*	10	U51007.056.0175	3/4-16X5.1/2*	5	U51007.075.0550
			9/16-18X2 Inch*	5	U51007.056.0200	3/4-16X6 Inch*	5	U51007.075.0600

* ft = fully threaded

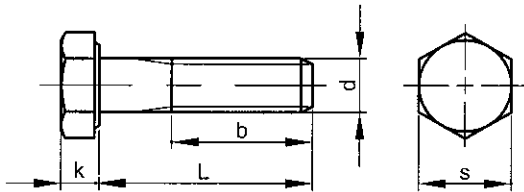
1 Hexagon head bolt BSW

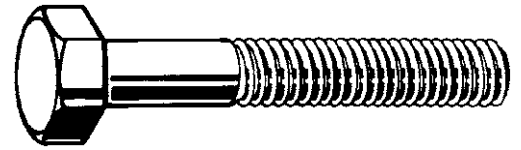

DIN ≈931 (1954)
NEN ≈2336 (1961)



Technical Data

d	k	s	Threads per inch	d	k	s	Threads per inch
1/2	9	22	12	7/8	16	36	9
5/8	11	27	11	1 Inch	18	41	8
3/4	13	32	10				

- Whitworth thread (BSW/BSF) is not internationally recommended. It is advised to use metric (M/MF) or unified threads (UNC/UNF).
- Depending on availability the dimensions may deviate.

03400	Hexagon head bolt BSW	X03A
Thread	British Standard Whitworth	
Material	Steel	
Class	8.8	
		
		

d x L/b	☒	Art.number	d x L/b	☒	Art.number	d x L/b	☒	Art.number
1/2X35/25	50	03400.127.035	5/8X50/28	25	03400.158.050	7/8X60/38	10	03400.222.060
1/2X50/25	50	03400.127.050	5/8X60/28	25	03400.158.060	7/8X70/38	10	03400.222.070
1/2X60/25	50	03400.127.060						
1/2X70/25	50	03400.127.070	3/4X50/32	10	03400.191.050	1 InchX70/40	10	03400.254.070
1/2X75/30	50	03400.127.075	3/4X60/32	10	03400.191.060	1 InchX80/40	10	03400.254.080
1/2X80/30	50	03400.127.080	3/4X70/32	10	03400.191.070	1 InchX100/55	10	03400.254.100
1/2X100/30	50	03400.127.100	3/4X80/32	10	03400.191.080			
			3/4X100/40	10	03400.191.100			

Hexagon head bolt BSF

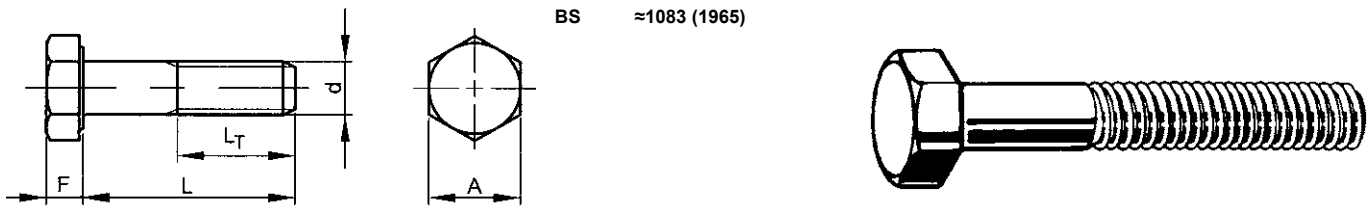



BS ≈1083 (1965)

Technical Data

d	A	F	L _T (min.)	Threads per inch
1/4	0.445	4.6	13	26
5/16	0.525	5.5	16	22
3/8	0.6	6.6	19	20
7/16	0.71	7.7	22	18
1/2	0.82	8.7	25.5	16
5/8	1.01	10.6	32	14
3/4	1.2	12.7	38	12

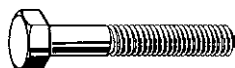
- Whitworth thread (BSW/BSF) is not internationally recommended. It is advised to use metric (M/MF) or unified threads (UNC/UNF).
- Minimum Grade R acc. to ≈ BS 1083 (1965) corresponds much the same with property class 6.8 acc. to DIN ISO 898-1. The bolthead is marked with the symbol of property class R.

03000 Hexagon head bolt BSF		X90A
Thread	British Standard Fine	
Material	Steel	
Class	≥Grade R	
		

d x L	☒	Art.number	d x L	☒	Art.number	d x L	☒	Art.number
1/4X1 Inch	200	03000.063.025	3/8X1.1/4	100	03000.096.031	1/2X1.3/4	50	03000.127.044
1/4X2 Inch	100	03000.063.050	3/8X1.1/2	100	03000.096.038	1/2X2 Inch	50	03000.127.050
1/4X2.1/2	100	03000.063.063	3/8X1.3/4	100	03000.096.044	1/2X2.1/2	50	03000.127.063
1/4X3 Inch	100	03000.063.076	3/8X2 Inch	100	03000.096.050	1/2X3 Inch	50	03000.127.076
5/16X1.1/2	200	03000.079.038	3/8X3 Inch	100	03000.096.076	5/8X2 Inch	25	03000.158.050
5/16X1.3/4	100	03000.079.044	7/16X1.1/2	100	03000.111.038	3/4X2 Inch	25	03000.191.050
5/16X2 Inch	100	03000.079.050	1/2X1.1/2	50	03000.127.038	3/4X2.1/2	25	03000.191.063
5/16X2.1/4	100	03000.079.057				3/4X3 Inch	25	03000.191.076
5/16X3 Inch	100	03000.079.076						

Hexagon head screw BSW

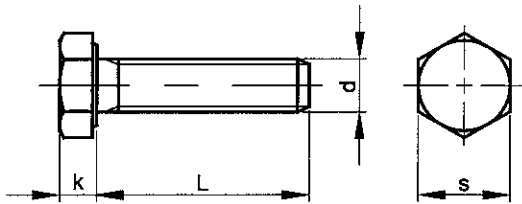

DIN ≈933 (1954)
NEN ≈2337 (1961)

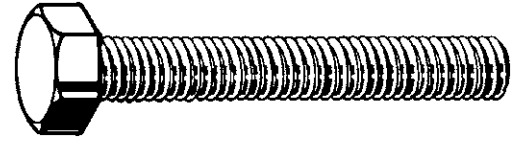

Technical Data

d	k	s	Threads per inch	d	k	s	Threads per inch
1/4	5	11	20	1/2	9	22	12
5/16	6	14	18	5/8	11	27	11
3/8	7	17	16	3/4	13	32	10

- Whitworth thread (BSW/BSF) is not internationally recommended. It is advised to use metric (M/MF) or unified threads (UNC/UNF).
- Depending on availability the dimensions may deviate.

Article groups

Thread	Driving features	Material	Class	Code	Page
BSW	Hexagon	St	8.8	03410	1-60
BSW	Hexagon	Br Cu2		46210	1-60

03410 Hexagon head screw BSW X03A

Thread British Standard Whitworth
Material Steel
Class 8.8



d x L	☒	Art.number	d x L	☒	Art.number	d x L	☒	Art.number
1/4X10MM	100	03410.063.010	3/8X15MM	100	03410.096.015	1/2X40MM	50	03410.127.040
1/4X15MM	100	03410.063.015	3/8X20MM	100	03410.096.020	1/2X50MM	50	03410.127.050
1/4X20MM	100	03410.063.020	3/8X25MM	100	03410.096.025	1/2X55MM	50	03410.127.055
1/4X25MM	100	03410.063.025	3/8X30MM	100	03410.096.030	1/2X60MM	50	03410.127.060
1/4X30MM	100	03410.063.030	3/8X35MM	100	03410.096.035	1/2X70MM	50	03410.127.070
1/4X40MM	100	03410.063.040	3/8X40MM	100	03410.096.040			
1/4X50MM	100	03410.063.050	3/8X50MM	100	03410.096.050	5/8X30MM	50	03410.158.030
			3/8X60MM	100	03410.096.060	5/8X40MM	25	03410.158.040
5/16X20MM	100	03410.079.020	3/8X70MM	100	03410.096.070	5/8X50MM	25	03410.158.050
5/16X25MM	100	03410.079.025				5/8X60MM	25	03410.158.060
5/16X30MM	100	03410.079.030	1/2X20MM	100	03410.127.020			
5/16X40MM	100	03410.079.040	1/2X25MM	100	03410.127.025	3/4X50MM	10	03410.191.050
5/16X50MM	100	03410.079.050	1/2X30MM	100	03410.127.030	3/4X60MM	10	03410.191.060
5/16X60MM	100	03410.079.060	1/2X35MM	100	03410.127.035	3/4X70MM	10	03410.191.070

46210 Hexagon head screw BSW X08A

Thread British Standard Whitworth
Material Brass Cu2



d x L	☒	Art.number	d x L	☒	Art.number	d x L	☒	Art.number
1/4X10MM	100	46210.063.010	5/16X20MM	100	46210.079.020	3/8X50MM	25	46210.096.050
1/4X12MM	100	46210.063.012	5/16X25MM	100	46210.079.025			
1/4X15MM	100	46210.063.015	5/16X30MM	50	46210.079.030	1/2X25MM	25	46210.127.025
1/4X20MM	100	46210.063.020	5/16X40MM	50	46210.079.040	1/2X30MM	25	46210.127.030
1/4X25MM	100	46210.063.025	5/16X50MM	50	46210.079.050	1/2X40MM	25	46210.127.040
1/4X30MM	100	46210.063.030				1/2X50MM	25	46210.127.050
1/4X40MM	50	46210.063.040	3/8X20MM	50	46210.096.020			
1/4X50MM	50	46210.063.050	3/8X25MM	50	46210.096.025	5/8X16MM	25	46210.158.016
			3/8X30MM	25	46210.096.030	5/8X40MM	10	46210.158.040
5/16X16MM	100	46210.079.016	3/8X40MM	25	46210.096.040	5/8X50MM	10	46210.158.050

Hexagon head screw BSF

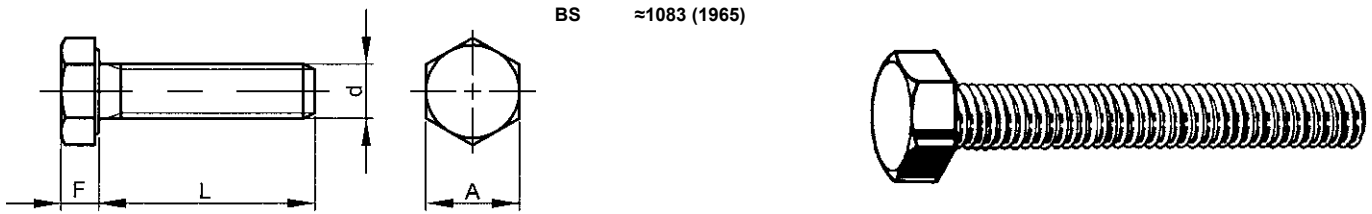

Technical Data

d	A	F	Threads per inch	d	A	F	Threads per inch
1/4	0.445	4.6	26	3/8	0.6	6.6	20
5/16	0.525	5.5	22	1/2	0.82	8.7	16

- Whitworth thread (BSW/BSF) is not internationally recommended. It is advised to use metric (M/MF) or unified threads (UNC/UNF).
- Minimum Grade R acc. to ≈ BS 1083 (1965) corresponds much the same with property class 6.8 acc. to DIN ISO 898-1. The bolthead is marked with the symbol of property class R.

03010 Hexagon head screw BSF		X90A
Thread	British Standard Fine	 
Material	Steel	
Class	≥Grade R	

d x L	☒	Art.number	d x L	☒	Art.number	d x L	☒	Art.number
1/4X5/8	200	03010.063.015	5/16X3/4	200	03010.079.019	3/8X5/8	100	03010.096.015
1/4X3/4	200	03010.063.019	5/16X1 Inch	200	03010.079.025	3/8X3/4	100	03010.096.019
1/4X1 Inch	200	03010.063.025	5/16X1.1/4	200	03010.079.031	3/8X1 Inch	100	03010.096.025
1/4X1.1/4	200	03010.063.031	5/16X1.1/2	200	03010.079.038	1/2X1 Inch	100	03010.127.025
1/4X1.1/2	200	03010.063.038	3/8X1/2	100	03010.096.012	1/2X1.1/4	50	03010.127.031
5/16X5/8	200	03010.079.015						

Self-locking hexagon bolt with flange

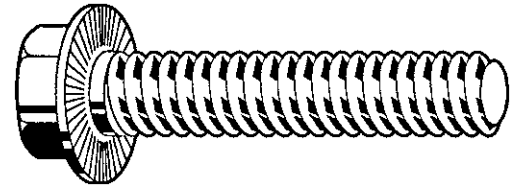
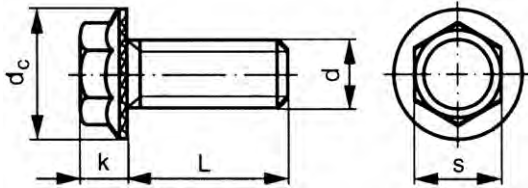

Technical Data

d	d _c	k	P	s
M5	11.2	4.3	0.8	8
M6	14.2	5.5	1	10
M8	18.2	7	1.25	13
M10	21	8.5	1.5	15
M12	24	10	1.75	17
M16	31	14	2	22

Special features of RIPP self-locking hexagon bolts with flange:

- the serrated flange eliminates surface damage during assembly, prevents self-loosening and reduces relaxation
- the flange enables built up forces under the bolt head to be spread over a larger area, consequently resulting in lower surface pressure
- large holes (oversized) and/or tooling holes can be covered by the flange
- a washer and/or a locking element is not necessary

ASSEMBLY PRE-LOAD F_M in kN and TIGHTENING TORQUE M_A in Nm

Class	Mating material	M5		M6		M8		M10		M12		M16	
		F _M	M _A	F _M	M _A	F _M	M _A	F _M	M _A	F _M	M _A	F _M	M _A
100	Steel (Rm < 800 N/mm ²)	9	11	12,6	19	23,2	42	37	85	54	130	102	330
	Steel (Rm ≥ 800 N/mm ²)	9	10	12,6	18	23,2	37	37	80	54	120	102	310
	Malleable iron	9	9	12,6	16	23,2	35	37	75	54	115	102	300

Article groups

Thread	Driving features	Material	Class	Surface treatment	Code	Page
M	Hexagon	St	100		04400	1-62
M	Hexagon	St	100	Zipl	04410	1-63
M	Hexagon	St	100	FLZNNC-NC6	04405	1-63

04400 RIPP Self-locking hexagon bolt with flange

A92A

Thread Metric thread
Material Steel
Class 100

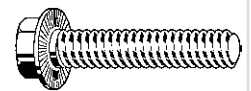

d x L	☒	Art.number	d x L	☒	Art.number	d x L	☒	Art.number
M5X10	500	04400.050.010	M8X25	200	04400.080.025	M12X35	100	04400.120.035
M5X12	500	04400.050.012	M8X30	200	04400.080.030	M12X40	100	04400.120.040
M5X16	500	04400.050.016	M8X35	200	04400.080.035	M12X45	100	04400.120.045
M5X20	500	04400.050.020	M8X40	200	04400.080.040	M12X50	100	04400.120.050
M6X10	500	04400.060.010	M10X16	200	04400.100.016	M16X25	50	04400.160.025
M6X12	500	04400.060.012	M10X20	200	04400.100.020	M16X30	50	04400.160.030
M6X16	500	04400.060.016	M10X25	200	04400.100.025	M16X35	50	04400.160.035
M6X20	500	04400.060.020	M10X30	200	04400.100.030	M16X40	50	04400.160.040
M6X25	500	04400.060.025	M10X35	100	04400.100.035	M16X45	50	04400.160.045
M6X30	500	04400.060.030	M10X40	100	04400.100.040	M16X50	50	04400.160.050
M8X12	200	04400.080.012	M12X20	100	04400.120.020	M16X55	50	04400.160.055
M8X16	200	04400.080.016	M12X25	100	04400.120.025	M16X60	50	04400.160.060
M8X20	200	04400.080.020	M12X30	100	04400.120.030	M16X70	25	04400.160.070

- RIPP self-locking hexagon bolts with flange are designated with the property class 100 with a min. tensile strength of 1040 N/mm², they are case hardened and therefore cannot be classified in the usual class 10.9.
- WARNING: electro-galvanizing of these products may cause hydrogen embrittlement.

04410 RIPP Self-locking hexagon bolt with flange		A92A
Thread	Metric thread	
Material	Steel	
Class	100	
Surface treatment	Zinc plated	
		

d x L	☒	Art.number	d x L	☒	Art.number	d x L	☒	Art.number
M5X10	500	04410.050.010	M8X25	200	04410.080.025	M12X25	100	04410.120.025
M5X12	500	04410.050.012	M8X30	200	04410.080.030	M12X30	100	04410.120.030
M5X16	500	04410.050.016	M8X35	200	04410.080.035	M12X35	100	04410.120.035
			M8X40	200	04410.080.040	M12X40	100	04410.120.040
M6X10	500	04410.060.010				M12X45	100	04410.120.045
M6X12	500	04410.060.012	M10X16	200	04410.100.016	M12X50	100	04410.120.050
M6X14	500	04410.060.014	M10X20	200	04410.100.020			
M6X16	500	04410.060.016	M10X22	200	04410.100.022	M16X30	50	04410.160.030
M6X20	500	04410.060.020	M10X25	200	04410.100.025	M16X35	50	04410.160.035
M6X25	500	04410.060.025	M10X30	200	04410.100.030	M16X40	50	04410.160.040
			M10X35	100	04410.100.035	M16X45	50	04410.160.045
M8X12	200	04410.080.012	M10X40	100	04410.100.040	M16X50	50	04410.160.050
M8X14	200	04410.080.014				M16X60	50	04410.160.060
M8X16	200	04410.080.016	M12X20	100	04410.120.020	M16X70	25	04410.160.070
M8X20	200	04410.080.020						

- RIPP self-locking hexagon bolts with flange are designated with the property class 100 with a min. tensile strength of 1040 N/mm², they are case hardened and therefore cannot be classified in the usual class 10.9.
- WARNING: electro-galvanizing of these products may cause hydrogen embrittlement.

04405 RIPP Self-locking hexagon bolt with flange		A95A
Thread	Metric thread	
Material	Steel	
Class	100	
Surface treatment	Zinc flake Cr ⁶⁺ free - ISO 10683 flZnnc	
		

d x L	☒	Art.number	d x L	☒	Art.number	d x L	☒	Art.number
M5X10	200	04405.050.010	M8X20	200	04405.080.020	M12X35	100	04405.120.035
M5X12	200	04405.050.012	M8X25	200	04405.080.025	M12X40	100	04405.120.040
M5X16	200	04405.050.016	M8X30	200	04405.080.030	M12X50	100	04405.120.050
M5X20	200	04405.050.020	M8X35	200	04405.080.035			
M6X10	200	04405.060.010	M10X20	200	04405.100.020	M16X30	50	04405.160.030
M6X12	200	04405.060.012	M10X25	200	04405.100.025	M16X35	50	04405.160.035
M6X16	200	04405.060.016	M10X30	200	04405.100.030	M16X40	50	04405.160.040
M6X20	200	04405.060.020	M10X35	100	04405.100.035	M16X45	50	04405.160.045
M6X25	200	04405.060.025	M10X40	100	04405.100.040	M16X50	50	04405.160.050
						M16X60	50	04405.160.060
M8X16	200	04405.080.016	M12X30	100	04405.120.030	M16X70	50	04405.160.070

- A ISO 10683 Zinc Flake surface coating eliminates the possibilities of damage which can arise due to hydrogen embrittlement.

Self-locking hexagon bolt with flange

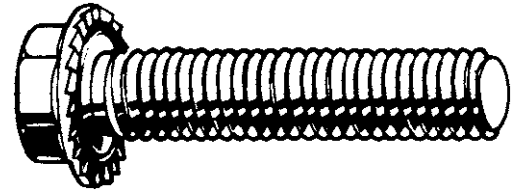
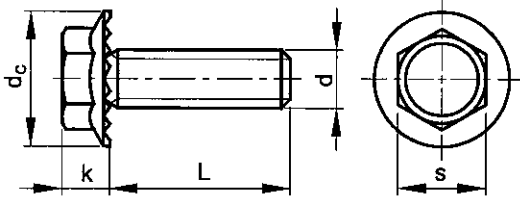

Technical Data

d	d _c	k	P	s
M5	11.2	4.3	0.8	8
M6	14.2	5.5	1	10
M8	18.2	7	1.25	13
M10	21	7.9	1.5	15
M12	24	8.7	1.75	17
M16	31	11.2	2	22

Special features of self-locking hexagon nuts:

- the resilient serrated flange gives excellent self-locking properties
- inside of the resilient flange serration there is an optimal preloading of the construction with minimal settlement
- a washer and/or locking element is not necessary and is even not advisable

ASSEMBLY PRE-LOAD F_M in KN and TIGHTENING TORQUE M_A in Nm

Class	Mating material	M5		M6		M8		M10		M12		M16	
		F _M	M _A	F _M	M _A	F _M	M _A	F _M	M _A	F _M	M _A	F _M	M _A
90	Steel	6,35	9	9	16	16,5	34	26,2	58	--	--	--	--
	Malleable iron	6,35	7	9	13	16,5	28	26,2	49	--	--	--	--
100	Steel	--	--	--	--	--	--	--	--	54	120	102	280
	Malleable iron	--	--	--	--	--	--	--	--	54	105	102	260

Article groups

Thread	Driving features	Material	Class	Surface treatment	Code	Page
M	Hexagon	St	90/100		01050	1-64
M	Hexagon	St	90/100	Zipl	01049	1-65
M	Hexagon	St	90/100	FLZNNC-NC6	01055	1-65

01050 Self-locking hexagon bolt with flange

A92A

Thread Metric thread
Material Steel
Class 90/100



d x L	☒	Art.number	d x L	☒	Art.number	d x L	☒	Art.number
M5X10	500	01050.050.010	M8X25	200	01050.080.025	M12X35	100	01050.120.035
M5X12	500	01050.050.012	M8X30	200	01050.080.030	M12X40	100	01050.120.040
M5X16	500	01050.050.016	M8X35	200	01050.080.035	M12X45	100	01050.120.045
M5X20	500	01050.050.020	M8X40	200	01050.080.040	M12X50	100	01050.120.050
M6X10	500	01050.060.010	M10X16	200	01050.100.016	M16X25	50	01050.160.025
M6X12	500	01050.060.012	M10X20	200	01050.100.020	M16X30	50	01050.160.030
M6X16	500	01050.060.016	M10X25	200	01050.100.025	M16X35	50	01050.160.035
M6X20	500	01050.060.020	M10X30	200	01050.100.030	M16X40	50	01050.160.040
M6X25	500	01050.060.025	M10X35	100	01050.100.035	M16X45	50	01050.160.045
M6X30	500	01050.060.030	M10X40	100	01050.100.040	M16X50	50	01050.160.050
M8X12	200	01050.080.012	M12X20	100	01050.120.020	M16X55	50	01050.160.055
M8X16	200	01050.080.016	M12X25	100	01050.120.025	M16X60	50	01050.160.060
M8X20	200	01050.080.020	M12X30	100	01050.120.030	M16X70	25	01050.160.070

01049 Self-locking hexagon bolt with flange		A92A
Thread	Metric thread	
Material	Steel	
Class	90/100	
Surface treatment	Zinc plated	
		

d x L	☒	Art.number	d x L	☒	Art.number	d x L	☒	Art.number
M5X8	500	01049.050.008	M6X30	500	01049.060.030	M10X25	200	01049.100.025
M5X10	500	01049.050.010				M10X30	200	01049.100.030
M5X12	500	01049.050.012	M8X12	200	01049.080.012			
M5X14	500	01049.050.014	M8X14	200	01049.080.014	M12X20	100	01049.120.020
M5X16	500	01049.050.016	M8X16	200	01049.080.016	M12X25	100	01049.120.025
M5X20	500	01049.050.020	M8X18	200	01049.080.018	M12X30	100	01049.120.030
			M8X22	200	01049.080.022	M12X35	100	01049.120.035
M6X10	500	01049.060.010	M8X25	200	01049.080.025	M12X40	100	01049.120.040
M6X12	500	01049.060.012	M8X30	200	01049.080.030			
M6X14	500	01049.060.014	M8X35	200	01049.080.035	M16X25	50	01049.160.025
M6X16	500	01049.060.016				M16X35	50	01049.160.035
M6X20	500	01049.060.020	M10X18	200	01049.100.018	M16X40	50	01049.160.040
M6X25	500	01049.060.025	M10X20	200	01049.100.020	M16X50	50	01049.160.050

01055 Self-locking hexagon bolt with flange		A94A
Thread	Metric thread	
Material	Steel	
Class	90/100	
Surface treatment	Zinc flake Cr ⁶⁺ free - ISO 10683 flZnnc	
		

d x L	☒	Art.number	d x L	☒	Art.number	d x L	☒	Art.number
M6X10	500	01055.060.010	M8X20	200	01055.080.020	M12X30	100	01055.120.030
M6X12	500	01055.060.012	M8X25	200	01055.080.025	M12X40	100	01055.120.040
M6X16	500	01055.060.016	M8X30	200	01055.080.030	M12X50	100	01055.120.050
M6X20	500	01055.060.020						
M6X25	500	01055.060.025	M10X25	200	01055.100.025	M16X40	50	01055.160.040
			M10X30	200	01055.100.030	M16X50	50	01055.160.050
M8X12	200	01055.080.012	M10X40	200	01055.100.040			
M8X16	200	01055.080.016						

- A ISO 10683 Zinc Flake surface coating eliminates the possibilities of damage which can arise due to hydrogen embrittlement.

1 Hexagon bolt with flange

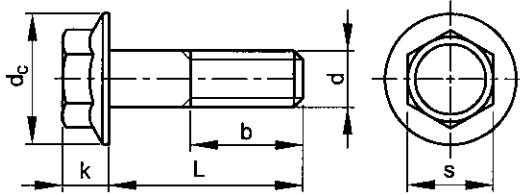

DIN 6921
 ISO ≈4162
 EN ≈1665
 ASME ≈B18.2.3.4M

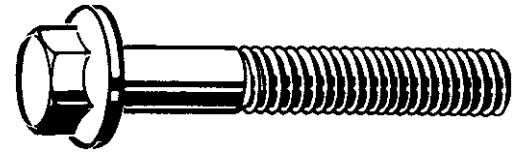

Technical Data

d	b (min.)	d _c (max.)	k (max.)	P	s
M6	18	14.2	6.6	1	10
M8	22	18	8.1	1.25	13
M10	26	22.3	9.2	1.5	15
M12	30	26.6	11.5	1.75	16
M14	34	30.5	12.8	2	18
M16	38	35	14.4	2	21
M20	46	43	17.1	2.5	27

Article groups

Thread	Driving features	Material	Class	Surface treatment	Code	Page
M	Hexagon	St	8.8	Zipl yell.p.	01256	1-66
M	Hexagon	St	10.9		04132	1-67

01256 Hexagon bolt with flange

A94A

Thread	Metric thread
Material	Steel
Class	8.8
Surface treatment	Zinc plated yellow passivated



d x L	☒	Art.number	d x L	☒	Art.number	d x L	☒	Art.number
M6X12	200	01256.060.012	M10X25	200	01256.100.025	M14X35	100	01256.140.035
M6X16	200	01256.060.016	M10X30	200	01256.100.030	M14X40	100	01256.140.040
M6X20	200	01256.060.020	M10X35	200	01256.100.035	M14X45	50	01256.140.045
M6X25	200	01256.060.025	M10X40	100	01256.100.040	M14X50	50	01256.140.050
M6X30	200	01256.060.030	M10X45	100	01256.100.045	M14X60	50	01256.140.060
M6X40	200	01256.060.040	M10X50	100	01256.100.050	M14X80	50	01256.140.080
M6X45	200	01256.060.045	M10X60	100	01256.100.060			
M6X50	200	01256.060.050	M10X70	100	01256.100.070	M16X35	50	01256.160.035
			M10X80	100	01256.100.080	M16X40	50	01256.160.040
M8X12	200	01256.080.012	M10X100	100	01256.100.100	M16X45	50	01256.160.045
M8X16	200	01256.080.016				M16X50	50	01256.160.050
M8X20	200	01256.080.020	M12X25	100	01256.120.025	M16X60	50	01256.160.060
M8X25	200	01256.080.025	M12X30	100	01256.120.030	M16X70	25	01256.160.070
M8X30	200	01256.080.030	M12X35	100	01256.120.035	M16X80	25	01256.160.080
M8X35	200	01256.080.035	M12X40	100	01256.120.040	M16X100	25	01256.160.100
M8X40	200	01256.080.040	M12X45	100	01256.120.045			
M8X45	200	01256.080.045	M12X50	100	01256.120.050	M20X50	25	01256.200.050
M8X50	200	01256.080.050	M12X60	100	01256.120.060	M20X60	25	01256.200.060
M8X60	200	01256.080.060	M12X70	50	01256.120.070	M20X70	25	01256.200.070
M8X70	200	01256.080.070	M12X80	50	01256.120.080	M20X80	10	01256.200.080
M8X80	100	01256.080.080	M12X90	50	01256.120.090	M20X90	10	01256.200.090
M8X100	100	01256.080.100	M12X100	50	01256.120.100	M20X100	10	01256.200.100
			M12X120	50	01256.120.120	M20X120	10	01256.200.120
M10X20	200	01256.100.020						

- Special features of hexagon bolts with flange:
- The flange enables built up forces to be spread over a larger area, consequently resulting in lower surface pressure.
- Large holes (oversized) and/or tooling holes can be covered by the flange.
- A washer is not necessary.

04132	Hexagon bolt with flange		A92A
Thread	Metric thread		
Material	Steel		
Class	10.9		
			

d x L	☒	Art.number	d x L	☒	Art.number	d x L	☒	Art.number
M6X20	200	04132.060.020	M10X40	100	04132.100.040	M12X90	50	04132.120.090
M6X25	200	04132.060.025	M10X50	100	04132.100.050	M14X35	50	04132.140.035
M6X30	200	04132.060.030	M10X60	100	04132.100.060	M14X40	50	04132.140.040
M6X40	200	04132.060.040	M10X70	100	04132.100.070	M14X45	50	04132.140.045
M6X50	200	04132.060.050	M12X25	100	04132.120.025	M14X50	50	04132.140.050
M8X20	200	04132.080.020	M12X30	100	04132.120.030	M16X35	50	04132.160.035
M8X25	200	04132.080.025	M12X35	100	04132.120.035	M16X40	50	04132.160.040
M8X30	200	04132.080.030	M12X40	100	04132.120.040	M16X45	50	04132.160.045
M8X40	200	04132.080.040	M12X45	100	04132.120.045	M16X50	50	04132.160.050
M8X50	200	04132.080.050	M12X50	100	04132.120.050	M16X60	50	04132.160.060
M10X20	200	04132.100.020	M12X60	100	04132.120.060	M16X70	25	04132.160.070
M10X25	200	04132.100.025	M12X70	50	04132.120.070	M16X80	25	04132.160.080
M10X30	200	04132.100.030	M12X80	50	04132.120.080			

- Special features of hexagon bolts with flange:
- The flange enables built up forces to be spread over a larger area, consequently resulting in lower surface pressure.
- Large holes (oversized) and/or tooling holes can be covered by the flange.
- A washer is not necessary.
- Warning: electro-galvanizing of these products may cause hydrogen embrittlement.

Hexagon bolt with flange, fully threaded

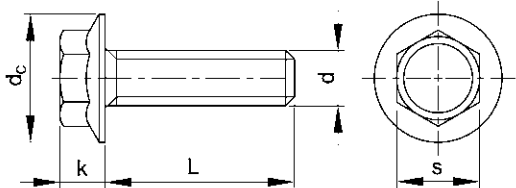

DIN ≈6921
ISO ≈4126
EN ≈1665
ASME ≈B18.2.3.4M

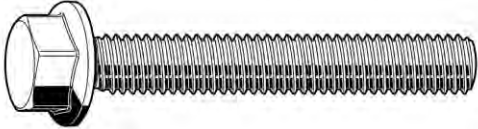

Technical Data					
d	b (min.)	d _c (max.)	k (max.)	P	s
M5	16	11.8	5.4	0.8	8
M6	18	14.2	6.6	1	10
M8	22	18	8.1	1.25	13
M10	26	22.3	9.2	1.5	15
M12	30	26.6	11.5	1.75	16

Article groups					
Thread	Driving features	Material	Class	Code	Page
M	Hexagon	St.St. A2	70	51018	1-67
M	Hexagon	St.St. A4	70	55018	1-68

51018	Hexagon bolt with flange, fully threaded		Q01A
Thread	Metric thread		
Material	Stainless steel A2		
Class	70		
			

d x L	☒	Art.number	d x L	☒	Art.number	d x L	☒	Art.number
M5X8*	200	51018.050.008	M6X10*	200	51018.060.010	M6X55*	200	51018.060.055
M5X10	200	51018.050.010	M6X12*	200	51018.060.012	M6X60*	200	51018.060.060
M5X12*	200	51018.050.012	M6X16	200	51018.060.016	M8X12*	200	51018.080.012
M5X16*	200	51018.050.016	M6X20	200	51018.060.020	M8X16	200	51018.080.016
M5X20*	200	51018.050.020	M6X25*	200	51018.060.025	M8X20*	200	51018.080.020
M5X25*	200	51018.050.025	M6X30*	200	51018.060.030	M8X25	200	51018.080.025
M5X30*	200	51018.050.030	M6X35*	200	51018.060.035	M8X30*	200	51018.080.030
M5X35*	200	51018.050.035	M6X40*	200	51018.060.040	M8X35*	200	51018.080.035
M5X40*	200	51018.050.040	M6X45*	200	51018.060.045	M8X40*	200	51018.080.040
M5X45*	200	51018.050.045	M6X50*	200	51018.060.050	M8X45*	200	51018.080.045
M5X50*	200	51018.050.050						

51018 Hexagon bolt with flange, fully threaded								
d x L	☒	Art.number	d x L	☒	Art.number	d x L	☒	Art.number
M8X50*	200	51018.080.050	M10X20*	100	51018.100.020	M10X60*	100	51018.100.060
M8X55*	200	51018.080.055	M10X25*	100	51018.100.025	M10X65*	100	51018.100.065
M8X60*	200	51018.080.060	M10X30*	100	51018.100.030	M10X70*	100	51018.100.070
M8X65*	200	51018.080.065	M10X35*	100	51018.100.035	M10X80*	100	51018.100.080
M8X70*	200	51018.080.070	M10X40*	100	51018.100.040			
M8X80*	200	51018.080.080	M10X45*	100	51018.100.045	M12X60*	50	51018.120.060
M10X16*	100	51018.100.016	M10X50*	100	51018.100.050			
			M10X55*	100	51018.100.055			

55018 Hexagon bolt with flange, fully threaded		Q41A
Thread	Metric thread	
Material	Stainless steel A4	
Class	70	



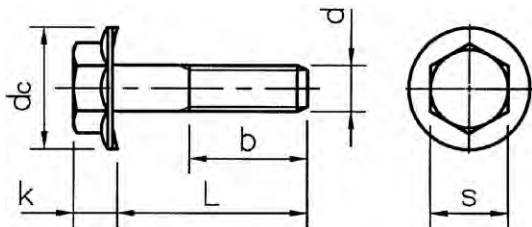

d x L	☒	Art.number	d x L	☒	Art.number	d x L	☒	Art.number
M5X8*	200	55018.050.008	M6X30*	200	55018.060.030	M8X55*	200	55018.080.055
M5X10*	200	55018.050.010	M6X35*	200	55018.060.035	M8X60*	200	55018.080.060
M5X12*	200	55018.050.012	M6X40*	200	55018.060.040			
M5X16*	200	55018.050.016	M6X45*	200	55018.060.045	M10X16*	100	55018.100.016
M5X20*	200	55018.050.020	M6X50*	200	55018.060.050	M10X20*	100	55018.100.020
M5X25*	200	55018.050.025	M6X55*	200	55018.060.055	M10X25*	100	55018.100.025
M5X30*	200	55018.050.030	M6X60*	200	55018.060.060	M10X30*	100	55018.100.030
M5X35*	200	55018.050.035				M10X35*	100	55018.100.035
M5X40*	200	55018.050.040	M8X12*	200	55018.080.012	M10X40*	100	55018.100.040
M5X45*	200	55018.050.045	M8X16*	200	55018.080.016	M10X45*	100	55018.100.045
M5X50*	200	55018.050.050	M8X20*	200	55018.080.020	M10X50*	100	55018.100.050
			M8X25*	200	55018.080.025	M10X55*	100	55018.100.055
M6X10*	200	55018.060.010	M8X30*	200	55018.080.030	M10X60*	100	55018.100.060
M6X12*	200	55018.060.012	M8X35*	200	55018.080.035	M10X65*	100	55018.100.065
M6X16*	200	55018.060.016	M8X40*	200	55018.080.040	M10X70*	100	55018.100.070
M6X20*	200	55018.060.020	M8X45*	200	55018.080.045	M10X80*	100	55018.100.080
M6X25*	200	55018.060.025	M8X50*	200	55018.080.050			

Hexagon bolt with flange, serrated, fully threaded

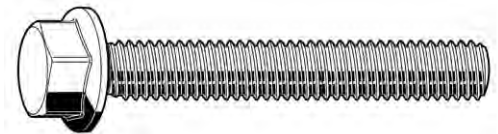

DIN ≈6921
 ISO ≈4162
 EN ≈1665
 ASME ≈B18.2.3.4M



Technical Data

d	b (min.)	d _c (max.)	k (max.)	P	s
M5	16	11.8	5.4	0.8	8
M6	18	14.2	6.6	1	10
M8	22	18	8.1	1.25	13
M10	26	22.3	9.2	1.5	15
M12	30	26.6	11.5	1.75	16

Article groups

Thread	Driving features	Material	Class	Surface treatment	Code	Page
M	Hexagon	St	8.8	Zipl	01258	1-69
M	Hexagon	St.St. A2	70		51014	1-69

01258 Hexagon bolt with flange, serrated, fully threaded		A94A
Thread	Metric thread	
Material	Steel	
Class	8.8	
Surface treatment	Zinc plated	
		

d x L	☒	Art.number	d x L	☒	Art.number	d x L	☒	Art.number
M6X12	200	01258.060.012	M8X25	200	01258.080.025	M10X40	100	01258.100.040
M6X16	200	01258.060.016	M8X30	200	01258.080.030			
M6X20	200	01258.060.020				M12X20	100	01258.120.020
M6X25	200	01258.060.025	M10X20	200	01258.100.020	M12X25	100	01258.120.025
M6X30	200	01258.060.030	M10X25	200	01258.100.025	M12X30	100	01258.120.030
			M10X30	200	01258.100.030	M12X35	100	01258.120.035
M8X16	200	01258.080.016	M10X35	100	01258.100.035	M12X40	100	01258.120.040
M8X20	200	01258.080.020						

- Special features of hexagon bolts with serrated flange:
- The flange enables built up forces to be spread over a larger area, consequently resulting in lower surface pressure
- Large holes (oversized) and/or tooling holes can be covered by the flange
- A washer is not necessary
- Serrated flangebrim gives excellent self-locking properties

51014 Hexagon bolt with flange, serrated, fully threaded		Q01A
Thread	Metric thread	
Material	Stainless steel A2	
Class	70	
		

d x L	☒	Art.number	d x L	☒	Art.number	d x L	☒	Art.number
M5X8*	200	51014.050.008	M6X35*	200	51014.060.035	M8X55*	200	51014.080.055
M5X10*	200	51014.050.010	M6X40*	200	51014.060.040	M8X60*	200	51014.080.060
M5X12*	200	51014.050.012	M6X45*	200	51014.060.045			
M5X16*	200	51014.050.016	M6X50*	200	51014.060.050	M10X16*	100	51014.100.016
M5X20*	200	51014.050.020	M6X55*	200	51014.060.055	M10X20*	100	51014.100.020
M5X25*	200	51014.050.025	M6X60*	200	51014.060.060	M10X25*	100	51014.100.025
M5X30*	200	51014.050.030				M10X30*	100	51014.100.030
M5X40*	200	51014.050.040	M8X12*	200	51014.080.012	M10X35*	100	51014.100.035
M5X50*	200	51014.050.050	M8X16*	200	51014.080.016	M10X40*	100	51014.100.040
			M8X20*	200	51014.080.020	M10X45*	100	51014.100.045
M6X10*	200	51014.060.010	M8X25*	200	51014.080.025	M10X50*	100	51014.100.050
M6X12*	200	51014.060.012	M8X30*	200	51014.080.030	M10X60*	100	51014.100.060
M6X16*	200	51014.060.016	M8X35*	200	51014.080.035	M10X65*	100	51014.100.065
M6X20*	200	51014.060.020	M8X40*	200	51014.080.040			
M6X25*	200	51014.060.025	M8X45*	200	51014.080.045	M12X90*	50	51014.120.090
M6X30*	200	51014.060.030	M8X50*	200	51014.080.050			

- Special features of hexagon bolts with serrated flange:
- The flange enables built up forces to be spread over a larger area, consequently resulting in lower surface pressure
- Large holes (oversized) and/or tooling holes can be covered by the flange
- A washer is not necessary
- Serrated flangebrim gives excellent self-locking properties"

1 Hexagon bolt with flange MF

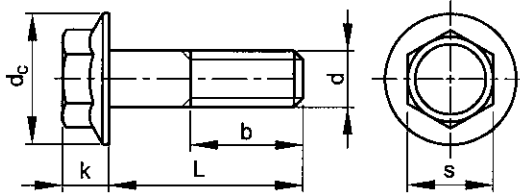

DIN 6921
 ISO ≈4162
 EN ≈1665
 ASME ≈B18.2.3.4M

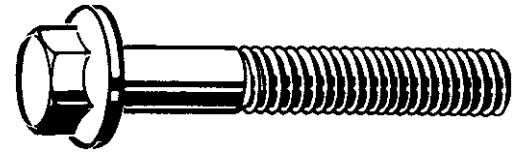

Technical Data

d	b (min.)	d _c (max.)	k (max.)	s
M8	22	18	8.1	13
M10	26	22.3	9.2	15
M12	30	26.6	11.5	16
M14	34	30.5	12.8	18
M16	38	35	14.4	21

- Special features of hexagon bolts with flange:
- The flange enables built up forces to be spread over a larger area, consequently resulting in lower surface pressure.
- Large holes (oversized) and/or tooling holes can be covered by the flange.
- A washer is not necessary.

04135	Hexagon bolt with flange MF	A92A
Thread	Metric fine thread	
Material	Steel	
Class	10.9	

d x P x L	☒	Art.number	d x P x L	☒	Art.number	d x P x L	☒	Art.number
M8X1,00X25	200	04135.080.025	M12X1,50X25	100	04135.120.025	M14X1,50X50	50	04135.140.050
M8X1,00X30	200	04135.080.030	M12X1,50X30	100	04135.120.030	M14X1,50X60	50	04135.140.060
M10X1,25X20	200	04135.100.020	M12X1,50X40	100	04135.120.040	M16X1,50X35	50	04135.160.035
M10X1,25X30	200	04135.100.030	M12X1,50X45	100	04135.120.045	M16X1,50X40	50	04135.160.040
M10X1,25X40	100	04135.100.040	M12X1,50X50	100	04135.120.050	M16X1,50X45	50	04135.160.045
M10X1,25X50	100	04135.100.050	M14X1,50X35	50	04135.140.035	M16X1,50X50	50	04135.160.050
M10X1,25X60	100	04135.100.060	M14X1,50X40	50	04135.140.040	M16X1,50X60	50	04135.160.060
M10X1,25X70	100	04135.100.070						

- Warning: electro-galvanizing of these products may cause hydrogen embrittlement.

Hexagon fit bolt with long thread

DIN 609

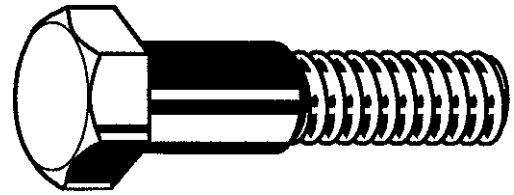
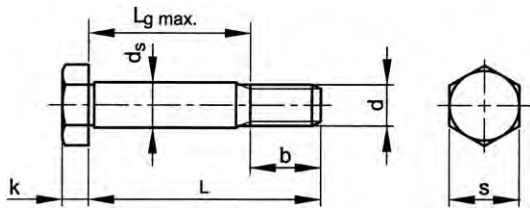

Technical Data

d	b:L≤50mm	b:50mm<L≤150mm	ds (k6)	k	P	s	Tolerance drill ø
M10	17.5	19.5	11	6.4	1.5	16	H7
M12	20.5	22.5	13	7.5	1.75	18	H7
M16	25	27	17	10	2	24	H7
M18	27.5	29.5	19	11.5	2.5	27	H7
M20	28.5	30.5	21	12.5	2.5	30	H7
M24	-	36.5	25	15	3	36	H7
M30	-	43	32	19	3.5	46	H7
M36	-	49	38	22	4	55	H7

01040 Hexagon fit bolt with long thread

A90A

Thread Metric thread
Material Steel
Class 8.8



d x L	☒	Art.number	d x L	☒	Art.number	d x L	☒	Art.number
M10X30	25	01040.100.030	M16X45	10	01040.160.045	M20X90	5	01040.200.090
M10X35	25	01040.100.035	M16X50	10	01040.160.050	M20X100	5	01040.200.100
M10X40	25	01040.100.040	M16X55	10	01040.160.055	M20X120	5	01040.200.120
M10X45	25	01040.100.045	M16X60	10	01040.160.060			
M10X50	25	01040.100.050	M16X70	10	01040.160.070	M24X55	3	01040.240.055
M10X55	25	01040.100.055	M16X80	10	01040.160.080	M24X60	3	01040.240.060
M10X60	25	01040.100.060	M16X90	10	01040.160.090	M24X70	3	01040.240.070
			M16X100	10	01040.160.100	M24X80	3	01040.240.080
M12X30	25	01040.120.030	M16X105	10	01040.160.105	M24X90	3	01040.240.090
M12X35	25	01040.120.035				M24X100	3	01040.240.100
M12X40	25	01040.120.040	M18X70	10	01040.180.070	M24X120	3	01040.240.120
M12X45	25	01040.120.045						
M12X50	25	01040.120.050	M20X45	5	01040.200.045	M30X100	1	01040.300.100
M12X55	25	01040.120.055	M20X50	5	01040.200.050	M30X120	1	01040.300.120
M12X60	25	01040.120.060	M20X55	5	01040.200.055			
M12X70	25	01040.120.070	M20X60	5	01040.200.060	M36X140	1	01040.360.140
			M20X70	5	01040.200.070	M36X150	1	01040.360.150
M16X40	10	01040.160.040	M20X80	5	01040.200.080			

Carriage bolt

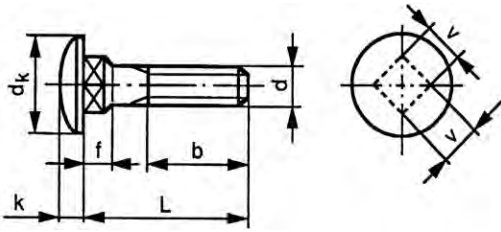

DIN 603
 ISO 8677
 NEN 303
 ASME B18.5.2.3M
 BS 4933

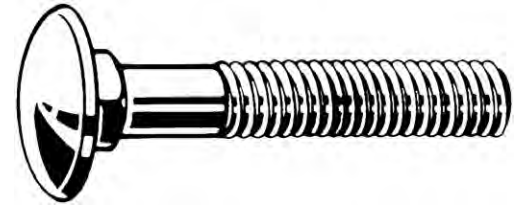

Technical Data

d	b (min.): L≤125mm	b (min.): 125mm<L≤200mm	b (min.): L>200mm	d _k (max.)	f (max.)	k (max.)	P	v (max.)
M5	16	22	-	13.55	4.1	3.3	0.8	5.48
M6	18	24	-	16.55	4.6	3.88	1	6.48
M8	22	28	41	20.65	5.6	4.88	1.25	8.58
M10	26	32	45	24.65	6.6	5.38	1.5	10.58
M12	30	36	49	30.65	8.75	6.95	1.75	12.7
M16	38	44	57	38.80	12.9	8.95	2	16.7

• Size 'b' is a guide value, it indicates on the minimum length of the threaded part.

Article groups

Thread	Material	Class	Surface treatment	Code	Page
M	St	8.8		08310	1-72
M	St	8.8	Zipl	08320	1-72
M	St.St. A2			51500	1-73
M	St.St. A4			55500	1-73

08310 Carriage bolt A90A

Thread	Metric thread
Material	Steel
Class	8.8

d x L	Art.number	d x L	Art.number	d x L	Art.number
M6X16	200 08310.060.016	M8X60	100 08310.080.060	M12X25	100 08310.120.025
M6X20	200 08310.060.020	M8X70	100 08310.080.070	M12X30	100 08310.120.030
M6X25	200 08310.060.025	M8X80	100 08310.080.080	M12X35	100 08310.120.035
M6X30	200 08310.060.030			M12X40	50 08310.120.040
M6X35	200 08310.060.035	M10X20	100 08310.100.020	M12X45	50 08310.120.045
M6X40	200 08310.060.040	M10X25	100 08310.100.025	M12X50	50 08310.120.050
M6X45	200 08310.060.045	M10X30	100 08310.100.030	M12X55	50 08310.120.055
M6X50	200 08310.060.050	M10X35	100 08310.100.035	M12X60	50 08310.120.060
		M10X40	100 08310.100.040	M12X65	50 08310.120.065
M8X16	200 08310.080.016	M10X45	100 08310.100.045	M12X70	50 08310.120.070
M8X20	200 08310.080.020	M10X50	100 08310.100.050	M12X80	50 08310.120.080
M8X25	200 08310.080.025	M10X55	100 08310.100.055	M12X90	50 08310.120.090
M8X30	200 08310.080.030	M10X60	100 08310.100.060	M12X100	50 08310.120.100
M8X35	200 08310.080.035	M10X70	100 08310.100.070		
M8X40	200 08310.080.040	M10X80	50 08310.100.080	M16X90	25 08310.160.090
M8X45	200 08310.080.045	M10X90	50 08310.100.090	M16X120	25 08310.160.120
M8X50	200 08310.080.050	M10X100	50 08310.100.100		
M8X55	100 08310.080.055				

08320 Carriage bolt A90A

Thread	Metric thread
Material	Steel
Class	8.8
Surface treatment	Zinc plated

d x L	Art.number	d x L	Art.number	d x L	Art.number
M6X16	200 08320.060.016	M8X30	200 08320.080.030	M10X25	100 08320.100.025
M6X20	200 08320.060.020	M8X35	200 08320.080.035	M10X30	100 08320.100.030
M6X30	200 08320.060.030	M8X40	200 08320.080.040	M10X35	100 08320.100.035
M6X40	200 08320.060.040	M8X45	200 08320.080.045	M10X40	100 08320.100.040
M6X50	200 08320.060.050	M8X50	200 08320.080.050	M10X50	100 08320.100.050
		M8X55	100 08320.080.055	M10X60	100 08320.100.060
M8X16	200 08320.080.016	M8X60	100 08320.080.060	M10X70	100 08320.100.070
M8X20	200 08320.080.020			M10X80	50 08320.100.080
M8X25	200 08320.080.025	M10X20	100 08320.100.020	M10X90	50 08320.100.090

08320 Carriage bolt								
d x L	☒	Art.number	d x L	☒	Art.number	d x L	☒	Art.number
M10X100	50	08320.100.100	M12X40	50	08320.120.040	M12X70	50	08320.120.070
M12X30	100	08320.120.030	M12X45	50	08320.120.045	M12X80	50	08320.120.080
M12X35	100	08320.120.035	M12X50	50	08320.120.050	M12X90	50	08320.120.090
			M12X60	50	08320.120.060	M12X100	50	08320.120.100

51500 Carriage bolt		R03A
Thread	Metric thread	
Material	Stainless steel A2	
		

d x L	☒	Art.number	d x L	☒	Art.number	d x L	☒	Art.number
M5X12*	500	51500.050.012	M8X100	25	51500.080.100	M12X55*	50	51500.120.055
M5X16	50	51500.050.016	M8X110	25	51500.080.110	M12X60	10	51500.120.060
M5X18*	200	51500.050.018	M8X120	50	51500.080.120	M12X70	10	51500.120.070
M5X20	50	51500.050.020	M8X130	25	51500.080.130	M12X80	10	51500.120.080
M5X25	50	51500.050.025	M8X140	25	51500.080.140	M12X90	10	51500.120.090
M5X30	50	51500.050.030	M8X150	25	51500.080.150	M12X100	10	51500.120.100
M5X35	50	51500.050.035	M8X160*	50	51500.080.160	M12X110	10	51500.120.110
M5X40	50	51500.050.040	M8X170*	50	51500.080.170	M12X120	10	51500.120.120
M5X45	50	51500.050.045	M8X180*	50	51500.080.180	M12X130	10	51500.120.130
M5X50	50	51500.050.050	M8X190*	50	51500.080.190	M12X140	10	51500.120.140
M5X60	50	51500.050.060	M8X200*	50	51500.080.200	M12X160*	50	51500.120.160
M6X16	50	51500.060.016	M10X16*	100	51500.100.016	M12X180*	50	51500.120.180
M6X20	50	51500.060.020	M10X20	25	51500.100.020	M12X200*	50	51500.120.200
M6X25	50	51500.060.025	M10X25	25	51500.100.025	M12X220*	50	51500.120.220
M6X30	50	51500.060.030	M10X30	25	51500.100.030	M12X240*	50	51500.120.240
M6X35	50	51500.060.035	M10X35	25	51500.100.035	M12X260*	50	51500.120.260
M6X40	50	51500.060.040	M10X40	25	51500.100.040	M12X280*	50	51500.120.280
M6X45	50	51500.060.045	M10X45	25	51500.100.045	M12X300*	50	51500.120.300
M6X50	50	51500.060.050	M10X50	25	51500.100.050	M16X30*	25	51500.160.030
M6X55	50	51500.060.055	M10X55	25	51500.100.055	M16X35*	25	51500.160.035
M6X60	50	51500.060.060	M10X60	10	51500.100.060	M16X40*	25	51500.160.040
M6X70	50	51500.060.070	M10X70	10	51500.100.070	M16X45	10	51500.160.045
M6X80	50	51500.060.080	M10X80	10	51500.100.080	M16X50*	25	51500.160.050
M6X90	50	51500.060.090	M10X90	10	51500.100.090	M16X55*	25	51500.160.055
M6X100	50	51500.060.100	M10X100	10	51500.100.100	M16X60	10	51500.160.060
M6X110	50	51500.060.110	M10X110	10	51500.100.110	M16X65	10	51500.160.065
M6X120	50	51500.060.120	M10X120	10	51500.100.120	M16X70*	25	51500.160.070
M8X12*	100	51500.080.012	M10X130	10	51500.100.130	M16X75*	25	51500.160.075
M8X16	50	51500.080.016	M10X140	10	51500.100.140	M16X80*	25	51500.160.080
M8X18*	100	51500.080.018	M10X150	10	51500.100.150	M16X90*	25	51500.160.090
M8X20	50	51500.080.020	M10X160	50	51500.100.160	M16X100*	25	51500.160.100
M8X25	50	51500.080.025	M10X180	50	51500.100.180	M16X110*	25	51500.160.110
M8X30	50	51500.080.030	M10X200*	50	51500.100.200	M16X120*	25	51500.160.120
M8X35	50	51500.080.035	M10X220*	50	51500.100.220	M16X130*	25	51500.160.130
M8X40	25	51500.080.040	M10X240*	50	51500.100.240	M16X140*	25	51500.160.140
M8X45	25	51500.080.045	M10X260*	50	51500.100.260	M16X150*	25	51500.160.150
M8X50	25	51500.080.050	M10X280*	50	51500.100.280	M16X160*	25	51500.160.160
M8X55	25	51500.080.055	M10X300*	50	51500.100.300	M16X180*	25	51500.160.180
M8X60	25	51500.080.060	M12X25	10	51500.120.025	M16X200*	25	51500.160.200
M8X65	100	51500.080.065	M12X30	10	51500.120.030	M16X220*	25	51500.160.220
M8X70	25	51500.080.070	M12X35	10	51500.120.035	M16X240*	25	51500.160.240
M8X75*	50	51500.080.075	M12X40	10	51500.120.040	M16X260*	25	51500.160.260
M8X80	25	51500.080.080	M12X50	10	51500.120.050	M16X280*	25	51500.160.280
M8X90	25	51500.080.090				M16X300*	25	51500.160.300

55500 Carriage bolt		R43A
Thread	Metric thread	
Material	Stainless steel A4	
		

d x L	☒	Art.number	d x L	☒	Art.number	d x L	☒	Art.number
M5X16	50	55500.050.016	M5X70	50	55500.050.070	M6X40	50	55500.060.040
M5X20	50	55500.050.020	M6X12*	200	55500.060.012	M6X45	50	55500.060.045
M5X25*	200	55500.050.025	M6X16	50	55500.060.016	M6X50	50	55500.060.050
M5X30	50	55500.050.030	M6X20	50	55500.060.020	M6X60	50	55500.060.060
M5X35	50	55500.050.035	M6X25	50	55500.060.025	M6X65	50	55500.060.065
M5X40	50	55500.050.040	M6X30	50	55500.060.030	M6X70	50	55500.060.070
M5X50	50	55500.050.050	M6X35	50	55500.060.035	M6X80	50	55500.060.080
M5X60	50	55500.050.060				M6X90	50	55500.060.090

55500		Carriage bolt							
d x L	☒	Art.number	d x L	☒	Art.number	d x L	☒	Art.number	
M6X100	50	55500.060.100	M10X40	25	55500.100.040	M12X110	10	55500.120.110	
M6X110	25	55500.060.110	M10X50	25	55500.100.050	M12X120	10	55500.120.120	
M6X120	25	55500.060.120	M10X60	10	55500.100.060	M12X130	10	55500.120.130	
			M10X70	10	55500.100.070	M12X140	10	55500.120.140	
M8X10*	50	55500.080.010	M10X80	10	55500.100.080	M12X150	10	55500.120.150	
M8X16	50	55500.080.016	M10X100	10	55500.100.100	M12X160*	50	55500.120.160	
M8X20	50	55500.080.020	M10X110	10	55500.100.110	M12X180*	50	55500.120.180	
M8X25	50	55500.080.025	M10X120	10	55500.100.120				
M8X30	50	55500.080.030	M10X130	10	55500.100.130	M16X40	10	55500.160.040	
M8X35	50	55500.080.035	M10X140	10	55500.100.140	M16X50	10	55500.160.050	
M8X40	25	55500.080.040	M10X150	10	55500.100.150	M16X55*	25	55500.160.055	
M8X50	25	55500.080.050	M10X160*	50	55500.100.160	M16X60	10	55500.160.060	
M8X60	25	55500.080.060	M10X200*	50	55500.100.200	M16X65*	25	55500.160.065	
M8X70	25	55500.080.070				M16X70	10	55500.160.070	
M8X80	25	55500.080.080	M12X25*	50	55500.120.025	M16X75*	25	55500.160.075	
M8X90	25	55500.080.090	M12X30	10	55500.120.030	M16X80	5	55500.160.080	
M8X100	25	55500.080.100	M12X35	10	55500.120.035	M16X90	5	55500.160.090	
M8X110	10	55500.080.110	M12X40	10	55500.120.040	M16X100	5	55500.160.100	
M8X120	10	55500.080.120	M12X45	10	55500.120.045	M16X110*	25	55500.160.110	
M8X130	10	55500.080.130	M12X50	10	55500.120.050	M16X120	5	55500.160.120	
M8X140	10	55500.080.140	M12X60	10	55500.120.060	M16X130	5	55500.160.130	
M8X150	10	55500.080.150	M12X70	10	55500.120.070	M16X140	5	55500.160.140	
			M12X80	10	55500.120.080	M16X150	5	55500.160.150	
M10X20	25	55500.100.020	M12X90	10	55500.120.090				
M10X30	25	55500.100.030	M12X100	10	55500.120.100				

Carriage bolt fully threaded

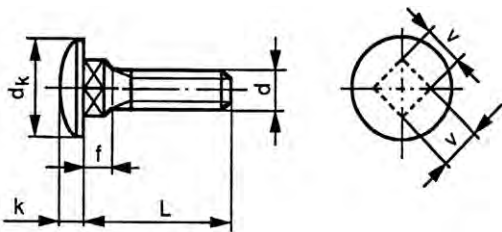

DIN ≈603
ISO ≈8677

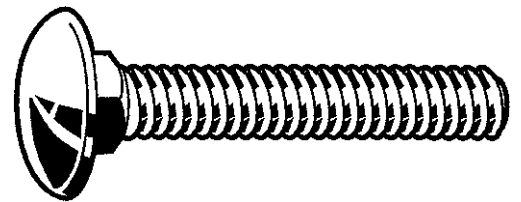

Technical Data

d	b (min.): L≤125mm	b (min.): 125mm<L≤200mm	b (min.): L>200mm	dk (max.)	f (max.)	k (max.)	P	v (max.)
M5	16	22	-	13.55	4.1	3.3	0.8	5.48
M6	18	24	-	16.55	4.6	3.88	1	6.48
M8	22	28	41	20.65	5.6	4.88	1.25	8.58
M10	26	32	45	24.65	6.6	5.38	1.5	10.58
M12	30	36	49	30.65	8.75	6.95	1.75	12.7

Article groups

Thread	Material	Code	Page
M	St.St. A2	51501	1-74
M	St.St. A4	55501	1-75

51501 Carriage bolt fully threaded R09A

Thread Metric thread
Material Stainless steel A2

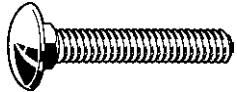



d x L	☒	Art.number	d x L	☒	Art.number	d x L	☒	Art.number
M5X35*	200	51501.050.035	M6X25*	200	51501.060.025	M8X90*	50	51501.080.090
M5X45*	200	51501.050.045	M6X55*	100	51501.060.055	M8X120*	50	51501.080.120
M5X55*	200	51501.050.055	M6X65*	100	51501.060.065	M8X130*	50	51501.080.130
M5X65*	200	51501.050.065	M6X75*	100	51501.060.075	M8X140*	50	51501.080.140
M5X70*	200	51501.050.070	M6X110*	100	51501.060.110	M8X150*	50	51501.080.150
M5X75*	200	51501.050.075	M6X120*	100	51501.060.120			
M5X80*	200	51501.050.080	M6X130*	100	51501.060.130	M10X35*	100	51501.100.035
M5X90*	200	51501.050.090	M6X140*	100	51501.060.140	M10X40*	100	51501.100.040
M5X100*	200	51501.050.100	M6X150*	100	51501.060.150	M10X45*	100	51501.100.045
M5X110*	200	51501.050.110				M10X50*	50	51501.100.050
M5X120*	200	51501.050.120	M8X55*	100	51501.080.055	M10X55*	50	51501.100.055
			M8X65*	100	51501.080.065	M10X60*	50	51501.100.060
M6X12*	200	51501.060.012	M8X75*	50	51501.080.075	M10X65*	50	51501.100.065

51501 Carriage bolt fully threaded								
d x L	☒	Art.number	d x L	☒	Art.number	d x L	☒	Art.number
M10X70*	50	51501.100.070	M12X35*	50	51501.120.035	M12X90*	50	51501.120.090
M10X75*	50	51501.100.075	M12X45*	50	51501.120.045	M12X100*	50	51501.120.100
M10X80*	50	51501.100.080	M12X55*	50	51501.120.055	M12X110*	50	51501.120.110
M10X100*	50	51501.100.100	M12X60*	50	51501.120.060	M12X120*	50	51501.120.120
M10X110*	50	51501.100.110	M12X65*	50	51501.120.065	M12X130*	50	51501.120.130
M10X120*	50	51501.100.120	M12X70*	50	51501.120.070	M12X140*	50	51501.120.140
M10X130*	50	51501.100.130	M12X75*	50	51501.120.075	M12X150*	50	51501.120.150
M10X140*	50	51501.100.140	M12X80*	50	51501.120.080			
M10X150*	50	51501.100.150						

55501 Carriage bolt fully threaded		R49A
Thread	Metric thread	
Material	Stainless steel A4	
		
		

d x L	☒	Art.number	d x L	☒	Art.number	d x L	☒	Art.number
M5X45*	200	55501.050.045	M8X55*	100	55501.080.055	M10X65*	50	55501.100.065
M5X80*	200	55501.050.080	M8X65*	100	55501.080.065	M10X75*	50	55501.100.075
			M8X75*	50	55501.080.075	M10X90*	50	55501.100.090
M6X55*	100	55501.060.055	M10X16*	100	55501.100.016	M12X35*	50	55501.120.035
M6X65*	100	55501.060.065	M10X25*	100	55501.100.025	M12X45*	50	55501.120.045
M6X75*	100	55501.060.075	M10X35*	100	55501.100.035	M12X65*	50	55501.120.065
M6X140*	100	55501.060.140	M10X45*	100	55501.100.045	M12X75*	50	55501.120.075
M8X45*	100	55501.080.045	M10X55*	50	55501.100.055			

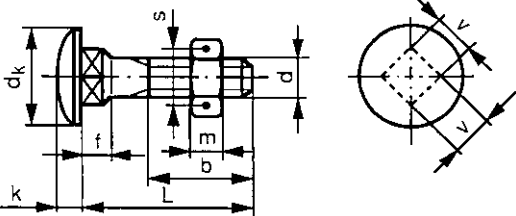
Carriage bolt with hexagon nut



DIN 603/555 (1987)
ISO 8677/-
NEN 303/697
ASME B18.5.2.3M/-
NF - / E25-402
BS 4933/-

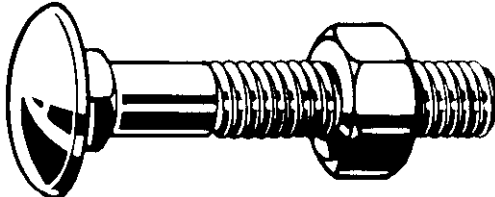

Technical Data										
d	b (min.): L≤125mm	b (min.): 125mm<L≤200mm	b (min.): L>200mm	dk (max.)	f (max.)	k (max.)	m	P	s	v (max.)
M5	16	22	-	13.55	4.1	3.3	4	0.8	8	5.48
M6	18	24	-	16.55	4.6	3.88	5	1	10	6.48
M8	22	28	41	20.65	5.6	4.88	6.5	1.25	13	8.58
M10	26	32	45	24.65	6.6	5.38	8	1.5	17	10.58
M12	30	36	49	30.65	8.75	6.95	10	1.75	19	12.7
M16	38	44	57	38.8	12.9	8.95	13	2	24	16.7

* Size 'b' is a guide value, it indicates on the minimum length of the threaded part.

Article groups

Thread	Material	Class	Surface treatment	Code	Page
M	St	≥4.6	Zipl	08250	1-75
M	St	≥4.6	Hot d.g.	08420	1-76

08250 Carriage bolt with hexagon nut		E05A
Thread	Metric thread	
Material	Steel	
Class	≥4.6	
Surface treatment	Zinc plated	
		
		

d x L	☒	Art.number	d x L	☒	Art.number	d x L	☒	Art.number
M5X16	500	08250.050.016	M5X45	200	08250.050.045	M6X16	200	08250.060.016
M5X20	500	08250.050.020	M5X50	200	08250.050.050	M6X20	200	08250.060.020
M5X25	500	08250.050.025	M5X60	200	08250.050.060	M6X25	200	08250.060.025
M5X30	500	08250.050.030	M5X65	200	08250.050.065	M6X30	200	08250.060.030
M5X35	200	08250.050.035	M5X70	200	08250.050.070	M6X35	200	08250.060.035
M5X40	200	08250.050.040	M5X80	200	08250.050.080			

08250 Carriage bolt with hexagon nut ←								
d x L	☒	Art.number	d x L	☒	Art.number	d x L	☒	Art.number
M6X40	200	08250.060.040	M10X30	200	08250.100.030	M12X140	50	08250.120.140
M6X45	200	08250.060.045	M10X35	100	08250.100.035	M12X150	50	08250.120.150
M6X50	200	08250.060.050	M10X40	100	08250.100.040	M12X160	25	08250.120.160
M6X55	200	08250.060.055	M10X45	100	08250.100.045	M12X170	25	08250.120.170
M6X60	200	08250.060.060	M10X50	100	08250.100.050	M12X180	25	08250.120.180
M6X65	200	08250.060.065	M10X55	100	08250.100.055	M12X190	25	08250.120.190
M6X70	200	08250.060.070	M10X60	100	08250.100.060	M12X200	25	08250.120.200
M6X75	200	08250.060.075	M10X65	100	08250.100.065	M12X220	25	08250.120.220
M6X80	200	08250.060.080	M10X70	100	08250.100.070	M12X240	25	08250.120.240
M6X90	100	08250.060.090	M10X75	100	08250.100.075	M12X250	25	08250.120.250
M6X100	100	08250.060.100	M10X80	100	08250.100.080	M12X260	25	08250.120.260
M6X110	100	08250.060.110	M10X90	100	08250.100.090	M12X280	25	08250.120.280
M6X120	100	08250.060.120	M10X100	100	08250.100.100	M12X300	25	08250.120.300
M6X130	100	08250.060.130	M10X110	50	08250.100.110	M12X320	10	08250.120.320
M6X140	100	08250.060.140	M10X120	50	08250.100.120	M12X340	10	08250.120.340
M6X150	100	08250.060.150	M10X130	50	08250.100.130	M12X360	10	08250.120.360
			M10X140	50	08250.100.140	M12X380	10	08250.120.380
M8X16	200	08250.080.016	M10X150	50	08250.100.150	M12X400	10	08250.120.400
M8X20	200	08250.080.020	M10X160	50	08250.100.160			
M8X25	200	08250.080.025	M10X170	50	08250.100.170	M16X50	50	08250.160.050
M8X30	200	08250.080.030	M10X180	50	08250.100.180	M16X60	50	08250.160.060
M8X35	200	08250.080.035	M10X190	50	08250.100.190	M16X70	25	08250.160.070
M8X40	200	08250.080.040	M10X200	50	08250.100.200	M16X80	25	08250.160.080
M8X45	200	08250.080.045	M10X220	25	08250.100.220	M16X90	25	08250.160.090
M8X50	200	08250.080.050	M10X240	25	08250.100.240	M16X100	25	08250.160.100
M8X55	200	08250.080.055	M10X260	25	08250.100.260	M16X110	25	08250.160.110
M8X60	200	08250.080.060	M10X280	25	08250.100.280	M16X120	25	08250.160.120
M8X65	200	08250.080.065	M10X300	25	08250.100.300	M16X130	25	08250.160.130
M8X70	200	08250.080.070				M16X140	25	08250.160.140
M8X75	200	08250.080.075	M12X30	100	08250.120.030	M16X160	25	08250.160.160
M8X80	200	08250.080.080	M12X35	100	08250.120.035	M16X170	25	08250.160.170
M8X90	100	08250.080.090	M12X40	100	08250.120.040	M16X180	25	08250.160.180
M8X100	100	08250.080.100	M12X45	100	08250.120.045	M16X200	10	08250.160.200
M8X110	100	08250.080.110	M12X50	100	08250.120.050	M16X220	10	08250.160.220
M8X120	100	08250.080.120	M12X55	100	08250.120.055	M16X240	10	08250.160.240
M8X130	100	08250.080.130	M12X60	100	08250.120.060	M16X260	10	08250.160.260
M8X140	50	08250.080.140	M12X65	50	08250.120.065	M16X280	10	08250.160.280
M8X150	50	08250.080.150	M12X70	50	08250.120.070	M16X300	10	08250.160.300
M8X160	50	08250.080.160	M12X75	50	08250.120.075	M16X320	10	08250.160.320
M8X170	50	08250.080.170	M12X80	50	08250.120.080	M16X340	10	08250.160.340
M8X180	50	08250.080.180	M12X90	50	08250.120.090	M16X360	10	08250.160.360
M8X200	50	08250.080.200	M12X100	50	08250.120.100	M16X380	10	08250.160.380
			M12X110	50	08250.120.110	M16X400	10	08250.160.400
M10X20	200	08250.100.020	M12X120	50	08250.120.120			
M10X25	200	08250.100.025	M12X130	50	08250.120.130			

08420 Carriage bolt with hexagon nut oversized thread			A08A	
Thread	Metric thread			
Material	Steel			
Class	≥4.6			
Surface treatment	Hot dip galvanized			

d x L	☒	Art.number	d x L	☒	Art.number	d x L	☒	Art.number
M8X50	200	08420.080.050	M10X160	50	08420.100.160	M12X220	25	08420.120.220
M8X60	200	08420.080.060	M10X170	50	08420.100.170	M12X240	25	08420.120.240
M8X70	200	08420.080.070	M10X180	50	08420.100.180	M12X260	25	08420.120.260
M8X80	100	08420.080.080	M10X200	50	08420.100.200	M12X280	25	08420.120.280
M8X90	100	08420.080.090	M10X220	25	08420.100.220	M12X300	25	08420.120.300
M8X100	100	08420.080.100	M10X240	25	08420.100.240	M12X320	10	08420.120.320
M8X110	100	08420.080.110	M10X280	25	08420.100.280	M12X340	10	08420.120.340
M8X120	100	08420.080.120	M10X300	25	08420.100.300	M12X360	10	08420.120.360
M8X130	100	08420.080.130				M12X400	10	08420.120.400
M8X140	50	08420.080.140	M12X60	50	08420.120.060			
M8X160	50	08420.080.160	M12X70	50	08420.120.070	M16X90	25	08420.160.090
M8X180	50	08420.080.180	M12X80	50	08420.120.080	M16X100	25	08420.160.100
			M12X90	50	08420.120.090	M16X120	25	08420.160.120
M10X50	100	08420.100.050	M12X100	50	08420.120.100	M16X130	25	08420.160.130
M10X60	100	08420.100.060	M12X110	50	08420.120.110	M16X140	25	08420.160.140
M10X70	100	08420.100.070	M12X120	50	08420.120.120	M16X150	25	08420.160.150
M10X80	100	08420.100.080	M12X130	50	08420.120.130	M16X160	25	08420.160.160
M10X90	100	08420.100.090	M12X140	50	08420.120.140	M16X180	25	08420.160.180
M10X100	100	08420.100.100	M12X150	50	08420.120.150	M16X200	10	08420.160.200
M10X110	50	08420.100.110	M12X160	25	08420.120.160	M16X220	10	08420.160.220
M10X120	50	08420.100.120	M12X170	25	08420.120.170	M16X240	10	08420.160.240
M10X130	50	08420.100.130	M12X180	25	08420.120.180	M16X260	10	08420.160.260
M10X140	50	08420.100.140	M12X200	25	08420.120.200	M16X280	10	08420.160.280
M10X150	50	08420.100.150						

08420 Carriage bolt with hexagon nut oversized thread

- For hot dip galvanized bolts with OVERSIZED thread the zinc layer is applied ON the normal thread, so AFTER galvanizing these bolts are no longer ISO-metric mating, but thicker: so called OVERSIZED.
- The corresponding OVERSIZED nuts have been Oversize tapped according to ISO 965-5 AFTER galvanizing running perfectly onto these bolts.

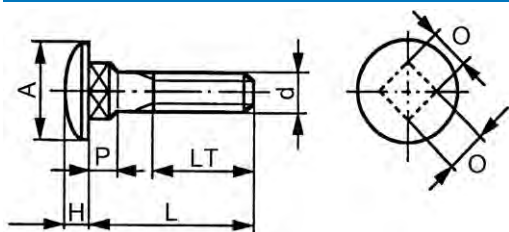
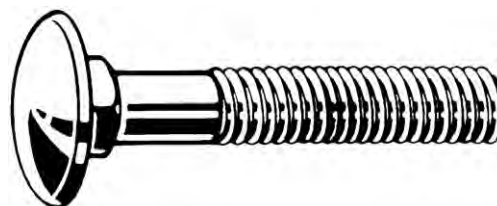
Carriage bolt UNC

 ASME B18.5.2.3M
 B18.5.2.3

Technical Data

d	A (max.)	H (max.)	L _T (min.): L≤6 Inch	L _T (min.): L>6 Inch	O (max.)	P (max.)	Threads per inch
1/4	0.594	0.145	0.750	1.000	0.260	0.156	20
5/16	0.719	0.176	0.875	1.125	0.324	0.187	18
3/8	0.844	0.208	1.000	1.250	0.388	0.219	16
7/16	0.969	0.239	1.125	1.375	0.452	0.250	14
1/2	1.094	0.270	1.250	1.500	0.515	0.281	13
5/8	1.344	0.344	1.500	1.750	0.642	0.344	11
3/4	1.594	0.406	1.750	2.000	0.768	0.406	10

Article groups

Thread	Material	Class	Surface treatment	Code	Page
UNC	St	Grade 2		U08300	1-77
UNC	St	Grade 2	Zipl	U08305	1-78
UNC	St	Grade 2	Hot d.g.	U08307	1-78
UNC	St	Grade 5	Zipl	U08320	1-78
UNC	St.St. A2 (AISI304/18-8)			U51500	1-79

U08300 Carriage bolt UNC
X09A

Thread Unified National Coarse
Material Steel
Class Grade 2



d x L	Art.number	d x L	Art.number	d x L	Art.number
1/4-20X1/2*	100 U08300.025.0050	5/16-18X6 Inch*	50 U08300.031.0600	1/2-13X2.1/2*	25 U08300.050.0250
1/4-20X3/4*	100 U08300.025.0075			1/2-13X3 Inch*	25 U08300.050.0300
1/4-20X1 Inch*	100 U08300.025.0100	3/8-16X1 Inch*	100 U08300.037.0100	1/2-13X3.1/2*	25 U08300.050.0350
1/4-20X1.1/4*	100 U08300.025.0125	3/8-16X1.1/2*	100 U08300.037.0150	1/2-13X4 Inch*	10 U08300.050.0400
1/4-20X1.1/2*	100 U08300.025.0150	3/8-16X2 Inch*	50 U08300.037.0200	1/2-13X5 Inch*	10 U08300.050.0500
1/4-20X2 Inch*	100 U08300.025.0200	3/8-16X2.1/2*	50 U08300.037.0250	1/2-13X6 Inch*	10 U08300.050.0600
1/4-20X2.1/2*	100 U08300.025.0250	3/8-16X3 Inch*	25 U08300.037.0300		
1/4-20X3 Inch*	50 U08300.025.0300	3/8-16X3.1/2*	25 U08300.037.0350	5/8-11X2 Inch*	10 U08300.062.0200
1/4-20X3.1/2*	50 U08300.025.0350	3/8-16X4 Inch*	25 U08300.037.0400	5/8-11X2.1/4*	10 U08300.062.0225
1/4-20X4 Inch*	50 U08300.025.0400	3/8-16X4.1/2*	10 U08300.037.0450	5/8-11X2.1/2*	10 U08300.062.0250
1/4-20X4.1/2*	50 U08300.025.0450	3/8-16X5 Inch*	10 U08300.037.0500	5/8-11X3 Inch*	10 U08300.062.0300
1/4-20X5 Inch*	50 U08300.025.0500	3/8-16X6 Inch*	10 U08300.037.0600	5/8-11X3.1/2*	10 U08300.062.0350
		3/8-16X6.1/2*	10 U08300.037.0650	5/8-11X4 Inch*	10 U08300.062.0400
5/16-18X1 Inch*	100 U08300.031.0100	3/8-16X7 Inch*	10 U08300.037.0700	5/8-11X5 Inch*	10 U08300.062.0500
5/16-18X1.1/4*	100 U08300.031.0125			5/8-11X6 Inch*	10 U08300.062.0600
5/16-18X1.1/2*	100 U08300.031.0150	7/16-14X1.1/4*	50 U08300.043.0125		
5/16-18X2 Inch*	100 U08300.031.0200	7/16-14X1.1/2*	50 U08300.043.0150	3/4-10X2 Inch*	10 U08300.075.0200
5/16-18X2.1/2*	100 U08300.031.0250	7/16-14X2 Inch*	50 U08300.043.0200	3/4-10X3 Inch*	10 U08300.075.0300
5/16-18X3 Inch*	50 U08300.031.0300	7/16-14X2.1/2*	25 U08300.043.0250	3/4-10X4 Inch*	10 U08300.075.0400
5/16-18X3.1/2*	50 U08300.031.0350			3/4-10X5 Inch*	10 U08300.075.0500
5/16-18X4 Inch*	50 U08300.031.0400	1/2-13X1.1/4*	50 U08300.050.0125	3/4-10X6 Inch*	10 U08300.075.0600
5/16-18X4.1/2*	50 U08300.031.0450	1/2-13X1.1/2*	50 U08300.050.0150	3/4-10X7 Inch*	5 U08300.075.0700
5/16-18X5 Inch*	50 U08300.031.0500	1/2-13X1.3/4*	25 U08300.050.0175	3/4-10X8 Inch*	5 U08300.075.0800
5/16-18X5.1/2*	50 U08300.031.0550	1/2-13X2 Inch*	25 U08300.050.0200		

U08305 Carriage bolt UNC		X09A	
Thread	Unified National Coarse		
Material	Steel		
Class	Grade 2		
Surface treatment	Zinc plated		

d x L	☒	Art.number	d x L	☒	Art.number	d x L	☒	Art.number
1/4-20X1/2*	100	U08305.025.0050	5/16-18X5.1/2*	50	U08305.031.0550	1/2-13X1.3/4*	25	U08305.050.0175
1/4-20X5/8*	100	U08305.025.0062	5/16-18X6 Inch*	50	U08305.031.0600	1/2-13X2 Inch*	25	U08305.050.0200
1/4-20X3/4*	100	U08305.025.0075				1/2-13X2.1/4*	25	U08305.050.0225
1/4-20X1 Inch*	100	U08305.025.0100	3/8-16X3/4*	100	U08305.037.0075	1/2-13X2.1/2*	25	U08305.050.0250
1/4-20X1.1/4*	100	U08305.025.0125	3/8-16X1 Inch*	100	U08305.037.0100	1/2-13X2.3/4*	25	U08305.050.0275
1/4-20X1.1/2*	100	U08305.025.0150	3/8-16X1.1/4*	100	U08305.037.0125	1/2-13X3 Inch*	25	U08305.050.0300
1/4-20X1.3/4*	100	U08305.025.0175	3/8-16X1.1/2*	100	U08305.037.0150	1/2-13X3.1/2*	25	U08305.050.0350
1/4-20X2 Inch*	100	U08305.025.0200	3/8-16X1.3/4*	100	U08305.037.0175	1/2-13X4 Inch*	10	U08305.050.0400
1/4-20X2.1/4*	100	U08305.025.0225	3/8-16X2 Inch*	50	U08305.037.0200	1/2-13X5 Inch*	10	U08305.050.0500
1/4-20X2.1/2*	100	U08305.025.0250	3/8-16X2.1/4*	50	U08305.037.0225	1/2-13X6 Inch*	10	U08305.050.0600
1/4-20X2.3/4*	100	U08305.025.0275	3/8-16X2.1/2*	50	U08305.037.0250	1/2-13X8 Inch*	10	U08305.050.0800
1/4-20X3 Inch*	50	U08305.025.0300	3/8-16X2.3/4*	50	U08305.037.0275	1/2-13X9 Inch*	10	U08305.050.0900
1/4-20X3.1/2*	50	U08305.025.0350	3/8-16X3 Inch*	25	U08305.037.0300	1/2-13X10 Inch*	10	U08305.050.1000
1/4-20X4 Inch*	50	U08305.025.0400	3/8-16X3.1/2*	25	U08305.037.0350			
1/4-20X4.1/2*	50	U08305.025.0450	3/8-16X4 Inch*	25	U08305.037.0400	5/8-11X1.1/2*	10	U08305.062.0150
1/4-20X5 Inch*	50	U08305.025.0500	3/8-16X4.1/2*	10	U08305.037.0450	5/8-11X2 Inch*	10	U08305.062.0200
			3/8-16X5 Inch*	10	U08305.037.0500	5/8-11X2.1/2*	10	U08305.062.0250
5/16-18X3/4*	100	U08305.031.0075	3/8-16X5.1/2*	10	U08305.037.0550	5/8-11X3 Inch*	10	U08305.062.0300
5/16-18X1 Inch*	100	U08305.031.0100	3/8-16X6 Inch*	10	U08305.037.0600	5/8-11X3.1/2*	10	U08305.062.0350
5/16-18X1.1/4*	100	U08305.031.0125	3/8-16X7 Inch*	10	U08305.037.0700	5/8-11X4 Inch*	10	U08305.062.0400
5/16-18X1.1/2*	100	U08305.031.0150	3/8-16X8 Inch*	10	U08305.037.0800	5/8-11X4.1/2*	10	U08305.062.0450
5/16-18X1.3/4*	100	U08305.031.0175				5/8-11X5 Inch*	10	U08305.062.0500
5/16-18X2 Inch*	100	U08305.031.0200	7/16-14X1 Inch*	50	U08305.043.0100	5/8-11X6 Inch*	10	U08305.062.0600
5/16-18X2.1/4*	100	U08305.031.0225	7/16-14X2 Inch*	50	U08305.043.0200			
5/16-18X2.1/2*	100	U08305.031.0250	7/16-14X3 Inch*	25	U08305.043.0300	3/4-10X2 Inch*	10	U08305.075.0200
5/16-18X2.3/4*	50	U08305.031.0275	7/16-14X4 Inch*	10	U08305.043.0400	3/4-10X3 Inch*	10	U08305.075.0300
5/16-18X3 Inch*	50	U08305.031.0300	7/16-14X4.1/2*	10	U08305.043.0450	3/4-10X4 Inch*	10	U08305.075.0400
5/16-18X3.1/2*	50	U08305.031.0350				3/4-10X5 Inch*	10	U08305.075.0500
5/16-18X4 Inch*	50	U08305.031.0400	1/2-13X1 Inch*	50	U08305.050.0100	3/4-10X6 Inch*	10	U08305.075.0600
5/16-18X4.1/2*	50	U08305.031.0450	1/2-13X1.1/4*	50	U08305.050.0125	3/4-10X7 Inch*	5	U08305.075.0700
5/16-18X5 Inch*	50	U08305.031.0500	1/2-13X1.1/2*	50	U08305.050.0150	3/4-10X8 Inch*	5	U08305.075.0800

U08307 Carriage bolt UNC		X09A	
Thread	Unified National Coarse		
Material	Steel		
Class	Grade 2		
Surface treatment	Hot dip galvanized		

d x L	☒	Art.number	d x L	☒	Art.number	d x L	☒	Art.number
1/4-20X1 Inch*	100	U08307.025.0100	5/16-18X3 Inch*	50	U08307.031.0300	1/2-13X1.1/2*	50	U08307.050.0150
1/4-20X1.1/4*	100	U08307.025.0125	5/16-18X3.1/2*	50	U08307.031.0350	1/2-13X2 Inch*	25	U08307.050.0200
1/4-20X1.1/2*	100	U08307.025.0150	5/16-18X4 Inch*	50	U08307.031.0400	1/2-13X2.1/2*	25	U08307.050.0250
1/4-20X2 Inch*	100	U08307.025.0200	5/16-18X5 Inch*	50	U08307.031.0500	1/2-13X3 Inch*	25	U08307.050.0300
1/4-20X2.1/2*	100	U08307.025.0250				1/2-13X3.1/2*	25	U08307.050.0350
1/4-20X3 Inch*	50	U08307.025.0300	3/8-16X1 Inch*	100	U08307.037.0100	1/2-13X4 Inch*	10	U08307.050.0400
1/4-20X3.1/2*	50	U08307.025.0350	3/8-16X1.1/4*	100	U08307.037.0125	1/2-13X5 Inch*	10	U08307.050.0500
1/4-20X4 Inch*	50	U08307.025.0400	3/8-16X1.1/2*	100	U08307.037.0150	1/2-13X6 Inch*	10	U08307.050.0600
1/4-20X5 Inch*	50	U08307.025.0500	3/8-16X2 Inch*	50	U08307.037.0200			
			3/8-16X2.1/2*	50	U08307.037.0250	5/8-11X2 Inch*	10	U08307.062.0200
5/16-18X1 Inch*	100	U08307.031.0100	3/8-16X3 Inch*	25	U08307.037.0300	5/8-11X2.1/2*	10	U08307.062.0250
5/16-18X1.1/4*	100	U08307.031.0125	3/8-16X3.1/2*	25	U08307.037.0350	5/8-11X3 Inch*	10	U08307.062.0300
5/16-18X1.1/2*	100	U08307.031.0150	3/8-16X4 Inch*	25	U08307.037.0400	5/8-11X4 Inch*	10	U08307.062.0400
5/16-18X2 Inch*	100	U08307.031.0200	3/8-16X5 Inch*	10	U08307.037.0500	5/8-11X5 Inch*	10	U08307.062.0500
5/16-18X2.1/2*	100	U08307.031.0250	3/8-16X6 Inch*	10	U08307.037.0600			

U08320 Carriage bolt UNC		X09A	
Thread	Unified National Coarse		
Material	Steel		
Class	Grade 5		
Surface treatment	Zinc plated		

d x L	☒	Art.number	d x L	☒	Art.number	d x L	☒	Art.number
1/4-20X3/4*	100	U08320.025.0075	1/4-20X2.1/2*	100	U08320.025.0250	5/16-18X3/4*	100	U08320.031.0075
1/4-20X1 Inch*	100	U08320.025.0100	1/4-20X3 Inch*	50	U08320.025.0300	5/16-18X1 Inch*	100	U08320.031.0100
1/4-20X1.1/4*	100	U08320.025.0125	1/4-20X3.1/2*	50	U08320.025.0350	5/16-18X1.1/4*	100	U08320.031.0125
1/4-20X1.1/2*	100	U08320.025.0150	1/4-20X4 Inch*	50	U08320.025.0400	5/16-18X1.1/2*	100	U08320.031.0150
1/4-20X2 Inch*	100	U08320.025.0200	1/4-20X5 Inch*	50	U08320.025.0500			

U08320 Carriage bolt UNC								
d x L	☒	Art.number	d x L	☒	Art.number	d x L	☒	Art.number
5/16-18X2 Inch*	100	U08320.031.0200	3/8-16X3.1/2*	25	U08320.037.0350	1/2-13X6 Inch*	10	U08320.050.0600
5/16-18X2.1/2*	50	U08320.031.0250	3/8-16X4 Inch*	25	U08320.037.0400	5/8-11X2 Inch*	10	U08320.062.0200
5/16-18X3 Inch*	50	U08320.031.0300	3/8-16X5 Inch*	10	U08320.037.0500	5/8-11X2.1/2*	10	U08320.062.0250
5/16-18X4 Inch*	50	U08320.031.0400	3/8-16X6 Inch*	10	U08320.037.0600	5/8-11X3 Inch*	10	U08320.062.0300
5/16-18X5 Inch*	50	U08320.031.0500				5/8-11X3.1/2*	10	U08320.062.0350
3/8-16X3/4*	100	U08320.037.0075	1/2-13X1 Inch*	50	U08320.050.0100	5/8-11X4 Inch*	10	U08320.062.0400
3/8-16X1 Inch*	100	U08320.037.0100	1/2-13X1.1/4*	50	U08320.050.0125	5/8-11X5 Inch*	10	U08320.062.0500
3/8-16X1.1/4*	100	U08320.037.0125	1/2-13X1.1/2*	50	U08320.050.0150	5/8-11X6 Inch*	10	U08320.062.0600
3/8-16X1.3/4*	100	U08320.037.0150	1/2-13X1.3/4*	25	U08320.050.0175			
3/8-16X2 Inch*	50	U08320.037.0200	1/2-13X2 Inch*	25	U08320.050.0200	3/4-10X2 Inch*	10	U08320.075.0200
3/8-16X2.1/4*	50	U08320.037.0225	1/2-13X2.1/2*	25	U08320.050.0250	3/4-10X3 Inch*	10	U08320.075.0300
3/8-16X2.1/2*	50	U08320.037.0250	1/2-13X3 Inch*	25	U08320.050.0300	3/4-10X4 Inch*	10	U08320.075.0400
3/8-16X3 Inch*	25	U08320.037.0300	1/2-13X3.1/2*	10	U08320.050.0350	3/4-10X5 Inch*	10	U08320.075.0500
			1/2-13X4 Inch*	10	U08320.050.0400			
			1/2-13X5 Inch*	10	U08320.050.0500			

U51500 Carriage bolt UNC		X15A
Thread	Unified National Coarse	
Material	Stainless steel A2 (AISI 304/18-8)	

d x L	☒	Art.number	d x L	☒	Art.number	d x L	☒	Art.number
1/4-20X1/2*	100	U51500.025.0050	5/16-18X1 Inch*	100	U51500.031.0100	3/8-16X3.1/2*	25	U51500.037.0350
1/4-20X5/8*	100	U51500.025.0062	5/16-18X1.1/4*	100	U51500.031.0125	3/8-16X4 Inch*	25	U51500.037.0400
1/4-20X3/4*	100	U51500.025.0075	5/16-18X1.1/2*	100	U51500.031.0150	3/8-16X4.1/2*	10	U51500.037.0450
1/4-20X1 Inch*	100	U51500.025.0100	5/16-18X1.3/4*	100	U51500.031.0175	3/8-16X5 Inch*	10	U51500.037.0500
1/4-20X1.1/4*	100	U51500.025.0125	5/16-18X2 Inch*	100	U51500.031.0200	3/8-16X6 Inch*	10	U51500.037.0600
1/4-20X1.1/2*	100	U51500.025.0150	5/16-18X2.1/4*	100	U51500.031.0225			
1/4-20X1.3/4*	100	U51500.025.0175	5/16-18X2.1/2*	50	U51500.031.0250	1/2-13X1.1/4*	50	U51500.050.0125
1/4-20X2 Inch*	100	U51500.025.0200	5/16-18X2.1/2*	50	U51500.031.0300	1/2-13X1.1/2*	50	U51500.050.0150
1/4-20X2.1/4*	100	U51500.025.0225	5/16-18X3 Inch*	50	U51500.031.0350	1/2-13X1.3/4*	25	U51500.050.0175
1/4-20X2.1/2*	100	U51500.025.0250	5/16-18X4 Inch*	50	U51500.031.0400	1/2-13X2 Inch*	25	U51500.050.0200
1/4-20X2.3/4*	100	U51500.025.0275				1/2-13X2.1/2*	25	U51500.050.0250
1/4-20X3 Inch*	50	U51500.025.0300	3/8-16X1 Inch*	100	U51500.037.0100	1/2-13X3 Inch*	25	U51500.050.0300
1/4-20X3.1/2*	50	U51500.025.0350	3/8-16X1.1/4*	100	U51500.037.0125	1/2-13X3.1/2*	10	U51500.050.0350
1/4-20X4 Inch*	50	U51500.025.0400	3/8-16X1.1/2*	100	U51500.037.0150	1/2-13X4 Inch*	10	U51500.050.0400
1/4-20X5 Inch*	50	U51500.025.0500	3/8-16X2 Inch*	50	U51500.037.0200	1/2-13X5 Inch*	10	U51500.050.0500
			3/8-16X2.1/2*	50	U51500.037.0250	1/2-13X6 Inch*	10	U51500.050.0600
5/16-18X3/4*	100	U51500.031.0075	3/8-16X3 Inch*	25	U51500.037.0300			

1

Flat countersunk square neck bolt with short square

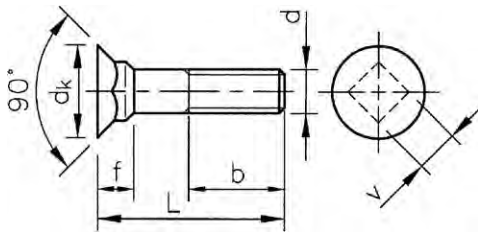

DIN ≈608
BS ≈4933

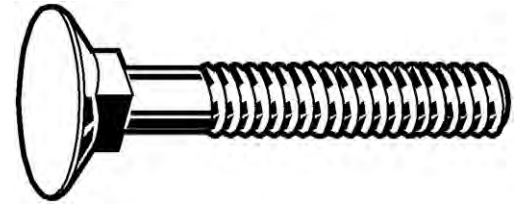

Technical Data

d	b (min.)	dk (max.)	f (max.)	P	v (max.)
M10	26	19.65	8.45	1.5	10.58
M12	30	24.65	11.05	1.75	12.7

01036 Flat countersunk square neck bolt with short square

A90A

Thread Metric thread
Material Steel
Class 8.8



d x L	☒	Art.number	d x L	☒	Art.number	d x L	☒	Art.number
M10X25	100	01036.100.025	M10X50	50	01036.100.050	M12X35	50	01036.120.035
M10X30	100	01036.100.030	M10X60	50	01036.100.060	M12X40	50	01036.120.040
M10X35	100	01036.100.035				M12X50	50	01036.120.050
M10X40	100	01036.100.040	M12X30	50	01036.120.030			

Flat countersunk wing neck bolt with hexagon nut

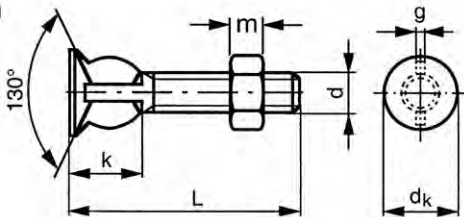

DIN - / 555 (1987)
NEN - / 697
NF - / E25-402

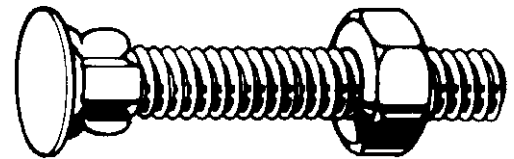

Technical Data

d	dk	g	k	m	P	s
M6	11.5	1	8	5	1	10
M8	15	1.2	11.5	6.5	1.25	13

• The corresponding hexagon nuts have a property class ≥ I4I.

08260 SEHA Flat countersunk wing neck bolt with hexagon nut

E90A

Thread Metric thread
Material Steel
Class ≥4.6
Surface treatment Zinc plated



d x L	☒	Art.number	d x L	☒	Art.number	d x L	☒	Art.number
M6X20	200	08260.060.020	M6X35	200	08260.060.035	M8X40	100	08260.080.040
M6X25	200	08260.060.025	M6X40	200	08260.060.040	M8X50	100	08260.080.050
M6X30	200	08260.060.030	M6X50	200	08260.060.050			

Flat countersunk nib bolt with hexagon nut

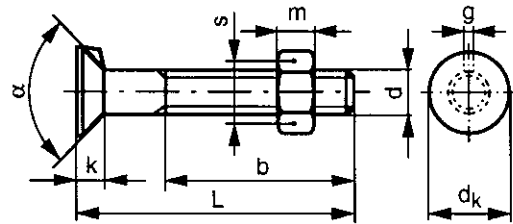

DIN 604/555 (1987)
 NEN 2355/697
 NF - / E25-402
 BS 4933/-

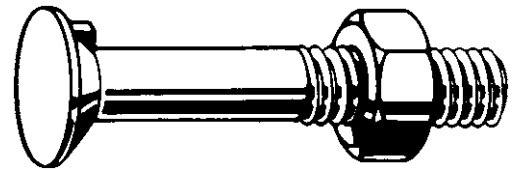

Technical Data

d	b (min.): L≤125mm	b (min.): 125mm<L≤200mm	b (min.): L>200mm	dk (max.)	g (max.)	k	m	P	s	α (min.)
M10	26	32	45	19.65	3.2	5.5	8	1.5	17	90°
M12	30	36	49	24.65	3.6	7	10	1.75	19	90°
M16	38	44	57	32.8	4.2	9	13	2	24	90°
M20	46	52	65	32.8	5.4	11.5	16	2.5	30	60°
M24	54	60	73	38.8	6.6	13	19	3	36	60°

• The corresponding hexagon nuts have a property class ≥ I4I.

08070 Flat countersunk nib bolt with hexagon nut

E01B

Thread Metric thread
 Material Steel
 Class ≥4.6

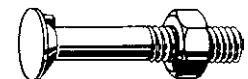

d x L	☒	Art.number	d x L	☒	Art.number	d x L	☒	Art.number
M10X25	100	08070.100.025	M12X50	100	08070.120.050	M16X140	25	08070.160.140
M10X30	100	08070.100.030	M12X60	50	08070.120.060	M20X50	25	08070.200.050
M10X35	100	08070.100.035	M12X70	50	08070.120.070	M20X60	25	08070.200.060
M10X40	100	08070.100.040	M12X80	50	08070.120.080	M20X70	25	08070.200.070
M10X45	100	08070.100.045	M12X90	50	08070.120.090	M20X80	25	08070.200.080
M10X50	100	08070.100.050	M16X35	25	08070.160.035	M20X90	25	08070.200.090
M10X55	100	08070.100.055	M16X40	25	08070.160.040	M20X100	25	08070.200.100
M10X60	100	08070.100.060	M16X45	25	08070.160.045	M20X120	25	08070.200.120
M10X70	100	08070.100.070	M16X50	25	08070.160.050	M20X130	25	08070.200.130
M10X80	50	08070.100.080	M16X55	25	08070.160.055	M24X60	25	08070.240.060
M10X90	50	08070.100.090	M16X60	25	08070.160.060	M24X80	25	08070.240.080
M12X30	100	08070.120.030	M16X60	25	08070.160.060	M24X90	25	08070.240.090
M12X35	100	08070.120.035	M16X70	25	08070.160.070	M24X100	25	08070.240.100
M12X40	100	08070.120.040	M16X80	25	08070.160.080	M24X110	25	08070.240.110
M12X45	100	08070.120.045	M16X90	25	08070.160.090			
			M16X100	25	08070.160.100			

Flat countersunk square neck bolt with long square with hexagon nut

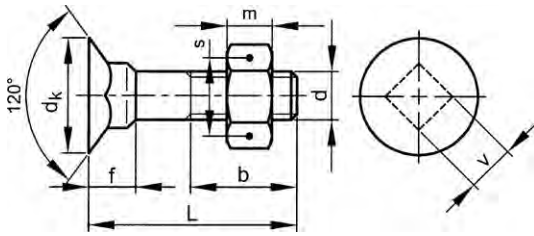

DIN 605/555 (1987)
NF - / E25-402
BS 4933/-

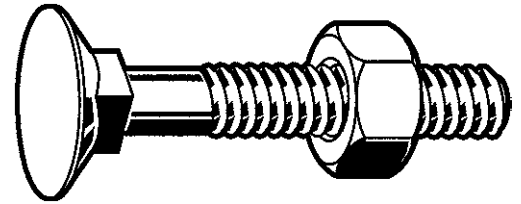

Technical Data

d	b (min.)	dk (max.)	f (max.)	m	P	s	v (max.)
M6	18	16.55	7.45	5	1	10	6.48
M8	22	20.65	9.45	6.5	1.25	13	8.58
M10	26	24.65	11.55	8	1.5	17	10.58

- The corresponding hexagon nuts have a property class \geq I4I.

08206 Flat countersunk square neck bolt with long square with hexagon nut

E03B

Thread Metric thread
Material Steel
Class 4.6
Surface treatment Zinc plated

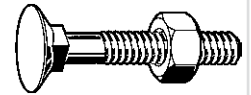

d x L	Art.number	d x L	Art.number	d x L	Art.number
M6X30	200 08206.060.030	M8X30	200 08206.080.030	M10X40	100 08206.100.040
M6X35	200 08206.060.035	M8X35	200 08206.080.035	M10X50	100 08206.100.050
M6X40	200 08206.060.040	M8X40	200 08206.080.040	M10X60	100 08206.100.060
M6X50	200 08206.060.050	M8X50	200 08206.080.050		
		M8X60	200 08206.080.060		

Seating screw

DIN 15237

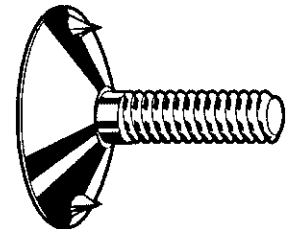
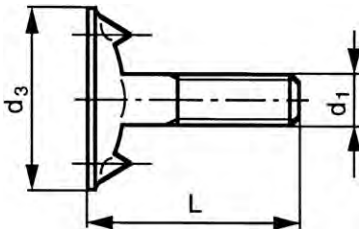

Technical Data

d ₁	d ₃	P
M8	28	1.25
M10	35	1.5

- Applicable for the attachment of conveyor belts.
- The cams under the countersunk head fasten the seating screw while the cupped washer under the belt reinforces the connection.

Article groups

Thread	Material	Code	Page
M	St.St. A2	51505	1-82
M	St.St. A4	55505	1-83

51505 Seating screw

R03A

Thread Metric thread
Material Stainless steel A2

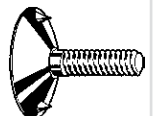

d ₁ x L	Art.number	d ₁ x L	Art.number	d ₁ x L	Art.number
M8X25	10 51505.080.025	M10X30	5 51505.100.030	M10X40	5 51505.100.040
M8X30	10 51505.080.030	M10X35	5 51505.100.035	M10X50	5 51505.100.050
M8X35	10 51505.080.035				

55505	Seating screw	R43A
Thread	Metric thread	
Material	Stainless steel A4	
		 

d₁ x L	☒	Art.number	d₁ x L	☒	Art.number	d₁ x L	☒	Art.number
M8X25	10	55505.080.025				M10X50	5	55505.100.050

Cupped washer for seating screw

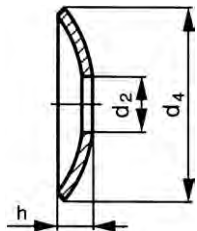

DIN 15237



Technical Data

For nom. size	d ₂	d ₄	h ≈
M8	9.5	32	5.7
M10	11.5	40	7



- Use these cupped washers together with the seating screws.
- Applicable for the attachment of conveyor belts.

Article groups

Material	Code	Page
St.St. A2	51506	1-83
St.St. A4	55506	1-83

51506	Cupped washer for seating screw	R09A
Material	Stainless steel A2	
		 

For nom. size	☒	Art.number	For nom. size	☒	Art.number
M8	10	51506.080.001	M10	5	51506.100.001

55506	Cupped washer for seating screw	R49A
Material	Stainless steel A4	
		 

For nom. size	☒	Art.number
M8	10	55506.080.001

Square head bolt with short dog point

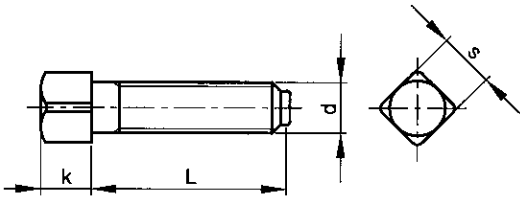

DIN 479
NF E25-134

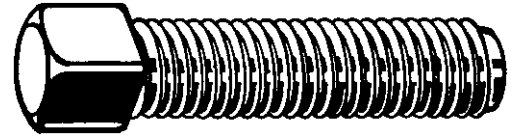

Technical Data

d	k	P	s	d	k	P	s
M6	6	1	6	M16	16	2	17
M8	8	1.25	8	M20	20	2.5	22
M10	10	1.5	10	M24	22	3	24
M12	12	1.75	13				

01030 Square head bolt with short dog point A90A

Thread Metric thread
Material Steel
Class 8.8



d x L	☒	Art.number	d x L	☒	Art.number	d x L	☒	Art.number
M6X16	200	01030.060.016	M10X40	100	01030.100.040	M16X50	50	01030.160.050
M6X20	200	01030.060.020	M10X45	100	01030.100.045	M16X60	50	01030.160.060
M6X25	200	01030.060.025	M10X50	100	01030.100.050	M16X70	50	01030.160.070
M6X30	200	01030.060.030	M10X60	100	01030.100.060	M16X80	25	01030.160.080
M6X35	200	01030.060.035	M10X70	100	01030.100.070	M16X90	25	01030.160.090
M6X40	200	01030.060.040	M10X80	50	01030.100.080	M16X100	25	01030.160.100
M6X50	200	01030.060.050	M10X100	50	01030.100.100	M16X120	25	01030.160.120
M8X16	200	01030.080.016	M12X20	200	01030.120.020	M20X50	25	01030.200.050
M8X20	200	01030.080.020	M12X25	100	01030.120.025	M20X60	25	01030.200.060
M8X25	200	01030.080.025	M12X30	100	01030.120.030	M20X70	25	01030.200.070
M8X30	200	01030.080.030	M12X35	100	01030.120.035	M20X80	25	01030.200.080
M8X35	200	01030.080.035	M12X40	100	01030.120.040	M20X90	25	01030.200.090
M8X40	200	01030.080.040	M12X50	50	01030.120.050	M20X100	25	01030.200.100
M8X50	200	01030.080.050	M12X60	50	01030.120.060	M20X120	25	01030.200.120
M8X60	100	01030.080.060	M12X70	50	01030.120.070			
M10X16	200	01030.100.016	M12X80	50	01030.120.080	M24X70	25	01030.240.070
M10X20	200	01030.100.020	M12X90	50	01030.120.090	M24X80	25	01030.240.080
M10X25	200	01030.100.025	M12X100	50	01030.120.100	M24X90	10	01030.240.090
M10X30	200	01030.100.030	M16X40	50	01030.160.040	M24X100	10	01030.240.100
M10X35	200	01030.100.035	M16X45	50	01030.160.045	M24X120	10	01030.240.120
						M24X140	50	01030.240.140

Square head bolt low UNC

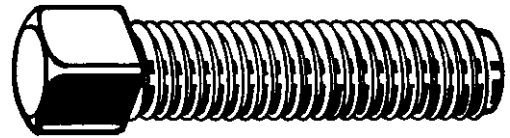
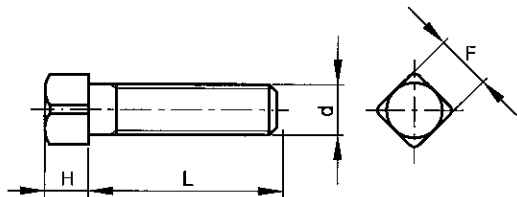

Technical Data

d	F (max.)	H (max.)	Threads per inch
1/4	0.250	0.196	20
5/16	0.312	0.245	18
3/8	0.375	0.293	16
7/16	0.438	0.341	14
1/2	0.500	0.389	13
5/8	0.625	0.485	11
3/4	0.750	0.582	10
7/8	0.875	0.678	9
1 Inch	1.000	0.774	8

U01080 Square head bolt low UNC

X09A

Thread Unified National Coarse
Material Steel

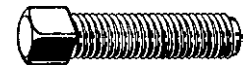

d x L	☒	Art.number	d x L	☒	Art.number	d x L	☒	Art.number
1/4-20X3/8*	100	U01080.025.0037	3/8-16X2.1/2*	25	U01080.037.0250	5/8-11X2.1/2*	10	U01080.062.0250
1/4-20X1/2*	100	U01080.025.0050	3/8-16X3 Inch*	10	U01080.037.0300	5/8-11X3 Inch*	5	U01080.062.0300
1/4-20X5/8*	100	U01080.025.0062	3/8-16X3.1/2*	10	U01080.037.0350	5/8-11X3.1/2*	5	U01080.062.0350
1/4-20X3/4*	100	U01080.025.0075	3/8-16X4 Inch*	10	U01080.037.0400	5/8-11X4 Inch*	5	U01080.062.0400
1/4-20X7/8*	100	U01080.025.0087				5/8-11X5 Inch*	5	U01080.062.0500
1/4-20X1 Inch*	100	U01080.025.0100	7/16-14X3/4*	50	U01080.043.0075	5/8-11X6 Inch*	5	U01080.062.0600
1/4-20X1.1/4*	100	U01080.025.0125	7/16-14X1 Inch*	50	U01080.043.0100			
1/4-20X1.1/2*	100	U01080.025.0150	7/16-14X1.1/4*	25	U01080.043.0125	3/4-10X1 Inch*	5	U01080.075.0100
1/4-20X1.3/4*	100	U01080.025.0175	7/16-14X1.1/2*	25	U01080.043.0150	3/4-10X1.1/4*	5	U01080.075.0125
1/4-20X2 Inch*	100	U01080.025.0200	7/16-14X2 Inch*	25	U01080.043.0200	3/4-10X1.1/2*	5	U01080.075.0150
1/4-20X2.1/2*	50	U01080.025.0250				3/4-10X2 Inch*	5	U01080.075.0200
			1/2-13X3/4*	25	U01080.050.0075	3/4-10X2.1/2*	5	U01080.075.0250
5/16-18X1/2*	100	U01080.031.0050	1/2-13X7/8*	25	U01080.050.0087	3/4-10X3 Inch*	5	U01080.075.0300
5/16-18X5/8*	100	U01080.031.0062	1/2-13X1 Inch*	25	U01080.050.0100	3/4-10X3.1/2*	5	U01080.075.0350
5/16-18X3/4*	100	U01080.031.0075	1/2-13X1.1/4*	25	U01080.050.0125	3/4-10X4 Inch*	5	U01080.075.0400
5/16-18X1 Inch*	100	U01080.031.0100	1/2-13X1.1/2*	25	U01080.050.0150	3/4-10X5 Inch*	5	U01080.075.0500
5/16-18X1.1/4*	100	U01080.031.0125	1/2-13X1.3/4*	25	U01080.050.0175	3/4-10X6 Inch*	5	U01080.075.0600
5/16-18X1.1/2*	100	U01080.031.0150	1/2-13X2 Inch*	10	U01080.050.0200			
5/16-18X1.3/4*	100	U01080.031.0175	1/2-13X2.1/2*	10	U01080.050.0250	7/8-9X2 Inch*	5	U01080.087.0200
5/16-18X2 Inch*	100	U01080.031.0200	1/2-13X3 Inch*	10	U01080.050.0300	7/8-9X3 Inch*	5	U01080.087.0300
5/16-18X2.1/2*	50	U01080.031.0250	1/2-13X3.1/2*	10	U01080.050.0350	7/8-9X4 Inch*	5	U01080.087.0400
			1/2-13X4 Inch*	10	U01080.050.0400	7/8-9X5 Inch*	5	U01080.087.0500
3/8-16X1/2*	100	U01080.037.0050	1/2-13X5 Inch*	5	U01080.050.0500	7/8-9X6 Inch*	5	U01080.087.0600
3/8-16X5/8*	100	U01080.037.0062	1/2-13X6 Inch*	5	U01080.050.0600			
3/8-16X3/4*	100	U01080.037.0075				1.-8X2.1/2*	1	U01080.100.0250
3/8-16X1 Inch*	100	U01080.037.0100	5/8-11X1 Inch*	10	U01080.062.0100	1.-8X3 Inch*	1	U01080.100.0300
3/8-16X1.1/4*	100	U01080.037.0125	5/8-11X1.1/4*	10	U01080.062.0125	1.-8X4 Inch*	1	U01080.100.0400
3/8-16X1.1/2*	50	U01080.037.0150	5/8-11X1.1/2*	10	U01080.062.0150	1.-8X5 Inch*	1	U01080.100.0500
3/8-16X1.3/4*	50	U01080.037.0175	5/8-11X1.3/4*	10	U01080.062.0175	1.-8X6 Inch*	1	U01080.100.0600
3/8-16X2 Inch*	25	U01080.037.0200	5/8-11X2 Inch*	10	U01080.062.0200			

1

Hexagon head set screw with small hexagon and dog point

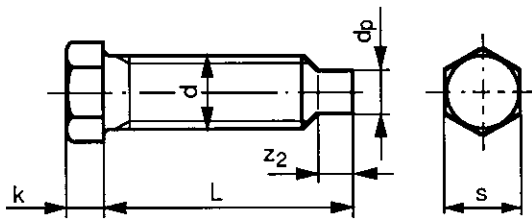

DIN 561
NF E25-133

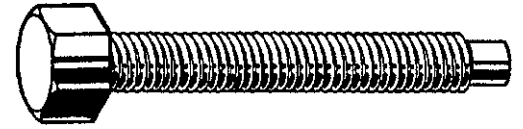

Technical Data

d	d _p (max.)	k	P	s	z ₂ (min.)
M6	4	5	1	8	3
M8	5.5	6	1.25	10	4
M10	7	7	1.5	13	5
M12	8.5	9	1.75	16	6
M16	12	11	2	18	8

01098 Hexagon head set screw with small hexagon and dog point

A90A

Thread Metric thread
Material Steel
Class 8.8



d x L	☒	Art.number	d x L	☒	Art.number	d x L	☒	Art.number
M6X12	200	01098.060.012	M10X20	200	01098.100.020	M12X30	100	01098.120.030
M6X16	200	01098.060.016	M10X25	200	01098.100.025	M12X35	100	01098.120.035
M6X20	200	01098.060.020	M10X30	200	01098.100.030	M12X40	100	01098.120.040
M8X16	200	01098.080.016	M10X35	100	01098.100.035	M12X50	100	01098.120.050
M8X20	200	01098.080.020	M10X40	100	01098.100.040	M12X60	100	01098.120.060
M8X25	200	01098.080.025	M10X50	100	01098.100.050	M16X50	50	01098.160.050
M8X30	200	01098.080.030	M10X60	100	01098.100.060	M16X60	50	01098.160.060
M8X35	200	01098.080.035	M12X25	100	01098.120.025	M16X70	25	01098.160.070
M8X40	200	01098.080.040				M16X80	25	01098.160.080
M8X50	100	01098.080.050						

Trackshoe bolt type caterpillar

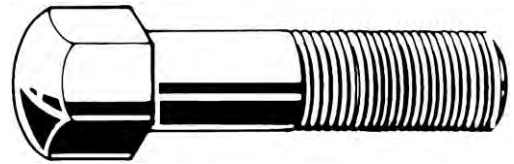
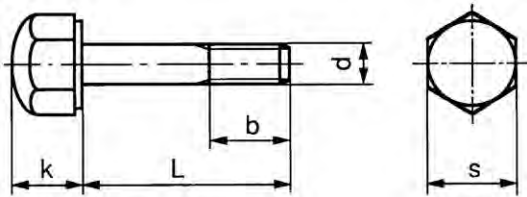

Technical Data

d	k	s	Threads per inch	d	k	s	Threads per inch
7/16	11	16	20	5/8	16	24	18
1/2	13	19	20	3/4	19	28	16
9/16	14	22	18	1 Inch-14G	24	38.1	14

- For corresponding Trackshoe nuts see Section 3.

06000 Trackshoe bolt type caterpillar		Y90A
Thread	Unified National Fine	
Material	Steel	
Class	170	



d x L x b	☒	Art.number	d x L x b	☒	Art.number	d x L x b	☒	Art.number
7/16X1.1/2X22MM	50	06000.111.038	9/16X1.15/16X28MM	50	06000.142.049	3/4X2.3/8X30MM	10	06000.191.060
1/2X1.1/2X19MM	50	06000.127.038	5/8X2 InchX28MM	25	06000.158.050	3/4X2.1/2X30MM	10	06000.191.063
1/2X2 InchX24MM	50	06000.127.050	5/8X2.1/4X27MM	25	06000.158.057	3/4X2.3/4X38MM	10	06000.191.069
9/16X1.5/8X26MM	50	06000.142.041	3/4X2.1/4X29MM	10	06000.191.057	1-14GX3 InchX35MM	10	06000.256.076

- 170 = minimum tensile strength 170.000 psi = 1200 N/mm².

1 PEINER High strength structural bolts

General

From September 2007, manufacturers of high strength structural bolts, nuts and washers should produce their products in accordance with the European standard **EN 14399**. Products made based on the old standards DIN 6914, 6915 and 6916 (old 'DIN stocks') can still be used and supplied, but cannot be combined in various assemblies (see 'Assembly') with products that meet the new standard!

The revised standard does not lead to any important dimensional changes (with the exception of the thread length size "b", which now has the maximum value from the old standard and, starting at M24 even somewhat above that). Furthermore, CE marking on the packaging is obliged and the products demand more stringent assembly instructions and traceability. In addition, the impact value has changed from $K_{V,min}=20J$ to $K_{V,min}=27J$ at $-20^{\circ}C$. PEINER 10.9 HV high strength structural bolts, nuts and washers that are included in this catalogue meet the new standards.

Product	Old	New	Marking
HV bolts	DIN 6914	→ EN 14399-4	10.9 HV
HV nuts	DIN 6915	→ EN 14399-4	10 HV
HV washers	DIN 6916	→ EN 14399-6	H

Quality

PEINER is a CE-certified supplier of class 10.9 HV bolts, class 10 HV nuts and washers (hardness 300-370 HV) in the sizes M12-M36 in accordance with standard EN 14399-4 resp. EN 14399-6. These articles are available in both a black and a hot-dip galvanised version. The bolts meet all of the requirements that are set to prevent hydrogen embrittlement.

Assembly

The standard prescribes that the bolt, nut and washer must come from the same manufacturer. Standard EN 14399-2 describes the test method that the bolt/nut/washer combination should fulfill. Due to the more stringent assembly instructions and a classification in k-classes, the manufacturer should ensure that the required preloading force can be achieved in a reliable manner and that overloading is avoided, with reference being made to the assembly methods in standard EN 1090-2.

For hot-dip galvanised combinations, in the friction class K1, the same tightening torque and preloading forces apply as stated in DIN 18800-7 (2002-09) Table 6, columns 3 and 7, resp. EN 1993-1-8. For hot-dip

galvanised products from the same manufacturer, the various separate elements (in accordance with DIN and EN) can be combined. This is because the values for the tightening torque remain the same!

For the non hot-dip galvanised combinations, according to the new EN standard, the same tightening torques apply as for the hot-dip galvanised combinations, there where DIN 18800-7 (2002-09) Table 6, columns 4 and 8, previously prescribed raised tightening torques. Due to this difference in tightening torque, combining DIN-products with EN-products is **not** allowed.

Peiner high strength structural bolts that meet the new EN standard are supplied in friction class K1. The k-factor describes the linear relationship between the tightening torque (M) and the preloading force achieved for the diameter concerned.

Expressed using the formula: $M = k \times F_v \times d$ (M [Nm], F_v [kN], d [mm])

PEINER preloading products (EN14399-4 and 6) should meet k-class **K1** where $0.1 \leq k \leq 0.16$, irrespective of the surface treatment.

The product packaging mentions assembly guidelines and the friction class. The surface treatment applied by the manufacturer ensures that these conditions are achieved! Additional lubrication or degreasing influences the k-value and is not allowed. With respect to the clamping length of a bolt-nut-washer combination, it must be noted that in the new standard the thickness of the washers is included.

Certificates

PEINER high strength structural bolts are, on request, available with a 3.1 certificate in accordance with EN 10204.



High-strength structural bolt

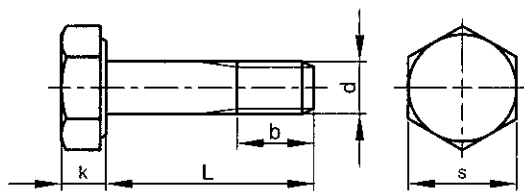

EN 14399-4

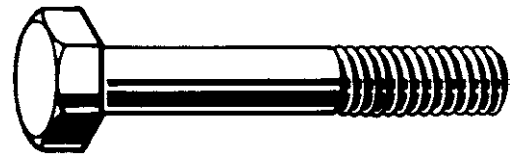

Technical Data

d	b	k	P	s
M12	23	8	1.75	22
M16	28	10	2	27
M20	33	13	2.5	32
M22	34	14	2.5	36
M24	39	15	3	41
M27	41	17	3	46
M30	44	19	3.5	50
M36	52	23	4	60
M39	68	25	4	65
M42	74	26	4.5	70
M45	76	28	4.5	75
M48	82	30	5	80
M56	90	35	5.5	90
M64	100	40	6	100

- PEINER HV-bolts and corresponding HV-nuts and HV-washers, sizes M12 up to M36 are specified in EN 14399-4 and EN 14399-6. Diameters M39 up to M72 are defined in DAST directive 021.
- PEINER HV-bolts with associated HV-nuts and HV-rings may be used only as a set from one and the same supplier.

04210 PEINER High-strength structural bolt

C05A

Thread Metric thread
Material Steel
Class 10.9
Surface treatment Hot dip galvanized

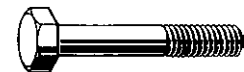
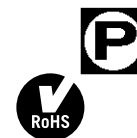

CE

d x L	☒	Art.number	d x L	☒	Art.number	d x L	☒	Art.number
M12X30	100	04210.120.030	M16X150	25	04210.160.150	M20X230	15	04210.200.230
M12X35	100	04210.120.035	M16X160	25	04210.160.160	M20X240	15	04210.200.240
M12X40	100	04210.120.040	M16X170	25	04210.160.170	M20X250	15	04210.200.250
M12X45	100	04210.120.045	M16X180	25	04210.160.180	M20X260	15	04210.200.260
M12X50	100	04210.120.050	M16X190	25	04210.160.190			
M12X55	100	04210.120.055	M16X200	25	04210.160.200	M22X50	25	04210.220.050
M12X60	50	04210.120.060	M16X210	25	04210.160.210	M22X55	25	04210.220.055
M12X65	50	04210.120.065	M16X220	25	04210.160.220	M22X60	25	04210.220.060
M12X70	50	04210.120.070				M22X65	25	04210.220.065
M12X75	50	04210.120.075	M20X40	25	04210.200.040	M22X70	25	04210.220.070
M12X80	50	04210.120.080	M20X45	25	04210.200.045	M22X75	25	04210.220.075
M12X85	50	04210.120.085	M20X50	25	04210.200.050	M22X80	25	04210.220.080
M12X90	50	04210.120.090	M20X55	25	04210.200.055	M22X85	25	04210.220.085
M12X95	50	04210.120.095	M20X60	25	04210.200.060	M22X90	25	04210.220.090
M12X100	50	04210.120.100	M20X65	25	04210.200.065	M22X95	25	04210.220.095
M12X110	50	04210.120.110	M20X70	25	04210.200.070	M22X100	25	04210.220.100
M12X120	50	04210.120.120	M20X75	25	04210.200.075	M22X110	25	04210.220.110
			M20X80	25	04210.200.080	M22X120	25	04210.220.120
M16X35	50	04210.160.035	M20X85	25	04210.200.085	M22X130	25	04210.220.130
M16X40	50	04210.160.040	M20X90	25	04210.200.090	M22X140	20	04210.220.140
M16X45	50	04210.160.045	M20X95	25	04210.200.095	M22X150	15	04210.220.150
M16X50	50	04210.160.050	M20X100	25	04210.200.100	M22X160	15	04210.220.160
M16X55	50	04210.160.055	M20X105	25	04210.200.105	M22X170	15	04210.220.170
M16X60	50	04210.160.060	M20X110	25	04210.200.110	M22X180	15	04210.220.180
M16X65	50	04210.160.065	M20X115	25	04210.200.115	M22X190	15	04210.220.190
M16X70	50	04210.160.070	M20X120	25	04210.200.120	M22X200	15	04210.220.200
M16X75	50	04210.160.075	M20X125	25	04210.200.125			
M16X80	25	04210.160.080	M20X130	25	04210.200.130	M24X50	25	04210.240.050
M16X85	25	04210.160.085	M20X140	25	04210.200.140	M24X55	25	04210.240.055
M16X90	25	04210.160.090	M20X150	25	04210.200.150	M24X60	25	04210.240.060
M16X95	25	04210.160.095	M20X160	20	04210.200.160	M24X65	25	04210.240.065
M16X100	25	04210.160.100	M20X170	20	04210.200.170	M24X70	25	04210.240.070
M16X110	25	04210.160.110	M20X180	15	04210.200.180	M24X75	25	04210.240.075
M16X115	25	04210.160.115	M20X190	15	04210.200.190	M24X80	25	04210.240.080
M16X120	25	04210.160.120	M20X200	15	04210.200.200	M24X85	25	04210.240.085
M16X130	25	04210.160.130	M20X210	15	04210.200.210	M24X90	25	04210.240.090
M16X140	25	04210.160.140	M20X220	15	04210.200.220	M24X95	25	04210.240.095

04210 PEINER High-strength structural bolt								
d x L	☒	Art.number	d x L	☒	Art.number	d x L	☒	Art.number
M24X100	25	04210.240.100	M27X260	10	04210.270.260	M30X500	1	04210.300.500
M24X105	25	04210.240.105						
M24X110	25	04210.240.110	M30X70	10	04210.300.070	M36X80	5	04210.360.080
M24X115	25	04210.240.115	M30X75	10	04210.300.075	M36X85	5	04210.360.085
M24X120	20	04210.240.120	M30X80	10	04210.300.080	M36X90	5	04210.360.090
M24X125	20	04210.240.125	M30X85	10	04210.300.085	M36X95	5	04210.360.095
M24X130	20	04210.240.130	M30X90	10	04210.300.090	M36X100	5	04210.360.100
M24X135	20	04210.240.135	M30X95	10	04210.300.095	M36X110	5	04210.360.110
M24X140	20	04210.240.140	M30X100	10	04210.300.100	M36X115	5	04210.360.115
M24X150	15	04210.240.150	M30X110	10	04210.300.110	M36X120	5	04210.360.120
M24X160	15	04210.240.160	M30X115	10	04210.300.115	M36X130	5	04210.360.130
M24X170	10	04210.240.170	M30X120	10	04210.300.120	M36X140	5	04210.360.140
M24X180	10	04210.240.180	M30X130	10	04210.300.130	M36X150	5	04210.360.150
M24X190	10	04210.240.190	M30X140	10	04210.300.140	M36X160	5	04210.360.160
M24X200	10	04210.240.200	M30X150	10	04210.300.150	M36X170	5	04210.360.170
M24X210	10	04210.240.210	M30X160	10	04210.300.160	M36X180	5	04210.360.180
M24X220	10	04210.240.220	M30X165	10	04210.300.165	M36X190	5	04210.360.190
M24X230	10	04210.240.230	M30X170	10	04210.300.170	M36X200	5	04210.360.200
M24X240	10	04210.240.240	M30X180	5	04210.300.180	M36X210	5	04210.360.210
M24X250	10	04210.240.250	M30X190	5	04210.300.190	M36X220	5	04210.360.220
M24X260	10	04210.240.260	M30X200	5	04210.300.200	M36X230	5	04210.360.230
			M30X210	5	04210.300.210	M36X240	5	04210.360.240
M27X60	10	04210.270.060	M30X220	5	04210.300.220	M36X250	5	04210.360.250
M27X65	10	04210.270.065	M30X230	5	04210.300.230	M36X260	5	04210.360.260
M27X70	10	04210.270.070	M30X240	5	04210.300.240	M36X270	1	04210.360.270
M27X75	10	04210.270.075	M30X250	5	04210.300.250	M36X280	1	04210.360.280
M27X80	10	04210.270.080	M30X260	5	04210.300.260	M36X290	1	04210.360.290
M27X85	10	04210.270.085	M30X270	1	04210.300.270	M36X300	1	04210.360.300
M27X90	10	04210.270.090	M30X280	1	04210.300.280	M36X310	1	04210.360.310
M27X95	10	04210.270.095	M30X290	1	04210.300.290	M36X320	1	04210.360.320
M27X100	10	04210.270.100	M30X300	1	04210.300.300	M36X330	1	04210.360.330
M27X105	10	04210.270.105	M30X310	1	04210.300.310	M36X340	1	04210.360.340
M27X110	10	04210.270.110	M30X320	1	04210.300.320	M36X350	1	04210.360.350
M27X115	10	04210.270.115	M30X330	1	04210.300.330	M36X360	1	04210.360.360
M27X120	10	04210.270.120	M30X340	1	04210.300.340	M36X370	1	04210.360.370
M27X125	10	04210.270.125	M30X350	1	04210.300.350	M36X380	1	04210.360.380
M27X130	10	04210.270.130	M30X360	1	04210.300.360	M36X390	1	04210.360.390
M27X140	10	04210.270.140	M30X370	1	04210.300.370	M36X400	1	04210.360.400
M27X150	10	04210.270.150	M30X380	1	04210.300.380	M36X410	1	04210.360.410
M27X160	10	04210.270.160	M30X390	1	04210.300.390	M36X420	1	04210.360.420
M27X165	10	04210.270.165	M30X400	1	04210.300.400	M36X430	1	04210.360.430
M27X170	10	04210.270.170	M30X410	1	04210.300.410	M36X440	1	04210.360.440
M27X180	10	04210.270.180	M30X420	1	04210.300.420	M36X450	1	04210.360.450
M27X190	10	04210.270.190	M30X430	1	04210.300.430	M36X460	1	04210.360.460
M27X200	10	04210.270.200	M30X440	1	04210.300.440	M36X470	1	04210.360.470
M27X210	10	04210.270.210	M30X450	1	04210.300.450	M36X480	1	04210.360.480
M27X220	10	04210.270.220	M30X460	1	04210.300.460	M36X490	1	04210.360.490
M27X230	10	04210.270.230	M30X470	1	04210.300.470	M36X500	1	04210.360.500
M27X240	10	04210.270.240	M30X480	1	04210.300.480			
M27X250	10	04210.270.250	M30X490	1	04210.300.490			

High-strength structural nut

EN 14399-4

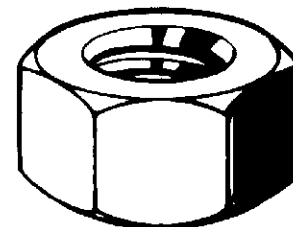
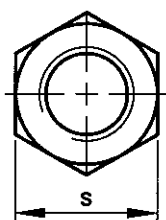
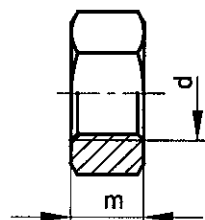

Technical Data

d	m	P	s	d	m	P	s
M12	10	1.75	22	M36	29	4	60
M16	13	2	27	M39	31	4	65
M20	16	2.5	32	M42	34	4.5	70
M22	18	2.5	36	M45	36	4.5	75
M24	20	3	41	M48	38	5	80
M27	22	3	46	M56	45	5.5	90
M30	24	3.5	50	M64	51	6	100

Article groups

Thread	Driving features	Material	Class	Surface treatment	Code	Page
M	Hexagon	St	10		04025	1-91
M	Hexagon	St	10	Hot d.g.	04225	1-91

04025 PEINER High-strength structural nut

C05A

Thread Metric thread
Material Steel
Class 10

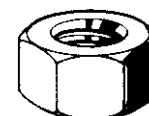
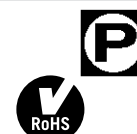

CE

d	☒	Art.number	d	☒	Art.number	d	☒	Art.number
M12	200	04025.120.001	M22	50	04025.220.001	M30	50	04025.300.001
M16	100	04025.160.001	M24	50	04025.240.001	M36	25	04025.360.001
M20	100	04025.200.001	M27	50	04025.270.001			

04225 PEINER High-strength structural nut

C05A

Thread Metric thread
Material Steel
Class 10
Surface treatment Hot dip galvanized

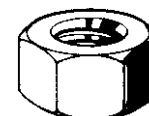
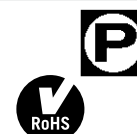

CE

d	☒	Art.number	d	☒	Art.number	d	☒	Art.number
M12	200	04225.120.001	M27	50	04225.270.001	M45	1	04225.450.001
M16	100	04225.160.001	M30	50	04225.300.001	M48	1	04225.480.001
M20	100	04225.200.001	M36	25	04225.360.001	M56	1	04225.560.001
M22	50	04225.220.001	M39	1	04225.390.001	M64	1	04225.640.001
M24	50	04225.240.001	M42	1	04225.420.001			

- Hot dip galvanized high-strength structural nuts acc. EN 14399-4 are supplied lubricated.

High-strength structural washer

EN 14399-6

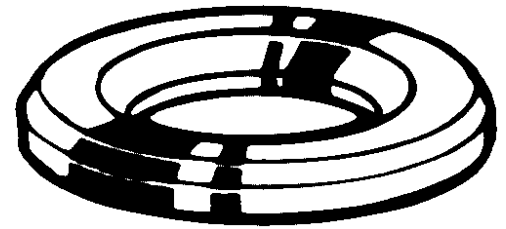
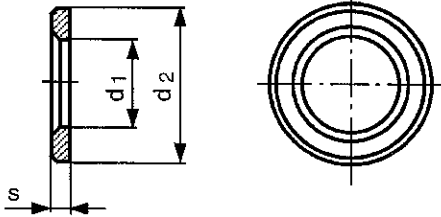

Technical Data

For nom.size	d ₁	d ₂	s	For nom.size	d ₁	d ₂	s
M12	13	24	3	M36	37	66	6
M16	17	30	4	M39	41	72	6
M20	21	37	4	M42	44	78	8
M22	23	39	4	M45	47	85	8
M24	25	44	4	M48	50	92	8
M27	28	50	5	M56	58	105	10
M30	31	56	5	M64	66	115	10

Article groups

Material	Surface treatment	Code	Page
St 300-370 HV10		04035	1-92
St 300-370 HV10	Hot d.g.	04237	1-92

04035 PEINER High-strength structural washer C05A

Material Steel 300-370 HV10



For nom. size	☒	Art.number	For nom. size	☒	Art.number	For nom. size	☒	Art.number
M12	400	04035.120.001	M22	200	04035.220.001	M30	100	04035.300.001
M16	200	04035.160.001	M24	200	04035.240.001	M36	50	04035.360.001
M20	200	04035.200.001	M27	100	04035.270.001			

04237 PEINER High-strength structural washer C05A

Material Steel 300-370 HV10
Surface treatment Hot dip galvanized



For nom. size	☒	Art.number	For nom. size	☒	Art.number	For nom. size	☒	Art.number
M12	400	04237.120.001	M27	100	04237.270.001	M45	1	04237.450.001
M16	200	04237.160.001	M30	100	04237.300.001	M48	1	04237.480.001
M20	200	04237.200.001	M36	50	04237.360.001	M56	1	04237.560.001
M22	200	04237.220.001	M39	1	04237.390.001	M64	1	04237.640.001
M24	200	04237.240.001	M42	1	04237.420.001			

Square taper washer 14% for I-sections

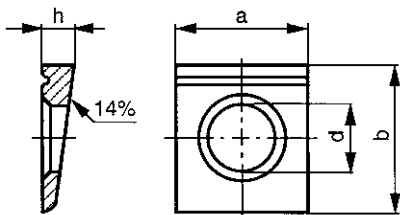

DIN 6917
NEN 5515

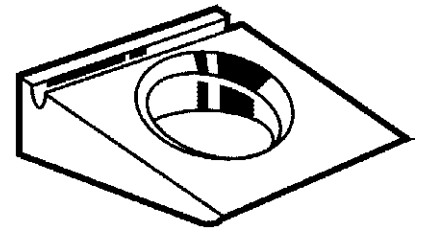

Technical Data

For nom. size	a	b	d	h
M12	26	30	13	6.2
M16	32	36	17	7.5
M20	40	44	21	9.2
M22	44	50	23	10
M24	56	56	25	10.8
M27	56	56	28	10.8
M30	62	62	31	11.7
M36	68	68	37	12.5

04240 PEINER Square taper washer 14% for I-sections

C05A

Material Steel 295-350 HV10
Surface treatment Hot dip galvanized

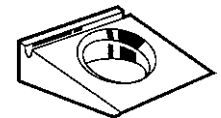

For nom. size	☒	Art.number	For nom. size	☒	Art.number	For nom. size	☒	Art.number
M12	200	04240.120.001	M22	50	04240.220.001	M30	50	04240.300.001
M16	100	04240.160.001	M24	50	04240.240.001	M36	50	04240.360.001
M20	100	04240.200.001	M27	50	04240.270.001			

Square taper washer 8% for U-section

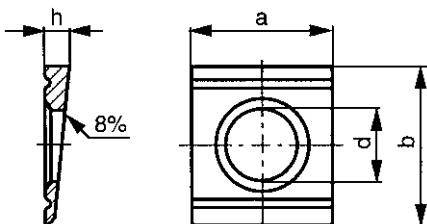

DIN 6918
NEN 5514

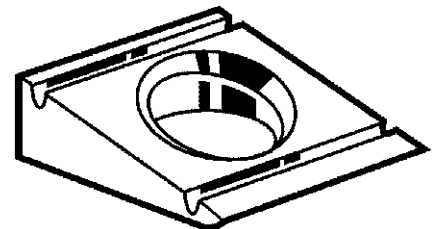

Technical Data

For nom. size	a	b	d	h
M12	26	30	13	4.9
M16	32	36	17	5.9
M20	40	44	21	7
M22	44	50	23	8
M24	56	56	25	8.5
M27	56	56	28	8.5
M30	62	62	31	9
M36	68	68	37	9.4

04250 PEINER Square taper washer 8% for U-section

C05A

Material Steel 295-350 HV10
Surface treatment Hot dip galvanized

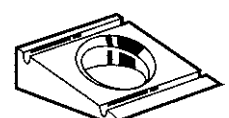

For nom. size	☒	Art.number	For nom. size	☒	Art.number	For nom. size	☒	Art.number
M12	200	04250.120.001	M22	50	04250.220.001	M30	50	04250.300.001
M16	100	04250.160.001	M24	50	04250.240.001	M36	50	04250.360.001
M20	100	04250.200.001	M27	50	04250.270.001			

1 Structural assembly set

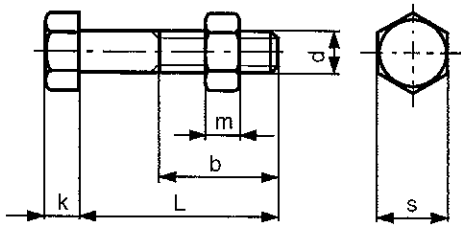

EN 15048
ISO 4014/4032

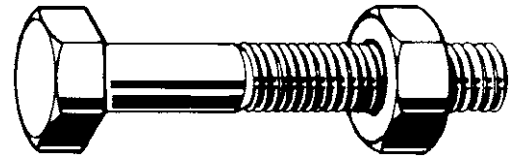

Technical Data

d	b (min.): L≤125mm	b (min.): 125mm<L≤200mm	b (min.): L>200mm	k	m (max.)	P	s
M10	26	32	45	6.4	8.4	1.5	16
M12	30	36	49	7.5	10.8	1.75	18
M16	38	44	57	10	14.8	2	24
M20	46	52	65	12.5	18	2.5	30
M24	54	60	73	15	21.5	3	36
M27	60	66	79	17	23.8	3	41
M30	66	72	85	18.7	25.6	3.5	46
M33	72	78	91	21	28.7	3.5	50
M36	78	84	97	22.5	31	4	55

• Full boxes only.

Article groups

Thread	Driving features	Material	Class	Surface treatment	Code	Page
M	Hexagon	St	8.8	Zipl	01222	1-94
M	Hexagon	St	8.8	Hot d.g.	ISO metric	01405

01222 Structural assembly set

A96A

Thread Metric thread
Material Steel
Class 8.8
Surface treatment Zinc plated



CE



d x L	☒	Art.number	d x L	☒	Art.number	d x L	☒	Art.number
M12X50/S=18	100	01222.120.050	M16X120	25	01222.160.120	M20X280	10	01222.200.280
M12X55/S=18	100	01222.120.055	M16X130	25	01222.160.130	M20X300	10	01222.200.300
M12X60/S=18	100	01222.120.060	M16X140	25	01222.160.140	M20X320	10	01222.200.320
M12X70/S=18	75	01222.120.070	M16X150	25	01222.160.150	M20X340	10	01222.200.340
M12X75/S=18	50	01222.120.075	M16X160	25	01222.160.160	M20X360	10	01222.200.360
M12X80/S=18	50	01222.120.080	M16X170	25	01222.160.170			
M12X85/S=18	50	01222.120.085	M16X180	25	01222.160.180	M24X80	25	01222.240.080
M12X90/S=18	50	01222.120.090	M16X190	25	01222.160.190	M24X85	10	01222.240.085
M12X100/S=18	50	01222.120.100	M16X200	25	01222.160.200	M24X90	10	01222.240.090
M12X110/S=18	50	01222.120.110	M16X220	25	01222.160.220	M24X100	10	01222.240.100
M12X120/S=18	50	01222.120.120	M16X240	10	01222.160.240	M24X110	10	01222.240.110
M12X130/S=18	50	01222.120.130	M16X250	10	01222.160.250	M24X120	10	01222.240.120
M12X140/S=18	50	01222.120.140	M16X260	10	01222.160.260	M24X130	10	01222.240.130
M12X150/S=18	50	01222.120.150	M16X280	10	01222.160.280	M24X140	10	01222.240.140
M12X160/S=18	25	01222.120.160	M16X300	10	01222.160.300	M24X150	25	01222.240.150
M12X170/S=18	25	01222.120.170				M24X160	10	01222.240.160
M12X180/S=18	25	01222.120.180	M20X65	25	01222.200.065	M24X170	10	01222.240.170
M12X190/S=18	25	01222.120.190	M20X70	25	01222.200.070	M24X180	10	01222.240.180
M12X200/S=18	25	01222.120.200	M20X75	25	01222.200.075	M24X200	10	01222.240.200
M12X220/S=18	25	01222.120.220	M20X80	25	01222.200.080	M24X220	10	01222.240.220
M12X240/S=18	25	01222.120.240	M20X85	25	01222.200.085	M24X240	10	01222.240.240
M12X250/S=18	25	01222.120.250	M20X90	20	01222.200.090	M24X260	10	01222.240.260
M12X260/S=18	25	01222.120.260	M20X100	20	01222.200.100	M24X280	10	01222.240.280
M12X280/S=18	25	01222.120.280	M20X110	20	01222.200.110	M24X300	10	01222.240.300
M12X300/S=18	25	01222.120.300	M20X120	20	01222.200.120	M24X320	5	01222.240.320
			M20X130	20	01222.200.130	M24X340	5	01222.240.340
M16X55	50	01222.160.055	M20X140	10	01222.200.140	M24X360	5	01222.240.360
M16X60	50	01222.160.060	M20X150	10	01222.200.150			
M16X65	25	01222.160.065	M20X160	10	01222.200.160	M27X80	5	01222.270.080
M16X70	25	01222.160.070	M20X170	10	01222.200.170	M27X90	10	01222.270.090
M16X75	25	01222.160.075	M20X180	10	01222.200.180	M27X100	10	01222.270.100
M16X80	25	01222.160.080	M20X190	10	01222.200.190	M27X110	10	01222.270.110
M16X85	25	01222.160.085	M20X200	10	01222.200.200	M27X120	10	01222.270.120
M16X90	25	01222.160.090	M20X220	10	01222.200.220	M27X130	10	01222.270.130
M16X95	25	01222.160.095	M20X240	10	01222.200.240	M27X140	10	01222.270.140
M16X100	25	01222.160.100	M20X250	10	01222.200.250	M27X150	10	01222.270.150
M16X110	25	01222.160.110	M20X260	10	01222.200.260	M27X160	10	01222.270.160

01222 Structural assembly set								
d x L	☒	Art.number	d x L	☒	Art.number	d x L	☒	Art.number
M27X180	5	01222.270.180	M30X240	5	01222.300.240	M36X120	5	01222.360.120
M27X200	5	01222.270.200	M30X260	5	01222.300.260	M36X130	5	01222.360.130
			M30X280	5	01222.300.280	M36X140	5	01222.360.140
M30X90	10	01222.300.090	M30X300	5	01222.300.300	M36X150	5	01222.360.150
M30X100	10	01222.300.100				M36X160	5	01222.360.160
M30X110	10	01222.300.110	M33X100	5	01222.330.100	M36X180	2	01222.360.180
M30X120	10	01222.300.120	M33X110	5	01222.330.110	M36X200	2	01222.360.200
M30X130	10	01222.300.130	M33X120	5	01222.330.120	M36X220	2	01222.360.220
M30X140	10	01222.300.140	M33X130	5	01222.330.130	M36X240	2	01222.360.240
M30X150	10	01222.300.150	M33X140	5	01222.330.140	M36X260	2	01222.360.260
M30X160	10	01222.300.160	M33X150	5	01222.330.150	M36X280	2	01222.360.280
M30X170	5	01222.300.170	M33X160	5	01222.330.160	M36X300	2	01222.360.300
M30X180	5	01222.300.180	M33X180	2	01222.330.180	M36X320	2	01222.360.320
M30X200	5	01222.300.200						
M30X220	5	01222.300.220	M36X110	5	01222.360.110			

- European constructions must comply with the Construction Products Regulation (CPR) 305/2011 in order to ensure safety to persons and objects.
- In most cases this means the application of products according to harmonized European standards (hEN-standards).
- For non-preloaded structural bolting, this means that fasteners according to EN 15048-1 should be used. Compared to the normal bolts ISO 4014/4017 (formerly DIN 931/933) and nuts ISO 4032 (DIN 934), bolts and nuts according to EN 150548 have a supplementary marking 'SB' (Structural Bolting) and the packaging shows the CE-logo.
- The manufacturers need to be CE-certified for the production of fasteners according to EN 15048.
- Bolts and nuts are packed together in a single sealed box.

01405 Structural assembly set		A96A
Thread	Metric thread	
Material	Steel	
Class	8.8	
Surface treatment	Hot dip galvanized	
CE		 

d x L	☒	Art.number	d x L	☒	Art.number	d x L	☒	Art.number
M10X45/S=16	100	01405.100.045	M16X160	25	01405.160.160	M24X170	10	01405.240.170
M10X50/S=16	100	01405.100.050	M16X170	25	01405.160.170	M24X180	10	01405.240.180
M10X55/S=16	100	01405.100.055	M16X180	25	01405.160.180	M24X200	10	01405.240.200
M10X60/S=16	100	01405.100.060	M16X200	25	01405.160.200	M24X220	10	01405.240.220
M10X65/S=16	100	01405.100.065	M16X220	25	01405.160.220	M24X240	10	01405.240.240
M10X70/S=16	100	01405.100.070	M16X240	10	01405.160.240	M24X260	10	01405.240.260
M10X75/S=16	100	01405.100.075	M16X260	10	01405.160.260	M24X280	10	01405.240.280
M10X80/S=16	100	01405.100.080	M16X280	25	01405.160.280	M24X300	10	01405.240.300
M10X90/S=16	100	01405.100.090	M16X300	25	01405.160.300			
M10X100/S=16	100	01405.100.100				M27X80	10	01405.270.080
M10X110/S=16	50	01405.100.110	M20X65	25	01405.200.065	M27X90	10	01405.270.090
M10X120/S=16	50	01405.100.120	M20X70	25	01405.200.070	M27X100	10	01405.270.100
M10X130/S=16	50	01405.100.130	M20X75	25	01405.200.075	M27X110	10	01405.270.110
M10X140/S=16	50	01405.100.140	M20X80	25	01405.200.080	M27X120	10	01405.270.120
M10X160/S=16	50	01405.100.160	M20X85	25	01405.200.085	M27X130	10	01405.270.130
M10X180/S=16	50	01405.100.180	M20X90	25	01405.200.090	M27X140	10	01405.270.140
			M20X100	25	01405.200.100	M27X150	10	01405.270.150
M12X50/S=18	100	01405.120.050	M20X110	25	01405.200.110	M27X160	10	01405.270.160
M12X55/S=18	100	01405.120.055	M20X120	25	01405.200.120	M27X180	5	01405.270.180
M12X60/S=18	100	01405.120.060	M20X130	25	01405.200.130	M27X200	5	01405.270.200
M12X65/S=18	50	01405.120.065	M20X140	25	01405.200.140	M27X220	5	01405.270.220
M12X70/S=18	50	01405.120.070	M20X150	25	01405.200.150	M27X230	5	01405.270.230
M12X75/S=18	50	01405.120.075	M20X160	10	01405.200.160	M27X240	5	01405.270.240
M12X80/S=18	50	01405.120.080	M20X170	10	01405.200.170	M27X260	5	01405.270.260
M12X90/S=18	50	01405.120.090	M20X180	10	01405.200.180	M27X280	5	01405.270.280
M12X100/S=18	50	01405.120.100	M20X190	10	01405.200.190	M27X300	5	01405.270.300
M12X110/S=18	50	01405.120.110	M20X200	10	01405.200.200			
M12X120/S=18	50	01405.120.120	M20X220	10	01405.200.220	M30X90	10	01405.300.090
M12X130/S=18	50	01405.120.130	M20X240	10	01405.200.240	M30X100	10	01405.300.100
M12X140/S=18	50	01405.120.140	M20X260	10	01405.200.260	M30X110	10	01405.300.110
M12X150/S=18	50	01405.120.150	M20X280	10	01405.200.280	M30X120	10	01405.300.120
M12X160/S=18	50	01405.120.160	M20X300	10	01405.200.300	M30X130	10	01405.300.130
M12X180/S=18	50	01405.120.180				M30X140	10	01405.300.140
			M24X70	25	01405.240.070	M30X150	10	01405.300.150
M16X55	50	01405.160.055	M24X75	25	01405.240.075	M30X160	10	01405.300.160
M16X60	50	01405.160.060	M24X80	25	01405.240.080	M30X180	5	01405.300.180
M16X65	25	01405.160.065	M24X85	10	01405.240.085			
M16X70	25	01405.160.070	M24X90	10	01405.240.090	M36X110	5	01405.360.110
M16X75	25	01405.160.075	M24X95	10	01405.240.095	M36X120	5	01405.360.120
M16X80	25	01405.160.080	M24X100	10	01405.240.100	M36X130	5	01405.360.130
M16X90	25	01405.160.090	M24X110	10	01405.240.110	M36X140	5	01405.360.140
M16X100	25	01405.160.100	M24X120	10	01405.240.120	M36X150	5	01405.360.150
M16X110	25	01405.160.110	M24X130	10	01405.240.130	M36X160	5	01405.360.160
M16X120	25	01405.160.120	M24X140	10	01405.240.140	M36X180	5	01405.360.180
M16X130	25	01405.160.130	M24X150	10	01405.240.150	M36X200	5	01405.360.200
M16X140	25	01405.160.140	M24X160	10	01405.240.160	M36X220	5	01405.360.220
M16X150	25	01405.160.150						

01405 Structural assembly set ←

- European constructions must comply with the Construction Products Regulation (CPR) 305/2011 in order to ensure safety to persons and objects.
- In most cases this means the application of products according to harmonized European standards (hEN-standards).
- For non-preloaded structural bolting, this means that fasteners according to EN 15048-1 should be used. Compared to the normal bolts ISO 4014/4017 (formerly DIN 931/933) and nuts ISO 4032 (DIN 934), bolts and nuts according to EN 150548 have a supplementary marking 'SB' (Structural Bolting) and the packaging shows the CE-logo.
- The manufacturers need to be CE-certified for the production of fasteners according to EN 15048.
- Bolts and nuts are packed together in a single sealed box.

Structural assembly set

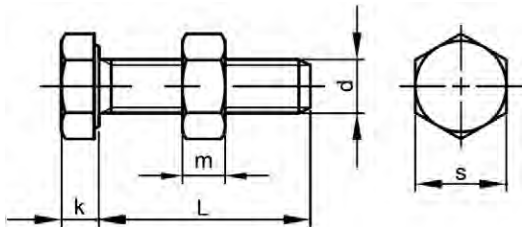

EN 15048
ISO 4017/4032

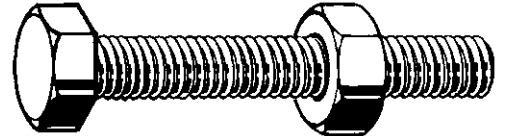

Technical Data

d	k	m (max.)	P	s
M10	6.4	8.4	1.5	16
M12	7.5	10.8	1.75	18
M16	10	14.8	2	24
M20	12.5	18	2.5	30
M24	15	21.5	3	36
M27	17	23.8	3	41
M30	18.7	25.6	3.5	46
M36	22.5	31	4	55

- Full boxes only.

Article groups

Thread	Driving features	Material	Class	Surface treatment	Code	Page	
M	Hexagon	St	8.8	Zipl	01232	1-96	
M	Hexagon	St	8.8	Hot d.g.	ISO metric	01415	1-97

01232 Structural assembly set A96A

Thread Metric thread
Material Steel
Class 8.8
Surface treatment Zinc plated

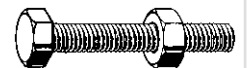

CE

d x L	☒	Art.number	d x L	☒	Art.number	d x L	☒	Art.number
M12X20/S=18	100	01232.120.020	M16X70	25	01232.160.070	M24X70	25	01232.240.070
M12X25/S=18	100	01232.120.025	M16X80	25	01232.160.080	M24X75	25	01232.240.075
M12X30/S=18	100	01232.120.030	M16X90	25	01232.160.090	M24X80	25	01232.240.080
M12X35/S=18	100	01232.120.035	M16X100	25	01232.160.100	M24X90	10	01232.240.090
M12X40/S=18	100	01232.120.040				M24X100	10	01232.240.100
M12X45/S=18	100	01232.120.045	M20X30	25	01232.200.030			
M12X50/S=18	100	01232.120.050	M20X35	25	01232.200.035	M27X50	10	01232.270.050
M12X55/S=18	100	01232.120.055	M20X40	25	01232.200.040	M27X60	10	01232.270.060
M12X60/S=18	100	01232.120.060	M20X45	25	01232.200.045	M27X70	10	01232.270.070
M12X65/S=18	50	01232.120.065	M20X50	25	01232.200.050	M27X80	10	01232.270.080
M12X70/S=18	50	01232.120.070	M20X55	25	01232.200.055			
M12X80/S=18	50	01232.120.080	M20X60	25	01232.200.060	M30X50	10	01232.300.050
M12X100/S=18	50	01232.120.100	M20X65	25	01232.200.065	M30X60	10	01232.300.060
			M20X70	25	01232.200.070	M30X70	10	01232.300.070
M16X20	50	01232.160.020	M20X80	25	01232.200.080	M30X80	10	01232.300.080
M16X25	50	01232.160.025	M20X90	25	01232.200.090	M30X90	10	01232.300.090
M16X30	50	01232.160.030	M20X100	25	01232.200.100	M30X100	10	01232.300.100
M16X35	50	01232.160.035						
M16X40	50	01232.160.040	M24X40	25	01232.240.040	M36X70	5	01232.360.070
M16X45	50	01232.160.045	M24X45	25	01232.240.045	M36X80	5	01232.360.080
M16X50	50	01232.160.050	M24X50	25	01232.240.050	M36X90	5	01232.360.090
M16X55	50	01232.160.055	M24X55	25	01232.240.055	M36X100	5	01232.360.100
M16X60	50	01232.160.060	M24X60	25	01232.240.060			
M16X65	25	01232.160.065	M24X65	25	01232.240.065			

01232 Structural assembly set ←

- European constructions must comply with the Construction Products Regulation (CPR) 305/2011 in order to ensure safety to persons and objects.
- In most cases this means the application of products according to harmonized European standards (hEN-standards).
- For non-preloaded structural bolting, this means that fasteners according to EN 15048-1 should be used. Compared to the normal bolts ISO 4014/4017 (formerly DIN 931/933) and nuts ISO 4032 (DIN 934), bolts and nuts according to EN 150548 have a supplementary marking 'SB' (Structural Bolting) and the packaging shows the CE-logo.
- The manufacturers need to be CE-certified for the production of fasteners according to EN 15048.
- Bolts and nuts are packed together in a single sealed box.

01415 Structural assembly set A96A

Thread Metric thread
Material Steel
Class 8.8
Surface treatment Hot dip galvanized

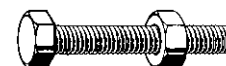

CE

d x L	☒	Art.number	d x L	☒	Art.number	d x L	☒	Art.number
M10X16/S=16	200	01415.100.016	M16X25	50	01415.160.025	M24X50	25	01415.240.050
M10X20/S=16	200	01415.100.020	M16X30	50	01415.160.030	M24X55	25	01415.240.055
M10X25/S=16	200	01415.100.025	M16X35	50	01415.160.035	M24X60	25	01415.240.060
M10X30/S=16	200	01415.100.030	M16X40	50	01415.160.040	M24X65	25	01415.240.065
M10X35/S=16	100	01415.100.035	M16X45	50	01415.160.045	M24X70	25	01415.240.070
M10X40/S=16	100	01415.100.040	M16X50	50	01415.160.050	M24X75	25	01415.240.075
M10X45/S=16	100	01415.100.045	M16X55	50	01415.160.055	M24X80	25	01415.240.080
M10X50/S=16	100	01415.100.050	M16X60	50	01415.160.060	M24X90	10	01415.240.090
M10X55/S=16	100	01415.100.055	M16X65	25	01415.160.065	M24X100	10	01415.240.100
M10X60/S=16	100	01415.100.060	M16X70	25	01415.160.070	M24X110	10	01415.240.110
M10X65/S=16	100	01415.100.065	M16X75	25	01415.160.075	M24X120	10	01415.240.120
M10X70/S=16	100	01415.100.070	M16X80	25	01415.160.080			
M10X75/S=16	100	01415.100.075	M16X90	25	01415.160.090	M27X50	10	01415.270.050
M10X80/S=16	100	01415.100.080	M16X100	25	01415.160.100	M27X60	10	01415.270.060
M10X90/S=16	100	01415.100.090	M16X110	25	01415.160.110	M27X65	10	01415.270.065
M10X100/S=16	100	01415.100.100	M16X120	25	01415.160.120	M27X70	10	01415.270.070
						M27X75	10	01415.270.075
M12X20/S=18	100	01415.120.020	M20X30	25	01415.200.030	M27X80	10	01415.270.080
M12X25/S=18	100	01415.120.025	M20X35	25	01415.200.035	M27X90	10	01415.270.090
M12X30/S=18	100	01415.120.030	M20X40	25	01415.200.040	M27X100	10	01415.270.100
M12X35/S=18	100	01415.120.035	M20X45	25	01415.200.045	M27X110	10	01415.270.110
M12X40/S=18	100	01415.120.040	M20X50	25	01415.200.050	M27X120	10	01415.270.120
M12X45/S=18	100	01415.120.045	M20X55	25	01415.200.055			
M12X50/S=18	100	01415.120.050	M20X60	25	01415.200.060	M30X60	10	01415.300.060
M12X55/S=18	100	01415.120.055	M20X65	25	01415.200.065	M30X65	10	01415.300.065
M12X60/S=18	100	01415.120.060	M20X70	25	01415.200.070	M30X70	10	01415.300.070
M12X65/S=18	50	01415.120.065	M20X75	25	01415.200.075	M30X80	10	01415.300.080
M12X70/S=18	50	01415.120.070	M20X80	25	01415.200.080	M30X90	10	01415.300.090
M12X75/S=18	50	01415.120.075	M20X90	25	01415.200.090	M30X100	10	01415.300.100
M12X80/S=18	50	01415.120.080	M20X100	25	01415.200.100			
M12X90 /S=18	50	01415.120.090	M20X110	25	01415.200.110	M36X80	5	01415.360.080
M12X100/S=18	50	01415.120.100	M20X120	25	01415.200.120	M36X90	5	01415.360.090
M12X110/S=18	50	01415.120.110				M36X100	5	01415.360.100
M12X120/S=18	50	01415.120.120	M24X40	25	01415.240.040			
			M24X45	25	01415.240.045			

- European constructions must comply with the Construction Products Regulation (CPR) 305/2011 in order to ensure safety to persons and objects.
- In most cases this means the application of products according to harmonized European standards (hEN-standards).
- For non-preloaded structural bolting, this means that fasteners according to EN 15048-1 should be used. Compared to the normal bolts ISO 4014/4017 (formerly DIN 931/933) and nuts ISO 4032 (DIN 934), bolts and nuts according to EN 150548 have a supplementary marking 'SB' (Structural Bolting) and the packaging shows the CE-logo.
- The manufacturers need to be CE-certified for the production of fasteners according to EN 15048.
- Bolts and nuts are packed together in a single sealed box.

Protecting cap for hexagon bolts, screws and nuts

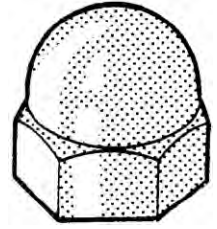
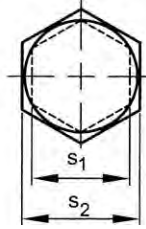
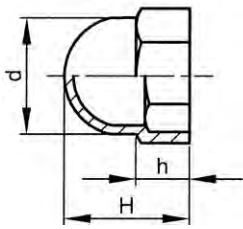

Technical Data

For use with	d	h	H	s	s ₁	s ₂
M4	7.6	4.8	8.1	7	6.8	8.6
M5	9.5	6.9	10.8	8	7.8	9.8
M6	11	6.9	13.3	10	9.8	11.6
M7	12	7.4	14.2	11	10.8	12.5
M8	14.3	8	15.3	13	12.8	15
M10	18	10.3	20.5	17	16.7	18.8
M12	20.2	11.5	22	19	18.7	20.8
M14	23.5	13	24.5	22	21.7	24.3
M16	26	15.1	28	24	23.7	26.5
M20	32	18	34	30	29.8	33
M22	34	19	37	32	31.8	35
M24	38	20	41	36	35.8	39.5
M27	43	22	47	41	40.8	44.5
M30	48	24	52	46	45.8	49.5
M33	53	36	57.5	50	49	54
M36	57	38	62.2	55	54.5	58.7

Example of application

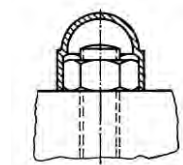

Article groups

Material	Color	Code	Page
Plastic PE	White	56660	1-98
Plastic PE	Black	56661	1-99
Plastic PE	Grey	56662	1-99

56660 Protecting cap for hexagon bolts, screws and nuts

W02G

Material Plastic Polyethylene
Color White

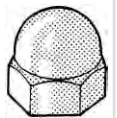

For use with / s	☒	Art.number	For use with / s	☒	Art.number	For use with / s	☒	Art.number
M4/s=7	100	56660.040.001	M12/s=19	50	56660.120.001	M27/s=41	10	56660.270.001
M5/s=8	100	56660.050.001	M14/s=22	50	56660.140.001	M30/s=46	10	56660.300.001
M6/s=10	100	56660.060.001	M16/s=24	50	56660.160.001	M33/s=50	10	56660.330.001
M7/s=11	100	56660.070.001	M20/s=30	25	56660.200.001	M36/s=55	10	56660.360.001
M8/s=13	100	56660.080.001	M22/s=32	25	56660.220.001			
M10/s=17	50	56660.100.001	M24/s=36	25	56660.240.001			

56661	Protecting cap for hexagon bolts, screws and nuts		W02G
Material	Plastic Polyethylene		
Color	Black		

For use with / s	☒	Art.number	For use with / s	☒	Art.number	For use with / s	☒	Art.number
M4/s=7	100	56661.040.001	M10/s=17	50	56661.100.001	M20/s=30	25	56661.200.001
M5/s=8	100	56661.050.001	M12/s=19	50	56661.120.001	M22/s=32	25	56661.220.001
M6/s=10	100	56661.060.001	M14/s=22	50	56661.140.001	M24/s=36	25	56661.240.001
M7/s=11	100	56661.070.001	M16/s=24	50	56661.160.001	M27/s=41	10	56661.270.001
M8/s=13	100	56661.080.001						

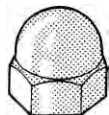
56662	Protecting cap for hexagon bolts, screws and nuts		W03G
Material	Plastic Polyethylene		
Color	Grey		

For use with / s	☒	Art.number	For use with / s	☒	Art.number	For use with / s	☒	Art.number
M4/s=7	100	56662.040.001	M8/s=13	100	56662.080.001	M16/s=24	50	56662.160.001
M5/s=8	100	56662.050.001	M10/s=17	50	56662.100.001	M20/s=30	25	56662.200.001
M6/s=10	100	56662.060.001	M12/s=19	50	56662.120.001	M24/s=36	25	56662.240.001
M7/s=11	100	56662.070.001	M14/s=22	50	56662.140.001			

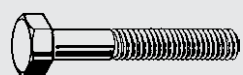

1 Bolts



2 Hexagon socket products



3 Nuts, rivet nuts & inserts



4 Threaded rods & studbolts



5 Hook & eye products



6 Screws

I Index



7 Washers & O-rings



8 Anchoring products

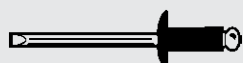

9 Rivets, pins & keys

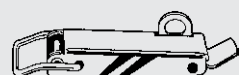

10 Systems, furniture & security fasteners



11 Assortments & storage systems

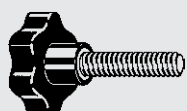

12 Engineering parts & machine parts

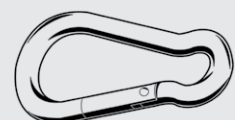

























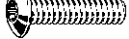























13 Maritime products

T Fastening technology

Hexagon socket products²

2

 Page 2-2 DIN 912 Metric	 Page 2-16 ISO 14579 Hexalobular Metric	 Page 2-17 DIN ≈912 Fully threaded Metric	 Page 2-20 DIN 912 Metric fine	 Page 2-21 ASME ≈B18.3 (1960) 1960 Series UNC
 Page 2-22 ASME ≈B18.3 (1936) 1936 Series UNC	 Page 2-28 ASME ≈B18.3 (1936) 1936 Series UNF	 Page 2-32 BS ≈2470 BSW	 Page 2-32 DIN 7984 Low cylindrical Metric	 Page 2-36 DIN 6912 Low cylindrical with pilot recess Metric
 Page 2-39 ISO 10642 Metric	 Page 2-44 ISO ≈10642 Hexalobular Metric	 Page 2-45 ASME ≈B18.3 UNC	 Page 2-48 ASME ≈B18.3 UNF	 Page 2-50 BS ≈2470 BSW
 Page 2-51 ISO 7380-1 Metric	 Page 2-54 ISO ≈7380-1 Hexalobular Metric	 Page 2-56 UNC	 Page 2-58 UNF	 Page 2-59 ISO 7380-2 With flange Metric
 Page 2-62 ISO ≈7380-2 Hexalobular Metric	 Page 2-63 Self Locking Metric	 Page 2-64 ISO ≈7379 Shoulder screw f9 Metric	 Page 2-66 ASME B18.3 UNC	 Page 2-68 ISO ≈7379 Tolerance h8 Metric
 Page 2-69 DIN 916 Cup point Metric	 Page 2-72 DIN ≈916 Cup point Metric fine	 Page 2-73 ASME ≈B18.3 Cup point UNC	 Page 2-75 ASME ≈B18.3 Cup point UNF	 Page 2-76 DIN ≈916 Cup point knurled Metric
 Page 2-77 ASME ≈B18.3 Cup point knurled UNC	 Page 2-78 ASME ≈B18.3 Cup point knurled UNF	 Page 2-78 DIN 913 Flat point Metric	 Page 2-81 DIN ≈913 Flat point Metric fine	 Page 2-82 ASME ≈B18.3 Flat point UNC
 Page 2-83 DIN 914 Cone point Metric	 Page 2-85 ASME ≈B18.3 Cone point UNC	 Page 2-86 DIN 915 Dog point Metric	 Page 2-88 ASME ≈B18.3 Half dog point UNC	 Page 2-89 With nylon dog point Metric
 Page 2-90 BS ≈2470 Cup point BSW	 Page 2-90 ASME ≈B18.3 Oval point UNC	 Page 2-91 Plastic	 Page 2-92 DIN 906 Metric fine	 Page 2-93 DIN 906 Non Metric
 Page 2-94 DIN 908 With collar Metric fine	 Page 2-95 DIN 908 With collar Non Metric	 Page 2-96 DIN 910 With collar Metric fine	 Page 2-97 DIN 910 With collar Non Metric	

Hexagon socket head cap screw

2

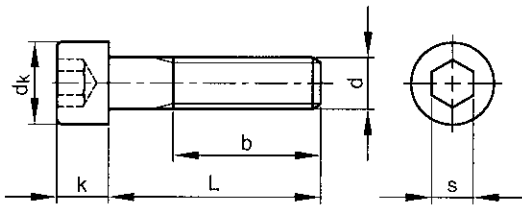

DIN 912
 ISO 4762
 NEN 1241
 ASME B18.3.1M
 NF E25-125
 BS 4168-1

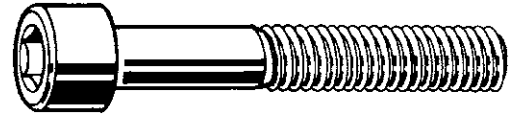

Technical Data

d	b	d _k (max.)	Full thread L ≤	k (max.)	P	s
M1.6	15	3	16	1.6	0.35	1.5
M2	16	3.8	20	2	0.4	1.5
M2.5	17	4.5	25	2.5	0.45	2
M3	18	5.5	20	3	0.5	2.5
M4	20	7	25	4	0.7	3
M5	22	8.5	25	5	0.8	4
M6	24	10	30	6	1	5
M8	28	13	35	8	1.25	6
M10	32	16	40	10	1.5	8
M12	36	18	50	12	1.75	10
M14	40	21	55	14	2	12
M16	44	24	60	16	2	14
M18	48	27	65	18	2.5	14
M20	52	30	75	20	2.5	17
M22	56	33	70	22	2.5	17
M24	60	36	85	24	3	19
M27	66	40	90	27	3	19
M30	72	45	100	30	3.5	22
M33	78	50	100	33	3.5	24
M36	84	54	110	36	4	27
M39 (≠DIN)	90	58	120	39	4	27
M42	96	63	130	42	4.5	32
M48	108	72	150	48	5	36

Article groups

Thread	Driving features	Material	Class	Surface treatment	Code	Page
M	Hexagon socket	St	8.8		07060	2-2
M	Hexagon socket	St	8.8	Zipl	07160	2-4
M	Hexagon socket	St	8.8	Zipl yell.p.	07170	2-5
M	Hexagon socket	St	8.8	FLZNNC-NC6	07065	2-6
M	Hexagon socket	St	10.9		07015	2-6
M	Hexagon socket	St	12.9		07000	2-7
M	Hexagon socket	St	12.9	FLZNNC-NC6	07025	2-9
M	Hexagon socket	St.St. A2	70		51050	2-10
M	Hexagon socket	St.St. A4	70		55050	2-12
M	Hexagon socket	St.St. A4	80		53570	2-14
M	Hexagon socket	Al P60			45205	2-15

07060 Hexagon socket head cap screw

D02A

Thread Metric thread
 Material Steel
 Class 8.8



d x L	Art.number	d x L	Art.number	d x L	Art.number
M3X4	200 07060.030.004	M4X6	200 07060.040.006	M4X40	200 07060.040.040
M3X5	200 07060.030.005	M4X8	200 07060.040.008	M4X45	200 07060.040.045
M3X6	200 07060.030.006	M4X10	200 07060.040.010	M4X50	200 07060.040.050
M3X8	200 07060.030.008	M4X12	200 07060.040.012	M4X60	200 07060.040.060
M3X10	200 07060.030.010	M4X16	200 07060.040.016	M4X65	200 07060.040.065
M3X12	200 07060.030.012	M4X18	200 07060.040.018	M4X70	200 07060.040.070
M3X16	200 07060.030.016	M4X20	200 07060.040.020	M5X6	200 07060.050.006
M3X20	200 07060.030.020	M4X25	200 07060.040.025	M5X8	200 07060.050.008
M3X25	200 07060.030.025	M4X30	200 07060.040.030	M5X10	200 07060.050.010
M3X30	500 07060.030.030	M4X35	200 07060.040.035	M5X12	200 07060.050.012
M3X40	200 07060.030.040				

07060 Hexagon socket head cap screw								
d x L	☒	Art.number	d x L	☒	Art.number	d x L	☒	Art.number
M5X14	200	07060.050.014	M10X22	200	07060.100.022	M16X30	50	07060.160.030
M5X16	200	07060.050.016	M10X25	200	07060.100.025	M16X35	50	07060.160.035
M5X18	200	07060.050.018	M10X30	200	07060.100.030	M16X40	50	07060.160.040
M5X20	200	07060.050.020	M10X35	100	07060.100.035	M16X45	50	07060.160.045
M5X25	200	07060.050.025	M10X40	100	07060.100.040	M16X50	50	07060.160.050
M5X30	200	07060.050.030	M10X45	100	07060.100.045	M16X55	50	07060.160.055
M5X35	200	07060.050.035	M10X50	100	07060.100.050	M16X60	50	07060.160.060
M5X40	200	07060.050.040	M10X55	100	07060.100.055	M16X65	50	07060.160.065
M5X45	200	07060.050.045	M10X60	100	07060.100.060	M16X70	25	07060.160.070
M5X50	200	07060.050.050	M10X65	100	07060.100.065	M16X75	25	07060.160.075
M5X55	200	07060.050.055	M10X70	100	07060.100.070	M16X80	25	07060.160.080
M5X60	200	07060.050.060	M10X75	100	07060.100.075	M16X85	25	07060.160.085
M5X70	200	07060.050.070	M10X80	100	07060.100.080	M16X90	25	07060.160.090
M5X75	200	07060.050.075	M10X90	100	07060.100.090	M16X100	25	07060.160.100
M5X80	200	07060.050.080	M10X100	50	07060.100.100	M16X110	25	07060.160.110
M5X90	200	07060.050.090	M10X110	50	07060.100.110	M16X120	25	07060.160.120
M5X100	200	07060.050.100	M10X120	50	07060.100.120	M16X130	25	07060.160.130
M5X110	100	07060.050.110	M10X130	50	07060.100.130	M16X140	25	07060.160.140
M5X120	100	07060.050.120	M10X140	50	07060.100.140	M16X150	25	07060.160.150
M5X140	100	07060.050.140	M10X150	25	07060.100.150	M16X160	25	07060.160.160
			M10X160	25	07060.100.160	M16X180	10	07060.160.180
M6X8	200	07060.060.008	M10X170	25	07060.100.170	M16X200	10	07060.160.200
M6X10	200	07060.060.010	M10X180	25	07060.100.180	M16X220	10	07060.160.220
M6X12	200	07060.060.012	M10X200	25	07060.100.200	M16X240	10	07060.160.240
M6X14	200	07060.060.014	M10X220	25	07060.100.220	M16X260	10	07060.160.260
M6X16	200	07060.060.016				M16X300	10	07060.160.300
M6X18	200	07060.060.018	M12X16	100	07060.120.016			
M6X20	200	07060.060.020	M12X20	100	07060.120.020	M18X35	25	07060.180.035
M6X22	200	07060.060.022	M12X25	100	07060.120.025	M18X40	25	07060.180.040
M6X25	200	07060.060.025	M12X30	100	07060.120.030	M18X45	25	07060.180.045
M6X30	200	07060.060.030	M12X35	100	07060.120.035	M18X50	25	07060.180.050
M6X35	200	07060.060.035	M12X40	100	07060.120.040	M18X55	25	07060.180.055
M6X40	200	07060.060.040	M12X45	100	07060.120.045	M18X60	25	07060.180.060
M6X45	200	07060.060.045	M12X50	100	07060.120.050	M18X70	25	07060.180.070
M6X50	200	07060.060.050	M12X55	100	07060.120.055	M18X80	25	07060.180.080
M6X55	200	07060.060.055	M12X60	100	07060.120.060	M18X90	25	07060.180.090
M6X60	200	07060.060.060	M12X65	50	07060.120.065	M18X100	25	07060.180.100
M6X65	200	07060.060.065	M12X70	50	07060.120.070	M18X110	10	07060.180.110
M6X70	200	07060.060.070	M12X75	50	07060.120.075	M18X120	10	07060.180.120
M6X75	200	07060.060.075	M12X80	50	07060.120.080	M18X140	10	07060.180.140
M6X80	200	07060.060.080	M12X90	50	07060.120.090	M18X160	10	07060.180.160
M6X90	100	07060.060.090	M12X100	50	07060.120.100	M18X180	10	07060.180.180
M6X100	100	07060.060.100	M12X110	50	07060.120.110	M18X200	10	07060.180.200
M6X110	100	07060.060.110	M12X120	25	07060.120.120			
M6X120	100	07060.060.120	M12X130	25	07060.120.130	M20X30	50	07060.200.030
M6X130	100	07060.060.130	M12X140	25	07060.120.140	M20X35	25	07060.200.035
M6X140	100	07060.060.140	M12X150	25	07060.120.150	M20X40	25	07060.200.040
M6X150	100	07060.060.150	M12X160	25	07060.120.160	M20X45	25	07060.200.045
M6X160	100	07060.060.160	M12X180	25	07060.120.180	M20X50	25	07060.200.050
M6X180	100	07060.060.180	M12X200	25	07060.120.200	M20X55	25	07060.200.055
			M12X220	25	07060.120.220	M20X60	25	07060.200.060
M8X10	200	07060.080.010	M12X240	25	07060.120.240	M20X65	25	07060.200.065
M8X12	200	07060.080.012	M12X260	25	07060.120.260	M20X70	25	07060.200.070
M8X16	200	07060.080.016	M12X280	25	07060.120.280	M20X75	25	07060.200.075
M8X18	200	07060.080.018	M12X300	25	07060.120.300	M20X80	25	07060.200.080
M8X20	200	07060.080.020				M20X90	25	07060.200.090
M8X22	200	07060.080.022	M14X20	100	07060.140.020	M20X100	25	07060.200.100
M8X25	200	07060.080.025	M14X25	100	07060.140.025	M20X110	25	07060.200.110
M8X30	200	07060.080.030	M14X30	100	07060.140.030	M20X120	25	07060.200.120
M8X35	200	07060.080.035	M14X35	100	07060.140.035	M20X130	25	07060.200.130
M8X40	200	07060.080.040	M14X40	100	07060.140.040	M20X140	25	07060.200.140
M8X45	200	07060.080.045	M14X45	50	07060.140.045	M20X150	25	07060.200.150
M8X50	200	07060.080.050	M14X50	50	07060.140.050	M20X160	10	07060.200.160
M8X55	200	07060.080.055	M14X55	50	07060.140.055	M20X180	10	07060.200.180
M8X60	200	07060.080.060	M14X60	50	07060.140.060	M20X190	10	07060.200.190
M8X70	200	07060.080.070	M14X70	50	07060.140.070	M20X200	10	07060.200.200
M8X75	200	07060.080.075	M14X75	50	07060.140.075	M20X220	10	07060.200.220
M8X80	200	07060.080.080	M14X80	50	07060.140.080	M20X240	10	07060.200.240
M8X90	100	07060.080.090	M14X90	50	07060.140.090	M20X250	10	07060.200.250
M8X100	100	07060.080.100	M14X100	50	07060.140.100	M20X260	10	07060.200.260
M8X110	100	07060.080.110	M14X110	50	07060.140.110	M20X270	10	07060.200.270
M8X120	100	07060.080.120	M14X120	25	07060.140.120	M20X280	10	07060.200.280
M8X130	50	07060.080.130	M14X130	25	07060.140.130	M20X300	10	07060.200.300
M8X140	50	07060.080.140	M14X140	25	07060.140.140	M20X310	10	07060.200.310
M8X150	50	07060.080.150	M14X150	25	07060.140.150			
M8X160	50	07060.080.160	M14X160	25	07060.140.160	M22X50	10	07060.220.050
M8X180	50	07060.080.180	M14X180	25	07060.140.180	M22X60	10	07060.220.060
M8X200	50	07060.080.200	M14X190	25	07060.140.190	M22X70	10	07060.220.070
			M14X200	25	07060.140.200	M22X80	10	07060.220.080
M10X12	200	07060.100.012				M22X90	10	07060.220.090
M10X16	200	07060.100.016	M16X20	100	07060.160.020	M22X100	10	07060.220.100
M10X20	200	07060.100.020	M16X25	100	07060.160.025	M22X110	10	07060.220.110

07060 Hexagon socket head cap screw ←

d x L	☒	Art.number	d x L	☒	Art.number	d x L	☒	Art.number
M22X120	10	07060.220.120	M27X60	10	07060.270.060	M33X70	2	07060.330.070
M22X130	10	07060.220.130	M27X70	10	07060.270.070	M33X80	2	07060.330.080
M22X140	10	07060.220.140	M27X80	10	07060.270.080	M33X90	2	07060.330.090
M22X150	10	07060.220.150	M27X90	10	07060.270.090	M33X100	2	07060.330.100
M22X160	10	07060.220.160	M27X100	10	07060.270.100	M33X120	2	07060.330.120
M22X180	5	07060.220.180	M27X120	10	07060.270.120	M33X130	2	07060.330.130
M22X200	5	07060.220.200	M27X130	10	07060.270.130	M33X140	2	07060.330.140
M24X40	10	07060.240.040	M27X140	10	07060.270.140	M33X160	2	07060.330.160
M24X45	10	07060.240.045	M27X160	10	07060.270.160	M33X180	2	07060.330.180
M24X50	10	07060.240.050	M27X180	10	07060.270.180	M33X200	2	07060.330.200
M24X55	10	07060.240.055	M27X200	10	07060.270.200	M36X60	1	07060.360.060
M24X60	10	07060.240.060	M30X60	5	07060.300.060	M36X80	1	07060.360.080
M24X65	10	07060.240.065	M30X70	5	07060.300.070	M36X100	1	07060.360.100
M24X70	10	07060.240.070	M30X80	5	07060.300.080	M36X110	1	07060.360.110
M24X75	5	07060.240.075	M30X90	2	07060.300.090	M36X120	1	07060.360.120
M24X80	10	07060.240.080	M30X100	2	07060.300.100	M36X140	1	07060.360.140
M24X90	10	07060.240.090	M30X110	2	07060.300.110	M36X160	1	07060.360.160
M24X100	10	07060.240.100	M30X120	2	07060.300.120	M36X180	1	07060.360.180
M24X110	10	07060.240.110	M30X130	2	07060.300.130	M36X200	1	07060.360.200
M24X120	5	07060.240.120	M30X140	2	07060.300.140	M36X220	1	07060.360.220
M24X130	5	07060.240.130	M30X150	2	07060.300.150	M36X240	1	07060.360.240
M24X140	5	07060.240.140	M30X160	2	07060.300.160	M36X260	1	07060.360.260
M24X150	5	07060.240.150	M30X170	2	07060.300.170	M36X280	1	07060.360.280
M24X160	5	07060.240.160	M30X180	2	07060.300.180	M36X300	1	07060.360.300
M24X180	5	07060.240.180	M30X190	2	07060.300.190	M42X100	1	07060.420.100
M24X190	5	07060.240.190	M30X200	2	07060.300.200	M42X120	1	07060.420.120
M24X200	5	07060.240.200	M30X220	2	07060.300.220	M42X140	1	07060.420.140
M24X220	5	07060.240.220	M30X240	2	07060.300.240	M42X160	1	07060.420.160
M24X240	5	07060.240.240	M30X260	2	07060.300.260	M42X180	1	07060.420.180
M24X260	5	07060.240.260	M30X280	2	07060.300.280	M42X200	1	07060.420.200
M24X280	5	07060.240.280	M30X300	2	07060.300.300	M42X240	1	07060.420.240
M24X300	5	07060.240.300				M42X280	1	07060.420.280
M24X320	5	07060.240.320						

07160 Hexagon socket head cap screw D02A

Thread Metric thread
Material Steel
Class 8.8
Surface treatment Zinc plated

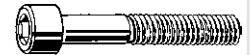

d x L	☒	Art.number	d x L	☒	Art.number	d x L	☒	Art.number
M3X5	200	07160.030.005	M5X25	200	07160.050.025	M6X110	100	07160.060.110
M3X6	200	07160.030.006	M5X30	200	07160.050.030	M6X120	100	07160.060.120
M3X8	200	07160.030.008	M5X35	200	07160.050.035			
M3X10	200	07160.030.010	M5X40	200	07160.050.040	M8X10	200	07160.080.010
M3X12	200	07160.030.012	M5X45	200	07160.050.045	M8X12	200	07160.080.012
M3X16	200	07160.030.016	M5X50	200	07160.050.050	M8X14	200	07160.080.014
M3X18	200	07160.030.018	M5X55	200	07160.050.055	M8X16	200	07160.080.016
M3X20	200	07160.030.020	M5X60	200	07160.050.060	M8X18	200	07160.080.018
M3X25	200	07160.030.025	M5X70	200	07160.050.070	M8X20	200	07160.080.020
M3X30	200	07160.030.030	M5X80	200	07160.050.080	M8X22	200	07160.080.022
M3X35	200	07160.030.035	M5X90	200	07160.050.090	M8X25	200	07160.080.025
M3X40	200	07160.030.040	M5X100	200	07160.050.100	M8X30	200	07160.080.030
			M5X120	100	07160.050.120	M8X35	200	07160.080.035
M4X6	200	07160.040.006				M8X40	200	07160.080.040
M4X8	200	07160.040.008	M6X6	100	07160.060.006	M8X45	200	07160.080.045
M4X10	200	07160.040.010	M6X8	200	07160.060.008	M8X50	200	07160.080.050
M4X12	200	07160.040.012	M6X10	200	07160.060.010	M8X55	200	07160.080.055
M4X16	200	07160.040.016	M6X12	200	07160.060.012	M8X60	200	07160.080.060
M4X18	200	07160.040.018	M6X16	200	07160.060.016	M8X65	200	07160.080.065
M4X20	200	07160.040.020	M6X18	200	07160.060.018	M8X70	200	07160.080.070
M4X25	200	07160.040.025	M6X20	200	07160.060.020	M8X75	200	07160.080.075
M4X30	200	07160.040.030	M6X22	200	07160.060.022	M8X80	200	07160.080.080
M4X35	200	07160.040.035	M6X25	200	07160.060.025	M8X85	100	07160.080.085
M4X40	200	07160.040.040	M6X30	200	07160.060.030	M8X90	100	07160.080.090
M4X45	200	07160.040.045	M6X35	200	07160.060.035	M8X100	100	07160.080.100
M4X50	200	07160.040.050	M6X40	200	07160.060.040	M8X110	100	07160.080.110
M4X60	200	07160.040.060	M6X45	200	07160.060.045	M8X120	100	07160.080.120
M4X70	200	07160.040.070	M6X50	200	07160.060.050	M8X130	50	07160.080.130
			M6X55	200	07160.060.055	M8X140	50	07160.080.140
M5X6	200	07160.050.006	M6X60	200	07160.060.060	M8X160	50	07160.080.160
M5X8	200	07160.050.008	M6X65	200	07160.060.065			
M5X10	200	07160.050.010	M6X70	200	07160.060.070	M10X12	200	07160.100.012
M5X12	200	07160.050.012	M6X75	200	07160.060.075	M10X16	200	07160.100.016
M5X16	200	07160.050.016	M6X80	200	07160.060.080	M10X20	200	07160.100.020
M5X18	200	07160.050.018	M6X90	100	07160.060.090	M10X25	200	07160.100.025
M5X20	200	07160.050.020	M6X100	100	07160.060.100	M10X30	200	07160.100.030

07160 Hexagon socket head cap screw								
d x L	☒	Art.number	d x L	☒	Art.number	d x L	☒	Art.number
M10X35	100	07160.100.035	M14X55	50	07160.140.055	M20X90	25	07160.200.090
M10X40	100	07160.100.040	M14X60	50	07160.140.060	M20X100	25	07160.200.100
M10X45	100	07160.100.045	M14X65	50	07160.140.065	M20X110	25	07160.200.110
M10X50	100	07160.100.050	M14X70	50	07160.140.070	M20X120	25	07160.200.120
M10X55	100	07160.100.055	M14X80	50	07160.140.080	M20X130	25	07160.200.130
M10X60	100	07160.100.060	M14X90	50	07160.140.090	M20X140	25	07160.200.140
M10X65	100	07160.100.065	M14X100	50	07160.140.100	M20X160	10	07160.200.160
M10X70	100	07160.100.070	M14X110	50	07160.140.110	M20X180	10	07160.200.180
M10X75	100	07160.100.075	M14X120	25	07160.140.120	M20X200	10	07160.200.200
M10X80	100	07160.100.080	M14X180	25	07160.140.180			
M10X85	100	07160.100.085				M22X50	10	07160.220.050
M10X90	100	07160.100.090	M16X20	50	07160.160.020	M22X60	10	07160.220.060
M10X100	50	07160.100.100	M16X25	50	07160.160.025	M22X70	10	07160.220.070
M10X110	50	07160.100.110	M16X30	50	07160.160.030	M22X80	10	07160.220.080
M10X120	50	07160.100.120	M16X35	50	07160.160.035	M22X100	10	07160.220.100
M10X130	50	07160.100.130	M16X40	50	07160.160.040			
M10X140	50	07160.100.140	M16X45	50	07160.160.045	M24X40	10	07160.240.040
M10X160	25	07160.100.160	M16X50	50	07160.160.050	M24X50	10	07160.240.050
M10X180	25	07160.100.180	M16X55	50	07160.160.055	M24X60	10	07160.240.060
			M16X60	50	07160.160.060	M24X65	10	07160.240.065
M12X16	100	07160.120.016	M16X65	50	07160.160.065	M24X70	10	07160.240.070
M12X20	100	07160.120.020	M16X70	25	07160.160.070	M24X75	10	07160.240.075
M12X25	100	07160.120.025	M16X80	25	07160.160.080	M24X80	10	07160.240.080
M12X30	100	07160.120.030	M16X90	25	07160.160.090	M24X90	10	07160.240.090
M12X35	100	07160.120.035	M16X100	25	07160.160.100	M24X100	10	07160.240.100
M12X40	100	07160.120.040	M16X110	25	07160.160.110	M24X110	10	07160.240.110
M12X45	100	07160.120.045	M16X120	25	07160.160.120	M24X120	5	07160.240.120
M12X50	100	07160.120.050	M16X130	25	07160.160.130	M24X140	5	07160.240.140
M12X55	100	07160.120.055	M16X140	25	07160.160.140	M24X160	5	07160.240.160
M12X60	100	07160.120.060	M16X150	50	07160.160.150	M24X180	5	07160.240.180
M12X65	50	07160.120.065	M16X160	25	07160.160.160	M24X200	5	07160.240.200
M12X70	50	07160.120.070	M16X180	10	07160.160.180			
M12X75	50	07160.120.075	M16X200	10	07160.160.200	M27X60	10	07160.270.060
M12X80	50	07160.120.080				M27X80	10	07160.270.080
M12X85	50	07160.120.085	M18X40	25	07160.180.040	M27X100	10	07160.270.100
M12X90	50	07160.120.090	M18X50	25	07160.180.050			
M12X100	50	07160.120.100	M18X60	25	07160.180.060	M30X80	5	07160.300.080
M12X110	50	07160.120.110	M18X80	25	07160.180.080	M30X100	2	07160.300.100
M12X120	25	07160.120.120	M18X100	25	07160.180.100	M30X120	2	07160.300.120
M12X130	25	07160.120.130	M18X120	10	07160.180.120	M30X140	2	07160.300.140
M12X140	25	07160.120.140				M30X160	2	07160.300.160
M12X150	25	07160.120.150	M20X30	25	07160.200.030	M30X180	2	07160.300.180
M12X160	25	07160.120.160	M20X40	25	07160.200.040	M30X200	1	07160.300.200
M12X180	25	07160.120.180	M20X45	25	07160.200.045			
			M20X50	25	07160.200.050	M36X100	1	07160.360.100
M14X30	100	07160.140.030	M20X55	25	07160.200.055	M36X120	1	07160.360.120
M14X35	100	07160.140.035	M20X60	25	07160.200.060	M36X160	1	07160.360.160
M14X40	100	07160.140.040	M20X65	25	07160.200.065	M36X200	1	07160.360.200
M14X45	50	07160.140.045	M20X70	25	07160.200.070	M36X240	1	07160.360.240
M14X50	50	07160.140.050	M20X80	25	07160.200.080			

07170 Hexagon socket head cap screw				D02A			
Thread	Metric thread						
Material	Steel						
Class	8.8						
Surface treatment	Zinc plated yellow passivated						

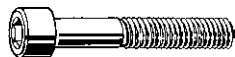

d x L	☒	Art.number	d x L	☒	Art.number	d x L	☒	Art.number
M4X6	200	07170.040.006	M5X50	200	07170.050.050	M8X35	200	07170.080.035
M4X8	200	07170.040.008				M8X40	200	07170.080.040
M4X10	200	07170.040.010	M6X10	200	07170.060.010	M8X45	200	07170.080.045
M4X12	200	07170.040.012	M6X12	200	07170.060.012	M8X50	200	07170.080.050
M4X16	200	07170.040.016	M6X16	200	07170.060.016	M8X55	200	07170.080.055
M4X20	200	07170.040.020	M6X20	200	07170.060.020	M8X60	200	07170.080.060
M4X25	200	07170.040.025	M6X25	200	07170.060.025	M8X70	200	07170.080.070
M4X30	200	07170.040.030	M6X30	200	07170.060.030	M8X80	200	07170.080.080
M4X35	200	07170.040.035	M6X35	200	07170.060.035	M8X90	50	07170.080.090
M4X40	200	07170.040.040	M6X40	200	07170.060.040	M8X100	200	07170.080.100
			M6X45	200	07170.060.045			
M5X10	200	07170.050.010	M6X50	200	07170.060.050	M10X16	200	07170.100.016
M5X12	200	07170.050.012	M6X60	200	07170.060.060	M10X20	200	07170.100.020
M5X16	200	07170.050.016	M6X70	200	07170.060.070	M10X25	200	07170.100.025
M5X20	200	07170.050.020	M6X80	200	07170.060.080	M10X30	200	07170.100.030
M5X25	200	07170.050.025				M10X35	100	07170.100.035
M5X30	200	07170.050.030	M8X16	200	07170.080.016	M10X40	100	07170.100.040
M5X35	200	07170.050.035	M8X20	200	07170.080.020	M10X45	100	07170.100.045
M5X40	200	07170.050.040	M8X25	200	07170.080.025	M10X50	100	07170.100.050
M5X45	200	07170.050.045	M8X30	200	07170.080.030	M10X60	100	07170.100.060

07170 Hexagon socket head cap screw ←

d x L	☒	Art.number	d x L	☒	Art.number	d x L	☒	Art.number
M10X70	100	07170.100.070	M12X25	100	07170.120.025	M12X60	100	07170.120.060
M10X80	100	07170.100.080	M12X30	100	07170.120.030	M12X70	50	07170.120.070
M10X100	50	07170.100.100	M12X35	100	07170.120.035	M12X80	50	07170.120.080
			M12X40	100	07170.120.040	M12X100	50	07170.120.100
M12X20	100	07170.120.020	M12X50	100	07170.120.050	M12X120	25	07170.120.120

07065 Hexagon socket head cap screw A96A

Thread Metric thread
Material Steel
Class 8.8
Surface treatment Zinc flake Cr⁶⁺ free - ISO 10683 flZnnc

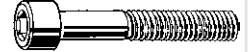

d x L	☒	Art.number	d x L	☒	Art.number	d x L	☒	Art.number
M3X10	200	07065.030.010	M6X20	200	07065.060.020	M10X35	100	07065.100.035
M3X12	200	07065.030.012	M6X25	200	07065.060.025	M10X40	100	07065.100.040
M3X16	200	07065.030.016	M6X30	200	07065.060.030	M10X45	100	07065.100.045
M3X20	200	07065.030.020	M6X35	200	07065.060.035	M10X50	100	07065.100.050
			M6X40	200	07065.060.040	M10X55	100	07065.100.055
M4X8	200	07065.040.008	M6X45	200	07065.060.045	M10X60	100	07065.100.060
M4X10	200	07065.040.010	M6X50	200	07065.060.050	M10X70	100	07065.100.070
M4X12	200	07065.040.012	M6X55	200	07065.060.055	M10X80	100	07065.100.080
M4X16	200	07065.040.016	M6X60	200	07065.060.060	M10X90	100	07065.100.090
M4X20	200	07065.040.020	M6X65	200	07065.060.065			
M4X25	200	07065.040.025	M6X70	200	07065.060.070	M12X20	100	07065.120.020
M4X30	200	07065.040.030	M6X80	200	07065.060.080	M12X25	100	07065.120.025
M4X40	200	07065.040.040	M6X90	100	07065.060.090	M12X30	100	07065.120.030
M4X50	200	07065.040.050				M12X35	100	07065.120.035
			M8X10	200	07065.080.010	M12X40	100	07065.120.040
M5X10	200	07065.050.010	M8X12	200	07065.080.012	M12X45	100	07065.120.045
M5X12	200	07065.050.012	M8X16	200	07065.080.016	M12X50	100	07065.120.050
M5X16	200	07065.050.016	M8X20	200	07065.080.020	M12X55	100	07065.120.055
M5X20	200	07065.050.020	M8X25	200	07065.080.025	M12X60	100	07065.120.060
M5X25	200	07065.050.025	M8X30	200	07065.080.030	M12X65	50	07065.120.065
M5X30	200	07065.050.030	M8X35	200	07065.080.035	M12X70	50	07065.120.070
M5X40	200	07065.050.040	M8X40	200	07065.080.040	M12X80	50	07065.120.080
M5X45	200	07065.050.045	M8X45	200	07065.080.045	M12X90	50	07065.120.090
M5X50	200	07065.050.050	M8X50	200	07065.080.050	M12X100	50	07065.120.100
M5X55	200	07065.050.055	M8X60	200	07065.080.060			
M5X60	200	07065.050.060	M8X70	200	07065.080.070	M16X40	50	07065.160.040
M5X70	200	07065.050.070	M8X80	200	07065.080.080	M16X50	50	07065.160.050
M5X80	200	07065.050.080	M8X90	100	07065.080.090	M16X60	50	07065.160.060
M5X90	200	07065.050.090				M16X70	25	07065.160.070
			M10X20	200	07065.100.020	M16X80	25	07065.160.080
M6X10	200	07065.060.010	M10X25	200	07065.100.025	M16X90	25	07065.160.090
M6X12	200	07065.060.012	M10X30	200	07065.100.030	M16X100	25	07065.160.100
M6X16	200	07065.060.016						

• A ISO 10683 Zinc Flake surface coating eliminates the possibilities of damage which can arise due to hydrogen embrittlement.

07015 Hexagon socket head cap screw D03A

Thread Metric thread
Material Steel
Class 10.9



d x L	☒	Art.number	d x L	☒	Art.number	d x L	☒	Art.number
M5X10	500	07015.050.010	M6X40	200	07015.060.040	M8X80	100	07015.080.080
M5X12	500	07015.050.012	M6X45	200	07015.060.045	M8X90	100	07015.080.090
M5X16	500	07015.050.016	M6X50	200	07015.060.050	M8X100	100	07015.080.100
M5X20	500	07015.050.020	M6X60	200	07015.060.060			
M5X25	500	07015.050.025	M6X70	200	07015.060.070	M10X20	200	07015.100.020
M5X30	500	07015.050.030	M6X80	100	07015.060.080	M10X25	200	07015.100.025
M5X35	200	07015.050.035	M6X90	100	07015.060.090	M10X30	200	07015.100.030
M5X40	200	07015.050.040	M6X140	50	07015.060.140	M10X35	100	07015.100.035
M5X45	200	07015.050.045				M10X40	100	07015.100.040
M5X50	200	07015.050.050	M8X16	200	07015.080.016	M10X45	100	07015.100.045
M5X60	200	07015.050.060	M8X20	200	07015.080.020	M10X50	100	07015.100.050
			M8X25	200	07015.080.025	M10X60	100	07015.100.060
M6X10	500	07015.060.010	M8X30	200	07015.080.030	M10X65	100	07015.100.065
M6X12	500	07015.060.012	M8X35	200	07015.080.035	M10X70	100	07015.100.070
M6X16	500	07015.060.016	M8X40	200	07015.080.040	M10X80	100	07015.100.080
M6X20	500	07015.060.020	M8X45	200	07015.080.045	M10X85	100	07015.100.085
M6X25	500	07015.060.025	M8X50	200	07015.080.050	M10X90	50	07015.100.090
M6X30	500	07015.060.030	M8X60	200	07015.080.060	M10X100	50	07015.100.100
M6X35	200	07015.060.035	M8X70	200	07015.080.070	M10X120	50	07015.100.120

07015 Hexagon socket head cap screw								
d x L	☒	Art.number	d x L	☒	Art.number	d x L	☒	Art.number
M10X130	50	07015.100.130	M16X40	50	07015.160.040	M20X120	25	07015.200.120
M12X25	100	07015.120.025	M16X50	50	07015.160.050	M20X130	25	07015.200.130
M12X30	100	07015.120.030	M16X60	50	07015.160.060	M20X140	25	07015.200.140
M12X35	100	07015.120.035	M16X70	25	07015.160.070	M20X190	10	07015.200.190
M12X40	100	07015.120.040	M16X80	25	07015.160.080	M20X230	5	07015.200.230
M12X50	100	07015.120.050	M16X90	25	07015.160.090			
M12X55	100	07015.120.055	M16X100	25	07015.160.100	M24X50	10	07015.240.050
M12X60	100	07015.120.060	M16X120	25	07015.160.120	M24X60	10	07015.240.060
M12X65	50	07015.120.065	M16X130	25	07015.160.130	M24X70	10	07015.240.070
M12X70	50	07015.120.070	M16X160	25	07015.160.160	M24X80	10	07015.240.080
M12X80	50	07015.120.080				M24X90	10	07015.240.090
M12X90	50	07015.120.090	M20X40	25	07015.200.040	M24X100	10	07015.240.100
M12X100	50	07015.120.100	M20X50	25	07015.200.050	M24X120	5	07015.240.120
M12X110	50	07015.120.110	M20X60	25	07015.200.060			
M12X120	50	07015.120.120	M20X70	25	07015.200.070	M27X90	10	07015.270.090
			M20X80	25	07015.200.080	M27X130	5	07015.270.130
M16X30	50	07015.160.030	M20X90	25	07015.200.090			
			M20X100	25	07015.200.100			

• Warning: electro-galvanizing of these products may cause hydrogen embrittlement.

07000 Hexagon socket head cap screw		D01A
Thread	Metric thread	
Material	Steel	
Class	12.9	
		

d x L	☒	Art.number	d x L	☒	Art.number	d x L	☒	Art.number
M1,6X3	100	07000.016.003	M4X12	200	07000.040.012	M5X120	100	07000.050.120
M1,6X4	100	07000.016.004	M4X14	200	07000.040.014	M5X125	100	07000.050.125
M1,6X5	100	07000.016.005	M4X16	200	07000.040.016	M5X130	50	07000.050.130
M1,6X6	100	07000.016.006	M4X18	200	07000.040.018	M5X135	200	07000.050.135
			M4X20	200	07000.040.020	M5X140	25	07000.050.140
M2X3	100	07000.020.003	M4X22	200	07000.040.022	M5X150	25	07000.050.150
M2X4	100	07000.020.004	M4X25	200	07000.040.025	M5X160	25	07000.050.160
M2X5	100	07000.020.005	M4X30	200	07000.040.030	M5X170	25	07000.050.170
M2X6	100	07000.020.006	M4X35	200	07000.040.035	M5X180	25	07000.050.180
M2X8	100	07000.020.008	M4X40	200	07000.040.040	M5X190	25	07000.050.190
M2X10	100	07000.020.010	M4X45	200	07000.040.045	M5X200	25	07000.050.200
M2X12	100	07000.020.012	M4X50	200	07000.040.050			
M2X14	100	07000.020.014	M4X55	200	07000.040.055	M6X6	500	07000.060.006
M2X16	100	07000.020.016	M4X60	200	07000.040.060	M6X8	200	07000.060.008
M2X20	100	07000.020.020	M4X65	200	07000.040.065	M6X10	200	07000.060.010
			M4X70	200	07000.040.070	M6X12	200	07000.060.012
M2,5X3	100	07000.025.003	M4X75	200	07000.040.075	M6X14	200	07000.060.014
M2,5X4	100	07000.025.004	M4X80	200	07000.040.080	M6X16	200	07000.060.016
M2,5X5	100	07000.025.005	M4X90	200	07000.040.090	M6X18	200	07000.060.018
M2,5X6	100	07000.025.006	M4X100	100	07000.040.100	M6X20	200	07000.060.020
M2,5X8	100	07000.025.008	M4X110	100	07000.040.110	M6X22	200	07000.060.022
M2,5X10	100	07000.025.010	M4X120	100	07000.040.120	M6X25	200	07000.060.025
M2,5X12	100	07000.025.012				M6X30	200	07000.060.030
M2,5X14	100	07000.025.014	M5X6	200	07000.050.006	M6X35	200	07000.060.035
M2,5X16	100	07000.025.016	M5X8	200	07000.050.008	M6X40	200	07000.060.040
M2,5X20	100	07000.025.020	M5X10	200	07000.050.010	M6X45	200	07000.060.045
M2,5X25	100	07000.025.025	M5X12	200	07000.050.012	M6X50	200	07000.060.050
			M5X14	200	07000.050.014	M6X55	200	07000.060.055
M3X4	200	07000.030.004	M5X16	200	07000.050.016	M6X60	200	07000.060.060
M3X6	200	07000.030.006	M5X18	200	07000.050.018	M6X65	200	07000.060.065
M3X8	200	07000.030.008	M5X20	200	07000.050.020	M6X70	200	07000.060.070
M3X10	200	07000.030.010	M5X22	200	07000.050.022	M6X75	200	07000.060.075
M3X12	200	07000.030.012	M5X25	200	07000.050.025	M6X80	200	07000.060.080
M3X14	200	07000.030.014	M5X30	200	07000.050.030	M6X85	100	07000.060.085
M3X16	200	07000.030.016	M5X35	200	07000.050.035	M6X90	100	07000.060.090
M3X18	200	07000.030.018	M5X40	200	07000.050.040	M6X95	100	07000.060.095
M3X20	200	07000.030.020	M5X45	200	07000.050.045	M6X100	100	07000.060.100
M3X22	200	07000.030.022	M5X50	200	07000.050.050	M6X110	50	07000.060.110
M3X25	200	07000.030.025	M5X55	200	07000.050.055	M6X115	50	07000.060.115
M3X30	200	07000.030.030	M5X60	200	07000.050.060	M6X120	50	07000.060.120
M3X35	200	07000.030.035	M5X65	200	07000.050.065	M6X125	50	07000.060.125
M3X40	200	07000.030.040	M5X70	200	07000.050.070	M6X130	50	07000.060.130
M3X45	200	07000.030.045	M5X75	200	07000.050.075	M6X135	50	07000.060.135
M3X50	200	07000.030.050	M5X80	200	07000.050.080	M6X140	25	07000.060.140
M3X60	200	07000.030.060	M5X85	200	07000.050.085	M6X150	25	07000.060.150
			M5X90	200	07000.050.090	M6X160	25	07000.060.160
M4X5	200	07000.040.005	M5X95	200	07000.050.095	M6X165	25	07000.060.165
M4X6	200	07000.040.006	M5X100	200	07000.050.100	M6X170	25	07000.060.170
M4X8	200	07000.040.008	M5X110	200	07000.050.110	M6X180	25	07000.060.180
M4X10	200	07000.040.010	M5X115	100	07000.050.115	M6X190	25	07000.060.190

07000 Hexagon socket head cap screw

2

d x L	☒	Art.number	d x L	☒	Art.number	d x L	☒	Art.number
M6X200	25	07000.060.200	M12X65	50	07000.120.065	M16X300	5	07000.160.300
M8X10	200	07000.080.010	M12X70	50	07000.120.070	M16X320	5	07000.160.320
M8X12	200	07000.080.012	M12X75	50	07000.120.075	M18X35	50	07000.180.035
M8X14	200	07000.080.014	M12X80	50	07000.120.080	M18X40	50	07000.180.040
M8X16	200	07000.080.016	M12X85	50	07000.120.085	M18X45	50	07000.180.045
M8X18	200	07000.080.018	M12X90	50	07000.120.090	M18X50	50	07000.180.050
M8X20	200	07000.080.020	M12X100	50	07000.120.100	M18X60	25	07000.180.060
M8X22	200	07000.080.022	M12X110	50	07000.120.110	M18X70	25	07000.180.070
M8X25	200	07000.080.025	M12X120	50	07000.120.120	M18X80	25	07000.180.080
M8X30	200	07000.080.030	M12X130	25	07000.120.130	M18X90	25	07000.180.090
M8X35	200	07000.080.035	M12X140	25	07000.120.140	M18X100	25	07000.180.100
M8X40	200	07000.080.040	M12X150	25	07000.120.150	M18X110	25	07000.180.110
M8X45	200	07000.080.045	M12X160	25	07000.120.160	M18X120	25	07000.180.120
M8X50	200	07000.080.050	M12X170	25	07000.120.170	M18X140	25	07000.180.140
M8X55	200	07000.080.055	M12X180	10	07000.120.180	M18X160	10	07000.180.160
M8X60	200	07000.080.060	M12X200	10	07000.120.200	M18X180	10	07000.180.180
M8X65	200	07000.080.065	M12X210	10	07000.120.210	M18X190	10	07000.180.190
M8X70	200	07000.080.070	M12X220	10	07000.120.220	M18X200	10	07000.180.200
M8X75	200	07000.080.075	M12X230	10	07000.120.230	M18X220	10	07000.180.220
M8X80	200	07000.080.080	M12X240	10	07000.120.240	M20X30	25	07000.200.030
M8X85	100	07000.080.085	M12X260	10	07000.120.260	M20X35	25	07000.200.035
M8X90	100	07000.080.090	M12X280	10	07000.120.280	M20X40	25	07000.200.040
M8X100	100	07000.080.100	M12X300	10	07000.120.300	M20X45	25	07000.200.045
M8X110	50	07000.080.110	M14X20	100	07000.140.020	M20X50	25	07000.200.050
M8X120	50	07000.080.120	M14X25	100	07000.140.025	M20X55	25	07000.200.055
M8X130	50	07000.080.130	M14X30	100	07000.140.030	M20X60	25	07000.200.060
M8X140	50	07000.080.140	M14X35	100	07000.140.035	M20X65	25	07000.200.065
M8X150	50	07000.080.150	M14X40	100	07000.140.040	M20X70	25	07000.200.070
M8X160	50	07000.080.160	M14X45	50	07000.140.045	M20X75	25	07000.200.075
M8X170	50	07000.080.170	M14X50	50	07000.140.050	M20X80	25	07000.200.080
M8X180	50	07000.080.180	M14X55	50	07000.140.055	M20X90	25	07000.200.090
M8X200	50	07000.080.200	M14X60	50	07000.140.060	M20X100	25	07000.200.100
M10X12	200	07000.100.012	M14X65	50	07000.140.065	M20X110	25	07000.200.110
M10X16	200	07000.100.016	M14X70	50	07000.140.070	M20X120	25	07000.200.120
M10X20	200	07000.100.020	M14X75	50	07000.140.075	M20X130	25	07000.200.130
M10X25	200	07000.100.025	M14X80	50	07000.140.080	M20X140	25	07000.200.140
M10X30	200	07000.100.030	M14X90	50	07000.140.090	M20X150	10	07000.200.150
M10X35	100	07000.100.035	M14X100	50	07000.140.100	M20X160	10	07000.200.160
M10X40	100	07000.100.040	M14X110	25	07000.140.110	M20X170	10	07000.200.170
M10X45	100	07000.100.045	M14X120	25	07000.140.120	M20X180	10	07000.200.180
M10X50	100	07000.100.050	M14X130	25	07000.140.130	M20X190	10	07000.200.190
M10X55	100	07000.100.055	M14X140	25	07000.140.140	M20X200	10	07000.200.200
M10X60	100	07000.100.060	M14X150	25	07000.140.150	M20X210	10	07000.200.210
M10X65	100	07000.100.065	M14X160	25	07000.140.160	M20X220	5	07000.200.220
M10X70	100	07000.100.070	M14X180	10	07000.140.180	M20X240	5	07000.200.240
M10X75	100	07000.100.075	M14X200	10	07000.140.200	M20X250	5	07000.200.250
M10X80	100	07000.100.080	M16X20	50	07000.160.020	M20X260	5	07000.200.260
M10X85	100	07000.100.085	M16X25	50	07000.160.025	M20X280	5	07000.200.280
M10X90	100	07000.100.090	M16X30	50	07000.160.030	M20X300	5	07000.200.300
M10X100	50	07000.100.100	M16X35	50	07000.160.035	M20X320	5	07000.200.320
M10X110	50	07000.100.110	M16X40	50	07000.160.040	M20X340	5	07000.200.340
M10X120	50	07000.100.120	M16X45	50	07000.160.045	M20X360	5	07000.200.360
M10X130	50	07000.100.130	M16X50	50	07000.160.050	M20X380	5	07000.200.380
M10X140	25	07000.100.140	M16X55	50	07000.160.055	M20X400	5	07000.200.400
M10X150	25	07000.100.150	M16X60	50	07000.160.060	M22X40	10	07000.220.040
M10X160	25	07000.100.160	M16X65	25	07000.160.065	M22X50	10	07000.220.050
M10X170	25	07000.100.170	M16X70	25	07000.160.070	M22X60	10	07000.220.060
M10X180	25	07000.100.180	M16X75	25	07000.160.075	M22X70	10	07000.220.070
M10X190	25	07000.100.190	M16X80	25	07000.160.080	M22X80	10	07000.220.080
M10X200	25	07000.100.200	M16X85	25	07000.160.085	M22X90	10	07000.220.090
M10X210	25	07000.100.210	M16X90	25	07000.160.090	M22X100	10	07000.220.100
M10X220	25	07000.100.220	M16X100	25	07000.160.100	M22X110	10	07000.220.110
M10X230	25	07000.100.230	M16X110	25	07000.160.110	M22X120	10	07000.220.120
M10X240	10	07000.100.240	M16X120	25	07000.160.120	M22X140	10	07000.220.140
M10X250	10	07000.100.250	M16X130	25	07000.160.130	M22X150	10	07000.220.150
M10X260	10	07000.100.260	M16X140	25	07000.160.140	M22X160	10	07000.220.160
M10X270	10	07000.100.270	M16X150	10	07000.160.150	M22X180	10	07000.220.180
M10X280	10	07000.100.280	M16X160	10	07000.160.160	M22X200	10	07000.220.200
M10X300	10	07000.100.300	M16X170	10	07000.160.170	M22X210	5	07000.220.210
M12X16	100	07000.120.016	M16X180	10	07000.160.180	M22X240	5	07000.220.240
M12X20	100	07000.120.020	M16X190	25	07000.160.190	M22X260	5	07000.220.260
M12X25	100	07000.120.025	M16X200	10	07000.160.200	M22X300	5	07000.220.300
M12X30	100	07000.120.030	M16X220	10	07000.160.220	M24X40	10	07000.240.040
M12X35	100	07000.120.035	M16X230	5	07000.160.230	M24X45	10	07000.240.045
M12X40	100	07000.120.040	M16X240	5	07000.160.240	M24X50	10	07000.240.050
M12X45	100	07000.120.045	M16X250	5	07000.160.250	M24X55	10	07000.240.055
M12X50	100	07000.120.050	M16X260	5	07000.160.260	M24X60	10	07000.240.060
M12X55	100	07000.120.055	M16X270	5	07000.160.270	M24X65	10	07000.240.065
M12X60	100	07000.120.060	M16X280	5	07000.160.280			

07000 Hexagon socket head cap screw ←

d x L	☒	Art.number	d x L	☒	Art.number	d x L	☒	Art.number
M24X70	10	07000.240.070	M27X220	2	07000.270.220	M36X100	1	07000.360.100
M24X75	10	07000.240.075	M27X240	2	07000.270.240	M36X120	1	07000.360.120
M24X80	10	07000.240.080	M27X260	2	07000.270.260	M36X140	1	07000.360.140
M24X85	10	07000.240.085	M27X300	2	07000.270.300	M36X160	1	07000.360.160
M24X90	10	07000.240.090				M36X180	1	07000.360.180
M24X100	10	07000.240.100	M30X60	2	07000.300.060	M36X200	1	07000.360.200
M24X110	10	07000.240.110	M30X70	2	07000.300.070	M36X220	1	07000.360.220
M24X120	5	07000.240.120	M30X80	2	07000.300.080	M36X240	1	07000.360.240
M24X130	5	07000.240.130	M30X90	2	07000.300.090	M36X260	1	07000.360.260
M24X140	5	07000.240.140	M30X100	2	07000.300.100	M36X280	1	07000.360.280
M24X150	5	07000.240.150	M30X110	2	07000.300.110	M36X300	1	07000.360.300
M24X160	5	07000.240.160	M30X120	2	07000.300.120	M36X400	1	07000.360.400
M24X170	5	07000.240.170	M30X130	2	07000.300.130	M36X420	1	07000.360.420
M24X180	5	07000.240.180	M30X140	2	07000.300.140			
M24X200	5	07000.240.200	M30X150	2	07000.300.150	M39X80	1	07000.390.080
M24X210	2	07000.240.210	M30X160	2	07000.300.160	M39X90	1	07000.390.090
M24X220	2	07000.240.220	M30X170	2	07000.300.170	M39X100	1	07000.390.100
M24X240	2	07000.240.240	M30X180	2	07000.300.180	M39X120	1	07000.390.120
M24X250	2	07000.240.250	M30X200	2	07000.300.200	M39X140	1	07000.390.140
M24X260	2	07000.240.260	M30X210	2	07000.300.210	M39X160	1	07000.390.160
M24X280	2	07000.240.280	M30X220	2	07000.300.220	M39X180	1	07000.390.180
M24X300	2	07000.240.300	M30X240	2	07000.300.240	M39X200	1	07000.390.200
M24X320	2	07000.240.320	M30X250	2	07000.300.250			
M24X340	2	07000.240.340	M30X260	2	07000.300.260	M42X90	1	07000.420.090
M24X360	2	07000.240.360	M30X280	2	07000.300.280	M42X100	1	07000.420.100
M24X380	2	07000.240.380	M30X300	2	07000.300.300	M42X120	1	07000.420.120
M24X400	2	07000.240.400	M30X400	1	07000.300.400	M42X140	1	07000.420.140
						M42X160	1	07000.420.160
M27X50	2	07000.270.050	M33X70	2	07000.330.070	M42X180	1	07000.420.180
M27X60	2	07000.270.060	M33X80	2	07000.330.080	M42X200	1	07000.420.200
M27X70	2	07000.270.070	M33X90	2	07000.330.090	M42X240	1	07000.420.240
M27X75	2	07000.270.075	M33X100	2	07000.330.100	M42X260	1	07000.420.260
M27X80	2	07000.270.080	M33X120	2	07000.330.120	M42X300	1	07000.420.300
M27X90	2	07000.270.090	M33X130	2	07000.330.130			
M27X100	2	07000.270.100	M33X140	2	07000.330.140	M48X120	1	07000.480.120
M27X120	2	07000.270.120	M33X160	2	07000.330.160	M48X140	1	07000.480.140
M27X130	2	07000.270.130	M33X180	2	07000.330.180	M48X150	1	07000.480.150
M27X140	2	07000.270.140	M33X200	2	07000.330.200	M48X160	1	07000.480.160
M27X150	2	07000.270.150	M33X260	1	07000.330.260	M48X180	1	07000.480.180
M27X160	2	07000.270.160	M33X280	1	07000.330.280	M48X200	1	07000.480.200
M27X170	2	07000.270.170				M48X260	1	07000.480.260
M27X180	2	07000.270.180	M36X60	1	07000.360.060	M48X300	1	07000.480.300
M27X190	2	07000.270.190	M36X80	1	07000.360.080			
M27X200	2	07000.270.200	M36X90	1	07000.360.090			

• Warning: electro-galvanizing of these products may cause hydrogen embrittlement.

07025 Hexagon socket head cap screw D95A

Thread Metric thread
Material Steel
Class 12.9
Surface treatment Zinc flake Cr⁶⁺ free - ISO 10683 flZnnc

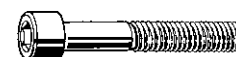

d x L	☒	Art.number	d x L	☒	Art.number	d x L	☒	Art.number
M3X6	200	07025.030.006	M5X12	200	07025.050.012	M6X55	200	07025.060.055
M3X8	200	07025.030.008	M5X16	200	07025.050.016	M6X60	200	07025.060.060
M3X10	200	07025.030.010	M5X20	200	07025.050.020	M6X65	200	07025.060.065
M3X12	200	07025.030.012	M5X25	200	07025.050.025	M6X70	200	07025.060.070
M3X16	200	07025.030.016	M5X30	200	07025.050.030	M6X75	200	07025.060.075
M3X20	200	07025.030.020	M5X35	200	07025.050.035	M6X80	200	07025.060.080
M3X25	200	07025.030.025	M5X40	200	07025.050.040	M6X100	100	07025.060.100
M3X30	200	07025.030.030	M5X45	200	07025.050.045	M6X130	50	07025.060.130
M3X35	200	07025.030.035	M5X50	200	07025.050.050	M6X140	25	07025.060.140
			M5X60	200	07025.050.060			
M4X6	200	07025.040.006	M5X70	200	07025.050.070	M8X10	200	07025.080.010
M4X8	200	07025.040.008	M5X100	200	07025.050.100	M8X12	200	07025.080.012
M4X10	200	07025.040.010				M8X16	200	07025.080.016
M4X12	200	07025.040.012	M6X10	200	07025.060.010	M8X20	200	07025.080.020
M4X16	200	07025.040.016	M6X12	200	07025.060.012	M8X25	200	07025.080.025
M4X20	200	07025.040.020	M6X16	200	07025.060.016	M8X30	200	07025.080.030
M4X25	200	07025.040.025	M6X18	200	07025.060.018	M8X35	200	07025.080.035
M4X30	200	07025.040.030	M6X20	200	07025.060.020	M8X40	200	07025.080.040
M4X45	200	07025.040.045	M6X25	200	07025.060.025	M8X45	200	07025.080.045
M4X50	200	07025.040.050	M6X30	200	07025.060.030	M8X50	200	07025.080.050
			M6X35	200	07025.060.035	M8X55	200	07025.080.055
M5X6	200	07025.050.006	M6X40	200	07025.060.040	M8X60	200	07025.080.060
M5X8	200	07025.050.008	M6X45	200	07025.060.045	M8X70	200	07025.080.070
M5X10	200	07025.050.010	M6X50	200	07025.060.050	M8X80	200	07025.080.080

07025 Hexagon socket head cap screw ←

d x L	☒	Art.number	d x L	☒	Art.number	d x L	☒	Art.number
M8X90	100	07025.080.090	M12X35	100	07025.120.035	M16X55	50	07025.160.055
M8X100	100	07025.080.100	M12X40	100	07025.120.040	M16X60	50	07025.160.060
M8X110	50	07025.080.110	M12X45	100	07025.120.045	M16X70	25	07025.160.070
M8X140	50	07025.080.140	M12X50	100	07025.120.050	M16X75	25	07025.160.075
			M12X55	100	07025.120.055	M16X80	25	07025.160.080
M10X12	200	07025.100.012	M12X60	100	07025.120.060	M16X90	25	07025.160.090
M10X16	200	07025.100.016	M12X70	50	07025.120.070	M16X100	25	07025.160.100
M10X20	200	07025.100.020	M12X80	50	07025.120.080	M16X110	25	07025.160.110
M10X25	200	07025.100.025	M12X90	50	07025.120.090	M16X120	25	07025.160.120
M10X30	200	07025.100.030	M12X100	50	07025.120.100			
M10X35	100	07025.100.035	M12X120	50	07025.120.120	M20X40	25	07025.200.040
M10X40	200	07025.100.040	M12X140	25	07025.120.140	M20X50	25	07025.200.050
M10X45	100	07025.100.045				M20X60	25	07025.200.060
M10X50	100	07025.100.050	M14X30	100	07025.140.030	M20X70	25	07025.200.070
M10X55	100	07025.100.055	M14X40	100	07025.140.040	M20X80	25	07025.200.080
M10X60	100	07025.100.060	M14X50	50	07025.140.050	M20X90	25	07025.200.090
M10X65	100	07025.100.065	M14X60	50	07025.140.060	M20X100	25	07025.200.100
M10X70	100	07025.100.070	M14X70	50	07025.140.070	M20X120	25	07025.200.120
M10X80	100	07025.100.080	M14X80	50	07025.140.080			
M10X90	100	07025.100.090	M14X90	50	07025.140.090	M24X40	10	07025.240.040
M10X100	100	07025.100.100	M14X100	50	07025.140.100	M24X50	10	07025.240.050
M10X120	50	07025.100.120				M24X60	10	07025.240.060
M10X150	25	07025.100.150	M16X25	50	07025.160.025	M24X70	10	07025.240.070
M10X160	25	07025.100.160	M16X30	50	07025.160.030	M24X80	10	07025.240.080
			M16X35	50	07025.160.035	M24X90	10	07025.240.090
M12X20	100	07025.120.020	M16X40	50	07025.160.040	M24X100	10	07025.240.100
M12X25	100	07025.120.025	M16X45	50	07025.160.045	M24X120	5	07025.240.120
M12X30	100	07025.120.030	M16X50	50	07025.160.050	M24X140	5	07025.240.140

• A ISO 10683 Zinc Flake surface coating eliminates the possibilities of damage which can arise due to hydrogen embrittlement.

51050 Hexagon socket head cap screw Q05A

Thread Metric thread
Material Stainless steel A2
Class 70



d x L	☒	Art.number	d x L	☒	Art.number	d x L	☒	Art.number
M1,6X3*	500	51050.016.003	M2,5X40*	500	51050.025.040	M4X50	200	51050.040.050
M1,6X4*	500	51050.016.004				M4X55	100	51050.040.055
M1,6X5*	500	51050.016.005	M3X3*	1000	51050.030.003	M4X60	200	51050.040.060
M1,6X6*	500	51050.016.006	M3X4	1000	51050.030.004	M4X65*	100	51050.040.065
M1,6X8*	500	51050.016.008	M3X5	200	51050.030.005	M4X70*	100	51050.040.070
M1,6X10*	500	51050.016.010	M3X6	200	51050.030.006	M4X75*	100	51050.040.075
M1,6X12*	500	51050.016.012	M3X8	200	51050.030.008	M4X80	100	51050.040.080
M1,6X14*	500	51050.016.014	M3X10	200	51050.030.010	M4X90	100	51050.040.090
M1,6X16*	500	51050.016.016	M3X12	200	51050.030.012	M4X100*	100	51050.040.100
M1,6X18*	500	51050.016.018	M3X14*	1000	51050.030.014			
M1,6X20*	500	51050.016.020	M3X16	200	51050.030.016	M5X5*	500	51050.050.005
			M3X18	200	51050.030.018	M5X6	200	51050.050.006
M2X3*	500	51050.020.003	M3X20	200	51050.030.020	M5X8	200	51050.050.008
M2X4	100	51050.020.004	M3X22*	1000	51050.030.022	M5X10	200	51050.050.010
M2X5	100	51050.020.005	M3X25	200	51050.030.025	M5X12	200	51050.050.012
M2X6	100	51050.020.006	M3X30	200	51050.030.030	M5X14*	500	51050.050.014
M2X8	100	51050.020.008	M3X35	200	51050.030.035	M5X16	200	51050.050.016
M2X10	100	51050.020.010	M3X40	200	51050.030.040	M5X18*	500	51050.050.018
M2X12	100	51050.020.012	M3X45	200	51050.030.045	M5X20	200	51050.050.020
M2X14*	500	51050.020.014	M3X50*	200	51050.030.050	M5X22*	500	51050.050.022
M2X16	100	51050.020.016	M3X55*	200	51050.030.055	M5X25	200	51050.050.025
M2X18*	500	51050.020.018	M3X60	200	51050.030.060	M5X30	200	51050.050.030
M2X22*	500	51050.020.022	M3X65*	200	51050.030.065	M5X35	200	51050.050.035
M2X25*	500	51050.020.025	M3X70*	200	51050.030.070	M5X40	200	51050.050.040
M2X30*	500	51050.020.030				M5X45	200	51050.050.045
			M4X4*	1000	51050.040.004	M5X50	200	51050.050.050
M2,5X3	500	51050.025.003	M4X5*	1000	51050.040.005	M5X55	100	51050.050.055
M2,5X4	500	51050.025.004	M4X6	200	51050.040.006	M5X60	200	51050.050.060
M2,5X5	100	51050.025.005	M4X8	200	51050.040.008	M5X65	100	51050.050.065
M2,5X6	100	51050.025.006	M4X10	200	51050.040.010	M5X70	200	51050.050.070
M2,5X8	100	51050.025.008	M4X12	200	51050.040.012	M5X75*	100	51050.050.075
M2,5X10	100	51050.025.010	M4X14*	1000	51050.040.014	M5X80	200	51050.050.080
M2,5X12	100	51050.025.012	M4X16	200	51050.040.016	M5X85*	100	51050.050.085
M2,5X14*	500	51050.025.014	M4X18*	1000	51050.040.018	M5X90	200	51050.050.090
M2,5X16	100	51050.025.016	M4X20	200	51050.040.020	M5X95*	100	51050.050.095
M2,5X18*	500	51050.025.018	M4X22*	500	51050.040.022	M5X100	200	51050.050.100
M2,5X20	100	51050.025.020	M4X25	200	51050.040.025	M5X110*	100	51050.050.110
M2,5X22*	500	51050.025.022	M4X30	200	51050.040.030	M5X120	100	51050.050.120
M2,5X25*	500	51050.025.025	M4X35	200	51050.040.035	M5X130*	100	51050.050.130
M2,5X30*	500	51050.025.030	M4X40	200	51050.040.040	M5X140*	100	51050.050.140
M2,5X35*	500	51050.025.035	M4X45	200	51050.040.045			

51050 Hexagon socket head cap screw ←									
d x L	☒	Art.number	d x L	☒	Art.number	d x L	☒	Art.number	
M6X6*	500	51050.060.006	M10X12	200	51050.100.012	M14X40	25	51050.140.040	
M6X8	200	51050.060.008	M10X14*	100	51050.100.014	M14X45*	50	51050.140.045	
M6X10	200	51050.060.010	M10X16	100	51050.100.016	M14X50	25	51050.140.050	
M6X12	200	51050.060.012	M10X18*	100	51050.100.018	M14X55*	50	51050.140.055	
M6X14	200	51050.060.014	M10X20	100	51050.100.020	M14X60	25	51050.140.060	
M6X16	200	51050.060.016	M10X22*	100	51050.100.022	M14X65*	50	51050.140.065	
M6X18	200	51050.060.018	M10X25	100	51050.100.025	M14X70*	50	51050.140.070	
M6X20	200	51050.060.020	M10X30	100	51050.100.030	M14X75*	50	51050.140.075	
M6X22	200	51050.060.022	M10X35	100	51050.100.035	M14X80	25	51050.140.080	
M6X25	200	51050.060.025	M10X40	100	51050.100.040	M14X85*	50	51050.140.085	
M6X30	200	51050.060.030	M10X45	100	51050.100.045	M14X90*	50	51050.140.090	
M6X35	200	51050.060.035	M10X50	100	51050.100.050	M14X95*	50	51050.140.095	
M6X40	200	51050.060.040	M10X55	100	51050.100.055	M14X100*	50	51050.140.100	
M6X45	200	51050.060.045	M10X60	100	51050.100.060	M14X110*	25	51050.140.110	
M6X50	200	51050.060.050	M10X65*	50	51050.100.065	M14X120*	25	51050.140.120	
M6X55	200	51050.060.055	M10X70	100	51050.100.070	M14X130*	25	51050.140.130	
M6X60	200	51050.060.060	M10X75	50	51050.100.075	M14X140*	25	51050.140.140	
M6X65	200	51050.060.065	M10X80	100	51050.100.080	M14X150*	25	51050.140.150	
M6X70	200	51050.060.070	M10X85*	50	51050.100.085	M14X160*	25	51050.140.160	
M6X75*	100	51050.060.075	M10X90	100	51050.100.090	M14X170*	25	51050.140.170	
M6X80	200	51050.060.080	M10X95*	50	51050.100.095	M14X180*	25	51050.140.180	
M6X85*	100	51050.060.085	M10X100	100	51050.100.100	M14X200*	25	51050.140.200	
M6X90	200	51050.060.090	M10X110	50	51050.100.110				
M6X95*	100	51050.060.095	M10X120	50	51050.100.120	M16X20*	25	51050.160.020	
M6X100	200	51050.060.100	M10X130	50	51050.100.130	M16X25	25	51050.160.025	
M6X110	100	51050.060.110	M10X140	50	51050.100.140	M16X30	25	51050.160.030	
M6X120*	100	51050.060.120	M10X150	50	51050.100.150	M16X35	25	51050.160.035	
M6X130*	100	51050.060.130	M10X160	25	51050.100.160	M16X40	25	51050.160.040	
M6X140	100	51050.060.140	M10X170*	25	51050.100.170	M16X45	25	51050.160.045	
M6X150	100	51050.060.150	M10X180*	25	51050.100.180	M16X50	25	51050.160.050	
M6X160*	100	51050.060.160	M10X190*	25	51050.100.190	M16X55	25	51050.160.055	
M6X170*	100	51050.060.170	M10X200*	25	51050.100.200	M16X60	25	51050.160.060	
M6X180*	100	51050.060.180	M10X210*	25	51050.100.210	M16X65*	25	51050.160.065	
M6X190*	100	51050.060.190	M10X220*	25	51050.100.220	M16X70	25	51050.160.070	
M6X200*	100	51050.060.200	M10X230*	25	51050.100.230	M16X75*	25	51050.160.075	
M6X220*	100	51050.060.220	M10X240*	25	51050.100.240	M16X80	25	51050.160.080	
			M10X250*	25	51050.100.250	M16X85*	25	51050.160.085	
M8X8*	500	51050.080.008	M10X260*	25	51050.100.260	M16X90	10	51050.160.090	
M8X10	200	51050.080.010	M10X280*	25	51050.100.280	M16X95*	25	51050.160.095	
M8X12	200	51050.080.012	M10X300*	25	51050.100.300	M16X100	10	51050.160.100	
M8X14*	200	51050.080.014				M16X110	10	51050.160.110	
M8X16	200	51050.080.016	M12X16	50	51050.120.016	M16X120	10	51050.160.120	
M8X18*	200	51050.080.018	M12X20	100	51050.120.020	M16X130	10	51050.160.130	
M8X20	200	51050.080.020	M12X22*	50	51050.120.022	M16X140	10	51050.160.140	
M8X22	200	51050.080.022	M12X25	100	51050.120.025	M16X150	10	51050.160.150	
M8X25	200	51050.080.025	M12X30	100	51050.120.030	M16X160*	25	51050.160.160	
M8X30	200	51050.080.030	M12X35	100	51050.120.035	M16X170*	25	51050.160.170	
M8X35	200	51050.080.035	M12X40	100	51050.120.040	M16X180*	25	51050.160.180	
M8X40	200	51050.080.040	M12X45	100	51050.120.045	M16X190*	25	51050.160.190	
M8X45	200	51050.080.045	M12X50	100	51050.120.050	M16X200*	25	51050.160.200	
M8X50	200	51050.080.050	M12X55	100	51050.120.055				
M8X55	200	51050.080.055	M12X60	100	51050.120.060	M18X30*	25	51050.180.030	
M8X60	200	51050.080.060	M12X65*	50	51050.120.065	M18X35*	25	51050.180.035	
M8X65	100	51050.080.065	M12X70	100	51050.120.070	M18X40*	25	51050.180.040	
M8X70	200	51050.080.070	M12X75	25	51050.120.075	M18X45*	25	51050.180.045	
M8X75*	100	51050.080.075	M12X80	100	51050.120.080	M18X50*	25	51050.180.050	
M8X80	200	51050.080.080	M12X85	25	51050.120.085	M18X55*	25	51050.180.055	
M8X85*	100	51050.080.085	M12X90	100	51050.120.090	M18X60*	25	51050.180.060	
M8X90	200	51050.080.090	M12X95*	25	51050.120.095	M18X65*	25	51050.180.065	
M8X95*	100	51050.080.095	M12X100	100	51050.120.100	M18X70*	25	51050.180.070	
M8X100	200	51050.080.100	M12X110	50	51050.120.110	M18X75*	25	51050.180.075	
M8X110	100	51050.080.110	M12X120	50	51050.120.120	M18X80*	25	51050.180.080	
M8X120	100	51050.080.120	M12X130	25	51050.120.130	M18X85*	25	51050.180.085	
M8X130	50	51050.080.130	M12X140*	25	51050.120.140	M18X90*	25	51050.180.090	
M8X140	50	51050.080.140	M12X150	25	51050.120.150	M18X100*	25	51050.180.100	
M8X150	50	51050.080.150	M12X160	50	51050.120.160	M18X110*	25	51050.180.110	
M8X160	50	51050.080.160	M12X170*	25	51050.120.170	M18X120*	25	51050.180.120	
M8X170*	25	51050.080.170	M12X180*	25	51050.120.180	M18X130*	25	51050.180.130	
M8X180*	25	51050.080.180	M12X190*	25	51050.120.190	M18X140*	25	51050.180.140	
M8X190*	25	51050.080.190	M12X200*	25	51050.120.200	M18X150*	25	51050.180.150	
M8X200*	25	51050.080.200	M12X210*	25	51050.120.210				
M8X210*	25	51050.080.210	M12X220*	25	51050.120.220	M20X30*	25	51050.200.030	
M8X220*	25	51050.080.220	M12X230*	25	51050.120.230	M20X35*	25	51050.200.035	
M8X230*	25	51050.080.230	M12X240*	25	51050.120.240	M20X40	25	51050.200.040	
M8X240*	25	51050.080.240	M12X260*	25	51050.120.260	M20X45	25	51050.200.045	
M8X250*	25	51050.080.250	M12X270*	25	51050.120.270	M20X50	25	51050.200.050	
M8X260*	25	51050.080.260	M12X300*	25	51050.120.300	M20X55	25	51050.200.055	
M8X270*	25	51050.080.270				M20X60	25	51050.200.060	
M8X280*	25	51050.080.280	M14X20	25	51050.140.020	M20X65*	25	51050.200.065	
M8X290*	25	51050.080.290	M14X25*	100	51050.140.025	M20X70	25	51050.200.070	
M8X300*	25	51050.080.300	M14X30	25	51050.140.030	M20X75*	25	51050.200.075	
			M14X35*	50	51050.140.035	M20X80	10	51050.200.080	

51050 Hexagon socket head cap screw ←

d x L	☒	Art.number	d x L	☒	Art.number	d x L	☒	Art.number
M20X85*	25	51050.200.085	M22X140*	25	51050.220.140	M27X60*	10	51050.270.060
M20X90	10	51050.200.090				M27X70*	10	51050.270.070
M20X100	10	51050.200.100	M24X40*	10	51050.240.040	M27X80*	10	51050.270.080
M20X110	10	51050.200.110	M24X45	10	51050.240.045	M27X90*	10	51050.270.090
M20X120	10	51050.200.120	M24X50	10	51050.240.050	M27X100*	10	51050.270.100
M20X130*	25	51050.200.130	M24X55*	10	51050.240.055	M27X110*	10	51050.270.110
M20X140	10	51050.200.140	M24X60	10	51050.240.060	M27X120*	10	51050.270.120
M20X150	10	51050.200.150	M24X65*	10	51050.240.065	M27X130*	10	51050.270.130
M20X160*	25	51050.200.160	M24X70	10	51050.240.070	M27X150*	10	51050.270.150
M20X170*	25	51050.200.170	M24X75*	10	51050.240.075			
M20X180*	25	51050.200.180	M24X80	10	51050.240.080	M30X50*	10	51050.300.050
M20X190*	25	51050.200.190	M24X85*	10	51050.240.085	M30X60*	10	51050.300.060
M20X200*	25	51050.200.200	M24X90	10	51050.240.090	M30X65*	10	51050.300.065
M20X210*	25	51050.200.210	M24X95*	10	51050.240.095	M30X70*	10	51050.300.070
M20X220*	25	51050.200.220	M24X100	10	51050.240.100	M30X75*	10	51050.300.075
M20X240*	25	51050.200.240	M24X110	10	51050.240.110	M30X80*	10	51050.300.080
M20X260*	25	51050.200.260	M24X120	10	51050.240.120	M30X90*	10	51050.300.090
			M24X130*	10	51050.240.130	M30X100*	10	51050.300.100
M22X40*	25	51050.220.040	M24X140	10	51050.240.140	M30X110*	10	51050.300.110
M22X50*	25	51050.220.050	M24X150	10	51050.240.150	M30X120*	10	51050.300.120
M22X55*	25	51050.220.055	M24X160*	10	51050.240.160	M30X130*	10	51050.300.130
M22X60*	25	51050.220.060	M24X170*	10	51050.240.170	M30X140*	10	51050.300.140
M22X65*	25	51050.220.065	M24X180*	10	51050.240.180	M30X160*	10	51050.300.160
M22X70*	25	51050.220.070	M24X200*	10	51050.240.200	M30X170*	10	51050.300.170
M22X75*	25	51050.220.075	M24X210*	10	51050.240.210	M30X180*	10	51050.300.180
M22X80*	25	51050.220.080	M24X220*	10	51050.240.220	M30X200*	10	51050.300.200
M22X100*	25	51050.220.100	M24X250*	10	51050.240.250	M30X300*	10	51050.300.300
M22X110*	25	51050.220.110	M24X260*	10	51050.240.260			
M22X130*	25	51050.220.130						

* Sizes with a diameter > M24 and sizes with a length > 8xd are minimal property class 50.

55050 Hexagon socket head cap screw Q45A

Thread Metric thread
Material Stainless steel A4
Class 70

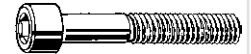

d x L	☒	Art.number	d x L	☒	Art.number	d x L	☒	Art.number
M1,6X3*	500	55050.016.003	M2,5X30*	500	55050.025.030	M4X30	200	55050.040.030
M1,6X4	100	55050.016.004	M2,5X35*	500	55050.025.035	M4X35	200	55050.040.035
M1,6X5	100	55050.016.005	M2,5X40*	500	55050.025.040	M4X40	200	55050.040.040
M1,6X6	100	55050.016.006				M4X45	200	55050.040.045
M1,6X8*	500	55050.016.008	M3X3*	1000	55050.030.003	M4X50	200	55050.040.050
M1,6X10*	500	55050.016.010	M3X4*	1000	55050.030.004	M4X55*	200	55050.040.055
M1,6X12*	500	55050.016.012	M3X5*	1000	55050.030.005	M4X60*	100	55050.040.060
M1,6X14*	500	55050.016.014	M3X6	200	55050.030.006	M4X65*	100	55050.040.065
M1,6X16*	500	55050.016.016	M3X8	200	55050.030.008	M4X70	100	55050.040.070
M1,6X18*	500	55050.016.018	M3X10	200	55050.030.010	M4X75*	100	55050.040.075
M1,6X20*	500	55050.016.020	M3X12	200	55050.030.012	M4X80*	100	55050.040.080
			M3X14*	1000	55050.030.014	M4X90*	100	55050.040.090
M2X3*	500	55050.020.003	M3X16	200	55050.030.016	M4X100*	100	55050.040.100
M2X4*	500	55050.020.004	M3X18*	1000	55050.030.018			
M2X5	100	55050.020.005	M3X20	200	55050.030.020	M5X5*	500	55050.050.005
M2X6	100	55050.020.006	M3X22*	1000	55050.030.022	M5X6	500	55050.050.006
M2X8	100	55050.020.008	M3X25	200	55050.030.025	M5X8	200	55050.050.008
M2X10	100	55050.020.010	M3X30	200	55050.030.030	M5X10	200	55050.050.010
M2X12	100	55050.020.012	M3X35	200	55050.030.035	M5X12	200	55050.050.012
M2X14*	500	55050.020.014	M3X40	200	55050.030.040	M5X14	500	55050.050.014
M2X16	100	55050.020.016	M3X45*	500	55050.030.045	M5X16	200	55050.050.016
M2X18*	500	55050.020.018	M3X50	200	55050.030.050	M5X18*	500	55050.050.018
M2X20	100	55050.020.020	M3X55*	200	55050.030.055	M5X20	200	55050.050.020
M2X25*	500	55050.020.025	M3X60*	200	55050.030.060	M5X22*	500	55050.050.022
M2X30*	500	55050.020.030	M3X65*	200	55050.030.065	M5X25	200	55050.050.025
			M3X70*	200	55050.030.070	M5X30	200	55050.050.030
M2,5X3*	500	55050.025.003				M5X35	200	55050.050.035
M2,5X4*	500	55050.025.004	M4X4*	1000	55050.040.004	M5X40	200	55050.050.040
M2,5X5	100	55050.025.005	M4X5*	1000	55050.040.005	M5X45	200	55050.050.045
M2,5X6	100	55050.025.006	M4X6	200	55050.040.006	M5X50	200	55050.050.050
M2,5X8	100	55050.025.008	M4X8	200	55050.040.008	M5X55	200	55050.050.055
M2,5X10	100	55050.025.010	M4X10	200	55050.040.010	M5X60	200	55050.050.060
M2,5X12	100	55050.025.012	M4X12	200	55050.040.012	M5X65*	100	55050.050.065
M2,5X14*	500	55050.025.014	M4X14*	1000	55050.040.014	M5X70	200	55050.050.070
M2,5X16	100	55050.025.016	M4X16	200	55050.040.016	M5X75*	100	55050.050.075
M2,5X18*	500	55050.025.018	M4X18*	1000	55050.040.018	M5X80	200	55050.050.080
M2,5X20	100	55050.025.020	M4X20	200	55050.040.020	M5X85*	100	55050.050.085
M2,5X22*	500	55050.025.022	M4X22*	500	55050.040.022	M5X90*	100	55050.050.090
M2,5X25*	500	55050.025.025	M4X25	200	55050.040.025	M5X95*	100	55050.050.095

55050 Hexagon socket head cap screw								
d x L	☒	Art.number	d x L	☒	Art.number	d x L	☒	Art.number
M5X100*	100	55050.050.100	M8X270*	25	55050.080.270	M14X25	25	55050.140.025
M5X110*	100	55050.050.110	M8X280*	25	55050.080.280	M14X30	25	55050.140.030
M5X120*	100	55050.050.120	M8X290*	25	55050.080.290	M14X35*	50	55050.140.035
M5X130*	100	55050.050.130	M8X300*	25	55050.080.300	M14X40	25	55050.140.040
M5X140*	100	55050.050.140				M14X45	50	55050.140.045
M6X6	500	55050.060.006	M10X12	100	55050.100.012	M14X50	25	55050.140.050
M6X8	200	55050.060.008	M10X14*	100	55050.100.014	M14X55*	50	55050.140.055
M6X10	200	55050.060.010	M10X16	100	55050.100.016	M14X60	25	55050.140.060
M6X12	200	55050.060.012	M10X18*	100	55050.100.018	M14X65*	50	55050.140.065
M6X14	200	55050.060.014	M10X20	100	55050.100.020	M14X70*	50	55050.140.070
M6X16	200	55050.060.016	M10X22*	100	55050.100.022	M14X75*	50	55050.140.075
M6X18*	200	55050.060.018	M10X25	100	55050.100.025	M14X80	25	55050.140.080
M6X20	200	55050.060.020	M10X30	100	55050.100.030	M14X85*	50	55050.140.085
M6X22*	200	55050.060.022	M10X35	100	55050.100.035	M14X90	10	55050.140.090
M6X25	200	55050.060.025	M10X40	100	55050.100.040	M14X95*	50	55050.140.095
M6X30	200	55050.060.030	M10X45	100	55050.100.045	M14X100	10	55050.140.100
M6X35	200	55050.060.035	M10X50	100	55050.100.050	M14X110	10	55050.140.110
M6X40	200	55050.060.040	M10X55	100	55050.100.055	M14X120	10	55050.140.120
M6X45	200	55050.060.045	M10X60	100	55050.100.060	M14X130*	25	55050.140.130
M6X50	200	55050.060.050	M10X65	50	55050.100.065	M14X140*	25	55050.140.140
M6X55	200	55050.060.055	M10X70	100	55050.100.070	M14X150*	25	55050.140.150
M6X60	200	55050.060.060	M10X75*	50	55050.100.075			
M6X65	100	55050.060.065	M10X80	100	55050.100.080	M16X20	25	55050.160.020
M6X70	200	55050.060.070	M10X85*	50	55050.100.085	M16X25	25	55050.160.025
M6X75*	100	55050.060.075	M10X90	100	55050.100.090	M16X30	25	55050.160.030
M6X80	200	55050.060.080	M10X95*	50	55050.100.095	M16X35	25	55050.160.035
M6X85*	100	55050.060.085	M10X100	100	55050.100.100	M16X40	25	55050.160.040
M6X90	200	55050.060.090	M10X110	50	55050.100.110	M16X45	25	55050.160.045
M6X95*	100	55050.060.095	M10X120	50	55050.100.120	M16X50	25	55050.160.050
M6X100	200	55050.060.100	M10X130	50	55050.100.130	M16X55	25	55050.160.055
M6X110	100	55050.060.110	M10X140	50	55050.100.140	M16X60	25	55050.160.060
M6X120	100	55050.060.120	M10X150	50	55050.100.150	M16X65*	25	55050.160.065
M6X130	100	55050.060.130	M10X160*	50	55050.100.160	M16X70	25	55050.160.070
M6X140	100	55050.060.140	M10X170*	25	55050.100.170	M16X75*	25	55050.160.075
M6X150	100	55050.060.150	M10X180*	25	55050.100.180	M16X80	25	55050.160.080
M6X160*	100	55050.060.160	M10X190*	25	55050.100.190	M16X85*	25	55050.160.085
M6X170*	100	55050.060.170	M10X200*	25	55050.100.200	M16X90	10	55050.160.090
M6X180*	100	55050.060.180	M10X210*	25	55050.100.210	M16X95*	25	55050.160.095
M6X190*	100	55050.060.190	M10X220*	25	55050.100.220	M16X100	10	55050.160.100
M6X200*	100	55050.060.200	M10X230*	25	55050.100.230	M16X110	10	55050.160.110
			M10X240*	25	55050.100.240	M16X120	10	55050.160.120
			M10X250*	25	55050.100.250	M16X130	10	55050.160.130
			M10X280*	25	55050.100.280	M16X140	10	55050.160.140
M8X8*	500	55050.080.008				M16X150	10	55050.160.150
M8X10	500	55050.080.010	M12X16*	50	55050.120.016	M16X160*	25	55050.160.160
M8X12	200	55050.080.012	M12X20	100	55050.120.020	M16X170*	25	55050.160.170
M8X14*	200	55050.080.014	M12X22*	50	55050.120.022	M16X180*	25	55050.160.180
M8X16	200	55050.080.016	M12X25	100	55050.120.025	M16X190*	25	55050.160.190
M8X18*	200	55050.080.018	M12X30	100	55050.120.030	M16X200*	25	55050.160.200
M8X20	200	55050.080.020	M12X35	100	55050.120.035			
M8X22*	200	55050.080.022	M12X40	100	55050.120.040	M18X30*	25	55050.180.030
M8X25	200	55050.080.025	M12X45	100	55050.120.045	M18X35*	25	55050.180.035
M8X30	200	55050.080.030	M12X50	100	55050.120.050	M18X40*	25	55050.180.040
M8X35	200	55050.080.035	M12X55	100	55050.120.055	M18X45*	25	55050.180.045
M8X40	200	55050.080.040	M12X60	100	55050.120.060	M18X50*	25	55050.180.050
M8X45	200	55050.080.045	M12X65	100	55050.120.065	M18X55*	25	55050.180.055
M8X50	200	55050.080.050	M12X70	100	55050.120.070	M18X60*	25	55050.180.060
M8X55	200	55050.080.055	M12X75	25	55050.120.075	M18X65*	25	55050.180.065
M8X60	200	55050.080.060	M12X80	100	55050.120.080	M18X70*	25	55050.180.070
M8X65	100	55050.080.065	M12X85*	25	55050.120.085	M18X75*	25	55050.180.075
M8X70	200	55050.080.070	M12X90	100	55050.120.090	M18X80*	25	55050.180.080
M8X75*	100	55050.080.075	M12X95*	25	55050.120.095	M18X90*	25	55050.180.090
M8X80	200	55050.080.080	M12X100	100	55050.120.100	M18X100*	25	55050.180.100
M8X85*	100	55050.080.085	M12X110	50	55050.120.110	M18X110*	25	55050.180.110
M8X90	200	55050.080.090	M12X120	50	55050.120.120	M18X120*	25	55050.180.120
M8X95*	100	55050.080.095	M12X130	25	55050.120.130	M18X140*	25	55050.180.140
M8X100	200	55050.080.100	M12X140	25	55050.120.140	M18X150*	25	55050.180.150
M8X110	100	55050.080.110	M12X150	25	55050.120.150			
M8X120	100	55050.080.120	M12X160*	25	55050.120.160	M20X30*	25	55050.200.030
M8X130	50	55050.080.130	M12X170*	25	55050.120.170	M20X35*	25	55050.200.035
M8X140	50	55050.080.140	M12X180*	25	55050.120.180	M20X40	25	55050.200.040
M8X150	50	55050.080.150	M12X190*	25	55050.120.190	M20X45	25	55050.200.045
M8X160*	50	55050.080.160	M12X200*	25	55050.120.200	M20X50	25	55050.200.050
M8X170*	25	55050.080.170	M12X210*	25	55050.120.210	M20X55	25	55050.200.055
M8X180*	25	55050.080.180	M12X220*	25	55050.120.220	M20X60	25	55050.200.060
M8X190*	25	55050.080.190	M12X230*	25	55050.120.230	M20X65*	25	55050.200.065
M8X200*	25	55050.080.200	M12X240*	25	55050.120.240	M20X70	25	55050.200.070
M8X210*	25	55050.080.210	M12X250*	25	55050.120.250	M20X75*	25	55050.200.075
M8X220*	25	55050.080.220	M12X260*	25	55050.120.260	M20X80	10	55050.200.080
M8X230*	25	55050.080.230	M12X270*	25	55050.120.270	M20X85*	25	55050.200.085
M8X240*	25	55050.080.240	M12X280*	25	55050.120.280	M20X90	10	55050.200.090
M8X250*	25	55050.080.250	M12X300*	25	55050.120.300			
M8X260*	25	55050.080.260						

55050 Hexagon socket head cap screw ←

d x L	☒	Art.number	d x L	☒	Art.number	d x L	☒	Art.number
M20X95*	25	55050.200.095	M24X40*	10	55050.240.040	M27X80	5	55050.270.080
M20X100	10	55050.200.100	M24X45*	10	55050.240.045	M27X90	5	55050.270.090
M20X110	10	55050.200.110	M24X50	10	55050.240.050	M27X100	5	55050.270.100
M20X120	10	55050.200.120	M24X55*	10	55050.240.055	M27X120*	10	55050.270.120
M20X130	10	55050.200.130	M24X60	10	55050.240.060	M27X130	5	55050.270.130
M20X140	10	55050.200.140	M24X65*	10	55050.240.065	M27X140	5	55050.270.140
M20X150	10	55050.200.150	M24X70	10	55050.240.070	M27X150	5	55050.270.150
M20X160*	25	55050.200.160	M24X75*	10	55050.240.075	M27X160*	10	55050.270.160
M20X170*	25	55050.200.170	M24X80	10	55050.240.080			
M20X180*	25	55050.200.180	M24X90	10	55050.240.090	M30X50	2	55050.300.050
M20X190*	25	55050.200.190	M24X100	10	55050.240.100	M30X55*	10	55050.300.055
M20X200*	25	55050.200.200	M24X110	10	55050.240.110	M30X60	2	55050.300.060
M20X210*	25	55050.200.210	M24X120	10	55050.240.120	M30X65*	10	55050.300.065
			M24X130*	10	55050.240.130	M30X70	2	55050.300.070
M22X40*	25	55050.220.040	M24X140	10	55050.240.140	M30X80	2	55050.300.080
M22X50*	25	55050.220.050	M24X150	10	55050.240.150	M30X85*	10	55050.300.085
M22X55*	25	55050.220.055	M24X160*	10	55050.240.160	M30X90	2	55050.300.090
M22X60*	25	55050.220.060	M24X170*	10	55050.240.170	M30X95*	10	55050.300.095
M22X65*	25	55050.220.065	M24X180*	10	55050.240.180	M30X100	2	55050.300.100
M22X70*	25	55050.220.070	M24X190*	10	55050.240.190	M30X110	2	55050.300.110
M22X75*	25	55050.220.075	M24X200*	10	55050.240.200	M30X120*	10	55050.300.120
M22X80*	25	55050.220.080	M24X210*	10	55050.240.210	M30X130	2	55050.300.130
M22X90*	25	55050.220.090	M24X220*	10	55050.240.220	M30X140	2	55050.300.140
M22X110*	25	55050.220.110	M24X240*	10	55050.240.240	M30X150	2	55050.300.150
M22X120*	25	55050.220.120				M30X160*	10	55050.300.160
M22X130*	25	55050.220.130	M27X50	5	55050.270.050	M30X180*	10	55050.300.180
M22X140*	25	55050.220.140	M27X60	5	55050.270.060	M30X200*	10	55050.300.200
M22X150*	10	55050.220.150	M27X70	5	55050.270.070			
			M27X75*	10	55050.270.075			

* Sizes with a diameter > M24 and sizes with a length > 8xd are minimal property class 50.

53570 Hexagon socket head cap screw R11A

Thread Metric thread
Material Stainless steel A4
Class 80

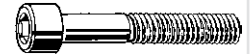

d x L	☒	Art.number	d x L	☒	Art.number	d x L	☒	Art.number
M4X5*	1000	53570.040.005	M5X80*	100	53570.050.080	M8X35	100	53570.080.035
M4X6*	1000	53570.040.006				M8X40	50	53570.080.040
M4X8	100	53570.040.008	M6X8*	500	53570.060.008	M8X45*	100	53570.080.045
M4X10	100	53570.040.010	M6X10*	500	53570.060.010	M8X50	50	53570.080.050
M4X12	100	53570.040.012	M6X12	100	53570.060.012	M8X55*	100	53570.080.055
M4X14*	1000	53570.040.014	M6X14	100	53570.060.014	M8X60	50	53570.080.060
M4X16	100	53570.040.016	M6X16	100	53570.060.016	M8X65*	100	53570.080.065
M4X18*	1000	53570.040.018	M6X18*	200	53570.060.018	M8X70	100	53570.080.070
M4X20	100	53570.040.020	M6X20	100	53570.060.020	M8X75*	100	53570.080.075
M4X22*	500	53570.040.022	M6X22*	200	53570.060.022	M8X80*	100	53570.080.080
M4X25	100	53570.040.025	M6X25	100	53570.060.025	M8X90*	100	53570.080.090
M4X30	100	53570.040.030	M6X30	100	53570.060.030	M8X100*	50	53570.080.100
M4X35*	200	53570.040.035	M6X35	100	53570.060.035	M8X110*	50	53570.080.110
M4X40	100	53570.040.040	M6X40	100	53570.060.040	M8X120*	50	53570.080.120
M4X45*	200	53570.040.045	M6X45*	100	53570.060.045	M8X130*	50	53570.080.130
M4X50*	200	53570.040.050	M6X50	100	53570.060.050	M8X140*	50	53570.080.140
M4X55*	200	53570.040.055	M6X55*	100	53570.060.055	M8X150*	50	53570.080.150
M4X60*	100	53570.040.060	M6X60	100	53570.060.060	M8X160*	50	53570.080.160
			M6X65*	100	53570.060.065			
M5X6*	500	53570.050.006	M6X70*	100	53570.060.070	M10X16	50	53570.100.016
M5X8*	500	53570.050.008	M6X75*	100	53570.060.075	M10X18*	100	53570.100.018
M5X10	100	53570.050.010	M6X80*	100	53570.060.080	M10X20	50	53570.100.020
M5X12	100	53570.050.012	M6X90*	100	53570.060.090	M10X22*	100	53570.100.022
M5X14*	500	53570.050.014	M6X100*	100	53570.060.100	M10X25	50	53570.100.025
M5X16	100	53570.050.016	M6X110*	100	53570.060.110	M10X30	50	53570.100.030
M5X18*	500	53570.050.018	M6X120*	100	53570.060.120	M10X35	50	53570.100.035
M5X20	100	53570.050.020	M6X130*	100	53570.060.130	M10X40	50	53570.100.040
M5X22*	500	53570.050.022	M6X140*	100	53570.060.140	M10X45	100	53570.100.045
M5X25	100	53570.050.025	M6X150*	100	53570.060.150	M10X50	50	53570.100.050
M5X30	100	53570.050.030				M10X55*	50	53570.100.055
M5X35	100	53570.050.035	M8X10*	500	53570.080.010	M10X60	50	53570.100.060
M5X40	100	53570.050.040	M8X12*	500	53570.080.012	M10X65*	50	53570.100.065
M5X45*	200	53570.050.045	M8X14*	200	53570.080.014	M10X70	50	53570.100.070
M5X50*	200	53570.050.050	M8X16	50	53570.080.016	M10X75*	50	53570.100.075
M5X55*	200	53570.050.055	M8X18*	200	53570.080.018	M10X80*	50	53570.100.080
M5X60*	100	53570.050.060	M8X20	50	53570.080.020	M10X90*	50	53570.100.090
M5X65*	100	53570.050.065	M8X22*	200	53570.080.022	M10X100*	50	53570.100.100
M5X70*	100	53570.050.070	M8X25	50	53570.080.025	M10X110*	50	53570.100.110
M5X75*	100	53570.050.075	M8X30	50	53570.080.030	M10X120*	50	53570.100.120

53570 Hexagon socket head cap screw ←

d x L	☒	Art.number	d x L	☒	Art.number	d x L	☒	Art.number
M10X130*	50	53570.100.130	M14X70*	50	53570.140.070	M20X40*	25	53570.200.040
M10X140*	50	53570.100.140	M14X75*	50	53570.140.075	M20X45*	25	53570.200.045
M10X150*	50	53570.100.150	M14X80*	50	53570.140.080	M20X50	10	53570.200.050
M12X20*	50	53570.120.020	M14X90*	50	53570.140.090	M20X55*	25	53570.200.055
M12X25	25	53570.120.025	M14X100*	50	53570.140.100	M20X60	10	53570.200.060
M12X30	25	53570.120.030	M14X110*	25	53570.140.110	M20X65*	25	53570.200.065
M12X35	25	53570.120.035	M14X120*	25	53570.140.120	M20X70	10	53570.200.070
M12X40	25	53570.120.040	M14X130*	25	53570.140.130	M20X75*	25	53570.200.075
M12X45	100	53570.120.045	M14X140*	25	53570.140.140	M20X80*	25	53570.200.080
M12X50	25	53570.120.050	M14X150*	25	53570.140.150	M20X90*	25	53570.200.090
M12X55*	50	53570.120.055	M16X25*	25	53570.160.025	M20X100	10	53570.200.100
M12X60	25	53570.120.060	M16X30	25	53570.160.030	M20X110*	25	53570.200.110
M12X65*	50	53570.120.065	M16X35*	25	53570.160.035	M20X120*	25	53570.200.120
M12X70	100	53570.120.070	M16X40	25	53570.160.040	M20X130*	25	53570.200.130
M12X75*	25	53570.120.075	M16X45	25	53570.160.045	M20X140*	25	53570.200.140
M12X80*	25	53570.120.080	M16X50	25	53570.160.050	M20X150*	25	53570.200.150
M12X90	25	53570.120.090	M16X55*	25	53570.160.055	M24X40*	10	53570.240.040
M12X100*	25	53570.120.100	M16X60	25	53570.160.060	M24X45*	10	53570.240.045
M12X110*	25	53570.120.110	M16X65*	25	53570.160.065	M24X50*	10	53570.240.050
M12X120*	25	53570.120.120	M16X70	100	53570.160.070	M24X55*	10	53570.240.055
M12X130*	25	53570.120.130	M16X75*	25	53570.160.075	M24X60*	10	53570.240.060
M12X140*	25	53570.120.140	M16X80	25	53570.160.080	M24X65*	10	53570.240.065
M12X150*	25	53570.120.150	M16X90	25	53570.160.090	M24X70*	10	53570.240.070
M14X30*	50	53570.140.030	M16X100*	25	53570.160.100	M24X75*	10	53570.240.075
M14X35*	50	53570.140.035	M16X110*	25	53570.160.110	M24X80*	10	53570.240.080
M14X40*	50	53570.140.040	M16X120*	25	53570.160.120	M24X90*	10	53570.240.090
M14X45*	50	53570.140.045	M16X130*	25	53570.160.130	M24X100*	10	53570.240.100
M14X50*	50	53570.140.050	M16X140*	25	53570.160.140	M24X110*	10	53570.240.110
M14X55*	50	53570.140.055	M16X150*	25	53570.160.150	M24X120*	10	53570.240.120
M14X60*	50	53570.140.060	M20X30*	25	53570.200.030	M24X130*	10	53570.240.130
M14X65*	50	53570.140.065	M20X35*	25	53570.200.035	M24X140*	10	53570.240.140
						M24X150*	10	53570.240.150

45205 Hexagon socket head cap screw W010

Thread	Metric thread	DIN	≈912
Material	Aluminium P60	ISO	≈4762
		NEN	≈1241
		ASME	≈B18.3.1M
		NF	≈E25-125
		BS	≈4168-1

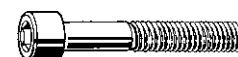

d x L	☒	Art.number	d x L	☒	Art.number	d x L	☒	Art.number
M4X10	200	45205.040.010	M5X40	200	45205.050.040	M8X15	200	45205.080.015
M4X12	200	45205.040.012				M8X20	200	45205.080.020
M4X16	200	45205.040.016	M6X10	200	45205.060.010	M8X25	200	45205.080.025
M4X20	200	45205.040.020	M6X12	200	45205.060.012	M8X30	200	45205.080.030
M4X25	200	45205.040.025	M6X16	200	45205.060.016	M8X40	200	45205.080.040
M4X30	200	45205.040.030	M6X20	200	45205.060.020	M8X50	200	45205.080.050
			M6X25	200	45205.060.025			
M5X10	200	45205.050.010	M6X30	200	45205.060.030	M10X25	200	45205.100.025
M5X12	200	45205.050.012	M6X40	200	45205.060.040	M10X30	200	45205.100.030
M5X16	200	45205.050.016	M6X50	200	45205.060.050	M10X40	100	45205.100.040
M5X20	200	45205.050.020	M6X60	200	45205.060.060	M10X50	100	45205.100.050
M5X25	200	45205.050.025	M6X70	200	45205.060.070	M10X60	100	45205.100.060
M5X30	200	45205.050.030						

Hexalobular socket cap screw

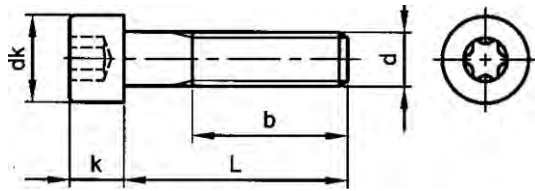

ISO 14579

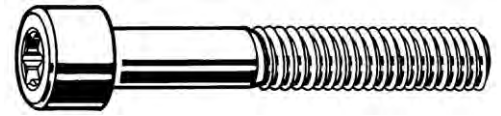

2

Technical Data

d	b	d _k (max.)	k (max.)	P	Socket
M2	16	3.8	2	0.4	T6
M2.5	17	4.5	2.5	0.45	T8
M3	18	5.5	3	0.5	T10
M4	20	7	4	0.7	T20
M5	22	8.5	5	0.8	T25
M6	24	10	6	1	T30
M8	28	13	8	1.25	T45

Article groups

Thread	Driving features	Material	Class	Surface treatment	Code	Page
M	Hexalobular	St	8.8	Zipl	07165	2-16
M	Hexalobular	St.St. A2	50		51052	2-16

07165 Hexalobular socket cap screw

D02A

Thread	Metric thread
Material	Steel
Class	8.8
Surface treatment	Zinc plated



d x L	Art.number	d x L	Art.number	d x L	Art.number
M5X25	500 07165.050.025	M6X35	200 07165.060.035	M8X16	200 07165.080.016
M6X12	200 07165.060.012	M6X40	200 07165.060.040	M8X40	100 07165.080.040
M6X30	200 07165.060.030	M6X50	200 07165.060.050	M8X50	100 07165.080.050

51052 Hexalobular socket cap screw

Q05A

Thread	Metric thread
Material	Stainless steel A2
Class	50



d x L	Art.number	d x L	Art.number	d x L	Art.number
M2X3*	500 51052.020.003	M3X5*	1000 51052.030.005	M4X35*	200 51052.040.035
M2X4*	500 51052.020.004	M3X6*	1000 51052.030.006	M4X40*	200 51052.040.040
M2X5*	500 51052.020.005	M3X8*	1000 51052.030.008	M4X45*	200 51052.040.045
M2X6*	500 51052.020.006	M3X10*	1000 51052.030.010	M4X50*	200 51052.040.050
M2X8*	500 51052.020.008	M3X12*	1000 51052.030.012	M4X60*	100 51052.040.060
M2X10*	500 51052.020.010	M3X14*	1000 51052.030.014	M5X6*	500 51052.050.006
M2X12*	500 51052.020.012	M3X16*	1000 51052.030.016	M5X8*	500 51052.050.008
M2X14*	500 51052.020.014	M3X18*	1000 51052.030.018	M5X10*	500 51052.050.010
M2X16*	500 51052.020.016	M3X20*	1000 51052.030.020	M5X12*	500 51052.050.012
M2X18*	500 51052.020.018	M3X22*	1000 51052.030.022	M5X14*	500 51052.050.014
M2X20*	500 51052.020.020	M3X25*	1000 51052.030.025	M5X16*	500 51052.050.016
M2.5X3*	500 51052.025.003	M3X30*	1000 51052.030.030	M5X18*	500 51052.050.018
M2.5X4*	500 51052.025.004	M4X5*	1000 51052.040.005	M5X20*	500 51052.050.020
M2.5X5*	500 51052.025.005	M4X6*	1000 51052.040.006	M5X22*	500 51052.050.022
M2.5X6*	500 51052.025.006	M4X8*	1000 51052.040.008	M5X25*	200 51052.050.025
M2.5X8*	500 51052.025.008	M4X10*	1000 51052.040.010	M5X30*	200 51052.050.030
M2.5X10*	500 51052.025.010	M4X12*	1000 51052.040.012	M5X35*	200 51052.050.035
M2.5X12*	500 51052.025.012	M4X14*	1000 51052.040.014	M5X40*	200 51052.050.040
M2.5X14*	500 51052.025.014	M4X16*	1000 51052.040.016	M5X45*	200 51052.050.045
M2.5X16*	500 51052.025.016	M4X18*	1000 51052.040.018	M5X50*	200 51052.050.050
M2.5X18*	500 51052.025.018	M4X20*	500 51052.040.020	M5X60*	100 51052.050.060
M2.5X20*	500 51052.025.020	M4X22*	500 51052.040.022	M6X6*	500 51052.060.006
M3X4*	1000 51052.030.004	M4X25*	500 51052.040.025	M6X8*	500 51052.060.008
		M4X30*	500 51052.040.030		

51052 Hexalobular socket cap screw								
d x L	☒	Art.number	d x L	☒	Art.number	d x L	☒	Art.number
M6X10*	500	51052.060.010	M6X35*	200	51052.060.035	M8X22*	200	51052.080.022
M6X12*	500	51052.060.012	M6X40*	200	51052.060.040	M8X25*	100	51052.080.025
M6X14*	200	51052.060.014	M6X45*	100	51052.060.045	M8X30*	100	51052.080.030
M6X16*	200	51052.060.016	M6X50*	100	51052.060.050	M8X35*	100	51052.080.035
M6X18*	200	51052.060.018	M6X60*	100	51052.060.060	M8X40*	100	51052.080.040
M6X20*	200	51052.060.020				M8X45*	100	51052.080.045
M6X22*	200	51052.060.022	M8X16*	200	51052.080.016	M8X50*	100	51052.080.050
M6X25*	200	51052.060.025	M8X18*	200	51052.080.018	M8X60*	100	51052.080.060
M6X30*	200	51052.060.030	M8X20*	200	51052.080.020			

Hexagon socket head cap screw fully threaded

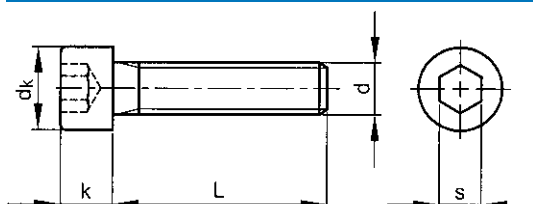

DIN ≈912
 ISO ≈4762
 NEN ≈1241
 ASME ≈B18.3.1M
 NF ≈E25-125
 BS ≈4168-1



Technical Data

d	dk (max.)	k (max.)	P	s
M3	5.5	3	0.5	2.5
M4	7	4	0.7	3
M5	8.5	5	0.8	4
M6	10	6	1	5
M8	13	8	1.25	6
M10	16	10	1.5	8
M12	18	12	1.75	10
M14	21	14	2	12
M16	24	16	2	14
M20	30	20	2.5	17

Article groups

Thread	Driving features	Material	Class	Surface treatment	Color	Code	Page
M	Hexagon socket	St	8.8			07070	2-17
M	Hexagon socket	St	8.8	Zipl		07071	2-18
M	Hexagon socket	St	12.9			07010	2-18
M	Hexagon socket	St.St. A2	70			51020	2-18
M	Hexagon socket	St.St. A4	70			55020	2-19
M	Hexagon socket	St.St. A2	70		serrated	51051	2-19
M	Hexagon socket	Plastic PA	PA 6.6		White	56120	2-19

07070 Hexagon socket head cap screw fully threaded		D03A
Thread	Metric thread	
Material	Steel	
Class	8.8	

d x L	☒	Art.number	d x L	☒	Art.number	d x L	☒	Art.number
M3X25	200	07070.030.025	M6X45	200	07070.060.045	M10X80	50	07070.100.080
M4X30	200	07070.040.030	M6X50	200	07070.060.050	M10X100	50	07070.100.100
M4X40	200	07070.040.040	M6X60	200	07070.060.060			
M4X50	200	07070.040.050	M6X80	200	07070.060.080	M12X60	50	07070.120.060
M4X60	200	07070.040.060	M6X90	100	07070.060.090	M12X70	50	07070.120.070
			M6X100	100	07070.060.100	M12X80	50	07070.120.080
M5X30	200	07070.050.030				M12X100	50	07070.120.100
M5X35	200	07070.050.035	M8X40	100	07070.080.040	M12X120	50	07070.120.120
M5X40	200	07070.050.040	M8X50	100	07070.080.050			
M5X45	200	07070.050.045	M8X60	100	07070.080.060	M14X60	50	07070.140.060
M5X50	200	07070.050.050	M8X70	100	07070.080.070	M14X80	50	07070.140.080
M5X60	200	07070.050.060	M8X80	100	07070.080.080			
M5X80	200	07070.050.080	M8X100	100	07070.080.100	M16X80	25	07070.160.080
						M16X100	25	07070.160.100
M6X35	200	07070.060.035	M10X50	50	07070.100.050			
M6X40	200	07070.060.040	M10X60	50	07070.100.060	M20X80	25	07070.200.080
			M10X70	50	07070.100.070			

07071 Hexagon socket head cap screw fully threaded D03A

Thread: Metric thread
 Material: Steel
 Class: 8.8
 Surface treatment: Zinc plated



d x L	☒	Art.number	d x L	☒	Art.number	d x L	☒	Art.number
M3X25	200	07071.030.025	M6X35	200	07071.060.035	M10X80	50	07071.100.080
M3X30	200	07071.030.030	M6X40	200	07071.060.040	M10X100	50	07071.100.100
M3X40	200	07071.030.040	M6X45	200	07071.060.045			
			M6X50	200	07071.060.050	M12X60	50	07071.120.060
M4X30	200	07071.040.030	M6X60	200	07071.060.060	M12X70	50	07071.120.070
M4X40	200	07071.040.040	M6X70	200	07071.060.070	M12X80	50	07071.120.080
M4X50	200	07071.040.050	M6X80	200	07071.060.080	M12X100	50	07071.120.100
M4X60	200	07071.040.060						
			M8X40	100	07071.080.040	M16X70	50	07071.160.070
M5X30	200	07071.050.030	M8X50	100	07071.080.050	M16X80	25	07071.160.080
M5X35	200	07071.050.035	M8X60	100	07071.080.060	M16X90	25	07071.160.090
M5X40	200	07071.050.040	M8X70	100	07071.080.070	M16X100	25	07071.160.100
M5X45	200	07071.050.045	M8X80	100	07071.080.080			
M5X50	200	07071.050.050	M8X100	100	07071.080.100	M20X80	25	07071.200.080
M5X60	200	07071.050.060				M20X90	25	07071.200.090
M5X70	200	07071.050.070	M10X50	50	07071.100.050	M20X100	25	07071.200.100
M5X80	200	07071.050.080	M10X60	50	07071.100.060			
			M10X70	50	07071.100.070			

07010 Hexagon socket head cap screw fully threaded D03A

Thread: Metric thread
 Material: Steel
 Class: 12.9





d x L	☒	Art.number	d x L	☒	Art.number	d x L	☒	Art.number
M3X25	200	07010.030.025	M6X35	200	07010.060.035	M8X80	100	07010.080.080
M4X30	200	07010.040.030	M6X40	200	07010.060.040	M10X50	50	07010.100.050
M4X40	200	07010.040.040	M6X50	200	07010.060.050	M10X60	50	07010.100.060
M4X50	200	07010.040.050	M6X60	100	07010.060.060	M10X70	50	07010.100.070
						M10X80	50	07010.100.080
M5X30	200	07010.050.030	M8X40	100	07010.080.040			
M5X35	200	07010.050.035	M8X50	100	07010.080.050	M12X60	50	07010.120.060
M5X40	200	07010.050.040	M8X60	100	07010.080.060	M12X80	50	07010.120.080
M5X50	200	07010.050.050						

• Warning: electro-galvanizing of these products may cause hydrogen embrittlement.

51020 Hexagon socket head cap screw fully threaded Q05A

Thread: Metric thread
 Material: Stainless steel A2
 Class: 70

d x L	☒	Art.number	d x L	☒	Art.number	d x L	☒	Art.number
M5X30*	200	51020.050.030	M6X90*	100	51020.060.090	M10X50*	50	51020.100.050
M5X35*	200	51020.050.035	M6X100*	100	51020.060.100	M10X55*	50	51020.100.055
M5X40*	200	51020.050.040				M10X60*	50	51020.100.060
M5X45*	200	51020.050.045	M8X40*	100	51020.080.040	M10X70*	50	51020.100.070
M5X50*	200	51020.050.050	M8X45*	100	51020.080.045	M10X80*	50	51020.100.080
			M8X50*	100	51020.080.050	M10X90*	50	51020.100.090
M6X35*	200	51020.060.035	M8X55*	100	51020.080.055	M10X100*	50	51020.100.100
M6X40*	200	51020.060.040	M8X60*	100	51020.080.060			
M6X45*	100	51020.060.045	M8X70*	100	51020.080.070	M12X55*	100	51020.120.055
M6X50*	100	51020.060.050	M8X80*	100	51020.080.080	M12X60*	50	51020.120.060
M6X55*	100	51020.060.055	M8X90*	100	51020.080.090	M12X70*	50	51020.120.070
M6X60*	100	51020.060.060	M8X100*	50	51020.080.100	M12X80*	25	51020.120.080
M6X70*	100	51020.060.070				M12X90*	25	51020.120.090
M6X80*	100	51020.060.080	M10X45*	100	51020.100.045			

55020 Hexagon socket head cap screw fully threaded Q45A



Thread Metric thread
Material Stainless steel A4
Class 70



d x L	☒	Art.number	d x L	☒	Art.number	d x L	☒	Art.number
M5X30*	200	55020.050.030	M6X80*	100	55020.060.080	M10X50*	50	55020.100.050
M5X35*	200	55020.050.035	M6X90*	100	55020.060.090	M10X55*	50	55020.100.055
M5X40*	200	55020.050.040				M10X60*	50	55020.100.060
M5X45*	200	55020.050.045	M8X40*	100	55020.080.040	M10X70*	50	55020.100.070
M5X50*	200	55020.050.050	M8X45*	100	55020.080.045	M10X80*	50	55020.100.080
M5X100*	100	55020.050.100	M8X50*	100	55020.080.050	M10X90*	50	55020.100.090
			M8X55*	100	55020.080.055	M10X100*	50	55020.100.100
M6X35*	200	55020.060.035	M8X60*	100	55020.080.060			
M6X40*	200	55020.060.040	M8X70*	100	55020.080.070	M12X55*	50	55020.120.055
M6X45*	100	55020.060.045	M8X80*	100	55020.080.080	M12X60*	50	55020.120.060
M6X50*	100	55020.060.050	M8X90*	100	55020.080.090	M12X70*	50	55020.120.070
M6X55*	100	55020.060.055	M8X100*	50	55020.080.100	M12X80*	25	55020.120.080
M6X60*	100	55020.060.060				M12X90*	25	55020.120.090
M6X70*	100	55020.060.070	M10X45*	100	55020.100.045	M12X100*	25	55020.120.100

51051 Hexagon socket head cap screw fully threaded, with serration Q05A

Thread Metric thread
Material Stainless steel A2
Class 70

d x L	☒	Art.number	d x L	☒	Art.number	d x L	☒	Art.number
M8X12*	500	51051.080.012	M8X28*	200	51051.080.028	M8X50*	200	51051.080.050
M8X14*	200	51051.080.014	M8X30*	200	51051.080.030	M8X55*	100	51051.080.055
M8X16*	200	51051.080.016	M8X32*	200	51051.080.032	M8X60*	100	51051.080.060
M8X20*	200	51051.080.020	M8X35*	200	51051.080.035			
M8X22*	200	51051.080.022	M8X40*	200	51051.080.040	M10X20*	100	51051.100.020
M8X25*	200	51051.080.025	M8X45*	200	51051.080.045			

56120 Hexagon socket head cap screw fully threaded plastic W02A

Thread Metric thread
Material Plastic Polyamide (nylon)
Class PA 6.6
Color White



d x L	☒	Art.number	d x L	☒	Art.number	d x L	☒	Art.number
M6X10	50	56120.060.010	M8X20	50	56120.080.020	M10X30	25	56120.100.030
M6X16	50	56120.060.016	M8X25	50	56120.080.025	M10X40	25	56120.100.040
M6X20	50	56120.060.020	M8X30	50	56120.080.030	M10X50	25	56120.100.050
M6X25	50	56120.060.025	M8X40	50	56120.080.040	M10X60	25	56120.100.060
M6X30	50	56120.060.030	M8X50	50	56120.080.050			
M6X40	50	56120.060.040	M8X60	50	56120.080.060	M12X30	25	56120.120.030
M6X50	50	56120.060.050				M12X40	25	56120.120.040
			M10X20	25	56120.100.020	M12X50	25	56120.120.050
M8X16	50	56120.080.016	M10X25	25	56120.100.025	M12X60	25	56120.120.060

Hexagon socket head cap screw MF

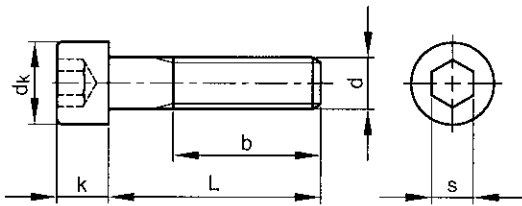

DIN 912
ISO 4762
NEN 1241
ASME B18.3.1M
NF E25-125
BS 4168-1

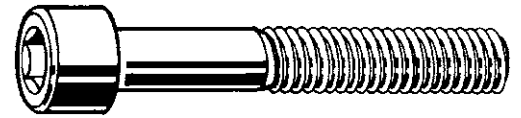

Technical Data

d	b	d _k (max.)	Full thread L ≤	k (max.)	s
M8	28	13	35	8	6
M10	32	16	40	10	8
M12	36	18	50	12	10
M14	40	21	55	14	12
M16	44	24	60	16	14
M18	48	27	65	18	14

Article groups

Thread	Driving features	Material	Class	Code	Page
MF	Hexagon socket	St	12.9	07040	2-20
MEF	Hexagon socket	St	12.9	07041	2-20

07040 Hexagon socket head cap screw MF

D93A

Thread Metric fine thread
Material Steel
Class 12.9

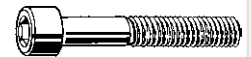

d x P x L	☒	Art.number	d x P x L	☒	Art.number	d x P x L	☒	Art.number
M8X1,00X16	100	07040.080.016	M10X1,25X60	25	07040.100.060	M12X1,50X100	10	07040.120.100
M8X1,00X20	100	07040.080.020	M10X1,25X70	25	07040.100.070			
M8X1,00X25	100	07040.080.025	M10X1,25X80	25	07040.100.080	M14X1,50X30	10	07040.140.030
M8X1,00X30	100	07040.080.030	M10X1,25X90	25	07040.100.090	M14X1,50X40	10	07040.140.040
M8X1,00X35	100	07040.080.035	M10X1,25X100	25	07040.100.100	M14X1,50X50	10	07040.140.050
M8X1,00X40	100	07040.080.040				M14X1,50X60	50	07040.140.060
M8X1,00X45	50	07040.080.045	M12X1,50X25	50	07040.120.025	M14X1,50X80	10	07040.140.080
M8X1,00X50	50	07040.080.050	M12X1,50X30	50	07040.120.030			
			M12X1,50X35	50	07040.120.035	M16X1,50X40	10	07040.160.040
M10X1,25X20	100	07040.100.020	M12X1,50X40	25	07040.120.040	M16X1,50X50	10	07040.160.050
M10X1,25X25	50	07040.100.025	M12X1,50X45	25	07040.120.045	M16X1,50X55	10	07040.160.055
M10X1,25X30	50	07040.100.030	M12X1,50X50	25	07040.120.050	M16X1,50X60	10	07040.160.060
M10X1,25X35	50	07040.100.035	M12X1,50X55	25	07040.120.055	M16X1,50X70	10	07040.160.070
M10X1,25X40	50	07040.100.040	M12X1,50X60	10	07040.120.060	M16X1,50X80	5	07040.160.080
M10X1,25X45	50	07040.100.045	M12X1,50X70	10	07040.120.070	M16X1,50X90	5	07040.160.090
M10X1,25X50	50	07040.100.050	M12X1,50X80	10	07040.120.080	M16X1,50X100	5	07040.160.100
M10X1,25X55	50	07040.100.055	M12X1,50X90	10	07040.120.090			

• Warning: electro-galvanizing of these products may cause hydrogen embrittlement.

07041 Hexagon socket head cap screw MEF

D93A

Thread Metric extra fine thread
Material Steel
Class 12.9

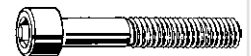

d x P x L	☒	Art.number	d x P x L	☒	Art.number	d x P x L	☒	Art.number
M10X1,00X30	50	07041.100.030	M10X1,00X100	25	07041.100.100	M12X1,25X60	25	07041.120.060
M10X1,00X35	50	07041.100.035				M12X1,25X70	10	07041.120.070
M10X1,00X40	50	07041.100.040	M12X1,25X25	50	07041.120.025	M12X1,25X80	10	07041.120.080
M10X1,00X45	50	07041.100.045	M12X1,25X30	50	07041.120.030	M12X1,25X100	10	07041.120.100
M10X1,00X50	50	07041.100.050	M12X1,25X40	25	07041.120.040			
M10X1,00X60	25	07041.100.060	M12X1,25X45	25	07041.120.045	M18X1,50X70	5	07041.180.070
M10X1,00X70	25	07041.100.070	M12X1,25X50	25	07041.120.050	M18X1,50X80	5	07041.180.080
M10X1,00X90	25	07041.100.090						

• Warning: electro-galvanizing of these products may cause hydrogen embrittlement.

Hexagon socket head cap screw UNC 1960 series

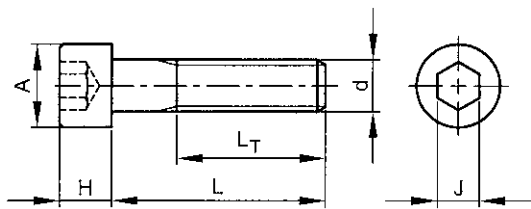

ASME ≈B18.3 (1960)
BS ≈2470

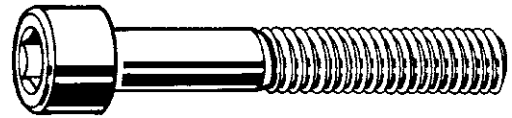

2

Technical Data

d	A	H	J	L _T (min.)	Threads per inch
No.2	0.14	0.086	5/64	0.625	56
No.4	0.183	0.112	3/32	0.750	40
No.6	0.226	0.138	7/64	0.750	32
No.8	0.27	0.164	9/64	0.875	32
1/4	3/8	1/4	3/16	1.000	20
5/16	15/32	5/16	1/4	1.125	18
3/8	9/16	3/8	5/16	1.250	16
1/2	3/4	1/2	3/8	1.500	13
5/8	15/16	5/8	1/2	1.750	11
3/4	1.1/8	3/4	5/8	2.000	10

- The mechanical properties corresponds much with the same property class 12.9 acc. to DIN ISO 898-1. Other properties acc. to ASTM A574.
- Marking of these screws is not mandatory.
- ATTENTION: as the product standard specifies thread tolerance 3A for thread sizes up to 1 inch, zinc plating can cause thread fit problems.

Article groups

Thread	Driving features	Material	Class	Code	Page
UNC	Hexagon socket	St	12.9	07212	2-21
UNC	Hexagon socket	St.St. A2		51056	2-21

07212 Hexagon socket head cap screw UNC 1960 series X05A

Thread: Unified National Coarse
Material: Steel
Class: 12.9

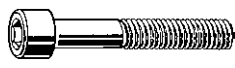
d x L	Art.number	d x L	Art.number	d x L	Art.number
NO.2X3/16	100 07212.021.004	NO.4X5/8	100 07212.028.015	NO.6X1 Inch	100 07212.035.025
NO.2X1/4	100 07212.021.006	NO.4X3/4	100 07212.028.019		
NO.2X3/8	100 07212.021.009			NO.8X1/4	100 07212.041.006
NO.2X1/2	100 07212.021.012	NO.6X1/4	100 07212.035.006	NO.8X3/8	100 07212.041.009
NO.2X5/8	100 07212.021.015	NO.6X5/16	100 07212.035.007	NO.8X1/2	100 07212.041.012
		NO.6X3/8	100 07212.035.009	NO.8X5/8	100 07212.041.015
NO.4X1/4	100 07212.028.006	NO.6X1/2	100 07212.035.012	NO.8X3/4	100 07212.041.019
NO.4X5/16	100 07212.028.007	NO.6X5/8	100 07212.035.015	NO.8X1 Inch	100 07212.041.025
NO.4X3/8	100 07212.028.009	NO.6X3/4	100 07212.035.019	NO.8X1.1/4	100 07212.041.031
NO.4X1/2	100 07212.028.012	NO.6X7/8	100 07212.035.022	NO.8X1.1/2	100 07212.041.038

- Warning: electro-galvanizing of these products may cause hydrogen embrittlement.

51056 Hexagon socket head cap screw UNC 1960 series X61A

Thread: Unified National Coarse
Material: Stainless steel A2



d x L	Art.number	d x L	Art.number	d x L	Art.number
1/4X1/4	100 51056.063.006	1/4X2 Inch	100 51056.063.050	3/8X2 Inch	50 51056.096.050
1/4X3/8	100 51056.063.009	1/4X2.1/4	100 51056.063.057	3/8X2.1/2	50 51056.096.063
1/4X1/2	100 51056.063.012	1/4X2.1/2	100 51056.063.063	3/8X2.3/4	100 51056.096.069
1/4X5/8	100 51056.063.015			3/8X3.1/2	50 51056.096.088
1/4X7/8	100 51056.063.022	3/8X5/8	25 51056.096.015	3/8X4.1/2	50 51056.096.114
1/4X1 Inch	100 51056.063.025	3/8X1 Inch	50 51056.096.025		
1/4X1.1/4	100 51056.063.031	3/8X1.1/4	50 51056.096.031	1/2X3/4	25 51056.127.019
1/4X1.1/2	100 51056.063.038	3/8X1.1/2	50 51056.096.038	1/2X1 Inch	25 51056.127.025
1/4X1.3/4	100 51056.063.044	3/8X1.3/4	50 51056.096.044	1/2X1.1/4	25 51056.127.031

51056 Hexagon socket head cap screw UNC 1960 series								
d x L	☒	Art.number	d x L	☒	Art.number	d x L	☒	Art.number
1/2X1.1/2	25	51056.127.038	1/2X2 Inch	25	51056.127.050	1/2X4 Inch	25	51056.127.101
1/2X1.3/4	25	51056.127.044	1/2X3 Inch	25	51056.127.076			

2

Hexagon socket head cap screw UNC 1936 series

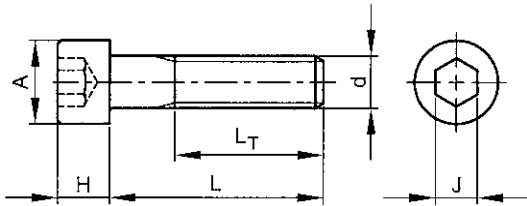

ASME ≈B18.3 (1936)

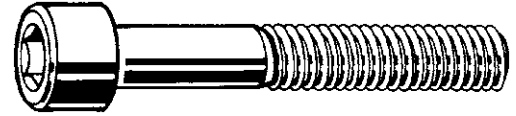

Technical Data

d	A	H	J	L _T (min.)	Threads per inch
No.1	0.118	0.073	1/16	0.62	64
No.2	0.140	0.086	5/64	0.62	56
No.3	0.161	0.099	5/64	0.62	48
No.4	0.183	0.112	3/32	0.75	40
No.5	0.205	0.125	3/32	0.75	40
No.6	0.226	0.138	7/64	0.75	32
No.8	0.270	0.164	9/64	0.88	32
No.10	0.312	0.19	5/32	0.88	24
1/4	0.375	0.25	3/16	1	20
5/16	0.469	0.312	1/4	1.12	18
3/8	0.562	0.375	5/16	1.25	16
7/16	0.656	0.438	3/8	1.38	14
1/2	0.750	0.5	3/8	1.5	13
9/16	0.844	0.562	3/8	1.5	12
5/8	0.938	0.625	1/2	1.75	11
3/4	1.125	0.75	5/8	2	10
7/8	1.312	0.875	3/4	2.25	9
1 Inch	1.5	1	3/4	2.5	8
1.1/8	1.688	1.125	7/8	2.81	7
1.1/4	1.875	1.25	7/8	3.12	7
1.3/8	2.062	1.375	1	3.44	6
1.1/2	2.25	1.5	1	3.75	6
1.3/4	2.625	1.75	1 1/4	4.38	5
2 Inch	3	2	1 1/2	5	4.5

- The mechanical properties corresponds much with the same property class 12.9 acc. to DIN ISO 898-1. Other properties acc. to ASTM A574.
- Marking of these screws is not mandatory.
- ATTENTION: as the product standard specifies thread tolerance 3A for thread sizes up to 1 inch, zinc plating can cause thread fit problems.

Article groups

Thread	Driving features	Material	Class	Surface treatment	Code	Page
UNC	Hexagon socket	St	Grade 8		U07000	2-22
UNC	Hexagon socket	St	Grade 8	Zipl	U07001	2-25
UNC	Hexagon socket	St	12.9	Mech.zipl.	07260	2-25
UNC	Hexagon socket	St.St. A2 (AISI304/18-8)	F837B		U51050	2-26
UNC	Hexagon socket	St.St. A4 (AISI316/18-10)	F837E		U55050	2-27

U07000 Hexagon socket head cap screw UNC 1936 series		X05A
Thread	Unified National Coarse	
Material	Steel	
Class	Grade 8	
		
		

d x L	☒	Art.number	d x L	☒	Art.number	d x L	☒	Art.number
NO.1-64X3/16 ft*	100	U07000.007.0018	NO.1-64X3/4*	100	U07000.007.0075	NO.2-56X5/16 ft*	100	U07000.008.0031
NO.1-64X1/4 ft*	100	U07000.007.0025	NO.1-64X1 Inch*	100	U07000.007.0100	NO.2-56X3/8 ft*	100	U07000.008.0037
NO.1-64X5/16 ft*	100	U07000.007.0031				NO.2-56X7/16 ft*	100	U07000.008.0043
NO.1-64X3/8 ft*	100	U07000.007.0037	NO.2-56X1/8 ft*	100	U07000.008.0012	NO.2-56X1/2 ft*	100	U07000.008.0050
NO.1-64X1/2 ft*	100	U07000.007.0050	NO.2-56X3/16 ft*	100	U07000.008.0018	NO.2-56X5/8 ft*	100	U07000.008.0062
NO.1-64X5/8 ft*	100	U07000.007.0062	NO.2-56X1/4 ft*	100	U07000.008.0025	NO.2-56X3/4*	100	U07000.008.0075

U07000 Hexagon socket head cap screw UNC 1936 series

2

d x L	Art.number	d x L	Art.number	d x L	Art.number
1/2-13X8.1/2*	U07000.050.0850	3/4-10X10 Inch*	U07000.075.1000	1.1/8-7X13 Inch*	U07000.112.1300
1/2-13X9 Inch*	U07000.050.0900	3/4-10X11 Inch*	U07000.075.1100	1.1/8-7X14 Inch*	U07000.112.1400
1/2-13X9.1/2*	U07000.050.0950	3/4-10X12 Inch*	U07000.075.1200	1.1/8-7X15 Inch*	U07000.112.1500
9/16-12X1 Inch ft*	U07000.056.0100	3/4-10X13 Inch*	U07000.075.1300	1.1/8-7X16 Inch*	U07000.112.1600
9/16-12X1.1/4 ft*	U07000.056.0125	3/4-10X14 Inch*	U07000.075.1400	1.1/4-7X2 Inch ft*	U07000.125.0200
9/16-12X1.1/2 ft*	U07000.056.0150	7/8-9X1.1/4 ft*	U07000.087.0125	1.1/4-7X2.1/4 ft*	U07000.125.0225
9/16-12X1.3/4*	U07000.056.0175	7/8-9X1.1/2 ft*	U07000.087.0150	1.1/4-7X2.1/2 ft*	U07000.125.0250
9/16-12X2 Inch*	U07000.056.0200	7/8-9X1.3/4 ft*	U07000.087.0175	1.1/4-7X2.3/4 ft*	U07000.125.0275
9/16-12X2.1/4*	U07000.056.0225	7/8-9X2 Inch ft*	U07000.087.0200	1.1/4-7X3 Inch ft*	U07000.125.0300
9/16-12X2.1/2*	U07000.056.0250	7/8-9X2.1/4 ft*	U07000.087.0225	1.1/4-7X3.1/2*	U07000.125.0350
9/16-12X2.3/4*	U07000.056.0275	7/8-9X2.1/2*	U07000.087.0250	1.1/4-7X3.3/4*	U07000.125.0375
9/16-12X3 Inch*	U07000.056.0300	7/8-9X2.3/4*	U07000.087.0275	1.1/4-7X4 Inch*	U07000.125.0400
9/16-12X3.1/2*	U07000.056.0350	7/8-9X3 Inch*	U07000.087.0300	1.1/4-7X4.1/2*	U07000.125.0450
9/16-12X4 Inch*	U07000.056.0400	7/8-9X3.1/4*	U07000.087.0325	1.1/4-7X5 Inch*	U07000.125.0500
9/16-12X4.1/2*	U07000.056.0450	7/8-9X3.1/2*	U07000.087.0350	1.1/4-7X5.1/2*	U07000.125.0550
9/16-12X5 Inch*	U07000.056.0500	7/8-9X4 Inch*	U07000.087.0400	1.1/4-7X6 Inch*	U07000.125.0600
9/16-12X5.1/2*	U07000.056.0550	7/8-9X4.1/2*	U07000.087.0450	1.1/4-7X6.1/2*	U07000.125.0650
9/16-12X6 Inch*	U07000.056.0600	7/8-9X4.3/4*	U07000.087.0475	1.1/4-7X7 Inch*	U07000.125.0700
9/16-12X6.1/2*	U07000.056.0650	7/8-9X5 Inch*	U07000.087.0500	1.1/4-7X8 Inch*	U07000.125.0800
9/16-12X7 Inch*	U07000.056.0700	7/8-9X5.1/2*	U07000.087.0550	1.1/4-7X9 Inch*	U07000.125.0900
9/16-12X7.1/2*	U07000.056.0750	7/8-9X6 Inch*	U07000.087.0600	1.1/4-7X10 Inch*	U07000.125.1000
9/16-12X8 Inch*	U07000.056.0800	7/8-9X6.1/2*	U07000.087.0650	1.1/4-7X11 Inch*	U07000.125.1100
5/8-11X5/8 ft*	U07000.062.0062	7/8-9X7 Inch*	U07000.087.0700	1.1/4-7X12 Inch*	U07000.125.1200
5/8-11X3/4 ft*	U07000.062.0075	7/8-9X7.1/2*	U07000.087.0750	1.1/4-7X13 Inch*	U07000.125.1300
5/8-11X7/8 ft*	U07000.062.0087	7/8-9X8 Inch*	U07000.087.0800	1.1/4-7X14 Inch*	U07000.125.1400
5/8-11X1 Inch ft*	U07000.062.0100	7/8-9X9 Inch*	U07000.087.0900	1.1/4-7X15 Inch*	U07000.125.1500
5/8-11X1.1/4 ft*	U07000.062.0125	7/8-9X10 Inch*	U07000.087.1000	1.1/4-7X16 Inch*	U07000.125.1600
5/8-11X1.3/8 ft*	U07000.062.0137	7/8-9X11 Inch*	U07000.087.1100	1.1/4-7X18 Inch*	U07000.125.1800
5/8-11X1.1/2 ft*	U07000.062.0150	7/8-9X12 Inch*	U07000.087.1200	1.1/4-7X20 Inch*	U07000.125.2000
5/8-11X1.3/4 ft*	U07000.062.0175	7/8-9X14 Inch*	U07000.087.1400	1.3/8-6X3 Inch ft*	U07000.137.0300
5/8-11X2 Inch*	U07000.062.0200	7/8-9X16 Inch*	U07000.087.1600	1.3/8-6X3.1/2*	U07000.137.0350
5/8-11X2.1/4*	U07000.062.0225	7/8-9X18 Inch*	U07000.087.1800	1.3/8-6X4 Inch*	U07000.137.0400
5/8-11X2.1/2*	U07000.062.0250	1.-8X1.1/2 ft*	U07000.100.0150	1.3/8-6X4.1/2*	U07000.137.0450
5/8-11X2.3/4*	U07000.062.0275	1.-8X1.3/4 ft*	U07000.100.0175	1.3/8-6X5 Inch*	U07000.137.0500
5/8-11X3 Inch*	U07000.062.0300	1.-8X2 Inch ft*	U07000.100.0200	1.3/8-6X5.1/2*	U07000.137.0550
5/8-11X3.1/4*	U07000.062.0325	1.-8X2.1/4 ft*	U07000.100.0225	1.3/8-6X6 Inch*	U07000.137.0600
5/8-11X3.1/2*	U07000.062.0350	1.-8X2.1/2 ft*	U07000.100.0250	1.3/8-6X7 Inch*	U07000.137.0700
5/8-11X3.3/4*	U07000.062.0375	1.-8X2.3/4*	U07000.100.0275	1.3/8-6X8 Inch*	U07000.137.0800
5/8-11X4 Inch*	U07000.062.0400	1.-8X3 Inch*	U07000.100.0300	1.3/8-6X10 Inch*	U07000.137.1000
5/8-11X4.1/4*	U07000.062.0425	1.-8X3.1/4*	U07000.100.0325	1.3/8-6X11 Inch*	U07000.137.1100
5/8-11X4.1/2*	U07000.062.0450	1.-8X3.1/2*	U07000.100.0350	1.3/8-6X12 Inch*	U07000.137.1200
5/8-11X5 Inch*	U07000.062.0500	1.-8X3.3/4*	U07000.100.0375	1.3/8-6X14 Inch*	U07000.137.1400
5/8-11X5.1/2*	U07000.062.0550	1.-8X4 Inch*	U07000.100.0400	1.3/8-6X16 Inch*	U07000.137.1600
5/8-11X6 Inch*	U07000.062.0600	1.-8X4.1/4*	U07000.100.0425	1.3/8-6X18 Inch*	U07000.137.1800
5/8-11X6.1/2*	U07000.062.0650	1.-8X4.1/2*	U07000.100.0450	1.3/8-6X20 Inch*	U07000.137.2000
5/8-11X7 Inch*	U07000.062.0700	1.-8X4.3/4*	U07000.100.0475	1.1/2-6X2.1/2 ft*	U07000.150.0250
5/8-11X7.1/2*	U07000.062.0750	1.-8X5 Inch*	U07000.100.0500	1.1/2-6X2.3/4 ft*	U07000.150.0275
5/8-11X8 Inch*	U07000.062.0800	1.-8X5.1/2*	U07000.100.0550	1.1/2-6X3 Inch ft*	U07000.150.0300
5/8-11X8.1/2*	U07000.062.0850	1.-8X6 Inch*	U07000.100.0600	1.1/2-6X3.1/2 ft*	U07000.150.0350
5/8-11X9 Inch*	U07000.062.0900	1.-8X6.1/2*	U07000.100.0650	1.1/2-6X4 Inch*	U07000.150.0400
5/8-11X9.1/2*	U07000.062.0950	1.-8X7 Inch*	U07000.100.0700	1.1/2-6X4.1/2*	U07000.150.0450
5/8-11X10 Inch*	U07000.062.1000	1.-8X7.1/2*	U07000.100.0750	1.1/2-6X5 Inch*	U07000.150.0500
5/8-11X11 Inch*	U07000.062.1100	1.-8X8 Inch*	U07000.100.0800	1.1/2-6X5.1/2*	U07000.150.0550
3/4-10X1 Inch ft*	U07000.075.0100	1.-8X8.1/2*	U07000.100.0850	1.1/2-6X6 Inch*	U07000.150.0600
3/4-10X1.1/4 ft*	U07000.075.0125	1.-8X9 Inch*	U07000.100.0900	1.1/2-6X6.1/2*	U07000.150.0650
3/4-10X1.1/2 ft*	U07000.075.0150	1.-8X9.1/2*	U07000.100.0950	1.1/2-6X7 Inch*	U07000.150.0700
3/4-10X1.3/4 ft*	U07000.075.0175	1.-8X10 Inch*	U07000.100.1000	1.1/2-6X8 Inch*	U07000.150.0800
3/4-10X2 Inch ft*	U07000.075.0200	1.-8X11 Inch*	U07000.100.1100	1.1/2-6X8 Inch*	U07000.150.0800
3/4-10X2.1/4*	U07000.075.0225	1.-8X12 Inch*	U07000.100.1200	1.1/2-6X9 Inch*	U07000.150.0900
3/4-10X2.1/2*	U07000.075.0250	1.-8X13 Inch*	U07000.100.1300	1.1/2-6X10 Inch*	U07000.150.1000
3/4-10X2.3/4*	U07000.075.0275	1.-8X14 Inch*	U07000.100.1400	1.1/2-6X11 Inch*	U07000.150.1100
3/4-10X3 Inch*	U07000.075.0300	1.-8X16 Inch*	U07000.100.1600	1.1/2-6X12 Inch*	U07000.150.1200
3/4-10X3.1/4*	U07000.075.0325	1.-8X18 Inch*	U07000.100.1800	1.1/2-6X13 Inch*	U07000.150.1300
3/4-10X3.1/2*	U07000.075.0350	1.-8X20 Inch*	U07000.100.2000	1.1/2-6X14 Inch*	U07000.150.1400
3/4-10X3.3/4*	U07000.075.0375	1.1/8-7X2 Inch ft*	U07000.112.0200	1.1/2-6X15 Inch*	U07000.150.1500
3/4-10X4 Inch*	U07000.075.0400	1.1/8-7X2.1/2 ft*	U07000.112.0250	1.1/2-6X16 Inch*	U07000.150.1600
3/4-10X4.1/4*	U07000.075.0425	1.1/8-7X3 Inch*	U07000.112.0300	1.1/2-6X18 Inch*	U07000.150.1800
3/4-10X4.1/2*	U07000.075.0450	1.1/8-7X3.1/2*	U07000.112.0350	1.1/2-6X20 Inch*	U07000.150.2000
3/4-10X4.3/4*	U07000.075.0475	1.1/8-7X4 Inch*	U07000.112.0400	1.3/4-5X3 Inch ft*	U07000.175.0300
3/4-10X5 Inch*	U07000.075.0500	1.1/8-7X4.1/2*	U07000.112.0450	1.3/4-5X3.1/2 ft*	U07000.175.0350
3/4-10X5.1/2*	U07000.075.0550	1.1/8-7X5 Inch*	U07000.112.0500	1.3/4-5X4 Inch ft*	U07000.175.0400
3/4-10X6 Inch*	U07000.075.0600	1.1/8-7X5.1/2*	U07000.112.0550	1.3/4-5X4.1/2*	U07000.175.0450
3/4-10X6.1/2*	U07000.075.0650	1.1/8-7X6 Inch*	U07000.112.0600	1.3/4-5X5 Inch*	U07000.175.0500
3/4-10X7 Inch*	U07000.075.0700	1.1/8-7X7 Inch*	U07000.112.0700	1.3/4-5X5.1/2*	U07000.175.0550
3/4-10X7.1/2*	U07000.075.0750	1.1/8-7X8 Inch*	U07000.112.0800	1.3/4-5X6 Inch*	U07000.175.0600
3/4-10X8 Inch*	U07000.075.0800	1.1/8-7X9 Inch*	U07000.112.0900	1.3/4-5X7 Inch*	U07000.175.0700
3/4-10X8.1/2*	U07000.075.0850	1.1/8-7X10 Inch*	U07000.112.1000	1.3/4-5X8 Inch*	U07000.175.0800
3/4-10X9 Inch*	U07000.075.0900	1.1/8-7X11 Inch*	U07000.112.1100	1.3/4-5X9 Inch*	U07000.175.0900
3/4-10X9.1/2*	U07000.075.0950	1.1/8-7X12 Inch*	U07000.112.1200	1.3/4-5X10 Inch*	U07000.175.1000

U07000 Hexagon socket head cap screw UNC 1936 series								
d x L	☒	Art.number	d x L	☒	Art.number	d x L	☒	Art.number
1.3/4-5X12 Inch*	1	U07000.175.1200	2.-4,5X4. 1/2 ft*	1	U07000.200.0450	2.-4,5X12 Inch*	1	U07000.200.1200
1.3/4-5X14 Inch*	1	U07000.175.1400	2.-4,5X5 Inch ft*	1	U07000.200.0500	2.-4,5X14 Inch*	1	U07000.200.1400
1.3/4-5X15 Inch*	1	U07000.175.1500	2.-4,5X5. 1/2*	1	U07000.200.0550	2.-4,5X15 Inch*	1	U07000.200.1500
1.3/4-5X16 Inch*	1	U07000.175.1600	2.-4,5X6 Inch*	1	U07000.200.0600	2.-4,5X16 Inch*	1	U07000.200.1600
1.3/4-5X18 Inch*	1	U07000.175.1800	2.-4,5X7 Inch*	1	U07000.200.0700	2.-4,5X18 Inch*	1	U07000.200.1800
1.3/4-5X20 Inch*	1	U07000.175.2000	2.-4,5X8 Inch*	1	U07000.200.0800	2.-4,5X20 Inch*	1	U07000.200.2000
2.-4,5X4 Inch ft*	1	U07000.200.0400	2.-4,5X9 Inch*	1	U07000.200.0900			
			2.-4,5X10 Inch*	1	U07000.200.1000			

* ft = fully threaded

U07001 Hexagon socket head cap screw UNC 1936 series		X05A
Thread	Unified National Coarse	
Material	Steel	
Class	Grade 8	
Surface treatment	Zinc plated	

d x L	☒	Art.number	d x L	☒	Art.number	d x L	☒	Art.number
NO.2-56X1/4 ft*	100	U07001.008.0025	NO.10-24X1. 1/4*	100	U07001.019.0125	3/8-16X2.3/4*	25	U07001.037.0275
NO.2-56X3/8 ft*	100	U07001.008.0037	NO.10-24X1. 1/2*	100	U07001.019.0150	3/8-16X3 Inch*	10	U07001.037.0300
			NO.10-24X1.3/4*	100	U07001.019.0175	3/8-16X3. 1/2*	10	U07001.037.0350
			NO.10-24X2 Inch*	100	U07001.019.0200	3/8-16X4 Inch*	10	U07001.037.0400
NO.3-48X1/4 ft*	100	U07001.009.0025						
NO.3-48X3/8 ft*	100	U07001.009.0037	1/4-20X3/8 ft*	100	U07001.025.0037	1/2-13X3/4 ft*	10	U07001.050.0075
NO.3-48X5/8 ft*	100	U07001.009.0062	1/4-20X1/2 ft*	100	U07001.025.0050	1/2-13X1 Inch ft*	10	U07001.050.0100
			1/4-20X5/8 ft*	100	U07001.025.0062	1/2-13X1. 1/4 ft*	10	U07001.050.0125
NO.4-40X3/16 ft*	100	U07001.011.0018	1/4-20X3/4 ft*	100	U07001.025.0075	1/2-13X1. 1/2 ft*	10	U07001.050.0150
NO.4-40X1/4 ft*	100	U07001.011.0025	1/4-20X7/8 ft*	100	U07001.025.0087	1/2-13X1.3/4*	10	U07001.050.0175
NO.4-40X3/8 ft*	100	U07001.011.0037	1/4-20X1 Inch ft*	100	U07001.025.0100	1/2-13X2 Inch*	10	U07001.050.0200
NO.4-40X1/2 ft*	100	U07001.011.0050	1/4-20X1. 1/4*	100	U07001.025.0125	1/2-13X2. 1/4*	10	U07001.050.0225
NO.4-40X5/8 ft*	100	U07001.011.0062	1/4-20X1. 1/2*	100	U07001.025.0150	1/2-13X2. 1/2*	10	U07001.050.0250
NO.4-40X3/4 ft*	100	U07001.011.0075	1/4-20X1.3/4*	100	U07001.025.0175	1/2-13X2.3/4*	10	U07001.050.0275
NO.4-40X1 Inch*	100	U07001.011.0100	1/4-20X2 Inch*	50	U07001.025.0200	1/2-13X3 Inch*	5	U07001.050.0300
			1/4-20X2. 1/4*	50	U07001.025.0225	1/2-13X3. 1/2*	5	U07001.050.0350
NO.5-40X1/4 ft*	100	U07001.012.0025	1/4-20X2. 1/2*	50	U07001.025.0250	1/2-13X4 Inch*	5	U07001.050.0400
NO.5-40X3/8 ft*	100	U07001.012.0037	1/4-20X3 Inch*	25	U07001.025.0300			
NO.5-40X1/2 ft*	100	U07001.012.0050						
NO.5-40X5/8 ft*	100	U07001.012.0062	5/16-18X1/2 ft*	100	U07001.031.0050	5/8-11X1. 1/4 ft*	10	U07001.062.0125
NO.5-40X3/4 ft*	100	U07001.012.0075	5/16-18X5/8 ft*	100	U07001.031.0062	5/8-11X1. 1/2 ft*	10	U07001.062.0150
			5/16-18X3/4 ft*	100	U07001.031.0075	5/8-11X1.3/4 ft*	10	U07001.062.0175
NO.6-32X1/4 ft*	100	U07001.013.0025	5/16-18X7/8 ft*	100	U07001.031.0087	5/8-11X2 Inch*	5	U07001.062.0200
NO.6-32X3/8 ft*	100	U07001.013.0037	5/16-18X7/8 ft*	100	U07001.031.0087	5/8-11X2. 1/4*	5	U07001.062.0225
NO.6-32X1/2 ft*	100	U07001.013.0050	5/16-18X1 Inch ft*	50	U07001.031.0100	5/8-11X2. 1/2*	5	U07001.062.0250
NO.6-32X5/8 ft*	100	U07001.013.0062	5/16-18X1. 1/4*	50	U07001.031.0125	5/8-11X2.3/4*	5	U07001.062.0275
NO.6-32X3/4 ft*	100	U07001.013.0075	5/16-18X1. 1/2*	50	U07001.031.0150	5/8-11X3 Inch*	5	U07001.062.0300
NO.6-32X1 Inch*	100	U07001.013.0100	5/16-18X1.3/4*	50	U07001.031.0175	5/8-11X3. 1/2*	5	U07001.062.0350
			5/16-18X2 Inch*	50	U07001.031.0200	5/8-11X4 Inch*	5	U07001.062.0400
NO.8-32X1/4 ft*	100	U07001.016.0025	5/16-18X2. 1/4*	25	U07001.031.0225			
NO.8-32X3/8 ft*	100	U07001.016.0037	5/16-18X2. 1/2*	25	U07001.031.0250	3/4-10X1. 1/4 ft*	5	U07001.075.0125
NO.8-32X1/2 ft*	100	U07001.016.0050	5/16-18X3 Inch*	25	U07001.031.0300	3/4-10X1. 1/2 ft*	5	U07001.075.0150
NO.8-32X5/8 ft*	100	U07001.016.0062	5/16-18X3. 1/2*	25	U07001.031.0350	3/4-10X1.3/4 ft*	5	U07001.075.0175
NO.8-32X3/4 ft*	100	U07001.016.0075	5/16-18X4 Inch*	10	U07001.031.0400	3/4-10X2 Inch ft*	5	U07001.075.0200
NO.8-32X7/8 ft*	100	U07001.016.0087				3/4-10X2. 1/4*	5	U07001.075.0225
NO.8-32X1 Inch*	100	U07001.016.0100	3/8-16X1/2 ft*	50	U07001.037.0050	3/4-10X2. 1/2*	5	U07001.075.0250
NO.8-32X1. 1/4*	100	U07001.016.0125	3/8-16X3/4 ft*	50	U07001.037.0075	3/4-10X2.3/4*	5	U07001.075.0275
NO.8-32X1. 1/2*	100	U07001.016.0150	3/8-16X7/8 ft*	50	U07001.037.0087	3/4-10X3 Inch*	5	U07001.075.0300
			3/8-16X1 Inch ft*	50	U07001.037.0100	3/4-10X3. 1/2*	5	U07001.075.0350
NO.10-24X3/8 ft*	100	U07001.019.0037	3/8-16X1. 1/4 ft*	50	U07001.037.0125	3/4-10X4 Inch*	5	U07001.075.0400
NO.10-24X1/2 ft*	100	U07001.019.0050	3/8-16X1. 1/2*	25	U07001.037.0150	3/4-10X5 Inch*	5	U07001.075.0500
NO.10-24X5/8 ft*	100	U07001.019.0062	3/8-16X1.3/4*	25	U07001.037.0175	3/4-10X6. 1/2*	5	U07001.075.0650
NO.10-24X3/4 ft*	100	U07001.019.0075	3/8-16X2 Inch*	25	U07001.037.0200	3/4-10X7 Inch*	5	U07001.075.0700
NO.10-24X7/8 ft*	100	U07001.019.0087	3/8-16X2. 1/4*	25	U07001.037.0225	3/4-10X8 Inch*	5	U07001.075.0800
NO.10-24X1 Inch*	100	U07001.019.0100	3/8-16X2. 1/2*	25	U07001.037.0250			

* ft = fully threaded

07260 Hexagon socket head cap screw UNC 1936 series		X05A
Thread	Unified National Coarse	
Material	Steel	
Class	12.9	
Surface treatment	Mechanical zinc plated	

d x L	☒	Art.number	d x L	☒	Art.number	d x L	☒	Art.number
1/4X3/8 ft	100	07260.063.009	5/16X1/2 ft	100	07260.079.012	3/8X7/8 ft	100	07260.096.022
1/4X5/8 ft	100	07260.063.015	5/16X1 Inch ft	100	07260.079.025	3/8X1. 1/4 ft	100	07260.096.031
1/4X1. 1/4	100	07260.063.031						

07260 Hexagon socket head cap screw UNC 1936 series

d x L	Art.number	d x L	Art.number	d x L	Art.number
3/8X1.1/2	100 07260.096.038	1/2X5/8 ft	50 07260.127.015	5/8X2.1/4	25 07260.158.057
3/8X1.3/4	50 07260.096.044	1/2X3/4 ft	50 07260.127.019		
1/2X1/2 ft	50 07260.127.012	1/2X1 Inch ft	50 07260.127.025		
		1/2X1.1/4 ft	50 07260.127.031		

• ft = fully threaded

U51050 Hexagon socket head cap screw UNC 1936 series
X15A

Thread Unified National Coarse
Material Stainless steel A2 (AISI 304/18-8)
Class F837B



d x L	Art.number	d x L	Art.number	d x L	Art.number
NO.1-64X1/8 ft*	100 U51050.007.0012	NO.6-32X3/16 ft*	100 U51050.013.0018	1/4-20X1/2 ft*	100 U51050.025.0050
NO.1-64X3/16 ft*	100 U51050.007.0018	NO.6-32X1/4 ft*	100 U51050.013.0025	1/4-20X5/8 ft*	100 U51050.025.0062
NO.1-64X1/4 ft*	100 U51050.007.0025	NO.6-32X5/16 ft*	100 U51050.013.0031	1/4-20X3/4 ft*	100 U51050.025.0075
NO.1-64X5/16 ft*	100 U51050.007.0031	NO.6-32X3/8 ft*	100 U51050.013.0037	1/4-20X7/8 ft*	100 U51050.025.0087
NO.1-64X3/8 ft*	100 U51050.007.0037	NO.6-32X7/16 ft*	100 U51050.013.0043	1/4-20X1 Inch ft*	100 U51050.025.0100
NO.1-64X1/2 ft*	100 U51050.007.0050	NO.6-32X1/2 ft*	100 U51050.013.0050	1/4-20X1.1/8*	100 U51050.025.0112
NO.1-64X5/8 ft*	100 U51050.007.0062	NO.6-32X5/8 ft*	100 U51050.013.0062	1/4-20X1.1/4*	100 U51050.025.0125
NO.1-64X3/4*	100 U51050.007.0075	NO.6-32X3/4 ft*	100 U51050.013.0075	1/4-20X1.3/8*	100 U51050.025.0137
NO.1-64X1 Inch*	100 U51050.007.0100	NO.6-32X7/8*	100 U51050.013.0087	1/4-20X1.1/2*	100 U51050.025.0150
		NO.6-32X1 Inch*	100 U51050.013.0100	1/4-20X1.3/4*	100 U51050.025.0175
NO.2-56X1/8 ft*	100 U51050.008.0012	NO.6-32X1.1/8*	100 U51050.013.0112	1/4-20X2 Inch*	50 U51050.025.0200
NO.2-56X3/16 ft*	100 U51050.008.0018	NO.6-32X1.1/4*	100 U51050.013.0125	1/4-20X2.1/4*	50 U51050.025.0225
NO.2-56X1/4 ft*	100 U51050.008.0025	NO.6-32X1.1/2*	100 U51050.013.0150	1/4-20X2.1/2*	50 U51050.025.0250
NO.2-56X5/16 ft*	100 U51050.008.0031	NO.6-32X1.3/4*	100 U51050.013.0175	1/4-20X2.3/4*	50 U51050.025.0275
NO.2-56X3/8 ft*	100 U51050.008.0037	NO.6-32X2 Inch*	100 U51050.013.0200	1/4-20X3 Inch*	25 U51050.025.0300
NO.2-56X7/16 ft*	100 U51050.008.0043	NO.6-32X2.1/4*	100 U51050.013.0225	1/4-20X3.1/4*	25 U51050.025.0325
NO.2-56X1/2 ft*	100 U51050.008.0050	NO.6-32X2.1/2*	100 U51050.013.0250	1/4-20X3.1/2*	25 U51050.025.0350
NO.2-56X5/8 ft*	100 U51050.008.0062			1/4-20X3.3/4*	25 U51050.025.0375
NO.2-56X3/4*	100 U51050.008.0075	NO.8-32X3/16 ft*	100 U51050.016.0018	1/4-20X4 Inch*	25 U51050.025.0400
NO.2-56X7/8*	100 U51050.008.0087	NO.8-32X1/4 ft*	100 U51050.016.0025	1/4-20X4.1/2*	25 U51050.025.0450
NO.2-56X1 Inch*	100 U51050.008.0100	NO.8-32X5/16 ft*	100 U51050.016.0031	1/4-20X5 Inch*	25 U51050.025.0500
NO.2-56X1.1/4*	100 U51050.008.0125	NO.8-32X3/8 ft*	100 U51050.016.0037		
NO.2-56X1.1/2*	100 U51050.008.0150	NO.8-32X7/16 ft*	100 U51050.016.0043	5/16-18X3/8 ft*	100 U51050.031.0037
		NO.8-32X1/2 ft*	100 U51050.016.0050	5/16-18X7/16 ft*	100 U51050.031.0043
NO.3-48X1/8 ft*	100 U51050.009.0012	NO.8-32X5/8 ft*	100 U51050.016.0062	5/16-18X1/2 ft*	100 U51050.031.0050
NO.3-48X3/16 ft*	100 U51050.009.0018	NO.8-32X3/4 ft*	100 U51050.016.0075	5/16-18X5/8 ft*	100 U51050.031.0062
NO.3-48X1/4 ft*	100 U51050.009.0025	NO.8-32X7/8 ft*	100 U51050.016.0087	5/16-18X3/4 ft*	100 U51050.031.0075
NO.3-48X5/16 ft*	100 U51050.009.0031	NO.8-32X1 Inch*	100 U51050.016.0100	5/16-18X7/8 ft*	100 U51050.031.0087
NO.3-48X3/8 ft*	100 U51050.009.0037	NO.8-32X1.1/8*	100 U51050.016.0112	5/16-18X1 Inch ft*	50 U51050.031.0100
NO.3-48X1/2 ft*	100 U51050.009.0050	NO.8-32X1.1/4*	100 U51050.016.0125	5/16-18X1.1/8 ft*	50 U51050.031.0112
NO.3-48X5/8 ft*	100 U51050.009.0062	NO.8-32X1.3/8*	100 U51050.016.0137	5/16-18X1.1/4*	50 U51050.031.0125
NO.3-48X3/4*	100 U51050.009.0075	NO.8-32X1.1/2*	100 U51050.016.0150	5/16-18X1.1/2*	50 U51050.031.0150
NO.3-48X7/8*	100 U51050.009.0087	NO.8-32X1.3/4*	100 U51050.016.0175	5/16-18X1.3/4*	50 U51050.031.0175
NO.3-48X1 Inch*	100 U51050.009.0100	NO.8-32X2 Inch*	100 U51050.016.0200	5/16-18X2 Inch*	50 U51050.031.0200
		NO.8-32X2.1/4*	100 U51050.016.0225	5/16-18X2.1/4*	25 U51050.031.0225
NO.4-40X1/8 ft*	100 U51050.011.0012	NO.8-32X2.1/2*	100 U51050.016.0250	5/16-18X2.1/2*	25 U51050.031.0250
NO.4-40X3/16 ft*	100 U51050.011.0018	NO.8-32X2.3/4*	100 U51050.016.0275	5/16-18X2.3/4*	25 U51050.031.0275
NO.4-40X1/4 ft*	100 U51050.011.0025	NO.8-32X3 Inch*	100 U51050.016.0300	5/16-18X3 Inch*	25 U51050.031.0300
NO.4-40X5/16 ft*	100 U51050.011.0031			5/16-18X3.1/4*	25 U51050.031.0325
NO.4-40X3/8 ft*	100 U51050.011.0037	NO.10-24X3/16 ft*	100 U51050.019.0018	5/16-18X3.1/2*	25 U51050.031.0350
NO.4-40X7/16 ft*	100 U51050.011.0043	NO.10-24X1/4 ft*	100 U51050.019.0025	5/16-18X3.3/4*	25 U51050.031.0375
NO.4-40X1/2 ft*	100 U51050.011.0050	NO.10-24X5/16 ft*	100 U51050.019.0031	5/16-18X4 Inch*	10 U51050.031.0400
NO.4-40X5/8 ft*	100 U51050.011.0062	NO.10-24X3/8 ft*	100 U51050.019.0037	5/16-18X4.1/2*	10 U51050.031.0450
NO.4-40X3/4 ft*	100 U51050.011.0075	NO.10-24X7/16 ft*	100 U51050.019.0043	5/16-18X5 Inch*	10 U51050.031.0500
NO.4-40X7/8*	100 U51050.011.0087	NO.10-24X1/2 ft*	100 U51050.019.0050	5/16-18X5.1/2*	10 U51050.031.0550
NO.4-40X1 Inch*	100 U51050.011.0100	NO.10-24X5/8 ft*	100 U51050.019.0062	5/16-18X6 Inch*	10 U51050.031.0600
NO.4-40X1.1/8*	100 U51050.011.0112	NO.10-24X3/4 ft*	100 U51050.019.0075		
NO.4-40X1.1/4*	100 U51050.011.0125	NO.10-24X7/8 ft*	100 U51050.019.0087	3/8-16X1/2 ft*	50 U51050.037.0050
NO.4-40X1.3/8*	100 U51050.011.0137	NO.10-24X1 Inch*	100 U51050.019.0100	3/8-16X5/8 ft*	50 U51050.037.0062
NO.4-40X1.1/2*	100 U51050.011.0150	NO.10-24X1.1/8*	100 U51050.019.0112	3/8-16X3/4 ft*	50 U51050.037.0075
NO.4-40X1.3/4*	100 U51050.011.0175	NO.10-24X1.1/4*	100 U51050.019.0125	3/8-16X7/8 ft*	50 U51050.037.0087
NO.4-40X2 Inch*	100 U51050.011.0200	NO.10-24X1.3/8*	100 U51050.019.0137	3/8-16X1 Inch ft*	50 U51050.037.0100
		NO.10-24X1.1/2*	100 U51050.019.0150	3/8-16X1.1/8 ft*	50 U51050.037.0112
NO.5-40X1/8 ft*	100 U51050.012.0012	NO.10-24X1.3/4*	100 U51050.019.0175	3/8-16X1.1/4 ft*	50 U51050.037.0125
NO.5-40X3/16 ft*	100 U51050.012.0018	NO.10-24X2 Inch*	100 U51050.019.0200	3/8-16X1.3/8*	50 U51050.037.0137
NO.5-40X1/4 ft*	100 U51050.012.0025	NO.10-24X2.1/4*	100 U51050.019.0225	3/8-16X1.1/2*	25 U51050.037.0150
NO.5-40X5/16 ft*	100 U51050.012.0031	NO.10-24X2.1/2*	100 U51050.019.0250	3/8-16X1.3/4*	25 U51050.037.0175
NO.5-40X3/8 ft*	100 U51050.012.0037	NO.10-24X2.3/4*	100 U51050.019.0275	3/8-16X2 Inch*	25 U51050.037.0200
NO.5-40X1/2 ft*	100 U51050.012.0050	NO.10-24X3 Inch*	100 U51050.019.0300	3/8-16X2.1/4*	25 U51050.037.0225
NO.5-40X5/8 ft*	100 U51050.012.0062	NO.10-24X3.1/2*	100 U51050.019.0350	3/8-16X2.1/2*	25 U51050.037.0250
NO.5-40X3/4 ft*	100 U51050.012.0075	NO.10-24X4 Inch*	100 U51050.019.0400	3/8-16X2.3/4*	25 U51050.037.0275
NO.5-40X7/8*	100 U51050.012.0087			3/8-16X3 Inch*	10 U51050.037.0300
NO.5-40X1 Inch*	100 U51050.012.0100	1/4-20X5/16 ft*	100 U51050.025.0031	3/8-16X3.1/4*	10 U51050.037.0325
NO.5-40X1.1/4*	100 U51050.012.0125	1/4-20X3/8 ft*	100 U51050.025.0037	3/8-16X3.1/2*	10 U51050.037.0350
		1/4-20X7/16 ft*	100 U51050.025.0043	3/8-16X3.3/4*	10 U51050.037.0375

U51050 Hexagon socket head cap screw UNC 1936 series								
d x L	☒	Art.number	d x L	☒	Art.number	d x L	☒	Art.number
3/8-16X4 Inch*	10	U51050.037.0400	1/2-13X5.1/2*	5	U51050.050.0550	3/4-10X3 Inch*	5	U51050.075.0300
3/8-16X4.1/2*	10	U51050.037.0450	1/2-13X6 Inch*	5	U51050.050.0600	3/4-10X3.1/2*	5	U51050.075.0350
3/8-16X5 Inch*	10	U51050.037.0500	1/2-13X6.1/2*	5	U51050.050.0650	3/4-10X4 Inch*	5	U51050.075.0400
3/8-16X5.1/2*	10	U51050.037.0550	1/2-13X7 Inch*	5	U51050.050.0700	3/4-10X4.1/2*	5	U51050.075.0450
3/8-16X6 Inch*	10	U51050.037.0600	1/2-13X7.1/2*	5	U51050.050.0750	3/4-10X5 Inch*	5	U51050.075.0500
3/8-16X6.1/2*	5	U51050.037.0650	1/2-13X8 Inch*	5	U51050.050.0800	3/4-10X6 Inch*	5	U51050.075.0600
3/8-16X7 Inch*	5	U51050.037.0700				3/4-10X6.1/2*	5	U51050.075.0650
			9/16-12X1 Inch ft*	10	U51050.056.0100	3/4-10X7 Inch*	5	U51050.075.0700
7/16-14X3/4 ft*	25	U51050.043.0075	9/16-12X1.1/2 ft*	10	U51050.056.0150	3/4-10X8 Inch*	5	U51050.075.0800
7/16-14X1 Inch ft*	25	U51050.043.0100	9/16-12X2.1/2*	5	U51050.056.0250			
7/16-14X1.1/4 ft*	25	U51050.043.0125	9/16-12X3 Inch*	5	U51050.056.0300	7/8-9X2 Inch ft*	5	U51050.087.0200
7/16-14X1.1/2*	25	U51050.043.0150				7/8-9X2.1/4 ft*	5	U51050.087.0225
7/16-14X1.3/4*	10	U51050.043.0175	5/8-11X1 Inch ft*	10	U51050.062.0100	7/8-9X2.1/2*	5	U51050.087.0250
7/16-14X2 Inch*	10	U51050.043.0200	5/8-11X1.1/4 ft*	10	U51050.062.0125	7/8-9X2.3/4*	5	U51050.087.0275
7/16-14X2.1/4*	10	U51050.043.0225	5/8-11X1.1/2 ft*	10	U51050.062.0150	7/8-9X3 Inch*	5	U51050.087.0300
7/16-14X2.1/2*	10	U51050.043.0250	5/8-11X1.3/4 ft*	10	U51050.062.0175	7/8-9X3.1/2*	5	U51050.087.0350
7/16-14X3 Inch*	10	U51050.043.0300	5/8-11X2 Inch*	5	U51050.062.0200	7/8-9X4 Inch*	5	U51050.087.0400
7/16-14X3.1/2*	5	U51050.043.0350	5/8-11X2.1/4*	5	U51050.062.0225	7/8-9X4.1/2*	5	U51050.087.0450
7/16-14X4 Inch*	5	U51050.043.0400	5/8-11X2.1/2*	5	U51050.062.0250	7/8-9X5 Inch*	5	U51050.087.0500
			5/8-11X2.3/4*	5	U51050.062.0275	7/8-9X6 Inch*	5	U51050.087.0600
1/2-13X1/2 ft*	10	U51050.050.0050	5/8-11X3 Inch*	5	U51050.062.0300	7/8-9X6.1/2*	5	U51050.087.0650
1/2-13X5/8 ft*	10	U51050.050.0062	5/8-11X3.1/2*	5	U51050.062.0350	7/8-9X7 Inch*	5	U51050.087.0700
1/2-13X3/4 ft*	10	U51050.050.0075	5/8-11X4 Inch*	5	U51050.062.0400	7/8-9X8 Inch*	1	U51050.087.0800
1/2-13X7/8 ft*	10	U51050.050.0087	5/8-11X4.1/2*	5	U51050.062.0450			
1/2-13X1 Inch ft*	10	U51050.050.0100	5/8-11X5 Inch*	5	U51050.062.0500	1.-8X2 Inch ft*	5	U51050.100.0200
1/2-13X1.1/4 ft*	10	U51050.050.0125	5/8-11X5.1/2*	5	U51050.062.0550	1.-8X2.1/4 ft*	5	U51050.100.0225
1/2-13X1.1/2 ft*	10	U51050.050.0150	5/8-11X6 Inch*	5	U51050.062.0600	1.-8X2.1/2 ft*	5	U51050.100.0250
1/2-13X1.3/4*	10	U51050.050.0175	5/8-11X7 Inch*	5	U51050.062.0700	1.-8X2.3/4*	5	U51050.100.0275
1/2-13X2 Inch*	10	U51050.050.0200	5/8-11X8 Inch*	5	U51050.062.0800	1.-8X3 Inch*	5	U51050.100.0300
1/2-13X2.1/4*	10	U51050.050.0225				1.-8X3.1/2*	5	U51050.100.0350
1/2-13X2.1/2*	10	U51050.050.0250	3/4-10X1 Inch ft*	5	U51050.075.0100	1.-8X4 Inch*	5	U51050.100.0400
1/2-13X2.3/4*	10	U51050.050.0275	3/4-10X1.1/4 ft*	5	U51050.075.0125	1.-8X4.1/2*	5	U51050.100.0450
1/2-13X3 Inch*	5	U51050.050.0300	3/4-10X1.1/2 ft*	5	U51050.075.0150	1.-8X5 Inch*	5	U51050.100.0500
1/2-13X3.1/4*	5	U51050.050.0325	3/4-10X1.3/4 ft*	5	U51050.075.0175	1.-8X6 Inch*	5	U51050.100.0600
1/2-13X3.1/2*	5	U51050.050.0350	3/4-10X2 Inch ft*	5	U51050.075.0200	1.-8X6.1/2*	1	U51050.100.0650
1/2-13X4 Inch*	5	U51050.050.0400	3/4-10X2.1/4*	5	U51050.075.0225	1.-8X7 Inch*	1	U51050.100.0700
1/2-13X4.1/2*	5	U51050.050.0450	3/4-10X2.1/2*	5	U51050.075.0250	1.-8X8 Inch*	1	U51050.100.0800
1/2-13X5 Inch*	5	U51050.050.0500	3/4-10X2.3/4*	5	U51050.075.0275			

* ft = fully threaded

U55050 Hexagon socket head cap screw UNC 1936 series X15A

Thread	Unified National Coarse
Material	Stainless steel A4 (AISI 316/18-10)
Class	F837E





d x L	☒	Art.number	d x L	☒	Art.number	d x L	☒	Art.number
NO.2-56X1/4 ft*	100	U55050.008.0025	NO.8-32X1/4 ft*	100	U55050.016.0025	1/4-20X2.1/4*	50	U55050.025.0225
NO.2-56X3/8 ft*	100	U55050.008.0037	NO.8-32X3/8 ft*	100	U55050.016.0037	1/4-20X2.1/2*	50	U55050.025.0250
			NO.8-32X1/2 ft*	100	U55050.016.0050	1/4-20X3 Inch*	25	U55050.025.0300
NO.3-48X1/4 ft*	100	U55050.009.0025	NO.8-32X5/8 ft*	100	U55050.016.0062			
NO.3-48X5/8 ft*	100	U55050.009.0062	NO.8-32X7/8 ft*	100	U55050.016.0075	5/16-18X1/2 ft*	100	U55050.031.0050
			NO.8-32X1 Inch*	100	U55050.016.0100	5/16-18X5/8 ft*	100	U55050.031.0062
NO.4-40X3/16 ft*	100	U55050.011.0018	NO.8-32X1.1/4*	100	U55050.016.0125	5/16-18X3/4 ft*	100	U55050.031.0075
NO.4-40X1/4 ft*	100	U55050.011.0025	NO.8-32X1.1/2*	100	U55050.016.0150	5/16-18X7/8 ft*	100	U55050.031.0087
NO.4-40X5/16 ft*	100	U55050.011.0031				5/16-18X1 Inch ft*	50	U55050.031.0100
NO.4-40X3/8 ft*	100	U55050.011.0037	NO.10-24X3/8 ft*	100	U55050.019.0037	5/16-18X1.1/4*	50	U55050.031.0125
NO.4-40X1/2 ft*	100	U55050.011.0050	NO.10-24X1/2 ft*	100	U55050.019.0050	5/16-18X1.1/2*	50	U55050.031.0150
NO.4-40X5/8 ft*	100	U55050.011.0062	NO.10-24X5/8 ft*	100	U55050.019.0062	5/16-18X1.3/4*	50	U55050.031.0175
NO.4-40X3/4 ft*	100	U55050.011.0075	NO.10-24X3/4 ft*	100	U55050.019.0075	5/16-18X2 Inch*	50	U55050.031.0200
NO.4-40X1 Inch*	100	U55050.011.0100	NO.10-24X7/8 ft*	100	U55050.019.0087	5/16-18X2.1/4*	25	U55050.031.0225
			NO.10-24X1 Inch*	100	U55050.019.0100	5/16-18X2.1/2*	25	U55050.031.0250
NO.5-40X1/4 ft*	100	U55050.012.0025	NO.10-24X1.1/4*	100	U55050.019.0125	5/16-18X3 Inch*	25	U55050.031.0300
NO.5-40X3/8 ft*	100	U55050.012.0037	NO.10-24X1.1/2*	100	U55050.019.0150	5/16-18X3.1/2*	25	U55050.031.0350
NO.5-40X1/2 ft*	100	U55050.012.0050	NO.10-24X1.3/4*	100	U55050.019.0175	5/16-18X4 Inch*	10	U55050.031.0400
NO.5-40X5/8 ft*	100	U55050.012.0062	NO.10-24X2 Inch*	100	U55050.019.0200			
NO.5-40X3/4 ft*	100	U55050.012.0075				3/8-16X1/2 ft*	50	U55050.037.0050
			1/4-20X3/8 ft*	100	U55050.025.0037	3/8-16X5/8 ft*	50	U55050.037.0062
NO.6-32X1/4 ft*	100	U55050.013.0025	1/4-20X1/2 ft*	100	U55050.025.0050	3/8-16X3/4 ft*	50	U55050.037.0075
NO.6-32X5/16 ft*	100	U55050.013.0031	1/4-20X5/8 ft*	100	U55050.025.0062	3/8-16X1 Inch ft*	50	U55050.037.0100
NO.6-32X3/8 ft*	100	U55050.013.0037	1/4-20X3/4 ft*	100	U55050.025.0075	3/8-16X1.1/4 ft*	50	U55050.037.0125
NO.6-32X1/2 ft*	100	U55050.013.0050	1/4-20X7/8 ft*	100	U55050.025.0087	3/8-16X1.1/2*	25	U55050.037.0150
NO.6-32X5/8 ft*	100	U55050.013.0062	1/4-20X1 Inch ft*	100	U55050.025.0100	3/8-16X1.3/4*	25	U55050.037.0175
NO.6-32X3/4 ft*	100	U55050.013.0075	1/4-20X1.1/4*	100	U55050.025.0125	3/8-16X2 Inch*	25	U55050.037.0200
NO.6-32X1 Inch*	100	U55050.013.0100	1/4-20X1.1/2*	100	U55050.025.0150	3/8-16X2.1/2*	25	U55050.037.0250
NO.6-32X1.1/4*	100	U55050.013.0125	1/4-20X1.3/4*	100	U55050.025.0175	3/8-16X3 Inch*	10	U55050.037.0300
NO.6-32X1.1/2*	100	U55050.013.0150	1/4-20X2 Inch*	50	U55050.025.0200	7/16-14X1.1/2*	25	U55050.043.0150

U55050 Hexagon socket head cap screw UNC 1936 series

d x L	☒	Art.number	d x L	☒	Art.number	d x L	☒	Art.number
7/16-14X2 Inch*	10	U55050.043.0200	1/2-13X3.1/2*	5	U55050.050.0350	5/8-11X3.1/2*	5	U55050.062.0350
1/2-13X3/4 ft*	10	U55050.050.0075	1/2-13X4 Inch*	5	U55050.050.0400	5/8-11X4 Inch*	5	U55050.062.0400
1/2-13X1 Inch ft*	10	U55050.050.0100	5/8-11X1 Inch ft*	10	U55050.062.0100	3/4-10X1.1/4 ft*	5	U55050.075.0125
1/2-13X1.1/4 ft*	10	U55050.050.0125	5/8-11X1.1/4 ft*	10	U55050.062.0125	3/4-10X1.1/2 ft*	5	U55050.075.0150
1/2-13X1.1/2 ft*	10	U55050.050.0150	5/8-11X1.1/2 ft*	10	U55050.062.0150	3/4-10X1.3/4 ft*	5	U55050.075.0175
1/2-13X1.3/4*	10	U55050.050.0175	5/8-11X1.3/4 ft*	10	U55050.062.0175	3/4-10X2 Inch ft*	5	U55050.075.0200
1/2-13X2 Inch*	10	U55050.050.0200	5/8-11X2 Inch*	5	U55050.062.0200	3/4-10X2.1/2*	5	U55050.075.0250
1/2-13X2.1/4*	10	U55050.050.0225	5/8-11X2.1/4*	5	U55050.062.0225	3/4-10X3 Inch*	5	U55050.075.0300
1/2-13X2.1/2*	10	U55050.050.0250	5/8-11X2.1/2*	5	U55050.062.0250	3/4-10X4 Inch*	5	U55050.075.0400
1/2-13X3 Inch*	5	U55050.050.0300	5/8-11X3 Inch*	5	U55050.062.0300			

* ft = fully threaded

Hexagon socket head cap screw UNF 1936 series

ASME ≈B18.3 (1936)

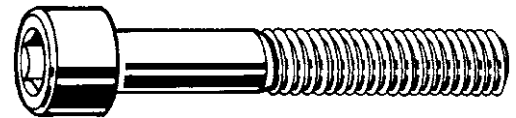
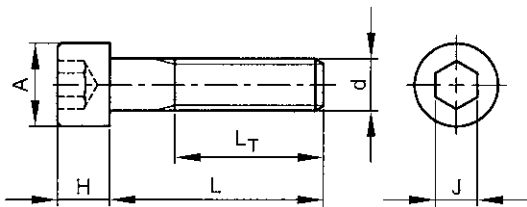

Technical Data

d	A	H	J	L _T (min.)	Threads per inch
No.0	0.096	0.06	0.05	0.5	80
No.1	0.118	0.073	1/16	0.62	72
No.2	0.140	0.086	5/64	0.62	64
No.3	0.161	0.099	5/64	0.62	56
No.4	0.183	0.112	3/32	0.75	48
No.5	0.205	0.125	3/32	0.75	44
No.6	0.026	0.138	7/64	0.75	40
No.8	0.270	0.164	9/64	0.88	36
No.10	0.312	0.19	5/32	0.88	32
1/4	0.375	0.25	3/16	1	28
5/16	0.469	0.312	1/4	1.12	24
3/8	0.562	0.375	5/16	1.25	24
7/16	0.656	0.438	3/8	1.38	20
1/2	0.750	0.5	3/8	1.5	20
9/16	0.844	0.562	3/8	1.5	18
5/8	0.938	0.625	1/2	1.75	18
3/4	1.125	0.75	5/8	2	16
7/8	1.312	0.875	3/4	2.25	14
1.1/8	1.688	1.125	7/8	2.81	12
1.1/4	1.875	1.25	7/8	3.12	12
1.3/8	2.062	1.375	1	3.44	12
1.1/2	2.25	1.5	1	3.75	12

- The mechanical properties corresponds much with the same property class 12.9 acc. to DIN ISO 898-1. Other properties acc. to ASTM A574. Marking of these screws is not mandatory.
- ATTENTION: as the product standard specifies thread tolerance 3A for thread sizes up to 1 inch, zinc plating can cause thread fit problems.

Article groups

Thread	Driving features	Material	Class	Surface treatment	Code	Page
UNF	Hexagon socket	St	Grade 8		U07040	2-29
UNF	Hexagon socket	St	12.9	Mech.zipl.	07250	2-30
UNF	Hexagon socket	St.St. A2 (AISI304/18-8)	F837B		U51041	2-30
UNF	Hexagon socket	St.St. A4 (AISI316/18-10)	F837E		U55041	2-31

U07040 Hexagon socket head cap screw UNF 1936 series
X05A
Thread Unified National Fine
Material Steel
Class Grade 8

2

d x L	☒	Art.number	d x L	☒	Art.number	d x L	☒	Art.number
NO.0-80X1/16 ft*	100	U07040.006.0006	NO.8-36X1.1/4*	100	U07040.016.0125	3/8-24X7/8 ft*	50	U07040.037.0087
NO.0-80X1/8 ft*	100	U07040.006.0012	NO.8-36X1.1/2*	100	U07040.016.0150	3/8-24X1 Inch ft*	50	U07040.037.0100
NO.0-80X3/16 ft*	100	U07040.006.0018				3/8-24X1.1/8 ft*	50	U07040.037.0112
NO.0-80X1/4 ft*	100	U07040.006.0025	NO.10-32X3/16 ft*	100	U07040.019.0018	3/8-24X1.1/4 ft*	50	U07040.037.0125
NO.0-80X5/16 ft*	100	U07040.006.0031	NO.10-32X1/4 ft*	100	U07040.019.0025	3/8-24X1.3/8*	50	U07040.037.0137
NO.0-80X3/8 ft*	100	U07040.006.0037	NO.10-32X5/16 ft*	100	U07040.019.0031	3/8-24X1.1/2*	25	U07040.037.0150
NO.0-80X1/2 ft*	100	U07040.006.0050	NO.10-32X3/8 ft*	100	U07040.019.0037	3/8-24X1.3/4*	25	U07040.037.0175
NO.0-80X5/8*	100	U07040.006.0062	NO.10-32X7/16 ft*	100	U07040.019.0043	3/8-24X2 Inch*	25	U07040.037.0200
NO.0-80X3/4*	100	U07040.006.0075	NO.10-32X1/2 ft*	100	U07040.019.0050	3/8-24X2.1/4*	25	U07040.037.0225
NO.0-80X1 Inch*	100	U07040.006.0100	NO.10-32X5/8 ft*	100	U07040.019.0062	3/8-24X2.1/2*	25	U07040.037.0250
			NO.10-32X3/4 ft*	100	U07040.019.0075	3/8-24X2.3/4*	25	U07040.037.0275
NO.1-72X1/8 ft*	100	U07040.007.0012	NO.10-32X7/8 ft*	100	U07040.019.0087	3/8-24X3 Inch*	10	U07040.037.0300
NO.1-72X3/16 ft*	100	U07040.007.0018	NO.10-32X1 Inch*	100	U07040.019.0100	3/8-24X3.1/4*	10	U07040.037.0325
NO.1-72X1/4 ft*	100	U07040.007.0025	NO.10-32X1.1/8*	100	U07040.019.0112	3/8-24X3.1/2*	10	U07040.037.0350
NO.1-72X3/8 ft*	100	U07040.007.0037	NO.10-32X1.1/4*	100	U07040.019.0125	3/8-24X3.3/4*	10	U07040.037.0375
NO.1-72X1/2 ft*	100	U07040.007.0050	NO.10-32X1.3/8*	100	U07040.019.0137	3/8-24X4 Inch*	10	U07040.037.0400
NO.1-72X5/8 ft*	100	U07040.007.0062	NO.10-32X1.1/2*	100	U07040.019.0150	3/8-24X4.1/2*	10	U07040.037.0450
NO.1-72X3/4*	100	U07040.007.0075	NO.10-32X1.3/4*	100	U07040.019.0175	3/8-24X5 Inch*	10	U07040.037.0500
NO.1-72X1 Inch*	100	U07040.007.0100	NO.10-32X2 Inch*	100	U07040.019.0200	3/8-24X5.1/2*	10	U07040.037.0550
			NO.10-32X2.1/4*	100	U07040.019.0225	3/8-24X6 Inch*	10	U07040.037.0600
NO.2-64X1/8 ft*	100	U07040.008.0012	NO.10-32X2.1/2*	100	U07040.019.0250			
NO.2-64X3/16 ft*	100	U07040.008.0018	NO.10-32X2.3/4*	100	U07040.019.0275	7/16-20X1/2 ft*	25	U07040.043.0050
NO.2-64X1/4 ft*	100	U07040.008.0025	NO.10-32X3 Inch*	100	U07040.019.0300	7/16-20X5/8 ft*	25	U07040.043.0062
NO.2-64X3/8 ft*	100	U07040.008.0037	NO.10-32X3.1/4*	100	U07040.019.0325	7/16-20X3/4 ft*	25	U07040.043.0075
NO.2-64X1/2 ft*	100	U07040.008.0050	NO.10-32X3.1/2*	100	U07040.019.0350	7/16-20X7/8 ft*	25	U07040.043.0087
NO.2-64X5/8 ft*	100	U07040.008.0062	NO.10-32X4 Inch*	100	U07040.019.0400	7/16-20X1 Inch ft*	25	U07040.043.0100
NO.2-64X3/4*	100	U07040.008.0075				7/16-20X1.1/4 ft*	25	U07040.043.0125
NO.2-64X1 Inch*	100	U07040.008.0100	1/4-28X3/8 ft*	100	U07040.025.0037	7/16-20X1.1/2 ft*	25	U07040.043.0150
			1/4-28X7/16 ft*	100	U07040.025.0043	7/16-20X1.3/4*	10	U07040.043.0175
NO.3-56X1/8 ft*	100	U07040.009.0012	1/4-28X1/2 ft*	100	U07040.025.0050	7/16-20X2 Inch*	10	U07040.043.0200
NO.3-56X3/16 ft*	100	U07040.009.0018	1/4-28X5/8 ft*	100	U07040.025.0062	7/16-20X2.1/4*	10	U07040.043.0225
NO.3-56X1/4 ft*	100	U07040.009.0025	1/4-28X3/4 ft*	100	U07040.025.0075	7/16-20X2.1/2*	10	U07040.043.0250
NO.3-56X5/16 ft*	100	U07040.009.0031	1/4-28X7/8 ft*	100	U07040.025.0087	7/16-20X3 Inch*	10	U07040.043.0300
NO.3-56X3/8 ft*	100	U07040.009.0037	1/4-28X1 Inch ft*	100	U07040.025.0100	7/16-20X3.1/2*	5	U07040.043.0350
NO.3-56X1/2 ft*	100	U07040.009.0050	1/4-28X1.1/8*	100	U07040.025.0112	7/16-20X4 Inch*	5	U07040.043.0400
NO.3-56X5/8 ft*	100	U07040.009.0062	1/4-28X1.1/4*	100	U07040.025.0125	7/16-20X5 Inch*	5	U07040.043.0500
NO.3-56X3/4*	100	U07040.009.0075	1/4-28X1.3/8*	100	U07040.025.0137	7/16-20X6 Inch*	5	U07040.043.0600
NO.3-56X1 Inch*	100	U07040.009.0100	1/4-28X1.1/2*	100	U07040.025.0150			
			1/4-28X1.3/4*	100	U07040.025.0175	1/2-20X1/2 ft*	10	U07040.050.0050
NO.4-48X1/8 ft*	100	U07040.011.0012	1/4-28X2 Inch*	50	U07040.025.0200	1/2-20X5/8 ft*	10	U07040.050.0062
NO.4-48X3/16 ft*	100	U07040.011.0018	1/4-28X2.1/4*	50	U07040.025.0225	1/2-20X3/4 ft*	10	U07040.050.0075
NO.4-48X1/4 ft*	100	U07040.011.0025	1/4-28X2.1/2*	50	U07040.025.0250	1/2-20X7/8 ft*	10	U07040.050.0087
NO.4-48X5/16 ft*	100	U07040.011.0031	1/4-28X2.3/4*	50	U07040.025.0275	1/2-20X1 Inch ft*	10	U07040.050.0100
NO.4-48X3/8 ft*	100	U07040.011.0037	1/4-28X3 Inch*	25	U07040.025.0300	1/2-20X1.1/8 ft*	10	U07040.050.0112
NO.4-48X7/16 ft*	100	U07040.011.0043	1/4-28X3.1/4*	25	U07040.025.0325	1/2-20X1.1/4 ft*	10	U07040.050.0125
NO.4-48X1/2 ft*	100	U07040.011.0050	1/4-28X3.1/2*	25	U07040.025.0350	1/2-20X1.3/8 ft*	10	U07040.050.0137
NO.4-48X5/8 ft*	100	U07040.011.0062	1/4-28X4 Inch*	25	U07040.025.0400	1/2-20X1.1/2 ft*	10	U07040.050.0150
NO.4-48X3/4 ft*	100	U07040.011.0075	1/4-28X4.1/2*	25	U07040.025.0450	1/2-20X1.3/4*	10	U07040.050.0175
NO.4-48X7/8*	100	U07040.011.0087	1/4-28X5 Inch*	25	U07040.025.0500	1/2-20X2 Inch*	10	U07040.050.0200
NO.4-48X1 Inch*	100	U07040.011.0100				1/2-20X2.1/4*	10	U07040.050.0225
			5/16-24X3/8 ft*	100	U07040.031.0037	1/2-20X2.1/2*	10	U07040.050.0250
NO.5-44X1/4 ft*	100	U07040.012.0025	5/16-24X1/2 ft*	100	U07040.031.0050	1/2-20X2.3/4*	10	U07040.050.0275
NO.5-44X3/8 ft*	100	U07040.012.0037	5/16-24X5/8 ft*	100	U07040.031.0062	1/2-20X3 Inch*	5	U07040.050.0300
NO.5-44X1/2 ft*	100	U07040.012.0050	5/16-24X3/4 ft*	100	U07040.031.0075	1/2-20X3.1/4*	5	U07040.050.0325
NO.5-44X5/8 ft*	100	U07040.012.0062	5/16-24X7/8 ft*	100	U07040.031.0087	1/2-20X3.1/2*	5	U07040.050.0350
NO.5-44X3/4 ft*	100	U07040.012.0075	5/16-24X1 Inch ft*	50	U07040.031.0100	1/2-20X3.3/4*	5	U07040.050.0375
			5/16-24X1.1/4*	50	U07040.031.0125	1/2-20X4 Inch*	5	U07040.050.0400
NO.6-40X3/16 ft*	100	U07040.013.0018	5/16-24X1.1/2*	50	U07040.031.0150	1/2-20X4.1/2*	5	U07040.050.0450
NO.6-40X1/4 ft*	100	U07040.013.0025	5/16-24X1.3/4*	50	U07040.031.0175	1/2-20X5 Inch*	5	U07040.050.0500
NO.6-40X5/16 ft*	100	U07040.013.0031	5/16-24X2 Inch*	50	U07040.031.0200	1/2-20X5.1/2*	5	U07040.050.0550
NO.6-40X3/8 ft*	100	U07040.013.0037	5/16-24X2.1/4*	25	U07040.031.0225	1/2-20X6 Inch*	5	U07040.050.0600
NO.6-40X7/16 ft*	100	U07040.013.0043	5/16-24X2.1/2*	25	U07040.031.0250	1/2-20X7 Inch*	5	U07040.050.0700
NO.6-40X1/2 ft*	100	U07040.013.0050	5/16-24X2.3/4*	25	U07040.031.0275	1/2-20X8 Inch*	5	U07040.050.0800
NO.6-40X5/8 ft*	100	U07040.013.0062	5/16-24X3 Inch*	25	U07040.031.0300			
NO.6-40X3/4 ft*	100	U07040.013.0075	5/16-24X3.1/4*	25	U07040.031.0325	9/16-18X1 Inch ft*	10	U07040.056.0100
NO.6-40X7/8*	100	U07040.013.0087	5/16-24X3.1/2*	25	U07040.031.0350	9/16-18X1.1/4 ft*	10	U07040.056.0125
NO.6-40X1 Inch*	100	U07040.013.0100	5/16-24X4 Inch*	10	U07040.031.0400	9/16-18X1.1/2 ft*	10	U07040.056.0150
			5/16-24X4.1/2*	10	U07040.031.0450	9/16-18X1.3/4*	10	U07040.056.0175
NO.8-36X1/4 ft*	100	U07040.016.0025	5/16-24X5 Inch*	10	U07040.031.0500	9/16-18X2 Inch*	5	U07040.056.0200
NO.8-36X3/8 ft*	100	U07040.016.0037	5/16-24X5.1/2*	10	U07040.031.0550	9/16-18X2.1/4*	5	U07040.056.0225
NO.8-36X1/2 ft*	100	U07040.016.0050	5/16-24X6 Inch*	10	U07040.031.0600	9/16-18X2.1/2*	5	U07040.056.0250
NO.8-36X5/8 ft*	100	U07040.016.0062				9/16-18X3 Inch*	5	U07040.056.0300
NO.8-36X3/4 ft*	100	U07040.016.0075	3/8-24X1/2 ft*	50	U07040.037.0050	9/16-18X4 Inch*	5	U07040.056.0400
NO.8-36X7/8 ft*	100	U07040.016.0087	3/8-24X5/8 ft*	50	U07040.037.0062	9/16-18X4.1/2*	5	U07040.056.0450
NO.8-36X1 Inch*	100	U07040.016.0100	3/8-24X3/4 ft*	50	U07040.037.0075	9/16-18X5 Inch*	5	U07040.056.0500

U07040 Hexagon socket head cap screw UNF 1936 series ←

d x L	Art.number	d x L	Art.number	d x L	Art.number
9/16-18X5.1/2*	5 U07040.056.0550	3/4-16X6.1/2*	1 U07040.075.0650	1.1/4-12X2 Inch ft*	1 U07040.125.0200
9/16-18X6 Inch*	5 U07040.056.0600	3/4-16X7 Inch*	1 U07040.075.0700	1.1/4-12X2.1/2 ft*	1 U07040.125.0250
5/8-18X1 Inch ft*	10 U07040.062.0100	3/4-16X8 Inch*	1 U07040.075.0800	1.1/4-12X3 Inch ft*	1 U07040.125.0300
5/8-18X1.1/4 ft*	10 U07040.062.0125	7/8-14X2 Inch ft*	5 U07040.087.0200	1.1/4-12X3.1/2*	1 U07040.125.0350
5/8-18X1.1/2 ft*	10 U07040.062.0150	7/8-14X2.1/4 ft*	5 U07040.087.0225	1.1/4-12X4 Inch*	1 U07040.125.0400
5/8-18X1.3/4 ft*	10 U07040.062.0175	7/8-14X2.1/2*	5 U07040.087.0250	1.1/4-12X4.1/2*	1 U07040.125.0450
5/8-18X2 Inch*	5 U07040.062.0200	7/8-14X3.1/4*	5 U07040.087.0275	1.1/4-12X5 Inch*	1 U07040.125.0500
5/8-18X2.1/4*	5 U07040.062.0225	7/8-14X3.1/2*	5 U07040.087.0300	1.1/4-12X5.1/2*	1 U07040.125.0550
5/8-18X2.1/2*	5 U07040.062.0250	7/8-14X3 Inch*	5 U07040.087.0325	1.1/4-12X6 Inch*	1 U07040.125.0600
5/8-18X2.3/4*	5 U07040.062.0275	7/8-14X3.1/4*	5 U07040.087.0350	1.1/4-12X7 Inch*	1 U07040.125.0700
5/8-18X3 Inch*	5 U07040.062.0300	7/8-14X3.1/2*	5 U07040.087.0375	1.1/4-12X8 Inch*	1 U07040.125.0800
5/8-18X3.1/4*	5 U07040.062.0325	7/8-14X4 Inch*	5 U07040.087.0400	1.1/4-12X9 Inch*	1 U07040.125.0900
5/8-18X3.1/2*	5 U07040.062.0350	7/8-14X4.1/2*	5 U07040.087.0425	1.1/4-12X10 Inch*	1 U07040.125.1000
5/8-18X4 Inch*	5 U07040.062.0400	7/8-14X5 Inch*	5 U07040.087.0450	1.1/4-12X12 Inch*	1 U07040.125.1200
5/8-18X4.1/2*	5 U07040.062.0425	7/8-14X6 Inch*	1 U07040.087.0600	1.3/8-12X3 Inch ft*	1 U07040.137.0300
5/8-18X5 Inch*	5 U07040.062.0500	7/8-14X7 Inch*	1 U07040.087.0700	1.3/8-12X3.1/2*	1 U07040.137.0350
5/8-18X5.1/2*	5 U07040.062.0550	7/8-14X8 Inch*	1 U07040.087.0800	1.3/8-12X4 Inch*	1 U07040.137.0400
5/8-18X6 Inch*	5 U07040.062.0600	1.-14X2 Inch*	5 U07040.101.0200	1.3/8-12X4.1/2*	1 U07040.137.0450
5/8-18X6.1/2*	5 U07040.062.0650	1.-14X2.1/4*	5 U07040.101.0225	1.3/8-12X5 Inch*	1 U07040.137.0500
5/8-18X7 Inch*	5 U07040.062.0700	1.-14X2.1/2*	5 U07040.101.0250	1.3/8-12X5.1/2*	1 U07040.137.0550
5/8-18X8 Inch*	5 U07040.062.0800	1.-14X3 Inch*	5 U07040.101.0300	1.3/8-12X6 Inch*	1 U07040.137.0600
3/4-16X1.1/4 ft*	5 U07040.075.0125	1.-14X3.1/2*	5 U07040.101.0350	1.3/8-12X7 Inch*	1 U07040.137.0700
3/4-16X1.1/2 ft*	5 U07040.075.0150	1.-14X3.1/2*	5 U07040.101.0350	1.3/8-12X8 Inch*	1 U07040.137.0800
3/4-16X1.3/4 ft*	5 U07040.075.0175	1.-14X4 Inch*	5 U07040.101.0400	1.3/8-12X10 Inch*	1 U07040.137.1000
3/4-16X2 Inch ft*	5 U07040.075.0200	1.-14X4.1/2*	5 U07040.101.0450	1.1/2-12X3 Inch ft*	1 U07040.150.0300
3/4-16X2.1/4*	5 U07040.075.0225	1.-14X5 Inch*	5 U07040.101.0500	1.1/2-12X3.1/2 ft*	1 U07040.150.0350
3/4-16X2.1/2*	5 U07040.075.0250	1.-14X6 Inch*	1 U07040.101.0600	1.1/2-12X4 Inch*	1 U07040.150.0400
3/4-16X2.3/4*	5 U07040.075.0275	1.-14X7 Inch*	1 U07040.101.0700	1.1/2-12X4.1/2*	1 U07040.150.0450
3/4-16X3 Inch*	5 U07040.075.0300	1.1/8-12X3 Inch*	1 U07040.112.0300	1.1/2-12X5 Inch*	1 U07040.150.0500
3/4-16X3.1/4*	5 U07040.075.0325	1.1/8-12X3.1/2*	1 U07040.112.0350	1.1/2-12X5.1/2*	1 U07040.150.0550
3/4-16X3.1/2*	5 U07040.075.0350	1.1/8-12X4 Inch*	1 U07040.112.0400	1.1/2-12X6 Inch*	1 U07040.150.0600
3/4-16X4 Inch*	5 U07040.075.0400	1.1/8-12X4.1/2*	1 U07040.112.0450	1.1/2-12X7 Inch*	1 U07040.150.0700
3/4-16X4.1/2*	5 U07040.075.0450	1.1/8-12X5 Inch*	1 U07040.112.0500	1.1/2-12X7 Inch*	1 U07040.150.0700
3/4-16X5 Inch*	5 U07040.075.0500	1.1/8-12X6 Inch*	1 U07040.112.0600	1.1/2-12X8 Inch*	1 U07040.150.0800
3/4-16X5.1/2*	5 U07040.075.0550	1.1/8-12X7 Inch*	1 U07040.112.0700	1.1/2-12X10 Inch*	1 U07040.150.1000
3/4-16X6 Inch*	5 U07040.075.0600	1.1/8-12X8 Inch*	1 U07040.112.0800	1.1/2-12X12 Inch*	1 U07040.150.1200

* ft = fully threaded

07250 Hexagon socket head cap screw UNF 1936 series X05A

Thread Unified National Fine
Material Steel
Class 12.9
Surface treatment Mechanical zinc plated



d x L	Art.number	d x L	Art.number	d x L	Art.number
5/16-24X7/8 ft	100 07250.079.022	3/8-24X1.1/2	100 07250.096.038	1/2-20X1.3/4	50 07250.127.044
5/16-24X1 Inch ft	100 07250.079.025	1/2-20X5/8 ft	50 07250.127.015	5/8-18X1.1/2 ft	25 07250.158.038
3/8-24X1 Inch ft	100 07250.096.025	1/2-20X1.1/2 ft	50 07250.127.038		

* ft = fully threaded

U51041 Hexagon socket head cap screw UNF 1936 series X15A

Thread Unified National Fine
Material Stainless steel A2 (AISI 304/18-8)
Class F837B

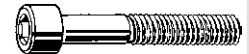

d x L	Art.number	d x L	Art.number	d x L	Art.number
NO.0-80X1/8 ft*	100 U51041.006.0012	NO.1-72X5/16 ft*	100 U51041.007.0031	NO.2-64X3/4*	100 U51041.008.0075
NO.0-80X3/16 ft*	100 U51041.006.0018	NO.1-72X3/8 ft*	100 U51041.007.0037	NO.2-64X1 Inch*	100 U51041.008.0100
NO.0-80X1/4 ft*	100 U51041.006.0025	NO.1-72X1/2 ft*	100 U51041.007.0050		
NO.0-80X5/16 ft*	100 U51041.006.0031	NO.1-72X5/8 ft*	100 U51041.007.0062	NO.3-56X3/16 ft*	100 U51041.009.0018
NO.0-80X3/8 ft*	100 U51041.006.0037	NO.1-72X3/4 ft*	100 U51041.007.0075	NO.3-56X1/4 ft*	100 U51041.009.0025
NO.0-80X1/2 ft*	100 U51041.006.0050	NO.1-72X1 Inch*	100 U51041.007.0100	NO.3-56X5/16 ft*	100 U51041.009.0031
NO.0-80X5/8*	100 U51041.006.0062			NO.3-56X3/8 ft*	100 U51041.009.0037
NO.0-80X3/4*	100 U51041.006.0075	NO.2-64X3/16 ft*	100 U51041.008.0018	NO.3-56X1/2 ft*	100 U51041.009.0050
NO.0-80X1 Inch*	100 U51041.006.0100	NO.2-64X1/4 ft*	100 U51041.008.0025	NO.3-56X5/8 ft*	100 U51041.009.0062
		NO.2-64X5/16 ft*	100 U51041.008.0031	NO.3-56X3/4*	100 U51041.009.0075
NO.1-72X1/8 ft*	100 U51041.007.0012	NO.2-64X3/8 ft*	100 U51041.008.0037	NO.3-56X1 Inch*	100 U51041.009.0100
NO.1-72X3/16 ft*	100 U51041.007.0018	NO.2-64X1/2 ft*	100 U51041.008.0050		
NO.1-72X1/4 ft*	100 U51041.007.0025	NO.2-64X5/8 ft*	100 U51041.008.0062	NO.4-48X3/16 ft*	100 U51041.011.0018

U51041 Hexagon socket head cap screw UNF 1936 series ←

d x L	☒	Art.number	d x L	☒	Art.number	d x L	☒	Art.number
NO.4-48X1/4 ft*	100	U51041.011.0025	NO.10-32X1.1/8*	100	U51041.019.0112	5/16-24X3.1/2*	25	U51041.031.0350
NO.4-48X5/16 ft*	100	U51041.011.0031	NO.10-32X1.1/4*	100	U51041.019.0125	5/16-24X4 Inch*	10	U51041.031.0400
NO.4-48X3/8 ft*	100	U51041.011.0037	NO.10-32X1.3/8*	100	U51041.019.0137			
NO.4-48X1/2 ft*	100	U51041.011.0050	NO.10-32X1.1/2*	100	U51041.019.0150	3/8-24X1/2 ft*	50	U51041.037.0050
NO.4-48X5/8 ft*	100	U51041.011.0062	NO.10-32X1.3/4*	100	U51041.019.0175	3/8-24X5/8 ft*	50	U51041.037.0062
NO.4-48X3/4 ft*	100	U51041.011.0075	NO.10-32X2 Inch*	100	U51041.019.0200	3/8-24X3/4 ft*	50	U51041.037.0075
NO.4-48X1 Inch*	100	U51041.011.0100	NO.10-32X2.1/4*	100	U51041.019.0225	3/8-24X7/8 ft*	50	U51041.037.0087
			NO.10-32X2.1/2*	100	U51041.019.0250	3/8-24X1 Inch ft*	50	U51041.037.0100
NO.5-44X3/16 ft*	100	U51041.012.0018	NO.10-32X2.3/4*	100	U51041.019.0275	3/8-24X1.1/4 ft*	50	U51041.037.0125
NO.5-44X1/4 ft*	100	U51041.012.0025	NO.10-32X3 Inch*	100	U51041.019.0300	3/8-24X1.1/2*	25	U51041.037.0150
NO.5-44X5/16 ft*	100	U51041.012.0031	NO.10-32X3.1/4*	100	U51041.019.0325	3/8-24X1.3/4*	25	U51041.037.0175
NO.5-44X3/8 ft*	100	U51041.012.0037	NO.10-32X3.1/2*	100	U51041.019.0350	3/8-24X2 Inch*	25	U51041.037.0200
NO.5-44X1/2 ft*	100	U51041.012.0050	NO.10-32X4 Inch*	100	U51041.019.0400	3/8-24X2.1/4*	25	U51041.037.0225
NO.5-44X5/8 ft*	100	U51041.012.0062				3/8-24X2.1/2*	25	U51041.037.0250
NO.5-44X3/4 ft*	100	U51041.012.0075	1/4-28X3/8 ft*	100	U51041.025.0037	3/8-24X2.3/4*	25	U51041.037.0275
NO.5-44X1 Inch*	100	U51041.012.0100	1/4-28X7/16 ft*	100	U51041.025.0043	3/8-24X3 Inch*	10	U51041.037.0300
			1/4-28X1/2 ft*	100	U51041.025.0050	3/8-24X3.1/2*	10	U51041.037.0350
NO.6-40X3/16 ft*	100	U51041.013.0018	1/4-28X5/8 ft*	100	U51041.025.0062	3/8-24X4 Inch*	10	U51041.037.0400
NO.6-40X1/4 ft*	100	U51041.013.0025	1/4-28X3/4 ft*	100	U51041.025.0075	3/8-24X4.1/2*	10	U51041.037.0450
NO.6-40X5/16 ft*	100	U51041.013.0031	1/4-28X7/8 ft*	100	U51041.025.0087	3/8-24X5 Inch*	10	U51041.037.0500
NO.6-40X3/8 ft*	100	U51041.013.0037	1/4-28X1 Inch ft*	100	U51041.025.0100	3/8-24X6 Inch*	10	U51041.037.0600
NO.6-40X1/2 ft*	100	U51041.013.0050	1/4-28X1.1/8*	100	U51041.025.0112			
NO.6-40X5/8 ft*	100	U51041.013.0062	1/4-28X1.1/4*	100	U51041.025.0125	7/16-20X1 Inch ft*	25	U51041.043.0100
NO.6-40X3/4 ft*	100	U51041.013.0075	1/4-28X1.1/2*	100	U51041.025.0150	7/16-20X1.1/4 ft*	25	U51041.043.0125
NO.6-40X1 Inch*	100	U51041.013.0100	1/4-28X1.3/4*	100	U51041.025.0175	7/16-20X1.1/2*	25	U51041.043.0150
NO.6-40X1.1/4*	100	U51041.013.0125	1/4-28X2 Inch*	50	U51041.025.0200	7/16-20X2 Inch*	10	U51041.043.0200
			1/4-28X2.1/4*	50	U51041.025.0225			
NO.8-36X1/4 ft*	100	U51041.016.0025	1/4-28X2.1/2*	50	U51041.025.0250	1/2-20X3/4 ft*	10	U51041.050.0075
NO.8-36X3/8 ft*	100	U51041.016.0037	1/4-28X3 Inch*	25	U51041.025.0300	1/2-20X1 Inch ft*	10	U51041.050.0100
NO.8-36X1/2 ft*	100	U51041.016.0050	1/4-28X3.1/2*	25	U51041.025.0350	1/2-20X1.1/4 ft*	10	U51041.050.0125
NO.8-36X5/8 ft*	100	U51041.016.0062	1/4-28X4 Inch*	25	U51041.025.0400	1/2-20X1.1/2 ft*	10	U51041.050.0150
NO.8-36X3/4 ft*	100	U51041.016.0075				1/2-20X1.3/4*	10	U51041.050.0175
NO.8-36X7/8 ft*	100	U51041.016.0087	5/16-24X3/8 ft*	100	U51041.031.0037	1/2-20X2 Inch*	10	U51041.050.0200
NO.8-36X1 Inch*	100	U51041.016.0100	5/16-24X1/2 ft*	100	U51041.031.0050	1/2-20X2.1/4*	10	U51041.050.0225
NO.8-36X1.1/4*	100	U51041.016.0125	5/16-24X5/8 ft*	100	U51041.031.0062	1/2-20X2.1/2*	10	U51041.050.0250
			5/16-24X3/4 ft*	100	U51041.031.0075	1/2-20X3 Inch*	5	U51041.050.0300
NO.10-32X3/16 ft*	100	U51041.019.0018	5/16-24X7/8 ft*	100	U51041.031.0087	1/2-20X3.1/2*	5	U51041.050.0350
NO.10-32X1/4 ft*	100	U51041.019.0025	5/16-24X1 Inch ft*	50	U51041.031.0100	1/2-20X4 Inch*	5	U51041.050.0400
NO.10-32X5/16 ft*	100	U51041.019.0031	5/16-24X1.1/4*	50	U51041.031.0125	1/2-20X4.1/2*	5	U51041.050.0450
NO.10-32X3/8 ft*	100	U51041.019.0037	5/16-24X1.1/2*	50	U51041.031.0150	1/2-20X5 Inch*	5	U51041.050.0500
NO.10-32X7/16 ft*	100	U51041.019.0043	5/16-24X1.3/4*	50	U51041.031.0175	1/2-20X6 Inch*	5	U51041.050.0600
NO.10-32X1/2 ft*	100	U51041.019.0050	5/16-24X2 Inch*	50	U51041.031.0200			
NO.10-32X5/8 ft*	100	U51041.019.0062	5/16-24X2.1/4*	25	U51041.031.0225	5/8-18X1.1/2 ft*	10	U51041.062.0150
NO.10-32X3/4 ft*	100	U51041.019.0075	5/16-24X2.1/2*	25	U51041.031.0250	5/8-18X1.3/4 ft*	10	U51041.062.0175
NO.10-32X7/8 ft*	100	U51041.019.0087	5/16-24X2.3/4*	25	U51041.031.0275	5/8-18X2 Inch*	5	U51041.062.0200
NO.10-32X1 Inch*	100	U51041.019.0100	5/16-24X3 Inch*	25	U51041.031.0300			

* ft = fully threaded

U55041 Hexagon socket head cap screw UNF 1936 series X15A

Thread	Unified National Fine
Material	Stainless steel A4 (AISI 316/18-10)
Class	F837E





d x L	☒	Art.number	d x L	☒	Art.number	d x L	☒	Art.number
NO.10-32X1/4 ft*	100	U55041.019.0025	NO.10-32X1.1/4*	100	U55041.019.0125	5/16-24X3/4 ft*	100	U55041.031.0075
NO.10-32X3/8 ft*	100	U55041.019.0037	NO.10-32X1.1/2*	100	U55041.019.0150	5/16-24X1 Inch ft*	50	U55041.031.0100
NO.10-32X1/2 ft*	100	U55041.019.0050	NO.10-32X2 Inch*	100	U55041.019.0200			
NO.10-32X5/8 ft*	100	U55041.019.0062				3/8-24X3/4 ft*	50	U55041.037.0075
NO.10-32X3/4 ft*	100	U55041.019.0075	1/4-28X1/2 ft*	100	U55041.025.0050	3/8-24X1 Inch ft*	50	U55041.037.0100
NO.10-32X7/8 ft*	100	U55041.019.0087	1/4-28X3/4 ft*	100	U55041.025.0075			
NO.10-32X1 Inch*	100	U55041.019.0100	1/4-28X1 Inch ft*	100	U55041.025.0100			

* ft = fully threaded

Hexagon socket head cap screw BSW

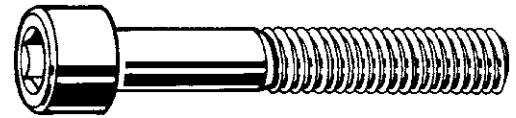
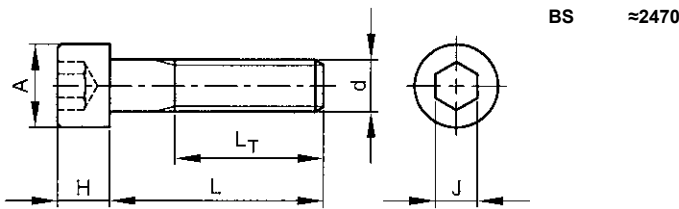
2



Technical Data

d	A	H	J	L _T (min.)	Threads per inch
1/2	19	12.7	3/8	38	12

- Whitworth thread (BSW/BSF) is not internationally recommended. It is advised to use metric (M/MF) or unified threads (UNC/UNF).
- Depending on availability also class 10.9 can be supplied.
- Marking of these screws is not mandatory.
- Depending on availability the dimensions may deviate.

07200 Hexagon socket head cap screw BSW

X08A

Thread British Standard Whitworth
Material Steel
Class 12.9



d x L	☒	Art.number	d x L	☒	Art.number	d x L	☒	Art.number
1/2X3/4	50	07200.127.020	1/2X2 Inch	50	07200.127.050	1/2X3.1/4	25	07200.127.080
1/2X1 Inch	50	07200.127.025	1/2X2.1/4	25	07200.127.060	1/2X3.1/2	25	07200.127.090
1/2X1.1/4	50	07200.127.030	1/2X2.1/2	25	07200.127.065	1/2X4 Inch	25	07200.127.100
1/2X1.1/2	50	07200.127.040	1/2X2.3/4	25	07200.127.070	1/2X4.1/2	25	07200.127.110
1/2X1.3/4	50	07200.127.045	1/2X3 Inch	25	07200.127.075			

- Warning: electro-galvanizing of these products may cause hydrogen embrittlement.

Hexagon socket low head cap screw

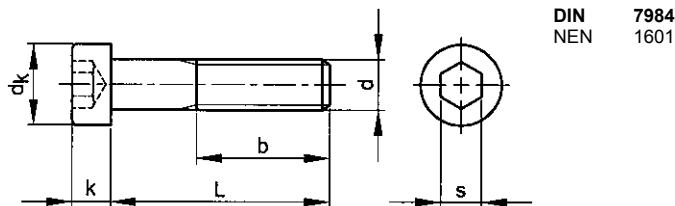

Technical Data

d	b (min.)	d _k	Full thread L ≤	k	P	s
M3	12	5.5	18	2	0.5	2
M4	14	7	20	2.8	0.7	2.5
M5	16	8.5	25	3.5	0.8	3
M6	18	10	25	4	1	4
M8	22	13	30	5	1.25	5
M10	26	16	35	6	1.5	7
M12	30	18	45	7	1.75	8
M16	38	24	55	9	2	12
M20	46	30	60	11	2.5	14
M24	54	36	80	13	3	17

- Due to the unfavourable geometry of the head, these fasteners do have reduced loadability.
- When steel fasteners (e.g. 8.8 / 10.9 / 12.9) with reduced loadability needs to be marked, the marking symbol for the property class is preceded by the digit '0'. So 8.8 → 08.8 and 10.9 → 010.9 and 12.9 → 012.9.
- For the stainless steel fasteners it is indicated by only marking the steel grade and by leaving out the property class 70 (e.g. A2-70 → A2).
- The former and the new indications can occur side by side for some time.

Article groups

Thread	Driving features	Material	Class	Surface treatment	Code	Page
M	Hexagon socket	St	08.8		07080	2-33
M	Hexagon socket	St	08.8	Zipl	07090	2-33
M	Hexagon socket	St	010.9		07105	2-34

Article groups						
Thread	Driving features	Material	Class	Surface treatment	Code	Page
M	Hexagon socket	St.St. A2			51040	2-34
M	Hexagon socket	St.St. A4			55040	2-35

07080 Hexagon socket low head cap screw D03A

Thread	Metric thread
Material	Steel
Class	08.8





d x L	☒	Art.number	d x L	☒	Art.number	d x L	☒	Art.number
M4X6	200	07080.040.006				M12X60	100	07080.120.060
M4X8	200	07080.040.008	M8X12	200	07080.080.012	M12X70	50	07080.120.070
M4X10	200	07080.040.010	M8X16	200	07080.080.016	M12X80	50	07080.120.080
M4X12	200	07080.040.012	M8X18	200	07080.080.018	M12X100	50	07080.120.100
M4X16	200	07080.040.016	M8X20	200	07080.080.020			
M4X20	200	07080.040.020	M8X22	200	07080.080.022	M16X25	50	07080.160.025
M4X25	200	07080.040.025	M8X25	200	07080.080.025	M16X30	50	07080.160.030
M4X30	200	07080.040.030	M8X30	200	07080.080.030	M16X35	50	07080.160.035
			M8X35	200	07080.080.035	M16X40	50	07080.160.040
M5X8	200	07080.050.008	M8X40	200	07080.080.040	M16X45	50	07080.160.045
M5X10	200	07080.050.010	M8X45	200	07080.080.045	M16X50	50	07080.160.050
M5X12	200	07080.050.012	M8X50	200	07080.080.050	M16X55	50	07080.160.055
M5X16	200	07080.050.016	M8X60	200	07080.080.060	M16X60	50	07080.160.060
M5X18	200	07080.050.018	M8X70	200	07080.080.070	M16X70	25	07080.160.070
M5X20	200	07080.050.020				M16X80	25	07080.160.080
M5X22	200	07080.050.022	M10X16	200	07080.100.016	M16X90	25	07080.160.090
M5X25	200	07080.050.025	M10X20	200	07080.100.020	M16X100	25	07080.160.100
M5X30	200	07080.050.030	M10X22	200	07080.100.022	M16X120	50	07080.160.120
M5X35	200	07080.050.035	M10X25	200	07080.100.025			
M5X40	200	07080.050.040	M10X30	200	07080.100.030	M20X30	25	07080.200.030
M5X50	200	07080.050.050	M10X35	100	07080.100.035	M20X35	25	07080.200.035
			M10X40	100	07080.100.040	M20X40	25	07080.200.040
M6X8	200	07080.060.008	M10X45	100	07080.100.045	M20X50	25	07080.200.050
M6X10	200	07080.060.010	M10X50	100	07080.100.050	M20X60	25	07080.200.060
M6X12	200	07080.060.012	M10X60	100	07080.100.060	M20X70	25	07080.200.070
M6X16	200	07080.060.016	M10X70	100	07080.100.070	M20X80	25	07080.200.080
M6X18	200	07080.060.018	M10X80	100	07080.100.080	M20X90	25	07080.200.090
M6X20	200	07080.060.020						
M6X22	200	07080.060.022	M12X20	100	07080.120.020	M24X40	25	07080.240.040
M6X25	200	07080.060.025	M12X25	100	07080.120.025	M24X45	25	07080.240.045
M6X30	200	07080.060.030	M12X30	100	07080.120.030	M24X50	25	07080.240.050
M6X35	200	07080.060.035	M12X35	100	07080.120.035	M24X60	25	07080.240.060
M6X40	200	07080.060.040	M12X40	100	07080.120.040	M24X80	25	07080.240.080
M6X45	200	07080.060.045	M12X45	100	07080.120.045	M24X90	25	07080.240.090
M6X50	200	07080.060.050	M12X50	100	07080.120.050	M24X100	25	07080.240.100
M6X60	200	07080.060.060						

07090 Hexagon socket low head cap screw D03A

Thread	Metric thread
Material	Steel
Class	08.8
Surface treatment	Zinc plated







d x L	☒	Art.number	d x L	☒	Art.number	d x L	☒	Art.number
M4X6	200	07090.040.006	M6X30	200	07090.060.030	M10X25	200	07090.100.025
M4X8	200	07090.040.008	M6X35	200	07090.060.035	M10X30	200	07090.100.030
M4X10	200	07090.040.010	M6X40	200	07090.060.040	M10X35	100	07090.100.035
M4X12	200	07090.040.012	M6X45	200	07090.060.045	M10X40	100	07090.100.040
M4X16	200	07090.040.016	M6X50	200	07090.060.050	M10X50	100	07090.100.050
M4X20	200	07090.040.020				M10X60	100	07090.100.060
			M8X10	200	07090.080.010			
M5X8	200	07090.050.008	M8X12	200	07090.080.012	M12X20	100	07090.120.020
M5X10	200	07090.050.010	M8X16	200	07090.080.016	M12X25	100	07090.120.025
M5X12	200	07090.050.012	M8X20	200	07090.080.020	M12X30	100	07090.120.030
M5X16	200	07090.050.016	M8X25	200	07090.080.025	M12X35	100	07090.120.035
M5X20	200	07090.050.020	M8X30	200	07090.080.030	M12X40	100	07090.120.040
M5X25	200	07090.050.025	M8X35	200	07090.080.035	M12X45	100	07090.120.045
M5X30	200	07090.050.030	M8X40	200	07090.080.040	M12X50	100	07090.120.050
			M8X45	200	07090.080.045	M12X60	100	07090.120.060
M6X10	200	07090.060.010	M8X50	200	07090.080.050	M12X80	50	07090.120.080
M6X12	200	07090.060.012	M8X60	200	07090.080.060			
M6X16	200	07090.060.016				M16X25	50	07090.160.025
M6X20	200	07090.060.020	M10X16	200	07090.100.016	M16X30	50	07090.160.030
M6X25	200	07090.060.025	M10X20	200	07090.100.020	M16X35	50	07090.160.035

07090 Hexagon socket low head cap screw								
d x L	☒	Art.number	d x L	☒	Art.number	d x L	☒	Art.number
M16X40	50	07090.160.040	M16X80	25	07090.160.080	M20X60	25	07090.200.060
M16X50	50	07090.160.050				M20X70	25	07090.200.070
M16X60	50	07090.160.060	M20X40	25	07090.200.040	M20X80	25	07090.200.080
M16X70	25	07090.160.070	M20X50	25	07090.200.050			

07105 Hexagon socket low head cap screw		D03A
Thread	Metric thread	
Material	Steel	
Class	010.9	
		

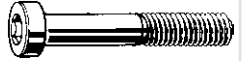

d x L	☒	Art.number	d x L	☒	Art.number	d x L	☒	Art.number
M4X8	200	07105.040.008	M8X12	200	07105.080.012	M12X45	100	07105.120.045
M4X10	200	07105.040.010	M8X16	200	07105.080.016	M12X50	50	07105.120.050
M4X12	200	07105.040.012	M8X20	200	07105.080.020	M12X60	50	07105.120.060
M4X16	200	07105.040.016	M8X25	200	07105.080.025			
M4X20	200	07105.040.020	M8X30	200	07105.080.030	M16X30	25	07105.160.030
			M8X35	200	07105.080.035	M16X40	25	07105.160.040
M5X10	200	07105.050.010	M8X40	200	07105.080.040	M16X45	25	07105.160.045
M5X12	200	07105.050.012	M8X50	200	07105.080.050	M16X50	25	07105.160.050
M5X16	200	07105.050.016				M16X60	25	07105.160.060
M5X20	200	07105.050.020	M10X16	200	07105.100.016	M16X70	25	07105.160.070
M5X25	200	07105.050.025	M10X20	200	07105.100.020	M16X80	25	07105.160.080
			M10X25	200	07105.100.025			
M6X10	200	07105.060.010	M10X30	200	07105.100.030	M20X30	25	07105.200.030
M6X12	200	07105.060.012	M10X35	100	07105.100.035	M20X40	25	07105.200.040
M6X16	200	07105.060.016	M10X40	100	07105.100.040	M20X50	25	07105.200.050
M6X20	200	07105.060.020	M10X50	100	07105.100.050	M20X60	25	07105.200.060
M6X25	200	07105.060.025				M20X70	25	07105.200.070
M6X30	200	07105.060.030	M12X20	100	07105.120.020	M20X80	25	07105.200.080
M6X35	200	07105.060.035	M12X25	100	07105.120.025	M20X90	25	07105.200.090
M6X40	200	07105.060.040	M12X30	100	07105.120.030	M20X100	25	07105.200.100
			M12X35	100	07105.120.035	M20X110	25	07105.200.110
M8X10	200	07105.080.010	M12X40	100	07105.120.040			

• Warning: electro-galvanizing of these products may cause hydrogen embrittlement.

51040 Hexagon socket low head cap screw		Q05A
Thread	Metric thread	
Material	Stainless steel A2	
		

d x L	☒	Art.number	d x L	☒	Art.number	d x L	☒	Art.number
M3X3*	1000	51040.030.003	M4X25*	500	51040.040.025	M6X6*	500	51040.060.006
M3X4*	1000	51040.030.004	M4X30	200	51040.040.030	M6X8	500	51040.060.008
M3X5*	1000	51040.030.005	M4X35*	200	51040.040.035	M6X10	200	51040.060.010
M3X6*	1000	51040.030.006	M4X40*	200	51040.040.040	M6X12	200	51040.060.012
M3X8	1000	51040.030.008	M4X45*	200	51040.040.045	M6X14*	200	51040.060.014
M3X10	1000	51040.030.010	M4X50*	200	51040.040.050	M6X16	200	51040.060.016
M3X12	1000	51040.030.012	M4X55*	200	51040.040.055	M6X18*	200	51040.060.018
M3X14*	1000	51040.030.014	M4X60*	100	51040.040.060	M6X20	200	51040.060.020
M3X16*	1000	51040.030.016				M6X22*	200	51040.060.022
M3X18*	1000	51040.030.018	M5X5*	500	51040.050.005	M6X25	100	51040.060.025
M3X20*	1000	51040.030.020	M5X6*	500	51040.050.006	M6X30	100	51040.060.030
M3X22*	1000	51040.030.022	M5X8	200	51040.050.008	M6X35	100	51040.060.035
M3X25*	1000	51040.030.025	M5X10	200	51040.050.010	M6X40	100	51040.060.040
M3X30*	1000	51040.030.030	M5X12	200	51040.050.012	M6X45	100	51040.060.045
M3X35*	500	51040.030.035	M5X14	500	51040.050.014	M6X50	100	51040.060.050
M3X40*	500	51040.030.040	M5X16	200	51040.050.016	M6X55*	100	51040.060.055
M3X45*	500	51040.030.045	M5X18*	500	51040.050.018	M6X60*	100	51040.060.060
M3X50*	200	51040.030.050	M5X20	200	51040.050.020	M6X65*	100	51040.060.065
			M5X22*	500	51040.050.022	M6X70*	100	51040.060.070
M4X4*	1000	51040.040.004	M5X25	200	51040.050.025	M6X75*	100	51040.060.075
M4X5*	1000	51040.040.005	M5X30	200	51040.050.030	M6X80*	100	51040.060.080
M4X6	200	51040.040.006	M5X35*	200	51040.050.035	M6X90*	100	51040.060.090
M4X8	200	51040.040.008	M5X40*	200	51040.050.040	M6X100*	100	51040.060.100
M4X10	200	51040.040.010	M5X45	200	51040.050.045	M6X120*	100	51040.060.120
M4X12	200	51040.040.012	M5X50	100	51040.050.050			
M4X14*	1000	51040.040.014	M5X60*	100	51040.050.060	M8X8*	500	51040.080.008
M4X16	200	51040.040.016	M5X65*	100	51040.050.065	M8X10*	500	51040.080.010
M4X18*	1000	51040.040.018	M5X70*	100	51040.050.070	M8X12	100	51040.080.012
M4X20	200	51040.040.020	M5X75*	100	51040.050.075	M8X14*	200	51040.080.014
M4X22*	500	51040.040.022	M5X80*	100	51040.050.080			

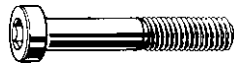
51040 Hexagon socket low head cap screw								
d x L	☒	Art.number	d x L	☒	Art.number	d x L	☒	Art.number
M8X16	100	51040.080.016	M10X40	50	51040.100.040	M12X120*	25	51040.120.120
M8X18*	200	51040.080.018	M10X45	50	51040.100.045	M16X25*	25	51040.160.025
M8X20	100	51040.080.020	M10X50	50	51040.100.050	M16X30	10	51040.160.030
M8X22*	200	51040.080.022	M10X55*	50	51040.100.055	M16X35	10	51040.160.035
M8X25	100	51040.080.025	M10X60	25	51040.100.060	M16X40*	25	51040.160.040
M8X30	100	51040.080.030	M10X65*	50	51040.100.065	M16X45	10	51040.160.045
M8X35	100	51040.080.035	M10X70	25	51040.100.070	M16X50	10	51040.160.050
M8X40	100	51040.080.040	M10X80*	50	51040.100.080	M16X55*	25	51040.160.055
M8X45	50	51040.080.045	M10X90*	50	51040.100.090	M16X60	10	51040.160.060
M8X50	50	51040.080.050	M10X100*	50	51040.100.100	M16X65*	25	51040.160.065
M8X55*	100	51040.080.055	M12X16*	50	51040.120.016	M16X70*	25	51040.160.070
M8X60	50	51040.080.060	M12X20	50	51040.120.020	M16X80	5	51040.160.080
M8X65*	100	51040.080.065	M12X22*	50	51040.120.022	M16X90*	25	51040.160.090
M8X70*	100	51040.080.070	M12X25	50	51040.120.025	M16X100	5	51040.160.100
M8X75*	100	51040.080.075	M12X25	50	51040.120.025	M16X150*	25	51040.160.150
M8X80*	100	51040.080.080	M12X30	50	51040.120.030	M20X30*	25	51040.200.030
M8X90*	100	51040.080.090	M12X35	50	51040.120.035	M20X35*	25	51040.200.035
M8X100*	50	51040.080.100	M12X40	25	51040.120.040	M20X40*	25	51040.200.040
M8X110*	50	51040.080.110	M12X45	25	51040.120.045	M20X45*	25	51040.200.045
M8X120*	50	51040.080.120	M12X50	25	51040.120.050	M20X50*	25	51040.200.050
M10X16	100	51040.100.016	M12X55*	50	51040.120.055	M20X60	5	51040.200.060
M10X18*	100	51040.100.018	M12X60	25	51040.120.060	M20X70*	25	51040.200.070
M10X20	100	51040.100.020	M12X65*	50	51040.120.065	M20X80*	25	51040.200.080
M10X22*	100	51040.100.022	M12X70	25	51040.120.070	M20X90*	25	51040.200.090
M10X25	50	51040.100.025	M12X75*	25	51040.120.075	M20X100*	25	51040.200.100
M10X30	50	51040.100.030	M12X80	25	51040.120.080	M20X110*	25	51040.200.110
M10X35	50	51040.100.035	M12X90*	25	51040.120.090			
			M12X100	25	51040.120.100			

55040 Hexagon socket low head cap screw		Q45A
Thread	Metric thread	
Material	Stainless steel A4	
		

d x L	☒	Art.number	d x L	☒	Art.number	d x L	☒	Art.number
M3X4*	1000	55040.030.004	M5X30*	200	55040.050.030	M8X40*	100	55040.080.040
M3X5*	1000	55040.030.005	M5X35*	200	55040.050.035	M8X45*	100	55040.080.045
M3X6*	1000	55040.030.006	M5X40*	200	55040.050.040	M8X50*	100	55040.080.050
M3X8*	1000	55040.030.008	M5X45*	200	55040.050.045	M8X55*	100	55040.080.055
M3X10*	1000	55040.030.010	M5X50*	200	55040.050.050	M8X60*	100	55040.080.060
M3X12*	1000	55040.030.012	M5X60*	100	55040.050.060	M8X65*	100	55040.080.065
M3X14*	1000	55040.030.014	M5X65*	100	55040.050.065	M8X70*	100	55040.080.070
M3X16*	1000	55040.030.016	M5X75*	100	55040.050.075	M8X80*	100	55040.080.080
M3X18*	1000	55040.030.018	M5X80*	100	55040.050.080	M8X90*	100	55040.080.090
M3X20*	1000	55040.030.020	M6X8*	500	55040.060.008	M8X100*	50	55040.080.100
M3X22*	1000	55040.030.022	M6X10	500	55040.060.010	M10X16*	100	55040.100.016
M3X25*	1000	55040.030.025	M6X12*	500	55040.060.012	M10X18*	100	55040.100.018
M3X30*	1000	55040.030.030	M6X14*	200	55040.060.014	M10X20*	100	55040.100.020
M3X35*	500	55040.030.035	M6X16*	200	55040.060.016	M10X22*	100	55040.100.022
M4X4*	1000	55040.040.004	M6X18*	200	55040.060.018	M10X25*	100	55040.100.025
M4X5*	1000	55040.040.005	M6X20*	200	55040.060.020	M10X30*	100	55040.100.030
M4X6*	1000	55040.040.006	M6X22*	200	55040.060.022	M10X35*	100	55040.100.035
M4X8*	1000	55040.040.008	M6X25*	200	55040.060.025	M10X40*	100	55040.100.040
M4X10*	1000	55040.040.010	M6X30*	200	55040.060.030	M10X45*	100	55040.100.045
M4X12*	1000	55040.040.012	M6X35*	200	55040.060.035	M10X50*	50	55040.100.050
M4X14*	1000	55040.040.014	M6X40*	200	55040.060.040	M10X55*	50	55040.100.055
M4X16*	1000	55040.040.016	M6X45*	100	55040.060.045	M10X60*	50	55040.100.060
M4X18*	1000	55040.040.018	M6X50*	100	55040.060.050	M10X65*	50	55040.100.065
M4X20*	500	55040.040.020	M6X55*	100	55040.060.055	M10X70*	50	55040.100.070
M4X22*	500	55040.040.022	M6X60*	100	55040.060.060	M10X75*	50	55040.100.075
M4X25*	500	55040.040.025	M6X65*	100	55040.060.065	M10X80*	50	55040.100.080
M4X30*	500	55040.040.030	M6X70*	100	55040.060.070	M10X100*	50	55040.100.100
M4X35*	200	55040.040.035	M6X80*	100	55040.060.080	M10X110*	50	55040.100.110
M4X40*	200	55040.040.040	M6X90*	100	55040.060.090	M12X16*	50	55040.120.016
M4X50*	200	55040.040.050	M6X100*	100	55040.060.100	M12X18*	50	55040.120.018
M4X60*	100	55040.040.060	M8X8*	500	55040.080.008	M12X20*	50	55040.120.020
M5X6*	500	55040.050.006	M8X10*	500	55040.080.010	M12X25*	50	55040.120.025
M5X8*	500	55040.050.008	M8X12*	500	55040.080.012	M12X30*	50	55040.120.030
M5X10*	500	55040.050.010	M8X14*	200	55040.080.014	M12X35*	50	55040.120.035
M5X12	500	55040.050.012	M8X16*	200	55040.080.016	M12X40*	50	55040.120.040
M5X14*	500	55040.050.014	M8X18*	200	55040.080.018	M12X45*	50	55040.120.045
M5X16*	500	55040.050.016	M8X22*	200	55040.080.022	M12X50*	50	55040.120.050
M5X18*	500	55040.050.018	M8X25*	100	55040.080.025	M12X55*	50	55040.120.055
M5X20*	500	55040.050.020	M8X30*	100	55040.080.030	M12X60*	50	55040.120.060
M5X25*	200	55040.050.025	M8X35*	100	55040.080.035	M12X65*	50	55040.120.065

55040 Hexagon socket low head cap screw								
d x L	☒	Art.number	d x L	☒	Art.number	d x L	☒	Art.number
M12X70*	50	55040.120.070	M16X45*	25	55040.160.045	M20X40*	25	55040.200.040
M12X80*	25	55040.120.080	M16X50*	25	55040.160.050	M20X45*	25	55040.200.045
M12X90*	25	55040.120.090	M16X55*	25	55040.160.055	M20X50*	25	55040.200.050
M12X100*	25	55040.120.100	M16X60*	25	55040.160.060	M20X55*	25	55040.200.055
M12X110*	25	55040.120.110	M16X65*	25	55040.160.065	M20X60*	25	55040.200.060
M16X25*	25	55040.160.025	M16X70*	25	55040.160.070	M20X65*	25	55040.200.065
M16X30*	25	55040.160.030	M16X80*	25	55040.160.080	M20X70*	25	55040.200.070
M16X35*	25	55040.160.035	M20X30*	25	55040.200.030	M20X80*	25	55040.200.080
M16X40*	25	55040.160.040	M20X35*	25	55040.200.035	M20X90*	25	55040.200.090
						M20X120*	25	55040.200.120

Hexagon socket low head cap screw with pilot recess

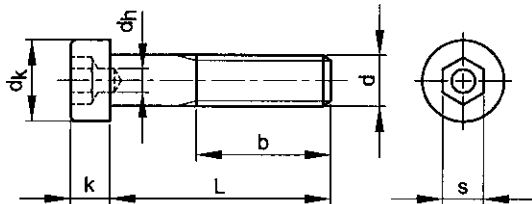

DIN 6912

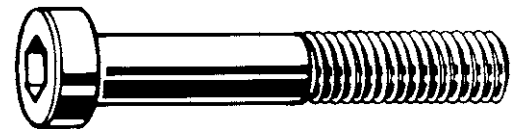

Technical Data

d	b (min.): L≤125mm	b (min.): 125mm<L≤200mm	b (min.): L>200mm	d _h	d _k	Full thread L ≤	k	P	s
M3 (#DIN)	12	-	-	-	5.5	18	2	0.5	2
M4	14	-	-	2	7	16	2.8	0.7	3
M5	16	-	-	2.5	8.5	20	3.5	0.8	4
M6	18	-	-	3	10	25	4	1	5
M8	22	-	-	4	13	30	5	1.25	6
M10	26	32	-	5	16	35	6.5	1.5	8
M12	30	36	-	6	18	45	7.5	1.75	10
M16	38	44	57	8	24	50	10	2	14
M20	46	52	65	10	30	60	12	2.5	17
M24	54	60	73	12	36	80	14	3	19

- Due to the unfavourable geometry of the head, these fasteners do have reduced loadability.
- When steel fasteners (e.g. 8.8 / 10.9 / 12.9) with reduced loadability needs to be marked, the marking symbol for the property class is preceded by the digit '0'. So 8.8 → 08.8 and 10.9 → 010.9 and 12.9 → 012.9.
- For the stainless steel fasteners it is indicated by only marking the steel grade and by leaving out the property class 70 (e.g. A2-70 → A2).
- The former and the new indications can occur side by side for some time.

Article groups

Thread	Driving features	Material	Class	Code	Page
M	Hexagon socket	St	08.8	07030	2-36
M	Hexagon socket	St.St. A2		51042	2-37
M	Hexagon socket	St.St. A4		55042	2-38

07030 Hexagon socket low head cap screw with pilot recess D03A

Thread: Metric thread
Material: Steel
Class: 08.8

d x L	☒	Art.number	d x L	☒	Art.number	d x L	☒	Art.number
M4X8	200	07030.040.008	M6X12	200	07030.060.012	M8X40	200	07030.080.040
M4X10	200	07030.040.010	M6X16	200	07030.060.016	M8X45	200	07030.080.045
M4X12	200	07030.040.012	M6X20	200	07030.060.020	M8X50	200	07030.080.050
M4X16	200	07030.040.016	M6X25	200	07030.060.025	M8X60	200	07030.080.060
M4X20	200	07030.040.020	M6X30	200	07030.060.030			
M4X25	200	07030.040.025	M6X35	200	07030.060.035	M10X20	200	07030.100.020
			M6X40	200	07030.060.040	M10X22	200	07030.100.022
M5X10	200	07030.050.010	M6X45	200	07030.060.045	M10X25	200	07030.100.025
M5X12	200	07030.050.012	M6X50	200	07030.060.050	M10X30	200	07030.100.030
M5X16	200	07030.050.016	M6X60	200	07030.060.060	M10X35	100	07030.100.035
M5X20	200	07030.050.020				M10X40	100	07030.100.040
M5X25	200	07030.050.025	M8X12	200	07030.080.012	M10X50	100	07030.100.050
M5X30	200	07030.050.030	M8X16	200	07030.080.016	M10X60	100	07030.100.060
M5X35	200	07030.050.035	M8X20	200	07030.080.020	M10X70	100	07030.100.070
M5X40	200	07030.050.040	M8X25	200	07030.080.025	M10X80	100	07030.100.080
			M8X30	200	07030.080.030	M10X100	100	07030.100.100
M6X10	200	07030.060.010	M8X35	200	07030.080.035			

07030 Hexagon socket low head cap screw with pilot recess								
d x L	☒	Art.number	d x L	☒	Art.number	d x L	☒	Art.number
M12X20	100	07030.120.020	M16X40	50	07030.160.040	M20X70	25	07030.200.070
M12X25	100	07030.120.025	M16X45	50	07030.160.045	M20X80	25	07030.200.080
M12X30	100	07030.120.030	M16X50	50	07030.160.050	M20X90	25	07030.200.090
M12X35	100	07030.120.035	M16X60	50	07030.160.060	M20X100	25	07030.200.100
M12X40	100	07030.120.040	M16X70	50	07030.160.070	M20X120	25	07030.200.120
M12X45	100	07030.120.045	M16X80	50	07030.160.080	M20X140	25	07030.200.140
M12X50	100	07030.120.050	M16X90	25	07030.160.090			
M12X60	100	07030.120.060	M16X100	25	07030.160.100	M24X50	10	07030.240.050
M12X80	50	07030.120.080	M16X120	25	07030.160.120	M24X60	10	07030.240.060
M12X90	50	07030.120.090				M24X70	10	07030.240.070
M12X100	50	07030.120.100	M20X40	25	07030.200.040	M24X80	10	07030.240.080
			M20X45	25	07030.200.045	M24X90	10	07030.240.090
M16X30	50	07030.160.030	M20X50	25	07030.200.050	M24X100	10	07030.240.100
M16X35	50	07030.160.035	M20X60	25	07030.200.060	M24X120	10	07030.240.120

51042 Hexagon socket low head cap screw with pilot recess		Q05A
Thread	Metric thread	
Material	Stainless steel A2	



d x L	☒	Art.number	d x L	☒	Art.number	d x L	☒	Art.number
M3X5*	1000	51042.030.005	M6X20	100	51042.060.020	M10X80	10	51042.100.080
M3X6*	1000	51042.030.006	M6X22*	200	51042.060.022	M10X90	10	51042.100.090
M3X8*	1000	51042.030.008	M6X25	50	51042.060.025	M10X100	10	51042.100.100
M3X10*	1000	51042.030.010	M6X30	50	51042.060.030	M10X110*	50	51042.100.110
M3X12*	1000	51042.030.012	M6X35	50	51042.060.035	M10X120*	50	51042.100.120
M3X16*	1000	51042.030.016	M6X40	50	51042.060.040			
M3X20*	1000	51042.030.020	M6X45	50	51042.060.045	M12X16	25	51042.120.016
M3X25*	1000	51042.030.025	M6X50	50	51042.060.050	M12X20	25	51042.120.020
M3X30*	1000	51042.030.030	M6X55	50	51042.060.055	M12X25	25	51042.120.025
			M6X60	25	51042.060.060	M12X30	25	51042.120.030
M4X5*	1000	51042.040.005	M6X65*	100	51042.060.065	M12X35	25	51042.120.035
M4X6*	1000	51042.040.006	M6X70	25	51042.060.070	M12X40	10	51042.120.040
M4X8	100	51042.040.008	M6X75*	100	51042.060.075	M12X45	10	51042.120.045
M4X10	100	51042.040.010	M6X80	25	51042.060.080	M12X50	10	51042.120.050
M4X12	100	51042.040.012	M6X90*	100	51042.060.090	M12X55	10	51042.120.055
M4X14*	1000	51042.040.014	M6X100*	100	51042.060.100	M12X60	10	51042.120.060
M4X16	100	51042.040.016	M6X120*	100	51042.060.120	M12X65*	50	51042.120.065
M4X18*	1000	51042.040.018				M12X70	5	51042.120.070
M4X20	100	51042.040.020	M8X10	50	51042.080.010	M12X75*	25	51042.120.075
M4X22*	500	51042.040.022	M8X12	50	51042.080.012	M12X80	5	51042.120.080
M4X25	100	51042.040.025	M8X14*	200	51042.080.014	M12X90	5	51042.120.090
M4X30	100	51042.040.030	M8X16	50	51042.080.016	M12X100	5	51042.120.100
M4X35	100	51042.040.035	M8X18*	200	51042.080.018	M12X120*	25	51042.120.120
M4X40	100	51042.040.040	M8X20	50	51042.080.020			
M4X45*	200	51042.040.045	M8X22*	200	51042.080.022	M16X25	10	51042.160.025
M4X50*	200	51042.040.050	M8X25	50	51042.080.025	M16X30	10	51042.160.030
M4X55*	200	51042.040.055	M8X30	50	51042.080.030	M16X35	5	51042.160.035
M4X60*	100	51042.040.060	M8X35	50	51042.080.035	M16X40	5	51042.160.040
			M8X40	50	51042.080.040	M16X45	5	51042.160.045
M5X6*	500	51042.050.006	M8X45*	100	51042.080.045	M16X50	5	51042.160.050
M5X8	100	51042.050.008	M8X50	25	51042.080.050	M16X55	5	51042.160.055
M5X10	100	51042.050.010	M8X55	25	51042.080.055	M16X60	5	51042.160.060
M5X12	100	51042.050.012	M8X60	25	51042.080.060	M16X65*	25	51042.160.065
M5X14*	500	51042.050.014	M8X65*	100	51042.080.065	M16X70	5	51042.160.070
M5X16	100	51042.050.016	M8X70	10	51042.080.070	M16X75*	25	51042.160.075
M5X18*	500	51042.050.018	M8X75*	100	51042.080.075	M16X80	3	51042.160.080
M5X20	100	51042.050.020	M8X80	10	51042.080.080	M16X90	3	51042.160.090
M5X22*	500	51042.050.022	M8X85*	100	51042.080.085	M16X100	3	51042.160.100
M5X25	100	51042.050.025	M8X90*	100	51042.080.090	M16X110*	25	51042.160.110
M5X30	100	51042.050.030	M8X100	10	51042.080.100	M16X120*	25	51042.160.120
M5X35	50	51042.050.035	M8X120*	50	51042.080.120			
M5X40	50	51042.050.040				M20X30*	25	51042.200.030
M5X45	50	51042.050.045	M10X16	50	51042.100.016	M20X35	3	51042.200.035
M5X50	50	51042.050.050	M10X18*	100	51042.100.018	M20X40	3	51042.200.040
M5X55*	200	51042.050.055	M10X20	50	51042.100.020	M20X45	3	51042.200.045
M5X60*	100	51042.050.060	M10X25	25	51042.100.025	M20X50*	25	51042.200.050
M5X65*	100	51042.050.065	M10X30	25	51042.100.030	M20X55*	25	51042.200.055
M5X70*	100	51042.050.070	M10X35	25	51042.100.035	M20X60	3	51042.200.060
M5X80*	100	51042.050.080	M10X40	25	51042.100.040	M20X70	3	51042.200.070
			M10X45*	100	51042.100.045	M20X80	3	51042.200.080
M6X8	100	51042.060.008	M10X50	25	51042.100.050	M20X90	3	51042.200.090
M6X10	100	51042.060.010	M10X55	25	51042.100.055	M20X100	3	51042.200.100
M6X12	100	51042.060.012	M10X60	10	51042.100.060	M20X120*	25	51042.200.120
M6X14*	200	51042.060.014	M10X65*	50	51042.100.065			
M6X16	100	51042.060.016	M10X70	10	51042.100.070	M24X55	3	51042.240.055
M6X18*	200	51042.060.018	M10X75*	50	51042.100.075	M24X60	3	51042.240.060

51042 Hexagon socket low head cap screw with pilot recess



d x L	☒	Art.number
M24X70	3	51042.240.070

2

55042 Hexagon socket low head cap screw with pilot recess

Q45A

Thread Metric thread
Material Stainless steel A4



d x L	☒	Art.number	d x L	☒	Art.number	d x L	☒	Art.number
M3X5*	1000	55042.030.005	M6X25	50	55042.060.025	M10X80*	50	55042.100.080
M3X6*	1000	55042.030.006	M6X30	50	55042.060.030	M10X90*	50	55042.100.090
M3X8*	1000	55042.030.008	M6X35	50	55042.060.035	M10X100*	50	55042.100.100
M3X10*	1000	55042.030.010	M6X40	50	55042.060.040	M10X120*	50	55042.100.120
M3X12*	1000	55042.030.012	M6X45*	100	55042.060.045			
			M6X50	50	55042.060.050	M12X16*	50	55042.120.016
M4X5*	1000	55042.040.005	M6X55*	100	55042.060.055	M12X20	25	55042.120.020
M4X6*	1000	55042.040.006	M6X60*	100	55042.060.060	M12X25	25	55042.120.025
M4X8*	1000	55042.040.008	M6X70*	100	55042.060.070	M12X30	25	55042.120.030
M4X10	100	55042.040.010	M6X75*	100	55042.060.075	M12X35	25	55042.120.035
M4X12	100	55042.040.012	M6X80*	100	55042.060.080	M12X40	10	55042.120.040
M4X14*	1000	55042.040.014	M6X90*	100	55042.060.090	M12X45*	50	55042.120.045
M4X16	100	55042.040.016	M6X120*	100	55042.060.120	M12X50	10	55042.120.050
M4X20	100	55042.040.020				M12X55*	50	55042.120.055
M4X22*	500	55042.040.022	M8X10*	500	55042.080.010	M12X60	10	55042.120.060
M4X25	100	55042.040.025	M8X12*	500	55042.080.012	M12X70*	50	55042.120.070
M4X30	100	55042.040.030	M8X14*	200	55042.080.014	M12X75*	25	55042.120.075
M4X35*	200	55042.040.035	M8X16	50	55042.080.016	M12X80*	25	55042.120.080
M4X40*	200	55042.040.040	M8X18*	200	55042.080.018	M12X90*	25	55042.120.090
M4X45*	200	55042.040.045	M8X20	50	55042.080.020	M12X100*	25	55042.120.100
M4X50*	200	55042.040.050	M8X22*	200	55042.080.022			
			M8X25	50	55042.080.025	M16X25*	25	55042.160.025
M5X6*	500	55042.050.006	M8X30	50	55042.080.030	M16X30	10	55042.160.030
M5X8*	500	55042.050.008	M8X35	50	55042.080.035	M16X35	5	55042.160.035
M5X10	100	55042.050.010	M8X40	50	55042.080.040	M16X40*	25	55042.160.040
M5X12	100	55042.050.012	M8X45*	100	55042.080.045	M16X45	5	55042.160.045
M5X14*	500	55042.050.014	M8X50	25	55042.080.050	M16X50	5	55042.160.050
M5X16	100	55042.050.016	M8X55*	100	55042.080.055	M16X55*	25	55042.160.055
M5X18*	500	55042.050.018	M8X60	25	55042.080.060	M16X60*	25	55042.160.060
M5X20	100	55042.050.020	M8X65*	100	55042.080.065	M16X70	5	55042.160.070
M5X22*	500	55042.050.022	M8X70*	100	55042.080.070	M16X80	3	55042.160.080
M5X25	100	55042.050.025	M8X75*	100	55042.080.075	M16X90	5	55042.160.090
M5X30	100	55042.050.030	M8X80*	100	55042.080.080	M16X100*	25	55042.160.100
M5X35	50	55042.050.035	M8X90*	100	55042.080.090	M16X110*	25	55042.160.110
M5X40	50	55042.050.040	M8X100*	50	55042.080.100	M16X130*	25	55042.160.130
M5X45*	200	55042.050.045	M8X110*	50	55042.080.110			
M5X50*	200	55042.050.050	M8X120*	50	55042.080.120	M20X35*	25	55042.200.035
M5X55*	200	55042.050.055				M20X40	3	55042.200.040
M5X60*	100	55042.050.060	M10X16*	100	55042.100.016	M20X45*	25	55042.200.045
M5X65*	100	55042.050.065	M10X20	50	55042.100.020	M20X50	3	55042.200.050
M5X70*	100	55042.050.070	M10X25	25	55042.100.025	M20X55*	25	55042.200.055
			M10X30	25	55042.100.030	M20X60	3	55042.200.060
M6X8*	500	55042.060.008	M10X35	50	55042.100.035	M20X65*	25	55042.200.065
M6X10*	500	55042.060.010	M10X40	25	55042.100.040	M20X70	3	55042.200.070
M6X12	100	55042.060.012	M10X45*	100	55042.100.045	M20X80	3	55042.200.080
M6X14*	200	55042.060.014	M10X50	25	55042.100.050	M20X90	3	55042.200.090
M6X16	100	55042.060.016	M10X55*	50	55042.100.055	M20X100	3	55042.200.100
M6X18*	200	55042.060.018	M10X60	10	55042.100.060	M20X120*	25	55042.200.120
M6X20	100	55042.060.020	M10X70*	50	55042.100.070	M20X150*	25	55042.200.150
M6X22*	200	55042.060.022	M10X75*	50	55042.100.075			

Hexagon socket countersunk head screw

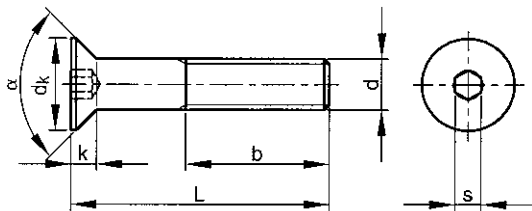

ISO 10642
DIN 7991
NEN 2359
BS 4168-8

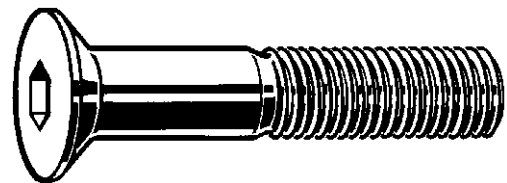

2

Technical Data

d	b	d _k	Full thread L ≤	k (max.)	P	s	α
M3	18	6.72	25	1.86	0.5	2	90°
M4	20	8.96	25	2.48	0.7	2.5	90°
M5	22	11.2	30	3.2	0.8	3	90°
M6	24	13.44	35	3.72	1	4	90°
M8	28	17.92	45	4.96	1.25	5	90°
M10	32	22.4	50	6.2	1.5	6	90°
M12	36	26.88	60	7.4	1.75	8	90°
M14	40	30.8	65	8.4	2	10	90°
M16	44	33.6	70	8.8	2	10	90°
M18 (DIN)	42	33	60	8	2.5	12	90°
M20	52	40.32	90	10.16	2.5	12	90°
M24 (DIN)	54	39	90	14	3	14	60°

- All dimensions are guide values and may deviate dependent on the manufacturer.
- Due to the unfavourable geometry of the head, these fasteners have reduced loadability.
- When steel fasteners (e.g. 8.8 / 10.9 / 12.9) with reduced loadability need to be marked, the marking symbol for the property class is preceded by the digit '0'. So 8.8 → 08.8 and 10.9 → 010.9 and 12.9 → 012.9.
- For the stainless steel fasteners it is indicated by marking the steel grade only and leaving out the property class 70 (e.g. A2-70 → A2).
- The former and the latter indications can occur side by side for some time.

Article groups

Thread	Driving features	Material	Class	Surface treatment	Code	Page
M	Hexagon socket	St	08.8	Zipl	07470	2-39
M	Hexagon socket	St	010.9		07400	2-40
M	Hexagon socket	St	010.9	FLZNNC-NC6	07407	2-41
M	Hexagon socket	St.St. A2			51060	2-41
M	Hexagon socket	St.St. A4			55060	2-42
M	Hexagon socket	Al P40			45008	2-43
M	Hexagon socket	Al P60			45208	2-44

07470 Hexagon socket countersunk head screw

D02A

Thread Metric thread
Material Steel
Class 08.8
Surface treatment Zinc plated

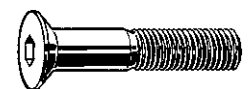

d x L	☒	Art.number	d x L	☒	Art.number	d x L	☒	Art.number
M3X6	200	07470.030.006	M5X8	200	07470.050.008	M6X45	200	07470.060.045
M3X8	200	07470.030.008	M5X10	200	07470.050.010	M6X50	200	07470.060.050
M3X10	200	07470.030.010	M5X12	200	07470.050.012	M6X60	200	07470.060.060
M3X12	200	07470.030.012	M5X16	200	07470.050.016	M6X70	200	07470.060.070
M3X16	200	07470.030.016	M5X20	200	07470.050.020	M6X80	200	07470.060.080
M3X20	200	07470.030.020	M5X25	200	07470.050.025			
M3X25	200	07470.030.025	M5X30	200	07470.050.030	M8X10	200	07470.080.010
M3X30	200	07470.030.030	M5X35	200	07470.050.035	M8X12	200	07470.080.012
M3X40	200	07470.030.040	M5X40	200	07470.050.040	M8X16	200	07470.080.016
M3X50	200	07470.030.050	M5X45	200	07470.050.045	M8X20	200	07470.080.020
			M5X50	200	07470.050.050	M8X25	200	07470.080.025
M4X6	200	07470.040.006	M5X60	200	07470.050.060	M8X30	200	07470.080.030
M4X8	200	07470.040.008	M5X70	200	07470.050.070	M8X35	200	07470.080.035
M4X10	200	07470.040.010				M8X40	200	07470.080.040
M4X12	200	07470.040.012	M6X8	200	07470.060.008	M8X45	200	07470.080.045
M4X16	200	07470.040.016	M6X10	200	07470.060.010	M8X50	200	07470.080.050
M4X20	200	07470.040.020	M6X12	200	07470.060.012	M8X55	200	07470.080.055
M4X25	200	07470.040.025	M6X16	200	07470.060.016	M8X60	200	07470.080.060
M4X30	200	07470.040.030	M6X18	200	07470.060.018	M8X65	200	07470.080.065
M4X35	200	07470.040.035	M6X20	200	07470.060.020	M8X70	200	07470.080.070
M4X40	200	07470.040.040	M6X25	200	07470.060.025	M8X80	200	07470.080.080
M4X50	200	07470.040.050	M6X30	200	07470.060.030	M8X90	200	07470.080.090
M4X60	200	07470.040.060	M6X35	200	07470.060.035	M8X100	200	07470.080.100
			M6X40	200	07470.060.040			

07470 Hexagon socket countersunk head screw								
d x L	☒	Art.number	d x L	☒	Art.number	d x L	☒	Art.number
M10X16	200	07470.100.016	M12X35	100	07470.120.035	M16X70	25	07470.160.070
M10X20	200	07470.100.020	M12X40	100	07470.120.040	M16X80	25	07470.160.080
M10X25	200	07470.100.025	M12X45	100	07470.120.045	M16X100	25	07470.160.100
M10X30	200	07470.100.030	M12X50	100	07470.120.050	M16X120	25	07470.160.120
M10X35	100	07470.100.035	M12X55	100	07470.120.055	M16X140	25	07470.160.140
M10X40	100	07470.100.040	M12X60	100	07470.120.060			
M10X45	100	07470.100.045	M12X70	50	07470.120.070	M20X40	25	07470.200.040
M10X50	100	07470.100.050	M12X80	50	07470.120.080	M20X45	25	07470.200.045
M10X55	100	07470.100.055	M12X90	50	07470.120.090	M20X50	25	07470.200.050
M10X60	100	07470.100.060	M12X100	50	07470.120.100	M20X60	25	07470.200.060
M10X70	100	07470.100.070	M12X120	50	07470.120.120	M20X70	25	07470.200.070
M10X80	100	07470.100.080				M20X80	25	07470.200.080
M10X90	100	07470.100.090	M16X30	50	07470.160.030	M20X90	25	07470.200.090
M10X100	50	07470.100.100	M16X35	50	07470.160.035	M20X100	25	07470.200.100
M10X120	50	07470.100.120	M16X40	50	07470.160.040			
			M16X45	50	07470.160.045	M24X50	25	07470.240.050
M12X20	100	07470.120.020	M16X50	50	07470.160.050	M24X60	10	07470.240.060
M12X25	100	07470.120.025	M16X55	50	07470.160.055	M24X70	10	07470.240.070
M12X30	100	07470.120.030	M16X60	50	07470.160.060	M24X80	10	07470.240.080

07400 Hexagon socket countersunk head screw D01A

Thread
Material
Class

Metric thread
Steel
010.9

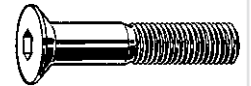

d x L	☒	Art.number	d x L	☒	Art.number	d x L	☒	Art.number
M3X5	200	07400.030.005	M6X30	200	07400.060.030	M12X35	100	07400.120.035
M3X6	200	07400.030.006	M6X35	200	07400.060.035	M12X40	100	07400.120.040
M3X8	200	07400.030.008	M6X40	200	07400.060.040	M12X45	100	07400.120.045
M3X10	200	07400.030.010	M6X45	200	07400.060.045	M12X50	100	07400.120.050
M3X12	200	07400.030.012	M6X50	200	07400.060.050	M12X55	100	07400.120.055
M3X16	200	07400.030.016	M6X55	200	07400.060.055	M12X60	100	07400.120.060
M3X20	200	07400.030.020	M6X60	200	07400.060.060	M12X70	100	07400.120.070
M3X25	200	07400.030.025	M6X70	200	07400.060.070	M12X80	100	07400.120.080
M3X30	200	07400.030.030	M6X80	200	07400.060.080	M12X90	50	07400.120.090
M3X40	200	07400.030.040	M6X90	200	07400.060.090	M12X100	50	07400.120.100
M3X50	200	07400.030.050	M6X100	200	07400.060.100	M12X110	50	07400.120.110
						M12X120	50	07400.120.120
M4X6	200	07400.040.006	M8X10	200	07400.080.010	M12X130	50	07400.120.130
M4X8	200	07400.040.008	M8X12	200	07400.080.012	M12X140	50	07400.120.140
M4X10	200	07400.040.010	M8X16	200	07400.080.016	M12X160	50	07400.120.160
M4X12	200	07400.040.012	M8X20	200	07400.080.020	M12X180	50	07400.120.180
M4X14	200	07400.040.014	M8X22	200	07400.080.022			
M4X16	200	07400.040.016	M8X25	200	07400.080.025	M14X25	25	07400.140.025
M4X20	200	07400.040.020	M8X30	200	07400.080.030	M14X30	25	07400.140.030
M4X25	200	07400.040.025	M8X35	200	07400.080.035	M14X35	25	07400.140.035
M4X30	200	07400.040.030	M8X40	200	07400.080.040	M14X40	25	07400.140.040
M4X35	200	07400.040.035	M8X45	200	07400.080.045	M14X45	50	07400.140.045
M4X40	200	07400.040.040	M8X50	200	07400.080.050	M14X50	25	07400.140.050
M4X50	200	07400.040.050	M8X55	200	07400.080.055	M14X60	25	07400.140.060
M4X60	200	07400.040.060	M8X60	100	07400.080.060	M14X70	25	07400.140.070
M4X70	200	07400.040.070	M8X70	100	07400.080.070	M14X80	25	07400.140.080
			M8X80	100	07400.080.080	M14X90	25	07400.140.090
M5X8	200	07400.050.008	M8X90	100	07400.080.090	M14X100	25	07400.140.100
M5X10	200	07400.050.010	M8X100	100	07400.080.100			
M5X12	200	07400.050.012				M16X20	50	07400.160.020
M5X16	200	07400.050.016	M10X16	200	07400.100.016	M16X25	50	07400.160.025
M5X18	200	07400.050.018	M10X20	200	07400.100.020	M16X30	50	07400.160.030
M5X20	200	07400.050.020	M10X25	200	07400.100.025	M16X35	50	07400.160.035
M5X22	200	07400.050.022	M10X30	200	07400.100.030	M16X40	50	07400.160.040
M5X25	200	07400.050.025	M10X35	100	07400.100.035	M16X45	50	07400.160.045
M5X30	200	07400.050.030	M10X40	100	07400.100.040	M16X50	50	07400.160.050
M5X35	200	07400.050.035	M10X45	100	07400.100.045	M16X55	50	07400.160.055
M5X40	200	07400.050.040	M10X50	100	07400.100.050	M16X60	50	07400.160.060
M5X45	200	07400.050.045	M10X55	100	07400.100.055	M16X70	25	07400.160.070
M5X50	200	07400.050.050	M10X60	100	07400.100.060	M16X80	25	07400.160.080
M5X60	200	07400.050.060	M10X65	100	07400.100.065	M16X90	25	07400.160.090
M5X70	200	07400.050.070	M10X70	100	07400.100.070	M16X100	25	07400.160.100
			M10X75	100	07400.100.075	M16X110	25	07400.160.110
M6X8	200	07400.060.008	M10X80	100	07400.100.080	M16X120	25	07400.160.120
M6X10	200	07400.060.010	M10X90	100	07400.100.090	M16X130	25	07400.160.130
M6X12	200	07400.060.012	M10X100	50	07400.100.100	M16X140	25	07400.160.140
M6X14	200	07400.060.014	M10X120	50	07400.100.120	M16X160	25	07400.160.160
M6X16	200	07400.060.016						
M6X18	200	07400.060.018	M12X20	100	07400.120.020	M18X50	25	07400.180.050
M6X20	200	07400.060.020	M12X25	100	07400.120.025	M18X60	25	07400.180.060
M6X25	200	07400.060.025	M12X30	100	07400.120.030	M18X70	25	07400.180.070

07400 Hexagon socket countersunk head screw								
d x L	☒	Art.number	d x L	☒	Art.number	d x L	☒	Art.number
M18X80	25	07400.180.080	M20X90	10	07400.200.090	M24X70	10	07400.240.070
M18X90	25	07400.180.090	M20X100	10	07400.200.100	M24X80	10	07400.240.080
M18X100	25	07400.180.100	M20X110	10	07400.200.110	M24X90	10	07400.240.090
			M20X120	10	07400.200.120	M24X100	10	07400.240.100
M20X30	10	07400.200.030	M20X140	10	07400.200.140	M24X110	10	07400.240.110
M20X35	10	07400.200.035	M20X150	10	07400.200.150	M24X120	10	07400.240.120
M20X40	10	07400.200.040	M20X160	10	07400.200.160	M24X140	10	07400.240.140
M20X50	10	07400.200.050	M20X180	10	07400.200.180	M24X160	10	07400.240.160
M20X55	25	07400.200.055	M20X200	10	07400.200.200	M24X180	10	07400.240.180
M20X60	10	07400.200.060				M24X200	10	07400.240.200
M20X70	10	07400.200.070	M24X50	10	07400.240.050			
M20X80	10	07400.200.080	M24X60	10	07400.240.060			

• Warning: electro-galvanizing of these products may cause hydrogen embrittlement.

07407 Hexagon socket countersunk head screw		D01A
Thread	Metric thread	
Material	Steel	
Class	010.9	
Surface treatment	Zinc flake Cr ⁶⁺ free - ISO 10683 flZnnc	
		

d x L	☒	Art.number	d x L	☒	Art.number	d x L	☒	Art.number
M6X16	200	07407.060.016	M10X20	200	07407.100.020	M12X70	100	07407.120.070
M6X20	200	07407.060.020	M10X25	200	07407.100.025	M12X80	100	07407.120.080
M6X25	200	07407.060.025	M10X30	200	07407.100.030			
M6X30	200	07407.060.030	M10X35	200	07407.100.035	M16X25	50	07407.160.025
M6X40	200	07407.060.040	M10X40	200	07407.100.040	M16X30	50	07407.160.030
			M10X50	100	07407.100.050	M16X40	50	07407.160.040
M8X16	200	07407.080.016	M10X60	100	07407.100.060	M16X50	50	07407.160.050
M8X20	200	07407.080.020				M16X60	50	07407.160.060
M8X25	200	07407.080.025	M12X30	100	07407.120.030			
M8X30	200	07407.080.030	M12X40	100	07407.120.040	M20X50	10	07407.200.050
M8X35	200	07407.080.035	M12X50	100	07407.120.050	M20X60	10	07407.200.060
M8X40	200	07407.080.040	M12X60	100	07407.120.060	M20X70	10	07407.200.070

• A ISO 10683 Zinc Flake surface coating eliminates the possibilities of damage which can arise due to hydrogen embrittlement.

51060 Hexagon socket countersunk head screw		Q05A	
Thread	Metric thread		
Material	Stainless steel A2		
			

d x L	☒	Art.number	d x L	☒	Art.number	d x L	☒	Art.number
M3X4*	1000	51060.030.004	M4X35	200	51060.040.035	M6X10	200	51060.060.010
M3X5*	1000	51060.030.005	M4X40	200	51060.040.040	M6X12	200	51060.060.012
M3X6	200	51060.030.006	M4X45	200	51060.040.045	M6X14	200	51060.060.014
M3X8	200	51060.030.008	M4X50	200	51060.040.050	M6X16	200	51060.060.016
M3X10	200	51060.030.010	M4X55*	200	51060.040.055	M6X18	200	51060.060.018
M3X12	200	51060.030.012	M4X60*	100	51060.040.060	M6X20	200	51060.060.020
M3X14	200	51060.030.014				M6X22*	200	51060.060.022
M3X16	200	51060.030.016	M5X6	500	51060.050.006	M6X25	200	51060.060.025
M3X18	200	51060.030.018	M5X8	200	51060.050.008	M6X30	200	51060.060.030
M3X20	200	51060.030.020	M5X10	200	51060.050.010	M6X35	200	51060.060.035
M3X22*	1000	51060.030.022	M5X12	200	51060.050.012	M6X40	200	51060.060.040
M3X25	200	51060.030.025	M5X14	200	51060.050.014	M6X45	100	51060.060.045
M3X30*	1000	51060.030.030	M5X16	200	51060.050.016	M6X50	100	51060.060.050
M3X35*	500	51060.030.035	M5X18	200	51060.050.018	M6X55	100	51060.060.055
M3X40	200	51060.030.040	M5X20	200	51060.050.020	M6X60	100	51060.060.060
M3X45*	500	51060.030.045	M5X22*	500	51060.050.022	M6X65	100	51060.060.065
M3X50	200	51060.030.050	M5X25	200	51060.050.025	M6X70	100	51060.060.070
			M5X30	200	51060.050.030	M6X75*	100	51060.060.075
M4X5*	1000	51060.040.005	M5X35	200	51060.050.035	M6X80	100	51060.060.080
M4X6	200	51060.040.006	M5X40	200	51060.050.040	M6X90	100	51060.060.090
M4X8	200	51060.040.008	M5X45	200	51060.050.045	M6X100	100	51060.060.100
M4X10	200	51060.040.010	M5X50	100	51060.050.050	M6X110*	100	51060.060.110
M4X12	200	51060.040.012	M5X55	200	51060.050.055	M6X120*	100	51060.060.120
M4X14	200	51060.040.014	M5X60	100	51060.050.060	M6X130*	100	51060.060.130
M4X16	200	51060.040.016	M5X65*	100	51060.050.065	M6X140*	100	51060.060.140
M4X18	200	51060.040.018	M5X70	100	51060.050.070	M6X150*	100	51060.060.150
M4X20	200	51060.040.020	M5X75*	100	51060.050.075			
M4X22*	500	51060.040.022	M5X80*	100	51060.050.080	M8X10	200	51060.080.010
M4X25	200	51060.040.025				M8X12	200	51060.080.012
M4X30	200	51060.040.030	M6X8	200	51060.060.008	M8X14*	200	51060.080.014

51060 Hexagon socket countersunk head screw ←

d x L	☒	Art.number	d x L	☒	Art.number	d x L	☒	Art.number
M8X16	200	51060.080.016	M10X100	50	51060.100.100	M16X70	25	51060.160.070
M8X18	200	51060.080.018	M10X110*	50	51060.100.110	M16X75*	25	51060.160.075
M8X20	200	51060.080.020	M10X120	50	51060.100.120	M16X80	25	51060.160.080
M8X22*	200	51060.080.022	M10X130*	50	51060.100.130	M16X90	25	51060.160.090
M8X25	100	51060.080.025	M10X140*	50	51060.100.140	M16X100	10	51060.160.100
M8X30	100	51060.080.030	M10X150*	50	51060.100.150	M16X110	10	51060.160.110
M8X35	100	51060.080.035	M10X160*	50	51060.100.160	M16X120	10	51060.160.120
M8X40	100	51060.080.040	M10X170*	25	51060.100.170	M16X130	10	51060.160.130
M8X45	100	51060.080.045	M10X180*	25	51060.100.180	M16X140*	25	51060.160.140
M8X50	100	51060.080.050	M10X190*	25	51060.100.190	M16X150*	25	51060.160.150
M8X55	100	51060.080.055	M10X200*	25	51060.100.200			
M8X60	100	51060.080.060				M20X30*	25	51060.200.030
M8X65	100	51060.080.065	M12X16	50	51060.120.016	M20X35*	25	51060.200.035
M8X70	50	51060.080.070	M12X18*	50	51060.120.018	M20X40	25	51060.200.040
M8X75*	100	51060.080.075	M12X20	50	51060.120.020	M20X45*	25	51060.200.045
M8X80	50	51060.080.080	M12X25	50	51060.120.025	M20X50	10	51060.200.050
M8X90	50	51060.080.090	M12X30	50	51060.120.030	M20X55	10	51060.200.055
M8X100	50	51060.080.100	M12X35	50	51060.120.035	M20X60	5	51060.200.060
M8X110	50	51060.080.110	M12X40	50	51060.120.040	M20X65*	25	51060.200.065
M8X120	50	51060.080.120	M12X45	50	51060.120.045	M20X70	10	51060.200.070
M8X130*	50	51060.080.130	M12X50	50	51060.120.050	M20X75*	25	51060.200.075
M8X140*	50	51060.080.140	M12X55	50	51060.120.055	M20X80	10	51060.200.080
M8X150*	50	51060.080.150	M12X60	50	51060.120.060	M20X90	10	51060.200.090
M8X160*	50	51060.080.160	M12X65*	50	51060.120.065	M20X100	10	51060.200.100
M8X170*	25	51060.080.170	M12X70	25	51060.120.070	M20X110*	25	51060.200.110
M8X180*	25	51060.080.180	M12X75*	25	51060.120.075	M20X120*	25	51060.200.120
M8X190*	25	51060.080.190	M12X80	25	51060.120.080	M20X130*	25	51060.200.130
M8X200*	25	51060.080.200	M12X90	25	51060.120.090	M20X140*	25	51060.200.140
			M12X100	25	51060.120.100	M20X150*	25	51060.200.150
M10X12*	100	51060.100.012	M12X110*	25	51060.120.110			
M10X14*	100	51060.100.014	M12X120*	25	51060.120.120	M24X40*	10	51060.240.040
M10X16	100	51060.100.016	M12X130*	25	51060.120.130	M24X45*	10	51060.240.045
M10X18	100	51060.100.018	M12X140*	25	51060.120.140	M24X50	10	51060.240.050
M10X20	100	51060.100.020	M12X150*	25	51060.120.150	M24X55*	10	51060.240.055
M10X22*	100	51060.100.022	M12X160*	25	51060.120.160	M24X60	10	51060.240.060
M10X25	100	51060.100.025	M12X170*	25	51060.120.170	M24X65*	10	51060.240.065
M10X30	100	51060.100.030	M12X180*	25	51060.120.180	M24X70	10	51060.240.070
M10X35	100	51060.100.035	M12X200*	25	51060.120.200	M24X75*	10	51060.240.075
M10X40	100	51060.100.040				M24X80	10	51060.240.080
M10X45	100	51060.100.045	M16X25	25	51060.160.025	M24X90	10	51060.240.090
M10X50	100	51060.100.050	M16X30	25	51060.160.030	M24X100	10	51060.240.100
M10X55	100	51060.100.055	M16X35	25	51060.160.035	M24X110	10	51060.240.110
M10X60	50	51060.100.060	M16X40	25	51060.160.040	M24X120	10	51060.240.120
M10X65*	50	51060.100.065	M16X45	25	51060.160.045	M24X130	10	51060.240.130
M10X70	50	51060.100.070	M16X50	25	51060.160.050	M24X140	10	51060.240.140
M10X75*	50	51060.100.075	M16X55*	25	51060.160.055	M24X150	10	51060.240.150
M10X80	50	51060.100.080	M16X60	25	51060.160.060			
M10X90	50	51060.100.090	M16X65*	25	51060.160.065			

55060 Hexagon socket countersunk head screw Q45A

Thread Metric thread
Material Stainless steel A4

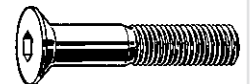

d x L	☒	Art.number	d x L	☒	Art.number	d x L	☒	Art.number
M3X4*	1000	55060.030.004	M4X12	200	55060.040.012	M5X20	200	55060.050.020
M3X5*	1000	55060.030.005	M4X14	200	55060.040.014	M5X22*	500	55060.050.022
M3X6	200	55060.030.006	M4X16	200	55060.040.016	M5X25	200	55060.050.025
M3X8	200	55060.030.008	M4X18	200	55060.040.018	M5X30	200	55060.050.030
M3X10	200	55060.030.010	M4X20	200	55060.040.020	M5X35	200	55060.050.035
M3X12	200	55060.030.012	M4X22*	500	55060.040.022	M5X40	200	55060.050.040
M3X14	200	55060.030.014	M4X25	200	55060.040.025	M5X45	200	55060.050.045
M3X16	200	55060.030.016	M4X30	200	55060.040.030	M5X50	200	55060.050.050
M3X18	200	55060.030.018	M4X35	200	55060.040.035	M5X55*	200	55060.050.055
M3X20	200	55060.030.020	M4X40	200	55060.040.040	M5X60	100	55060.050.060
M3X22*	1000	55060.030.022	M4X45*	200	55060.040.045	M5X65*	100	55060.050.065
M3X25	200	55060.030.025	M4X50	200	55060.040.050	M5X70*	100	55060.050.070
M3X30*	1000	55060.030.030	M4X55*	200	55060.040.055	M5X75*	100	55060.050.075
M3X35*	500	55060.030.035	M4X60*	100	55060.040.060	M5X80*	100	55060.050.080
M3X40*	500	55060.030.040						
M3X45*	500	55060.030.045	M5X6*	500	55060.050.006	M6X8	200	55060.060.008
M3X50*	200	55060.030.050	M5X8	200	55060.050.008	M6X10	200	55060.060.010
			M5X10	200	55060.050.010	M6X12	200	55060.060.012
M4X5*	1000	55060.040.005	M5X12	200	55060.050.012	M6X14	200	55060.060.014
M4X6	200	55060.040.006	M5X14	200	55060.050.014	M6X16	200	55060.060.016
M4X8	200	55060.040.008	M5X16	200	55060.050.016	M6X18	200	55060.060.018
M4X10	200	55060.040.010	M5X18	200	55060.050.018	M6X20	200	55060.060.020

55060 Hexagon socket countersunk head screw ←								
d x L	☒	Art.number	d x L	☒	Art.number	d x L	☒	Art.number
M6X22*	200	55060.060.022	M10X18	100	55060.100.018	M16X25	25	55060.160.025
M6X25	200	55060.060.025	M10X20	100	55060.100.020	M16X30	25	55060.160.030
M6X30	200	55060.060.030	M10X22*	100	55060.100.022	M16X35	25	55060.160.035
M6X35	200	55060.060.035	M10X25	100	55060.100.025	M16X40	25	55060.160.040
M6X40	200	55060.060.040	M10X30	100	55060.100.030	M16X45	25	55060.160.045
M6X45	100	55060.060.045	M10X35	100	55060.100.035	M16X50	25	55060.160.050
M6X50	100	55060.060.050	M10X40	100	55060.100.040	M16X55*	25	55060.160.055
M6X55	100	55060.060.055	M10X45	100	55060.100.045	M16X60	25	55060.160.060
M6X60	100	55060.060.060	M10X50	100	55060.100.050	M16X65*	25	55060.160.065
M6X65*	100	55060.060.065	M10X55	100	55060.100.055	M16X70	25	55060.160.070
M6X70	100	55060.060.070	M10X60	50	55060.100.060	M16X75*	25	55060.160.075
M6X75*	100	55060.060.075	M10X65*	50	55060.100.065	M16X80	25	55060.160.080
M6X80	100	55060.060.080	M10X70	50	55060.100.070	M16X90	25	55060.160.090
M6X90*	100	55060.060.090	M10X75*	50	55060.100.075	M16X100	10	55060.160.100
M6X100*	100	55060.060.100	M10X80	50	55060.100.080	M16X110*	25	55060.160.110
M6X110*	100	55060.060.110	M10X90	50	55060.100.090	M16X120*	25	55060.160.120
M6X120*	100	55060.060.120	M10X100	50	55060.100.100	M16X130*	25	55060.160.130
M6X130*	100	55060.060.130	M10X110*	50	55060.100.110	M16X140*	25	55060.160.140
M6X140*	100	55060.060.140	M10X120	50	55060.100.120	M16X150*	25	55060.160.150
M6X150*	100	55060.060.150	M10X130*	50	55060.100.130			
			M10X140*	50	55060.100.140			
M8X10	200	55060.080.010	M10X150*	50	55060.100.150	M20X30*	25	55060.200.030
M8X12	200	55060.080.012	M10X160*	50	55060.100.160	M20X35*	25	55060.200.035
M8X14*	200	55060.080.014	M10X170*	25	55060.100.170	M20X40	10	55060.200.040
M8X16	200	55060.080.016	M10X180*	25	55060.100.180	M20X45	10	55060.200.045
M8X18	200	55060.080.018	M10X190*	25	55060.100.190	M20X50	10	55060.200.050
M8X20	200	55060.080.020	M10X200*	25	55060.100.200	M20X55	10	55060.200.055
M8X22*	200	55060.080.022				M20X60	10	55060.200.060
M8X25	100	55060.080.025	M12X16*	50	55060.120.016	M20X65*	25	55060.200.065
M8X30	100	55060.080.030	M12X20	50	55060.120.020	M20X70	10	55060.200.070
M8X35	100	55060.080.035	M12X22*	50	55060.120.022	M20X75*	25	55060.200.075
M8X40	100	55060.080.040	M12X25	50	55060.120.025	M20X80*	25	55060.200.080
M8X45	100	55060.080.045	M12X30	50	55060.120.030	M20X90	10	55060.200.090
M8X50	100	55060.080.050	M12X35	50	55060.120.035	M20X100	10	55060.200.100
M8X55	100	55060.080.055	M12X40	50	55060.120.040	M20X110*	25	55060.200.110
M8X60	100	55060.080.060	M12X45	50	55060.120.045	M20X120*	25	55060.200.120
M8X65*	100	55060.080.065	M12X50	50	55060.120.050	M20X130*	25	55060.200.130
M8X70	50	55060.080.070	M12X55	50	55060.120.055	M20X140*	25	55060.200.140
M8X75*	100	55060.080.075	M12X60	50	55060.120.060	M20X150*	25	55060.200.150
M8X80	50	55060.080.080	M12X65*	50	55060.120.065			
M8X90	50	55060.080.090	M12X70	25	55060.120.070	M24X40*	10	55060.240.040
M8X100	50	55060.080.100	M12X75*	25	55060.120.075	M24X45*	10	55060.240.045
M8X110*	50	55060.080.110	M12X80	25	55060.120.080	M24X50*	10	55060.240.050
M8X120*	50	55060.080.120	M12X90	25	55060.120.090	M24X55*	10	55060.240.055
M8X130*	50	55060.080.130	M12X100	25	55060.120.100	M24X60*	10	55060.240.060
M8X140*	50	55060.080.140	M12X110*	25	55060.120.110	M24X65*	10	55060.240.065
M8X150*	50	55060.080.150	M12X120	25	55060.120.120	M24X70*	10	55060.240.070
M8X160*	50	55060.080.160	M12X130*	25	55060.120.130	M24X75*	10	55060.240.075
M8X170*	25	55060.080.170	M12X140*	25	55060.120.140	M24X80*	10	55060.240.080
M8X180*	25	55060.080.180	M12X150*	25	55060.120.150	M24X90*	10	55060.240.090
M8X200*	25	55060.080.200	M12X160*	25	55060.120.160	M24X100*	10	55060.240.100
			M12X170*	25	55060.120.170	M24X110*	10	55060.240.110
M10X12*	100	55060.100.012	M12X180*	25	55060.120.180	M24X120*	10	55060.240.120
M10X14*	100	55060.100.014	M12X190*	25	55060.120.190	M24X130*	10	55060.240.130
M10X16	100	55060.100.016	M12X200	10	55060.120.200	M24X150*	10	55060.240.150

45008 Hexagon socket countersunk head screw W010

Thread	Metric thread	ISO	≈10642
Material	Aluminium P40	DIN	≈7991
		NEN	≈2359
		BS	≈4168-8

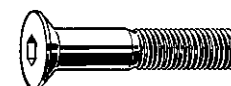

d x L	☒	Art.number	d x L	☒	Art.number	d x L	☒	Art.number
M3X8	200	45008.030.008	M3X16	200	45008.030.016	M4X10	200	45008.040.010
M3X12	200	45008.030.012				M4X16	200	45008.040.016

45208	Hexagon socket countersunk head screw				W010
Thread	Metric thread	ISO	≈10642		
Material	Aluminium P60	DIN	≈7991		
		NEN	≈2359		
		BS	≈4168-8		

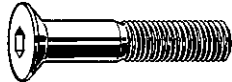

d x L	☒	Art.number	d x L	☒	Art.number	d x L	☒	Art.number
M5X20	200	45208.050.020	M6X10	200	45208.060.010	M8X20	200	45208.080.020
			M6X25	200	45208.060.025			

Hexalobular socket countersunk head screw

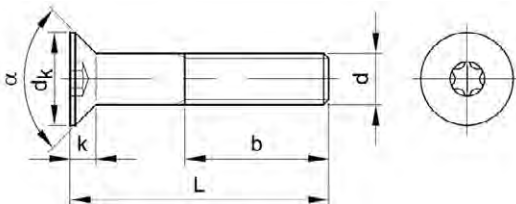

ISO ≈10642
DIN ≈7991
NF ≈E25-107

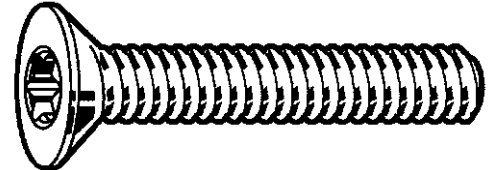

Technical Data

d	b (min.)	dk	k (max.)	P	Socket	α
M4	14	8	2.3	0.7	T20	90°
M5	16	10	2.8	0.8	T25	90°
M6	18	12	3.3	1	T30	90°
M8	22	16	4.4	1.25	T40	90°

- Due to the unfavourable geometry of the head, these fasteners do have reduced loadability.
- When steel fasteners (e.g. 8.8 / 10.9 / 12.9) with reduced loadability needs to be marked, the marking symbol for the property class is preceded by the digit '0'. So 8.8 → 08.8 and 10.9 → 010.9 and 12.9 → 012.9.
- For the stainless steel fasteners it is indicated by only marking the steel grade and by leaving out the property class 70 (e.g. A2-70 → A2).
- The former and the new indications can occur side by side for some time.

Article groups



Thread	Driving features	Material	Class	Surface treatment	Code	Page
M	Hexalobular	St	08.8	Zipl	07450	2-44
M	Hexalobular	St.St. A2			51047	2-44
M	Hexalobular	St.St. A4			55047	2-45

07450	Hexalobular socket countersunk head screw				D02A
Thread	Metric thread	Material	Steel		
Class	08.8	Surface treatment	Zinc plated		

d x L	☒	Art.number	d x L	☒	Art.number	d x L	☒	Art.number
M4X10	200	07450.040.010	M5X30	200	07450.050.030	M6X40	200	07450.060.040
M4X12	200	07450.040.012	M5X35	100	07450.050.035	M8X16	200	07450.080.016
M4X16	200	07450.040.016	M5X40	100	07450.050.040	M8X20	200	07450.080.020
M4X20	200	07450.040.020	M6X10	200	07450.060.010	M8X25	200	07450.080.025
M4X25	200	07450.040.025	M6X12	200	07450.060.012	M8X30	200	07450.080.030
M5X10	200	07450.050.010	M6X16	200	07450.060.016	M8X35	100	07450.080.035
M5X12	200	07450.050.012	M6X20	200	07450.060.020	M8X40	100	07450.080.040
M5X16	200	07450.050.016	M6X25	200	07450.060.025	M8X45	100	07450.080.045
M5X20	200	07450.050.020	M6X30	200	07450.060.030	M8X50	100	07450.080.050
M5X25	200	07450.050.025	M6X35	200	07450.060.035			

51047	Hexalobular socket countersunk head screw				Q05A
Thread	Metric thread	Material	Stainless steel A2		

d x L	☒	Art.number	d x L	☒	Art.number	d x L	☒	Art.number
M4X10*	500	51047.040.010	M5X12	500	51047.050.012	M6X14*	200	51047.060.014
M4X12	500	51047.040.012	M5X16*	500	51047.050.016	M6X16*	200	51047.060.016
M4X16*	500	51047.040.016	M5X20	500	51047.050.020	M6X20*	200	51047.060.020
M4X20*	500	51047.040.020	M5X25*	500	51047.050.025	M6X25*	200	51047.060.025
M5X10*	500	51047.050.010	M6X12	200	51047.060.012	M6X30*	200	51047.060.030

55047 Hexalobular socket countersunk head screw Q45A

Thread Metric thread
Material Stainless steel A4



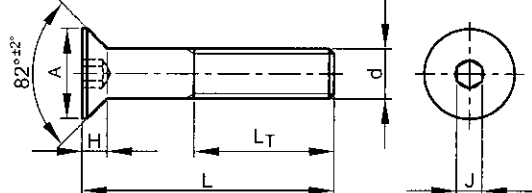

d x L	☒	Art.number	d x L	☒	Art.number	d x L	☒	Art.number
M4X10*	500	55047.040.010	M5X12*	500	55047.050.012	M6X16*	200	55047.060.016
M4X12*	500	55047.040.012	M5X16*	500	55047.050.016	M6X20*	200	55047.060.020
M4X16*	500	55047.040.016	M5X20*	500	55047.050.020	M6X25*	200	55047.060.025
M4X20*	500	55047.040.020	M5X25*	500	55047.050.025	M6X30*	200	55047.060.030
M5X10*	500	55047.050.010	M6X12*	200	55047.060.012			

Hexagon socket countersunk head screw UNC

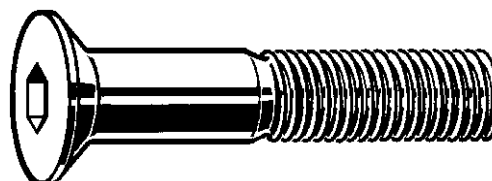

ASME ≈B18.3
 BS ≈2470



Technical Data					
d	A	H	J	L _T (min.)	Threads per inch
No.2	0.197	0.064	0.050	0.62	56
No.3	0.226	0.073	1/16	0.62	48
No.4	0.255	0.083	1/16	0.75	40
No.5	0.281	0.09	5/64	0.75	40
No.6	0.307	0.097	5/64	0.75	32
No.8	0.359	0.112	3/32	0.88	32
No.10	0.411	0.127	1/8	0.88	24
1/4	0.531	0.161	5/32	1	20
5/16	0.656	0.198	3/16	1.12	18
3/8	0.781	0.234	7/32	1.25	16
7/16	0.844	0.234	1/4	1.38	14
1/2	0.938	0.251	5/16	1.5	13
5/8	1.188	0.324	3/8	1.75	11
3/4	1.438	0.396	1/2	2	10
7/8	1.688	0.468	9/16	2.25	9
1 Inch	1.938	0.54	5/8	2.5	8
1.1/4	2.438	0.683	7/8	3.12	7

- Due to the unfavourable geometry of the head, these fasteners do have reduced loadability.
- ATTENTION: as the product standard specifies thread tolerance 3A for thread sizes up to 1 Inch, zinc plating can cause thread fit problems.

Article groups						
Thread	Driving features	Material	Class	Surface treatment	Code	Page
UNC	Hexagon socket	St	Grade 5		U07410	2-46
UNC	Hexagon socket	St	Grade 5	Zipl	U07415	2-47
UNC	Hexagon socket	St.St. A2 (AISI304/18-8)	F837		U51060	2-47

U07410 Hexagon socket countersunk head screw UNC		X05A
Thread Material Class	Unified National Coarse Steel Grade 5	 

d x L	☒	Art.number	d x L	☒	Art.number	d x L	☒	Art.number
NO.2-56X1/8 ft*	100	U07410.008.0012	NO.10-24X5/16 ft*	100	U07410.019.0031	7/16-14X1 Inch ft*	25	U07410.043.0100
NO.2-56X3/16 ft*	100	U07410.008.0018	NO.10-24X3/8 ft*	100	U07410.019.0037	7/16-14X1.1/4 ft*	25	U07410.043.0125
NO.2-56X1/4 ft*	100	U07410.008.0025	NO.10-24X7/16 ft*	100	U07410.019.0043	7/16-14X1.1/2*	25	U07410.043.0150
NO.2-56X5/16 ft*	100	U07410.008.0031	NO.10-24X1/2 ft*	100	U07410.019.0050	7/16-14X1.3/4*	10	U07410.043.0175
NO.2-56X3/8 ft*	100	U07410.008.0037	NO.10-24X5/8 ft*	100	U07410.019.0062	7/16-14X2 Inch*	10	U07410.043.0200
NO.2-56X1/2 ft*	100	U07410.008.0050	NO.10-24X3/4 ft*	100	U07410.019.0075	7/16-14X2.1/4*	10	U07410.043.0225
NO.2-56X5/8 ft*	100	U07410.008.0062	NO.10-24X7/8 ft*	100	U07410.019.0087	7/16-14X2.1/2*	10	U07410.043.0250
NO.2-56X3/4*	100	U07410.008.0075	NO.10-24X1 Inch*	100	U07410.019.0100	7/16-14X3 Inch*	10	U07410.043.0300
NO.2-56X7/8*	100	U07410.008.0087	NO.10-24X1.1/4*	100	U07410.019.0125	7/16-14X3.1/2*	5	U07410.043.0350
NO.2-56X1 Inch*	100	U07410.008.0100	NO.10-24X1.1/2*	100	U07410.019.0150	7/16-14X4 Inch*	5	U07410.043.0400
			NO.10-24X1.3/4*	100	U07410.019.0175			
NO.3-48X3/16 ft*	100	U07410.009.0018	NO.10-24X2 Inch*	100	U07410.019.0200	1/2-13X3/4 ft*	10	U07410.050.0075
NO.3-48X1/4 ft*	100	U07410.009.0025	NO.10-24X2.1/4*	100	U07410.019.0225	1/2-13X7/8 ft*	10	U07410.050.0087
NO.3-48X5/16 ft*	100	U07410.009.0031	NO.10-24X2.1/2*	100	U07410.019.0250	1/2-13X1 Inch ft*	10	U07410.050.0100
NO.3-48X3/8 ft*	100	U07410.009.0037	NO.10-24X3 Inch*	100	U07410.019.0300	1/2-13X1.1/4 ft*	10	U07410.050.0125
NO.3-48X1/2 ft*	100	U07410.009.0050				1/2-13X1.3/8 ft*	10	U07410.050.0137
NO.3-48X5/8 ft*	100	U07410.009.0062	1/4-20X3/8 ft*	100	U07410.025.0037	1/2-13X1.1/2 ft*	10	U07410.050.0150
NO.3-48X3/4*	100	U07410.009.0075	1/4-20X1/2 ft*	100	U07410.025.0050	1/2-13X1.3/4*	10	U07410.050.0175
NO.3-48X1 Inch*	100	U07410.009.0100	1/4-20X5/8 ft*	100	U07410.025.0062	1/2-13X2 Inch*	10	U07410.050.0200
			1/4-20X3/4 ft*	100	U07410.025.0075	1/2-13X2.1/4*	10	U07410.050.0225
NO.4-40X3/16 ft*	100	U07410.011.0018	1/4-20X7/8 ft*	100	U07410.025.0087	1/2-13X2.1/2*	10	U07410.050.0250
NO.4-40X1/4 ft*	100	U07410.011.0025	1/4-20X1 Inch ft*	100	U07410.025.0100	1/2-13X2.3/4*	10	U07410.050.0275
NO.4-40X5/16 ft*	100	U07410.011.0031	1/4-20X1.1/8*	100	U07410.025.0112	1/2-13X3 Inch*	5	U07410.050.0300
NO.4-40X3/8 ft*	100	U07410.011.0037	1/4-20X1.1/4*	100	U07410.025.0125	1/2-13X3.1/4*	5	U07410.050.0325
NO.4-40X7/16 ft*	100	U07410.011.0043	1/4-20X1.1/2*	100	U07410.025.0150	1/2-13X3.1/2*	5	U07410.050.0350
NO.4-40X1/2 ft*	100	U07410.011.0050	1/4-20X1.3/4*	100	U07410.025.0175	1/2-13X4 Inch*	5	U07410.050.0400
NO.4-40X5/8 ft*	100	U07410.011.0062	1/4-20X2 Inch*	50	U07410.025.0200	1/2-13X4.1/2*	5	U07410.050.0450
NO.4-40X3/4 ft*	100	U07410.011.0075	1/4-20X2.1/4*	50	U07410.025.0225	1/2-13X5 Inch*	5	U07410.050.0500
NO.4-40X7/8*	100	U07410.011.0087	1/4-20X2.1/2*	50	U07410.025.0250	1/2-13X5.1/2*	5	U07410.050.0550
NO.4-40X1 Inch*	100	U07410.011.0100	1/4-20X2.3/4*	50	U07410.025.0275	1/2-13X6 Inch*	5	U07410.050.0600
NO.4-40X1.1/4*	100	U07410.011.0125	1/4-20X3 Inch*	25	U07410.025.0300	1/2-13X7 Inch*	5	U07410.050.0700
			1/4-20X3.1/2*	25	U07410.025.0350	1/2-13X8 Inch*	5	U07410.050.0800
			1/4-20X4 Inch*	25	U07410.025.0400			
NO.5-40X1/4 ft*	100	U07410.012.0025				5/8-11X1 Inch ft*	10	U07410.062.0100
NO.5-40X3/8 ft*	100	U07410.012.0037	5/16-18X3/8 ft*	100	U07410.031.0037	5/8-11X1.1/4 ft*	10	U07410.062.0125
NO.5-40X1/2 ft*	100	U07410.012.0050	5/16-18X1/2 ft*	100	U07410.031.0050	5/8-11X1.1/2 ft*	10	U07410.062.0150
NO.5-40X5/8 ft*	100	U07410.012.0062	5/16-18X5/8 ft*	100	U07410.031.0062	5/8-11X1.3/4 ft*	10	U07410.062.0175
NO.5-40X3/4 ft*	100	U07410.012.0075	5/16-18X3/4 ft*	100	U07410.031.0075	5/8-11X2 Inch*	5	U07410.062.0200
NO.5-40X1 Inch*	100	U07410.012.0100	5/16-18X7/8 ft*	100	U07410.031.0087	5/8-11X2.1/4*	5	U07410.062.0225
NO.5-40X1.1/4*	100	U07410.012.0125	5/16-18X1 Inch ft*	50	U07410.031.0100	5/8-11X2.1/2*	5	U07410.062.0250
NO.5-40X1.1/2*	100	U07410.012.0150	5/16-18X1.1/8 ft*	50	U07410.031.0112	5/8-11X2.3/4*	5	U07410.062.0275
			5/16-18X1.1/4*	50	U07410.031.0125	5/8-11X3 Inch*	5	U07410.062.0300
NO.6-32X3/16 ft*	100	U07410.013.0018	5/16-18X1.1/2*	50	U07410.031.0150	5/8-11X3.1/2*	5	U07410.062.0350
NO.6-32X1/4 ft*	100	U07410.013.0025	5/16-18X1.3/4*	50	U07410.031.0175	5/8-11X4 Inch*	5	U07410.062.0400
NO.6-32X5/16 ft*	100	U07410.013.0031	5/16-18X2 Inch*	50	U07410.031.0200	5/8-11X4.1/2*	5	U07410.062.0450
NO.6-32X3/8 ft*	100	U07410.013.0037	5/16-18X2.1/4*	25	U07410.031.0225	5/8-11X5 Inch*	5	U07410.062.0500
NO.6-32X7/16 ft*	100	U07410.013.0043	5/16-18X2.1/2*	25	U07410.031.0250	5/8-11X5.1/2*	5	U07410.062.0550
NO.6-32X1/2 ft*	100	U07410.013.0050	5/16-18X2.3/4*	25	U07410.031.0275	5/8-11X6 Inch*	5	U07410.062.0600
NO.6-32X5/8 ft*	100	U07410.013.0062	5/16-18X3 Inch*	25	U07410.031.0300	5/8-11X6.1/2*	5	U07410.062.0650
NO.6-32X3/4 ft*	100	U07410.013.0075	5/16-18X3.1/2*	25	U07410.031.0350	5/8-11X7 Inch*	5	U07410.062.0700
NO.6-32X7/8*	100	U07410.013.0087	5/16-18X4 Inch*	10	U07410.031.0400	5/8-11X8 Inch*	5	U07410.062.0800
NO.6-32X1 Inch*	100	U07410.013.0100						
NO.6-32X1.1/4*	100	U07410.013.0125	3/8-16X1/2 ft*	50	U07410.037.0050	3/4-10X1 Inch ft*	5	U07410.075.0100
NO.6-32X1.1/2*	100	U07410.013.0150	3/8-16X5/8 ft*	50	U07410.037.0062	3/4-10X1.1/4 ft*	5	U07410.075.0125
NO.6-32X1.3/4*	100	U07410.013.0175	3/8-16X3/4 ft*	50	U07410.037.0075	3/4-10X1.1/2 ft*	5	U07410.075.0150
NO.6-32X2 Inch*	100	U07410.013.0200	3/8-16X7/8 ft*	50	U07410.037.0087	3/4-10X1.3/4 ft*	5	U07410.075.0175
NO.6-32X2.1/4*	100	U07410.013.0225	3/8-16X1 Inch ft*	50	U07410.037.0100	3/4-10X2 Inch ft*	5	U07410.075.0200
NO.6-32X2.1/2*	100	U07410.013.0250	3/8-16X1.1/4 ft*	50	U07410.037.0125	3/4-10X2.1/4*	5	U07410.075.0225
			3/8-16X1.3/8*	50	U07410.037.0137	3/4-10X2.1/2*	5	U07410.075.0250
NO.8-32X1/4 ft*	100	U07410.016.0025	3/8-16X1.1/2*	25	U07410.037.0150	3/4-10X2.3/4*	5	U07410.075.0275
NO.8-32X5/16 ft*	100	U07410.016.0031	3/8-16X1.3/4*	25	U07410.037.0175	3/4-10X3 Inch*	5	U07410.075.0300
NO.8-32X3/8 ft*	100	U07410.016.0037	3/8-16X2 Inch*	25	U07410.037.0200	3/4-10X3.1/4*	5	U07410.075.0325
NO.8-32X7/16 ft*	100	U07410.016.0043	3/8-16X2.1/4*	25	U07410.037.0225	3/4-10X3.1/2*	5	U07410.075.0350
NO.8-32X1/2 ft*	100	U07410.016.0050	3/8-16X2.1/2*	25	U07410.037.0250	3/4-10X4 Inch*	5	U07410.075.0400
NO.8-32X5/8 ft*	100	U07410.016.0062	3/8-16X2.3/4*	25	U07410.037.0275	3/4-10X4.1/2*	5	U07410.075.0450
NO.8-32X3/4 ft*	100	U07410.016.0075	3/8-16X3 Inch*	10	U07410.037.0300	3/4-10X5 Inch*	5	U07410.075.0500
NO.8-32X7/8 ft*	100	U07410.016.0087	3/8-16X3.1/2*	10	U07410.037.0350	3/4-10X6 Inch*	5	U07410.075.0600
NO.8-32X1 Inch*	100	U07410.016.0100	3/8-16X4 Inch*	10	U07410.037.0400	3/4-10X6.1/2*	1	U07410.075.0650
NO.8-32X1.1/4*	100	U07410.016.0125	3/8-16X4.1/2*	10	U07410.037.0450	3/4-10X7 Inch*	1	U07410.075.0700
NO.8-32X1.1/2*	100	U07410.016.0150	3/8-16X5 Inch*	10	U07410.037.0500	3/4-10X8 Inch*	1	U07410.075.0800
NO.8-32X1.3/4*	100	U07410.016.0175	3/8-16X5.1/2*	10	U07410.037.0550			
NO.8-32X2 Inch*	100	U07410.016.0200	3/8-16X6 Inch*	10	U07410.037.0600	7/8-9X2 Inch ft*	5	U07410.087.0200
NO.8-32X2.1/4*	100	U07410.016.0225				7/8-9X2.1/2*	5	U07410.087.0250
NO.8-32X2.1/2*	100	U07410.016.0250	7/16-14X3/4 ft*	25	U07410.043.0075	7/8-9X3 Inch*	5	U07410.087.0300
			7/16-14X7/8 ft*	25	U07410.043.0087	7/8-9X3.1/2*	5	U07410.087.0350

U07410 Hexagon socket countersunk head screw UNC								
d x L	☒	Art.number	d x L	☒	Art.number	d x L	☒	Art.number
7/8-9X4 Inch*	5	U07410.087.0400	1.-8X2.1/2 ft*	5	U07410.100.0250	1.-8X8 Inch*	1	U07410.100.0800
7/8-9X4.1/2*	5	U07410.087.0450	1.-8X2.3/4*	5	U07410.100.0275			
7/8-9X5 Inch*	5	U07410.087.0500	1.-8X3 Inch*	5	U07410.100.0300	1.1/4-7X3 Inch ft*	1	U07410.125.0300
7/8-9X6 Inch*	1	U07410.087.0600	1.-8X3.1/2*	5	U07410.100.0350	1.1/4-7X3.1/2*	1	U07410.125.0350
7/8-9X6.1/2*	1	U07410.087.0650	1.-8X4 Inch*	5	U07410.100.0400	1.1/4-7X4 Inch*	1	U07410.125.0400
7/8-9X7 Inch*	1	U07410.087.0700	1.-8X4.1/2*	5	U07410.100.0450	1.1/4-7X5 Inch*	1	U07410.125.0500
7/8-9X8 Inch*	1	U07410.087.0800	1.-8X5 Inch*	5	U07410.100.0500	1.1/4-7X6 Inch*	1	U07410.125.0600
			1.-8X6 Inch*	1	U07410.100.0600	1.1/4-7X7 Inch*	1	U07410.125.0700
1.-8X2 Inch ft*	5	U07410.100.0200	1.-8X6.1/2*	1	U07410.100.0650	1.1/4-7X8 Inch*	1	U07410.125.0800
1.-8X2.1/4 ft*	5	U07410.100.0225	1.-8X7 Inch*	1	U07410.100.0700			

* ft = fully threaded

U07415 Hexagon socket countersunk head screw UNC		X05A
Thread	Unified National Coarse	
Material	Steel	
Class	Grade 5	
Surface treatment	Zinc plated	

d x L	☒	Art.number	d x L	☒	Art.number	d x L	☒	Art.number
NO.4-40X1/4 ft*	100	U07415.011.0025	NO.10-24X5/8 ft*	100	U07415.019.0062	5/16-18X1.1/2*	50	U07415.031.0150
NO.4-40X3/8 ft*	100	U07415.011.0037	NO.10-24X3/4 ft*	100	U07415.019.0075	5/16-18X1.3/4*	50	U07415.031.0175
NO.4-40X1/2 ft*	100	U07415.011.0050	NO.10-24X1 Inch*	100	U07415.019.0100	5/16-18X2 Inch*	50	U07415.031.0200
NO.4-40X5/8 ft*	100	U07415.011.0062	NO.10-24X1.1/4*	100	U07415.019.0125	5/16-18X2.1/2*	25	U07415.031.0250
NO.4-40X3/4 ft*	100	U07415.011.0075	NO.10-24X1.1/2*	100	U07415.019.0150			
NO.4-40X1 Inch*	100	U07415.011.0100				3/8-16X1/2 ft*	50	U07415.037.0050
			1/4-20X3/8 ft*	100	U07415.025.0037	3/8-16X3/4 ft*	50	U07415.037.0075
NO.6-32X1/4 ft*	100	U07415.013.0025	1/4-20X1/2 ft*	100	U07415.025.0050	3/8-16X1 Inch ft*	50	U07415.037.0100
NO.6-32X3/8 ft*	100	U07415.013.0037	1/4-20X5/8 ft*	100	U07415.025.0062	3/8-16X1.1/4 ft*	50	U07415.037.0125
NO.6-32X1/2 ft*	100	U07415.013.0050	1/4-20X3/4 ft*	100	U07415.025.0075	3/8-16X1.1/2*	25	U07415.037.0150
NO.6-32X5/8 ft*	100	U07415.013.0062	1/4-20X1 Inch ft*	100	U07415.025.0100	3/8-16X1.3/4*	25	U07415.037.0175
NO.6-32X3/4 ft*	100	U07415.013.0075	1/4-20X1.1/4*	100	U07415.025.0125	3/8-16X2 Inch*	25	U07415.037.0200
			1/4-20X1.1/2*	100	U07415.025.0150			
NO.8-32X3/8 ft*	100	U07415.016.0037	1/4-20X1.3/4*	100	U07415.025.0175	1/2-13X3/4 ft*	10	U07415.050.0075
NO.8-32X1/2 ft*	100	U07415.016.0050	1/4-20X2 Inch*	50	U07415.025.0200	1/2-13X1 Inch ft*	10	U07415.050.0100
NO.8-32X5/8 ft*	100	U07415.016.0062				1/2-13X1.1/4 ft*	10	U07415.050.0125
NO.8-32X3/4 ft*	100	U07415.016.0075	5/16-18X1/2 ft*	100	U07415.031.0050	1/2-13X1.1/2 ft*	10	U07415.050.0150
NO.8-32X1 Inch*	100	U07415.016.0100	5/16-18X5/8 ft*	100	U07415.031.0062	1/2-13X1.3/4*	10	U07415.050.0175
			5/16-18X3/4 ft*	100	U07415.031.0075	1/2-13X2 Inch*	10	U07415.050.0200
NO.10-24X3/8 ft*	100	U07415.019.0037	5/16-18X1 Inch ft*	50	U07415.031.0100	1/2-13X2.1/2*	10	U07415.050.0250
NO.10-24X1/2 ft*	100	U07415.019.0050	5/16-18X1.1/4*	50	U07415.031.0125	1/2-13X3 Inch*	5	U07415.050.0300

* ft = fully threaded

U51060 Hexagon socket countersunk head screw UNC		X15A
Thread	Unified National Coarse	
Material	Stainless steel A2 (AISI 304/18-8)	
Class	F837	

d x L	☒	Art.number	d x L	☒	Art.number	d x L	☒	Art.number
NO.2-56X1/8 ft*	100	U51060.008.0012	NO.4-40X1/2 ft*	100	U51060.011.0050	NO.8-32X1/4 ft*	100	U51060.016.0025
NO.2-56X3/16 ft*	100	U51060.008.0018	NO.4-40X5/8 ft*	100	U51060.011.0062	NO.8-32X5/16 ft*	100	U51060.016.0031
NO.2-56X1/4 ft*	100	U51060.008.0025	NO.4-40X3/4 ft*	100	U51060.011.0075	NO.8-32X3/8 ft*	100	U51060.016.0037
NO.2-56X5/16 ft*	100	U51060.008.0031	NO.4-40X1 Inch*	100	U51060.011.0100	NO.8-32X7/16 ft*	100	U51060.016.0043
NO.2-56X3/8 ft*	100	U51060.008.0037				NO.8-32X1/2 ft*	100	U51060.016.0050
NO.2-56X1/2 ft*	100	U51060.008.0050	NO.5-40X1/4 ft*	100	U51060.012.0025	NO.8-32X1/2 ft*	100	U51060.016.0050
NO.2-56X5/8 ft*	100	U51060.008.0062	NO.5-40X5/16 ft*	100	U51060.012.0031	NO.8-32X5/8 ft*	100	U51060.016.0062
NO.2-56X3/4 ft*	100	U51060.008.0075	NO.5-40X3/8 ft*	100	U51060.012.0037	NO.8-32X3/4 ft*	100	U51060.016.0075
NO.2-56X7/8 ft*	100	U51060.008.0087	NO.5-40X1/2 ft*	100	U51060.012.0050	NO.8-32X7/8 ft*	100	U51060.016.0087
NO.2-56X1 Inch*	100	U51060.008.0100	NO.5-40X5/8 ft*	100	U51060.012.0062	NO.8-32X1 Inch*	100	U51060.016.0100
			NO.5-40X3/4 ft*	100	U51060.012.0075	NO.8-32X1.1/4*	100	U51060.016.0125
NO.3-48X3/16 ft*	100	U51060.009.0018	NO.5-40X1 Inch*	100	U51060.012.0100	NO.8-32X1.1/2*	100	U51060.016.0150
NO.3-48X1/4 ft*	100	U51060.009.0025				NO.8-32X1.3/4*	100	U51060.016.0175
NO.3-48X5/16 ft*	100	U51060.009.0031	NO.6-32X1/4 ft*	100	U51060.013.0025			
NO.3-48X3/8 ft*	100	U51060.009.0037	NO.6-32X5/16 ft*	100	U51060.013.0031	NO.10-24X5/16 ft*	100	U51060.019.0031
NO.3-48X1/2 ft*	100	U51060.009.0050	NO.6-32X3/8 ft*	100	U51060.013.0037	NO.10-24X3/8 ft*	100	U51060.019.0037
NO.3-48X5/8 ft*	100	U51060.009.0062	NO.6-32X7/16 ft*	100	U51060.013.0043	NO.10-24X7/16 ft*	100	U51060.019.0043
NO.3-48X3/4 ft*	100	U51060.009.0075	NO.6-32X1/2 ft*	100	U51060.013.0050	NO.10-24X1/2 ft*	100	U51060.019.0050
NO.3-48X1 Inch*	100	U51060.009.0100	NO.6-32X5/8 ft*	100	U51060.013.0062	NO.10-24X5/8 ft*	100	U51060.019.0062
			NO.6-32X3/4 ft*	100	U51060.013.0075	NO.10-24X3/4 ft*	100	U51060.019.0075
NO.4-40X3/16 ft*	100	U51060.011.0018	NO.6-32X7/8 ft*	100	U51060.013.0087	NO.10-24X7/8 ft*	100	U51060.019.0087
NO.4-40X1/4 ft*	100	U51060.011.0025	NO.6-32X1 Inch*	100	U51060.013.0100	NO.10-24X1 Inch*	100	U51060.019.0100
NO.4-40X5/16 ft*	100	U51060.011.0031	NO.6-32X1.1/4*	100	U51060.013.0125	NO.10-24X1.1/4*	100	U51060.019.0125
NO.4-40X3/8 ft*	100	U51060.011.0037	NO.6-32X1.1/2*	100	U51060.013.0150	NO.10-24X1.1/2*	100	U51060.019.0150
NO.4-40X7/16 ft*	100	U51060.011.0043						

U51060 Hexagon socket countersunk head screw UNC

d x L	☒	Art.number	d x L	☒	Art.number	d x L	☒	Art.number
NO.10-24X1.3/4*	100	U51060.019.0175	5/16-18X2.1/4*	25	U51060.031.0225	1/2-13X2.1/2*	10	U51060.050.0250
NO.10-24X2 Inch*	100	U51060.019.0200	5/16-18X2.1/2*	25	U51060.031.0250	1/2-13X3 Inch*	5	U51060.050.0300
			5/16-18X3 Inch*	25	U51060.031.0300	1/2-13X3.1/2*	5	U51060.050.0350
1/4-20X3/8 ft*	100	U51060.025.0037				1/2-13X4 Inch*	5	U51060.050.0400
1/4-20X1/2 ft*	100	U51060.025.0050	3/8-16X1/2 ft*	50	U51060.037.0050			
1/4-20X5/8 ft*	100	U51060.025.0062	3/8-16X5/8 ft*	50	U51060.037.0062	5/8-11X1 Inch ft*	10	U51060.062.0100
1/4-20X3/4 ft*	100	U51060.025.0075	3/8-16X3/4 ft*	50	U51060.037.0075	5/8-11X1.1/4 ft*	10	U51060.062.0125
1/4-20X7/8 ft*	100	U51060.025.0087	3/8-16X7/8 ft*	50	U51060.037.0087	5/8-11X1.1/2 ft*	10	U51060.062.0150
1/4-20X1 Inch ft*	100	U51060.025.0100	3/8-16X1 Inch ft*	50	U51060.037.0100	5/8-11X1.3/4 ft*	10	U51060.062.0175
1/4-20X1.1/4*	100	U51060.025.0125	3/8-16X1.1/4 ft*	50	U51060.037.0125	5/8-11X2 Inch*	5	U51060.062.0200
1/4-20X1.1/2*	100	U51060.025.0150	3/8-16X1.1/2*	25	U51060.037.0150	5/8-11X2.1/4*	5	U51060.062.0225
1/4-20X1.3/4*	100	U51060.025.0175	3/8-16X1.3/4*	25	U51060.037.0175	5/8-11X2.1/2*	5	U51060.062.0250
1/4-20X2 Inch*	50	U51060.025.0200	3/8-16X2 Inch*	25	U51060.037.0200	5/8-11X3 Inch*	5	U51060.062.0300
1/4-20X2.1/2*	50	U51060.025.0250	3/8-16X2.1/4*	25	U51060.037.0225	5/8-11X3.1/2*	5	U51060.062.0350
			3/8-16X2.1/2*	25	U51060.037.0250	5/8-11X4 Inch*	5	U51060.062.0400
			3/8-16X3 Inch*	10	U51060.037.0300			
5/16-18X3/8 ft*	100	U51060.031.0037				3/4-10X1.1/4 ft*	5	U51060.075.0125
5/16-18X1/2 ft*	100	U51060.031.0050	1/2-13X3/4 ft*	10	U51060.050.0075	3/4-10X1.1/2 ft*	5	U51060.075.0150
5/16-18X5/8 ft*	100	U51060.031.0062	1/2-13X7/8 ft*	10	U51060.050.0087	3/4-10X1.3/4 ft*	5	U51060.075.0175
5/16-18X3/4 ft*	100	U51060.031.0075	1/2-13X1 Inch ft*	10	U51060.050.0100	3/4-10X2 Inch ft*	5	U51060.075.0200
5/16-18X7/8 ft*	100	U51060.031.0087	1/2-13X1.1/4 ft*	10	U51060.050.0125	3/4-10X2.1/2*	5	U51060.075.0250
5/16-18X1 Inch ft*	50	U51060.031.0100	1/2-13X1.1/2 ft*	10	U51060.050.0150	3/4-10X3 Inch*	5	U51060.075.0300
5/16-18X1.1/4*	50	U51060.031.0125	1/2-13X1.3/4*	10	U51060.050.0175	3/4-10X3.1/2*	5	U51060.075.0350
5/16-18X1.1/2*	50	U51060.031.0150	1/2-13X2 Inch*	10	U51060.050.0200	3/4-10X4 Inch*	5	U51060.075.0400
5/16-18X1.3/4*	50	U51060.031.0175	1/2-13X2.1/4*	10	U51060.050.0225			
5/16-18X2 Inch*	50	U51060.031.0200						

* ft = fully threaded

Hexagon socket countersunk head screw UNF

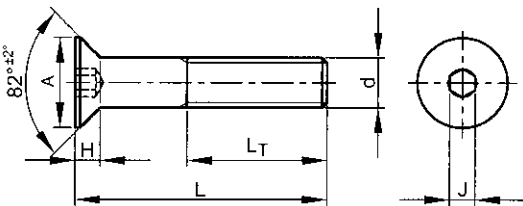

ASME ≈B18.3
BS ≈2470

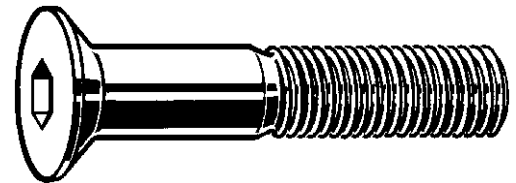

Technical Data

d	A	H	J	L _T (min.)	Threads per inch
No.0	0.138	0.044	0.035	0.5	80
No.1	0.168	0.054	0.050	0.62	72
No.4	0.255	0.083	1/16	0.75	48
No.6	0.307	0.097	5/64	0.75	40
No.8	0.359	0.112	3/32	0.88	36
No.10	0.411	0.127	1/8	0.88	32
1/4	0.531	0.161	5/32	1	28
5/16	0.656	0.198	3/16	1.12	24
3/8	0.781	0.234	7/32	1.25	24
7/16	0.844	0.234	1/4	1.38	20
1/2	0.938	0.251	5/16	1.5	20
5/8	1.188	0.324	3/8	1.75	18
3/4	1.438	0.396	1/2	2	16

- Due to the unfavourable geometry of the head, these fasteners do have reduced load ability.
- ATTENTION: as the product standard specifies thread tolerance 3A for thread sizes up to 1 Inch, zinc plating can cause thread fit problems.

Article groups

Thread	Driving features	Material	Class	Surface treatment	Code	Page
UNF	Hexagon socket	St	Grade 5		U07566	2-49
UNF	Hexagon socket	St	Grade 5	Mech.zipl.	07560	2-49
UNF	Hexagon socket	St.St. A2 (AISI304/18-8)	F837		U51566	2-50

U07566 Hexagon socket countersunk head screw UNF		X05A
Thread	Unified National Fine	
Material	Steel	
Class	Grade 5	
		

d x L	☒	Art.number	d x L	☒	Art.number	d x L	☒	Art.number
NO.0-80X1/8 ft*	100	U07566.006.0012	NO.10-32X1.1/8*	100	U07566.019.0112	3/8-24X2.1/2*	25	U07566.037.0250
NO.0-80X3/16 ft*	100	U07566.006.0018	NO.10-32X1.1/4*	100	U07566.019.0125	3/8-24X2.3/4*	25	U07566.037.0275
NO.0-80X1/4 ft*	100	U07566.006.0025	NO.10-32X1.1/2*	100	U07566.019.0150	3/8-24X3 Inch*	10	U07566.037.0300
NO.0-80X5/16 ft*	100	U07566.006.0031	NO.10-32X1.3/4*	100	U07566.019.0175	3/8-24X3.1/4*	10	U07566.037.0325
NO.0-80X3/8 ft*	100	U07566.006.0037	NO.10-32X2 Inch*	100	U07566.019.0200	3/8-24X3.1/2*	10	U07566.037.0350
NO.0-80X1/2 ft*	100	U07566.006.0050	NO.10-32X2.1/4*	100	U07566.019.0225			
NO.0-80X5/8*	100	U07566.006.0062	NO.10-32X2.1/2*	100	U07566.019.0250	7/16-20X3/4 ft*	25	U07566.043.0075
NO.0-80X3/4*	100	U07566.006.0075	NO.10-32X3 Inch*	100	U07566.019.0300	7/16-20X1 Inch ft*	25	U07566.043.0100
NO.0-80X1 Inch*	100	U07566.006.0100				7/16-20X1.1/4 ft*	25	U07566.043.0125
			1/4-28X3/8 ft*	100	U07566.025.0037	7/16-20X1.1/2*	25	U07566.043.0150
			1/4-28X1/2 ft*	100	U07566.025.0050	7/16-20X1.3/4*	10	U07566.043.0175
			1/4-28X5/8 ft*	100	U07566.025.0062	7/16-20X2 Inch*	10	U07566.043.0200
			1/4-28X3/4 ft*	100	U07566.025.0075	7/16-20X2.1/2*	10	U07566.043.0250
			1/4-28X7/8 ft*	100	U07566.025.0087	7/16-20X3 Inch*	10	U07566.043.0300
			1/4-28X1 Inch ft*	100	U07566.025.0100			
			1/4-28X1.1/4*	100	U07566.025.0125	1/2-20X3/4 ft*	10	U07566.050.0075
			1/4-28X1.1/2*	100	U07566.025.0150	1/2-20X1 Inch ft*	10	U07566.050.0100
			1/4-28X1.3/4*	100	U07566.025.0175	1/2-20X1.1/4 ft*	10	U07566.050.0125
			1/4-28X2 Inch*	50	U07566.025.0200	1/2-20X1.1/2 ft*	10	U07566.050.0150
			1/4-28X2.1/4*	50	U07566.025.0225	1/2-20X1.3/4*	10	U07566.050.0175
			1/4-28X2.1/2*	50	U07566.025.0250	1/2-20X2 Inch*	10	U07566.050.0200
			1/4-28X3 Inch*	25	U07566.025.0300	1/2-20X2.1/4*	10	U07566.050.0225
			1/4-28X3.1/2*	25	U07566.025.0350	1/2-20X2.1/2*	10	U07566.050.0250
						1/2-20X3 Inch*	5	U07566.050.0300
			5/16-24X3/8 ft*	100	U07566.031.0037	1/2-20X3.1/2*	5	U07566.050.0350
			5/16-24X1/2 ft*	100	U07566.031.0050	1/2-20X4 Inch*	5	U07566.050.0400
			5/16-24X5/8 ft*	100	U07566.031.0062			
			5/16-24X3/4 ft*	100	U07566.031.0075	5/8-18X1 Inch ft*	10	U07566.062.0100
			5/16-24X7/8 ft*	100	U07566.031.0087	5/8-18X1.1/4 ft*	10	U07566.062.0125
			5/16-24X1 Inch ft*	50	U07566.031.0100	5/8-18X1.1/2 ft*	10	U07566.062.0150
			5/16-24X1.1/4*	50	U07566.031.0125	5/8-18X1.3/4 ft*	10	U07566.062.0175
			5/16-24X1.1/2*	50	U07566.031.0150	5/8-18X2 Inch*	5	U07566.062.0200
			5/16-24X1.3/4*	50	U07566.031.0175	5/8-18X2.1/4*	5	U07566.062.0225
			5/16-24X2 Inch*	50	U07566.031.0200	5/8-18X2.1/2*	5	U07566.062.0250
			5/16-24X2.1/4*	25	U07566.031.0225	5/8-18X3 Inch*	5	U07566.062.0300
			5/16-24X2.1/2*	25	U07566.031.0250	5/8-18X3.1/2*	5	U07566.062.0350
			5/16-24X3 Inch*	25	U07566.031.0300	5/8-18X4 Inch*	5	U07566.062.0400
			5/16-24X3.1/2*	25	U07566.031.0350			
						3/4-16X1.1/4 ft*	5	U07566.075.0125
			3/8-24X1/2 ft*	50	U07566.037.0050	3/4-16X1.1/2 ft*	5	U07566.075.0150
			3/8-24X5/8 ft*	50	U07566.037.0062	3/4-16X1.3/4 ft*	5	U07566.075.0175
			3/8-24X3/4 ft*	50	U07566.037.0075	3/4-16X2 Inch ft*	5	U07566.075.0200
			3/8-24X7/8 ft*	50	U07566.037.0087	3/4-16X2.1/4*	5	U07566.075.0225
			3/8-24X1 Inch ft*	50	U07566.037.0100	3/4-16X2.1/2*	5	U07566.075.0250
			3/8-24X1.1/4 ft*	50	U07566.037.0125	3/4-16X3 Inch*	5	U07566.075.0300
			3/8-24X1.1/2*	25	U07566.037.0150	3/4-16X3.1/2*	5	U07566.075.0350
			3/8-24X1.3/4*	25	U07566.037.0175	3/4-16X4 Inch*	5	U07566.075.0400
			3/8-24X2 Inch*	25	U07566.037.0200			
			3/8-24X2.1/4*	25	U07566.037.0225			

* ft = fully threaded

07560 Hexagon socket countersunk head screw UNF		X05A
Thread	Unified National Fine	
Material	Steel	
Class	Grade 5	
Surface treatment	Mechanical zinc plated	
		

d x L	☒	Art.number	d x L	☒	Art.number	d x L	☒	Art.number
1/4X3/4	100	07560.063.019	3/8X1 Inch	100	07560.096.025	5/8X2 Inch	25	07560.158.050
5/16X1 Inch	100	07560.079.025	1/2X1.1/4	50	07560.127.031			

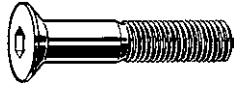
U51566	Hexagon socket countersunk head screw UNF		X15A
Thread	Unified National Fine		
Material	Stainless steel A2 (AISI 304/18-8)		
Class	F837		
			

d x L	☒	Art.number	d x L	☒	Art.number	d x L	☒	Art.number
NO.0-80X1/8 ft*	100	U51566.006.0012	NO.6-40X1 Inch*	100	U51566.013.0100	NO.10-32X2.1/4*	100	U51566.019.0225
NO.0-80X3/16 ft*	100	U51566.006.0018	NO.10-32X5/16 ft*	100	U51566.019.0031	1/4-28X3/8 ft*	100	U51566.025.0037
NO.0-80X1/4 ft*	100	U51566.006.0025	NO.10-32X3/8 ft*	100	U51566.019.0037	1/4-28X1/2 ft*	100	U51566.025.0050
NO.0-80X5/16 ft*	100	U51566.006.0031	NO.10-32X7/16 ft*	100	U51566.019.0043	1/4-28X5/8 ft*	100	U51566.025.0062
NO.0-80X3/8 ft*	100	U51566.006.0037	NO.10-32X1/2 ft*	100	U51566.019.0050	1/4-28X3/4 ft*	100	U51566.025.0075
NO.0-80X1/2 ft*	100	U51566.006.0050	NO.10-32X5/8 ft*	100	U51566.019.0062	1/4-28X7/8 ft*	100	U51566.025.0087
NO.1-72X1/8 ft*	100	U51566.007.0012	NO.10-32X3/4 ft*	100	U51566.019.0075	1/4-28X1 Inch ft*	100	U51566.025.0100
NO.1-72X3/16 ft*	100	U51566.007.0018	NO.10-32X7/8 ft*	100	U51566.019.0087	1/4-28X1.1/4*	100	U51566.025.0125
NO.1-72X1/4 ft*	100	U51566.007.0025	NO.10-32X1 Inch*	100	U51566.019.0100	1/4-28X1.1/2*	100	U51566.025.0150
NO.1-72X5/16 ft*	100	U51566.007.0031	NO.10-32X1.1/4*	100	U51566.019.0125	1/4-28X1.3/4*	100	U51566.025.0175
NO.1-72X3/8 ft*	100	U51566.007.0037	NO.10-32X1.1/2*	100	U51566.019.0150	1/4-28X2 Inch*	50	U51566.025.0200
NO.1-72X1/2 ft*	100	U51566.007.0050	NO.10-32X1.3/4*	100	U51566.019.0175			
NO.10-32X2 Inch*	100	U51566.019.0200	NO.10-32X2 Inch*	100	U51566.019.0200	5/16-24X3/8 ft*	100	U51566.031.0037

* ft = fully threaded

Hexagon socket countersunk head screw BSW

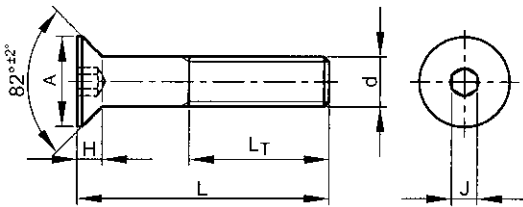

BS ≈2470

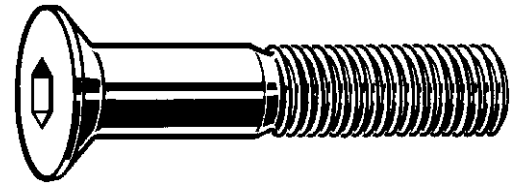

Technical Data

d	A	H	J	L _T (min.)	Threads per inch
1/2	23.8	6.4	5/16	38	12

- Whitworth thread (BSW/BSF) is not internationally recommended. It is advised to use metric (M/MF) or unified threads (UNC/UNF).
- Depending on availability also class 012.9 can be supplied.
- Due to the unfavourable geometry of the head, these fasteners do have reduced load ability.
- Depending on availability the dimensions may deviate.

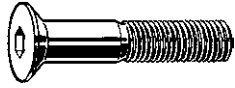
07600	Hexagon socket countersunk head screw BSW		X08A
Thread	British Standard Whitworth		
Material	Steel		
Class	010.9		
			

d x L	☒	Art.number	d x L	☒	Art.number	d x L	☒	Art.number
1/2X25MM	50	07600.127.025	1/2X30MM	50	07600.127.031	1/2X38MM	50	07600.127.038

• Warning: electro-galvanizing of these products may cause hydrogen embrittlement.

Hexagon socket button head screw

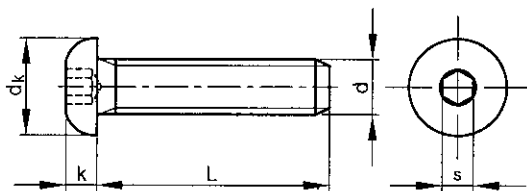

ISO 7380-1
ASME ≈B18.3.4M
NF ≈E25-126
BS ≈4168-6

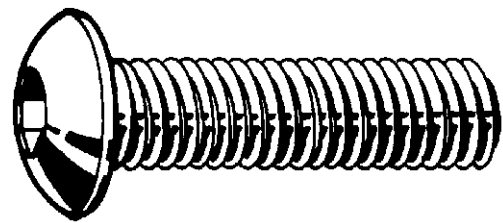

2

Technical Data

d	d _k (max.)	Full thread L ≤	k (max.)	P	s
M3	5.7	12	1.65	0.5	2
M4	7.6	16	2.2	0.7	2.5
M5	9.5	30	2.75	0.8	3
M6	10.5	30	3.3	1	4
M8	14	40	4.4	1.25	5
M10	17.5	40	5.5	1.5	6
M12	21	50	6.6	1.75	8
M16	28	45	8.8	2	10

- Due to the unfavourable geometry of the head, these fasteners do have reduced loadability.
- When steel fasteners (e.g. 8.8 / 10.9 / 12.9) with reduced loadability needs to be marked, the marking symbol for the property class is preceded by the digit '0'. So 8.8 → 08.8 and 10.9 → 010.9 and 12.9 → 012.9.
- For the stainless steel fasteners it is indicated by only marking the steel grade and by leaving out the property class 70 (e.g. A2-70 → A2).
- The former and the new indications can occur side by side for some time.

Article groups

Thread	Driving features	Material	Class	Surface treatment	Code	Page
M	Hexagon socket	St	010.9		07150	2-51
M	Hexagon socket	St	010.9	Zipl	07151	2-52
M	Hexagon socket	St.St. A2	70		51030	2-52
M	Hexagon socket	St.St. A4	70		55030	2-53

07150 Hexagon socket button head screw

D04A

Thread Metric thread
Material Steel
Class 010.9

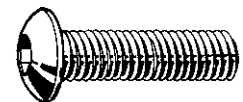

d x L	Art.number	d x L	Art.number	d x L	Art.number
M3X6	200 07150.030.006	M5X60	200 07150.050.060	M8X55	200 07150.080.055
M3X8	200 07150.030.008	M5X70	200 07150.050.070	M8X60	200 07150.080.060
M3X10	200 07150.030.010			M8X70	200 07150.080.070
M3X12	200 07150.030.012	M6X6	200 07150.060.006	M8X80	200 07150.080.080
M3X16	200 07150.030.016	M6X8	200 07150.060.008	M8X90	100 07150.080.090
M3X20	200 07150.030.020	M6X10	200 07150.060.010	M8X100	100 07150.080.100
M3X25	200 07150.030.025	M6X12	200 07150.060.012		
M3X30	200 07150.030.030	M6X14	200 07150.060.014	M10X12	200 07150.100.012
		M6X16	200 07150.060.016	M10X16	200 07150.100.016
M4X6	200 07150.040.006	M6X20	200 07150.060.020	M10X20	200 07150.100.020
M4X8	200 07150.040.008	M6X25	200 07150.060.025	M10X25	200 07150.100.025
M4X10	200 07150.040.010	M6X30	200 07150.060.030	M10X30	200 07150.100.030
M4X12	200 07150.040.012	M6X35	200 07150.060.035	M10X35	100 07150.100.035
M4X16	200 07150.040.016	M6X40	200 07150.060.040	M10X40	100 07150.100.040
M4X20	200 07150.040.020	M6X45	200 07150.060.045	M10X45	100 07150.100.045
M4X25	200 07150.040.025	M6X50	200 07150.060.050	M10X50	100 07150.100.050
M4X30	200 07150.040.030	M6X55	200 07150.060.055	M10X55	100 07150.100.055
M4X35	200 07150.040.035	M6X60	200 07150.060.060	M10X60	100 07150.100.060
M4X40	200 07150.040.040	M6X70	200 07150.060.070	M10X70	100 07150.100.070
M4X50	200 07150.040.050			M10X80	100 07150.100.080
		M8X8	200 07150.080.008	M10X90	100 07150.100.090
M5X6	200 07150.050.006	M8X10	200 07150.080.010	M10X100	100 07150.100.100
M5X8	200 07150.050.008	M8X12	200 07150.080.012		
M5X10	200 07150.050.010	M8X14	200 07150.080.014	M12X20	100 07150.120.020
M5X12	200 07150.050.012	M8X16	200 07150.080.016	M12X25	100 07150.120.025
M5X16	200 07150.050.016	M8X18	200 07150.080.018	M12X30	100 07150.120.030
M5X20	200 07150.050.020	M8X20	200 07150.080.020	M12X35	100 07150.120.035
M5X25	200 07150.050.025	M8X25	200 07150.080.025	M12X40	100 07150.120.040
M5X30	200 07150.050.030	M8X30	200 07150.080.030	M12X45	100 07150.120.045
M5X35	200 07150.050.035	M8X35	200 07150.080.035	M12X50	100 07150.120.050
M5X40	200 07150.050.040	M8X40	200 07150.080.040	M12X55	100 07150.120.055
M5X45	200 07150.050.045	M8X45	200 07150.080.045	M12X60	100 07150.120.060
M5X50	200 07150.050.050	M8X50	200 07150.080.050	M12X70	100 07150.120.070

07150 Hexagon socket button head screw								
d x L	☒	Art.number	d x L	☒	Art.number	d x L	☒	Art.number
M12X80	50	07150.120.080				M16X60	50	07150.160.060
M12X90	50	07150.120.090	M16X30	50	07150.160.030	M16X70	50	07150.160.070
M12X100	50	07150.120.100	M16X35	50	07150.160.035	M16X80	25	07150.160.080
M12X110	50	07150.120.110	M16X40	50	07150.160.040			
M12X120	50	07150.120.120	M16X45	50	07150.160.045			

• Warning: electro-galvanizing of these products may cause hydrogen embrittlement.

07151 Hexagon socket button head screw		D04A
Thread	Metric thread	 
Material	Steel	
Class	010.9	
Surface treatment	Zinc plated	

d x L	☒	Art.number	d x L	☒	Art.number	d x L	☒	Art.number
M3X5	200	07151.030.005	M5X70	200	07151.050.070	M8X100	100	07151.080.100
M3X6	200	07151.030.006						
M3X8	200	07151.030.008	M6X6	200	07151.060.006	M10X12	200	07151.100.012
M3X10	200	07151.030.010	M6X8	200	07151.060.008	M10X16	200	07151.100.016
M3X12	200	07151.030.012	M6X10	200	07151.060.010	M10X20	200	07151.100.020
M3X16	200	07151.030.016	M6X12	200	07151.060.012	M10X25	200	07151.100.025
M3X20	200	07151.030.020	M6X16	200	07151.060.016	M10X30	200	07151.100.030
M3X25	200	07151.030.025	M6X20	200	07151.060.020	M10X35	100	07151.100.035
M3X30	200	07151.030.030	M6X25	200	07151.060.025	M10X40	100	07151.100.040
			M6X30	200	07151.060.030	M10X45	100	07151.100.045
M4X6	200	07151.040.006	M6X35	200	07151.060.035	M10X50	100	07151.100.050
M4X8	200	07151.040.008	M6X40	200	07151.060.040	M10X55	100	07151.100.055
M4X10	200	07151.040.010	M6X45	200	07151.060.045	M10X60	100	07151.100.060
M4X12	200	07151.040.012	M6X50	200	07151.060.050	M10X70	100	07151.100.070
M4X16	200	07151.040.016	M6X55	200	07151.060.055	M10X80	100	07151.100.080
M4X20	200	07151.040.020	M6X60	200	07151.060.060	M10X90	100	07151.100.090
M4X25	200	07151.040.025	M6X70	200	07151.060.070	M10X100	100	07151.100.100
M4X30	200	07151.040.030						
M4X35	200	07151.040.035	M8X8	200	07151.080.008	M12X16	100	07151.120.016
M4X40	200	07151.040.040	M8X10	200	07151.080.010	M12X20	100	07151.120.020
M4X50	200	07151.040.050	M8X12	200	07151.080.012	M12X25	100	07151.120.025
			M8X14	200	07151.080.014	M12X30	100	07151.120.030
M5X6	200	07151.050.006	M8X16	200	07151.080.016	M12X35	100	07151.120.035
M5X8	200	07151.050.008	M8X20	200	07151.080.020	M12X40	100	07151.120.040
M5X10	200	07151.050.010	M8X25	200	07151.080.025	M12X45	100	07151.120.045
M5X12	200	07151.050.012	M8X30	200	07151.080.030	M12X50	100	07151.120.050
M5X16	200	07151.050.016	M8X35	200	07151.080.035	M12X55	100	07151.120.055
M5X20	200	07151.050.020	M8X40	200	07151.080.040	M12X60	100	07151.120.060
M5X25	200	07151.050.025	M8X45	200	07151.080.045	M12X70	100	07151.120.070
M5X30	200	07151.050.030	M8X50	200	07151.080.050	M12X80	50	07151.120.080
M5X35	200	07151.050.035	M8X55	200	07151.080.055	M12X90	50	07151.120.090
M5X40	200	07151.050.040	M8X60	200	07151.080.060	M12X100	50	07151.120.100
M5X45	200	07151.050.045	M8X70	200	07151.080.070	M12X110	50	07151.120.110
M5X50	200	07151.050.050	M8X80	100	07151.080.080	M12X120	50	07151.120.120
M5X60	200	07151.050.060	M8X90	100	07151.080.090			

• Warning: electro-galvanizing of these products may cause hydrogen embrittlement.

51030 Hexagon socket button head screw		Q05A
Thread	Metric thread	 
Material	Stainless steel A2	
Class	70	

d x L	☒	Art.number	d x L	☒	Art.number	d x L	☒	Art.number
M3X3*	1000	51030.030.003	M3X35*	500	51030.030.035	M4X20	50	51030.040.020
M3X4	1000	51030.030.004	M3X40*	500	51030.030.040	M4X22*	500	51030.040.022
M3X5	50	51030.030.005	M3X45*	500	51030.030.045	M4X25	50	51030.040.025
M3X6	50	51030.030.006	M3X50*	200	51030.030.050	M4X30	50	51030.040.030
M3X8	50	51030.030.008				M4X35	50	51030.040.035
M3X10	50	51030.030.010	M4X4*	1000	51030.040.004	M4X40	200	51030.040.040
M3X12	50	51030.030.012	M4X5*	1000	51030.040.005	M4X45*	200	51030.040.045
M3X14*	1000	51030.030.014	M4X6	50	51030.040.006	M4X50*	200	51030.040.050
M3X16	50	51030.030.016	M4X8	50	51030.040.008	M4X55*	200	51030.040.055
M3X18*	1000	51030.030.018	M4X10	50	51030.040.010	M4X60*	100	51030.040.060
M3X20	50	51030.030.020	M4X12	50	51030.040.012			
M3X22*	1000	51030.030.022	M4X14*	1000	51030.040.014	M5X5*	500	51030.050.005
M3X25	50	51030.030.025	M4X16	50	51030.040.016	M5X6	50	51030.050.006
M3X30*	1000	51030.030.030	M4X18*	1000	51030.040.018	M5X8	50	51030.050.008

51030 Hexagon socket button head screw ←								
d x L	☒	Art.number	d x L	☒	Art.number	d x L	☒	Art.number
M5X10	50	51030.050.010	M6X70	100	51030.060.070	M10X25	25	51030.100.025
M5X12	50	51030.050.012	M6X75*	100	51030.060.075	M10X30	25	51030.100.030
M5X14*	500	51030.050.014	M6X80	100	51030.060.080	M10X35	25	51030.100.035
M5X16	50	51030.050.016	M6X90*	100	51030.060.090	M10X40	25	51030.100.040
M5X18*	500	51030.050.018	M6X100*	100	51030.060.100	M10X45	10	51030.100.045
M5X20	50	51030.050.020	M6X120*	100	51030.060.120	M10X50	10	51030.100.050
M5X22*	500	51030.050.022				M10X55	10	51030.100.055
M5X25	25	51030.050.025	M8X8	25	51030.080.008	M10X60	10	51030.100.060
M5X30	25	51030.050.030	M8X10	25	51030.080.010	M10X65*	50	51030.100.065
M5X35	25	51030.050.035	M8X12	25	51030.080.012	M10X70	50	51030.100.070
M5X40	25	51030.050.040	M8X14*	200	51030.080.014	M10X75*	50	51030.100.075
M5X45	25	51030.050.045	M8X16	25	51030.080.016	M10X80	50	51030.100.080
M5X50	25	51030.050.050	M8X18*	200	51030.080.018	M10X90*	50	51030.100.090
M5X55*	200	51030.050.055	M8X20	25	51030.080.020	M10X100*	50	51030.100.100
M5X60*	100	51030.050.060	M8X22*	200	51030.080.022	M10X110*	50	51030.100.110
M5X65*	100	51030.050.065	M8X25	25	51030.080.025	M10X120*	50	51030.100.120
M5X70*	100	51030.050.070	M8X30	25	51030.080.030			
M5X75*	100	51030.050.075	M8X35	25	51030.080.035	M12X16*	50	51030.120.016
M5X80*	100	51030.050.080	M8X40	25	51030.080.040	M12X18*	50	51030.120.018
			M8X45	25	51030.080.045	M12X20	10	51030.120.020
M6X6	25	51030.060.006	M8X50	25	51030.080.050	M12X22*	50	51030.120.022
M6X8	25	51030.060.008	M8X55	25	51030.080.055	M12X25	10	51030.120.025
M6X10	25	51030.060.010	M8X60	25	51030.080.060	M12X30	10	51030.120.030
M6X12	25	51030.060.012	M8X65*	100	51030.080.065	M12X35	10	51030.120.035
M6X14	200	51030.060.014	M8X70*	100	51030.080.070	M12X40	10	51030.120.040
M6X16	25	51030.060.016	M8X75*	100	51030.080.075	M12X45	10	51030.120.045
M6X18*	200	51030.060.018	M8X80	100	51030.080.080	M12X50	10	51030.120.050
M6X20	25	51030.060.020	M8X90*	100	51030.080.090	M12X55	10	51030.120.055
M6X22*	200	51030.060.022	M8X100*	50	51030.080.100	M12X60	10	51030.120.060
M6X25	25	51030.060.025	M8X110*	50	51030.080.110	M12X65*	50	51030.120.065
M6X30	25	51030.060.030	M8X120*	50	51030.080.120	M12X70	10	51030.120.070
M6X35	25	51030.060.035				M12X75*	25	51030.120.075
M6X40	25	51030.060.040	M10X12	25	51030.100.012	M12X80*	25	51030.120.080
M6X45	25	51030.060.045	M10X14*	100	51030.100.014	M12X90*	25	51030.120.090
M6X50	25	51030.060.050	M10X16	25	51030.100.016	M12X100*	25	51030.120.100
M6X55	25	51030.060.055	M10X18*	100	51030.100.018	M12X110*	25	51030.120.110
M6X60	25	51030.060.060	M10X20	25	51030.100.020	M12X120*	25	51030.120.120
M6X65*	100	51030.060.065	M10X22*	100	51030.100.022			

55030 Hexagon socket button head screw		Q45A
Thread	Metric thread	
Material	Stainless steel A4	
Class	70	
		

d x L	☒	Art.number	d x L	☒	Art.number	d x L	☒	Art.number
M3X4*	1000	55030.030.004	M4X40*	200	55030.040.040	M6X14*	200	55030.060.014
M3X5*	1000	55030.030.005	M4X45*	200	55030.040.045	M6X16	25	55030.060.016
M3X6	50	55030.030.006	M4X50*	200	55030.040.050	M6X18*	200	55030.060.018
M3X8	50	55030.030.008	M4X55*	200	55030.040.055	M6X20	25	55030.060.020
M3X10	50	55030.030.010	M4X60*	100	55030.040.060	M6X22*	200	55030.060.022
M3X12	50	55030.030.012				M6X25	25	55030.060.025
M3X14*	1000	55030.030.014	M5X5*	500	55030.050.005	M6X30	25	55030.060.030
M3X16	50	55030.030.016	M5X6*	500	55030.050.006	M6X35	25	55030.060.035
M3X18*	1000	55030.030.018	M5X8	50	55030.050.008	M6X40	25	55030.060.040
M3X20	50	55030.030.020	M5X10	50	55030.050.010	M6X45	25	55030.060.045
M3X22*	1000	55030.030.022	M5X12	50	55030.050.012	M6X50	25	55030.060.050
M3X25	50	55030.030.025	M5X14*	500	55030.050.014	M6X55	25	55030.060.055
M3X30*	1000	55030.030.030	M5X16	50	55030.050.016	M6X60	25	55030.060.060
M3X35*	500	55030.030.035	M5X18*	500	55030.050.018	M6X65*	100	55030.060.065
M3X40*	500	55030.030.040	M5X20	50	55030.050.020	M6X70*	100	55030.060.070
M3X45*	500	55030.030.045	M5X22*	500	55030.050.022	M6X75*	100	55030.060.075
M3X50*	200	55030.030.050	M5X25	25	55030.050.025	M6X80*	100	55030.060.080
			M5X30	25	55030.050.030	M6X90*	100	55030.060.090
M4X4*	1000	55030.040.004	M5X35	25	55030.050.035	M6X100*	100	55030.060.100
M4X5*	1000	55030.040.005	M5X40	25	55030.050.040	M6X120*	100	55030.060.120
M4X6	50	55030.040.006	M5X45	25	55030.050.045			
M4X8	50	55030.040.008	M5X50	25	55030.050.050	M8X8*	500	55030.080.008
M4X10	50	55030.040.010	M5X55*	200	55030.050.055	M8X10	25	55030.080.010
M4X12	50	55030.040.012	M5X60*	100	55030.050.060	M8X12	25	55030.080.012
M4X14*	1000	55030.040.014	M5X65*	100	55030.050.065	M8X14*	200	55030.080.014
M4X16	50	55030.040.016	M5X70*	100	55030.050.070	M8X16	25	55030.080.016
M4X18*	1000	55030.040.018	M5X80*	100	55030.050.080	M8X18*	200	55030.080.018
M4X20	50	55030.040.020				M8X20	25	55030.080.020
M4X22*	500	55030.040.022	M6X6*	500	55030.060.006	M8X22*	200	55030.080.022
M4X25	50	55030.040.025	M6X8	25	55030.060.008	M8X25	25	55030.080.025
M4X30	50	55030.040.030	M6X10	25	55030.060.010	M8X30	25	55030.080.030
M4X35*	200	55030.040.035	M6X12	25	55030.060.012	M8X35	25	55030.080.035

55030 Hexagon socket button head screw								
d x L	☒	Art.number	d x L	☒	Art.number	d x L	☒	Art.number
M8X40	25	55030.080.040	M10X20	25	55030.100.020	M12X16*	50	55030.120.016
M8X45	25	55030.080.045	M10X22*	100	55030.100.022	M12X20*	50	55030.120.020
M8X50	25	55030.080.050	M10X25	25	55030.100.025	M12X25*	50	55030.120.025
M8X55	25	55030.080.055	M10X30	25	55030.100.030	M12X30*	50	55030.120.030
M8X60	25	55030.080.060	M10X35	25	55030.100.035	M12X35*	50	55030.120.035
M8X65*	100	55030.080.065	M10X40	25	55030.100.040	M12X40*	50	55030.120.040
M8X70*	100	55030.080.070	M10X45	10	55030.100.045	M12X45*	50	55030.120.045
M8X75*	100	55030.080.075	M10X50	10	55030.100.050	M12X50*	50	55030.120.050
M8X80*	100	55030.080.080	M10X55	10	55030.100.055	M12X55*	50	55030.120.055
M8X90*	100	55030.080.090	M10X60	10	55030.100.060	M12X60*	50	55030.120.060
M8X100*	50	55030.080.100	M10X65*	50	55030.100.065	M12X65*	50	55030.120.065
M8X110*	50	55030.080.110	M10X70*	50	55030.100.070	M12X70*	50	55030.120.070
M8X120*	50	55030.080.120	M10X75*	50	55030.100.075	M12X80*	25	55030.120.080
M10X12*	100	55030.100.012	M10X80*	50	55030.100.080	M12X90*	25	55030.120.090
M10X14*	100	55030.100.014	M10X90*	50	55030.100.090	M12X100*	25	55030.120.100
M10X16	25	55030.100.016	M10X100*	50	55030.100.100	M12X110*	25	55030.120.110
M10X18*	100	55030.100.018	M10X110*	50	55030.100.110	M12X120*	25	55030.120.120
			M10X120*	50	55030.100.120			

Hexalobular socket button head screw

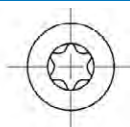
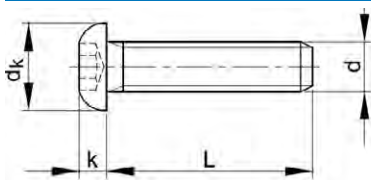

ISO ≈7380-1
 ASME ≈B18.3.4M
 NF ≈E25-126
 BS ≈4168-6

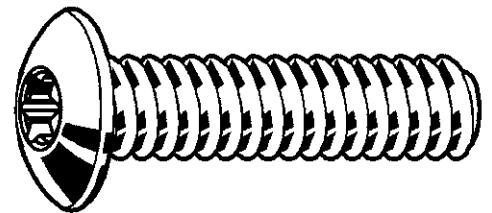

Technical Data

d	dk (max.)	k (max.)	P	Socket
M3	5.7	1.65	0.5	T10
M4	7.6	2.2	0.7	T20
M5	9.5	2.75	0.8	T25
M6	10.5	3.3	1	T30
M8	14	4.4	1.25	T40
M10	17.5	5.5	1.50	T50

- Due to the unfavourable geometry of the head, these fasteners do have reduced loadability.
- When steel fasteners (e.g. 8.8 / 10.9 / 12.9) with reduced loadability needs to be marked, the marking symbol for the property class is preceded by the digit '0'. So 8.8 → 08.8 and 10.9 → 010.9 and 12.9 → 012.9.
- For the stainless steel fasteners it is indicated by only marking the steel grade and by leaving out the property class 70 (e.g. A2-70 → A2).
- The former and the new indications can occur side by side for some time.

Article groups

Thread	Driving features	Material	Class	Surface treatment	Code	Page
M	Hexalobular	St	010.9	Zipl	07290	2-54
M	Hexalobular	St.St. A2			51029	2-55
M	Hexalobular	St.St. A4			55032	2-55

07290 Hexalobular socket button head screw D04A

Thread	Metric thread
Material	Steel
Class	010.9
Surface treatment	Zinc plated

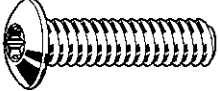
d x L	☒	Art.number	d x L	☒	Art.number	d x L	☒	Art.number
M4X10	200	07290.040.010	M5X20	200	07290.050.020	M8X12	200	07290.080.012
M4X12	200	07290.040.012	M5X25	200	07290.050.025	M8X16	200	07290.080.016
M4X16	200	07290.040.016	M6X10	200	07290.060.010	M8X20	200	07290.080.020
M4X20	200	07290.040.020	M6X12	200	07290.060.012	M8X25	200	07290.080.025
M5X10	200	07290.050.010	M6X16	200	07290.060.016	M8X30	200	07290.080.030
M5X12	200	07290.050.012	M6X20	200	07290.060.020	M8X35	200	07290.080.035
M5X16	200	07290.050.016	M6X25	200	07290.060.025	M8X40	200	07290.080.040

• Warning: electro-galvanizing of these products may cause hydrogen embrittlement.

51029 Hexalobular socket button head screw Q45A

Thread: Metric thread
Material: Stainless steel A2



d x L	☒	Art.number	d x L	☒	Art.number	d x L	☒	Art.number
M3X3*	1000	51029.030.003	M5X10*	500	51029.050.010	M8X10*	200	51029.080.010
M3X4*	1000	51029.030.004	M5X12*	500	51029.050.012	M8X12*	200	51029.080.012
M3X5*	500	51029.030.005	M5X14*	500	51029.050.014	M8X14*	200	51029.080.014
M3X6*	500	51029.030.006	M5X16*	500	51029.050.016	M8X16	200	51029.080.016
M3X8*	500	51029.030.008	M5X18*	500	51029.050.018	M8X18*	200	51029.080.018
M3X10*	1000	51029.030.010	M5X20*	500	51029.050.020	M8X20*	200	51029.080.020
M3X12*	1000	51029.030.012	M5X22*	500	51029.050.022	M8X22*	200	51029.080.022
M3X14*	1000	51029.030.014	M5X25*	500	51029.050.025	M8X25*	200	51029.080.025
M3X16*	1000	51029.030.016	M5X30*	500	51029.050.030	M8X30*	200	51029.080.030
M3X18*	1000	51029.030.018	M5X35*	500	51029.050.035	M8X35*	200	51029.080.035
M3X20	1000	51029.030.020	M5X40*	500	51029.050.040	M8X40*	200	51029.080.040
M3X22*	1000	51029.030.022	M5X45*	200	51029.050.045	M8X45*	200	51029.080.045
M3X25*	1000	51029.030.025	M5X50*	200	51029.050.050	M8X50*	200	51029.080.050
M3X30*	1000	51029.030.030	M5X60*	100	51029.050.060	M8X55*	200	51029.080.055
M3X35*	500	51029.030.035	M6X6*	500	51029.060.006	M8X60*	200	51029.080.060
M3X40*	500	51029.030.040	M6X8*	500	51029.060.008	M8X70*	100	51029.080.070
M4X4*	1000	51029.040.004	M6X10*	500	51029.060.010	M8X80*	100	51029.080.080
M4X5*	1000	51029.040.005	M6X12*	500	51029.060.012	M8X88*	500	51029.080.088
M4X6	500	51029.040.006	M6X14*	500	51029.060.014	M8X100*	50	51029.080.100
M4X8	1000	51029.040.008	M6X16*	500	51029.060.016	M8X120*	50	51029.080.120
M4X10*	1000	51029.040.010	M6X18*	200	51029.060.018	M10X12*	100	51029.100.012
M4X12*	1000	51029.040.012	M6X20*	500	51029.060.020	M10X20*	100	51029.100.020
M4X16*	1000	51029.040.016	M6X22*	200	51029.060.022	M10X25*	100	51029.100.025
M4X18*	1000	51029.040.018	M6X25*	200	51029.060.025	M10X30*	100	51029.100.030
M4X20*	500	51029.040.020	M6X30*	200	51029.060.030	M10X35*	100	51029.100.035
M4X25*	500	51029.040.025	M6X35*	200	51029.060.035	M10X40*	100	51029.100.040
M4X30*	500	51029.040.030	M6X40*	200	51029.060.040	M10X45*	100	51029.100.045
M4X35*	200	51029.040.035	M6X45*	100	51029.060.045	M10X50*	50	51029.100.050
M4X40*	200	51029.040.040	M6X50*	100	51029.060.050	M10X60*	50	51029.100.060
M5X5*	500	51029.050.005	M6X55*	100	51029.060.055	M10X70*	50	51029.100.070
M5X6*	500	51029.050.006	M6X60*	100	51029.060.060	M10X80*	50	51029.100.080
M5X8	500	51029.050.008	M6X70*	100	51029.060.070	M10X100*	50	51029.100.100
			M6X80*	100	51029.060.080			

55032 Hexalobular socket button head screw Q45A

Thread: Metric thread
Material: Stainless steel A4



d x L	☒	Art.number	d x L	☒	Art.number	d x L	☒	Art.number
M3X4*	1000	55032.030.004	M4X8*	1000	55032.040.008	M5X8*	500	55032.050.008
M3X6*	1000	55032.030.006	M4X20*	500	55032.040.020	M6X10*	500	55032.060.010
M3X8*	1000	55032.030.008	M5X6*	500	55032.050.006	M6X30*	200	55032.060.030
M4X6*	1000	55032.040.006						

Button head cap screw UNC

2

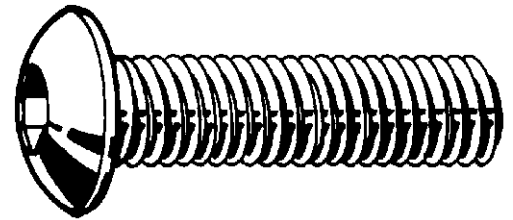
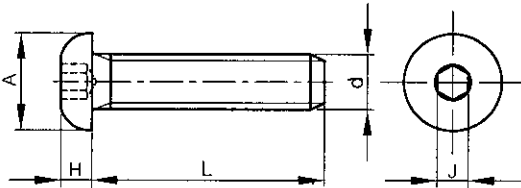

Technical Data

d	A	H	J	Threads per inch
No.1	0.139	0.039	0.050	64
No.2	0.164	0.046	0.050	56
No.3	0.188	0.052	1/16	48
No.4	0.213	0.059	1/16	40
No.5	0.238	0.066	5/64	40
No.6	0.262	0.073	5/64	32
No.8	0.312	0.087	3/32	32
No.10	0.361	0.101	1/8	24
1/4	0.437	0.132	5/32	20
5/16	0.547	0.166	3/16	18
3/8	0.656	0.199	7/32	16
1/2	0.875	0.265	5/16	13
5/8	1.000	0.331	3/8	11

- Due to the unfavourable geometry of the head, these fasteners do have reduced loadability.

Article groups

Thread	Driving features	Material	Class	Surface treatment	Code	Page
UNC	Hexagon socket	St	Grade 5		U07150	2-56
UNC	Hexagon socket	St	Grade 5	Zipl	U07151	2-57
UNC	Hexagon socket	St.St. A2 (AISI304/18-8)	F879		U51030	2-57

U07150 Button head cap screw UNC

X05A

Thread Unified National Coarse
Material Steel
Class Grade 5

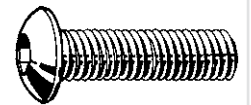

d x L	☒	Art.number	d x L	☒	Art.number	d x L	☒	Art.number
NO.1-64X3/8*	100	U07150.007.0037	NO.4-40X7/8*	100	U07150.011.0087	NO.8-32X1.1/2*	100	U07150.016.0150
NO.1-64X1/2*	100	U07150.007.0050	NO.4-40X1 Inch*	100	U07150.011.0100	NO.8-32X2 Inch*	100	U07150.016.0200
NO.1-64X3/4*	100	U07150.007.0075						
NO.2-56X1/8*	100	U07150.008.0012	NO.5-40X1/4*	100	U07150.012.0025	NO.10-24X1/4*	100	U07150.019.0025
NO.2-56X3/16*	100	U07150.008.0018	NO.5-40X3/8*	100	U07150.012.0037	NO.10-24X3/8*	100	U07150.019.0037
NO.2-56X1/4*	100	U07150.008.0025	NO.5-40X1/2*	100	U07150.012.0050	NO.10-24X1/2*	100	U07150.019.0050
NO.2-56X5/16*	100	U07150.008.0031	NO.5-40X3/4*	100	U07150.012.0075	NO.10-24X5/8*	100	U07150.019.0062
NO.2-56X3/8*	100	U07150.008.0037	NO.5-40X1 Inch*	100	U07150.012.0100	NO.10-24X3/4*	100	U07150.019.0075
NO.2-56X1/2*	100	U07150.008.0050				NO.10-24X7/8*	100	U07150.019.0087
NO.2-56X5/8*	100	U07150.008.0062	NO.6-32X3/16*	100	U07150.013.0018	NO.10-24X1 Inch*	100	U07150.019.0100
NO.2-56X3/4*	100	U07150.008.0075	NO.6-32X1/4*	100	U07150.013.0025	NO.10-24X1.1/4*	100	U07150.019.0125
NO.2-56X1 Inch*	100	U07150.008.0100	NO.6-32X5/16*	100	U07150.013.0031	NO.10-24X1.1/2*	100	U07150.019.0150
			NO.6-32X3/8*	100	U07150.013.0037	NO.10-24X2 Inch*	100	U07150.019.0200
			NO.6-32X1/2*	100	U07150.013.0050			
NO.3-48X3/16*	100	U07150.009.0018	NO.6-32X5/8*	100	U07150.013.0062	1/4-20X3/8*	100	U07150.025.0037
NO.3-48X1/4*	100	U07150.009.0025	NO.6-32X7/8*	100	U07150.013.0075	1/4-20X1/2*	100	U07150.025.0050
NO.3-48X5/16*	100	U07150.009.0031	NO.6-32X3/4*	100	U07150.013.0087	1/4-20X5/8*	100	U07150.025.0062
NO.3-48X3/8*	100	U07150.009.0037	NO.6-32X1 Inch*	100	U07150.013.0100	1/4-20X3/4*	100	U07150.025.0075
NO.3-48X1/2*	100	U07150.009.0050	NO.6-32X1.1/4*	100	U07150.013.0125	1/4-20X1 Inch*	100	U07150.025.0100
NO.3-48X5/8*	100	U07150.009.0062	NO.6-32X1.1/2*	100	U07150.013.0150	1/4-20X1.1/2*	100	U07150.025.0150
NO.3-48X3/4*	100	U07150.009.0075	NO.6-32X2 Inch*	100	U07150.013.0200	1/4-20X2 Inch*	50	U07150.025.0200
NO.3-48X1 Inch*	100	U07150.009.0100				1/4-20X2.1/2*	50	U07150.025.0250
			NO.8-32X3/16*	100	U07150.016.0018	1/4-20X3 Inch*	25	U07150.025.0300
NO.4-40X1/8*	100	U07150.011.0012	NO.8-32X1/4*	100	U07150.016.0025	1/4-20X3.1/2*	25	U07150.025.0350
NO.4-40X3/16*	100	U07150.011.0018	NO.8-32X5/16*	100	U07150.016.0031			
NO.4-40X1/4*	100	U07150.011.0025	NO.8-32X3/8*	100	U07150.016.0037	5/16-18X3/8*	100	U07150.031.0037
NO.4-40X5/16*	100	U07150.011.0031	NO.8-32X1/2*	100	U07150.016.0050	5/16-18X1/2*	100	U07150.031.0050
NO.4-40X3/8*	100	U07150.011.0037	NO.8-32X5/8*	100	U07150.016.0062	5/16-18X5/8*	100	U07150.031.0062
NO.4-40X7/16*	100	U07150.011.0043	NO.8-32X3/4*	100	U07150.016.0075	5/16-18X3/4*	100	U07150.031.0075
NO.4-40X1/2*	100	U07150.011.0050	NO.8-32X1 Inch*	100	U07150.016.0100	5/16-18X7/8*	100	U07150.031.0087
NO.4-40X5/8*	100	U07150.011.0062	NO.8-32X1.1/4*	100	U07150.016.0125			
NO.4-40X3/4*	100	U07150.011.0075						

U07150 Button head cap screw UNC								
d x L	☒	Art.number	d x L	☒	Art.number	d x L	☒	Art.number
5/16-18X1.1/4*	50	U07150.031.0125	3/8-16X1.3/4*	25	U07150.037.0175	1/2-13X2 Inch*	10	U07150.050.0200
5/16-18X1.1/2*	50	U07150.031.0150	3/8-16X2 Inch*	25	U07150.037.0200	1/2-13X2.1/2*	10	U07150.050.0250
5/16-18X2 Inch*	50	U07150.031.0200	3/8-16X2.1/4*	25	U07150.037.0225	1/2-13X3 Inch*	5	U07150.050.0300
3/8-16X1/2*	50	U07150.037.0050	3/8-16X2.1/2*	25	U07150.037.0250	5/8-11X1 Inch*	10	U07150.062.0100
3/8-16X5/8*	50	U07150.037.0062	3/8-16X2.3/4*	25	U07150.037.0275	5/8-11X1.1/2*	10	U07150.062.0150
3/8-16X3/4*	50	U07150.037.0075	1/2-13X3/4*	10	U07150.050.0075	5/8-11X2 Inch*	5	U07150.062.0200
3/8-16X7/8*	50	U07150.037.0087	1/2-13X1 Inch*	10	U07150.050.0100	5/8-11X2.1/2*	5	U07150.062.0250
3/8-16X1 Inch*	50	U07150.037.0100	1/2-13X1.1/4*	10	U07150.050.0125	5/8-11X3 Inch*	5	U07150.062.0300
3/8-16X1.1/4*	50	U07150.037.0125	1/2-13X1.1/2*	10	U07150.050.0150			
3/8-16X1.1/2*	25	U07150.037.0150	1/2-13X1.3/4*	10	U07150.050.0175			

U07151 Button head cap screw UNC		X05A
Thread	Unified National Coarse	
Material	Steel	
Class	Grade 5	
Surface treatment	Zinc plated	
		

d x L	☒	Art.number	d x L	☒	Art.number	d x L	☒	Art.number
NO.4-40X1/4*	100	U07151.011.0025	NO.10-24X5/8*	100	U07151.019.0062	5/16-18X1.1/2*	50	U07151.031.0150
NO.4-40X3/8*	100	U07151.011.0037	NO.10-24X3/4*	100	U07151.019.0075	3/8-16X1/2*	50	U07151.037.0050
NO.4-40X1/2*	100	U07151.011.0050	NO.10-24X7/8*	100	U07151.019.0087	3/8-16X3/4*	50	U07151.037.0075
			NO.10-24X1 Inch*	100	U07151.019.0100	3/8-16X1 Inch*	50	U07151.037.0100
NO.6-32X1/4*	100	U07151.013.0025				3/8-16X1.1/4*	50	U07151.037.0125
NO.6-32X3/8*	100	U07151.013.0037	1/4-20X3/8*	100	U07151.025.0037	3/8-16X1.1/2*	25	U07151.037.0150
NO.6-32X1/2*	100	U07151.013.0050	1/4-20X1/2*	100	U07151.025.0050			
NO.6-32X5/8*	100	U07151.013.0062	1/4-20X5/8*	100	U07151.025.0062			
			1/4-20X3/4*	100	U07151.025.0075	1/2-13X1 Inch*	10	U07151.050.0100
NO.8-32X1/4*	100	U07151.016.0025	1/4-20X7/8*	100	U07151.025.0087	1/2-13X1.1/4*	10	U07151.050.0125
NO.8-32X3/8*	100	U07151.016.0037	1/4-20X1 Inch*	100	U07151.025.0100	1/2-13X1.1/2*	10	U07151.050.0150
NO.8-32X1/2*	100	U07151.016.0050	1/4-20X1.1/2*	100	U07151.025.0150	1/2-13X2 Inch*	10	U07151.050.0200
NO.8-32X5/8*	100	U07151.016.0062						
NO.8-32X3/4*	100	U07151.016.0075	5/16-18X3/8*	100	U07151.031.0037	5/8-11X1 Inch*	10	U07151.062.0100
NO.8-32X1 Inch*	100	U07151.016.0100	5/16-18X1/2*	100	U07151.031.0050	5/8-11X1.1/2*	10	U07151.062.0150
			5/16-18X3/4*	100	U07151.031.0075	5/8-11X2 Inch*	5	U07151.062.0200
NO.10-24X3/8*	100	U07151.019.0037	5/16-18X1 Inch*	50	U07151.031.0100			
NO.10-24X1/2*	100	U07151.019.0050	5/16-18X1.1/4*	50	U07151.031.0125			

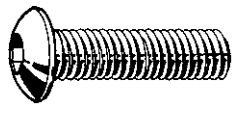
U51030 Button head cap screw UNC		X15A
Thread	Unified National Coarse	
Material	Stainless steel A2 (AISI 304/18-8)	
Class	F879	
		

d x L	☒	Art.number	d x L	☒	Art.number	d x L	☒	Art.number
NO.1-64X3/8*	100	U51030.007.0037	NO.4-40X5/8*	100	U51030.011.0062	NO.8-32X3/8*	100	U51030.016.0037
NO.1-64X1/2*	100	U51030.007.0050	NO.4-40X3/4*	100	U51030.011.0075	NO.8-32X7/16*	100	U51030.016.0043
NO.1-64X3/4*	100	U51030.007.0075	NO.4-40X7/8*	100	U51030.011.0087	NO.8-32X1/2*	100	U51030.016.0050
			NO.4-40X1 Inch*	100	U51030.011.0100	NO.8-32X5/8*	100	U51030.016.0062
NO.2-56X1/8*	100	U51030.008.0012				NO.8-32X3/4*	100	U51030.016.0075
NO.2-56X3/16*	100	U51030.008.0018	NO.5-40X1/4*	100	U51030.012.0025	NO.8-32X7/8*	100	U51030.016.0087
NO.2-56X1/4*	100	U51030.008.0025	NO.5-40X5/16*	100	U51030.012.0031	NO.8-32X1 Inch*	100	U51030.016.0100
NO.2-56X5/16*	100	U51030.008.0031	NO.5-40X3/8*	100	U51030.012.0037	NO.8-32X1.1/4*	100	U51030.016.0125
NO.2-56X3/8*	100	U51030.008.0037	NO.5-40X1/2*	100	U51030.012.0050	NO.8-32X1.1/2*	100	U51030.016.0150
NO.2-56X1/2*	100	U51030.008.0050	NO.5-40X5/8*	100	U51030.012.0062			
NO.2-56X5/8*	100	U51030.008.0062	NO.5-40X3/4*	100	U51030.012.0075	NO.10-24X1/4*	100	U51030.019.0025
NO.2-56X3/4*	100	U51030.008.0075	NO.5-40X1 Inch*	100	U51030.012.0100	NO.10-24X5/16*	100	U51030.019.0031
NO.2-56X1 Inch*	100	U51030.008.0100				NO.10-24X3/8*	100	U51030.019.0037
			NO.6-32X3/16*	100	U51030.013.0018	NO.10-24X1/2*	100	U51030.019.0050
NO.3-48X3/16*	100	U51030.009.0018	NO.6-32X1/4*	100	U51030.013.0025	NO.10-24X5/8*	100	U51030.019.0062
NO.3-48X1/4*	100	U51030.009.0025	NO.6-32X5/16*	100	U51030.013.0031	NO.10-24X3/4*	100	U51030.019.0075
NO.3-48X5/16*	100	U51030.009.0031	NO.6-32X3/8*	100	U51030.013.0037	NO.10-24X7/8*	100	U51030.019.0087
NO.3-48X3/8*	100	U51030.009.0037	NO.6-32X7/16*	100	U51030.013.0043	NO.10-24X1 Inch*	100	U51030.019.0100
NO.3-48X1/2*	100	U51030.009.0050	NO.6-32X1/2*	100	U51030.013.0050	NO.10-24X1.1/8*	100	U51030.019.0112
NO.3-48X3/4*	100	U51030.009.0075	NO.6-32X5/8*	100	U51030.013.0062	NO.10-24X1.1/4*	100	U51030.019.0125
NO.3-48X1 Inch*	100	U51030.009.0100	NO.6-32X3/4*	100	U51030.013.0075	NO.10-24X1.1/2*	100	U51030.019.0150
			NO.6-32X7/8*	100	U51030.013.0087	NO.10-24X1.3/4*	100	U51030.019.0175
NO.4-40X1/8*	100	U51030.011.0012	NO.6-32X1 Inch*	100	U51030.013.0100	NO.10-24X2 Inch*	100	U51030.019.0200
NO.4-40X3/16*	100	U51030.011.0018	NO.6-32X1.1/4*	100	U51030.013.0125			
NO.4-40X1/4*	100	U51030.011.0025	NO.6-32X1.1/2*	100	U51030.013.0150			
NO.4-40X5/16*	100	U51030.011.0031				1/4-20X5/16*	100	U51030.025.0031
NO.4-40X3/8*	100	U51030.011.0037	NO.8-32X3/16*	100	U51030.016.0018	1/4-20X3/8*	100	U51030.025.0037
NO.4-40X7/16*	100	U51030.011.0043	NO.8-32X1/4*	100	U51030.016.0025	1/4-20X1/2*	100	U51030.025.0050
NO.4-40X1/2*	100	U51030.011.0050	NO.8-32X5/16*	100	U51030.016.0031	1/4-20X5/8*	100	U51030.025.0062
						1/4-20X3/4*	100	U51030.025.0075

U51030 Button head cap screw UNC								
d x L	☒	Art.number	d x L	☒	Art.number	d x L	☒	Art.number
1/4-20X7/8*	100	U51030.025.0087	5/16-18X1 Inch*	50	U51030.031.0100	3/8-16X2 Inch*	25	U51030.037.0200
1/4-20X1 Inch*	100	U51030.025.0100	5/16-18X1.1/4*	50	U51030.031.0125	3/8-16X2.1/2*	25	U51030.037.0250
1/4-20X1.1/4*	100	U51030.025.0125	5/16-18X1.1/2*	50	U51030.031.0150	3/8-16X3 Inch*	10	U51030.037.0300
1/4-20X1.1/2*	100	U51030.025.0150	5/16-18X1.3/4*	50	U51030.031.0175			
1/4-20X1.3/4*	100	U51030.025.0175	5/16-18X2 Inch*	50	U51030.031.0200	1/2-13X1 Inch*	10	U51030.050.0100
1/4-20X2 Inch*	50	U51030.025.0200				1/2-13X1.1/4*	10	U51030.050.0125
			3/8-16X1/2*	50	U51030.037.0050	1/2-13X1.1/2*	10	U51030.050.0150
5/16-18X3/8*	100	U51030.031.0037	3/8-16X3/4*	50	U51030.037.0075	1/2-13X1.3/4*	10	U51030.050.0175
5/16-18X1/2*	100	U51030.031.0050	3/8-16X1 Inch*	50	U51030.037.0100	1/2-13X2 Inch*	10	U51030.050.0200
5/16-18X5/8*	100	U51030.031.0062	3/8-16X1.1/4*	50	U51030.037.0125	1/2-13X2.1/2*	10	U51030.050.0250
5/16-18X3/4*	100	U51030.031.0075	3/8-16X1.1/2*	25	U51030.037.0150	1/2-13X3 Inch*	5	U51030.050.0300
5/16-18X7/8*	100	U51030.031.0087	3/8-16X1.3/4*	25	U51030.037.0175			

Button head cap screw UNF

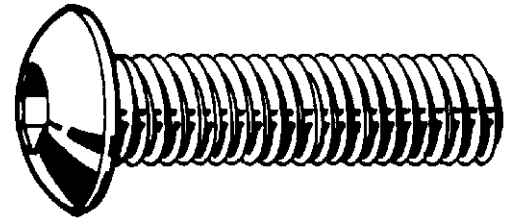
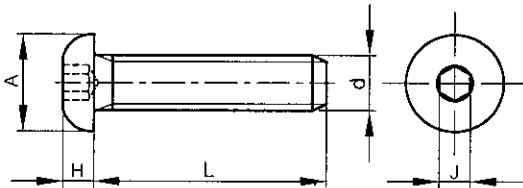

Technical Data				
d	A	H	J	Threads per inch
No.0	0.114	0.032	0.035	80
No.1	0.139	0.039	0.050	72
No.10	0.361	0.101	1/8	32
1/4	0.437	0.132	5/32	28
5/16	0.547	0.166	3/16	24
3/8	0.656	0.199	7/32	24

• Due to the unfavourable geometry of the head, these fasteners do have reduced loadability.

Article groups					
Thread	Driving features	Material	Class	Code	Page
UNF	Hexagon socket	St	Grade 5	U07230	2-58
UNF	Hexagon socket	St.St. A2 (AISI304/18-8)	F879	U51130	2-59

U07230 Button head cap screw UNF		X05A
Thread	Unified National Fine	
Material	Steel	
Class	Grade 5	

d x L	☒	Art.number	d x L	☒	Art.number	d x L	☒	Art.number
NO.0-80X1/8*	100	U07230.006.0012	NO.10-32X1/4*	100	U07230.019.0025	1/4-28X5/8*	100	U07230.025.0062
NO.0-80X3/16*	100	U07230.006.0018	NO.10-32X5/16*	100	U07230.019.0031	1/4-28X3/4*	100	U07230.025.0075
NO.0-80X1/4*	100	U07230.006.0025	NO.10-32X3/8*	100	U07230.019.0037	1/4-28X1 Inch*	100	U07230.025.0100
NO.0-80X5/16*	100	U07230.006.0031	NO.10-32X1/2*	100	U07230.019.0050	1/4-28X1.1/2*	100	U07230.025.0150
NO.0-80X3/8*	100	U07230.006.0037	NO.10-32X5/8*	100	U07230.019.0062	1/4-28X2 Inch*	50	U07230.025.0200
NO.0-80X1/2*	100	U07230.006.0050	NO.10-32X3/4*	100	U07230.019.0075			
			NO.10-32X7/8*	100	U07230.019.0087	5/16-24X3/8*	100	U07230.031.0037
NO.1-72X3/16*	100	U07230.007.0018	NO.10-32X1 Inch*	100	U07230.019.0100	5/16-24X1/2*	100	U07230.031.0050
NO.1-72X1/4*	100	U07230.007.0025	NO.10-32X1.1/4*	100	U07230.019.0125	5/16-24X5/8*	100	U07230.031.0062
NO.1-72X5/16*	100	U07230.007.0031	NO.10-32X1.1/2*	100	U07230.019.0150	5/16-24X3/4*	100	U07230.031.0075
NO.1-72X3/8*	100	U07230.007.0037	NO.10-32X1.3/4*	100	U07230.019.0175	5/16-24X1 Inch*	50	U07230.031.0100
NO.1-72X1/2*	100	U07230.007.0050	NO.10-32X2 Inch*	100	U07230.019.0200			
NO.1-72X5/8*	100	U07230.007.0062				3/8-24X1/2*	50	U07230.037.0050
NO.1-72X3/4*	100	U07230.007.0075	1/4-28X3/8*	100	U07230.025.0037	3/8-24X3/4*	50	U07230.037.0075
			1/4-28X1/2*	100	U07230.025.0050	3/8-24X1 Inch*	50	U07230.037.0100

U51130	Button head cap screw UNF	X15A
Thread	Unified National Fine	
Material	Stainless steel A2 (AISI 304/18-8)	
Class	F879	

d x L	☒	Art.number	d x L	☒	Art.number	d x L	☒	Art.number
NO.0-80X1/8	100	U51130.006.0012	NO.1-72X1/2*	100	U51130.007.0050	NO.10-32X1 Inch*	100	U51130.019.0100
NO.0-80X3/16*	100	U51130.006.0018	NO.1-72X5/8*	100	U51130.007.0062	NO.10-32X1.1/4*	100	U51130.019.0125
NO.0-80X1/4*	100	U51130.006.0025	NO.1-72X3/4*	100	U51130.007.0075	NO.10-32X1.1/2*	100	U51130.019.0150
NO.0-80X5/16*	100	U51130.006.0031				NO.10-32X1.3/4*	100	U51130.019.0175
NO.0-80X3/8*	100	U51130.006.0037	NO.10-32X1/4*	100	U51130.019.0025	NO.10-32X2 Inch*	100	U51130.019.0200
NO.0-80X1/2*	100	U51130.006.0050	NO.10-32X5/16*	100	U51130.019.0031			
			NO.10-32X3/8*	100	U51130.019.0037	1/4-28X2 Inch*	50	U51130.025.0200
NO.1-72X1/8*	100	U51130.007.0012	NO.10-32X7/16*	100	U51130.019.0043			
NO.1-72X3/16*	100	U51130.007.0018	NO.10-32X1/2*	100	U51130.019.0050	5/16-24X3/8*	100	U51130.031.0037
NO.1-72X1/4*	100	U51130.007.0025	NO.10-32X5/8*	100	U51130.019.0062	5/16-24X1/2*	100	U51130.031.0050
NO.1-72X5/16*	100	U51130.007.0031	NO.10-32X3/4*	100	U51130.019.0075	5/16-24X1 Inch*	50	U51130.031.0100
NO.1-72X3/8*	100	U51130.007.0037	NO.10-32X7/8*	100	U51130.019.0087	5/16-24X1.1/2*	50	U51130.031.0150

Hexagon socket button head screw with flange

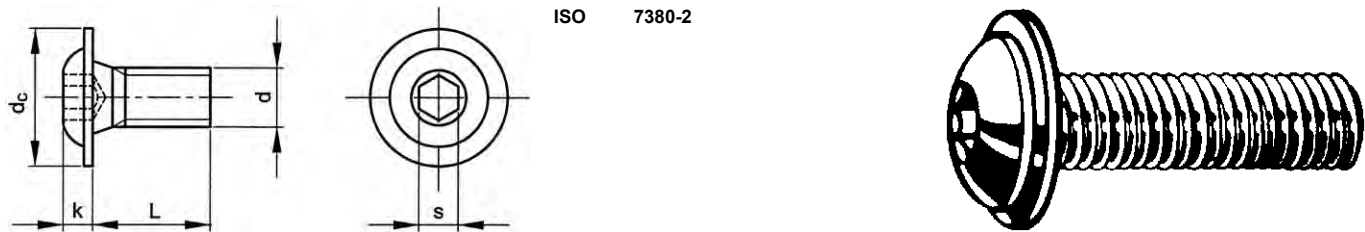

Technical Data

d	d _c (max.)	Full thread L ≤	k (max.)	P	s
M3	6.9	12	1.65	0.5	2
M4	9.4	16	2.2	0.7	2.5
M5	11.8	30	2.75	0.8	3
M6	13.6	30	3.3	1	4
M8	17.8	40	4.4	1.25	5
M10	21.9	40	5.5	1.5	6
M12	26.0	50	6.6	1.75	8

- Due to the unfavourable geometry of the head, these fasteners do have reduced loadability.
- When steel fasteners (e.g. 8.8 / 10.9 / 12.9) with reduced loadability needs to be marked, the marking symbol for the property class is preceded by the digit '0'. So 8.8 → 08.8 and 10.9 → 010.9 and 12.9 → 012.9.
- For the stainless steel fasteners it is indicated by only marking the steel grade and by leaving out the property class 70 (e.g. A2-70 → A2).
- The former and the new indications can occur side by side for some time.

Article groups

Thread	Driving features	Material	Class	Surface treatment	Code	Page
M	Hexagon socket	St	010.9	Zipl	07141	2-59
M	Hexagon socket	St.St. A2			51028	2-60
M	Hexagon socket	St.St. A4			55025	2-61

07141 Hexagon socket button head screw with flange D04A

Thread	Metric thread	
Material	Steel	
Class	010.9	
Surface treatment	Zinc plated	

d x L	☒	Art.number	d x L	☒	Art.number	d x L	☒	Art.number
M3X6	200	07141.030.006	M4X10	200	07141.040.010	M5X10	200	07141.050.010
M3X8	200	07141.030.008	M4X12	200	07141.040.012	M5X12	200	07141.050.012
M3X10	200	07141.030.010	M4X16	200	07141.040.016	M5X16	200	07141.050.016
M3X12	200	07141.030.012	M4X20	200	07141.040.020	M5X20	200	07141.050.020
M3X16	200	07141.030.016	M4X25	200	07141.040.025	M5X25	200	07141.050.025
M3X20	200	07141.030.020	M4X30	200	07141.040.030	M5X30	200	07141.050.030
M3X25	200	07141.030.025	M4X40	200	07141.040.040	M5X40	200	07141.050.040
M3X30	200	07141.030.030	M4X45	200	07141.040.045	M5X45	200	07141.050.045
						M5X50	200	07141.050.050
M4X6	200	07141.040.006	M5X6	200	07141.050.006			
M4X8	200	07141.040.008	M5X8	200	07141.050.008	M6X8	200	07141.060.008

07141 Hexagon socket button head screw with flange ←

d x L	☒	Art.number	d x L	☒	Art.number	d x L	☒	Art.number
M6X10	200	07141.060.010	M8X25	200	07141.080.025	M10X50	100	07141.100.050
M6X12	200	07141.060.012	M8X30	200	07141.080.030	M10X60	100	07141.100.060
M6X16	200	07141.060.016	M8X35	200	07141.080.035			
M6X20	200	07141.060.020	M8X40	200	07141.080.040	M12X20	100	07141.120.020
M6X25	200	07141.060.025	M8X45	200	07141.080.045	M12X25	100	07141.120.025
M6X30	200	07141.060.030	M8X50	200	07141.080.050	M12X30	100	07141.120.030
M6X35	200	07141.060.035	M8X60	200	07141.080.060	M12X35	100	07141.120.035
M6X40	200	07141.060.040				M12X40	100	07141.120.040
M6X50	200	07141.060.050	M10X16	200	07141.100.016	M12X45	100	07141.120.045
M6X60	200	07141.060.060	M10X20	200	07141.100.020	M12X50	100	07141.120.050
			M10X25	200	07141.100.025	M12X60	100	07141.120.060
M8X10	200	07141.080.010	M10X30	200	07141.100.030	M12X70	100	07141.120.070
M8X12	200	07141.080.012	M10X35	100	07141.100.035	M12X80	50	07141.120.080
M8X16	200	07141.080.016	M10X40	100	07141.100.040			
M8X20	200	07141.080.020	M10X45	100	07141.100.045			

• Warning: electro-galvanizing of these products may cause hydrogen embrittlement.

51028 Hexagon socket button head screw with flange R09A

Thread Metric thread
Material Stainless steel A2

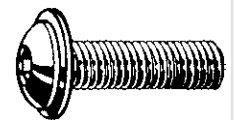

d x L	☒	Art.number	d x L	☒	Art.number	d x L	☒	Art.number
M3X3*	1000	51028.030.003	M5X40	200	51028.050.040	M8X70*	100	51028.080.070
M3X4*	1000	51028.030.004	M5X45*	200	51028.050.045	M8X75*	100	51028.080.075
M3X5*	1000	51028.030.005	M5X50*	200	51028.050.050	M8X80*	100	51028.080.080
M3X6	50	51028.030.006	M5X55*	200	51028.050.055	M8X90*	100	51028.080.090
M3X8	50	51028.030.008	M5X60*	100	51028.050.060	M8X100*	50	51028.080.100
M3X10	50	51028.030.010	M5X65*	100	51028.050.065	M8X110*	50	51028.080.110
M3X12	50	51028.030.012	M5X70*	100	51028.050.070	M8X120*	50	51028.080.120
M3X14*	1000	51028.030.014	M5X75*	100	51028.050.075			
M3X16	50	51028.030.016	M5X80*	100	51028.050.080	M10X12*	100	51028.100.012
M3X18*	1000	51028.030.018				M10X14*	100	51028.100.014
M3X20	50	51028.030.020	M6X6*	500	51028.060.006	M10X16	25	51028.100.016
M3X22*	1000	51028.030.022	M6X8	25	51028.060.008	M10X18*	100	51028.100.018
M3X25*	1000	51028.030.025	M6X10	25	51028.060.010	M10X20	25	51028.100.020
M3X30*	1000	51028.030.030	M6X12	25	51028.060.012	M10X22*	100	51028.100.022
M3X35*	500	51028.030.035	M6X14*	200	51028.060.014	M10X25	25	51028.100.025
M3X40*	500	51028.030.040	M6X16	25	51028.060.016	M10X30	10	51028.100.030
M3X45*	500	51028.030.045	M6X18*	200	51028.060.018	M10X35	10	51028.100.035
M3X50*	200	51028.030.050	M6X20	25	51028.060.020	M10X40	10	51028.100.040
			M6X22	200	51028.060.022	M10X45*	100	51028.100.045
M4X4*	1000	51028.040.004	M6X25	25	51028.060.025	M10X50*	50	51028.100.050
M4X5*	1000	51028.040.005	M6X30	25	51028.060.030	M10X55*	50	51028.100.055
M4X6	50	51028.040.006	M6X35	25	51028.060.035	M10X60*	50	51028.100.060
M4X8	50	51028.040.008	M6X40	25	51028.060.040	M10X65*	50	51028.100.065
M4X10	50	51028.040.010	M6X45	100	51028.060.045	M10X70*	50	51028.100.070
M4X12	50	51028.040.012	M6X50	100	51028.060.050	M10X75*	50	51028.100.075
M4X14*	1000	51028.040.014	M6X55*	100	51028.060.055	M10X80*	50	51028.100.080
M4X16	50	51028.040.016	M6X60	100	51028.060.060	M10X90*	50	51028.100.090
M4X18*	1000	51028.040.018	M6X65*	100	51028.060.065	M10X100*	50	51028.100.100
M4X20	50	51028.040.020	M6X70*	100	51028.060.070	M10X110*	50	51028.100.110
M4X22*	500	51028.040.022	M6X75*	100	51028.060.075	M10X120*	50	51028.100.120
M4X25	50	51028.040.025	M6X80*	100	51028.060.080			
M4X30	50	51028.040.030	M6X90*	100	51028.060.090	M12X16*	50	51028.120.016
M4X35*	200	51028.040.035	M6X100*	100	51028.060.100	M12X18*	50	51028.120.018
M4X40*	200	51028.040.040	M6X120*	100	51028.060.120	M12X20*	50	51028.120.020
M4X45*	200	51028.040.045				M12X25*	50	51028.120.025
M4X50*	200	51028.040.050	M8X8*	500	51028.080.008	M12X30*	50	51028.120.030
M4X55*	200	51028.040.055	M8X10	25	51028.080.010	M12X35*	50	51028.120.035
M4X60*	100	51028.040.060	M8X12	25	51028.080.012	M12X40*	50	51028.120.040
			M8X14*	200	51028.080.014	M12X45*	50	51028.120.045
M5X5	500	51028.050.005	M8X16	25	51028.080.016	M12X50*	50	51028.120.050
M5X6*	500	51028.050.006	M8X18*	200	51028.080.018	M12X55*	50	51028.120.055
M5X8	50	51028.050.008	M8X20	25	51028.080.020	M12X60*	50	51028.120.060
M5X10	50	51028.050.010	M8X22*	200	51028.080.022	M12X65*	50	51028.120.065
M5X12	50	51028.050.012	M8X25	25	51028.080.025	M12X70*	50	51028.120.070
M5X14*	500	51028.050.014	M8X30	25	51028.080.030	M12X75*	25	51028.120.075
M5X16	50	51028.050.016	M8X35	25	51028.080.035	M12X80*	25	51028.120.080
M5X18*	500	51028.050.018	M8X40	25	51028.080.040	M12X90*	25	51028.120.090
M5X20	50	51028.050.020	M8X45	100	51028.080.045	M12X100*	25	51028.120.100
M5X22*	500	51028.050.022	M8X50	100	51028.080.050	M12X110*	25	51028.120.110
M5X25	25	51028.050.025	M8X55*	100	51028.080.055	M12X120*	25	51028.120.120
M5X30	25	51028.050.030	M8X60*	100	51028.080.060			
M5X35	200	51028.050.035	M8X65*	100	51028.080.065			

55025 Hexagon socket button head screw with flange		R49A
Thread	Metric thread	
Material	Stainless steel A4	
		

d x L	✉	Art.number	d x L	✉	Art.number	d x L	✉	Art.number
M3X3*	1000	55025.030.003	M5X12*	500	55025.050.012	M8X10*	500	55025.080.010
M3X4*	1000	55025.030.004	M5X14*	500	55025.050.014	M8X12*	500	55025.080.012
M3X5*	1000	55025.030.005	M5X16*	500	55025.050.016	M8X14*	200	55025.080.014
M3X6*	1000	55025.030.006	M5X18*	500	55025.050.018	M8X16*	200	55025.080.016
M3X8*	1000	55025.030.008	M5X20*	500	55025.050.020	M8X18*	200	55025.080.018
M3X10*	1000	55025.030.010	M5X22*	500	55025.050.022	M8X20*	200	55025.080.020
M3X12*	1000	55025.030.012	M5X25*	200	55025.050.025	M8X22*	200	55025.080.022
M3X14*	1000	55025.030.014	M5X30*	200	55025.050.030	M8X25*	100	55025.080.025
M3X16*	1000	55025.030.016	M5X35*	200	55025.050.035	M8X30*	100	55025.080.030
M3X18*	1000	55025.030.018	M5X40*	200	55025.050.040	M8X35*	100	55025.080.035
M3X20*	1000	55025.030.020	M5X45*	200	55025.050.045	M8X40*	100	55025.080.040
M3X22*	1000	55025.030.022	M5X50*	200	55025.050.050	M8X45*	100	55025.080.045
M3X25*	1000	55025.030.025	M5X60*	100	55025.050.060	M8X50*	100	55025.080.050
M3X30*	1000	55025.030.030				M8X55*	100	55025.080.055
			M6X6*	500	55025.060.006	M8X60*	100	55025.080.060
M4X4*	1000	55025.040.004	M6X8*	500	55025.060.008	M8X65*	100	55025.080.065
M4X5*	1000	55025.040.005	M6X10*	500	55025.060.010	M8X70*	100	55025.080.070
M4X6*	1000	55025.040.006	M6X12*	200	55025.060.012	M8X75*	100	55025.080.075
M4X8*	1000	55025.040.008	M6X14*	200	55025.060.014	M8X80*	100	55025.080.080
M4X10*	1000	55025.040.010	M6X16*	200	55025.060.016	M8X90*	100	55025.080.090
M4X12*	1000	55025.040.012	M6X18*	200	55025.060.018	M8X100*	50	55025.080.100
M4X14*	1000	55025.040.014	M6X20*	200	55025.060.020			
M4X16*	1000	55025.040.016	M6X22*	200	55025.060.022	M10X12*	100	55025.100.012
M4X18*	1000	55025.040.018	M6X25*	200	55025.060.025	M10X16*	100	55025.100.016
M4X20*	500	55025.040.020	M6X30*	200	55025.060.030	M10X20*	100	55025.100.020
M4X22*	500	55025.040.022	M6X35*	200	55025.060.035	M10X25*	100	55025.100.025
M4X25*	500	55025.040.025	M6X40*	200	55025.060.040	M10X30*	100	55025.100.030
M4X30*	500	55025.040.030	M6X45*	100	55025.060.045	M10X35*	100	55025.100.035
M4X35*	200	55025.040.035	M6X50*	100	55025.060.050	M10X40*	100	55025.100.040
M4X40*	200	55025.040.040	M6X55*	100	55025.060.055	M10X45*	100	55025.100.045
M4X45*	200	55025.040.045	M6X60*	100	55025.060.060	M10X50*	50	55025.100.050
M4X50*	200	55025.040.050	M6X65*	100	55025.060.065	M10X55*	50	55025.100.055
			M6X70*	100	55025.060.070	M10X60*	50	55025.100.060
M5X5*	500	55025.050.005	M6X75*	100	55025.060.075	M10X80*	50	55025.100.080
M5X6*	500	55025.050.006				M10X90*	50	55025.100.090
M5X8*	500	55025.050.008	M8X8*	500	55025.080.008	M10X100*	50	55025.100.100
M5X10*	500	55025.050.010						

Hexalobular button head screw with flange

2

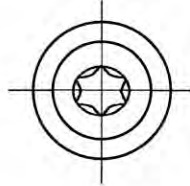
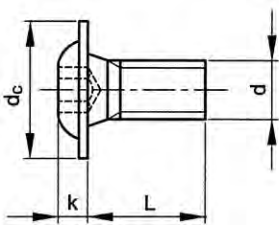

ISO ≈7380-2

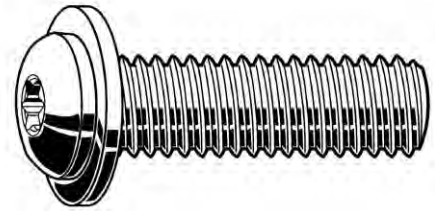

Technical Data

d	d _c (max.)	k (max.)	P	Socket
M3	6.9	1.65	0.5	T10
M4	9.4	2.2	0.7	T20
M5	11.8	2.75	0.8	T25
M6	13.6	3.3	1	T30
M8	17.8	4.4	1.25	T40
M10	21.9	5.5	1.50	T50

- Due to the unfavourable geometry of the head, these fasteners do have reduced loadability.
- For the stainless steel fasteners it is indicated by only marking the steel grade and by leaving out the property class 70 (e.g. A2-70 → A2).

51041 Hexalobular button head screw with flange

Q05A

Thread Metric thread
Material Stainless steel A2

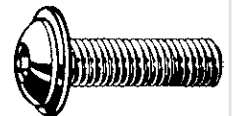

d x L	☒	Art.number	d x L	☒	Art.number	d x L	☒	Art.number
M3X4*	1000	51041.030.004	M5X6*	500	51041.050.006	M6X40*	200	51041.060.040
M3X5*	1000	51041.030.005	M5X8*	500	51041.050.008	M6X45*	100	51041.060.045
M3X6*	1000	51041.030.006	M5X10	500	51041.050.010	M6X50*	100	51041.060.050
M3X8*	1000	51041.030.008	M5X12	500	51041.050.012	M6X55*	100	51041.060.055
M3X10*	1000	51041.030.010	M5X14*	500	51041.050.014	M6X60*	100	51041.060.060
M3X12*	1000	51041.030.012	M5X16*	500	51041.050.016			
M3X14*	1000	51041.030.014	M5X18*	500	51041.050.018	M8X8*	500	51041.080.008
M3X16*	1000	51041.030.016	M5X20*	500	51041.050.020	M8X10*	200	51041.080.010
M3X18*	1000	51041.030.018	M5X22*	500	51041.050.022	M8X12*	200	51041.080.012
M3X20*	1000	51041.030.020	M5X25*	500	51041.050.025	M8X16*	200	51041.080.016
M3X22*	1000	51041.030.022	M5X30*	200	51041.050.030	M8X20*	200	51041.080.020
M3X25*	1000	51041.030.025	M5X35*	200	51041.050.035	M8X25*	100	51041.080.025
			M5X40*	200	51041.050.040	M8X30*	100	51041.080.030
M4X4*	1000	51041.040.004	M5X45*	200	51041.050.045	M8X35*	100	51041.080.035
M4X5*	1000	51041.040.005	M5X50*	200	51041.050.050	M8X40*	100	51041.080.040
M4X6*	1000	51041.040.006	M5X60*	100	51041.050.060	M8X45*	100	51041.080.045
M4X8*	1000	51041.040.008				M8X50*	100	51041.080.050
M4X10*	1000	51041.040.010	M6X6*	500	51041.060.006	M8X55*	100	51041.080.055
M4X12*	1000	51041.040.012	M6X8*	500	51041.060.008	M8X60*	100	51041.080.060
M4X14*	1000	51041.040.014	M6X10*	500	51041.060.010	M8X70*	100	51041.080.070
M4X16*	1000	51041.040.016	M6X12*	500	51041.060.012	M8X80*	100	51041.080.080
M4X20*	500	51041.040.020	M6X14*	500	51041.060.014			
M4X22*	500	51041.040.022	M6X16*	200	51041.060.016	M10X16*	100	51041.100.016
M4X25*	500	51041.040.025	M6X18*	200	51041.060.018	M10X20*	100	51041.100.020
M4X30*	500	51041.040.030	M6X20*	200	51041.060.020	M10X25*	100	51041.100.025
M4X35*	200	51041.040.035	M6X22*	200	51041.060.022	M10X30*	100	51041.100.030
M4X40*	200	51041.040.040	M6X25*	200	51041.060.025	M10X35*	100	51041.100.035
			M6X30*	200	51041.060.030	M10X60*	50	51041.100.060
M5X5*	500	51041.050.005	M6X35*	200	51041.060.035			

Self-locking hexagon socket head cap screw with flange

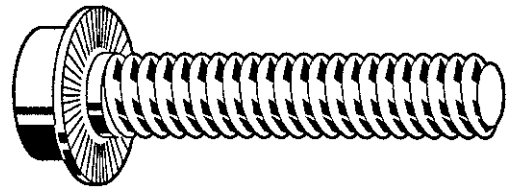
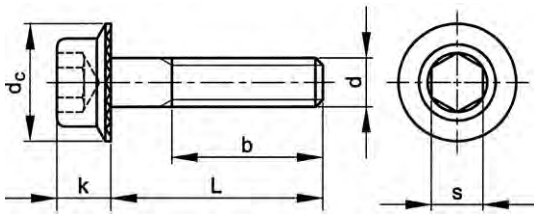

2

Technical Data

d	b	d _c (max.)	Full thread L ≤	k (max.)	P	s
M5	22	11	-	5	0.8	4
M6	24	13.5	25	6	1	5
M8	28	17	30	8	1.25	6
M10	32	19.5	35	10	1.5	8
M12	36	22.5	35	12	1.75	10

- RIPP self-locking hexagon bolts with flange are designated with the property class 100 with a min. tensile strength of 1040 N/mm², they are casehardened and therefore cannot be classified in the usual class 10.9.

Special features of RIPP self-locking hexagon bolts with flange:

- the serrated flange eliminates surface damage during assembly, prevents self-loosening and reduces relaxation
- the flange enables built up forces under the bolt head to be spread over a larger area, consequently resulting in a lower surface pressure
- large holes (oversized) and/or tooling holes can be covered by the flange
- a washer and/or a locking element is not necessary

ASSEMBLY PRE-LOAD F_M in kN and TIGHTENING TORQUE M_A in Nm

Class	Mating material	M5		M6		M8		M10		M12	
		F_M	M_A	F_M	M_A	F_M	M_A	F_M	M_A	F_M	M_A
100	Steel ($R_m < 800 \text{ N/mm}^2$)	9	13	12,6	24	23,2	45	37	90	54	150
	Steel ($R_m \geq 800 \text{ N/mm}^2$)	9	11	12,6	20	23,2	42	37	85	54	140
	Malleable iron	9	10	12,6	19	23,2	39	37	80	54	120

07095 RIPP Self-locking hexagon socket head cap screw with flange

D93A

Thread Metric thread
Material Steel
Class 100



d x L	Art.number	d x L	Art.number	d x L	Art.number
M5X10	500 07095.050.010	M8X12	200 07095.080.012	M10X35	100 07095.100.035
M5X12	500 07095.050.012	M8X16	200 07095.080.016	M10X40	100 07095.100.040
M5X16	500 07095.050.016	M8X20	200 07095.080.020	M12X20	100 07095.120.020
M5X20	500 07095.050.020	M8X25	200 07095.080.025	M12X25	100 07095.120.025
M6X10	500 07095.060.010	M8X30	200 07095.080.030	M12X30	100 07095.120.030
M6X12	500 07095.060.012	M8X40	200 07095.080.040	M12X35	100 07095.120.035
M6X16	500 07095.060.016	M10X20	200 07095.100.020	M12X40	100 07095.120.040
M6X20	500 07095.060.020	M10X25	200 07095.100.025	M12X45	100 07095.120.045
M6X25	500 07095.060.025	M10X30	200 07095.100.030	M12X50	100 07095.120.050
M6X30	500 07095.060.030				

- Warning: electro-galvanizing of these products may cause hydrogen embrittlement.

Hexagon socket head shoulder screw f9

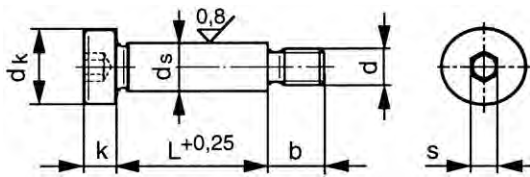

ISO ≈7379
 ASME ≈B18.3.3M
 BS ≈4168-7



Technical Data

d	Tolerance f9 (min.)	Tolerance f9 (max.)	b	dk (max.)	ds (nom.)	k (max.)	P	s
M5	5.960	5.990	9.5	10.22	6	4.5	0.8	3
M6	7.951	7.987	11	13.27	8	5.5	1	4
M8	9.951	9.987	13	16.27	10	7	1.25	5
M10	11.941	11.984	16	18.27	12	9	1.5	6
M12	15.941	15.984	18	24.33	16	11	1.75	8
M16	19.928	19.980	22	30.33	20	14	2	10
M20	23.928	23.980	27	36.39	24	16	2.5	12

- Due to the unfavourable geometry of the head, these fasteners do have reduced loadability.
- When steel fasteners (e.g. 8.8 / 10.9 / 12.9) with reduced loadability needs to be marked, the marking symbol for the property class is preceded by the digit '0'. So 8.8 → 08.8 and 10.9 → 010.9 and 12.9 → 012.9.
- For the stainless steel fasteners it is indicated by only marking the steel grade and by leaving out the property class 70 (e.g. A2-70 → A2).
- The former and the new indications can occur side by side for some time.

Example of application

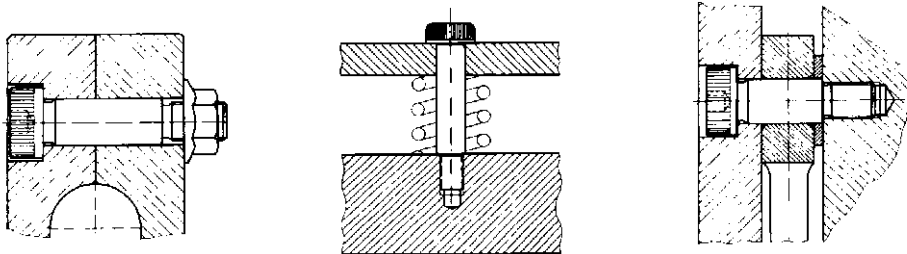

Article groups

Thread	Driving features	Material	Class	Code	Page
M	Hexagon socket	St	012.9	07111	2-64
M	Hexagon socket	St.St. A2		51044	2-65

07111 Hexagon socket head shoulder screw f9

D93A

Thread Metric thread
 Material Steel
 Class 012.9



(d) d _s x L	☒	Art.number	(d) d _s x L	☒	Art.number	(d) d _s x L	☒	Art.number
M5 6X6	50	07111.050.006	M6 8X45	50	07111.060.045	M10 12X12	25	07111.100.012
M5 6X8	50	07111.050.008	M6 8X50	50	07111.060.050	M10 12X16	25	07111.100.016
M5 6X10	50	07111.050.010	M6 8X60	50	07111.060.060	M10 12X20	25	07111.100.020
M5 6X12	50	07111.050.012	M6 8X70	50	07111.060.070	M10 12X25	25	07111.100.025
M5 6X16	50	07111.050.016	M8 10X10	50	07111.080.010	M10 12X30	25	07111.100.030
M5 6X20	50	07111.050.020	M8 10X12	50	07111.080.012	M10 12X35	25	07111.100.035
M5 6X25	50	07111.050.025	M8 10X16	50	07111.080.016	M10 12X40	25	07111.100.040
M5 6X30	50	07111.050.030	M8 10X20	50	07111.080.020	M10 12X45	25	07111.100.045
M5 6X35	50	07111.050.035	M8 10X25	50	07111.080.025	M10 12X50	25	07111.100.050
M5 6X40	50	07111.050.040	M8 10X30	50	07111.080.030	M10 12X55	25	07111.100.055
M5 6X45	50	07111.050.045	M8 10X35	50	07111.080.035	M10 12X60	25	07111.100.060
M5 6X50	50	07111.050.050	M8 10X40	50	07111.080.040	M10 12X70	25	07111.100.070
M6 8X8	50	07111.060.008	M8 10X45	50	07111.080.045	M10 12X80	25	07111.100.080
M6 8X10	50	07111.060.010	M8 10X50	50	07111.080.050	M10 12X90	25	07111.100.090
M6 8X12	50	07111.060.012	M8 10X55	50	07111.080.055	M10 12X100	25	07111.100.100
M6 8X16	50	07111.060.016	M8 10X60	50	07111.080.060	M10 12X120	25	07111.100.120
M6 8X20	50	07111.060.020	M8 10X70	50	07111.080.070	M12 16X20	25	07111.120.020
M6 8X25	50	07111.060.025	M8 10X80	50	07111.080.080	M12 16X25	25	07111.120.025
M6 8X30	50	07111.060.030	M8 10X90	50	07111.080.090	M12 16X30	25	07111.120.030
M6 8X35	50	07111.060.035	M8 10X100	25	07111.080.100	M12 16X35	25	07111.120.035
M6 8X40	50	07111.060.040	M8 10X120	25	07111.080.120			

07111 Hexagon socket head shoulder screw f9								
(d) d _s x L	☒	Art.number	(d) d _s x L	☒	Art.number	(d) d _s x L	☒	Art.number
M12 16X40	25	07111.120.040	M16 20X30	10	07111.160.030	M16 20X120	10	07111.160.120
M12 16X45	25	07111.120.045	M16 20X35	10	07111.160.035			
M12 16X50	25	07111.120.050	M16 20X40	10	07111.160.040	M20 24X50	5	07111.200.050
M12 16X55	25	07111.120.055	M16 20X45	10	07111.160.045	M20 24X55	5	07111.200.055
M12 16X60	25	07111.120.060	M16 20X50	10	07111.160.050	M20 24X60	5	07111.200.060
M12 16X70	25	07111.120.070	M16 20X55	10	07111.160.055	M20 24X70	5	07111.200.070
M12 16X80	25	07111.120.080	M16 20X60	10	07111.160.060	M20 24X80	5	07111.200.080
M12 16X90	25	07111.120.090	M16 20X70	10	07111.160.070	M20 24X90	5	07111.200.090
M12 16X100	25	07111.120.100	M16 20X80	10	07111.160.080	M20 24X100	5	07111.200.100
M12 16X120	25	07111.120.120	M16 20X90	10	07111.160.090	M20 24X120	5	07111.200.120
			M16 20X100	10	07111.160.100			

• Warning: electro-galvanizing of these products may cause hydrogen embrittlement.

51044 Hexagon socket head shoulder screw f9		Q05A
Thread	Metric thread	
Material	Stainless steel A2	
		
		

(d) d _s x L	☒	Art.number	(d) d _s x L	☒	Art.number	(d) d _s x L	☒	Art.number
(M5)6X10	10	51044.050.010	(M8)10X20	10	51044.080.020	(M10)12X80	5	51044.100.080
(M5)6X12	10	51044.050.012	(M8)10X25	10	51044.080.025	(M10)12X100	5	51044.100.100
(M5)6X16	10	51044.050.016	(M8)10X30	10	51044.080.030			
(M5)6X20	10	51044.050.020	(M8)10X40	10	51044.080.040	(M12)16X30	5	51044.120.030
(M5)6X25	10	51044.050.025	(M8)10X50	10	51044.080.050	(M12)16X40	5	51044.120.040
(M5)6X30	10	51044.050.030	(M8)10X60	10	51044.080.060	(M12)16X50	5	51044.120.050
(M5)6X40	10	51044.050.040	(M8)10X70	10	51044.080.070	(M12)16X60	5	51044.120.060
			(M8)10X80	10	51044.080.080	(M12)16X70	5	51044.120.070
(M6)8X12	10	51044.060.012				(M12)16X80	5	51044.120.080
(M6)8X16	10	51044.060.016	(M10)12X16	5	51044.100.016	(M12)16X100	5	51044.120.100
(M6)8X20	10	51044.060.020	(M10)12X20	5	51044.100.020			
(M6)8X25	10	51044.060.025	(M10)12X25	5	51044.100.025	(M16)20X40	3	51044.160.040
(M6)8X30	10	51044.060.030	(M10)12X30	5	51044.100.030	(M16)20X50	3	51044.160.050
(M6)8X40	10	51044.060.040	(M10)12X40	5	51044.100.040	(M16)20X60	3	51044.160.060
(M6)8X50	10	51044.060.050	(M10)12X50	5	51044.100.050	(M16)20X70	3	51044.160.070
			(M10)12X60	5	51044.100.060	(M16)20X80	3	51044.160.080
(M8)10X16	10	51044.080.016	(M10)12X70	5	51044.100.070			

Hexagon socket head shoulder screw UNC

2

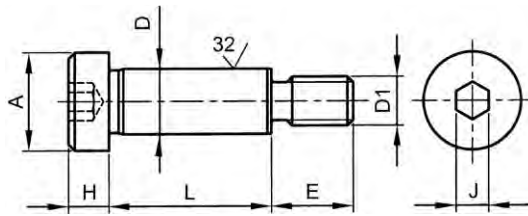

ASME B18.3
BS 2470



Technical Data

D	A (max.)	E	H (max.)	J	Threads per inch
1/4	0.375	0.375	0.188	1/8	24
5/16	0.438	0.438	0.219	5/32	20
3/8	0.562	0.500	0.250	3/16	18
1/2	0.750	0.625	0.312	1/4	16
5/8	0.875	0.750	0.375	5/16	13
3/4	1.000	0.875	0.500	3/8	11
1 Inch	1.312	1.000	0.625	1/2	10

- Due to the unfavourable geometry of the head, these fasteners do have reduced loadability.
- When steel fasteners (e.g. 8.8 / 10.9 / 12.9) with reduced loadability needs to be marked, the marking symbol for the property class is preceded by the digit '0'. So 8.8 → 08.8 and 10.9 → 010.9 and 12.9 → 012.9.
- For the stainless steel fasteners it is indicated by only marking the steel grade and by leaving out the property class 70 (e.g. A2-70 → A2).
- The former and the new indications can occur side by side for some time.

Example of application

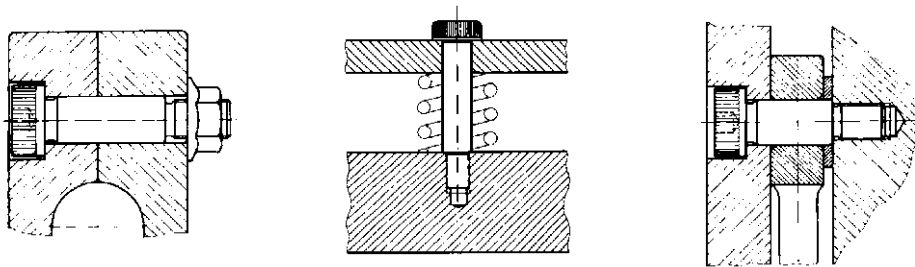

Article groups

Thread	Driving features	Material	Class	Code	Page
UNC	Hexagon socket	St	Grade 5	U07111	2-66
UNC	Hexagon socket	St	012.9	07116	2-67
UNC	Hexagon socket	St.St. A2 (AISI304/18-8)		U51044	2-67

U07111 Hexagon socket head shoulder screw UNC

X05A

Thread Unified National Coarse
Material Steel
Class Grade 5



(D ₁) Dx L	Art.number	(D ₁) Dx L	Art.number	(D ₁) Dx L	Art.number
(10-24)1/4X1/4*	25 U07111.025.0025	(1/4-20)5/16X1 Inch*	10 U07111.031.0100	(5/16-18)3/8X2 1/2*	5 U07111.037.0250
(10-24)1/4X3/8*	25 U07111.025.0037	(1/4-20)5/16X1.1/4*	10 U07111.031.0125	(5/16-18)3/8X2 3/4*	5 U07111.037.0275
(10-24)1/4X1/2*	25 U07111.025.0050	(1/4-20)5/16X1.1/2*	5 U07111.031.0150	(5/16-18)3/8X3 Inch*	5 U07111.037.0300
(10-24)1/4X5/8*	25 U07111.025.0062	(1/4-20)5/16X1.3/4*	5 U07111.031.0175	(5/16-18)3/8X3 1/4*	5 U07111.037.0325
(10-24)1/4X3/4*	25 U07111.025.0075	(1/4-20)5/16X2 Inch*	5 U07111.031.0200	(5/16-18)3/8X3 1/2*	5 U07111.037.0350
(10-24)1/4X7/8*	10 U07111.025.0087	(1/4-20)5/16X2 1/4*	5 U07111.031.0225	(5/16-18)3/8X3 3/4*	5 U07111.037.0375
(10-24)1/4X1 Inch*	10 U07111.025.0100	(1/4-20)5/16X2 1/2*	5 U07111.031.0250	(5/16-18)3/8X4 Inch*	5 U07111.037.0400
(10-24)1/4X1.1/4*	10 U07111.025.0125	(1/4-20)5/16X3 Inch*	5 U07111.031.0300	(5/16-18)3/8X4 1/2*	5 U07111.037.0450
(10-24)1/4X1.1/2*	10 U07111.025.0150			(5/16-18)3/8X5 Inch*	5 U07111.037.0500
(10-24)1/4X1.3/4*	10 U07111.025.0175	(5/16-18)3/8X1/4*	10 U07111.037.0025	(5/16-18)3/8X6 Inch*	5 U07111.037.0600
(10-24)1/4X2 Inch*	10 U07111.025.0200	(5/16-18)3/8X3/8*	10 U07111.037.0037		
(10-24)1/4X2 1/4*	10 U07111.025.0225	(5/16-18)3/8X1/2*	10 U07111.037.0050	(3/8-16)1/2X3/8*	5 U07111.050.0037
(10-24)1/4X2 1/2*	10 U07111.025.0250	(5/16-18)3/8X5/8*	10 U07111.037.0062	(3/8-16)1/2X1/2*	5 U07111.050.0050
(10-24)1/4X3 Inch*	10 U07111.025.0300	(5/16-18)3/8X3/4*	10 U07111.037.0075	(3/8-16)1/2X5/8*	5 U07111.050.0062
		(5/16-18)3/8X7/8*	10 U07111.037.0087	(3/8-16)1/2X3/4*	5 U07111.050.0075
(1/4-20)5/16X1/4*	10 U07111.031.0025	(5/16-18)3/8X1 Inch*	10 U07111.037.0100	(3/8-16)1/2X7/8*	5 U07111.050.0087
(1/4-20)5/16X3/8*	10 U07111.031.0037	(5/16-18)3/8X1.1/4*	10 U07111.037.0125	(3/8-16)1/2X1 Inch*	5 U07111.050.0100
(1/4-20)5/16X1/2*	10 U07111.031.0050	(5/16-18)3/8X1.1/2*	10 U07111.037.0150	(3/8-16)1/2X1.1/4*	5 U07111.050.0125
(1/4-20)5/16X5/8*	10 U07111.031.0062	(5/16-18)3/8X1.3/4*	10 U07111.037.0175	(3/8-16)1/2X1.1/2*	5 U07111.050.0150
(1/4-20)5/16X3/4*	10 U07111.031.0075	(5/16-18)3/8X2 Inch*	10 U07111.037.0200	(3/8-16)1/2X1.3/4*	5 U07111.050.0175
(1/4-20)5/16X7/8*	10 U07111.031.0087	(5/16-18)3/8X2 1/4*	5 U07111.037.0225	(3/8-16)1/2X2 Inch*	5 U07111.050.0200

U07111 Hexagon socket head shoulder screw UNC								
(D ₁) Dx L	☒	Art.number	(D ₁) Dx L	☒	Art.number	(D ₁) Dx L	☒	Art.number
(3/8-16)1/2X2 1/4*	5	U07111.050.0225	(1/2-13)5/8X3 1/4*	1	U07111.062.0325	(5/8-11)3/4X3 1/2*	1	U07111.075.0350
(3/8-16)1/2X2 1/2*	5	U07111.050.0250	(1/2-13)5/8X3 1/2*	1	U07111.062.0350	(5/8-11)3/4X3 3/4*	1	U07111.075.0375
(3/8-16)1/2X2 3/4*	5	U07111.050.0275	(1/2-13)5/8X3 3/4*	1	U07111.062.0375	(5/8-11)3/4X4 Inch*	1	U07111.075.0400
(3/8-16)1/2X3 Inch*	5	U07111.050.0300	(1/2-13)5/8X4 Inch*	1	U07111.062.0400	(5/8-11)3/4X4 1/4*	1	U07111.075.0425
(3/8-16)1/2X3 1/4*	5	U07111.050.0325	(1/2-13)5/8X4 1/4*	1	U07111.062.0425	(5/8-11)3/4X4 1/2*	1	U07111.075.0450
(3/8-16)1/2X3 1/2*	5	U07111.050.0350	(1/2-13)5/8X4 1/2*	1	U07111.062.0450	(5/8-11)3/4X4 3/4*	1	U07111.075.0475
(3/8-16)1/2X3 3/4*	5	U07111.050.0375	(1/2-13)5/8X4 3/4*	1	U07111.062.0475	(5/8-11)3/4X5 Inch*	1	U07111.075.0500
(3/8-16)1/2X4 Inch*	5	U07111.050.0400	(1/2-13)5/8X5 Inch*	1	U07111.062.0500	(5/8-11)3/4X5 1/2*	1	U07111.075.0550
(3/8-16)1/2X4 1/4*	5	U07111.050.0425	(1/2-13)5/8X5 1/2*	1	U07111.062.0550	(5/8-11)3/4X6 Inch*	1	U07111.075.0600
(3/8-16)1/2X4 1/2*	5	U07111.050.0450	(1/2-13)5/8X6 Inch*	1	U07111.062.0600	(5/8-11)3/4X7 Inch*	1	U07111.075.0700
(3/8-16)1/2X4 3/4*	5	U07111.050.0475				(5/8-11)3/4X8 Inch*	1	U07111.075.0800
(3/8-16)1/2X5 Inch*	5	U07111.050.0500	(5/8-11)3/4X1/2*	1	U07111.075.0050	(3/4-10)1X1 Inch*	1	U07111.100.0100
(3/8-16)1/2X5 1/2*	1	U07111.050.0550	(5/8-11)3/4X3/4*	1	U07111.075.0075	(3/4-10)1X1.1/2*	1	U07111.100.0150
(3/8-16)1/2X6 Inch*	1	U07111.050.0600	(5/8-11)3/4X1 Inch*	1	U07111.075.0100	(3/4-10)1X1.3/4*	1	U07111.100.0175
			(5/8-11)3/4X1.1/4*	1	U07111.075.0125	(3/4-10)1X2 Inch*	1	U07111.100.0200
(1/2-13)5/8X1.1/4*	5	U07111.062.0125	(5/8-11)3/4X1.1/2*	1	U07111.075.0150	(3/4-10)1X2 1/2*	1	U07111.100.0250
(1/2-13)5/8X1.1/2*	1	U07111.062.0150	(5/8-11)3/4X1.3/4*	1	U07111.075.0175	(3/4-10)1X3 Inch*	1	U07111.100.0300
(1/2-13)5/8X1.3/4*	1	U07111.062.0175	(5/8-11)3/4X2 Inch*	1	U07111.075.0200	(3/4-10)1X3 1/2*	1	U07111.100.0350
(1/2-13)5/8X2 Inch*	1	U07111.062.0200	(5/8-11)3/4X2 1/4*	1	U07111.075.0225	(3/4-10)1X4 Inch*	1	U07111.100.0400
(1/2-13)5/8X2 1/4*	1	U07111.062.0225	(5/8-11)3/4X2 1/2*	1	U07111.075.0250	(3/4-10)1X5 Inch*	1	U07111.100.0500
(1/2-13)5/8X2 1/2*	1	U07111.062.0250	(5/8-11)3/4X3 1/4*	1	U07111.075.0275	(3/4-10)1X6 Inch*	1	U07111.100.0600
(1/2-13)5/8X2 3/4*	1	U07111.062.0275	(5/8-11)3/4X3 Inch*	1	U07111.075.0300			
(1/2-13)5/8X3 Inch*	1	U07111.062.0300	(5/8-11)3/4X3 1/4*	1	U07111.075.0325			

U07116 Hexagon socket head shoulder screw UNC			X05A		
Thread	Unified National Coarse				
Material	Steel				
Class	012.9				

(D ₁) Dx L	☒	Art.number	(D ₁) Dx L	☒	Art.number	(D ₁) Dx L	☒	Art.number
(NO.10)1/4X3/4	25	07116.048.019	(5/16)3/8X1 Inch	10	07116.079.025	(3/8)1/2X4 Inch	5	07116.096.101
(NO.10)1/4X1 Inch	25	07116.048.025	(5/16)3/8X1.1/4	10	07116.079.031	(1/2)5/8X1.1/4	5	07116.127.031
(NO.10)1/4X1.1/4	25	07116.048.031	(5/16)3/8X1.1/2	10	07116.079.038	(1/2)5/8X1.1/2	5	07116.127.038
(NO.10)1/4X1.1/2	10	07116.048.038	(5/16)3/8X1.3/4	10	07116.079.044	(1/2)5/8X2 Inch	5	07116.127.050
(NO.10)1/4X2 Inch	10	07116.048.050	(5/16)3/8X2 Inch	10	07116.079.050	(1/2)5/8X2.1/2	5	07116.127.063
			(5/16)3/8X2.1/2	10	07116.079.063	(1/2)5/8X3 Inch	5	07116.127.076
(1/4)5/16X1 Inch	25	07116.063.025	(5/16)3/8X3 Inch	10	07116.079.076	(1/2)5/8X3.1/2	3	07116.127.088
(1/4)5/16X1.1/4	25	07116.063.031				(1/2)5/8X4 Inch	3	07116.127.101
(1/4)5/16X1.1/2	25	07116.063.038	(3/8)1/2X1 Inch	10	07116.096.025			
(1/4)5/16X1.3/4	10	07116.063.044	(3/8)1/2X1.1/4	10	07116.096.031	(5/8)3/4X2 Inch	3	07116.158.050
(1/4)5/16X2 Inch	10	07116.063.050	(3/8)1/2X1.1/2	10	07116.096.038	(5/8)3/4X2.1/2	3	07116.158.063
(1/4)5/16X2.1/4	10	07116.063.057	(3/8)1/2X2 Inch	10	07116.096.050	(5/8)3/4X3 Inch	3	07116.158.076
(1/4)5/16X2.1/2	10	07116.063.063	(3/8)1/2X2.1/2	5	07116.096.063	(5/8)3/4X3.1/2	3	07116.158.088
			(3/8)1/2X3 Inch	5	07116.096.076	(5/8)3/4X4 Inch	3	07116.158.101
(5/16)3/8X3/4	10	07116.079.019	(3/8)1/2X3.1/2	5	07116.096.088			

• Warning: electro-galvanizing of these products may cause hydrogen embrittlement.

U51044 Hexagon socket head shoulder screw UNC			X15A		
Thread	Unified National Coarse				
Material	Stainless steel A2 (AISI 304/18-8)				

(D ₁) Dx L	☒	Art.number	(D ₁) Dx L	☒	Art.number	(D ₁) Dx L	☒	Art.number
(10-24)1/4X1/4*	5	U51044.025.0025	(1/4-20)5/16X1/2*	5	U51044.031.0050	(5/16-18)3/8X1 Inch*	2	U51044.037.0100
(10-24)1/4X5/16*	5	U51044.025.0031	(1/4-20)5/16X5/8*	5	U51044.031.0062	(5/16-18)3/8X1.1/4*	2	U51044.037.0125
(10-24)1/4X3/8*	5	U51044.025.0037	(1/4-20)5/16X3/4*	5	U51044.031.0075	(5/16-18)3/8X1.1/2*	2	U51044.037.0150
(10-24)1/4X1/2*	5	U51044.025.0050	(1/4-20)5/16X1 Inch*	5	U51044.031.0100			
(10-24)1/4X5/8*	5	U51044.025.0062	(1/4-20)5/16X1.1/4*	5	U51044.031.0125	(3/8-16)1/2X3/8*	5	U51044.050.0037
(10-24)1/4X3/4*	5	U51044.025.0075	(1/4-20)5/16X1.1/2*	5	U51044.031.0150	(3/8-16)1/2X1/2*	5	U51044.050.0050
(10-24)1/4X1 Inch*	5	U51044.025.0100				(3/8-16)1/2X5/8*	5	U51044.050.0062
(10-24)1/4X1.1/4*	5	U51044.025.0125	(5/16-18)3/8X1/4*	5	U51044.037.0025	(3/8-16)1/2X3/4*	5	U51044.050.0075
(10-24)1/4X1.1/2*	2	U51044.025.0150	(5/16-18)3/8X5/16*	5	U51044.037.0031	(3/8-16)1/2X1 Inch*	5	U51044.050.0100
			(5/16-18)3/8X3/8*	5	U51044.037.0037	(3/8-16)1/2X1.1/4*	5	U51044.050.0125
(1/4-20)5/16X1/4*	5	U51044.031.0025	(5/16-18)3/8X1/2*	5	U51044.037.0050	(3/8-16)1/2X1.1/2*	2	U51044.050.0150
(1/4-20)5/16X5/16*	5	U51044.031.0031	(5/16-18)3/8X5/8*	5	U51044.037.0062			
(1/4-20)5/16X3/8*	5	U51044.031.0037	(5/16-18)3/8X3/4*	5	U51044.037.0075			

Hexagon socket head shoulder screw h8

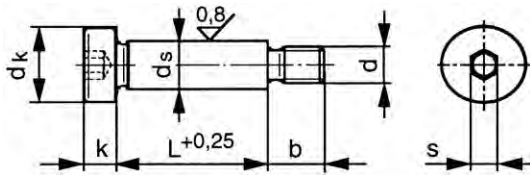

ISO ≈7379
 ASME ≈B18.3.3M
 BS ≈4168-7



Technical Data

d	Tolerance h8 (min.)	Tolerance h8 (max.)	b	dk (max.)	ds (nom.)	k (max.)	P	s
M5	5.982	6.000	9.5	10.22	6	4.5	0.8	3
M6	7.978	8.000	11	13.27	8	5.5	1	4
M8	9.978	10.000	13	16.27	10	7	1.25	5
M10	11.973	12.000	16	18.27	12	9	1.5	6
M12	15.973	16.000	18	24.33	16	11	1.75	8

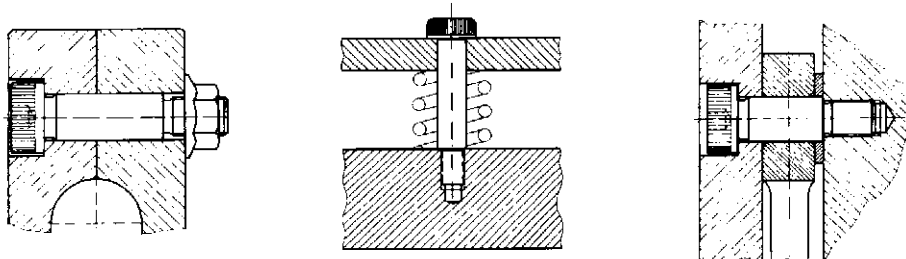

- Due to the unfavourable geometry of the head, these fasteners do have reduced loadability.
- When steel fasteners (e.g. 8.8 / 10.9 / 12.9) with reduced loadability needs to be marked, the marking symbol for the property class is preceded by the digit '0'. So 8.8 → 08.8 and 10.9 → 010.9 and 12.9 → 012.9.
- For the stainless steel fasteners it is indicated by only marking the steel grade and by leaving out the property class 70 (e.g. A2-70 → A2).
- The former and the new indications can occur side by side for some time.

Example of application



07117 Hexagon socket head shoulder screw h8 D93A

Thread: Metric thread
 Material: Steel
 Class: 012.9

(d) ds x L	✉	Art.number	(d) ds x L	✉	Art.number	(d) ds x L	✉	Art.number
M5 6X10	50	07117.050.010	M8 10X16	50	07117.080.016	M10 12X60	25	07117.100.060
M5 6X12	50	07117.050.012	M8 10X20	50	07117.080.020	M10 12X70	25	07117.100.070
M5 6X16	50	07117.050.016	M8 10X25	50	07117.080.025	M10 12X80	25	07117.100.080
M5 6X20	50	07117.050.020	M8 10X30	50	07117.080.030	M10 12X90	25	07117.100.090
M5 6X25	50	07117.050.025	M8 10X40	50	07117.080.040	M10 12X100	25	07117.100.100
M5 6X30	50	07117.050.030	M8 10X50	50	07117.080.050	M12 16X30	25	07117.120.030
M5 6X40	50	07117.050.040	M8 10X60	50	07117.080.060	M12 16X40	25	07117.120.040
M6 8X10	50	07117.060.010	M8 10X70	50	07117.080.070	M12 16X50	25	07117.120.050
M6 8X12	50	07117.060.012	M10 12X16	25	07117.100.016	M12 16X60	25	07117.120.060
M6 8X16	50	07117.060.016	M10 12X20	25	07117.100.020	M12 16X70	25	07117.120.070
M6 8X20	50	07117.060.020	M10 12X25	25	07117.100.025	M12 16X80	25	07117.120.080
M6 8X25	50	07117.060.025	M10 12X30	25	07117.100.030	M12 16X90	25	07117.120.090
M6 8X30	50	07117.060.030	M10 12X40	25	07117.100.040	M12 16X100	25	07117.120.100
M6 8X40	50	07117.060.040	M10 12X50	25	07117.100.050	M12 16X120	25	07117.120.120
M6 8X50	50	07117.060.050						

- Warning: electro-galvanizing of these products may cause hydrogen embrittlement.

Hexagon socket set screw with cup point

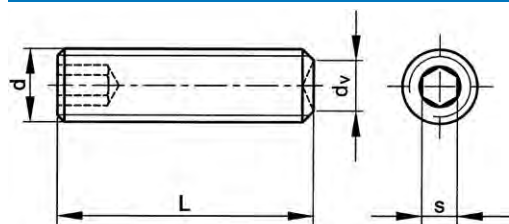

DIN 916
ISO 4029
NEN 2343
ASME B18.3.6M
NF E27-183
BS 4168-5

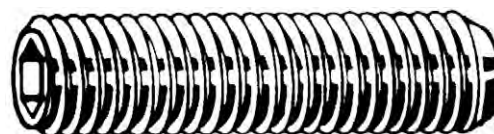

2

Technical Data

d	d _v	P	s	d	d _v	P	s
M1.6	0.8	0.35	0.7	M8	5	1.25	4
M2	1	0.4	0.9	M10	6	1.5	5
M2.5	1.2	0.45	1.3	M12	8	1.75	6
M3	1.4	0.5	1.5	M14	9	2	6
M4	2	0.7	2	M16	10	2	8
M5	2.5	0.8	2.5	M20	14	2.5	10
M6	3	1	3	M24	16	3	12

Article groups

Thread	Driving features	Material	Class	Surface treatment	Code	Page
M	Hexagon socket	St	45H		07840	2-69
M	Hexagon socket	St	45H	Zipl	07850	2-70
M	Hexagon socket	St	45H	Zipl yell.p.	07930	2-70
M	Hexagon socket	St.St. A2			51260	2-71
M	Hexagon socket	St.St. A4			55260	2-71

07840 Hexagon socket set screw with cup point

D05A



Thread Metric thread
Material Steel
Class 45H



d x L	☒	Art.number	d x L	☒	Art.number	d x L	☒	Art.number
M2X2	200	07840.020.002	M5X8	200	07840.050.008	M8X60	100	07840.080.060
M2X3	200	07840.020.003	M5X10	200	07840.050.010	M8X70	100	07840.080.070
M2X4	200	07840.020.004	M5X12	200	07840.050.012	M8X80	100	07840.080.080
M2X6	200	07840.020.006	M5X16	200	07840.050.016			
M2X8	200	07840.020.008	M5X20	200	07840.050.020	M10X8	200	07840.100.008
M2X10	200	07840.020.010	M5X25	200	07840.050.025	M10X10	200	07840.100.010
M2X12	200	07840.020.012	M5X30	200	07840.050.030	M10X12	200	07840.100.012
			M5X35	200	07840.050.035	M10X16	200	07840.100.016
M3X3	200	07840.030.003	M5X40	200	07840.050.040	M10X20	200	07840.100.020
M3X4	200	07840.030.004	M5X50	200	07840.050.050	M10X25	100	07840.100.025
M3X5	200	07840.030.005				M10X30	100	07840.100.030
M3X6	200	07840.030.006	M6X6	200	07840.060.006	M10X35	100	07840.100.035
M3X8	200	07840.030.008	M6X8	200	07840.060.008	M10X40	100	07840.100.040
M3X10	200	07840.030.010	M6X10	200	07840.060.010	M10X45	100	07840.100.045
M3X12	200	07840.030.012	M6X12	200	07840.060.012	M10X50	100	07840.100.050
M3X16	200	07840.030.016	M6X16	200	07840.060.016	M10X60	100	07840.100.060
M3X20	200	07840.030.020	M6X20	200	07840.060.020	M10X70	100	07840.100.070
M3X25	200	07840.030.025	M6X25	200	07840.060.025	M10X80	100	07840.100.080
M3X30	200	07840.030.030	M6X30	200	07840.060.030			
			M6X35	200	07840.060.035	M12X10	100	07840.120.010
M4X4	200	07840.040.004	M6X40	200	07840.060.040	M12X12	100	07840.120.012
M4X5	200	07840.040.005	M6X45	200	07840.060.045	M12X16	100	07840.120.016
M4X6	200	07840.040.006	M6X50	200	07840.060.050	M12X20	100	07840.120.020
M4X8	200	07840.040.008	M6X60	200	07840.060.060	M12X25	100	07840.120.025
M4X10	200	07840.040.010	M6X70	200	07840.060.070	M12X30	100	07840.120.030
M4X12	200	07840.040.012				M12X35	100	07840.120.035
M4X16	200	07840.040.016	M8X8	200	07840.080.008	M12X40	100	07840.120.040
M4X20	200	07840.040.020	M8X10	200	07840.080.010	M12X45	100	07840.120.045
M4X25	200	07840.040.025	M8X12	200	07840.080.012	M12X50	100	07840.120.050
M4X30	200	07840.040.030	M8X16	200	07840.080.016	M12X55	100	07840.120.055
M4X35	200	07840.040.035	M8X20	200	07840.080.020	M12X60	100	07840.120.060
M4X40	200	07840.040.040	M8X25	200	07840.080.025	M12X70	100	07840.120.070
M4X50	100	07840.040.050	M8X30	200	07840.080.030	M12X80	100	07840.120.080
			M8X35	100	07840.080.035	M12X90	100	07840.120.090
M5X4	200	07840.050.004	M8X40	100	07840.080.040	M12X100	50	07840.120.100
M5X5	200	07840.050.005	M8X45	100	07840.080.045	M12X110	50	07840.120.110
M5X6	200	07840.050.006	M8X50	100	07840.080.050			

07840 Hexagon socket set screw with cup point								
d x L	☒	Art.number	d x L	☒	Art.number	d x L	☒	Art.number
M14X16	100	07840.140.016	M16X40	50	07840.160.040	M20X65	10	07840.200.065
M14X20	100	07840.140.020	M16X45	50	07840.160.045	M20X70	10	07840.200.070
M14X25	100	07840.140.025	M16X50	50	07840.160.050	M20X80	10	07840.200.080
M14X30	50	07840.140.030	M16X60	25	07840.160.060	M20X100	10	07840.200.100
M14X35	50	07840.140.035	M16X70	25	07840.160.070	M20X120	10	07840.200.120
M14X40	50	07840.140.040	M16X80	25	07840.160.080			
M14X50	50	07840.140.050	M16X100	25	07840.160.100	M24X25	25	07840.240.025
M14X60	50	07840.140.060	M16X130	25	07840.160.130	M24X40	10	07840.240.040
M14X110	50	07840.140.110				M24X50	10	07840.240.050
			M20X20	25	07840.200.020	M24X60	10	07840.240.060
M16X16	50	07840.160.016	M20X25	10	07840.200.025	M24X70	10	07840.240.070
M16X20	50	07840.160.020	M20X30	10	07840.200.030	M24X90	10	07840.240.090
M16X25	50	07840.160.025	M20X40	10	07840.200.040	M24X100	10	07840.240.100
M16X30	50	07840.160.030	M20X50	10	07840.200.050			
M16X35	50	07840.160.035	M20X60	10	07840.200.060			

• Warning: electro-galvanizing of these products may cause hydrogen embrittlement.

07850 Hexagon socket set screw with cup point				D05A
Thread	Metric thread			
Material	Steel			
Class	45H			
Surface treatment	Zinc plated			
				

d x L	☒	Art.number	d x L	☒	Art.number	d x L	☒	Art.number
M3X4	200	07850.030.004	M6X8	200	07850.060.008	M10X16	200	07850.100.016
M3X5	200	07850.030.005	M6X10	200	07850.060.010	M10X20	200	07850.100.020
M3X6	200	07850.030.006	M6X12	200	07850.060.012	M10X25	100	07850.100.025
M3X8	200	07850.030.008	M6X16	200	07850.060.016	M10X30	100	07850.100.030
M3X10	200	07850.030.010	M6X20	200	07850.060.020	M10X35	100	07850.100.035
M3X12	200	07850.030.012	M6X25	200	07850.060.025	M10X40	100	07850.100.040
M3X16	200	07850.030.016	M6X30	200	07850.060.030	M10X50	100	07850.100.050
			M6X35	200	07850.060.035	M10X60	100	07850.100.060
M4X4	200	07850.040.004	M6X40	200	07850.060.040			
M4X5	200	07850.040.005				M12X10	100	07850.120.010
M4X6	200	07850.040.006	M8X6	200	07850.080.006	M12X12	100	07850.120.012
M4X8	200	07850.040.008	M8X8	200	07850.080.008	M12X16	100	07850.120.016
M4X10	200	07850.040.010	M8X10	200	07850.080.010	M12X20	100	07850.120.020
M4X12	200	07850.040.012	M8X12	200	07850.080.012	M12X25	100	07850.120.025
M4X16	200	07850.040.016	M8X16	200	07850.080.016	M12X30	100	07850.120.030
M4X20	200	07850.040.020	M8X20	200	07850.080.020	M12X35	100	07850.120.035
			M8X25	200	07850.080.025	M12X40	100	07850.120.040
M5X6	200	07850.050.006	M8X30	200	07850.080.030	M12X50	100	07850.120.050
M5X8	200	07850.050.008	M8X35	100	07850.080.035	M12X60	100	07850.120.060
M5X10	200	07850.050.010	M8X40	100	07850.080.040			
M5X12	200	07850.050.012	M8X50	100	07850.080.050	M16X20	50	07850.160.020
M5X16	200	07850.050.016	M8X70	100	07850.080.070	M16X25	50	07850.160.025
M5X20	200	07850.050.020				M16X30	50	07850.160.030
M5X25	200	07850.050.025	M10X8	200	07850.100.008	M16X40	50	07850.160.040
M5X30	200	07850.050.030	M10X10	200	07850.100.010	M16X50	50	07850.160.050
			M10X12	200	07850.100.012	M16X60	25	07850.160.060

• Warning: electro-galvanizing of these products may cause hydrogen embrittlement.



07930 Hexagon socket set screw with cup point				D05A
Thread	Metric thread			
Material	Steel			
Class	45H			
Surface treatment	Zinc plated yellow passivated			

d x L	☒	Art.number	d x L	☒	Art.number	d x L	☒	Art.number
M5X16	200	07930.050.016	M6X40	200	07930.060.040	M10X25	100	07930.100.025
M5X20	200	07930.050.020				M10X30	100	07930.100.030
			M8X25	200	07930.080.025	M10X40	100	07930.100.040
M6X16	200	07930.060.016	M8X30	200	07930.080.030	M10X50	100	07930.100.050
M6X20	200	07930.060.020	M8X40	100	07930.080.040	M10X60	100	07930.100.060
M6X25	200	07930.060.025	M8X50	100	07930.080.050			
M6X30	200	07930.060.030						

• Warning: electro-galvanizing of these products may cause hydrogen embrittlement.

51260 Hexagon socket set screw with cup point R03A

Thread Metric thread
Material Stainless steel A2

d x L	☒	Art.number	d x L	☒	Art.number	d x L	☒	Art.number
M1,6X3	25	51260.016.003	M5X4*	500	51260.050.004	M10X10	100	51260.100.010
M1,6X4	25	51260.016.004	M5X5	200	51260.050.005	M10X12	100	51260.100.012
M1,6X5	25	51260.016.005	M5X6	200	51260.050.006	M10X16	100	51260.100.016
M1,6X6	25	51260.016.006	M5X8	200	51260.050.008	M10X20	100	51260.100.020
			M5X10	200	51260.050.010	M10X25	100	51260.100.025
M2X3	50	51260.020.003	M5X12	200	51260.050.012	M10X30	100	51260.100.030
M2X4	50	51260.020.004	M5X14*	500	51260.050.014	M10X35	100	51260.100.035
M2X5	50	51260.020.005	M5X16	200	51260.050.016	M10X40	100	51260.100.040
M2X6	50	51260.020.006	M5X20	200	51260.050.020	M10X45*	100	51260.100.045
M2X8	50	51260.020.008	M5X25	200	51260.050.025	M10X50	100	51260.100.050
M2X10*	500	51260.020.010	M5X30	200	51260.050.030	M10X60	100	51260.100.060
M2X12*	500	51260.020.012	M5X35*	200	51260.050.035			
			M5X40*	200	51260.050.040	M12X10*	100	51260.120.010
M2,5X3*	500	51260.025.003				M12X12	100	51260.120.012
M2,5X4	50	51260.025.004	M6X5	200	51260.060.005	M12X16	100	51260.120.016
M2,5X5	50	51260.025.005	M6X6	200	51260.060.006	M12X20	100	51260.120.020
M2,5X6	50	51260.025.006	M6X8	200	51260.060.008	M12X25	100	51260.120.025
M2,5X8	50	51260.025.008	M6X10	200	51260.060.010	M12X30	100	51260.120.030
M2,5X10*	500	51260.025.010	M6X12	200	51260.060.012	M12X35	100	51260.120.035
M2,5X12*	500	51260.025.012	M6X14*	200	51260.060.014	M12X40	100	51260.120.040
			M6X16	200	51260.060.016	M12X45*	100	51260.120.045
M3X3	200	51260.030.003	M6X20	200	51260.060.020	M12X50	100	51260.120.050
M3X4	200	51260.030.004	M6X25	200	51260.060.025	M12X55*	100	51260.120.055
M3X5	200	51260.030.005	M6X30	200	51260.060.030	M12X60*	100	51260.120.060
M3X6	200	51260.030.006	M6X35	200	51260.060.035	M12X70*	50	51260.120.070
M3X8	200	51260.030.008	M6X40	200	51260.060.040			
M3X10	200	51260.030.010	M6X45*	200	51260.060.045	M16X16	50	51260.160.016
M3X12	200	51260.030.012	M6X50	200	51260.060.050	M16X20	100	51260.160.020
M3X16	200	51260.030.016	M6X60	200	51260.060.060	M16X25	50	51260.160.025
M3X20	200	51260.030.020				M16X30	50	51260.160.030
M3X25*	500	51260.030.025	M8X6	200	51260.080.006	M16X35*	50	51260.160.035
M3X30	200	51260.030.030	M8X8	200	51260.080.008	M16X40*	50	51260.160.040
			M8X10	200	51260.080.010	M16X45*	50	51260.160.045
M4X3	500	51260.040.003	M8X12	200	51260.080.012	M16X50*	50	51260.160.050
M4X4	200	51260.040.004	M8X16	200	51260.080.016	M16X60*	50	51260.160.060
M4X5	200	51260.040.005	M8X20	200	51260.080.020	M16X70*	50	51260.160.070
M4X6	200	51260.040.006	M8X25	200	51260.080.025	M16X80*	25	51260.160.080
M4X8	200	51260.040.008	M8X30	100	51260.080.030			
M4X10	200	51260.040.010	M8X35	100	51260.080.035	M20X20*	50	51260.200.020
M4X12	200	51260.040.012	M8X40	100	51260.080.040	M20X25*	50	51260.200.025
M4X16	200	51260.040.016	M8X45	200	51260.080.045	M20X30*	50	51260.200.030
M4X20	200	51260.040.020	M8X50	100	51260.080.050	M20X35*	50	51260.200.035
M4X25	200	51260.040.025	M8X60	100	51260.080.060	M20X40*	50	51260.200.040
M4X30	200	51260.040.030	M8X70	200	51260.080.070	M20X60*	50	51260.200.060
M4X35*	200	51260.040.035	M8X80*	200	51260.080.080	M20X70*	25	51260.200.070
						M20X80*	25	51260.200.080

55260 Hexagon socket set screw with cup point R43A

Thread Metric thread
Material Stainless steel A4

d x L	☒	Art.number	d x L	☒	Art.number	d x L	☒	Art.number
M2X3	50	55260.020.003				M5X16	200	55260.050.016
M2X4	50	55260.020.004	M4X4	200	55260.040.004	M5X20	200	55260.050.020
M2X6	50	55260.020.006	M4X5	200	55260.040.005	M5X25	200	55260.050.025
			M4X6	200	55260.040.006	M5X30	200	55260.050.030
M2,5X4	50	55260.025.004	M4X8	200	55260.040.008	M5X35*	200	55260.050.035
M2,5X6	50	55260.025.006	M4X10	200	55260.040.010	M5X40	200	55260.050.040
			M4X12	200	55260.040.012			
M3X3	200	55260.030.003	M4X16	200	55260.040.016	M6X6	200	55260.060.006
M3X4	200	55260.030.004	M4X20	200	55260.040.020	M6X8	200	55260.060.008
M3X5	200	55260.030.005	M4X25	200	55260.040.025	M6X10	200	55260.060.010
M3X6	200	55260.030.006	M4X30*	200	55260.040.030	M6X12	200	55260.060.012
M3X8	200	55260.030.008				M6X14*	200	55260.060.014
M3X10	200	55260.030.010	M5X5	200	55260.050.005	M6X16	200	55260.060.016
M3X12	200	55260.030.012	M5X6	200	55260.050.006	M6X20	200	55260.060.020
M3X16	200	55260.030.016	M5X8	200	55260.050.008	M6X25	200	55260.060.025
M3X20	200	55260.030.020	M5X10	200	55260.050.010	M6X30	200	55260.060.030
M3X30*	200	55260.030.030	M5X12	200	55260.050.012	M6X35*	200	55260.060.035

55260 Hexagon socket set screw with cup point								
d x L	☒	Art.number	d x L	☒	Art.number	d x L	☒	Art.number
M6X40	200	55260.060.040	M10X16	100	55260.100.016	M12X50	100	55260.120.050
M6X45*	200	55260.060.045	M10X20	100	55260.100.020			
M6X50	200	55260.060.050	M10X25	100	55260.100.025	M16X16	50	55260.160.016
M6X60*	200	55260.060.060	M10X30	100	55260.100.030	M16X20	50	55260.160.020
			M10X35*	100	55260.100.035	M16X25*	50	55260.160.025
M8X8	200	55260.080.008	M10X40	100	55260.100.040	M16X30*	50	55260.160.030
M8X10	200	55260.080.010	M10X45*	100	55260.100.045	M16X35*	50	55260.160.035
M8X12	200	55260.080.012	M10X50	100	55260.100.050	M16X40*	50	55260.160.040
M8X16	200	55260.080.016	M10X60*	100	55260.100.060	M16X45*	50	55260.160.045
M8X20	200	55260.080.020				M16X50*	50	55260.160.050
M8X25	200	55260.080.025	M12X10	100	55260.120.010	M16X60*	50	55260.160.060
M8X30	100	55260.080.030	M12X12	100	55260.120.012	M16X70*	50	55260.160.070
M8X35	100	55260.080.035	M12X16	100	55260.120.016	M16X90	50	55260.160.090
M8X40	100	55260.080.040	M12X20	100	55260.120.020			
M8X45*	200	55260.080.045	M12X25	100	55260.120.025	M20X20*	50	55260.200.020
M8X50	100	55260.080.050	M12X30	100	55260.120.030	M20X25*	50	55260.200.025
			M12X35*	100	55260.120.035	M20X30*	50	55260.200.030
M10X10	100	55260.100.010	M12X40	100	55260.120.040	M20X50	50	55260.200.050
M10X12	100	55260.100.012	M12X45*	100	55260.120.045	M20X70*	25	55260.200.070

Hexagon socket set screw with cup point MF

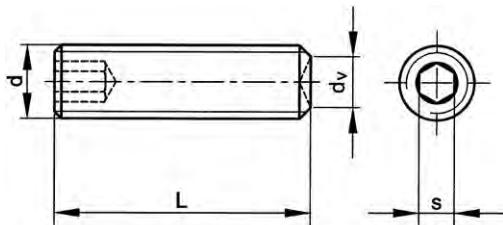

DIN ≈916
 ISO ≈4029
 NEN ≈2343
 ASME ≈B18.3.6M
 NF ≈E27-183
 BS ≈4168-5

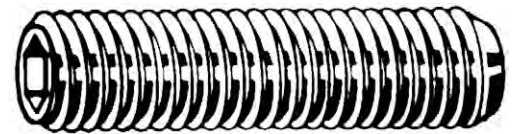

Technical Data

d	d _v	s	d	d _v	s
M8	5	4	M12	8	6
M10	6	5	M16	10	8

07852 Hexagon socket set screw with cup point MF

D93A

Thread Metric fine thread
Material Steel
Class 45H



d x P x L	☒	Art.number	d x P x L	☒	Art.number	d x P x L	☒	Art.number
M8X1,00X10	100	07852.080.010	M10X1,25X16	50	07852.100.016	M12X1,50X25	50	07852.120.025
M8X1,00X12	100	07852.080.012	M10X1,25X20	50	07852.100.020	M12X1,50X30	50	07852.120.030
M8X1,00X16	100	07852.080.016	M10X1,25X25	50	07852.100.025	M12X1,50X40	50	07852.120.040
M8X1,00X20	100	07852.080.020	M10X1,25X30	50	07852.100.030	M12X1,50X50	50	07852.120.050
M8X1,00X25	50	07852.080.025	M10X1,25X40	50	07852.100.040			
M8X1,00X30	50	07852.080.030	M10X1,25X50	50	07852.100.050	M16X1,50X20	25	07852.160.020
M8X1,00X40	50	07852.080.040				M16X1,50X25	25	07852.160.025
M8X1,00X50	50	07852.080.050	M12X1,50X10	50	07852.120.010	M16X1,50X30	25	07852.160.030
			M12X1,50X12	50	07852.120.012	M16X1,50X40	25	07852.160.040
M10X1,25X10	50	07852.100.010	M12X1,50X16	50	07852.120.016	M16X1,50X50	25	07852.160.050
M10X1,25X12	50	07852.100.012	M12X1,50X20	50	07852.120.020			

• Warning: electro-galvanizing of these products may cause hydrogen embrittlement.

Hexagon socket set screws with cup point UNC

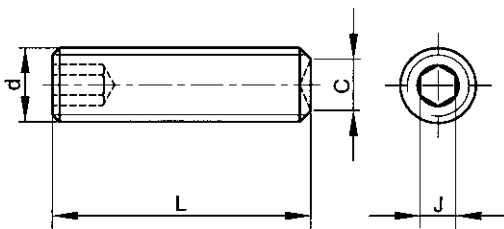

ASME ≈B18.3
BS ≈2470

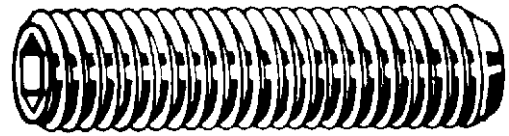

2

Technical Data

d	C (max.)	J	Threads per inch	d	C (max.)	J	Threads per inch
No.2	0.047	0.035	56	5/16	0.172	5/32	18
No.3	0.054	0.050	48	3/8	0.212	3/16	16
No.4	0.061	0.050	40	7/16	0.252	7/32	14
No.5	0.067	1/16	40	1/2	0.291	1/4	13
No.6	0.074	1/16	32	5/8	0.371	5/16	11
No.8	0.087	5/64	32	3/4	0.450	3/8	10
No.10	0.102	3/32	24	7/8	0.530	1/2	9
1/4	0.132	1/8	20	1 Inch	0.609	9/16	8

Article groups

Thread	Driving features	Material	Code	Page
UNC	Hexagon socket	St	U07840	2-73
UNC	Hexagon socket	St.St. A2 (AISI304/18-8)	U51260	2-74

U07840 Hexagon socket set screws with cup point UNC

X05A

Thread Unified National Coarse
Material Steel



d x L	Art.number	d x L	Art.number	d x L	Art.number
NO.2-56X3/16*	100 U07840.008.0006	NO.6-32X5/16*	100 U07840.013.0031	1/4-20X1/2*	100 U07840.025.0050
NO.2-56X3/32*	100 U07840.008.0009	NO.6-32X3/8*	100 U07840.013.0037	1/4-20X5/8*	100 U07840.025.0062
NO.2-56X1/8*	100 U07840.008.0012	NO.6-32X1/2*	100 U07840.013.0050	1/4-20X3/4*	100 U07840.025.0075
NO.2-56X3/16*	100 U07840.008.0018	NO.6-32X5/8*	100 U07840.013.0062	1/4-20X7/8*	100 U07840.025.0087
NO.2-56X1/4*	100 U07840.008.0025	NO.6-32X3/4*	100 U07840.013.0075	1/4-20X1 Inch*	100 U07840.025.0100
		NO.6-32X7/8*	100 U07840.013.0087	1/4-20X1.1/8*	100 U07840.025.0112
NO.3-48X3/32*	100 U07840.009.0009	NO.6-32X7/16*	100 U07840.013.0100	1/4-20X1.1/4*	100 U07840.025.0125
NO.3-48X1/8*	100 U07840.009.0012	NO.6-32X1 Inch*		1/4-20X1.1/2*	100 U07840.025.0150
NO.3-48X3/16*	100 U07840.009.0018	NO.8-32X1/8*	100 U07840.016.0012	1/4-20X1.3/4*	100 U07840.025.0175
NO.3-48X1/4*	100 U07840.009.0025	NO.8-32X3/16*	100 U07840.016.0018	1/4-20X2 Inch*	100 U07840.025.0200
NO.3-48X5/16*	100 U07840.009.0031	NO.8-32X1/4*	100 U07840.016.0025	1/4-20X2.1/4*	100 U07840.025.0225
NO.3-48X1/2*	100 U07840.009.0050	NO.8-32X5/16*	100 U07840.016.0031	1/4-20X2.1/2*	50 U07840.025.0250
NO.3-48X5/8*	100 U07840.009.0062	NO.8-32X3/8*	100 U07840.016.0037	1/4-20X3 Inch*	50 U07840.025.0300
NO.3-48X3/4*	100 U07840.009.0075	NO.8-32X7/16*	100 U07840.016.0043		
		NO.8-32X1/2*	100 U07840.016.0050	5/16-18X3/16*	100 U07840.031.0018
NO.4-40X3/32*	100 U07840.011.0009	NO.8-32X5/8*	100 U07840.016.0062	5/16-18X1/4*	100 U07840.031.0025
NO.4-40X1/8*	100 U07840.011.0012	NO.8-32X3/4*	100 U07840.016.0075	5/16-18X5/16*	100 U07840.031.0031
NO.4-40X3/16*	100 U07840.011.0018	NO.8-32X7/8*	100 U07840.016.0087	5/16-18X3/8*	100 U07840.031.0037
NO.4-40X1/4*	100 U07840.011.0025	NO.8-32X1 Inch*	100 U07840.016.0100	5/16-18X7/16*	100 U07840.031.0043
NO.4-40X5/16*	100 U07840.011.0031	NO.8-32X1.1/4*	100 U07840.016.0125	5/16-18X1/2*	100 U07840.031.0050
NO.4-40X3/8*	100 U07840.011.0037	NO.8-32X1.1/2*	100 U07840.016.0150	5/16-18X5/8*	100 U07840.031.0062
NO.4-40X1/2*	100 U07840.011.0050			5/16-18X3/4*	100 U07840.031.0075
NO.4-40X5/8*	100 U07840.011.0062	NO.10-24X1/8*	100 U07840.019.0012	5/16-18X7/8*	100 U07840.031.0087
NO.4-40X3/4*	100 U07840.011.0075	NO.10-24X3/16*	100 U07840.019.0018	5/16-18X1 Inch*	100 U07840.031.0100
NO.4-40X1 Inch*	100 U07840.011.0100	NO.10-24X1/4*	100 U07840.019.0025	5/16-18X1.1/4*	100 U07840.031.0125
		NO.10-24X5/16*	100 U07840.019.0031	5/16-18X1.1/2*	100 U07840.031.0150
NO.5-40X1/8*	100 U07840.012.0012	NO.10-24X3/8*	100 U07840.019.0037	5/16-18X1.3/4*	100 U07840.031.0175
NO.5-40X3/16*	100 U07840.012.0018	NO.10-24X1/2*	100 U07840.019.0050	5/16-18X2 Inch*	100 U07840.031.0200
NO.5-40X1/4*	100 U07840.012.0025	NO.10-24X5/8*	100 U07840.019.0062	5/16-18X2.1/4*	100 U07840.031.0225
NO.5-40X5/16*	100 U07840.012.0031	NO.10-24X3/4*	100 U07840.019.0075	5/16-18X2.1/2*	50 U07840.031.0250
NO.5-40X3/8*	100 U07840.012.0037	NO.10-24X7/8*	100 U07840.019.0087	5/16-18X2.3/4*	50 U07840.031.0275
NO.5-40X7/16*	100 U07840.012.0043	NO.10-24X1 Inch*	100 U07840.019.0100		
NO.5-40X1/2*	100 U07840.012.0050	NO.10-24X1.1/4*	100 U07840.019.0125	3/8-16X1/4*	100 U07840.037.0025
NO.5-40X5/8*	100 U07840.012.0062	NO.10-24X1.1/2*	100 U07840.019.0150	3/8-16X5/16*	100 U07840.037.0031
NO.5-40X3/4*	100 U07840.012.0075	NO.10-24X2 Inch*	50 U07840.019.0200	3/8-16X3/8*	100 U07840.037.0037
NO.5-40X1 Inch*	100 U07840.012.0100			3/8-16X7/16*	100 U07840.037.0043
		1/4-20X3/16*	100 U07840.025.0018	3/8-16X1/2*	100 U07840.037.0050
NO.6-32X1/8*	100 U07840.013.0012	1/4-20X1/4*	100 U07840.025.0025	3/8-16X5/8*	100 U07840.037.0062
NO.6-32X3/16*	100 U07840.013.0018	1/4-20X5/16*	100 U07840.025.0031	3/8-16X3/4*	100 U07840.037.0075
NO.6-32X1/4*	100 U07840.013.0025	1/4-20X3/8*	100 U07840.025.0037	3/8-16X7/8*	100 U07840.037.0087

U07840 Hexagon socket set screws with cup point UNC ←

d x L	☒	Art.number	d x L	☒	Art.number	d x L	☒	Art.number
3/8-16X1 Inch*	100	U07840.037.0100	1/2-13X3/4*	25	U07840.050.0075	3/4-10X5/8*	5	U07840.075.0062
3/8-16X1.1/4*	100	U07840.037.0125	1/2-13X7/8*	25	U07840.050.0087	3/4-10X3/4*	5	U07840.075.0075
3/8-16X1.1/2*	50	U07840.037.0150	1/2-13X1 Inch*	25	U07840.050.0100	3/4-10X7/8*	5	U07840.075.0087
3/8-16X1.3/4*	50	U07840.037.0175	1/2-13X1.1/4*	25	U07840.050.0125	3/4-10X1 Inch*	5	U07840.075.0100
3/8-16X2 Inch*	25	U07840.037.0200	1/2-13X1.1/2*	25	U07840.050.0150	3/4-10X1.1/4*	5	U07840.075.0125
3/8-16X2.1/4*	25	U07840.037.0225	1/2-13X1.3/4*	25	U07840.050.0175	3/4-10X1.1/2*	5	U07840.075.0150
3/8-16X2.1/2*	25	U07840.037.0250	1/2-13X2 Inch*	10	U07840.050.0200	3/4-10X1.3/4*	5	U07840.075.0175
3/8-16X2.3/4*	10	U07840.037.0275	1/2-13X2.1/4*	10	U07840.050.0225	3/4-10X2 Inch*	5	U07840.075.0200
3/8-16X3 Inch*	10	U07840.037.0300	1/2-13X2.1/2*	10	U07840.050.0250	3/4-10X2.1/2*	5	U07840.075.0250
			1/2-13X2.3/4*	10	U07840.050.0275	3/4-10X3 Inch*	5	U07840.075.0300
			1/2-13X3 Inch*	10	U07840.050.0300	3/4-10X3.1/2*	5	U07840.075.0350
			1/2-13X3.1/2*	10	U07840.050.0350	3/4-10X4 Inch*	5	U07840.075.0400
			1/2-13X4 Inch*	10	U07840.050.0400			
						7/8-9X7/8*	5	U07840.087.0087
			5/8-11X1/2*	10	U07840.062.0050	7/8-9X1 Inch*	5	U07840.087.0100
			5/8-11X5/8*	10	U07840.062.0062	7/8-9X1.1/4*	5	U07840.087.0125
			5/8-11X3/4*	10	U07840.062.0075	7/8-9X1.1/2*	5	U07840.087.0150
			5/8-11X1 Inch*	10	U07840.062.0100	7/8-9X2 Inch*	5	U07840.087.0200
			5/8-11X1.1/4*	10	U07840.062.0125	7/8-9X2.1/2*	1	U07840.087.0250
			5/8-11X1.1/2*	10	U07840.062.0150	7/8-9X3 Inch*	1	U07840.087.0300
			5/8-11X1.3/4*	10	U07840.062.0175	7/8-9X4 Inch*	1	U07840.087.0400
			5/8-11X2 Inch*	10	U07840.062.0200			
			5/8-11X2.1/4*	10	U07840.062.0225	1.-8X1 Inch*	1	U07840.100.0100
			5/8-11X2.1/2*	10	U07840.062.0250	1.-8X1.1/2*	1	U07840.100.0150
			5/8-11X3 Inch*	5	U07840.062.0300	1.-8X2 Inch*	1	U07840.100.0200
			5/8-11X4 Inch*	5	U07840.062.0400	1.-8X2.1/2*	1	U07840.100.0250
						1.-8X3 Inch*	1	U07840.100.0300

U51260 Hexagon socket set screws with cup point UNC X15A

Thread Unified National Coarse
Material Stainless steel A2 (AISI 304/18-8)



d x L	☒	Art.number	d x L	☒	Art.number	d x L	☒	Art.number
NO.2-56X1/16	100	U51260.008.0006	NO.8-32X1/4*	100	U51260.016.0025	1/4-20X1 Inch*	50	U51260.025.0100
NO.2-56X3/32*	100	U51260.008.0009	NO.8-32X5/16*	100	U51260.016.0031			
NO.2-56X1/8*	100	U51260.008.0012	NO.8-32X3/8*	100	U51260.016.0037	5/16-18X1/4*	100	U51260.031.0025
NO.2-56X3/16*	100	U51260.008.0018	NO.8-32X7/16*	100	U51260.016.0043	5/16-18X5/16*	100	U51260.031.0031
NO.2-56X1/4*	100	U51260.008.0025	NO.8-32X1/2*	100	U51260.016.0050	5/16-18X3/8*	100	U51260.031.0037
						5/16-18X1/2*	100	U51260.031.0050
						5/16-18X5/8*	100	U51260.031.0062
NO.3-48X3/32*	100	U51260.009.0009	NO.10-24X3/16*	100	U51260.019.0018	5/16-18X3/4*	50	U51260.031.0075
NO.3-48X1/8*	100	U51260.009.0012	NO.10-24X1/4*	100	U51260.019.0025	5/16-18X1 Inch*	50	U51260.031.0100
NO.3-48X3/16*	100	U51260.009.0018	NO.10-24X5/16*	100	U51260.019.0031			
			NO.10-24X3/8*	100	U51260.019.0037			
			NO.10-24X1/2*	100	U51260.019.0050	3/8-16X5/16*	50	U51260.037.0031
NO.4-40X1/8*	100	U51260.011.0012	NO.10-24X1/4*	100	U51260.019.0062	3/8-16X3/8*	50	U51260.037.0037
NO.4-40X3/16*	100	U51260.011.0018	NO.10-24X5/8*	100	U51260.019.0075	3/8-16X1/2*	50	U51260.037.0050
NO.4-40X1/4*	100	U51260.011.0025	NO.10-24X3/4*	100		3/8-16X5/8*	50	U51260.037.0062
						3/8-16X3/4*	50	U51260.037.0075
						3/8-16X1 Inch*	50	U51260.037.0100
NO.6-32X1/8*	100	U51260.013.0012	1/4-20X3/16*	100	U51260.025.0018			
NO.6-32X3/16*	100	U51260.013.0018	1/4-20X1/4*	100	U51260.025.0025			
NO.6-32X1/4*	100	U51260.013.0025	1/4-20X5/16*	100	U51260.025.0031			
NO.6-32X5/16*	100	U51260.013.0031	1/4-20X3/8*	100	U51260.025.0037			
NO.6-32X3/8*	100	U51260.013.0037	1/4-20X1/2*	100	U51260.025.0050	1/2-13X1/2*	50	U51260.050.0050
			1/4-20X5/8*	100	U51260.025.0062	1/2-13X5/8*	25	U51260.050.0062
			1/4-20X3/4*	100	U51260.025.0075	1/2-13X3/4*	25	U51260.050.0075
						1/2-13X1 Inch*	25	U51260.050.0100

Hexagon socket set screw with cup point UNF

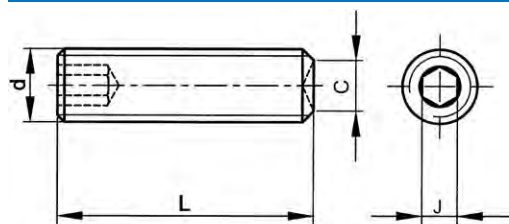

ASME ≈B18.3



2

Technical Data

d	C (max.)	J	Threads per inch
No.4	0.061	0.05	48
No.5	0.067	1/16	44
No.6	0.074	1/16	40
No.8	0.087	5/64	36
No.10	0.102	3/32	32
1/4	0.132	1/8	28
5/16	0.172	5/32	24
3/8	0.212	3/16	24
7/16	0.252	7/32	20
1/2	0.291	1/4	20
5/8	0.371	5/16	18
3/4	0.450	3/8	16

Article groups

Thread	Driving features	Material	Code	Page
UNF	Hexagon socket	St	U07852	2-75
UNF	Hexagon socket	St.St. A2 (AISI304/18-8)	U51261	2-76

U07852 Hexagon socket set screw with cup point UNF



X05A

Thread Unified National Fine
Material Steel



d x L	Art.number	d x L	Art.number	d x L	Art.number
NO.4-48X1/8*	100 U07852.011.0012	NO.10-32X1.3/4*	100 U07852.019.0175	3/8-24X3/4*	100 U07852.037.0075
NO.4-48X3/16*	100 U07852.011.0018	NO.10-32X2 Inch*	50 U07852.019.0200	3/8-24X1 Inch*	100 U07852.037.0100
NO.4-48X1/4*	100 U07852.011.0025			3/8-24X1.1/4*	100 U07852.037.0125
NO.4-48X1/2*	100 U07852.011.0050	1/4-28X3/16*	100 U07852.025.0018	3/8-24X1.1/2*	50 U07852.037.0150
		1/4-28X1/4*	100 U07852.025.0025	3/8-24X1.3/4*	50 U07852.037.0175
NO.5-44X1/8*	100 U07852.012.0012	1/4-28X5/16*	100 U07852.025.0031	3/8-24X2 Inch*	25 U07852.037.0200
NO.5-44X3/16*	100 U07852.012.0018	1/4-28X3/8*	100 U07852.025.0037	3/8-24X2.1/2*	25 U07852.037.0250
NO.5-44X1/4*	100 U07852.012.0025	1/4-28X1/2*	100 U07852.025.0050		
		1/4-28X5/8*	100 U07852.025.0062	7/16-20X3/8*	50 U07852.043.0037
NO.6-40X1/8*	100 U07852.013.0012	1/4-28X3/4*	100 U07852.025.0075	7/16-20X7/16*	50 U07852.043.0043
NO.6-40X3/16*	100 U07852.013.0018	1/4-28X1 Inch*	100 U07852.025.0100	7/16-20X1/2*	50 U07852.043.0050
NO.6-40X1/4*	100 U07852.013.0025	1/4-28X1.1/4*	100 U07852.025.0125	7/16-20X5/8*	50 U07852.043.0062
NO.6-40X5/16*	100 U07852.013.0031	1/4-28X1.1/2*	100 U07852.025.0150	7/16-20X3/4*	50 U07852.043.0075
NO.6-40X3/8*	100 U07852.013.0037	1/4-28X1.3/4*	100 U07852.025.0175	7/16-20X7/8*	50 U07852.043.0087
NO.6-40X1/2*	100 U07852.013.0050	1/4-28X2 Inch*	100 U07852.025.0200	7/16-20X1 Inch*	50 U07852.043.0100
		1/4-28X2.1/2*	50 U07852.025.0250	7/16-20X1.1/4*	25 U07852.043.0125
NO.8-36X1/8*	100 U07852.016.0012			7/16-20X1.1/2*	25 U07852.043.0150
NO.8-36X3/16*	100 U07852.016.0018	5/16-24X1/4*	100 U07852.031.0025	7/16-20X1.3/4*	25 U07852.043.0175
NO.8-36X1/4*	100 U07852.016.0025	5/16-24X5/16*	100 U07852.031.0031	7/16-20X2 Inch*	10 U07852.043.0200
NO.8-36X5/16*	100 U07852.016.0031	5/16-24X3/8*	100 U07852.031.0037		
NO.8-36X3/8*	100 U07852.016.0037	5/16-24X1/2*	100 U07852.031.0050	1/2-20X3/8*	25 U07852.050.0037
NO.8-36X1/2*	100 U07852.016.0050	5/16-24X5/8*	100 U07852.031.0062	1/2-20X1/2*	50 U07852.050.0050
		5/16-24X3/4*	100 U07852.031.0075	1/2-20X5/8*	50 U07852.050.0062
NO.10-32X1/8*	100 U07852.019.0012	5/16-24X1 Inch*	100 U07852.031.0100	1/2-20X3/4*	25 U07852.050.0075
NO.10-32X3/16*	100 U07852.019.0018	5/16-24X1.1/4*	100 U07852.031.0125	1/2-20X1 Inch*	25 U07852.050.0100
NO.10-32X1/4*	100 U07852.019.0025	5/16-24X1.1/2*	100 U07852.031.0150	1/2-20X1.1/4*	25 U07852.050.0125
NO.10-32X5/16*	100 U07852.019.0031	5/16-24X1.3/4*	100 U07852.031.0175	1/2-20X1.1/2*	10 U07852.050.0150
NO.10-32X3/8*	100 U07852.019.0037	5/16-24X2 Inch*	100 U07852.031.0200	1/2-20X1.3/4*	25 U07852.050.0175
NO.10-32X1/2*	100 U07852.019.0050	5/16-24X2.1/2*	50 U07852.031.0250	1/2-20X2 Inch*	10 U07852.050.0200
NO.10-32X5/8*	100 U07852.019.0062			1/2-20X2.1/2*	10 U07852.050.0250
NO.10-32X3/4*	100 U07852.019.0075	3/8-24X1/4*	100 U07852.037.0025	1/2-20X3 Inch*	10 U07852.050.0300
NO.10-32X7/8*	100 U07852.019.0087	3/8-24X5/16*	100 U07852.037.0031		
NO.10-32X1 Inch*	100 U07852.019.0100	3/8-24X3/8*	100 U07852.037.0037	5/8-18X1/2*	10 U07852.062.0050
NO.10-32X1.1/4*	100 U07852.019.0125	3/8-24X1/2*	100 U07852.037.0050	5/8-18X5/8*	10 U07852.062.0062
NO.10-32X1.1/2*	100 U07852.019.0150	3/8-24X5/8*	100 U07852.037.0062	5/8-18X3/4*	10 U07852.062.0075

U07852 Hexagon socket set screw with cup point UNF								
d x L	☒	Art.number	d x L	☒	Art.number	d x L	☒	Art.number
5/8-18X1 Inch*	10	U07852.062.0100				3/4-16X1.3/4*	5	U07852.075.0175
5/8-18X1.1/2*	10	U07852.062.0150	3/4-16X3/4*	5	U07852.075.0075	3/4-16X2 Inch*	5	U07852.075.0200
5/8-18X2 Inch*	10	U07852.062.0200	3/4-16X1 Inch*	5	U07852.075.0100	3/4-16X2.1/2*	5	U07852.075.0250
5/8-18X2.1/2*	10	U07852.062.0250	3/4-16X1.1/2*	5	U07852.075.0150	3/4-16X3 Inch*	5	U07852.075.0300

U51261 Hexagon socket set screw with cup point UNF								X15A
Thread		Unified National Fine						
Material		Stainless steel A2 (AISI 304/18-8)						
								
								
d x L	☒	Art.number	d x L	☒	Art.number	d x L	☒	Art.number
NO.10-32X3/16*	100	U51261.019.0018	NO.10-32X3/8*	100	U51261.019.0037	NO.10-32X5/8*	100	U51261.019.0062
NO.10-32X1/4*	100	U51261.019.0025	NO.10-32X1/2*	100	U51261.019.0050	NO.10-32X3/4*	100	U51261.019.0075
NO.10-32X5/16*	100	U51261.019.0031						

Hexagon socket set screw with knurled cup point

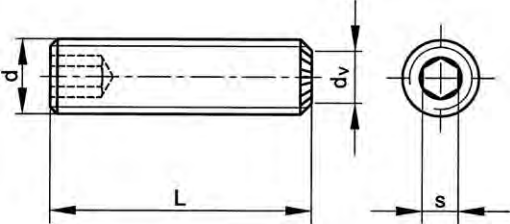

DIN ≈916
ISO ≈4029
NEN ≈2343
ASME ≈B18.3.6M
NF ≈E27-183
BS ≈4168-5

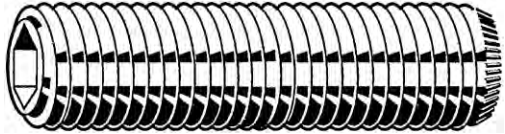

Technical Data							
d	d _v	P	s	d	d _v	P	s
M3	1.4	0.5	1.5	M6	3	1	3
M4	2	0.7	2	M8	5	1.25	4
M5	2.5	0.8	2.5				

07890 Hexagon socket set screw with knurled cup point								D05A
Thread		Metric thread						
Material		Steel						
Class		45H						
								
								

d x L	☒	Art.number	d x L	☒	Art.number	d x L	☒	Art.number
M3X4	200	07890.030.004				M6X12	200	07890.060.012
M3X5	200	07890.030.005	M5X5	200	07890.050.005	M6X16	200	07890.060.016
M3X6	200	07890.030.006	M5X6	200	07890.050.006	M6X20	200	07890.060.020
M3X8	200	07890.030.008	M5X8	200	07890.050.008	M6X25	200	07890.060.025
M3X10	200	07890.030.010	M5X10	200	07890.050.010			
			M5X12	200	07890.050.012	M8X8	200	07890.080.008
M4X5	200	07890.040.005	M5X16	200	07890.050.016	M8X10	200	07890.080.010
M4X6	200	07890.040.006	M5X20	200	07890.050.020	M8X12	200	07890.080.012
M4X8	200	07890.040.008				M8X16	200	07890.080.016
M4X10	200	07890.040.010	M6X6	200	07890.060.006	M8X20	200	07890.080.020
M4X12	200	07890.040.012	M6X8	200	07890.060.008	M8X25	200	07890.080.025
M4X16	200	07890.040.016	M6X10	200	07890.060.010	M8X30	200	07890.080.030

• Warning: electro-galvanizing of these products may cause hydrogen embrittlement.

Set screw with knurled cup point UNC

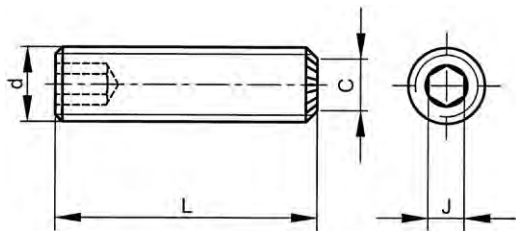

ASME ≈B18.3

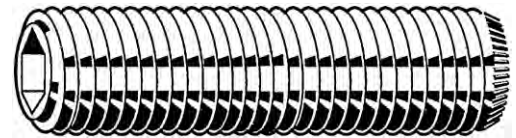

2

Technical Data

d	C (max.)	J	Threads per inch
No.4	0.054	0.05	40
No.6	0.074	1/16	32
No.8	0.087	5/64	32
No.10	0.102	3/32	24
1/4	0.132	1/8	20
5/16	0.172	5/32	18
3/8	0.212	3/16	16
1/2	0.291	1/4	13

U07890 Set screw with knurled cup point UNC

X05A

Thread Unified National Coarse
Material Steel



d x L	☒	Art.number	d x L	☒	Art.number	d x L	☒	Art.number
NO.4-40X1/8*	100	U07890.011.0012	NO.10-24X1/4*	100	U07890.019.0025	5/16-18X5/16*	100	U07890.031.0031
NO.6-32X1/8*	100	U07890.013.0012	NO.10-24X5/16*	100	U07890.019.0031	5/16-18X3/8*	100	U07890.031.0037
NO.6-32X3/16*	100	U07890.013.0018	NO.10-24X3/8*	100	U07890.019.0037	5/16-18X1/2*	100	U07890.031.0050
NO.6-32X1/4*	100	U07890.013.0025	NO.10-24X1/2*	100	U07890.019.0050	5/16-18X5/8*	100	U07890.031.0062
NO.6-32X5/16*	100	U07890.013.0031	NO.10-24X3/4*	100	U07890.019.0075	5/16-18X3/4*	100	U07890.031.0075
NO.6-32X3/8*	100	U07890.013.0037	NO.10-24X1 Inch*	100	U07890.019.0100	5/16-18X1 Inch*	100	U07890.031.0100
NO.6-32X1/2*	100	U07890.013.0050	1/4-20X3/16*	100	U07890.025.0018	3/8-16X3/8*	100	U07890.037.0037
NO.8-32X1/8*	100	U07890.016.0012	1/4-20X1/4*	100	U07890.025.0025	3/8-16X1/2*	100	U07890.037.0050
NO.8-32X3/16*	100	U07890.016.0018	1/4-20X5/16*	100	U07890.025.0031	3/8-16X5/8*	100	U07890.037.0062
NO.8-32X1/4*	100	U07890.016.0025	1/4-20X3/8*	100	U07890.025.0037	3/8-16X3/4*	100	U07890.037.0075
NO.8-32X5/16*	100	U07890.016.0031	1/4-20X1/2*	100	U07890.025.0050	3/8-16X1 Inch*	100	U07890.037.0100
NO.8-32X3/8*	100	U07890.016.0037	1/4-20X5/8*	100	U07890.025.0062	1/2-13X1/2*	50	U07890.050.0050
NO.8-32X1/2*	100	U07890.016.0050	1/4-20X3/4*	100	U07890.025.0075	1/2-13X5/8*	25	U07890.050.0062
NO.8-32X5/8*	100	U07890.016.0062	1/4-20X1 Inch*	100	U07890.025.0100	1/2-13X3/4*	25	U07890.050.0075
NO.8-32X3/4*	100	U07890.016.0075	1/4-20X1.1/4*	100	U07890.025.0125	1/2-13X1 Inch*	25	U07890.050.0100
NO.10-24X3/16*	100	U07890.019.0018	5/16-18X1/4*	100	U07890.031.0025	1/2-13X1.1/4*	25	U07890.050.0125

Set screw with knurled cup point UNF

2

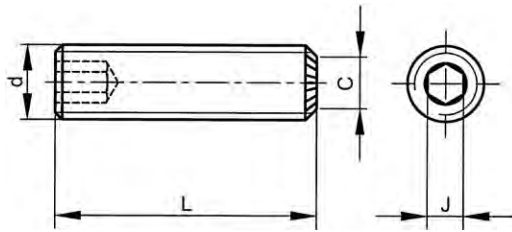

ASME ≈B18.3

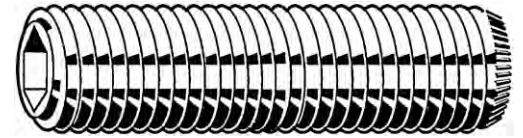

Technical Data

d	C (max.)	J	Threads per inch
No.10	0.102	3/32	32
1/4	0.132	1/8	28
5/16	0.172	5/32	24
3/8	0.212	3/16	24

U07891 Set screw with knurled cup point UNF

X05A

Thread Unified National Fine
Material Steel



d x L	Art.number	d x L	Art.number	d x L	Art.number
NO.10-32X3/16*	100 U07891.019.0018	1/4-28X5/16*	100 U07891.025.0031	5/16-24X5/8*	100 U07891.031.0062
NO.10-32X1/4*	100 U07891.019.0025	1/4-28X3/8*	100 U07891.025.0037	5/16-24X3/4*	100 U07891.031.0075
NO.10-32X5/16*	100 U07891.019.0031	1/4-28X1/2*	100 U07891.025.0050		
NO.10-32X3/8*	100 U07891.019.0037			3/8-24X3/8*	100 U07891.037.0037
NO.10-32X1/2*	100 U07891.019.0050	5/16-24X1/4*	100 U07891.031.0025	3/8-24X1/2*	100 U07891.037.0050
		5/16-24X5/16*	100 U07891.031.0031	3/8-24X5/8*	100 U07891.037.0062
1/4-28X3/16*	100 U07891.025.0018	5/16-24X3/8*	100 U07891.031.0037	3/8-24X3/4*	50 U07891.037.0075
1/4-28X1/4*	100 U07891.025.0025	5/16-24X1/2*	100 U07891.031.0050		

Hexagon socket set screw with flat point

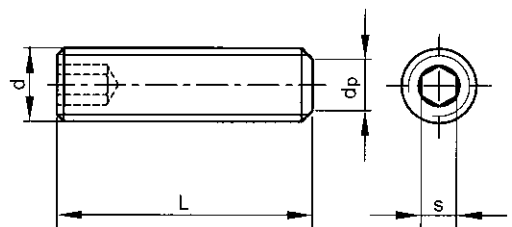

DIN 913
ISO 4026
NEN 2341
ASME B18.3.6M
NF E27-180
BS 4168-2

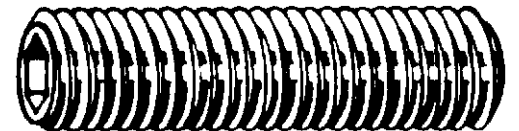

Technical Data

d	d _p (max.)	P	s	d	d _p (max.)	P	s
M1.6	0.8	0.35	0.7	M6	4	1	3
M2	1	0.4	0.9	M8	5.5	1.25	4
M2.5	1.5	0.45	1.3	M10	7	1.5	5
M3	2	0.5	1.5	M12	8.5	1.75	6
M4	2.5	0.7	2	M16	12	2	8
M5	3.5	0.8	2.5	M20	15	2.5	10

Article groups

Thread	Driving features	Material	Class	Surface treatment	Code	Page
M	Hexagon socket	St	45H		07810	2-79
M	Hexagon socket	St	45H	Zipl	07860	2-79
M	Hexagon socket	St.St. A2			51240	2-80
M	Hexagon socket	St.St. A4			55240	2-80

07810 Hexagon socket set screw with flat point D05A

Thread: Metric thread
Material: Steel
Class: 45H



d x L	☒	Art.number	d x L	☒	Art.number	d x L	☒	Art.number
M3X3	200	07810.030.003	M6X8	200	07810.060.008	M10X40	100	07810.100.040
M3X4	200	07810.030.004	M6X10	200	07810.060.010	M10X50	100	07810.100.050
M3X5	200	07810.030.005	M6X12	200	07810.060.012	M10X60	100	07810.100.060
M3X6	200	07810.030.006	M6X16	200	07810.060.016	M10X70	100	07810.100.070
M3X8	200	07810.030.008	M6X20	200	07810.060.020	M10X80	100	07810.100.080
M3X10	200	07810.030.010	M6X25	200	07810.060.025	M10X100	50	07810.100.100
M3X12	200	07810.030.012	M6X30	200	07810.060.030			
M3X16	200	07810.030.016	M6X35	200	07810.060.035	M12X12	100	07810.120.012
M3X20	200	07810.030.020	M6X40	200	07810.060.040	M12X16	100	07810.120.016
			M6X45	200	07810.060.045	M12X20	100	07810.120.020
M4X4	200	07810.040.004	M6X50	200	07810.060.050	M12X25	100	07810.120.025
M4X5	200	07810.040.005				M12X30	100	07810.120.030
M4X6	200	07810.040.006	M8X6	200	07810.080.006	M12X35	100	07810.120.035
M4X8	200	07810.040.008	M8X8	200	07810.080.008	M12X40	100	07810.120.040
M4X10	200	07810.040.010	M8X10	200	07810.080.010	M12X50	100	07810.120.050
M4X12	200	07810.040.012	M8X12	200	07810.080.012	M12X60	25	07810.120.060
M4X16	200	07810.040.016	M8X16	200	07810.080.016	M12X70	100	07810.120.070
M4X20	200	07810.040.020	M8X20	200	07810.080.020			
M4X25	200	07810.040.025	M8X25	200	07810.080.025	M16X16	50	07810.160.016
M4X30	200	07810.040.030	M8X30	200	07810.080.030	M16X20	50	07810.160.020
			M8X35	100	07810.080.035	M16X25	50	07810.160.025
M5X5	200	07810.050.005	M8X40	100	07810.080.040	M16X30	50	07810.160.030
M5X6	200	07810.050.006	M8X50	100	07810.080.050	M16X35	50	07810.160.035
M5X8	200	07810.050.008	M8X60	100	07810.080.060	M16X40	50	07810.160.040
M5X10	200	07810.050.010	M8X70	100	07810.080.070	M16X50	50	07810.160.050
M5X12	200	07810.050.012	M8X80	100	07810.080.080	M16X60	25	07810.160.060
M5X16	200	07810.050.016				M16X70	100	07810.160.070
M5X20	200	07810.050.020	M10X10	25	07810.100.010	M16X80	25	07810.160.080
M5X25	200	07810.050.025	M10X12	200	07810.100.012	M16X90	25	07810.160.090
M5X30	200	07810.050.030	M10X16	200	07810.100.016	M16X100	25	07810.160.100
M5X35	100	07810.050.035	M10X20	200	07810.100.020			
M5X40	100	07810.050.040	M10X25	100	07810.100.025	M20X20	10	07810.200.020
			M10X30	100	07810.100.030	M20X25	10	07810.200.025
M6X6	200	07810.060.006						

• Warning: electro-galvanizing of these products may cause hydrogen embrittlement.

07860 Hexagon socket set screw with flat point D05A

Thread: Metric thread
Material: Steel
Class: 45H
Surface treatment: Zinc plated



d x L	☒	Art.number	d x L	☒	Art.number	d x L	☒	Art.number
M3X6	200	07860.030.006	M5X20	200	07860.050.020	M8X30	200	07860.080.030
M3X8	200	07860.030.008	M5X25	200	07860.050.025	M8X40	100	07860.080.040
M3X10	200	07860.030.010						
M3X12	200	07860.030.012	M6X6	200	07860.060.006	M10X10	200	07860.100.010
			M6X8	200	07860.060.008	M10X12	200	07860.100.012
M4X4	200	07860.040.004	M6X10	200	07860.060.010	M10X16	200	07860.100.016
M4X5	200	07860.040.005	M6X12	200	07860.060.012	M10X20	200	07860.100.020
M4X6	200	07860.040.006	M6X16	200	07860.060.016	M10X25	100	07860.100.025
M4X8	200	07860.040.008	M6X20	200	07860.060.020	M10X30	100	07860.100.030
M4X10	200	07860.040.010	M6X25	200	07860.060.025	M10X40	100	07860.100.040
M4X12	200	07860.040.012	M6X30	200	07860.060.030	M10X50	100	07860.100.050
M4X16	200	07860.040.016						
M4X20	200	07860.040.020	M8X8	200	07860.080.008	M12X12	100	07860.120.012
			M8X10	200	07860.080.010	M12X16	100	07860.120.016
M5X6	200	07860.050.006	M8X12	200	07860.080.012	M12X20	100	07860.120.020
M5X8	200	07860.050.008	M8X16	200	07860.080.016	M12X25	100	07860.120.025
M5X10	200	07860.050.010	M8X20	200	07860.080.020	M12X30	100	07860.120.030
M5X12	200	07860.050.012	M8X25	200	07860.080.025	M12X40	100	07860.120.040
M5X16	200	07860.050.016						

• Warning: electro-galvanizing of these products may cause hydrogen embrittlement.

51240 Hexagon socket set screw with flat point R03A

Thread Material: Metric thread, Stainless steel A2



d x L	☒	Art.number	d x L	☒	Art.number	d x L	☒	Art.number
M1,6X2*	200	51240.016.002	M5X5	500	51240.050.005	M10X30	100	51240.100.030
M1,6X3	200	51240.016.003	M5X6	200	51240.050.006	M10X35*	100	51240.100.035
M1,6X6*	200	51240.016.006	M5X8	200	51240.050.008	M10X40	100	51240.100.040
M2X2	500	51240.020.002	M5X10	200	51240.050.010	M10X45*	100	51240.100.045
M2X3*	500	51240.020.003	M5X12	200	51240.050.012	M10X50*	100	51240.100.050
M2X4	200	51240.020.004	M5X14*	500	51240.050.014	M10X60*	100	51240.100.060
M2X5*	500	51240.020.005	M5X16	200	51240.050.016	M10X70*	100	51240.100.070
M2X6*	500	51240.020.006	M5X20	200	51240.050.020	M10X80	100	51240.100.080
M2X8*	500	51240.020.008	M5X25*	200	51240.050.025	M10X90*	100	51240.100.090
M2X10*	500	51240.020.010	M5X30*	200	51240.050.030	M12X12*	100	51240.120.012
M2X12*	500	51240.020.012	M5X35*	200	51240.050.035	M12X16*	100	51240.120.016
M2X16*	500	51240.020.016	M5X40*	200	51240.050.040	M12X20*	100	51240.120.020
M2,5X3*	500	51240.025.003	M6X5	200	51240.060.005	M12X25*	100	51240.120.025
M2,5X4	500	51240.025.004	M6X6	200	51240.060.006	M12X30*	100	51240.120.030
M2,5X5*	500	51240.025.005	M6X8	200	51240.060.008	M12X35*	100	51240.120.035
M2,5X6*	500	51240.025.006	M6X10	200	51240.060.010	M12X40*	100	51240.120.040
M2,5X8*	500	51240.025.008	M6X12	200	51240.060.012	M12X45*	100	51240.120.045
M2,5X10*	500	51240.025.010	M6X14*	200	51240.060.014	M12X50*	100	51240.120.050
M2,5X12*	500	51240.025.012	M6X16	200	51240.060.016	M12X55*	100	51240.120.055
M2,5X16*	500	51240.025.016	M6X20	200	51240.060.020	M12X60*	100	51240.120.060
M3X3	200	51240.030.003	M6X25	200	51240.060.025	M12X70	50	51240.120.070
M3X4*	500	51240.030.004	M6X30	200	51240.060.030	M12X80*	50	51240.120.080
M3X5*	500	51240.030.005	M6X35*	200	51240.060.035	M12X90*	50	51240.120.090
M3X6	200	51240.030.006	M6X40*	200	51240.060.040	M16X16*	50	51240.160.016
M3X8	200	51240.030.008	M6X45*	200	51240.060.045	M16X20*	50	51240.160.020
M3X10	200	51240.030.010	M6X50*	200	51240.060.050	M16X25*	50	51240.160.025
M3X12*	500	51240.030.012	M6X60*	200	51240.060.060	M16X30*	50	51240.160.030
M3X14*	500	51240.030.014	M6X70*	200	51240.060.070	M16X35*	50	51240.160.035
M3X16	200	51240.030.016	M8X6	200	51240.080.006	M16X40*	50	51240.160.040
M3X20*	500	51240.030.020	M8X8	200	51240.080.008	M16X45*	50	51240.160.045
M3X25*	500	51240.030.025	M8X10	200	51240.080.010	M16X50*	50	51240.160.050
M3X30*	200	51240.030.030	M8X12	200	51240.080.012	M16X60*	50	51240.160.060
M3X40*	200	51240.030.040	M8X16	200	51240.080.016	M16X70*	50	51240.160.070
M4X3*	500	51240.040.003	M8X20	200	51240.080.020	M16X80*	25	51240.160.080
M4X4	200	51240.040.004	M8X25	100	51240.080.025	M16X90*	25	51240.160.090
M4X5	200	51240.040.005	M8X30	100	51240.080.030	M16X100*	25	51240.160.100
M4X6	200	51240.040.006	M8X35*	200	51240.080.035	M20X20*	50	51240.200.020
M4X8	200	51240.040.008	M8X40	100	51240.080.040	M20X25*	50	51240.200.025
M4X10	200	51240.040.010	M8X45*	200	51240.080.045	M20X30*	50	51240.200.030
M4X12	200	51240.040.012	M8X50	200	51240.080.050	M20X35*	50	51240.200.035
M4X16	200	51240.040.016	M8X60*	200	51240.080.060	M20X40*	50	51240.200.040
M4X20	200	51240.040.020	M8X70*	200	51240.080.070	M20X45*	50	51240.200.045
M4X25*	500	51240.040.025	M8X80*	200	51240.080.080	M20X50*	50	51240.200.050
M4X30	200	51240.040.030	M10X10	100	51240.100.010	M20X60*	50	51240.200.060
M4X40*	200	51240.040.040	M10X12	100	51240.100.012	M20X70*	25	51240.200.070
M5X4	500	51240.050.004	M10X16	100	51240.100.016	M20X80*	25	51240.200.080
			M10X20	100	51240.100.020	M20X90*	25	51240.200.090
			M10X25	100	51240.100.025	M20X100*	25	51240.200.100

55240 Hexagon socket set screw with flat point R43A

Thread Material: Metric thread, Stainless steel A4





d x L	☒	Art.number	d x L	☒	Art.number	d x L	☒	Art.number
M3X4*	500	55240.030.004	M4X8	200	55240.040.008	M5X12	200	55240.050.012
M3X5	500	55240.030.005	M4X10	200	55240.040.010	M5X16	200	55240.050.016
M3X6	200	55240.030.006	M4X12	200	55240.040.012	M5X20	200	55240.050.020
M3X8	200	55240.030.008	M4X16	200	55240.040.016	M5X25	200	55240.050.025
M3X10	200	55240.030.010	M4X20	200	55240.040.020	M5X30	200	55240.050.030
M3X12	200	55240.030.012	M4X25	200	55240.040.025	M5X35*	200	55240.050.035
M3X16	200	55240.030.016	M4X30*	200	55240.040.030	M5X40*	200	55240.050.040
M3X20	200	55240.030.020	M5X5	500	55240.050.005	M6X6	200	55240.060.006
M4X4	200	55240.040.004	M5X6	200	55240.050.006	M6X8	200	55240.060.008
M4X5	200	55240.040.005	M5X8	200	55240.050.008	M6X10	200	55240.060.010
M4X6	200	55240.040.006	M5X10	200	55240.050.010	M6X12	200	55240.060.012

55240 Hexagon socket set screw with flat point ←

d x L	☒	Art.number	d x L	☒	Art.number	d x L	☒	Art.number
M6X14*	200	55240.060.014	M8X50*	200	55240.080.050	M12X40	100	55240.120.040
M6X16	200	55240.060.016	M8X60*	200	55240.080.060	M12X45*	100	55240.120.045
M6X20	200	55240.060.020				M12X50*	100	55240.120.050
M6X25	200	55240.060.025	M10X10*	200	55240.100.010	M12X60*	100	55240.120.060
M6X30	200	55240.060.030	M10X12	100	55240.100.012	M12X70*	50	55240.120.070
M6X35*	200	55240.060.035	M10X16	100	55240.100.016			
M6X40*	200	55240.060.040	M10X20	100	55240.100.020	M16X16*	50	55240.160.016
M6X45*	200	55240.060.045	M10X25	100	55240.100.025	M16X20*	50	55240.160.020
M6X50*	200	55240.060.050	M10X30	100	55240.100.030	M16X25*	50	55240.160.025
M6X60*	200	55240.060.060	M10X35*	100	55240.100.035	M16X30*	50	55240.160.030
			M10X40	100	55240.100.040	M16X35*	50	55240.160.035
M8X8	200	55240.080.008	M10X45*	100	55240.100.045	M16X40*	50	55240.160.040
M8X10	200	55240.080.010	M10X50	100	55240.100.050	M16X45*	50	55240.160.045
M8X12	200	55240.080.012	M10X60*	100	55240.100.060	M16X50*	50	55240.160.050
M8X16	200	55240.080.016				M16X60	50	55240.160.060
M8X20	200	55240.080.020	M12X12*	100	55240.120.012			
M8X25	100	55240.080.025	M12X16	100	55240.120.016	M20X25*	50	55240.200.025
M8X30	100	55240.080.030	M12X20	100	55240.120.020	M20X30*	50	55240.200.030
M8X35*	200	55240.080.035	M12X25	100	55240.120.025	M20X40*	50	55240.200.040
M8X40	100	55240.080.040	M12X30	100	55240.120.030	M20X50*	50	55240.200.050
M8X45*	200	55240.080.045	M12X35*	100	55240.120.035	M20X60*	50	55240.200.060

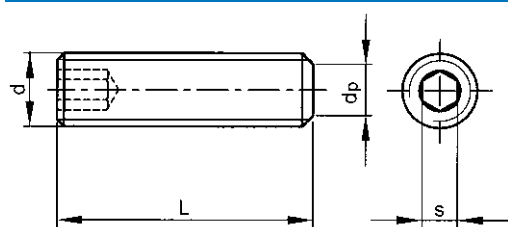
Hexagon socket set screw with flat point MF



DIN ≈913
 ISO ≈4026
 NEN ≈2341
 ASME ≈B18.3.6M
 NF ≈E27-180
 BS ≈4168-2

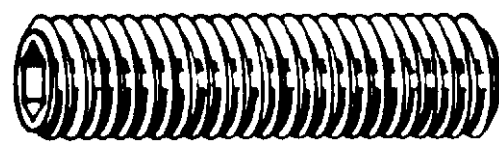

Technical Data

d	d _p (max.)	s	d	d _p (max.)	s
M8	5.5	4	M12	8.5	6
M10	7	5	M16	12	8

07812 Hexagon socket set screw with flat point MF D93A

Thread Metric fine thread
 Material Steel
 Class 45H



d x P x L	☒	Art.number	d x P x L	☒	Art.number	d x P x L	☒	Art.number
M8X1,00X10	200	07812.080.010	M10X1,25X16	100	07812.100.016	M12X1,50X25	100	07812.120.025
M8X1,00X12	200	07812.080.012	M10X1,25X20	100	07812.100.020	M12X1,50X30	100	07812.120.030
M8X1,00X16	200	07812.080.016	M10X1,25X25	100	07812.100.025	M12X1,50X40	100	07812.120.040
M8X1,00X20	200	07812.080.020	M10X1,25X30	100	07812.100.030	M12X1,50X50	100	07812.120.050
M8X1,00X25	100	07812.080.025	M10X1,25X40	100	07812.100.040			
M8X1,00X30	100	07812.080.030	M10X1,25X50	100	07812.100.050	M16X1,50X20	50	07812.160.020
M8X1,00X40	100	07812.080.040				M16X1,50X25	50	07812.160.025
M8X1,00X50	100	07812.080.050	M12X1,50X10	100	07812.120.010	M16X1,50X30	50	07812.160.030
			M12X1,50X12	100	07812.120.012	M16X1,50X40	50	07812.160.040
M10X1,25X10	100	07812.100.010	M12X1,50X16	100	07812.120.016	M16X1,50X50	50	07812.160.050
M10X1,25X12	100	07812.100.012	M12X1,50X20	100	07812.120.020			

• Warning: electro-galvanizing of these products may cause hydrogen embrittlement.

Hexagon socket set screw with flat point UNC

ASME ≈B18.3

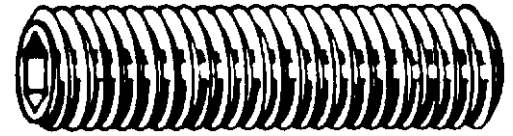
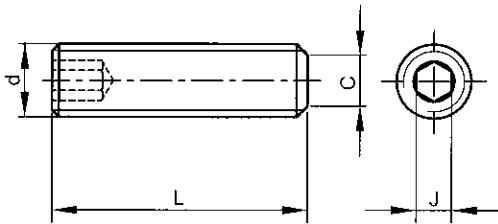

2

Technical Data

d	C (max.)	J	Threads per inch
No.4	0.061	0.05	40
No.5	0.067	1/16	40
No.6	0.074	1/16	32
No.8	0.087	5/64	32
No.10	0.102	3/32	24
1/4	0.132	1/8	20
5/16	0.172	5/32	18
3/8	0.212	3/16	16
7/16	0.252	7/32	14
1/2	0.291	1/4	13
5/8	0.371	5/16	11

U07810 Hexagon socket set screw with flat point UNC

X05A

Thread Unified National Coarse
Material Steel



d x L	Art.number	d x L	Art.number	d x L	Art.number
NO.4-40X1/8*	100 U07810.011.0012	NO.10-24X3/4*	100 U07810.019.0075	3/8-16X1 Inch*	100 U07810.037.0100
NO.4-40X3/16*	100 U07810.011.0018	NO.10-24X1 Inch*	100 U07810.019.0100	3/8-16X1.1/4*	100 U07810.037.0125
NO.4-40X1/4*	100 U07810.011.0025	NO.10-24X1.1/4*	100 U07810.019.0125	3/8-16X1.1/2*	50 U07810.037.0150
NO.4-40X3/8*	100 U07810.011.0037	NO.10-24X1.1/2*	100 U07810.019.0150	3/8-16X1.3/4*	50 U07810.037.0175
NO.5-40X1/8*	100 U07810.012.0012	1/4-20X3/16*	100 U07810.025.0018	3/8-16X2 Inch*	25 U07810.037.0200
NO.5-40X3/16*	100 U07810.012.0018	1/4-20X5/16*	100 U07810.025.0031	3/8-16X2.1/2*	25 U07810.037.0250
NO.5-40X1/4*	100 U07810.012.0025	1/4-20X3/8*	100 U07810.025.0037	7/16-14X3/8*	50 U07810.043.0037
NO.5-40X3/8*	100 U07810.012.0037	1/4-20X1/2*	100 U07810.025.0050	7/16-14X5/8*	50 U07810.043.0062
NO.5-40X1/2*	100 U07810.012.0050	1/4-20X5/8*	100 U07810.025.0062	7/16-14X3/4*	50 U07810.043.0075
NO.6-32X1/8*	100 U07810.013.0012	1/4-20X3/4*	100 U07810.025.0075	7/16-14X1 Inch*	50 U07810.043.0100
NO.6-32X3/16*	100 U07810.013.0018	1/4-20X1 Inch*	100 U07810.025.0100	1/2-13X3/8*	50 U07810.050.0037
NO.6-32X1/4*	100 U07810.013.0025	1/4-20X1.1/4*	100 U07810.025.0125	1/2-13X1/2*	50 U07810.050.0050
NO.6-32X5/16*	100 U07810.013.0031	1/4-20X1.1/2*	100 U07810.025.0150	1/2-13X5/8*	50 U07810.050.0062
NO.6-32X3/8*	100 U07810.013.0037	1/4-20X1.3/4*	100 U07810.025.0175	1/2-13X3/4*	25 U07810.050.0075
NO.6-32X1/2*	100 U07810.013.0050	1/4-20X2 Inch*	100 U07810.025.0200	1/2-13X1 Inch*	25 U07810.050.0100
NO.6-32X5/8*	100 U07810.013.0062	5/16-18X3/16*	100 U07810.031.0018	1/2-13X1.1/4*	25 U07810.050.0125
NO.6-32X3/4*	100 U07810.013.0075	5/16-18X1/4*	100 U07810.031.0025	1/2-13X1.1/2*	25 U07810.050.0150
NO.6-32X1 Inch*	100 U07810.013.0100	5/16-18X5/16*	100 U07810.031.0031	1/2-13X1.3/4*	25 U07810.050.0175
NO.8-32X1/8*	50 U07810.016.0012	5/16-18X3/8*	100 U07810.031.0037	1/2-13X2 Inch*	10 U07810.050.0200
NO.8-32X3/16*	100 U07810.016.0018	5/16-18X1/2*	100 U07810.031.0050	1/2-13X2.1/2*	10 U07810.050.0250
NO.8-32X1/4*	100 U07810.016.0025	5/16-18X5/8*	100 U07810.031.0062	1/2-13X3 Inch*	10 U07810.050.0300
NO.8-32X5/16*	100 U07810.016.0031	5/16-18X3/4*	100 U07810.031.0075	1/2-13X4 Inch*	10 U07810.050.0400
NO.8-32X3/8*	100 U07810.016.0037	5/16-18X1 Inch*	100 U07810.031.0100	5/8-11X1/2*	10 U07810.062.0050
NO.8-32X1/2*	100 U07810.016.0050	5/16-18X1.1/4*	100 U07810.031.0125	5/8-11X5/8*	10 U07810.062.0062
NO.8-32X5/8*	100 U07810.016.0062	5/16-18X1.1/2*	100 U07810.031.0150	5/8-11X3/4*	10 U07810.062.0075
NO.8-32X3/4*	100 U07810.016.0075	5/16-18X1.3/4*	100 U07810.031.0175	5/8-11X7/8*	10 U07810.062.0087
NO.8-32X1 Inch*	100 U07810.016.0100	5/16-18X2 Inch*	100 U07810.031.0200	5/8-11X1 Inch*	10 U07810.062.0100
NO.10-24X3/16*	100 U07810.019.0018	3/8-16X1/4*	100 U07810.037.0025	5/8-11X1.1/4*	10 U07810.062.0125
NO.10-24X1/4*	100 U07810.019.0025	3/8-16X5/16*	100 U07810.037.0031	5/8-11X1.1/2*	10 U07810.062.0150
NO.10-24X5/16*	100 U07810.019.0031	3/8-16X3/8*	100 U07810.037.0037	5/8-11X1.3/4*	10 U07810.062.0175
NO.10-24X3/8*	100 U07810.019.0037	3/8-16X1/2*	100 U07810.037.0050	5/8-11X2 Inch*	10 U07810.062.0200
NO.10-24X1/2*	100 U07810.019.0050	3/8-16X5/8*	100 U07810.037.0062	5/8-11X2.1/2*	10 U07810.062.0250
NO.10-24X5/8*	100 U07810.019.0062	3/8-16X3/4*	100 U07810.037.0075	5/8-11X3.1/2*	5 U07810.062.0350

Hexagon socket set screw with cone point

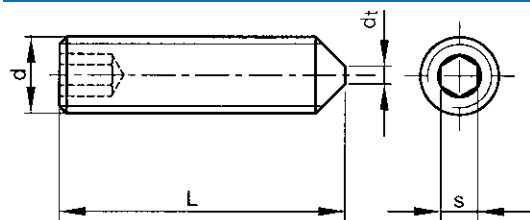

DIN	914
ISO	4027
NEN	2342
ASME	B18.3.6M
NF	E27-181
BS	4168-3

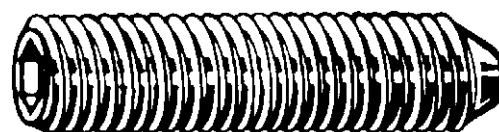

2

Technical Data

d	d _t (max.)	P	s	d	d _t (max.)	P	s
M2	-	0.4	0.9	M8	2	1.25	4
M2.5	-	0.45	1.3	M10	2.5	1.5	5
M3	-	0.5	1.5	M12	3	1.75	6
M4	-	0.7	2	M16	4	2	8
M5	-	0.8	2.5	M20	5	2.5	10
M6	1.5	1	3				

Article groups

Thread	Driving features	Material	Class	Code	Page
M	Hexagon socket	St	45H	07800	2-83
M	Hexagon socket	St.St. A2		51250	2-84
M	Hexagon socket	St.St. A4		55250	2-84

07800 Hexagon socket set screw with cone point

D05A

Thread	Metric thread
Material	Steel
Class	45H



d x L	Art.number	d x L	Art.number	d x L	Art.number
M3X3	200 07800.030.003	M5X20	200 07800.050.020	M10X10	200 07800.100.010
M3X4	200 07800.030.004	M5X25	200 07800.050.025	M10X12	200 07800.100.012
M3X5	200 07800.030.005	M5X30	200 07800.050.030	M10X16	200 07800.100.016
M3X6	200 07800.030.006			M10X20	200 07800.100.020
M3X8	200 07800.030.008	M6X6	200 07800.060.006	M10X25	100 07800.100.025
M3X10	200 07800.030.010	M6X8	200 07800.060.008	M10X30	100 07800.100.030
M3X12	200 07800.030.012	M6X10	200 07800.060.010	M10X40	100 07800.100.040
M3X16	200 07800.030.016	M6X12	200 07800.060.012	M10X50	100 07800.100.050
M3X20	200 07800.030.020	M6X16	200 07800.060.016		
		M6X20	200 07800.060.020	M12X16	100 07800.120.016
M4X4	200 07800.040.004	M6X25	200 07800.060.025	M12X20	100 07800.120.020
M4X5	200 07800.040.005	M6X30	200 07800.060.030	M12X25	100 07800.120.025
M4X6	200 07800.040.006	M6X35	200 07800.060.035	M12X30	100 07800.120.030
M4X8	200 07800.040.008			M12X40	100 07800.120.040
M4X10	200 07800.040.010	M8X8	200 07800.080.008	M12X50	100 07800.120.050
M4X12	200 07800.040.012	M8X10	200 07800.080.010		
M4X16	200 07800.040.016	M8X12	200 07800.080.012	M16X16	50 07800.160.016
M4X20	200 07800.040.020	M8X16	200 07800.080.016	M16X20	50 07800.160.020
M4X25	200 07800.040.025	M8X20	200 07800.080.020	M16X25	50 07800.160.025
		M8X25	200 07800.080.025	M16X30	50 07800.160.030
M5X5	200 07800.050.005	M8X30	200 07800.080.030	M16X35	50 07800.160.035
M5X6	200 07800.050.006	M8X35	100 07800.080.035	M16X40	50 07800.160.040
M5X8	200 07800.050.008	M8X40	100 07800.080.040	M16X50	50 07800.160.050
M5X10	200 07800.050.010	M8X50	100 07800.080.050	M16X60	25 07800.160.060
M5X12	200 07800.050.012	M8X60	100 07800.080.060		
M5X16	200 07800.050.016				

- Warning: electro-galvanizing of these products may cause hydrogen embrittlement.

51250 Hexagon socket set screw with cone point R03A



Thread Material: Metric thread, Stainless steel A2



d x L	☒	Art.number	d x L	☒	Art.number	d x L	☒	Art.number
M2X3*	500	51250.020.003	M5X8	200	51250.050.008	M8X50*	200	51250.080.050
M2X4*	500	51250.020.004	M5X10	200	51250.050.010	M8X60*	200	51250.080.060
M2X5*	500	51250.020.005	M5X12	200	51250.050.012			
M2X6*	500	51250.020.006	M5X14*	500	51250.050.014	M10X10*	200	51250.100.010
M2X8*	500	51250.020.008	M5X16	200	51250.050.016	M10X12	100	51250.100.012
M2X10*	500	51250.020.010	M5X18*	500	51250.050.018	M10X16	100	51250.100.016
M2X12*	500	51250.020.012	M5X20	200	51250.050.020	M10X20	100	51250.100.020
			M5X25	200	51250.050.025	M10X25	100	51250.100.025
M2,5X3*	500	51250.025.003	M5X30*	200	51250.050.030	M10X30*	100	51250.100.030
M2,5X4	200	51250.025.004	M5X35*	200	51250.050.035	M10X35*	100	51250.100.035
M2,5X5*	500	51250.025.005	M5X40*	200	51250.050.040	M10X40*	100	51250.100.040
M2,5X6*	500	51250.025.006	M5X45*	200	51250.050.045	M10X45*	100	51250.100.045
M2,5X8*	500	51250.025.008	M5X50	200	51250.050.050	M10X50*	100	51250.100.050
M2,5X10*	500	51250.025.010				M10X60*	100	51250.100.060
M2,5X12*	500	51250.025.012	M6X5*	200	51250.060.005			
			M6X6	200	51250.060.006	M12X12*	100	51250.120.012
M3X3*	500	51250.030.003	M6X8	200	51250.060.008	M12X16*	100	51250.120.016
M3X4	500	51250.030.004	M6X10	200	51250.060.010	M12X20*	100	51250.120.020
M3X5*	500	51250.030.005	M6X12	200	51250.060.012	M12X25*	100	51250.120.025
M3X6*	500	51250.030.006	M6X14*	200	51250.060.014	M12X30*	100	51250.120.030
M3X8*	500	51250.030.008	M6X16	200	51250.060.016	M12X35	100	51250.120.035
M3X10*	500	51250.030.010	M6X20	200	51250.060.020	M12X40*	100	51250.120.040
M3X12*	500	51250.030.012	M6X22*	200	51250.060.022	M12X45*	100	51250.120.045
M3X16*	500	51250.030.016	M6X25	200	51250.060.025	M12X50*	100	51250.120.050
M3X20*	500	51250.030.020	M6X30*	200	51250.060.030	M12X55	100	51250.120.055
M3X25*	500	51250.030.025	M6X35*	200	51250.060.035	M12X60*	100	51250.120.060
M3X30*	200	51250.030.030	M6X40*	200	51250.060.040	M12X70*	50	51250.120.070
			M6X45*	200	51250.060.045			
M4X4	500	51250.040.004	M6X50*	200	51250.060.050	M16X16*	50	51250.160.016
M4X5	500	51250.040.005	M6X60*	200	51250.060.060	M16X20*	50	51250.160.020
M4X6	200	51250.040.006				M16X25*	50	51250.160.025
M4X8	200	51250.040.008	M8X6*	200	51250.080.006	M16X30*	50	51250.160.030
M4X10	200	51250.040.010	M8X8	200	51250.080.008	M16X40*	50	51250.160.040
M4X12	200	51250.040.012	M8X10	200	51250.080.010	M16X45*	50	51250.160.045
M4X14	200	51250.040.014	M8X12	200	51250.080.012	M16X50*	50	51250.160.050
M4X16	200	51250.040.016	M8X16	200	51250.080.016	M16X60*	50	51250.160.060
M4X20	200	51250.040.020	M8X20	200	51250.080.020	M16X70*	50	51250.160.070
M4X25*	500	51250.040.025	M8X25	100	51250.080.025			
M4X30*	200	51250.040.030	M8X30	200	51250.080.030	M20X20*	50	51250.200.020
			M8X35*	200	51250.080.035	M20X30*	50	51250.200.030
M5X5*	500	51250.050.005	M8X40*	200	51250.080.040	M20X40*	50	51250.200.040
M5X6	200	51250.050.006	M8X45*	200	51250.080.045	M20X50*	50	51250.200.050

55250 Hexagon socket set screw with cone point R43A

Thread Material: Metric thread, Stainless steel A4

d x L	☒	Art.number	d x L	☒	Art.number	d x L	☒	Art.number
M3X4*	500	55250.030.004	M5X12	200	55250.050.012	M8X8	200	55250.080.008
M3X5*	500	55250.030.005	M5X14*	500	55250.050.014	M8X10	200	55250.080.010
M3X6*	500	55250.030.006	M5X16	200	55250.050.016	M8X12	200	55250.080.012
M3X8*	500	55250.030.008	M5X20	200	55250.050.020	M8X16	200	55250.080.016
M3X10*	500	55250.030.010	M5X25*	200	55250.050.025	M8X20	200	55250.080.020
M3X12*	500	55250.030.012	M5X30*	200	55250.050.030	M8X25	100	55250.080.025
			M5X35*	200	55250.050.035	M8X30	100	55250.080.030
M4X4*	500	55250.040.004	M5X40*	200	55250.050.040	M8X35*	200	55250.080.035
M4X5*	500	55250.040.005				M8X40	100	55250.080.040
M4X6	200	55250.040.006	M6X6	200	55250.060.006	M8X45*	200	55250.080.045
M4X8	200	55250.040.008	M6X8	200	55250.060.008	M8X50*	200	55250.080.050
M4X10	200	55250.040.010	M6X10	200	55250.060.010			
M4X12	200	55250.040.012	M6X12	200	55250.060.012	M10X10*	200	55250.100.010
M4X16	200	55250.040.016	M6X14*	200	55250.060.014	M10X12	100	55250.100.012
M4X20	200	55250.040.020	M6X16	200	55250.060.016	M10X16	100	55250.100.016
M4X30*	200	55250.040.030	M6X20	200	55250.060.020	M10X20	100	55250.100.020
			M6X25	200	55250.060.025	M10X25	100	55250.100.025
M5X5*	500	55250.050.005	M6X30	200	55250.060.030	M10X30	100	55250.100.030
M5X6	200	55250.050.006	M6X35*	200	55250.060.035	M10X35*	100	55250.100.035
M5X8	200	55250.050.008	M6X40*	200	55250.060.040	M10X40	100	55250.100.040
M5X10	200	55250.050.010	M6X45*	200	55250.060.045			

55250 Hexagon socket set screw with cone point								
d x L	☒	Art.number	d x L	☒	Art.number	d x L	☒	Art.number
M10X50*	100	55250.100.050	M12X25*	100	55250.120.025			
			M12X30*	100	55250.120.030	M16X25*	50	55250.160.025
M12X12*	100	55250.120.012	M12X40*	100	55250.120.040	M16X30*	50	55250.160.030
M12X16*	100	55250.120.016	M12X45*	100	55250.120.045	M16X40*	50	55250.160.040
M12X20*	100	55250.120.020	M12X50*	100	55250.120.050			

Hexagon socket set screw with cone point UNC

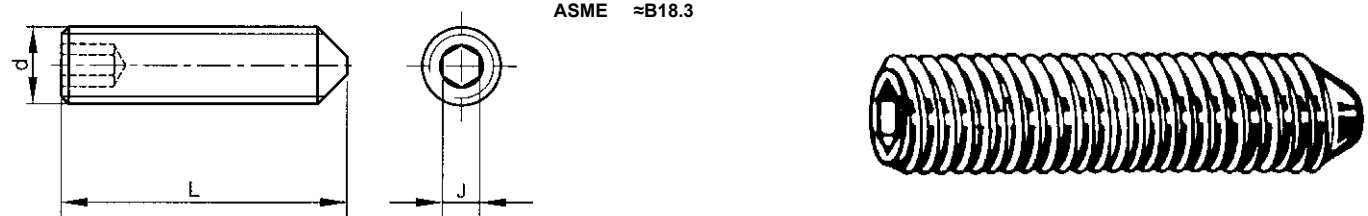

Technical Data		
d	J	Threads per inch
No.4	0.05	40
No.5	1/16	40
No.6	1/16	32
No.8	5/64	32
No.10	3/32	24
1/4	1/8	20
5/16	5/32	18
3/8	3/16	16
1/2	1/4	13

U07800 Hexagon socket set screw with cone point UNC		X05A
Thread	Unified National Coarse	
Material	Steel	

d x L	☒	Art.number	d x L	☒	Art.number	d x L	☒	Art.number
NO.4-40X1/8*	100	U07800.011.0012	NO.10-24X3/8*	100	U07800.019.0037	5/16-18X5/8*	100	U07800.031.0062
			NO.10-24X1/2*	100	U07800.019.0050	5/16-18X3/4*	100	U07800.031.0075
NO.5-40X1/4*	100	U07800.012.0025				5/16-18X1 Inch*	100	U07800.031.0100
NO.6-32X1/8*	100	U07800.013.0012	1/4-20X1/4*	100	U07800.025.0025			
NO.6-32X3/16*	100	U07800.013.0018	1/4-20X5/16*	100	U07800.025.0031	3/8-16X3/8*	100	U07800.037.0037
NO.6-32X1/4*	100	U07800.013.0025	1/4-20X3/8*	100	U07800.025.0037	3/8-16X1/2*	100	U07800.037.0050
			1/4-20X1/2*	50	U07800.025.0050	3/8-16X3/4*	100	U07800.037.0075
NO.8-32X3/16*	100	U07800.016.0018	1/4-20X5/8*	100	U07800.025.0062	3/8-16X1 Inch*	100	U07800.037.0100
NO.8-32X1/4*	100	U07800.016.0025	1/4-20X3/4*	50	U07800.025.0075			
NO.8-32X3/8*	100	U07800.016.0037	1/4-20X1 Inch*	100	U07800.025.0100	1/2-13X1/2*	50	U07800.050.0050
						1/2-13X3/4*	25	U07800.050.0075
NO.10-24X1/4*	100	U07800.019.0025	5/16-18X5/16*	50	U07800.031.0031	1/2-13X1 Inch*	25	U07800.050.0100
NO.10-24X5/16*	100	U07800.019.0031	5/16-18X3/8*	100	U07800.031.0037			
			5/16-18X1/2*	100	U07800.031.0050			

Hexagon socket set screw with dog point

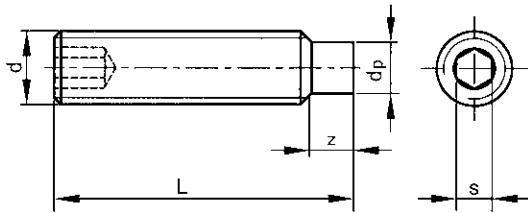

DIN 915
 ISO 4028
 NEN 2344
 ASME B18.3.6M
 NF E27-182
 BS 4168-4

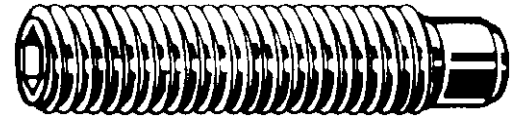

Technical Data

d	z short L ≤	z short (min.)	z short (max.)	z long L ≥	z long (min.)	z long (max.)	d _p (max.)	P	s
M2	3	0.5	0.75	4	1	1.25	1	0.4	0.9
M2.5	4	0.63	0.88	5	1.25	1.5	1.5	0.45	1.3
M3	5	0.75	1	6	1.5	1.75	2	0.5	1.5
M4	6	1	1.25	8	2	2.25	2.5	0.7	2
M5	6	1.25	1.5	8	2.5	2.75	3.5	0.8	2.5
M6	8	1.5	1.75	10	3	3.25	4	1	3
M8	10	2	2.25	12	4	4.3	5.5	1.25	4
M10	12	2.5	2.75	16	5	5.3	7	1.5	5
M12	16	3	3.25	20	6	6.3	8.5	1.75	6
M16	20	4	4.3	25	8	8.36	12	2	8
M20	25	5	5.3	30	10	10.36	15	2.5	10

Article groups

Thread	Driving features	Material	Class	Code	Page
M	Hexagon socket	St	45H	07820	2-86
M	Hexagon socket	St.St. A2		51230	2-87
M	Hexagon socket	St.St. A4		55230	2-87

07820 Hexagon socket set screw with dog point

D05A

Thread Metric thread
Material Steel
Class 45H





d x L	☒	Art.number	d x L	☒	Art.number	d x L	☒	Art.number
M3X3	200	07820.030.003	M6X8	200	07820.060.008	M10X45	100	07820.100.045
M3X4	200	07820.030.004	M6X10	200	07820.060.010	M10X50	100	07820.100.050
M3X5	200	07820.030.005	M6X12	200	07820.060.012	M10X60	50	07820.100.060
M3X6	200	07820.030.006	M6X16	200	07820.060.016			
M3X8	200	07820.030.008	M6X20	200	07820.060.020	M12X12	100	07820.120.012
M3X10	200	07820.030.010	M6X25	200	07820.060.025	M12X16	100	07820.120.016
M3X12	200	07820.030.012	M6X30	200	07820.060.030	M12X20	100	07820.120.020
M3X16	200	07820.030.016	M6X40	200	07820.060.040	M12X25	100	07820.120.025
M3X20	200	07820.030.020	M6X50	200	07820.060.050	M12X30	100	07820.120.030
						M12X35	100	07820.120.035
M4X6	200	07820.040.006	M8X8	200	07820.080.008	M12X40	100	07820.120.040
M4X8	200	07820.040.008	M8X10	200	07820.080.010	M12X45	100	07820.120.045
M4X10	200	07820.040.010	M8X12	200	07820.080.012	M12X50	100	07820.120.050
M4X12	200	07820.040.012	M8X16	200	07820.080.016	M12X60	50	07820.120.060
M4X16	200	07820.040.016	M8X20	200	07820.080.020			
M4X20	200	07820.040.020	M8X25	200	07820.080.025	M16X16	50	07820.160.016
M4X25	200	07820.040.025	M8X30	200	07820.080.030	M16X20	50	07820.160.020
M4X30	200	07820.040.030	M8X35	100	07820.080.035	M16X25	50	07820.160.025
			M8X40	100	07820.080.040	M16X30	50	07820.160.030
M5X6	200	07820.050.006	M8X45	100	07820.080.045	M16X35	50	07820.160.035
M5X8	200	07820.050.008	M8X50	100	07820.080.050	M16X40	50	07820.160.040
M5X10	200	07820.050.010	M8X80	100	07820.080.080	M16X50	50	07820.160.050
M5X12	200	07820.050.012				M16X60	25	07820.160.060
M5X16	200	07820.050.016	M10X12	200	07820.100.012			
M5X20	200	07820.050.020	M10X16	200	07820.100.016	M20X30	25	07820.200.030
M5X25	200	07820.050.025	M10X20	200	07820.100.020	M20X40	25	07820.200.040
M5X30	200	07820.050.030	M10X25	100	07820.100.025	M20X50	10	07820.200.050
M5X40	200	07820.050.040	M10X30	100	07820.100.030	M20X60	25	07820.200.060
			M10X35	100	07820.100.035	M20X70	25	07820.200.070
M6X6	200	07820.060.006	M10X40	100	07820.100.040	M20X140	25	07820.200.140

• Warning: electro-galvanizing of these products may cause hydrogen embrittlement.

51230 Hexagon socket set screw with dog point R03A

Thread: Metric thread
Material: Stainless steel A2

d x L	☒	Art.number	d x L	☒	Art.number	d x L	☒	Art.number
M2X3	500	51230.020.003				M8X35*	200	51230.080.035
M2X4*	500	51230.020.004				M8X40	100	51230.080.040
M2X5*	500	51230.020.005	M5X5*	500	51230.050.005	M8X45*	200	51230.080.045
M2X6*	500	51230.020.006	M5X6	200	51230.050.006	M8X50*	200	51230.080.050
M2X8*	500	51230.020.008	M5X8	200	51230.050.008	M8X60*	200	51230.080.060
M2X12*	500	51230.020.012	M5X10	200	51230.050.010			
			M5X12	200	51230.050.012			
M2,5X3*	500	51230.025.003	M5X16	200	51230.050.016	M10X10*	200	51230.100.010
M2,5X4*	500	51230.025.004	M5X18*	500	51230.050.018	M10X12	100	51230.100.012
M2,5X5*	500	51230.025.005	M5X20	200	51230.050.020	M10X16	100	51230.100.016
M2,5X6*	500	51230.025.006	M5X25*	200	51230.050.025	M10X20	100	51230.100.020
M2,5X8*	500	51230.025.008	M5X30*	200	51230.050.030	M10X25	100	51230.100.025
M2,5X10*	500	51230.025.010	M5X35*	200	51230.050.035	M10X30	100	51230.100.030
M2,5X12*	500	51230.025.012	M5X40*	200	51230.050.040	M10X35*	200	51230.100.035
						M10X40	100	51230.100.040
M3X3*	500	51230.030.003	M6X6	200	51230.060.006	M10X45*	200	51230.100.045
M3X4*	500	51230.030.004	M6X8	200	51230.060.008	M10X50*	200	51230.100.050
M3X5*	500	51230.030.005	M6X10	200	51230.060.010	M10X60*	200	51230.100.060
M3X6*	500	51230.030.006	M6X12	200	51230.060.012			
M3X8*	500	51230.030.008	M6X16	200	51230.060.016	M12X12*	100	51230.120.012
M3X10*	500	51230.030.010	M6X20	200	51230.060.020	M12X16*	100	51230.120.016
M3X12*	500	51230.030.012	M6X25	200	51230.060.025	M12X20*	100	51230.120.020
M3X16*	500	51230.030.016	M6X30	200	51230.060.030	M12X25*	100	51230.120.025
M3X20*	500	51230.030.020	M6X35*	200	51230.060.035	M12X30*	100	51230.120.030
M3X25*	500	51230.030.025	M6X40*	200	51230.060.040	M12X35*	100	51230.120.035
			M6X45*	200	51230.060.045	M12X40*	100	51230.120.040
M4X4*	500	51230.040.004	M6X50*	200	51230.060.050	M12X45*	100	51230.120.045
M4X5*	500	51230.040.005	M6X60*	200	51230.060.060	M12X50*	100	51230.120.050
M4X6	200	51230.040.006				M12X55*	100	51230.120.055
M4X8	200	51230.040.008	M8X8*	200	51230.080.008	M12X60*	100	51230.120.060
M4X10	200	51230.040.010	M8X10	200	51230.080.010			
M4X12*	500	51230.040.012	M8X12	200	51230.080.012	M16X20*	50	51230.160.020
M4X16	500	51230.040.016	M8X16	200	51230.080.016	M16X25	50	51230.160.025
M4X20*	500	51230.040.020	M8X20	200	51230.080.020	M16X30*	50	51230.160.030
M4X25*	500	51230.040.025	M8X25	100	51230.080.025	M16X40*	50	51230.160.040
M4X30*	200	51230.040.030	M8X30	100	51230.080.030	M16X50*	50	51230.160.050

55230 Hexagon socket set screw with dog point R43A

Thread: Metric thread
Material: Stainless steel A4





d x L	☒	Art.number	d x L	☒	Art.number	d x L	☒	Art.number
M3X4*	500	55230.030.004	M5X16*	500	55230.050.016	M8X25*	200	55230.080.025
M3X5*	500	55230.030.005	M5X20*	500	55230.050.020	M8X30*	200	55230.080.030
M3X6*	500	55230.030.006	M5X25*	200	55230.050.025			
M3X8*	500	55230.030.008				M10X10*	200	55230.100.010
			M6X6*	200	55230.060.006	M10X12*	200	55230.100.012
M4X4*	500	55230.040.004	M6X8*	200	55230.060.008	M10X16*	200	55230.100.016
M4X6*	500	55230.040.006	M6X10*	200	55230.060.010	M10X20*	200	55230.100.020
M4X8*	500	55230.040.008	M6X12*	200	55230.060.012	M10X25*	100	55230.100.025
M4X10	500	55230.040.010	M6X16*	200	55230.060.016	M10X30*	100	55230.100.030
M4X12*	500	55230.040.012	M6X20*	200	55230.060.020	M10X40*	100	55230.100.040
M4X16*	500	55230.040.016	M6X25*	200	55230.060.025			
M4X25*	500	55230.040.025	M6X30*	200	55230.060.030	M12X20*	100	55230.120.020
						M12X25*	100	55230.120.025
M5X6*	500	55230.050.006	M8X8*	200	55230.080.008	M12X30*	100	55230.120.030
M5X8	500	55230.050.008	M8X10*	200	55230.080.010	M12X40*	100	55230.120.040
M5X10*	500	55230.050.010	M8X12*	200	55230.080.012	M12X45*	100	55230.120.045
M5X12*	500	55230.050.012	M8X16*	200	55230.080.016			
M5X14*	500	55230.050.014	M8X20	200	55230.080.020	M16X40*	50	55230.160.040

Set screw with dog point UNC

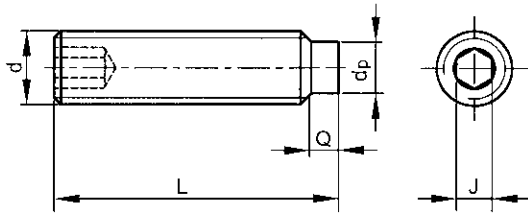
2

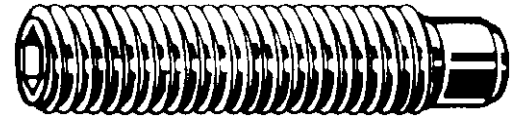

ASME ≈B18.3



Technical Data

d	d _p (max.)	J	Q (max.)	Threads per inch
No.8	0.109	5/64	0.043	32
No.10	0.127	3/32	0.049	24
1/4	0.156	1/8	0.067	20
5/16	0.203	5/32	0.082	18
3/8	0.250	3/16	0.099	16
1/2	0.344	1/4	0.13	13
5/8	0.469	5/16	0.164	11

U07820 Set screw with dog point UNC

X05A

Thread Material Unified National Coarse Steel



d x L	☒	Art.number	d x L	☒	Art.number	d x L	☒	Art.number
NO.8-32X3/16*	100	U07820.016.0018	1/4-20X5/16*	100	U07820.025.0031	3/8-16X5/8*	100	U07820.037.0062
NO.8-32X1/4*	100	U07820.016.0025	1/4-20X3/8*	100	U07820.025.0037	3/8-16X3/4*	100	U07820.037.0075
NO.8-32X5/16*	100	U07820.016.0031	1/4-20X1/2*	100	U07820.025.0050	3/8-16X1 Inch*	100	U07820.037.0100
NO.8-32X3/8*	100	U07820.016.0037	1/4-20X5/8*	100	U07820.025.0062	3/8-16X1.1/4*	100	U07820.037.0125
NO.8-32X1/2*	100	U07820.016.0050	1/4-20X3/4*	100	U07820.025.0075			
			1/4-20X1 Inch*	100	U07820.025.0100	1/2-13X1/2*	50	U07820.050.0050
NO.10-24X3/16*	100	U07820.019.0018				1/2-13X5/8*	50	U07820.050.0062
NO.10-24X1/4*	100	U07820.019.0025	5/16-18X5/16*	100	U07820.031.0031	1/2-13X3/4*	25	U07820.050.0075
NO.10-24X5/16*	100	U07820.019.0031	5/16-18X3/8*	100	U07820.031.0037	1/2-13X1 Inch*	25	U07820.050.0100
NO.10-24X3/8*	100	U07820.019.0037	5/16-18X1/2*	100	U07820.031.0050	1/2-13X1.1/4*	25	U07820.050.0125
NO.10-24X1/2*	100	U07820.019.0050						
			3/8-16X3/8*	100	U07820.037.0037	5/8-11X1 Inch*	10	U07820.062.0100
1/4-20X1/4*	100	U07820.025.0025	3/8-16X1/2*	100	U07820.037.0050	5/8-11X1.1/4*	10	U07820.062.0125

Hexagon socket set screw with nylon dog point

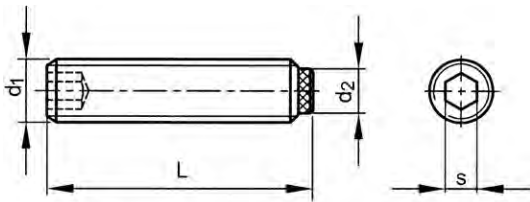



2

Technical Data

d ₁	d ₂	P	s	d ₁	d ₂	P	s
M4	2.5	0.7	2	M8	5.5	1.25	4
M5	3	0.8	2.5	M10	7	1.5	5
M6	4	1	3				

- These hexagon socket set screws with nylon dog point are suitable for pressure, without causing damage, e.g. threaded rods, studs and fasteners with a surface coating.

56949 Hexagon socket set screw with nylon dog point		W03A
Thread	Metric thread	 
Material	Steel	
Class	5.8	

d ₁ x L	☒	Art.number	d ₁ x L	☒	Art.number	d ₁ x L	☒	Art.number
M4X6,5	25	56949.040.006	M5X11	25	56949.050.011	M8X10	10	56949.080.010
M4X7	25	56949.040.007	M5X12,5	25	56949.050.012	M8X12	10	56949.080.012
M4X8	25	56949.040.008	M5X16	25	56949.050.016	M8X13,6	10	56949.080.013
M4X9	25	56949.040.009	M5X17	25	56949.050.017	M8X20	10	56949.080.020
M4X10,5	25	56949.040.010						
M4X11	25	56949.040.011	M6X10	25	56949.060.010	M10X16	10	56949.100.016
			M6X11,3	25	56949.060.011	M10X18	10	56949.100.018
M5X8,5	25	56949.050.008	M6X26,3	10	56949.060.026	M10X26,9	10	56949.100.026
M5X9	25	56949.050.009				M10X27	10	56949.100.027
M5X10	25	56949.050.010						

Hexagon socket set screw with cup point BSW

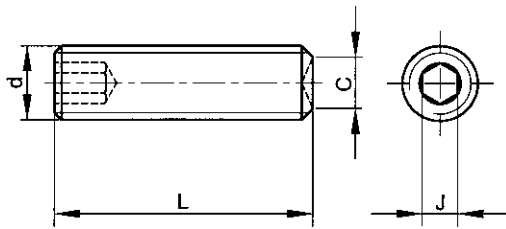

BS ≈2470
ASME ≈B18.3

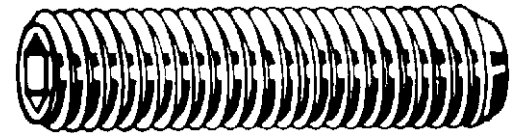

Technical Data

d	C	J	Threads per inch
1/2	7.3	1/4	12

07940 Hexagon socket set screw with cup point BSW

X08A

Thread British Standard Whitworth
Material Steel
Class 45H



d x L	☒	Art.number	d x L	☒	Art.number	d x L	☒	Art.number
1/2X1/2	100	07940.127.012	1/2X3/4	100	07940.127.020	1/2X1.1/2	50	07940.127.040
1/2X5/8	100	07940.127.016	1/2X1 Inch	50	07940.127.025			

• Warning: electro-galvanizing of these products may cause hydrogen embrittlement.

Hexagon socket set screw with oval point UNC

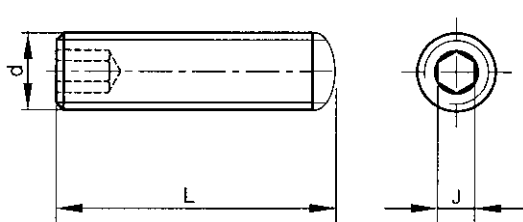

ASME ≈B18.3

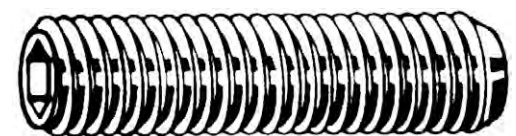

Technical Data

d	J	Threads per inch
No.6	1/16	32
No.8	5/64	32
No.10	3/32	24
1/4	1/8	20
5/16	5/32	18
3/8	3/16	16
1/2	1/4	13

U07845 Hexagon socket set screw with oval point UNC

X05A

Thread Unified National Coarse
Material Steel



d x L	☒	Art.number	d x L	☒	Art.number	d x L	☒	Art.number
NO.6-32X1/4*	100	U07845.013.0025	1/4-20X1/4*	100	U07845.025.0025	5/16-18X1/2*	100	U07845.031.0050
NO.6-32X5/16*	100	U07845.013.0031	1/4-20X5/16*	100	U07845.025.0031	5/16-18X5/8*	100	U07845.031.0062
NO.6-32X3/8*	100	U07845.013.0037	1/4-20X3/8*	100	U07845.025.0037	5/16-18X3/4*	100	U07845.031.0075
NO.8-32X3/16*	100	U07845.016.0018	1/4-20X1/2*	100	U07845.025.0050	5/16-18X1 Inch*	100	U07845.031.0100
NO.8-32X1/4*	100	U07845.016.0025	1/4-20X5/8*	100	U07845.025.0062	3/8-16X3/8*	100	U07845.037.0037
NO.8-32X1/2*	100	U07845.016.0050	1/4-20X3/4*	100	U07845.025.0075	3/8-16X1/2*	100	U07845.037.0050
NO.10-24X3/16*	100	U07845.019.0018	1/4-20X1 Inch*	100	U07845.025.0100	3/8-16X5/8*	100	U07845.037.0062
NO.10-24X1/4*	100	U07845.019.0025				3/8-16X3/4*	100	U07845.037.0075
NO.10-24X3/8*	100	U07845.019.0037	5/16-18X1/4*	100	U07845.031.0025	3/8-16X1 Inch*	100	U07845.037.0100
NO.10-24X1/2*	100	U07845.019.0050	5/16-18X5/16*	100	U07845.031.0031			
			5/16-18X3/8*	100	U07845.031.0037	1/2-13X1/2*	50	U07845.050.0050

U07845 Hexagon socket set screw with oval point UNC								
d x L	Art.number	d x L	Art.number	d x L	Art.number			
1/2-13X5/8*	50	U07845.050.0062	1/2-13X3/4*	25	U07845.050.0075	1/2-13X1 Inch*	25	U07845.050.0100

Cover for hexagon socket screw

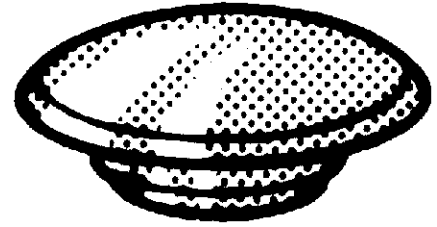
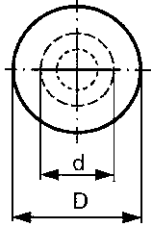

Technical Data

For use with	d	D	h	H	s
M5	4.3	9.1	1.5	2.8	4
M6	5.4	10.1	1.8	3.2	5
M8	6.3	13.1	2.4	3.8	6
M10	8.2	16	2.8	4.3	8
M12	10.5	18.2	3.4	5.5	10
M14	12.5	22.1	3.5	6.3	12
M16	14.5	23.8	3.8	7.5	14
M20	17.6	30.1	4.4	7.4	17

Examples of application

Special features for covers for hexagon socket screws:

- prevent corrosion and dirt accumulation in socket hole
- neat appearance
- easy to assemble and re-useable
- temperature resistant from -60°C up to +120°C
- colour traffic grey A RAL 7042
- **ATTENTION:** heads of hexagon socket screws can be **partly** covered by these covers

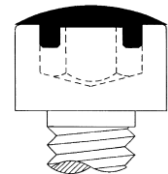

07760 Cover for hexagon socket screw		D91A
Material	Plastic Polyethylene	
Color	Grey	

For use with / s	Art.number	For use with / s	Art.number	For use with / s	Art.number
M5/s=4	100	07760.050.001	M10/s=8	100	07760.100.001
M6/s=5	100	07760.060.001	M12/s=10	100	07760.120.001
M8/s=6	100	07760.080.001	M14/s=12	100	07760.140.001
			M16/s=14	100	07760.160.001
			M20/s=17	50	07760.200.001

Hexagon socket pipe plug with external tapered screw thread MF

DIN 906

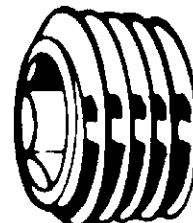
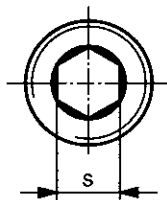
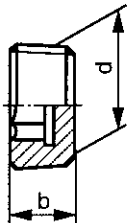

2

Technical Data

d	b (js16)	s (D12)	d	b (js16)	s (D12)
M8	8	4	M22	10	10
M10	8	5	M24	12	12
M12	10	6	M26	12	12
M14	10	7	M27	12	12
M16	10	8	M30	12	17
M18	10	8	M36	15	19
M20	10	10	M42	18	22

Article groups

Thread	Driving features	Material	Code	Page
MF	Hexagon socket	St	07660	2-92
MF	Hexagon socket	St.St. A2	51961	2-92
MF	Hexagon socket	St.St. A4	55961	2-92

07660 Hexagon socket pipe plug with external tapered screw thread MF

D90A

Thread Metric fine thread
Material Steel



d x P	Art.number	d x P	Art.number	d x P	Art.number
M8X1,00	50 07660.080.100	M18X1,50	25 07660.180.150	M26X1,50	25 07660.260.150
M10X1,00	50 07660.100.100	M20X1,50	25 07660.200.150	M30X1,50	10 07660.300.150
M12X1,50	50 07660.120.150	M22X1,50	25 07660.220.150	M36X1,50	10 07660.360.150
M14X1,50	50 07660.140.150	M24X1,50	25 07660.240.150	M42X1,50	10 07660.420.150
M16X1,50	50 07660.160.150				

51961 Hexagon socket pipe plug with external tapered screw thread MF

R09A

Thread Metric fine thread
Material Stainless steel A2



d x P	Art.number	d x P	Art.number	d x P	Art.number
M8X1,00*	50 51961.080.100	M18X1,50*	50 51961.180.150	M24X1,50*	10 51961.260.150
M10X1,00*	50 51961.100.100	M20X1,50*	25 51961.200.150	M27X2,00*	10 51961.270.200
M12X1,50*	50 51961.120.150	M22X1,50*	25 51961.220.150	M30X1,50*	10 51961.300.150
M14X1,50*	50 51961.140.150	M24X1,50*	25 51961.240.150	M30X2,00*	10 51961.300.200
M16X1,50*	50 51961.160.150				

55961 Hexagon socket pipe plug with external tapered screw thread MF

R49A

Thread Metric fine thread
Material Stainless steel A4



d x P	Art.number	d x P	Art.number	d x P	Art.number
M8X1,00*	50 55961.080.100	M16X1,50*	50 55961.160.150	M22X1,50*	25 55961.220.150
M10X1,00*	50 55961.100.100	M18X1,50*	50 55961.180.150	M24X1,50*	25 55961.240.150
M12X1,50*	50 55961.120.150	M20X1,50*	25 55961.200.150	M30X1,50*	10 55961.300.150
M14X1,50*	50 55961.140.150				

Hexagon socket pipe plug with external tapered pipe thread

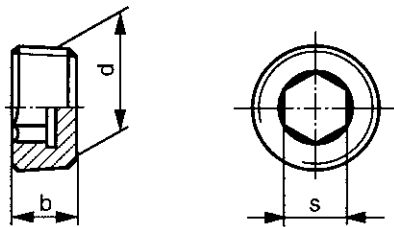

DIN 906

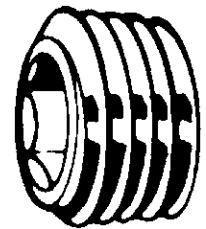

2

Technical Data

d	b (js16)	s (D12)	Threads per inch	d	b (js16)	s (D12)	Threads per inch
R1/8	8	5	28	R1 Inch	12	17	11
R1/4	10	7	19	R1.1/4	18	22	11
R3/8	10	8	19	R1.1/2	20	24	11
R1/2	10	10	14	R2 Inch	22	30	11
R3/4	12	12	14				

Article groups

Thread	Driving features	Material	Code	Page
R	Hexagon socket	St	07650	2-93
R	Hexagon socket	St.St. A2	51962	2-93
R	Hexagon socket	St.St. A4	55962	2-93

07650 Hexagon socket pipe plug with external tapered pipe thread				D90A
Thread	Conical pipe thread			
Material	Steel			
				

d	☒	Art.number	d	☒	Art.number	d	☒	Art.number
R1/8	100	07650.031.001	R1/2	50	07650.127.001	R1.1/4	10	07650.317.001
R1/4	50	07650.063.001	R3/4	25	07650.191.001	R1.1/2	10	07650.381.001
R3/8	50	07650.096.001	R1 Inch	25	07650.254.001	R2 Inch	10	07650.508.001

51962 Hexagon socket pipe plug with external tapered pipe thread				R09A
Thread	Conical pipe thread			
Material	Stainless steel A2			
				

d	☒	Art.number	d	☒	Art.number	d	☒	Art.number
R1/8*	50	51962.031.001	R1/2*	25	51962.127.001	R1 Inch*	10	51962.254.001
R1/4*	50	51962.063.001	R3/4*	25	51962.191.001	R1.1/4*	5	51962.317.001
R3/8*	50	51962.096.001						

55962 Hexagon socket pipe plug with external tapered pipe thread				R49A
Thread	Conical pipe thread			
Material	Stainless steel A4			
				

d	☒	Art.number	d	☒	Art.number	d	☒	Art.number
R1/8*	50	55962.031.001	R1/2*	25	55962.127.001	R1.1/4*	5	55962.317.001
R1/4*	50	55962.063.001	R3/4*	25	55962.191.001	R1.1/2*	5	55962.381.001
R3/8*	50	55962.096.001	R1 Inch*	10	55962.254.001			

Hexagon socket screw plug MF

2

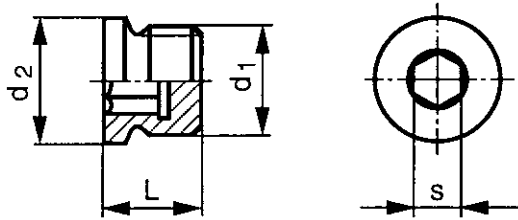

DIN 908

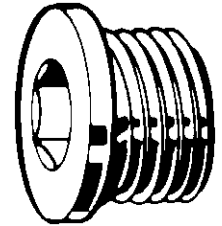



Technical Data

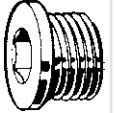

d_1	d_2 (h14)	$L \approx$	s (D12)	d_1	d_2 (h14)	$L \approx$	s (D12)
M8 (#DIN)	12	10	4	M30	36	20	17
M10	14	11	5	M33	39	21	17
M12	17	15	6	M36	42	21	19
M14	19	15	6	M38	44	21	19
M16	21	15	8	M42	49	21	22
M18	23	16	8	M45	52	21	22
M20	25	18	10	M48	55	21	24
M22	27	18	10	M52	60	21	24
M24	29	18	12	M56	64	25	32
M26	31	20	12	M60	68	25	32
M27	32	20	12	M64	72	25	32

Article groups

Thread	Driving features	Material	Code	Page
MF	Hexagon socket	St	07640	2-94
MF	Hexagon socket	St.St. A4	55963	2-94

07640 Hexagon socket screw plug MF		D90A
Thread	Metric fine thread	
Material	Steel	
		

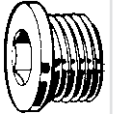
d_1 x P	☒	Art.number	d_1 x P	☒	Art.number	d_1 x P	☒	Art.number
M8X1,00	50	07640.080.100	M26X1,50	25	07640.260.150	M45X1,50	10	07640.450.150
M10X1,00	50	07640.100.100	M27X2,00	25	07640.270.200	M45X2,00	10	07640.450.200
M12X1,50	50	07640.120.150	M30X1,50	10	07640.300.150	M48X1,50	10	07640.480.150
M14X1,50	50	07640.140.150	M33X2,00	10	07640.330.200	M48X2,00	10	07640.480.200
M16X1,50	50	07640.160.150	M36X1,50	10	07640.360.150	M52X1,50	5	07640.520.150
M18X1,50	25	07640.180.150	M36X2,00	10	07640.360.200	M52X2,00	5	07640.520.200
M20X1,50	25	07640.200.150	M38X1,50	10	07640.380.150	M56X2,00	5	07640.560.200
M22X1,50	25	07640.220.150	M42X1,50	10	07640.420.150	M60X2,00	3	07640.600.200
M24X1,50	25	07640.240.150	M42X2,00	10	07640.420.200	M64X2,00	3	07640.640.200

55963 Hexagon socket screw plug MF		R49A
Thread	Metric fine thread	
Material	Stainless steel A4	
		

d_1 x P	☒	Art.number	d_1 x P	☒	Art.number	d_1 x P	☒	Art.number
M10X1,00	50	55963.100.100	M18X1,50*	50	55963.180.150	M26X1,50*	10	55963.260.150
M12X1,50*	50	55963.120.150	M20X1,50*	25	55963.200.150	M27X2,00*	10	55963.270.200
M14X1,50*	50	55963.140.150	M22X1,50*	25	55963.220.150	M30X1,50*	10	55963.300.150
M16X1,50*	50	55963.160.150	M24X1,50*	25	55963.240.150	M30X2,00*	10	55963.300.200

Hexagon socket screw plug pipe thread

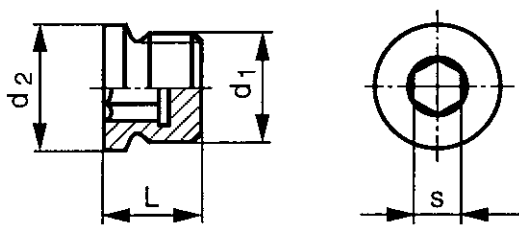

DIN 908

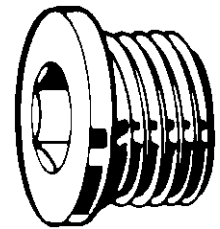

2

Technical Data

d_1	d_2 (h14)	$L \approx$	s (D12)	Threads per inch
G1/8A	14	11	5	28
G1/4A	18	15	6	19
G3/8A	22	15	8	19
G1/2A	26	18	10	14
G3/4A	32	20	12	14
G1 Inch.A	39	21	17	11
G1.1/4A	49	21	22	11
G1.1/2A	55	21	24	11
G1.3/4A	62	25	32	11
G2 Inch.A	68	25	32	11

Article groups

Thread	Driving features	Material	Code	Page
G	Hexagon socket	St	07620	2-95
G	Hexagon socket	St.St. A2	51964	2-95
G	Hexagon socket	St.St. A4	55964	2-95

07620 Hexagon socket screw plug pipe thread

D90A

Thread Cylindrical pipe thread
Material Steel

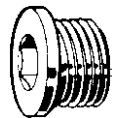

d_1	☒	Art.number	d_1	☒	Art.number	d_1	☒	Art.number
G1/8A	50	07620.031.001	G1/2A	50	07620.127.001	G1.1/4A	10	07620.317.001
G1/4A	50	07620.063.001	G3/4A	25	07620.191.001	G1.1/2A	10	07620.381.001
G3/8A	50	07620.096.001	G1 Inch.A	25	07620.254.001			

51964 Hexagon socket screw plug pipe thread

R09A

Thread Cylindrical pipe thread
Material Stainless steel A2

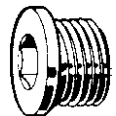

d_1	☒	Art.number	d_1	☒	Art.number	d_1	☒	Art.number
G1/8A*	50	51964.031.001	G1/2A*	25	51964.127.001	G1.1/4A*	5	51964.317.001
G1/4A*	50	51964.063.001	G3/4A*	25	51964.191.001	G1.1/2A*	5	51964.381.001
G3/8A*	50	51964.096.001	G1 Inch.A*	10	51964.254.001	G2 Inch.A*	5	51964.508.001

55964 Hexagon socket screw plug pipe thread

R49A

Thread Cylindrical pipe thread
Material Stainless steel A4

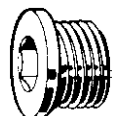

d_1	☒	Art.number	d_1	☒	Art.number	d_1	☒	Art.number
G1/8A*	50	55964.031.001	G3/4A*	25	55964.191.001	G1.1/2A*	5	55964.381.001
G1/4A*	50	55964.063.001	G1 Inch.A*	10	55964.254.001	G1.3/4A*	5	55964.444.001
G3/8A	50	55964.096.001	G1.1/4A*	5	55964.317.001	G2 Inch.A*	5	55964.508.001
G1/2A*	25	55964.127.001						

Hexagon head screw plug MF

DIN 910

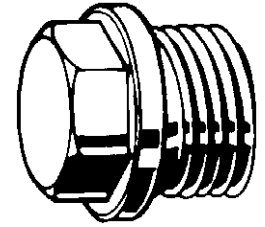
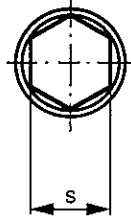
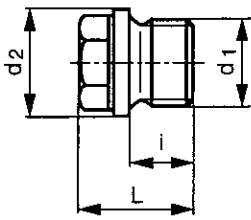

2

Technical Data

d_1	d_2 (h14)	i	$L \approx$	s	d_1	d_2 (h14)	i	$L \approx$	s
M8 (#DIN)	14	8	17	10	M22	27	14	26	19
M10	14	8	17	10	M24	29	14	27	22
M12	17	12	21	13	M26	31	16	30	24
M14	19	12	21	13	M27	32	16	30	24
M16	21	12	21	17	M30	36	16	30	24
M18	23	12	24	17	M36	42	16	32	27
M20	25	14	26	19	M42	49	16	33	30

Article groups

Thread	Driving features	Material	Code	Page
MF	Hexagon	St	07680	2-96
MF	Hexagon	St.St. A2	51965	2-96
MF	Hexagon	St.St. A4	55965	2-96

07680 Hexagon head screw plug MF

D90A

Thread Metric fine thread
Material Steel

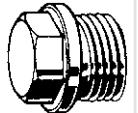

d_1 x P	☒	Art.number	d_1 x P	☒	Art.number	d_1 x P	☒	Art.number
M8X1,00	50	07680.080.100	M18X1,50	25	07680.180.150	M26X1,50	25	07680.260.150
M10X1,00	50	07680.100.100	M20X1,50	25	07680.200.150	M30X1,50	10	07680.300.150
M12X1,50	50	07680.120.150	M22X1,50	25	07680.220.150	M36X1,50	10	07680.360.150
M14X1,50	50	07680.140.150	M24X1,50	25	07680.240.150	M42X1,50	10	07680.420.150
M16X1,50	50	07680.160.150						

51965 Hexagon head screw plug MF

R09A

Thread Metric fine thread
Material Stainless steel A2

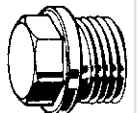

d_1 x P	☒	Art.number	d_1 x P	☒	Art.number	d_1 x P	☒	Art.number
M10X1,00*	50	51965.100.100	M18X1,50*	50	51965.180.150	M26X1,50*	10	51965.260.150
M12X1,50*	50	51965.120.150	M20X1,50*	25	51965.200.150	M27X2,00*	10	51965.270.200
M14X1,50*	50	51965.140.150	M22X1,50*	25	51965.220.150	M30X1,50*	10	51965.300.150
M16X1,50*	50	51965.160.150	M24X1,50*	25	51965.240.150			

55965 Hexagon head screw plug MF

R49A

Thread Metric fine thread
Material Stainless steel A4

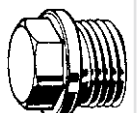

d_1 x P	☒	Art.number	d_1 x P	☒	Art.number	d_1 x P	☒	Art.number
M10X1,00	25	55965.100.100	M18X1,50	10	55965.180.150	M26X1,50*	10	55965.260.150
M12X1,50	25	55965.120.150	M20X1,50	10	55965.200.150	M27X2,00*	10	55965.270.200
M14X1,50	25	55965.140.150	M22X1,50	10	55965.220.150	M30X1,50*	10	55965.300.150
M16X1,50	25	55965.160.150	M24X1,50	10	55965.240.150	M30X2,00*	5	55965.300.200

Hexagon head screw plug cylindrical pipe thread

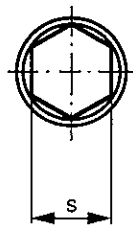
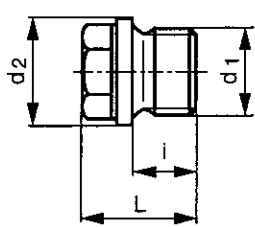

DIN 910

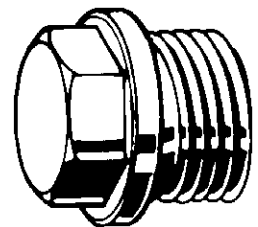

2

Technical Data

d ₁	d ₂ (h14)	i	L ≈	s	Threads per inch
G1/8A	14	8	17	10	28
G1/4A	18	12	21	13	19
G3/8A	22	12	21	17	19
G3/8Ax8	22	8	17	17	19
G1/2A	26	14	26	19	14
G5/8A (#DIN)	28	14	26	19	14
G3/4A	32	16	30	24	14
G3/4Ax12	32	12	26	24	14
G1 Inch.A	39	16	32	27	11
G1.1/8A	44	16	32	27	11
G1.1/4A	49	16	33	30	11
G1.1/2A	55	16	33	30	11
G1.3/4A	62	20	40	36	11
G2 Inch.A	68	20	40	36	11
G2.1/2A (#DIN)	85	20	40	36	11

Article groups

Thread	Driving features	Material	Code	Page
G	Hexagon	St	07670	2-97
G	Hexagon	St.St. A2	51966	2-97
G	Hexagon	St.St. A4	55966	2-98
G	Hexagon	Br	47220	2-98

07670 Hexagon head screw plug cylindrical pipe thread

D90A

Thread Cylindrical pipe thread
Material Steel

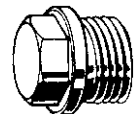

d ₁	Art.number	d ₁	Art.number	d ₁	Art.number
G1/8A	50 07670.031.001	G1/2A	50 07670.127.001	G1.1/4A	10 07670.317.001
G1/4A	50 07670.063.001	G3/4A	25 07670.191.001	G1.1/2A	10 07670.381.001
G3/8A	50 07670.096.001	G3/4AX12	25 07670.191.012	G2 Inch.A	10 07670.508.001
G3/8Ax8	50 07670.096.008	G1 Inch.A	25 07670.254.001	G2.1/2A (#DIN)	10 07670.635.001

51966 Hexagon head screw plug cylindrical pipe thread

R09A

Thread Cylindrical pipe thread
Material Stainless steel A2

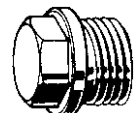

d ₁	Art.number	d ₁	Art.number	d ₁	Art.number
G1/8A*	50 51966.031.001	G1/2A*	25 51966.127.001	G1.1/4A*	5 51966.317.001
G1/4A*	50 51966.063.001	G3/4A*	25 51966.191.001	G1.1/2A*	5 51966.381.001
G3/8A*	50 51966.096.001	G1 Inch.A*	10 51966.254.001	G2 Inch.A*	5 51966.508.001

55966 Hexagon head screw plug cylindrical pipe thread R49A

Thread Cylindrical pipe thread
Material Stainless steel A4

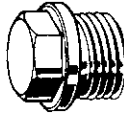
d ₁	☒	Art.number	d ₁	☒	Art.number	d ₁	☒	Art.number
G1/8A	50	55966.031.001	G5/8A*	25	55966.158.001	G1.1/4A	5	55966.317.001
G1/4A	25	55966.063.001	G3/4A	10	55966.191.001	G1.1/2A*	5	55966.381.001
G3/8A	25	55966.096.001	G1 Inch.A	10	55966.254.001	G1.3/4A*	5	55966.444.001
G1/2A	25	55966.127.001	G1.1/8A*	5	55966.285.001	G2 Inch.A*	5	55966.508.001

47220 Hexagon head screw plug cylindrical pipe thread M01A

Thread Cylindrical pipe thread
Material Brass



d ₁	☒	Art.number	d ₁	☒	Art.number	d ₁	☒	Art.number
G1/4A	100	47220.063.001	G1/2A	50	47220.127.001	G1 Inch.A	10	47220.254.001
G3/8A	50	47220.096.001	G3/4A	25	47220.191.001			

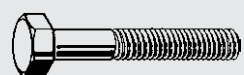

1 Bolts



2 Hexagon socket products



3 Nuts, rivet nuts & inserts



4 Threaded rods & studbolts



5 Hook & eye products



6 Screws

I Index



7 Washers & O-rings



8 Anchoring products

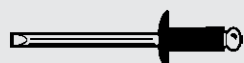

9 Rivets, pins & keys



10 Systems, furniture & security fasteners



11 Assortments & storage systems

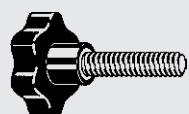

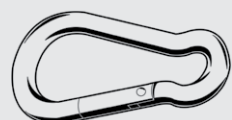

12 Engineering parts & machine parts



13 Maritime products

T Fastening technology

Nuts, rivet nuts & inserts 3

 Page 3-5 DIN 934 (1987) DIN Metric	 Page 3-14 DIN 934 (1987) Metric fine	 Page 3-17 ISO 4032 ISO Metric	 Page 3-20 ASME ≈B18.2.2 UNC	 Page 3-23 ASME ≈B18.2.2 Machine screw nut UNC
 Page 3-23 ASME ≈B18.2.2 UNF	 Page 3-26 ASME ≈B18.2.2 Machine screw nut UNF	 Page 3-27 DIN ≈934 (1954) BSW	 Page 3-28 BS ≈1083 (1965) BSF	 Page 3-29 DIN ≈934 (1987) 1xd Metric
 Page 3-30 DIN ≈934 (1954) 1xd BSW	 Page 3-31 DIN 555 (1987) ≥ 4 Metric	 Page 3-32 DIN 439 B (1987) Metric	 Page 3-35 DIN 439 B (1987) Metric fine	 Page 3-38 DIN 936 Metric
 Page 3-39 DIN 936 Metric fine	 Page 3-39 ISO 4035 Metric	 Page 3-40 ASME ≈B18.2.2 UNC	 Page 3-40 DIN 431 A Pipe thread	 Page 3-41 Trackshoe nut UNF
 Page 3-42 Exhaust nut	 Page 3-43 DIN 6334 3xd Metric	 Page 3-45 High Metric	 Page 3-46 With internal en external thread	 Page 3-47 With 2x internal thread
 Page 3-47 Reducer	 Page 3-48 DIN 985 (1987) Metric	 Page 3-52 DIN 985 (1987) Metric fine	 Page 3-53 DIN 982 High Metric	 Page 3-55 ASME B18.16.6 NE UNC
 Page 3-57 ASME B18.16.6 NTE UNC	 Page 3-58 ASME B18.16.6 NTE UNF	 Page 3-59 ASME B18.16.6 NU UNC	 Page 3-60 ASME B18.16.6 NTU UNC	 Page 3-61 ASME B18.16.6 NE UNF
 Page 3-63 BSW	 Page 3-63 BSF	 Page 3-64 Stainless steel Metric	 Page 3-65 Plastic, Metric	 Page 3-65 DIN 980V(1987) Metric
 Page 3-67 DIN 980V(1987) Metric fine	 Page 3-68 IFI 100/107 Toplock UNC	 Page 3-69 IFI 100/107 Toplock UNF	 Page 3-71 Type H100-ESN Metric	 Page 3-72 Type H130-ESN Metric
 Page 3-73 Type USN Metric	 Page 3-73 RIPP Metric	 Page 3-74 SECURIT Metric	 Page 3-75 Self-locking hexagon nut	 Page 3-76 DIN 6923 (1983) With flange Metric

Nuts, rivet nuts & inserts **3**

3



 <p>Page 3-78 DIN ≈6923</p> <p>With toothed flange Metric</p>	 <p>Page 3-80 IFI 100/107</p> <p>With flange UNC</p>	 <p>Page 3-81 DIN 6926</p> <p>With plastic insert Metric</p>	 <p>Page 3-82 DIN ≈6926</p> <p>With flange serrated</p>	 <p>Page 3-83</p> <p>NORD-LOCK</p>
 <p>Page 3-83</p> <p>With conical washer</p>	 <p>Page 3-84</p> <p>COMBY Metric</p>	 <p>Page 3-84 DIN 7967</p> <p>PAL Metric</p>	 <p>Page 3-86 DIN 935-1</p> <p>Metric</p>	 <p>Page 3-88 DIN 935</p> <p>Metric fine</p>
 <p>Page 3-89 DIN 979</p> <p>Low Metric</p>	 <p>Page 3-90 DIN 937</p> <p>Low Metric</p>	 <p>Page 3-91 DIN 979</p> <p>Low Metric fine</p>	 <p>Page 3-92 BS ≈1768</p> <p>UNF</p>	 <p>Page 3-94</p> <p>KALEI Metric</p>
 <p>Page 3-96</p> <p>Round Metric</p>	 <p>Page 3-97 DIN 1587 (1987)</p> <p>Metric</p>	 <p>Page 3-99</p> <p>BSW</p>	 <p>Page 3-100</p> <p>Welded cap Metric</p>	 <p>Page 3-101 DIN 917</p> <p>Low Metric</p>
 <p>Page 3-102 DIN 986</p> <p>With plastic insert Metric</p>	 <p>Page 3-103 ASME ≈B18.17</p> <p>American model Metric</p>	 <p>Page 3-104 DIN 315</p> <p>Round wings Metric</p>	 <p>Page 3-106 DIN ≈313 (1956)</p> <p>BSW</p>	 <p>Page 3-107 DIN 80701</p> <p>Toggle nut</p>
 <p>Page 3-107 DIN 80704</p> <p>Bow nut</p>	 <p>Page 3-108</p> <p>With collar Metric, plastic</p>	 <p>Page 3-108</p> <p>Metric, plastic</p>	 <p>Page 3-109 DIN 929</p> <p>Hexagon Metric</p>	 <p>Page 3-110</p> <p>With flange Metric</p>
 <p>Page 3-111</p> <p>Spot welded Metric</p>	 <p>Page 3-112 DIN 928</p> <p>Square Metric</p>	 <p>Page 3-113 DIN 466</p> <p>High Metric</p>	 <p>Page 3-114 DIN 467</p> <p>Low Metric</p>	 <p>Page 3-115</p> <p>Metric, plastic</p>
 <p>Page 3-116 DIN 562</p> <p>Low Metric</p>	 <p>Page 3-117 DIN 557</p> <p>Metric</p>	 <p>Page 3-118</p> <p>Metric</p>	 <p>Page 3-119</p> <p>Type SMG</p>	 <p>Page 3-120</p> <p>Speednut</p>
 <p>Page 3-121</p> <p>Jacknut</p>	 <p>Page 3-122 DIN 1804 W</p> <p>For hook spanner Metric</p>	 <p>Page 3-123 DIN 546</p> <p>With slot Metric</p>	 <p>Page 3-124</p> <p>Round Metric</p>	 <p>Page 3-125</p> <p>Type GUK Metric fine</p>
 <p>Page 3-126</p> <p>With slot Metric</p>	 <p>Page 3-128</p> <p>Cylindrical</p>	 <p>Page 3-129</p> <p>Cylindrical Stainless steel</p>	 <p>Page 3-130</p> <p>Cylindrical hexagonal Stainless steel</p>	 <p>Page 3-131</p> <p>Countersunk Steel</p>

Nuts, rivet nuts & inserts 3

 Page 3-132 Countersunk Stainless steel	 Page 3-133 Countersunk	 Page 3-134 Reduced countersunk Steel	 Page 3-134 Reduced countersunk Stainless steel	 Page 3-135 Reduced countersunk Aluminium
 Page 3-135 Reduced countersunk hexagonal Steel	 Page 3-136 Reduced countersunk hexagonal	 Page 3-136 Cylindrical closed Steel	 Page 3-137 Cylindrical closed Aluminium	 Page 3-138 Countersunk closed Steel
 Page 3-139 Blind rivet screw cylindrical Steel zinc	 Page 3-140 Blind rivet nut hand tool FABORY	 Page 3-141 Set	 Page 3-143 AMECOIL Machine tap Metric	 Page 3-144 AMECOIL Machine tap Metric fine
 Page 3-144 AMECOIL Machine tap spark plug Metric fine	 Page 3-145 AMECOIL Machine tap UNC	 Page 3-145 AMECOIL Machine tap UNF	 Page 3-146 DIN 8140-1A AMECOIL Metric	 Page 3-147 DIN 8140-1A AMECOIL Metric fine
 Page 3-147 DIN 8140-1A AMECOIL Metric extra fine	 Page 3-148 AMECOIL UNC	 Page 3-149 AMECOIL UNF	 Page 3-149 AMECOIL Metric	 Page 3-150 AMECOIL Metric fine
 Page 3-150 AMECOIL Metric extra fine	 Page 3-151 AMECOIL UNC	 Page 3-152 AMECOIL UNF	 Page 3-152 AMECOIL BSW	 Page 3-153 AMECOIL Assortment
 Page 3-154 AMECOIL Metric/Non Metric	 Page 3-155 AMECOIL Complete Metric	 Page 3-156 AMECOIL Metric	 Page 3-158 AMECOIL Carrier adapter	 Page 3-159 AMECOIL Tang breaking tool
 Page 3-159 AMECOIL Extractor	 Page 3-160 V-COIL Metric Rapid	 Page 3-160 V-COIL Metric	 Page 3-161 V-COIL Non-metric	 Page 3-162 V-COIL Spark plug
 Page 3-163 V-COIL Assortment Metric	 Page 3-164 V-COIL Assortment Metric Rapid	 Page 3-164 V-COIL Assortment Non-Metric	 Page 3-166 Tools V-COIL	 Page 3-169 Tools V-COIL Rapid
 Page 3-172 Type 302	 Page 3-173 Type 307-308	 Page 3-174 Type 302 2	 Page 3-175 Type 308 2	 Page 3-176 Type 610

Nuts, rivet nuts & inserts **3**

3

 Type 620	 Type 620	 Type 6102
---	---	--

Hexagon nut

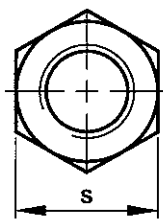
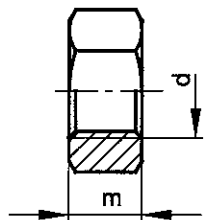

DIN 934 (1987)
NEN 1560
NF E25-401

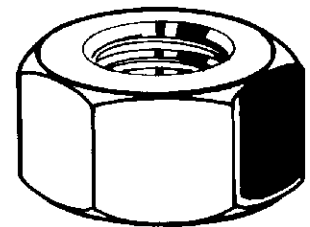

Technical Data

d	m	P	s	d	m	P	s
M1	0.8	0.25	2.5	M20	16	2.5	30
M1.2	1	0.25	3	M22	18	2.5	32
M1.4	1.2	0.3	3	M24	19	3	36
M1.6	1.3	0.35	3.2	M27	22	3	41
M1.7 (#DIN)	1.4	0.35	3.5	M30	24	3.5	46
M2	1.6	0.4	4	M33	26	3.5	50
M2.3 (#DIN)	1.8	0.4	4.5	M36	29	4	55
M2.5	2	0.45	5	M39	31	4	60
M2.6 (#DIN)	2	0.45	5	M42	34	4.5	65
M3	2.4	0.5	5.5	M45	36	4.5	70
M3.5	2.8	0.6	6	M48	38	5	75
M4	3.2	0.7	7	M52	42	5	80
M5	4	0.8	8	M56	45	5.5	85
M6	5	1	10	M60	48	5.5	90
M7	5.5	1	11	M64	51	6	95
M8	6.5	1.25	13	M68	54	6	100
M10 (#DIN)	8	1.5	15	M72X6	58	6	105
M10	8	1.5	17	M76X6	61	6	110
M12	10	1.75	19	M80X6	64	6	115
M14	11	2	22	M90X6	72	6	130
M16	13	2	24	M100X6	80	6	145
M18	15	2.5	27	M110X6	88	6	155

Article groups

Thread	Driving features	Material	Class	Surface treatment	Color	Code	Page
M	Hexagon	St	8			01100	3-6
M	Hexagon	St	8		large pack	01110	3-6
M	Hexagon	St	8		left hand	11040	3-6
M	Hexagon	St	8	ZNTHP-NC6		01325	3-6
M	Hexagon	St	8	Zipl		01300	3-7
M	Hexagon	St	8	Zipl	large pack	01310	3-7
M	Hexagon	St	8	Zipl	left hand	11042	3-7
M	Hexagon	St	8	Zipl yell.p.		01320	3-7
M	Hexagon	St	8	Zipl blk p.		01326	3-7
M	Hexagon	St	8	FLZNNC-NC6		01336	3-8
M	Hexagon	St	8	Hot d.g.	ISO metric	01500	3-8
M	Hexagon	St	8	Hot d.g.	oversized	01560	3-8
M	Hexagon	St	10			04120	3-8
M	Hexagon	St	10	Zipl		04121	3-9
M	Hexagon	St	10	Zipl yell.p.		04122	3-9
M	Hexagon	St	10	Hot d.g.	oversized	04119	3-9
M	Hexagon	St	10	FLZNNC-NC6		04125	3-9
M	Hexagon	St	12			04190	3-9
M	Hexagon	Free-cutting steel	6	Zipl	turned	11300	3-10
M	Hexagon	St.St. A2	70			51080	3-10
M	Hexagon	St.St. A2	70		large pack	51100	3-10
M	Hexagon	St.St. A2	70	COMBIFLON		51082	3-10
M	Hexagon	St.St. A2	70	METALFORM		51089	3-11
M	Hexagon	St.St. A2	70		left hand	51162	3-11
M	Hexagon	St.St. A2	80			53080	3-11
M	Hexagon	St.St. A4	70			55080	3-11
M	Hexagon	St.St. A4	70		large pack	55100	3-12
M	Hexagon	St.St. A4	80			53580	3-12
M	Hexagon	St.St. A4	80		left hand	53162	3-12
M	Hexagon	St.St. A5	70			55089	3-12
M	Hexagon	Al P40				45080	3-12
M	Hexagon	Al P60		Yell a.		45280	3-13

Article groups

Thread	Driving features	Material	Class	Surface treatment	Color	Code	Page
M	Hexagon	Kuprodur Cu5	60			45850	3-13
M	Hexagon	Ti	Gr.2			45920	3-13
M	Hexagon	Br Cu2/Cu3				47000	3-13
M	Hexagon	Br Cu2/Cu3		Ni.pl.		47050	3-13
M	Hexagon	Plastic PA	PA 6.6		White	56200	3-14

3

01100 Hexagon nut A01B

Thread	Metric thread		
Material	Steel		
Class	8		

d	☒	Art.number	d	☒	Art.number	d	☒	Art.number
M2,5	250	01100.025.001	M20	50	01100.200.001	M52	1	01100.520.001
M3	250	01100.030.001	M22	25	01100.220.001	M56	1	01100.560.001
M4	250	01100.040.001	M24	25	01100.240.001	M60	1	01100.600.001
M5	250	01100.050.001	M27	10	01100.270.001	M64	1	01100.640.001
M6	250	01100.060.001	M30	10	01100.300.001	M68	1	01100.680.001
M7	250	01100.070.001	M33	5	01100.330.001	M72X6,00	1	01100.720.001
M8	250	01100.080.001	M36	5	01100.360.001	M76X6,00	1	01100.760.001
M10	250	01100.100.001	M39	5	01100.390.001	M80X6,00	1	01100.800.001
M12	100	01100.120.001	M42	5	01100.420.001	M90X6,00	1	01100.900.001
M14	100	01100.140.001	M45	4	01100.450.001	M100X6,00	1	01100.982.001
M16	100	01100.160.001	M48	4	01100.480.001	M110X6,00	1	01100.984.001
M18	50	01100.180.001						

01110 Hexagon nut A01B

Thread	Metric thread		
Material	Steel		
Class	8		

d	☒	Art.number	d	☒	Art.number	d	☒	Art.number
M3	2500	01110.030.001	M10	1000	01110.100.001	M20	150	01110.200.001
M4	2500	01110.040.001	M12	700	01110.120.001	M24	50	01110.240.001
M5	2500	01110.050.001	M14	400	01110.140.001	M27	50	01110.270.001
M6	2000	01110.060.001	M16	300	01110.160.001	M30	50	01110.300.001
M8	2000	01110.080.001	M18	200	01110.180.001	M68	5	01110.680.001

11040 Hexagon nut left hand thread F01A

Thread	Metric thread		
Material	Steel		
Class	8		

d	☒	Art.number	d	☒	Art.number	d	☒	Art.number
M4	250	11040.040.001	M14	50	11040.140.001	M30	5	11040.300.001
M5	250	11040.050.001	M16	50	11040.160.001	M33	2	11040.330.001
M6	250	11040.060.001	M18	25	11040.180.001	M36	2	11040.360.001
M8	100	11040.080.001	M20	25	11040.200.001	M39	2	11040.390.001
M10	100	11040.100.001	M22	10	11040.220.001	M42	2	11040.420.001
M10 s=15	100	11040.100.150	M24	10	11040.240.001	M48	2	11040.480.001
M12	50	11040.120.001	M27	5	11040.270.001			

01325 Hexagon nut A95A

Thread	Metric thread		
Material	Steel		
Class	8		
Surface treatment	Galvanized thick Cr ³⁺ passivated		

d	☒	Art.number	d	☒	Art.number	d	☒	Art.number
M4	250	01325.040.001	M8	250	01325.080.001	M12	100	01325.120.001
M5	250	01325.050.001	M10	250	01325.100.001	M16	100	01325.160.001
M6	250	01325.060.001						

01300 Hexagon nut		A05B
Thread	Metric thread	
Material	Steel	
Class	8	
Surface treatment	Zinc plated	
		

d	☒	Art.number	d	☒	Art.number	d	☒	Art.number
M2	1000	01300.020.001	M14	100	01300.140.001	M36	5	01300.360.001
M2,5	1000	01300.025.001	M16	100	01300.160.001	M39	5	01300.390.001
M3	250	01300.030.001	M18	50	01300.180.001	M42	5	01300.420.001
M4	250	01300.040.001	M20	50	01300.200.001	M45	4	01300.450.001
M5	250	01300.050.001	M22	25	01300.220.001	M48	4	01300.480.001
M6	250	01300.060.001	M24	25	01300.240.001	M52	1	01300.520.001
M7	250	01300.070.001	M27	10	01300.270.001	M56	1	01300.560.001
M8	250	01300.080.001	M30	10	01300.300.001	M60	1	01300.600.001
M10	250	01300.100.001	M33	5	01300.330.001	M64	1	01300.640.001
M12	100	01300.120.001						

01310 Hexagon nut		A05B
Thread	Metric thread	
Material	Steel	
Class	8	
Surface treatment	Zinc plated	
		

d	☒	Art.number	d	☒	Art.number	d	☒	Art.number
M3	2500	01310.030.001	M10	1000	01310.100.001	M20	150	01310.200.001
M4	2500	01310.040.001	M12	700	01310.120.001	M24	50	01310.240.001
M5	2500	01310.050.001	M14	400	01310.140.001	M27	50	01310.270.001
M6	2000	01310.060.001	M16	300	01310.160.001	M30	50	01310.300.001
M8	2000	01310.080.001	M18	200	01310.180.001			

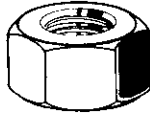
11042 Hexagon nut left hand thread		F01A
Thread	Metric thread	
Material	Steel	
Class	8	
Surface treatment	Zinc plated	
		

d	☒	Art.number	d	☒	Art.number	d	☒	Art.number
M4	250	11042.040.001	M8	100	11042.080.001	M16	50	11042.160.001
M5	250	11042.050.001	M10	100	11042.100.001	M24	25	11042.240.001
M6	250	11042.060.001	M12	50	11042.120.001			



01320 Hexagon nut		A06A
Thread	Metric thread	
Material	Steel	
Class	8	
Surface treatment	Zinc plated yellow passivated	



d	☒	Art.number	d	☒	Art.number	d	☒	Art.number
M3	250	01320.030.001	M12	100	01320.120.001	M27	10	01320.270.001
M4	250	01320.040.001	M14	100	01320.140.001	M30	10	01320.300.001
M5	250	01320.050.001	M16	100	01320.160.001	M33	5	01320.330.001
M6	250	01320.060.001	M18	50	01320.180.001	M36	5	01320.360.001
M7	250	01320.070.001	M20	50	01320.200.001	M39	5	01320.390.001
M8	250	01320.080.001	M22	25	01320.220.001	M42	5	01320.420.001
M10	250	01320.100.001	M24	25	01320.240.001			

01326 Hexagon nut		A06A
Thread	Metric thread	
Material	Steel	
Class	8	
Surface treatment	Zinc plated black passivated	

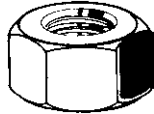

d	☒	Art.number	d	☒	Art.number	d	☒	Art.number
M3	250	01326.030.001	M5	250	01326.050.001	M8	250	01326.080.001
M4	250	01326.040.001	M6	250	01326.060.001	M10	250	01326.100.001

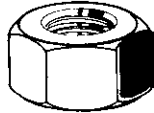
01326 Hexagon nut								
d	☒	Art.number	d	☒	Art.number	d	☒	Art.number
M12	100	01326.120.001	M16	100	01326.160.001	M24	25	01326.240.001
M14	100	01326.140.001	M20	50	01326.200.001			

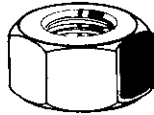

01336 Hexagon nut								A96A
Thread	Metric thread							
Material	Steel							
Class	8							
Surface treatment	Zinc flake Cr ⁶⁺ free - ISO 10683 flZnnc							
								
d	☒	Art.number	d	☒	Art.number	d	☒	Art.number
M4	250	01336.040.001	M12	700	01336.120.001	M22	125	01336.220.001
M5	250	01336.050.001	M14	400	01336.140.001	M24	50	01336.240.001
M6	2000	01336.060.001	M16	300	01336.160.001	M27	50	01336.270.001
M8	2000	01336.080.001	M18	200	01336.180.001	M30	50	01336.300.001
M10	1000	01336.100.001	M20	150	01336.200.001	M36	25	01336.360.001

01500 Hexagon nut ISO-Metric fitting thread								A08A
Thread	Metric thread							
Material	Steel							
Class	8							
Surface treatment	Hot dip galvanized							
								
d	☒	Art.number	d	☒	Art.number	d	☒	Art.number
M6	100	01500.060.001	M18	50	01500.180.001	M33	5	01500.330.001
M8	100	01500.080.001	M20	50	01500.200.001	M36	5	01500.360.001
M10	100	01500.100.001	M22	50	01500.220.001	M39	3	01500.390.001
M12	100	01500.120.001	M24	50	01500.240.001	M42	3	01500.420.001
M14	100	01500.140.001	M27	10	01500.270.001	M45	4	01500.450.001
M16	50	01500.160.001	M30	10	01500.300.001	M48	4	01500.480.001

- These hexagon nuts are used among other to hot dip galvanized bolts and screws with ISO-METRIC FITTING thread and to hot dip galvanized threaded rods with ISO-METRIC FITTING thread.
- The nuts are tapped AFTER galvanizing and meet the tolerances 6H.
- The corrosion resistance is not influenced disadvantageously, with assembled nuts, by the uncoated thread.

01560 Hexagon nut oversized thread								A08A
Thread	Metric thread							
Material	Steel							
Class	8							
Surface treatment	Hot dip galvanized							
								
d	☒	Art.number	d	☒	Art.number	d	☒	Art.number
M8	250	01560.080.001	M22	25	01560.220.001	M42	5	01560.420.001
M10	250	01560.100.001	M24	25	01560.240.001	M45	4	01560.450.001
M12	100	01560.120.001	M27	25	01560.270.001	M48	4	01560.480.001
M14	100	01560.140.001	M30	10	01560.300.001	M52	1	01560.520.001
M16	100	01560.160.001	M33	5	01560.330.001	M56	1	01560.560.001
M18	50	01560.180.001	M36	5	01560.360.001	M60	1	01560.600.001
M20	50	01560.200.001	M39	5	01560.390.001	M64	1	01560.640.001

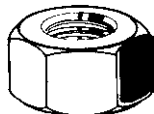
- These hexagon nuts are used among other to hot dip galvanized hexagon bolts with OVERSIZED thread and to hot dip galvanized threaded rods with OVERSIZED thread.
- After the zinc coating, the nuts are being oversized tapped according to ISO 965-5 resulting in a perfect fit for, hot-dip galvanized, oversized thread.
- The corrosion resistance is not influenced disadvantageously, with assembled nuts, by the uncoated thread.

04120 Hexagon nut								C01C
Thread	Metric thread							
Material	Steel							
Class	10							
Surface treatment								
								
d	☒	Art.number	d	☒	Art.number	d	☒	Art.number
M5	250	04120.050.001	M16	100	04120.160.001	M30	25	04120.300.001
M6	250	04120.060.001	M18	50	04120.180.001	M33	5	04120.330.001
M8	250	04120.080.001	M20	50	04120.200.001	M36	5	04120.360.001
M10	250	04120.100.001	M22	25	04120.220.001	M39	5	04120.390.001
M12	100	04120.120.001	M24	25	04120.240.001	M42	5	04120.420.001
M14	100	04120.140.001	M27	25	04120.270.001	M48	5	04120.480.001

04120 Hexagon nut

d	Art.number
M56	5 04120.560.001

04121 Hexagon nut C01C

Thread Metric thread
Material Steel
Class |10|
Surface treatment Zinc plated

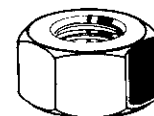

d	Art.number	d	Art.number	d	Art.number
M3	250 04121.030.001	M10	250 04121.100.001	M20	50 04121.200.001
M4	250 04121.040.001	M12	100 04121.120.001	M24	25 04121.240.001
M5	250 04121.050.001	M14	100 04121.140.001	M30	25 04121.300.001
M6	250 04121.060.001	M16	100 04121.160.001	M36	10 04121.360.001
M8	250 04121.080.001				

04122 Hexagon nut C03A

Thread Metric thread
Material Steel
Class |10|
Surface treatment Zinc plated yellow passivated

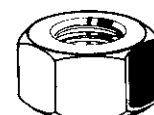

d	Art.number	d	Art.number	d	Art.number
M6	250 04122.060.001	M12	100 04122.120.001	M18	50 04122.180.001
M8	250 04122.080.001	M14	100 04122.140.001	M20	20 04122.200.001
M10	250 04122.100.001	M16	100 04122.160.001	M24	25 04122.240.001

04119 Hexagon nut oversized thread C01A

Thread Metric thread
Material Steel
Class |10|
Surface treatment Hot dip galvanized

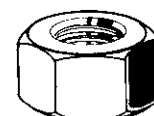

d	Art.number	d	Art.number	d	Art.number
M10	500 04119.100.001	M20	100 04119.200.001	M30	25 04119.300.001
M12	100 04119.120.001	M24	50 04119.240.001	M36	15 04119.360.001
M16	100 04119.160.001	M27	25 04119.270.001		

- These hexagon nuts are used among other to hot dip galvanized hexagon bolts with OVERSIZED thread and to hot dip galvanized threaded rods with OVERSIZED thread.
- After the zinc coating, the nuts are being oversize tapped according to ISO 965-5 resulting in a perfect fit for, hot-dip galvanized, oversize thread.
- The corrosion resistance is not influenced disadvantageously, with assembled nuts, by the uncoated thread.

04125 Hexagon nut C02A

Thread Metric thread
Material Steel
Class |10|
Surface treatment Zinc flake Cr⁶⁺ free - ISO 10683 flZnnc

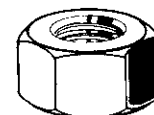

d	Art.number	d	Art.number	d	Art.number
M4	250 04125.040.001	M10	250 04125.100.001	M20	50 04125.200.001
M5	250 04125.050.001	M12	100 04125.120.001	M24	25 04125.240.001
M6	250 04125.060.001	M14	100 04125.140.001	M30	25 04125.300.001
M8	250 04125.080.001	M16	100 04125.160.001		



04190 Hexagon nut C01C

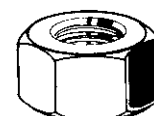

Thread Metric thread
Material Steel
Class |12|



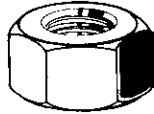

d	Art.number	d	Art.number	d	Art.number
M6	250 04190.060.001	M10	250 04190.100.001	M14	100 04190.140.001
M8	250 04190.080.001	M12	100 04190.120.001	M16	100 04190.160.001

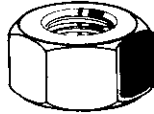
04190 Hexagon nut					
d	☒	Art.number	d	☒	Art.number
M20	50	04190.200.001	M30	25	04190.300.001
M24	25	04190.240.001	M36	10	04190.360.001

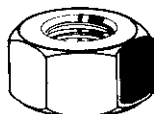

11300 Hexagon nut turned						F01A		
Thread	Metric thread							
Material	Free-cutting steel							
Class	[6]							
Surface treatment	Zinc plated							
								
d	☒	Art.number	d	☒	Art.number	d	☒	Art.number
M1,6	500	11300.016.001	M2,3	500	11300.023.001	M2,6	500	11300.026.001
M2	500	11300.020.001	M2,5	500	11300.025.001	M3,5	250	11300.035.001

51080 Hexagon nut						Q01A		
Thread	Metric thread							
Material	Stainless steel A2							
Class	70							
Surface treatment								
								
d	☒	Art.number	d	☒	Art.number	d	☒	Art.number
M1	200	51080.010.001	M7	200	51080.070.001	M27	10	51080.270.001
M1,2	200	51080.012.001	M8	200	51080.080.001	M30	5	51080.300.001
M1,4	200	51080.014.001	M10	200	51080.100.001	M33	5	51080.330.001
M1,6	200	51080.016.001	M12	200	51080.120.001	M36	5	51080.360.001
M2	500	51080.020.001	M14	100	51080.140.001	M39	5	51080.390.001
M2,5	500	51080.025.001	M16	100	51080.160.001	M42	5	51080.420.001
M3	500	51080.030.001	M18	50	51080.180.001	M45	5	51080.450.001
M4	500	51080.040.001	M20	50	51080.200.001	M48	5	51080.480.001
M5	500	51080.050.001	M22	20	51080.220.001	M52*	5	51080.520.001
M6	500	51080.060.001	M24	20	51080.240.001			

• Sizes with a diameter > M24 are at least property class 50.

51100 Hexagon nut						Q01A		
Thread	Metric thread							
Material	Stainless steel A2							
Class	70							
Surface treatment								
								
d	☒	Art.number	d	☒	Art.number	d	☒	Art.number
M1,7*	1000	51100.017.001	M5	2500	51100.050.001	M20	150	51100.200.001
M2,3*	1000	51100.023.001	M6	2000	51100.060.001	M24	50	51100.240.001
M2,6*	1000	51100.026.001	M8	2000	51100.080.001	M27	25	51100.270.001
M3	2500	51100.030.001	M10	1000	51100.100.001	M30	10	51100.300.001
M3,5*	1000	51100.035.001	M12	700	51100.120.001			
M4	2500	51100.040.001	M16	300	51100.160.001			

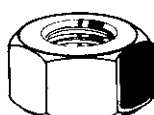
• Sizes with a diameter > M24 are at least property class 50.

51082 Hexagon nut						R09A		
Thread	Metric thread							
Material	Stainless steel A2							
Class	70							
Surface treatment	COMBIFLON							
								
d	☒	Art.number	d	☒	Art.number	d	☒	Art.number
M6	250	51082.060.001	M10	100	51082.100.001	M16	50	51082.160.001
M8	100	51082.080.001	M12	100	51082.120.001	M20	25	51082.200.001

- Specific features Combiflon:
- It's a fixed dry film coating, colour silver, with reducing effect on galling.
- It levels out the big scatter in coefficient of friction and reduces the average value.
- For a bolt /nut assembly only one product (e.g. the nut) needs to be treated with Combiflon.
- Reduces Bi-metallic corrosion.

51089 Hexagon nut		Q01A
Thread	Metric thread	
Material	Stainless steel A2	
Class	70	
Surface treatment	METALFORM	
		

d	☒	Art.number	d	☒	Art.number	d	☒	Art.number
M4	250	51089.040.001	M8	100	51089.080.001	M16	50	51089.160.001
M5	250	51089.050.001	M10	100	51089.100.001	M20	25	51089.200.001
M6	250	51089.060.001	M12	100	51089.120.001	M24	10	51089.240.001

- Special features of METALFORM:
- Is a dry partly visible lubricant which eliminates the possibility of seizure of threaded stainless steel fasteners.
- In addition the friction coefficient is reduced to a more constant value.
- In a bolt/nut combination it's sufficient that only the nut is lubricated to prevent seizure with METALFORM.
- Can be removed very easily with a solvent after application, so there's no objection of using this application in the food industry.

3

51162 Hexagon nut left hand thread		R09A
Thread	Metric thread	
Material	Stainless steel A2	
Class	70	
		

d	☒	Art.number	d	☒	Art.number	d	☒	Art.number
M4	100	51162.040.001	M12	25	51162.120.001	M22	5	51162.220.001
M5	100	51162.050.001	M14	25	51162.140.001	M24	5	51162.240.001
M6	100	51162.060.001	M16	10	51162.160.001	M27*	10	51162.270.001
M8	50	51162.080.001	M18	10	51162.180.001	M30	3	51162.300.001
M10	50	51162.100.001	M20	10	51162.200.001			

- Sizes with a diameter > M24 are at least property class 50.

53080 Hexagon nut		R11A
Thread	Metric thread	
Material	Stainless steel A2	
Class	80	
		

d	☒	Art.number	d	☒	Art.number	d	☒	Art.number
M4*	500	53080.040.001	M8*	100	53080.080.001	M16*	50	53080.160.001
M5*	500	53080.050.001	M10*	100	53080.100.001	M20*	50	53080.200.001
M6*	200	53080.060.001	M12*	100	53080.120.001			

55080 Hexagon nut		Q41A
Thread	Metric thread	
Material	Stainless steel A4	
Class	70	
		

d	☒	Art.number	d	☒	Art.number	d	☒	Art.number
M1,2*	200	55080.012.001	M6	500	55080.060.001	M24	20	55080.240.001
M1,4*	200	55080.014.001	M7	200	55080.070.001	M27	10	55080.270.001
M1,6	200	55080.016.001	M8	200	55080.080.001	M30	5	55080.300.001
M2	500	55080.020.001	M10	200	55080.100.001	M33	5	55080.330.001
M2,5	500	55080.025.001	M12	200	55080.120.001	M36	5	55080.360.001
M2,6*	1000	55080.026.001	M14	100	55080.140.001	M39	5	55080.390.001
M3	500	55080.030.001	M16	100	55080.160.001	M42	5	55080.420.001
M3,5*	1000	55080.035.001	M18	50	55080.180.001	M45	5	55080.450.001
M4	500	55080.040.001	M20	50	55080.200.001	M48	5	55080.480.001
M5	500	55080.050.001	M22	20	55080.220.001	M52*	5	55080.520.001

- Sizes with a diameter > M24 are at least property class 50.

3

55100 Hexagon nut Q41A

Thread Metric thread
Material Stainless steel A4
Class 70

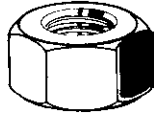
d	☒	Art.number	d	☒	Art.number	d	☒	Art.number
M3	2500	55100.030.001	M6	2000	55100.060.001	M12	700	55100.120.001
M4	2500	55100.040.001	M8	2000	55100.080.001	M16	300	55100.160.001
M5	2500	55100.050.001	M10	1000	55100.100.001			

53580 Hexagon nut R11A

Thread Metric thread
Material Stainless steel A4
Class 80



d	☒	Art.number	d	☒	Art.number	d	☒	Art.number
M6	100	53580.060.001	M12	25	53580.120.001	M20	10	53580.200.001
M8	50	53580.080.001	M16	25	53580.160.001	M24	10	53580.240.001
M10	50	53580.100.001						

53162 Hexagon nut left hand thread R11A

Thread Metric thread
Material Stainless steel A4
Class 80

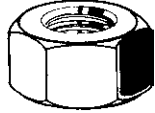
d	☒	Art.number	d	☒	Art.number	d	☒	Art.number
M5*	100	53162.050.001	M14*	50	53162.140.001	M22*	25	53162.220.001
M6*	100	53162.060.001	M16*	25	53162.160.001	M24*	25	53162.240.001
M8*	100	53162.080.001	M18*	25	53162.180.001	M27*	10	53162.270.001
M10*	100	53162.100.001	M20*	25	53162.200.001	M30*	10	53162.300.001
M12*	50	53162.120.001						

55089 Hexagon nut Q45A

Thread Metric thread
Material Stainless steel A5
Class 70

d	☒	Art.number	d	☒	Art.number	d	☒	Art.number
M5*	500	55089.050.001	M10*	200	55089.100.001	M20*	50	55089.200.001
M6*	500	55089.060.001	M12*	100	55089.120.001	M24*	50	55089.240.001
M8*	200	55089.080.001	M16*	100	55089.160.001			

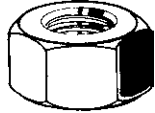

45080 Hexagon nut W01A



Thread Metric thread
Material Aluminium P40

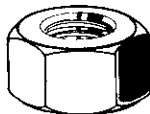

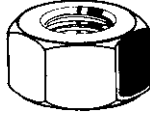

d	☒	Art.number	d	☒	Art.number	d	☒	Art.number
M3	250	45080.030.001	M6	250	45080.060.001	M10	100	45080.100.001
M4	250	45080.040.001	M8	100	45080.080.001	M12	100	45080.120.001
M5	250	45080.050.001						

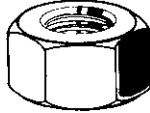

45280 Hexagon nut				W01A				
Thread	Metric thread							
Material	Aluminium P60							
Surface treatment	Yellow anodized							
d	☒	Art.number	d	☒	Art.number	d	☒	Art.number
M6		250 45280.060.001	M12		100 45280.120.001	M20		25 45280.200.001
M8		100 45280.080.001	M16		50 45280.160.001	M24		10 45280.240.001
M10		100 45280.100.001						

45850 Hexagon nut				M11A				
Thread	Metric thread							
Material	Kuprodur Cu5							
Class	60							
								
d	☒	Art.number	d	☒	Art.number	d	☒	Art.number
M6		100 45850.060.001	M10		50 45850.100.001	M16		10 45850.160.001
M8		50 45850.080.001	M12		25 45850.120.001			

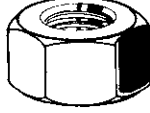
45920 Hexagon nut				W01A				
Thread	Metric thread			DIN	≈934 (1987)			
Material	Titanium			NEN	≈1560			
Class	Gr.2			NF	≈E25-401			
								
d	☒	Art.number	d	☒	Art.number	d	☒	Art.number
M6		25 45920.060.001	M8		25 45920.080.001	M10		10 45920.100.001

- Titanium Grade 2 (materialnumber 3.7035) with a high percentage of pure titanium, ensures product stability and -suitability in extremely corrosive environments where other materials i.e. stainless steel fail.
- Titanium Grade 2 is also suitable for other light loaded applications.

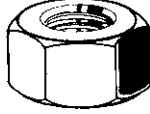
47000 Hexagon nut				M01A				
Thread	Metric thread							
Material	Brass Cu2/Cu3							
								
d	☒	Art.number	d	☒	Art.number	d	☒	Art.number
M2		250 47000.020.001	M7		250 47000.070.001	M18		10 47000.180.001
M2,5		250 47000.025.001	M8		250 47000.080.001	M20		10 47000.200.001
M3		250 47000.030.001	M10		100 47000.100.001	M22		10 47000.220.001
M4		250 47000.040.001	M12		50 47000.120.001	M24		10 47000.240.001
M5		250 47000.050.001	M14		50 47000.140.001	M27		10 47000.270.001
M6		250 47000.060.001	M16		25 47000.160.001	M30		5 47000.300.001

47050 Hexagon nut				M01A				
Thread	Metric thread							
Material	Brass Cu2/Cu3							
Surface treatment	Nickel plated							
								
d	☒	Art.number	d	☒	Art.number	d	☒	Art.number
M1,4		500 47050.014.001	M3,5		250 47050.035.001	M8		250 47050.080.001
M1,6		500 47050.016.001	M4		250 47050.040.001	M10		100 47050.100.001
M2		250 47050.020.001	M5		250 47050.050.001	M12		50 47050.120.001
M2,5		250 47050.025.001	M6		250 47050.060.001	M16		25 47050.160.001
M3		250 47050.030.001						

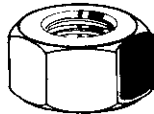
56200 Hexagon nut plastic				W02A
Thread	Metric thread	DIN	≈934 (1987)	
Material	Plastic Polyamide (nylon)	NEN	≈1560	
Class	PA 6.6	NF	≈E25-401	
Color	White			

d	☒	Art.number	d	☒	Art.number	d	☒	Art.number
M3	200	56200.030.001	M8	50	56200.080.001	M14	25	56200.140.001
M4	200	56200.040.001	M10	50	56200.100.001	M16	25	56200.160.001
M5	200	56200.050.001	M12	25	56200.120.001	M20	10	56200.200.001
M6	100	56200.060.001						

3

Hexagon nut MF

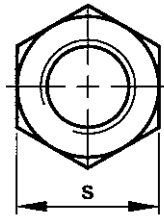
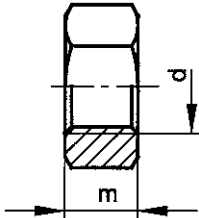

DIN 934 (1987)
NEN 1560
NF E25-401

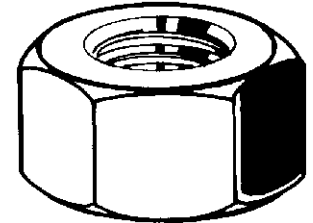

Technical Data

d	m	s	d	m	s
M4 (#DIN)	3.2	7	M33 (#DIN)	26	50
M6 (#DIN)	5	10	M33	26	50
M8	6.5	13	M36 (#DIN)	29	55
M10	8	17	M36	29	55
M12 (#DIN)	10	19	M38 (#DIN)	31	60
M12	10	19	M39 (#DIN)	31	60
M14	11	22	M39	31	60
M16	13	24	M40 (#DIN)	31	60
M18 (#DIN)	15	27	M42 (#DIN)	34	65
M18	15	27	M42	34	65
M20	16	30	M45 (#DIN)	36	70
M22 (#DIN)	18	32	M45	36	70
M22	18	32	M48 (#DIN)	38	75
M24 (#DIN)	19	36	M48	38	75
M24	19	36	M52 (#DIN)	42	80
M26 (#DIN)	22	41	M52	42	80
M27 (#DIN)	22	41	M56 (#DIN)	45	85
M27	22	41	M56	45	85
M28 (#DIN)	22	41	M60 (#DIN)	48	90
M30 (#DIN)	24	46	M60	48	90
M30	24	46	M64	51	95
M32 (#DIN)	26	50	M68	54	100

Article groups

Thread	Driving features	Material	Class	Surface treatment	Code	Page
MF	Hexagon	St	8		01120	3-15
MF	Hexagon	St	8	left hand	01130	3-15
MF	Hexagon	St	8	Zipl	01330	3-15
MF	Hexagon	St	8	Zipl yell.p.	01340	3-15
MF	Hexagon	St	10		04180	3-16
MF	Hexagon	Free-cutting steel	6	left hand	11007	3-16
MF	Hexagon	St.St. A2	70		51160	3-16
MF	Hexagon	St.St. A4	70		55160	3-16

01120 Hexagon nut MF		A09A	
Thread	Metric fine thread		
Material	Steel		
Class	[8]		

d x P	☒	Art.number	d x P	☒	Art.number	d x P	☒	Art.number
M4X0,75 (#DIN)	250	01120.040.075	M22X2,00	25	01120.220.200	M39X3,00	5	01120.390.300
M6X0,75 (#DIN)	250	01120.060.075	M24X1,50 (#DIN)	25	01120.240.150	M40X1,50 (#DIN)	2	01120.400.150
M8X1,00	250	01120.080.100	M24X2,00	25	01120.240.200	M40X2,00 (#DIN)	2	01120.400.200
M10X1,00	250	01120.100.100	M26X1,50 (#DIN)	10	01120.260.150	M42X1,50 (#DIN)	5	01120.420.150
M10X1,25	250	01120.100.125	M27X1,50 (#DIN)	25	01120.270.150	M42X3,00	5	01120.420.300
M12X1,00 (#DIN)	100	01120.120.100	M27X2,00	25	01120.270.200	M45X1,50 (#DIN)	4	01120.450.150
M12X1,25	100	01120.120.125	M28X2,00 (#DIN)	10	01120.280.200	M45X3,00	4	01120.450.300
M12X1,50	100	01120.120.150	M30X1,00 (#DIN)	10	01120.300.100	M48X1,50 (#DIN)	4	01120.480.150
M14X1,50	100	01120.140.150	M30X1,50 (#DIN)	25	01120.300.150	M48X2,00 (#DIN)	2	01120.480.200
M16X1,00	50	01120.160.100	M30X2,00	25	01120.300.200	M48X3,00	4	01120.480.300
M16X1,50	100	01120.160.150	M32X2,00 (#DIN)	5	01120.320.200	M52X1,50 (#DIN)	1	01120.520.150
M18X1,00 (#DIN)	25	01120.180.100	M33X1,50 (#DIN)	10	01120.330.150	M52X3,00	1	01120.520.300
M18X1,50	50	01120.180.150	M33X2,00	10	01120.330.200	M56X2,00 (#DIN)	1	01120.560.200
M18X2,00	50	01120.180.200	M36X1,50 (#DIN)	10	01120.360.150	M56X4,00	1	01120.560.400
M20X1,50	50	01120.200.150	M36X2,00 (#DIN)	10	01120.360.200	M60X2,00 (#DIN)	1	01120.600.200
M20X2,00	50	01120.200.200	M36X3,00	10	01120.360.300	M60X4,00	1	01120.600.400
M22X1,00 (#DIN)	10	01120.220.100	M38X1,50 (#DIN)	2	01120.380.150	M64X4,00	1	01120.640.400
M22X1,50	25	01120.220.150	M39X1,50 (#DIN)	5	01120.390.150	M68X4,00	1	01120.680.400

3

01130 Hexagon nut MF left hand thread		A09A	
Thread	Metric fine thread		
Material	Steel		
Class	[8]		

d x P	☒	Art.number	d x P	☒	Art.number	d x P	☒	Art.number
M12X1,25	50	01130.120.125	M24X1,50 (#DIN)	10	01130.240.150	M36X1,50 (#DIN)	2	01130.360.150
M12X1,50	50	01130.120.150	M24X2,00	10	01130.240.200	M36X2,00 (#DIN)	2	01130.360.200
M14X1,50	50	01130.140.150	M27X1,50 (#DIN)	10	01130.270.150	M42X1,50 (#DIN)	1	01130.420.150
M16X1,50	25	01130.160.150	M27X2,00	10	01130.270.200	M45X3,00	1	01130.450.300
M18X1,50	10	01130.180.150	M30X1,50 (#DIN)	10	01130.300.150	M48X1,50 (#DIN)	1	01130.480.150
M20X2,00	10	01130.200.200	M30X2,00	10	01130.300.200	M48X3,00	1	01130.480.300
M22X2,00	10	01130.220.200	M33X2,00	5	01130.330.200			

01330 Hexagon nut MF		A09A	
Thread	Metric fine thread		
Material	Steel		
Class	[8]		
Surface treatment	Zinc plated		

d x P	☒	Art.number	d x P	☒	Art.number	d x P	☒	Art.number
M8X1,00	250	01330.080.100	M12X1,25	100	01330.120.125	M18X1,50	50	01330.180.150
M10X1,00	250	01330.100.100	M12X1,50	100	01330.120.150	M20X1,50	50	01330.200.150
M10X1,25	250	01330.100.125	M14X1,50	100	01330.140.150	M24X1,50	50	01330.240.150
M12X1,00	100	01330.120.100	M16X1,50	100	01330.160.150	M39X3,00	1	01330.390.300

01340 Hexagon nut MF		A09A	
Thread	Metric fine thread		
Material	Steel		
Class	[8]		
Surface treatment	Zinc plated yellow passivated		

d x P	☒	Art.number	d x P	☒	Art.number	d x P	☒	Art.number
M6X0,75 (#DIN)	250	01340.060.075	M18X1,50	50	01340.180.150	M27X1,50 (#DIN)	25	01340.270.150
M8X1,00	250	01340.080.100	M18X2,00	50	01340.180.200	M27X2,00	25	01340.270.200
M10X1,00	250	01340.100.100	M20X1,50	50	01340.200.150	M30X1,50 (#DIN)	25	01340.300.150
M10X1,25	250	01340.100.125	M20X2,00	50	01340.200.200	M30X2,00	25	01340.300.200
M12X1,00 (#DIN)	100	01340.120.100	M22X1,50	25	01340.220.150	M33X1,50 (#DIN)	10	01340.330.150
M12X1,25 (#DIN)	100	01340.120.125	M22X2,00	25	01340.220.200	M33X2,00	10	01340.330.200
M12X1,50 (#DIN)	100	01340.120.150	M24X1,50 (#DIN)	25	01340.240.150	M36X1,50 (#DIN)	10	01340.360.150
M14X1,50	100	01340.140.150	M24X2,00	25	01340.240.200	M36X3,00	10	01340.360.300
M16X1,50	100	01340.160.150						

04180	Hexagon nut MF	C02A
Thread	Metric fine thread	
Material	Steel	
Class	[10]	
		

d x P	☒	Art.number	d x P	☒	Art.number	d x P	☒	Art.number
M8X1,00	250	04180.080.100	M14X1,50	100	04180.140.150	M22X1,50	50	04180.220.150
M10X1,00	250	04180.100.100	M16X1,50	100	04180.160.150	M24X2,00	50	04180.240.200
M10X1,25	250	04180.100.125	M18X1,50	50	04180.180.150	M27X2,00	10	04180.270.200
M12X1,25	100	04180.120.125	M20X1,50	50	04180.200.150	M30X2,00	5	04180.300.200
M12X1,50	100	04180.120.150						

11007	Hexagon nut turned MF, left hand thread	F01B
Thread	Metric fine thread	
Material	Free-cutting steel	
Class	[6]	
		

d x P	☒	Art.number	d x P	☒	Art.number	d x P	☒	Art.number
M10X1,00	250	11007.100.100	M20X2,00	50	11007.200.200	M33X2,00	5	11007.330.200
M12X1,25	100	11007.120.125	M24X1,50 (≠DIN)	25	11007.240.150	M36X1,50 (≠DIN)	5	11007.360.150
M12X1,50	100	11007.120.150	M24X2,00	25	11007.240.200	M45X3,00	4	11007.450.300
M14X1,50	100	11007.140.150	M27X2,00	25	11007.270.200	M48X1,50 (≠DIN)	4	11007.480.150
M16X1,50	100	11007.160.150	M30X1,50 (≠DIN)	25	11007.300.150			
M18X1,50	50	11007.180.150	M30X2,00	25	11007.300.200			

51160	Hexagon nut MF	R09A
Thread	Metric fine thread	
Material	Stainless steel A2	
Class	70	
		

d x P	☒	Art.number	d x P	☒	Art.number	d x P	☒	Art.number
M8X1,00	100	51160.080.100	M16X1,50	50	51160.160.150	M27X1,50*	25	51160.270.150
M10X1,00	100	51160.100.100	M18X1,50	25	51160.180.150	M27X2,00*	25	51160.270.200
M10X1,25	100	51160.100.125	M20X1,50	25	51160.200.150	M30X1,50*	25	51160.300.150
M12X1,00	50	51160.120.100	M20X2,00*	50	51160.200.200	M30X2,00*	25	51160.300.200
M12X1,25	100	51160.120.125	M22X1,50	10	51160.220.150	M36X1,50*	10	51160.360.150
M12X1,50	100	51160.120.150	M24X1,50 (≠DIN)	10	51160.240.150	M36X3,00*	10	51160.360.300
M14X1,50	50	51160.140.150	M24X2,00	10	51160.240.200			

* Sizes with a diameter > M24 are at least property class 50.

55160	Hexagon nut MF	R49A
Thread	Metric fine thread	
Material	Stainless steel A4	
Class	70	
		

d x P	☒	Art.number	d x P	☒	Art.number	d x P	☒	Art.number
M8X1,00	100	55160.080.100	M16X1,50	50	55160.160.150	M27X1,50*	25	55160.270.150
M10X1,00	100	55160.100.100	M18X1,50	25	55160.180.150	M27X2,00*	25	55160.270.200
M10X1,25	100	55160.100.125	M20X1,50	25	55160.200.150	M30X1,50 (≠DIN)*	25	55160.300.150
M12X1,25	100	55160.120.125	M22X1,50	10	55160.220.150	M30X2,00*	25	55160.300.200
M12X1,50	100	55160.120.150	M24X1,50 (≠DIN)	10	55160.240.150			
M14X1,50	50	55160.140.150	M24X2,00	10	55160.240.200			

* Sizes with a diameter > M24 are at least property class 50.

Hexagon nut ISO

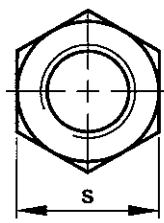
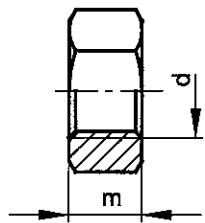

ISO 4032

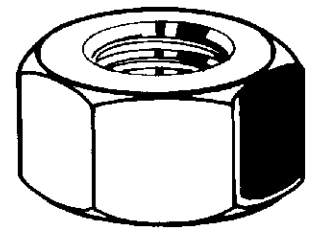

Technical Data

d	m (max.)	P	s	d	m (max.)	P	s
M2	1.6	0.4	4	M16	14.8	2	24
M2.5	2	0.45	5	M18	15.8	2.5	27
M3	2.4	0.5	5.5	M20	18	2.5	30
M4	3.2	0.7	7	M22	19.4	2.5	34
M5	4.7	0.8	8	M24	21.5	3	36
M6	5.2	1	10	M27	23.8	3	41
M8	6.8	1.25	13	M30	25.6	3.5	46
M10	8.4	1.5	16	M33	28.7	3.5	50
M12	10.8	1.75	18	M36	31	4	55
M14	12.8	2	21	M39	34	4	60

Article groups

Thread	Driving features	Material	Class	Surface treatment	Code	Page	
M	Hexagon	St	8		01104	3-17	
M	Hexagon	St	8	Zipl	01301	3-17	
M	Hexagon	St	8	Zipl yell.p.	01321	3-18	
M	Hexagon	St	8	FLZNNC-NC6	01337	3-18	
M	Hexagon	St	8	Hot d.g.	ISO metric	01510	3-18
M	Hexagon	St	10		04124	3-18	
M	Hexagon	St	10	Zipl	04127	3-19	
M	Hexagon	St	10	FLZNNC-NC6	04130	3-19	
M	Hexagon	St	5-2		for pressure vessels	08781	3-19
M	Hexagon	St.St. A2	70			51081	3-19
M	Hexagon	St.St. A2	80			53581	3-20
M	Hexagon	St.St. A4	70			55081	3-20

01104 Hexagon nut ISO

A01B

Thread Metric thread
Material Steel
Class 8

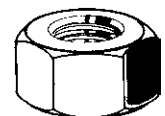

d	Art.number	d	Art.number	d	Art.number
M3	250 01104.030.001	M12	100 01104.120.001	M30	10 01104.300.001
M4	250 01104.040.001	M14	100 01104.140.001	M33	5 01104.330.001
M5	250 01104.050.001	M16	100 01104.160.001	M36	5 01104.360.001
M6	250 01104.060.001	M20	50 01104.200.001	M39	5 01104.390.001
M8	250 01104.080.001	M24	25 01104.240.001		
M10	250 01104.100.001	M27	10 01104.270.001		

01301 Hexagon nut ISO

A05B

Thread Metric thread
Material Steel
Class 8
Surface treatment Zinc plated

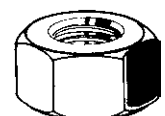

d	Art.number	d	Art.number	d	Art.number
M2	1000 01301.020.001	M10	250 01301.100.001	M24	25 01301.240.001
M2,5	1000 01301.025.001	M12	100 01301.120.001	M27	10 01301.270.001
M3	250 01301.030.001	M14	100 01301.140.001	M30	10 01301.300.001
M4	250 01301.040.001	M16	100 01301.160.001	M33	5 01301.330.001
M5	250 01301.050.001	M18	50 01301.180.001	M36	5 01301.360.001
M6	250 01301.060.001	M20	50 01301.200.001	M 39	5 01301.390.001
M8	250 01301.080.001	M22	25 01301.220.001		

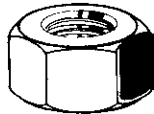
01321 Hexagon nut ISO		A06A
Thread	Metric thread	
Material	Steel	
Class	8	
Surface treatment	Zinc plated yellow passivated	

d	☒	Art.number	d	☒	Art.number	d	☒	Art.number
M3	250	01321.030.001	M12	100	01321.120.001	M27	10	01321.270.001
M4	250	01321.040.001	M14	100	01321.140.001	M30	10	01321.300.001
M5	250	01321.050.001	M16	100	01321.160.001	M33	5	01321.330.001
M6	250	01321.060.001	M18	50	01321.180.001	M36	5	01321.360.001
M8	250	01321.080.001	M20	50	01321.200.001			
M10	250	01321.100.001	M24	25	01321.240.001			

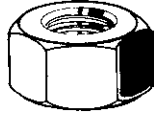
01337 Hexagon nut ISO		A96A
Thread	Metric thread	
Material	Steel	
Class	8	
Surface treatment	Zinc flake Cr ⁶⁺ free - ISO 10683 flZnnc	

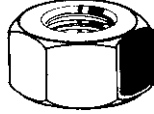

d	☒	Art.number	d	☒	Art.number	d	☒	Art.number
M3	250	01337.030.001	M12	100	01337.120.001	M30	10	01337.300.001
M4	250	01337.040.001	M14	100	01337.140.001	M33	5	01337.330.001
M5	250	01337.050.001	M16	100	01337.160.001	M36	5	01337.360.001
M6	250	01337.060.001	M20	50	01337.200.001	M39	5	01337.390.001
M8	250	01337.080.001	M24	25	01337.240.001			
M10	250	01337.100.001	M27	10	01337.270.001			

01510 Hexagon nut ISO-Metric fitting thread		A05B
Thread	Metric thread	
Material	Steel	
Class	8	
Surface treatment	Hot dip galvanized	



d	☒	Art.number	d	☒	Art.number	d	☒	Art.number
M6	250	01510.060.001	M16	100	01510.160.001	M27	10	01510.270.001
M8	250	01510.080.001	M18	50	01510.180.001	M30	10	01510.300.001
M10	250	01510.100.001	M20	50	01510.200.001	M33	5	01510.330.001
M12	100	01510.120.001	M22	25	01510.220.001	M36	5	01510.360.001
M14	100	01510.140.001	M24	25	01510.240.001			

- These hexagon nuts are used among other to hot dip galvanized bolts and screws with ISO-METRIC FITTING thread and to hot dip galvanized threaded rods with ISO-METRIC FITTING thread.
- The nuts are tapped AFTER galvanizing and meet the tolerances 6H.
- The corrosion resistance is not influenced disadvantageously, with assembled nuts, by the uncoated thread.

04124 Hexagon nut ISO		A05B
Thread	Metric thread	
Material	Steel	
Class	10	



d	☒	Art.number	d	☒	Art.number	d	☒	Art.number
M5	250	04124.050.001	M16	100	04124.160.001	M30	10	04124.300.001
M6	250	04124.060.001	M18	50	04124.180.001	M33	5	04124.330.001
M8	250	04124.080.001	M20	50	04124.200.001	M36	5	04124.360.001
M10	250	04124.100.001	M22	50	04124.220.001	M39	5	04124.390.001
M12	100	04124.120.001	M24	25	04124.240.001			
M14	100	04124.140.001	M27	10	04124.270.001			

04127 Hexagon nut ISO		A05B	
Thread	Metric thread		
Material	Steel		
Class	10		
Surface treatment	Zinc plated		

d	☒	Art.number	d	☒	Art.number	d	☒	Art.number
M3	250	04127.030.001	M12	100	04127.120.001	M24	25	04127.240.001
M4	250	04127.040.001	M14	100	04127.140.001	M27	10	04127.270.001
M5	250	04127.050.001	M16	100	04127.160.001	M30	10	04127.300.001
M6	250	04127.060.001	M18	50	04127.180.001	M33	5	04127.330.001
M8	250	04127.080.001	M20	50	04127.200.001	M36	5	04127.360.001
M10	250	04127.100.001	M22	50	04127.220.001	M39	5	04127.390.001

3

04130 Hexagon nut ISO		C02A	
Thread	Metric thread		
Material	Steel		
Class	10		
Surface treatment	Zinc flake Cr ⁶⁺ free - ISO 10683 flZnnc		

d	☒	Art.number	d	☒	Art.number	d	☒	Art.number
M5	250	04130.050.001	M16	100	04130.160.001	M30	10	04130.300.001
M6	250	04130.060.001	M18	100	04130.180.001	M33	5	04130.330.001
M8	250	04130.080.001	M20	100	04130.200.001	M36	5	04130.360.001
M10	250	04130.100.001	M22	50	04130.220.001	M39	5	04130.390.001
M12	250	04130.120.001	M24	25	04130.240.001			
M14	250	04130.140.001	M27	10	04130.270.001			

08781 Hexagon nut ISO		E11A	
Thread	Metric thread		
Material	Steel		
Class	5-2		

d	☒	Art.number	d	☒	Art.number	d	☒	Art.number
M8	250	08781.080.001	M20	100	08781.200.001	M30	25	08781.300.001
M10	250	08781.100.001	M24	50	08781.240.001	M33	5	08781.330.001
M12	100	08781.120.001	M27	50	08781.270.001	M36	5	08781.360.001
M16	100	08781.160.001						

- Special features hexagon nuts for pressure vessels etc.:
- Are intended for use in pressure vessels, steam apparatus, equipment and flanged joints at temperatures from – 10°C up to + 300°C, overpressures max. 40 bar.
- Meet the requirements of AD-Merkblatt W7, TRD 106 of the "Technischer Überwachungsverein (TÜV)" and resp. ISO 898-2 and DIN 267-13.
- According to TÜV-Merkblatt Werkstoffe 1253, the manufacturer has been certified to deliver these bolts without a 3.1 certificate, the trademark and class designation are sufficient.
- This certification is also accepted by "Lloyd's Register Energy".

51081 Hexagon nut ISO		R09A	
Thread	Metric thread		
Material	Stainless steel A2		
Class	70		

d	☒	Art.number	d	☒	Art.number	d	☒	Art.number
M5*	1000	51081.050.001	M12*	200	51081.120.001	M18*	50	51081.180.001
M6	1000	51081.060.001	M14*	100	51081.140.001	M20	50	51081.200.001
M8	500	51081.080.001	M16*	100	51081.160.001	M22*	25	51081.220.001
M10	200	51081.100.001						

53581 Hexagon nut ISO R11A

Thread Material Class Metric thread
Stainless steel A2
80

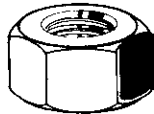

d	☒	Art.number	d	☒	Art.number	d	☒	Art.number
M6*	1000	53581.060.001	M12*	200	53581.120.001	M20*	50	53581.200.001
M8*	500	53581.080.001	M16*	100	53581.160.001	M24*	25	53581.240.001
M10*	200	53581.100.001						

55081 Hexagon nut ISO R49A

Thread Material Class Metric thread
Stainless steel A4
70



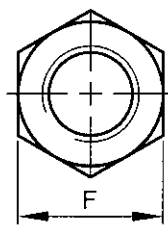
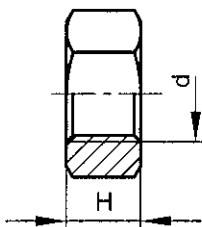

d	☒	Art.number	d	☒	Art.number	d	☒	Art.number
M6*	1000	55081.060.001	M12*	200	55081.120.001	M20*	50	55081.200.001
M8*	500	55081.080.001	M14*	100	55081.140.001	M24*	25	55081.240.001
M10*	200	55081.100.001	M16	100	55081.160.001			

Hexagon nut UNC

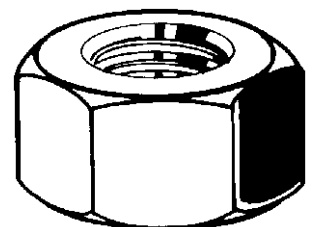

ASME ≈B18.2.2
BS ≈1768



Technical Data



d	F	H	Threads per inch	d	F	H	Threads per inch
1/4	7/16	7/32	20	3/4	1.1/8	41/64	10
5/16	1/2	17/64	18	7/8	1.5/16	3/4	9
3/8	9/16	21/64	16	1 inch	1.1/2	55/64	8
7/16	11/16	3/8	14	1.1/8	1.11/16	31/32	7
1/2	3/4	7/16	13	1.1/4	1.7/8	1 1/16	7
9/16	7/8	31/64	12	1.1/2	2.1/4	1 9/32	6
5/8	15/16	35/64	11				

Article groups

Thread	Driving features	Material	Class	Surface treatment	Code	Page
UNC	Hexagon	St	Grade 2		U08100	3-20
UNC	Hexagon	St	Grade 2	Zipl	U08110	3-21
UNC	Hexagon	St	Grade 5		U01100	3-21
UNC	Hexagon	St	Grade 5	Zipl	U01300	3-21
UNC	Hexagon	St	Grade 8		U04120	3-21
UNC	Hexagon	St	Grade 8	Zipl yell.p.	U04122	3-22
UNC	Hexagon	St.St. A2 (AISI304/18-8)	F594		U51080	3-22
UNC	Hexagon	St.St. A4 (AISI316/18-10)	F594		U55080	3-22

U08100 Hexagon nut UNC X01A

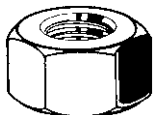
Thread Material Class Unified National Coarse
Steel
Grade 2

d	☒	Art.number	d	☒	Art.number	d	☒	Art.number
1/4-20*	100	U08100.025.0001	1/2-13*	50	U08100.050.0001	7/8-9*	10	U08100.087.0001
5/16-18*	100	U08100.031.0001	9/16-12*	25	U08100.056.0001	1.-8*	5	U08100.100.0001
3/8-16*	100	U08100.037.0001	5/8-11*	25	U08100.062.0001	1.1/8-7*	5	U08100.112.0001
7/16-14*	50	U08100.043.0001	3/4-10*	20	U08100.075.0001	1.1/4-7*	5	U08100.125.0001

U08100 Hexagon nut UNC

d	☒	Art.number
1.1/2-6*	5	U08100.150.0001

U08110 Hexagon nut UNC X01A

Thread Unified National Coarse
Material Steel
Class Grade 2
Surface treatment Zinc plated

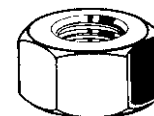

d	☒	Art.number	d	☒	Art.number	d	☒	Art.number
1/4-20*	100	U08110.025.0001	9/16-12*	25	U08110.056.0001	1.-8*	5	U08110.100.0001
5/16-18*	100	U08110.031.0001	5/8-11*	25	U08110.062.0001	1.1/8-7*	5	U08110.112.0001
3/8-16*	100	U08110.037.0001	3/4-10*	20	U08110.075.0001	1.1/4-7*	5	U08110.125.0001
7/16-14*	50	U08110.043.0001	7/8-9*	10	U08110.087.0001	1.1/2-6*	5	U08110.150.0001
1/2-13*	50	U08110.050.0001						

U01100 Hexagon nut UNC X01A

Thread Unified National Coarse
Material Steel
Class Grade 5

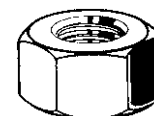

d	☒	Art.number	d	☒	Art.number	d	☒	Art.number
1/4-20*	100	U01100.025.0001	9/16-12*	25	U01100.056.0001	1.-8*	5	U01100.100.0001
5/16-18*	100	U01100.031.0001	5/8-11*	25	U01100.062.0001	1.1/8-7*	5	U01100.112.0001
3/8-16*	100	U01100.037.0001	3/4-10*	20	U01100.075.0001	1.1/4-7*	5	U01100.125.0001
7/16-14*	50	U01100.043.0001	7/8-9*	10	U01100.087.0001	1.1/2-6*	5	U01100.150.0001
1/2-13*	50	U01100.050.0001						

U01300 Hexagon nut UNC X01A

Thread Unified National Coarse
Material Steel
Class Grade 5
Surface treatment Zinc plated

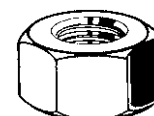

d	☒	Art.number	d	☒	Art.number	d	☒	Art.number
1/4-20*	100	U01300.025.0001	9/16-12*	25	U01300.056.0001	1.-8*	5	U01300.100.0001
5/16-18*	100	U01300.031.0001	5/8-11*	25	U01300.062.0001	1.1/8-7*	5	U01300.112.0001
3/8-16*	100	U01300.037.0001	3/4-10*	20	U01300.075.0001	1.1/4-7*	5	U01300.125.0001
7/16-14*	50	U01300.043.0001	7/8-9*	10	U01300.087.0001	1.1/2-6*	5	U01300.150.0001
1/2-13*	50	U01300.050.0001						

U04120 Hexagon nut UNC X01A

Thread Unified National Coarse
Material Steel
Class Grade 8

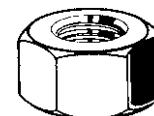



d	☒	Art.number	d	☒	Art.number	d	☒	Art.number
1/4-20*	100	U04120.025.0001	9/16-12*	25	U04120.056.0001	1.-8*	5	U04120.100.0001
5/16-18*	100	U04120.031.0001	5/8-11*	25	U04120.062.0001	1.1/8-7*	5	U04120.112.0001
3/8-16*	100	U04120.037.0001	3/4-10*	20	U04120.075.0001	1.1/4-7*	5	U04120.125.0001
7/16-14*	50	U04120.043.0001	7/8-9*	10	U04120.087.0001	1.1/2-6*	5	U04120.150.0001
1/2-13*	50	U04120.050.0001						

U04122	Hexagon nut UNC	X01A
Thread	Unified National Coarse	
Material	Steel	
Class	Grade 8	
Surface treatment	Zinc plated yellow passivated	

d	☒	Art.number	d	☒	Art.number	d	☒	Art.number
1/4-20*	100	U04122.025.0001	9/16-12*	25	U04122.056.0001	1.-8*	5	U04122.100.0001
5/16-18*	100	U04122.031.0001	5/8-11*	25	U04122.062.0001	1.1/8-7*	5	U04122.112.0001
3/8-16*	100	U04122.037.0001	3/4-10*	20	U04122.075.0001	1.1/4-7*	5	U04122.125.0001
7/16-14*	50	U04122.043.0001	7/8-9*	10	U04122.087.0001	1.1/2-6*	5	U04122.150.0001
1/2-13*	50	U04122.050.0001						

U51080	Hexagon nut UNC	X15A
Thread	Unified National Coarse	
Material	Stainless steel A2 (AISI 304/18-8)	
Class	F594	
		

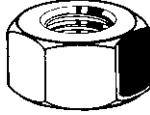
d	☒	Art.number	d	☒	Art.number	d	☒	Art.number
1/4-20*	50	U51080.025.0001	9/16-12*	25	U51080.056.0001	1.-8*	5	U51080.100.0001
5/16-18*	50	U51080.031.0001	5/8-11*	25	U51080.062.0001	1.1/8-7*	5	U51080.112.0001
3/8-16*	50	U51080.037.0001	3/4-10*	20	U51080.075.0001	1.1/4-7*	5	U51080.125.0001
7/16-14*	25	U51080.043.0001	7/8-9*	5	U51080.087.0001	1.1/2-6*	5	U51080.150.0001
1/2-13*	25	U51080.050.0001						

U55080	Hexagon nut UNC	X15A
Thread	Unified National Coarse	
Material	Stainless steel A4 (AISI 316/18-10)	
Class	F594	
		

d	☒	Art.number	d	☒	Art.number	d	☒	Art.number
1/4-20*	50	U55080.025.0001	9/16-12*	25	U55080.056.0001	1.-8*	5	U55080.100.0001
5/16-18*	50	U55080.031.0001	5/8-11*	25	U55080.062.0001	1.1/8-7*	5	U55080.112.0001
3/8-16*	50	U55080.037.0001	3/4-10*	20	U55080.075.0001	1.1/4-7*	5	U55080.125.0001
7/16-14*	25	U55080.043.0001	7/8-9*	5	U55080.087.0001	1.1/2-6*	5	U55080.150.0001
1/2-13*	25	U55080.050.0001						

Hexagon machine screw nut UNC

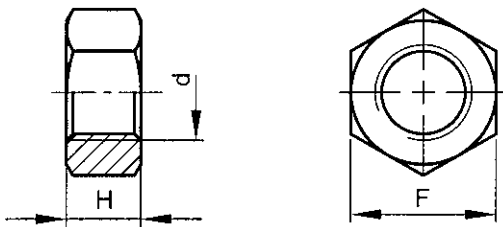

ASME ≈B18.2.2

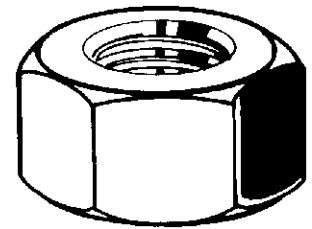

Technical Data

d	F	H	Threads per inch	d	F	H	Threads per inch
No.6	5/16	2.9	32	No.10	3/8	3.3	24
No.8	11/32	3.3	32	No.12	7/16	4.1	24

11740 Hexagon machine screw nut UNC

X09A

Thread Unified National Coarse
Material Free-cutting steel
Class 6
Surface treatment Zinc plated

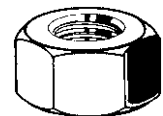

d	☒	Art.number	d	☒	Art.number	d	☒	Art.number
NO.6 = 3,51MM	250	11740.035.001	NO.10 = 4,83MM	250	11740.048.001	NO.12 = 5,49MM	250	11740.054.001
NO.8 = 4,17MM	250	11740.041.001						

Hexagon nut UNF

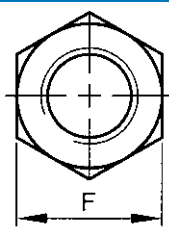
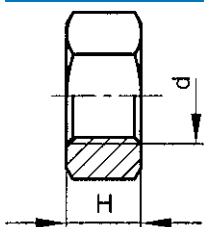

ASME ≈B18.2.2
 BS ≈1768

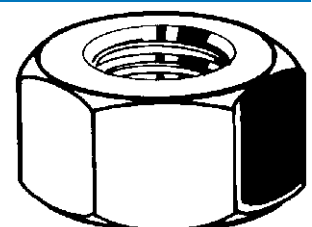

Technical Data

d	F	H	Threads per inch	d	F	H	Threads per inch
1/4	7/16	7/32	28	3/4	1.1/8	41/64	16
5/16	1/2	17/64	24	7/8	1.5/16	3/4	14
3/8	9/16	21/64	24	1 Inch-14G	1.1/2	55/64	14
7/16	11/16	3/8	20	1.1/8	1.11/16	31/32	12
1/2	3/4	7/16	20	1.1/4	1.7/8	1 1/16	12
9/16	7/8	31/64	18	1.1/2	2.1/4	1 9/32	12
5/8	15/16	35/64	18				

Article groups

Thread	Driving features	Material	Class	Surface treatment	Code	Page
UNF	Hexagon	St	Grade 2		U08160	3-24
UNF	Hexagon	St	Grade 2	Zipl	U08161	3-24
UNF	Hexagon	St	Grade 5		U01120	3-24
UNF	Hexagon	St	Grade 5	Zipl	U01330	3-24
UNF	Hexagon	St	Grade 8		U04180	3-24
UNF	Hexagon	St	Grade 8	Zipl	U04162	3-25
UNF	Hexagon	St	Grade 8	Zipl yell.p.	U04181	3-25
UNF	Hexagon	St.St. A2 (AISI304/18-8)	F594		U51160	3-25

U08160 Hexagon nut UNF X01A

Thread Unified National Fine
Material Steel
Class Grade 2

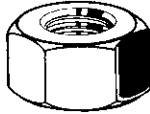
d	☒	Art.number	d	☒	Art.number	d	☒	Art.number
1/4-28*	100	U08160.025.0002	9/16-18*	25	U08160.056.0002	1.-14*	5	U08160.100.0003
5/16-24*	100	U08160.031.0002	5/8-18*	25	U08160.062.0002	1.1/8-12*	5	U08160.112.0002
3/8-24*	100	U08160.037.0002	3/4-16*	20	U08160.075.0002	1.1/4-12*	5	U08160.125.0002
7/16-20*	50	U08160.043.0002	7/8-14*	10	U08160.087.0002	1.1/2-12*	5	U08160.150.0002
1/2-20*	50	U08160.050.0002						

U08161 Hexagon nut UNF X01A

Thread Unified National Fine
Material Steel
Class Grade 2
Surface treatment Zinc plated



d	☒	Art.number	d	☒	Art.number	d	☒	Art.number
1/4-28*	100	U08161.025.0002	9/16-18*	25	U08161.056.0002	1.-14*	5	U08161.100.0003
5/16-24*	100	U08161.031.0002	5/8-18*	25	U08161.062.0002	1.1/8-12*	5	U08161.112.0002
3/8-24*	100	U08161.037.0002	3/4-16*	20	U08161.075.0002	1.1/4-12*	5	U08161.125.0002
7/16-20*	50	U08161.043.0002	7/8-14*	10	U08161.087.0002	1.1/2-12*	5	U08161.150.0002
1/2-20*	50	U08161.050.0002						

U01120 Hexagon nut UNF X01A

Thread Unified National Fine
Material Steel
Class Grade 5

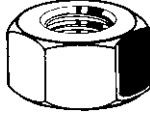
d	☒	Art.number	d	☒	Art.number	d	☒	Art.number
1/4-28*	100	U01120.025.0002	9/16-18*	25	U01120.056.0002	1.-14*	5	U01120.100.0003
5/16-24*	100	U01120.031.0002	5/8-18*	25	U01120.062.0002	1.1/8-12*	5	U01120.112.0002
3/8-24*	100	U01120.037.0002	3/4-16*	20	U01120.075.0002	1.1/4-12*	5	U01120.125.0002
7/16-20*	50	U01120.043.0002	7/8-14*	10	U01120.087.0002	1.1/2-12*	5	U01120.150.0002
1/2-20*	50	U01120.050.0002						

U01330 Hexagon nut UNF X01A

Thread Unified National Fine
Material Steel
Class Grade 5
Surface treatment Zinc plated

d	☒	Art.number	d	☒	Art.number	d	☒	Art.number
1/4-28*	100	U01330.025.0002	9/16-18*	25	U01330.056.0002	1.-14*	5	U01330.100.0003
5/16-24*	100	U01330.031.0002	5/8-18*	25	U01330.062.0002	1.1/8-12*	5	U01330.112.0002
3/8-24*	100	U01330.037.0002	3/4-16*	20	U01330.075.0002	1.1/4-12*	5	U01330.125.0002
7/16-20*	50	U01330.043.0002	7/8-14*	10	U01330.087.0002	1.1/2-12*	5	U01330.150.0002
1/2-20*	50	U01330.050.0002						

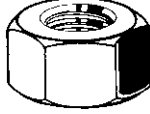
U04180 Hexagon nut UNF X01A

Thread Unified National Fine
Material Steel
Class Grade 8



d	☒	Art.number	d	☒	Art.number	d	☒	Art.number
1/4-28*	100	U04180.025.0002	9/16-18*	25	U04180.056.0002	1.-14*	5	U04180.100.0003
5/16-24*	100	U04180.031.0002	5/8-18*	25	U04180.062.0002	1.1/8-12*	5	U04180.112.0002
3/8-24*	100	U04180.037.0002	3/4-16*	20	U04180.075.0002	1.1/4-12*	5	U04180.125.0002
7/16-20*	50	U04180.043.0002	7/8-14*	10	U04180.087.0002	1.1/2-12*	5	U04180.150.0002
1/2-20*	50	U04180.050.0002						

U04162 Hexagon nut UNF X01A

Thread Unified National Fine
Material Steel
Class Grade 8
Surface treatment Zinc plated

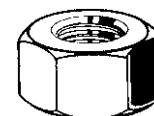

d	☒	Art.number	d	☒	Art.number	d	☒	Art.number
1/4-28*	100	U04162.025.0002	9/16-18*	25	U04162.056.0002	1.-14*	5	U04162.101.0002
5/16-24*	100	U04162.031.0002	5/8-18*	25	U04162.062.0002	1.1/8-12*	5	U04162.112.0002
3/8-24*	100	U04162.037.0002	3/4-16*	20	U04162.075.0002	1.1/4-12*	5	U04162.125.0002
7/16-20*	50	U04162.043.0002	7/8-14*	10	U04162.087.0002	1.1/2-12*	5	U04162.150.0002
1/2-20*	50	U04162.050.0002						

3
U04181 Hexagon nut UNF X01A

Thread Unified National Fine
Material Steel
Class Grade 8
Surface treatment Zinc plated yellow passivated

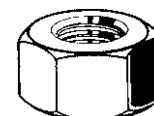

d	☒	Art.number	d	☒	Art.number	d	☒	Art.number
1/4-28*	100	U04181.025.0002	9/16-18*	25	U04181.056.0002	1.-14*	5	U04181.100.0003
5/16-24*	100	U04181.031.0002	5/8-18*	25	U04181.062.0002	1.1/8-12*	5	U04181.112.0002
3/8-24*	100	U04181.037.0002	3/4-16*	20	U04181.075.0002	1.1/4-12*	5	U04181.125.0002
7/16-20*	50	U04181.043.0002	7/8-14*	10	U04181.087.0002	1.1/2-12*	5	U04181.150.0002
1/2-20*	50	U04181.050.0002						

U51160 Hexagon nut UNF X15A

Thread Unified National Fine
Material Stainless steel A2 (AISI 304/18-8)
Class F594

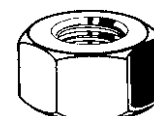

d	☒	Art.number	d	☒	Art.number	d	☒	Art.number
1/4-28	50	U51160.025.0002	9/16-18*	25	U51160.056.0002	1.-14*	5	U51160.101.0002
5/16-24*	50	U51160.031.0002	5/8-18*	25	U51160.062.0002	1.1/8-12*	5	U51160.112.0002
3/8-24*	50	U51160.037.0002	3/4-16*	20	U51160.075.0002	1.1/4-12*	5	U51160.125.0002
7/16-20*	25	U51160.043.0002	7/8-14*	5	U51160.087.0002	1.1/2-12*	5	U51160.150.0002
1/2-20*	25	U51160.050.0002						

Hexagon machine screw nut UNF

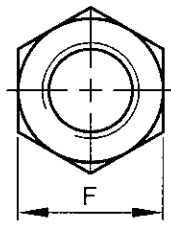
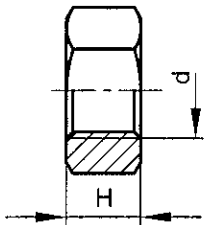

ASME ≈B18.2.2

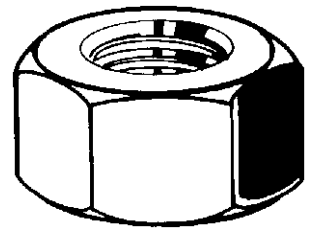

3

Technical Data

d	F	H (mm)	Threads per inch	d	F	H (mm)	Threads per inch
No.4	1/4	2.5	48	No.8	11/32	3.3	36
No.5	5/16	2.9	44	No.10	3/8	3.3	32
No.6	5/16	2.9	40				

Article groups

Thread	Driving features	Material	Surface treatment	Code	Page
UNF	Hexagon	Free-cutting steel	Zipl	11750	3-26
UNF	Hexagon	Br Cu3		47170	3-26

11750 Hexagon machine screw nut UNF

X09A

Thread	Unified National Fine
Material	Free-cutting steel
Surface treatment	Zinc plated

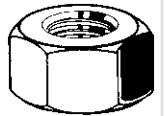

d	Art.number	d	Art.number	d	Art.number
NO.4 = 2,85MM	250 11750.028.001	NO.8 = 4,17MM	250 11750.041.001	NO.10 = 4,83MM	250 11750.048.001
NO.5 = 3,18MM	250 11750.031.001				

47170 Hexagon machine screw nut UNF

X09A

Thread	Unified National Fine
Material	Brass Cu3

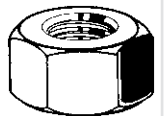

d	Art.number	d	Art.number
NO.6-40 = 3,52MM	250 47170.035.001	NO.10-32 = 4,83MM	100 47170.048.001

Hexagon nut BSW

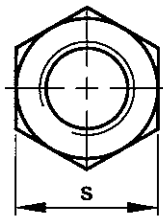
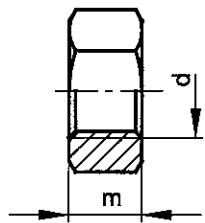

DIN ≈934 (1954)
NEN ≈2338 (1960)

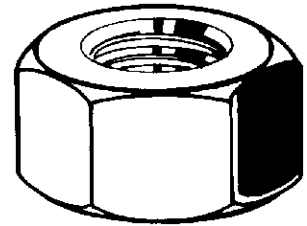

Technical Data

d	m	s	Threads per inch	d	m	s	Threads per inch
1/8	2.4	5.5	40	3/4	16	32	10
5/32	3.2	7	32	7/8	18	36	9
3/16	4.8	10	24	1 Inch	20	41	8
1/4	5.5	11	20	1.1/8	22	46	7
5/16	6.5	14	18	1.1/4	25	50	7
5/16 (#DIN)	6.5	13	18	1.3/8	28	55	6
3/8	8	17	16	1.1/2	30	60	6
7/16	9.5	19	14	1.5/8	32	65	5
1/2	11	22	12	1.3/4	35	70	5
9/16	11	22	12	2 Inch	40	80	4.5
5/8	13	27	11	2.1/4	45	85	4

- Whitworth thread (BSW/BSF) is not internationally recommended. It is advised to use metric (M/MF) or unified threads (UNC/UNF).
- Depending on availability the dimensions may deviate.

Article groups

Thread	Driving features	Material	Class	Surface treatment	Code	Page
BSW	Hexagon	St	8		03460	3-27
BSW	Hexagon	St	8	Zipl	03600	3-27
BSW	Hexagon	Free-cutting steel	6		11200	3-28
BSW	Hexagon	Br Cu3			47100	3-28

03460 Hexagon nut BSW

X03A

Thread British Standard Whitworth
Material Steel
Class 8

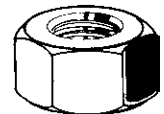

d	Art.number	d	Art.number	d	Art.number
3/16	250 03460.047.001	7/16	100 03460.111.001	3/4	50 03460.191.001
1/4	250 03460.063.001	1/2	100 03460.127.001	7/8	25 03460.222.001
5/16	250 03460.079.001	5/8	100 03460.158.001	1 Inch	25 03460.254.001
3/8	250 03460.096.001				

03600 Hexagon nut BSW

X03A

Thread British Standard Whitworth
Material Steel
Class 8
Surface treatment Zinc plated

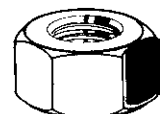

d	Art.number	d	Art.number	d	Art.number
3/16	250 03600.047.001	3/8	250 03600.096.001	3/4	50 03600.191.001
1/4	250 03600.063.001	1/2	100 03600.127.001	7/8	25 03600.222.001
5/16	250 03600.079.001	5/8	100 03600.158.001	1 Inch	25 03600.254.001

11200 Hexagon machine screw nut X08A

Thread Material Class British Standard Whitworth Free-cutting steel 6

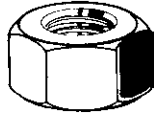
d	☒	Art.number	d	☒	Art.number	d	☒	Art.number
1/8	250	11200.031.001	1/2	100	11200.127.001	1.1/4	10	11200.317.001
5/32	250	11200.039.001	9/16	100	11200.142.001	1.3/8	10	11200.349.001
3/16	250	11200.047.001	5/8	50	11200.158.001	1.1/2	5	11200.381.001
1/4	250	11200.063.001	3/4	25	11200.191.001	1.5/8	5	11200.412.001
5/16 (#DIN)	250	11200.079.001	7/8	25	11200.222.001	1.3/4	4	11200.444.001
3/8	100	11200.096.001	1 Inch	25	11200.254.001	2 Inch	1	11200.508.001
7/16	100	11200.111.001	1.1/8	25	11200.285.001	2.1/4	1	11200.571.001

47100 Hexagon nut BSW X08A

Thread Material British Standard Whitworth Brass Cu3



d	☒	Art.number	d	☒	Art.number	d	☒	Art.number
1/8	250	47100.031.001	5/16	250	47100.079.001	3/4	10	47100.191.001
5/32	250	47100.039.001	3/8	100	47100.096.001	7/8	10	47100.222.001
3/16	250	47100.047.001	1/2	50	47100.127.001	1 Inch	5	47100.254.001
1/4	250	47100.063.001	5/8	25	47100.158.001			

Hexagon nut BSF

BS ≈1083 (1965)

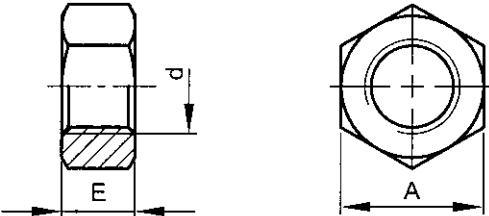
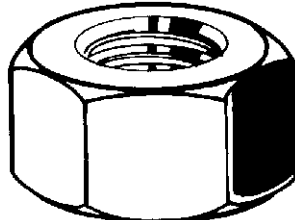
Technical Data

d	A	E	Threads per inch	d	A	E	Threads per inch
1/4	0.445	5.1	26	5/8	1.01	14.3	14
5/16	0.525	6.4	22	3/4	1.2	17.5	12
3/8	0.6	7.9	20	7/8	1.3	19	11
7/16	0.71	9.5	18	1 Inch	1.48	22.2	10
1/2	0.82	11.1	16				

- Whitworth thread (BSW/BSF) is not internationally recommended.
- It is advised to use metric (M/MF) or unified threads (UNC/UNF).

03060 Hexagon nut BSF X90A

Thread Material Class British Standard Fine Steel ≥6



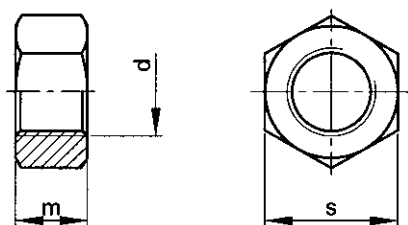

d	☒	Art.number	d	☒	Art.number	d	☒	Art.number
1/4	100	03060.063.001	7/16	100	03060.111.001	3/4	50	03060.191.001
5/16	100	03060.079.001	1/2	100	03060.127.001	7/8	25	03060.222.001
3/8	100	03060.096.001	5/8	50	03060.158.001	1 Inch	25	03060.254.001

Hexagon nut 1 x d

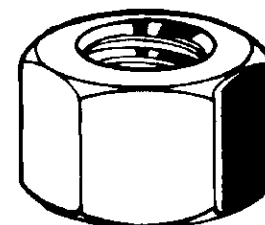

DIN ≈934 (1987)
 NEN ≈1560
 NF ≈E25-401



Technical Data

d	m	P	s	d	m	P	s
M3	3	0.5	5.5	M27	27	3	41
M4	4	0.7	7	M30	30	3.5	46
M5	5	0.8	8	M33	33	3.5	50
M6	6	1	10	M36	36	4	55
M8	8	1.25	13	M39	39	4	60
M10	10	1.5	17	M42	42	4.5	65
M12	12	1.75	19	M45	45	4.5	70
M14	14	2	22	M48	48	5	75
M16	16	2	24	M52	52	5	80
M18	18	2.5	27	M56	56	5.5	85
M20	20	2.5	30	M60	60	5.5	90
M22	22	2.5	32	M64	64	6	95
M24	24	3	36	M72	72	6	105

Article groups

Thread	Driving features	Material	Class	Code	Page
M	Hexagon	St	≥ 6	11080	3-29
M	Hexagon	St.St. A2		51109	3-29
M	Hexagon	St.St. A4		55109	3-30

11080 Hexagon nut 1 x d F01A

Thread: Metric thread
 Material: Steel
 Class: ≥|6|

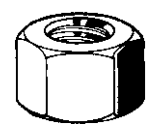
d	Art.number	d	Art.number	d	Art.number
M4	250 11080.040.001	M20	25 11080.200.001	M45	4 11080.450.001
M5	250 11080.050.001	M22	25 11080.220.001	M48	4 11080.480.001
M6	250 11080.060.001	M24	25 11080.240.001	M52	1 11080.520.001
M8	100 11080.080.001	M27	10 11080.270.001	M56	1 11080.560.001
M10	100 11080.100.001	M30	10 11080.300.001	M60	1 11080.600.001
M12	100 11080.120.001	M33	10 11080.330.001	M64	1 11080.640.001
M14	100 11080.140.001	M36	5 11080.360.001	M72	1 11080.720.001
M16	50 11080.160.001	M39	5 11080.390.001		
M18	25 11080.180.001	M42	5 11080.420.001		

51109 Hexagon nut 1 x d R09A

Thread: Metric thread
 Material: Stainless steel A2

d	Art.number	d	Art.number	d	Art.number
M3*	1000 51109.030.001	M5*	1000 51109.050.001	M8*	200 51109.080.001

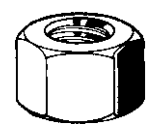
55109 Hexagon nut 1 x d R09A

Thread Metric thread
Material Stainless steel A4





d	☒	Art.number	d	☒	Art.number	d	☒	Art.number
M3*	1000	55109.030.001	M6*	1000	55109.060.001	M12*	100	55109.120.001
M4*	1000	55109.040.001	M8*	1000	55109.080.001	M16*	50	55109.160.001
M5*	1000	55109.050.001	M10*	100	55109.100.001			

3

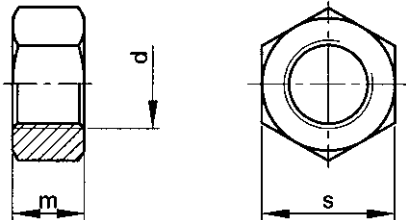
Hexagon machine screw nut BSW 1 x d

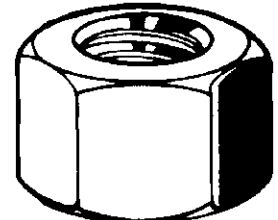

DIN ≈934 (1954)
 NEN ≈2338 (1960)



Technical Data

d	m	s	Threads per inch	d	m	s	Threads per inch
5/16	7.9	13	18	1 Inch	25.4	41	8
3/8	9.5	17	16	1.1/4	31.8	50	7
1/2	12.7	22	12	1.1/2	38.1	60	6
5/8	15.9	27	11	1.5/8	41.3	65	5
3/4	19.1	32	10				

11280 Hexagon machine screw nut BSW 1 x d X08A

Thread British Standard Whitworth
Material Free-cutting steel
Class 6

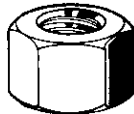

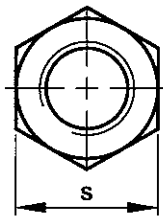
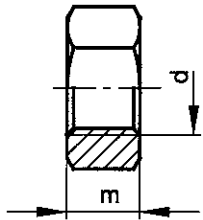

d	☒	Art.number	d	☒	Art.number	d	☒	Art.number
5/16	100	11280.079.001	5/8	50	11280.158.001	1.1/4	10	11280.317.001
3/8	100	11280.096.001	3/4	25	11280.191.001	1.1/2	5	11280.381.001
1/2	50	11280.127.001	1 Inch	10	11280.254.001	1.5/8	5	11280.412.001

Hexagon nut DIN 555

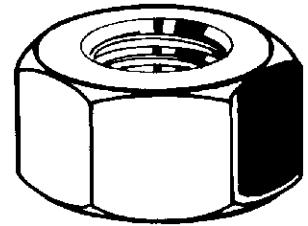

DIN 555 (1987)
NEN 697
NF E25-402



Technical Data

d	m	P	s	d	m	P	s
M6	4	0.8	10	M33	26	3.5	50
M10	8	1.5	17	M36	29	4	55
M12	10	1.75	19	M39	31	4	60
M16	13	2	24	M42	34	4.5	65
M18 (≠DIN)	15	2.5	27	M45	36	4.5	70
M20	16	2.5	30	M48	38	5	75
M22	18	2.5	32	M52	42	5	80
M24	19	3	36	M56	45	5.5	85
M27	22	3	41	M64	51	6	95
M30	24	3.5	46				

Article groups

Thread	Driving features	Material	Class	Surface treatment	Code	Page
M	Hexagon	St	≥ 4		08100	3-31
M	Hexagon	St	≥ 4	Zipl	08110	3-31

08100 Hexagon nut DIN 555

E01A

Thread Metric thread
Material Steel
Class ≥|4|

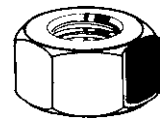

d	Art.number	d	Art.number	d	Art.number
M6	500 08100.060.001	M24	50 08100.240.001	M42	5 08100.420.001
M10	500 08100.100.001	M27	25 08100.270.001	M45	4 08100.450.001
M12	500 08100.120.001	M30	25 08100.300.001	M48	4 08100.480.001
M16	200 08100.160.001	M33	10 08100.330.001	M52	4 08100.520.001
M18 (≠DIN)	100 08100.180.001	M36	10 08100.360.001	M56	1 08100.560.001
M20	100 08100.200.001	M39	5 08100.390.001	M64	1 08100.640.001
M22	50 08100.220.001				

08110 Hexagon nut DIN 555

E03A

Thread Metric thread
Material Steel
Class ≥|4|
Surface treatment Zinc plated

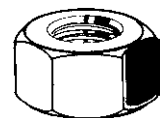

d	Art.number	d	Art.number	d	Art.number
M12	500 08110.120.001	M27	25 08110.270.001	M42	5 08110.420.001
M16	200 08110.160.001	M30	25 08110.300.001	M45	4 08110.450.001
M20	100 08110.200.001	M33	10 08110.330.001	M48	4 08110.480.001
M24	50 08110.240.001	M36	10 08110.360.001		

Hexagon thin nut

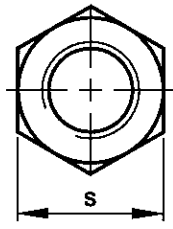
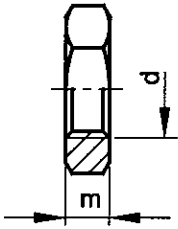

DIN 439 (1987)
NEN 2334 B
ASME B18.2.4.5M
NF E25-405-1

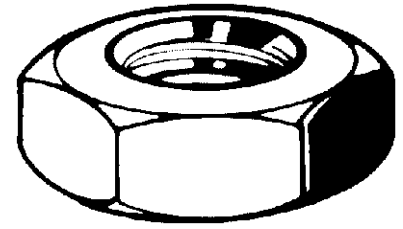

3

Technical Data

d	m	P	s	d	m	P	s
M1.6	1	0.35	3.2	M22	11	2.5	32
M2	1.2	0.4	4	M24	10	3	36
M2.5	1.6	0.45	5	M27	13.5	3	41
M3	1.8	0.5	5.5	M30	15	3.5	46
M4	2.2	0.7	7	M33	16.5	3.5	50
M5	2.7	0.8	8	M36	18	4	55
M6	3.2	1	10	M39	19.5	4	60
M8	4	1.25	13	M42	21	4.5	65
M10	5	1.5	17	M45	22.5	4.5	70
M12	6	1.75	19	M48	24	5	75
M14	7	2	22	M52	26	5	80
M16	8	2	24	M56 (#DIN)	28	5.5	85
M18	9	2.5	27	M60 (#DIN)	30	5.5	90
M20	10	2.5	30				

Article groups

Thread	Driving features	Material	Class	Surface treatment	Code	Page
M	Hexagon	St	04		11060	3-32
M	Hexagon	St	04	Zipl	11360	3-32
M	Hexagon	St	04	Zipl left hand	11382	3-33
M	Hexagon	St	04	Zipl yell.p.	11350	3-33
M	Hexagon	St	04	Hot d.g.	01580	3-33
M	Hexagon	St	04	Hot d.g. ISO metric	01586	3-33
M	Hexagon	St.St. A2	35		51090	3-34
M	Hexagon	St.St. A2	35	left hand	51093	3-34
M	Hexagon	St.St. A4	35		55090	3-34
M	Hexagon	Br Cu2			47030	3-34

11060 Hexagon thin nut

F01A

Thread Metric thread
Material Steel
Class 04

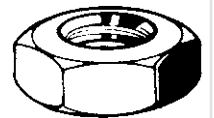

d	Art.number	d	Art.number	d	Art.number
M3	250 11060.030.001	M16	50 11060.160.001	M36	5 11060.360.001
M4	250 11060.040.001	M18	25 11060.180.001	M39	5 11060.390.001
M5	250 11060.050.001	M20	25 11060.200.001	M42	5 11060.420.001
M6	250 11060.060.001	M22	25 11060.220.001	M45	4 11060.450.001
M8	100 11060.080.001	M24	25 11060.240.001	M48	4 11060.480.001
M10	100 11060.100.001	M27	10 11060.270.001	M52	1 11060.520.001
M12	100 11060.120.001	M30	10 11060.300.001	M56	1 11060.560.001
M14	100 11060.140.001	M33	10 11060.330.001	M60	1 11060.600.001

11360 Hexagon thin nut

F01A

Thread Metric thread
Material Steel
Class 04
Surface treatment Zinc plated

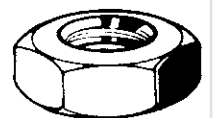

d	Art.number	d	Art.number	d	Art.number
M2	250 11360.020.001	M4	250 11360.040.001	M8	100 11360.080.001
M2,5	250 11360.025.001	M5	250 11360.050.001	M10	100 11360.100.001
M3	250 11360.030.001	M6	250 11360.060.001	M12	100 11360.120.001

11360 Hexagon thin nut								
d	☒	Art.number	d	☒	Art.number	d	☒	Art.number
M14	100	11360.140.001	M24	25	11360.240.001	M39	5	11360.390.001
M16	50	11360.160.001	M27	10	11360.270.001	M42	5	11360.420.001
M18	25	11360.180.001	M30	10	11360.300.001	M45	4	11360.450.001
M20	25	11360.200.001	M33	10	11360.330.001	M48	4	11360.480.001
M22	25	11360.220.001	M36	5	11360.360.001			

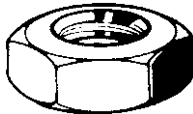
11382 Hexagon thin nut left hand thread							F01A
Thread	Metric thread						
Material	Steel						
Class	04						
Surface treatment	Zinc plated						
							

d	☒	Art.number	d	☒	Art.number	d	☒	Art.number
M5	250	11382.050.001	M12	100	11382.120.001	M24	25	11382.240.001
M6	250	11382.060.001	M16	50	11382.160.001	M27	10	11382.270.001
M8	100	11382.080.001	M20	25	11382.200.001	M30	10	11382.300.001
M10	100	11382.100.001						



11350 Hexagon thin nut							F01A
Thread	Metric thread						
Material	Steel						
Class	04						
Surface treatment	Zinc plated yellow passivated						

d	☒	Art.number	d	☒	Art.number	d	☒	Art.number
M3	250	11350.030.001	M10	100	11350.100.001	M20	25	11350.200.001
M4	250	11350.040.001	M12	100	11350.120.001	M22	25	11350.220.001
M5	250	11350.050.001	M14	100	11350.140.001	M24	25	11350.240.001
M6	250	11350.060.001	M16	50	11350.160.001	M27	10	11350.270.001
M8	100	11350.080.001	M18	25	11350.180.001	M30	10	11350.300.001

01580 Hexagon thin nut oversized thread							A08A
Thread	Metric thread						
Material	Steel						
Class	04						
Surface treatment	Hot dip galvanized						
							

d	☒	Art.number	d	☒	Art.number	d	☒	Art.number
M12	100	01580.120.001	M20	50	01580.200.001	M24	25	01580.240.001
M14	100	01580.140.001	M22	25	01580.220.001	M30	25	01580.300.001
M16	100	01580.160.001						

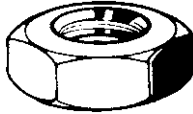
- These hexagon nuts are used among other to hot dip galvanized bolts and screws with OVERSIZED thread and to hot dip galvanized threaded rods with OVERSIZED thread.
- The nuts are tapped AFTER galvanizing and DO NOT meet the ISO-metric tolerances.
- The corrosion resistance is not influenced disadvantageously, with assembled nuts, by the uncoated thread.

01586 Hexagon thin nut ISO-Metric fitting thread							A08A
Thread	Metric thread						
Material	Steel						
Class	04						
Surface treatment	Hot dip galvanized						
							

d	☒	Art.number	d	☒	Art.number	d	☒	Art.number
M12	100	01586.120.001	M16	50	01586.160.001	M24	25	01586.240.001
M14	100	01586.140.001	M20	25	01586.200.001	M30	25	01586.300.001

- These hexagon nuts are used among other to hot dip galvanized bolts and screws with ISO-METRIC FITTING thread and to hot dip galvanized threaded rods with ISO-METRIC FITTING thread.
- The nuts are tapped AFTER galvanizing and meet the tolerances 6H.
- The corrosion resistance is not influenced disadvantageously, with assembled nuts, by the uncoated thread.

3

51090 Hexagon thin nut R09A

Thread Material Class Metric thread
Stainless steel A2
35



d	☒	Art.number	d	☒	Art.number	d	☒	Art.number
M1,6	250	51090.016.001	M10	100	51090.100.001	M27	5	51090.270.001
M2	250	51090.020.001	M12	50	51090.120.001	M30	3	51090.300.001
M2,5	250	51090.025.001	M14	50	51090.140.001	M33*	10	51090.330.001
M3	250	51090.030.001	M16	50	51090.160.001	M36	10	51090.360.001
M4	250	51090.040.001	M18	25	51090.180.001	M39*	10	51090.390.001
M5	250	51090.050.001	M20	25	51090.200.001	M42*	10	51090.420.001
M6	250	51090.060.001	M22	10	51090.220.001	M48*	10	51090.480.001
M8	100	51090.080.001	M24	10	51090.240.001			

51093 Hexagon thin nut left hand thread R09A

Thread Material Class Metric thread
Stainless steel A2
35

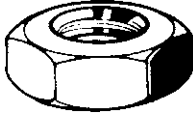
d	☒	Art.number	d	☒	Art.number	d	☒	Art.number
M5	200	51093.050.001	M10	100	51093.100.001	M20	25	51093.200.001
M6	200	51093.060.001	M12	50	51093.120.001	M24	25	51093.240.001
M8	100	51093.080.001	M16	50	51093.160.001			

55090 Hexagon thin nut R49A

Thread Material Class Metric thread
Stainless steel A4
35

d	☒	Art.number	d	☒	Art.number	d	☒	Art.number
M2	250	55090.020.001	M12	50	55090.120.001	M30	3	55090.300.001
M2,5	250	55090.025.001	M14	50	55090.140.001	M33*	10	55090.330.001
M3	250	55090.030.001	M16	50	55090.160.001	M36*	10	55090.360.001
M4	250	55090.040.001	M18	25	55090.180.001	M39*	10	55090.390.001
M5	250	55090.050.001	M20	25	55090.200.001	M42*	10	55090.420.001
M6	250	55090.060.001	M22	10	55090.220.001	M45*	10	55090.450.001
M8	100	55090.080.001	M24	10	55090.240.001	M48*	10	55090.480.001
M10	100	55090.100.001	M27	5	55090.270.001			

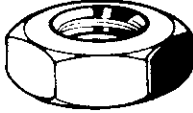
47030 Hexagon thin nut M01C

Thread Material Metric thread
Brass Cu2



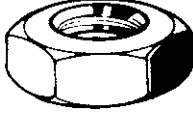

d	☒	Art.number	d	☒	Art.number	d	☒	Art.number
M3	250	47030.030.001	M8	100	47030.080.001	M16	50	47030.160.001
M4	250	47030.040.001	M10	100	47030.100.001	M20	50	47030.200.001
M5	250	47030.050.001	M12	100	47030.120.001	M24	25	47030.240.001
M6	250	47030.060.001						

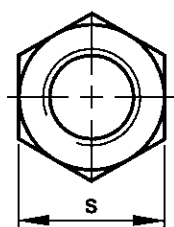
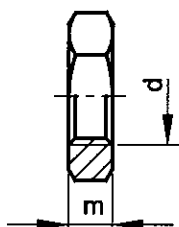
Hexagon thin nut MF

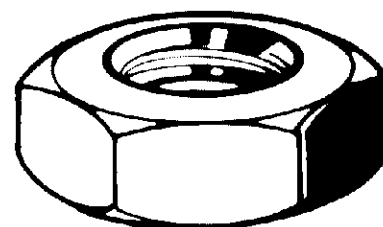

DIN 439 (1987)
NEN 2334 B
ASME B18.2.4.5M
NF E25-453



Technical Data

d	m	s	d	m	s
M8	4	13	M33	16.5	50
M10	5	17	M35 (#DIN)	17.5	55
M12	6	19	M36	18	55
M14	7	22	M38 (#DIN)	19	60
M16	8	24	M39	19.5	60
M18	9	27	M40 (#DIN)	20	60
M20	10	30	M42	21	65
M22	11	32	M45	22.5	70
M24	12	36	M48	24	75
M27	13.5	41	M52	26	80
M28 (#DIN)	14	41	M56 (#DIN)	28	85
M30	15	46	M64 (#DIN)	32	95
M32 (#DIN)	16	50			

Article groups

Thread	Driving features	Material	Class	Surface treatment	Code	Page	
MF	Hexagon	St	04		11070	3-35	
MF	Hexagon	St	04		left hand	11074	3-36
MF	Hexagon	St	04	Zipl		11380	3-36
MF	Hexagon	St	04	Zipl	left hand	11075	3-36
MF	Hexagon	St.St. A2	35			51092	3-36
MF	Hexagon	St.St. A2	35		left hand	51166	3-37
MF	Hexagon	St.St. A4	35			55092	3-37
MF	Hexagon	St.St. A4	35		left hand	55166	3-37

11070 Hexagon thin nut MF

F01B

Thread Metric fine thread
Material Steel
Class 04

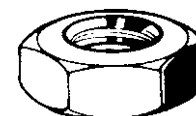

d x P	☒	Art.number	d x P	☒	Art.number	d x P	☒	Art.number
M8X1,00	100	11070.080.100	M22X1,50	25	11070.220.150	M39X3,00	3	11070.390.300
M10X1,00	100	11070.100.100	M22X2,00	25	11070.220.200	M40X1,50 (#DIN)	3	11070.400.150
M10X1,25	100	11070.100.125	M24X1,50	25	11070.240.150	M40X2,00 (#DIN)	3	11070.400.200
M12X0,75 (#DIN)	100	11070.120.075	M24X2,00 (#DIN)	25	11070.240.200	M42X1,50	3	11070.420.150
M12X1,00 (#DIN)	100	11070.120.100	M27X1,50	10	11070.270.150	M45X1,50	1	11070.450.150
M12X1,25	100	11070.120.125	M27X2,00	10	11070.270.200	M45X2,00	1	11070.450.200
M12X1,50	100	11070.120.150	M30X1,50	10	11070.300.150	M45X3,00	1	11070.450.300
M14X1,00 (#DIN)	100	11070.140.100	M30X2,00	10	11070.300.200	M48X1,50	1	11070.480.150
M14X1,25 (#DIN)	100	11070.140.125	M32X1,50	10	11070.320.150	M48X2,00	1	11070.480.200
M14X1,50	100	11070.140.150	M32X2,00	5	11070.320.200	M48X3,00	1	11070.480.300
M16X1,00 (#DIN)	50	11070.160.100	M33X1,50	5	11070.330.150	M52X1,50	1	11070.520.150
M16X1,50	50	11070.160.150	M33X2,00	5	11070.330.200	M52X2,00	1	11070.520.200
M18X1,00 (#DIN)	25	11070.180.100	M35X1,50 (#DIN)	3	11070.350.150	M52X3,00	1	11070.520.300
M18X2,00	25	11070.180.200	M36X1,50	3	11070.360.150	M56X2,00 (#DIN)	1	11070.560.200
M20X1,00 (#DIN)	25	11070.200.100	M36X3,00	3	11070.360.300	M56X4,00 (#DIN)	1	11070.560.400
M20X1,50	25	11070.200.150	M38X1,50 (#DIN)	3	11070.380.150	M64X1,50 (#DIN)	1	11070.640.150
M20X2,00	25	11070.200.200	M39X1,50	3	11070.390.150	M64X2,00 (#DIN)	1	11070.640.200
M22X1,00 (#DIN)	25	11070.220.100	M39X2,00	3	11070.390.200	M64X4,00 (#DIN)	1	11070.640.400

11074 Hexagon thin nut left hand thread MF F01B

Thread: Metric fine thread
 Material: Steel
 Class: 04



d x P	☒	Art.number	d x P	☒	Art.number	d x P	☒	Art.number
M10X1,00	50	11074.100.100	M22X1,50	10	11074.220.150	M36X3,00	3	11074.360.300
M12X1,00 (≠DIN)	50	11074.120.100	M22X2,00	10	11074.220.200	M38X1,50 (≠DIN)	3	11074.380.150
M12X1,50	50	11074.120.150	M27X1,50	5	11074.270.150	M42X1,50	3	11074.420.150
M14X1,50	50	11074.140.150	M27X2,00	5	11074.270.200	M42X3,00	3	11074.420.300
M16X1,00 (≠DIN)	50	11074.160.100	M28X1,50 (≠DIN)	5	11074.280.150	M45X3,00	1	11074.450.300
M16X1,50	25	11074.160.150	M30X2,00	5	11074.300.200	M48X1,50	1	11074.480.150
M18X1,50	10	11074.180.150	M33X1,50	5	11074.330.150	M48X3,00	1	11074.480.300
M20X1,50	10	11074.200.150	M36X1,50	3	11074.360.150			
M20X2,00	10	11074.200.200	M36X2,00	3	11074.360.200			

11380 Hexagon thin nut MF F01B

Thread: Metric fine thread
 Material: Steel
 Class: 04
 Surface treatment: Zinc plated

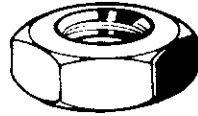
d x P	☒	Art.number	d x P	☒	Art.number	d x P	☒	Art.number
M8X1,00	100	11380.080.100	M14X1,50	100	11380.140.150	M24X1,50	25	11380.240.150
M10X1,00	100	11380.100.100	M16X1,00 (≠DIN)	50	11380.160.100	M24X2,00	25	11380.240.200
M10X1,25	100	11380.100.125	M16X1,50	50	11380.160.150	M27X1,50	10	11380.270.150
M12X1,00 (≠DIN)	100	11380.120.100	M18X1,00 (≠DIN)	25	11380.180.100	M27X2,00	10	11380.270.200
M12X1,25	100	11380.120.125	M18X1,50	25	11380.180.150	M30X1,50	10	11380.300.150
M12X1,50	100	11380.120.150	M20X1,00 (≠DIN)	25	11380.200.100	M30X2,00	10	11380.300.200
M14X1,00 (≠DIN)	100	11380.140.100	M20X1,50	25	11380.200.150	M36X1,50	3	11380.360.150
M14X1,25 (≠DIN)	100	11380.140.125	M22X1,50	25	11380.220.150	M36X3,00	3	11380.360.300

11075 Hexagon thin nut left hand thread MF F01B

Thread: Metric fine thread
 Material: Steel
 Class: 04
 Surface treatment: Zinc plated



d x P	☒	Art.number	d x P	☒	Art.number	d x P	☒	Art.number
M12X1,00 (≠DIN)	50	11075.120.100	M16X1,50	25	11075.160.150	M24X2,00	10	11075.240.200
M12X1,50	50	11075.120.150	M18X1,50	10	11075.180.150	M27X2,00	5	11075.270.200
M14X1,50	50	11075.140.150	M20X1,50	10	11075.200.150	M30X2,00	5	11075.300.200
M16X1,00 (≠DIN)	50	11075.160.100						

51092 Hexagon thin nut MF R09A

Thread: Metric fine thread
 Material: Stainless steel A2
 Class: 35

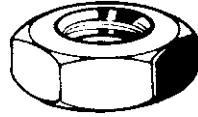
d x P	☒	Art.number	d x P	☒	Art.number	d x P	☒	Art.number
M8X0,75*	200	51092.080.075	M14X1,50	50	51092.140.150	M24X1,50	10	51092.240.150
M8X1,00	100	51092.080.100	M16X1,50	50	51092.160.150	M24X2,00	10	51092.240.200
M10X1,00	100	51092.100.100	M18X1,50	25	51092.180.150	M27X1,50	3	51092.270.150
M10X1,25	100	51092.100.125	M20X1,50	25	51092.200.150	M30X1,50	3	51092.300.150
M12X1,00	100	51092.120.100	M20X2,00*	50	51092.200.200	M30X2,00	3	51092.300.200
M12X1,25	100	51092.120.125	M22X1,50	10	51092.220.150	M33X2,00*	10	51092.330.200
M12X1,50	100	51092.120.150	M22X2,00*	25	51092.220.200			

51166	Hexagon thin nut left hand thread MF		R09A
Thread	Metric fine thread		 
Material	Stainless steel A2		
Class	35		

d x P	✉	Art.number	d x P	✉	Art.number	d x P	✉	Art.number
M16X1,50	50	51166.160.150	M27X2,00	3	51166.270.200	M30X2,00	3	51166.300.200
M20X1,50	25	51166.200.150						

55092	Hexagon thin nut MF		R49A
Thread	Metric fine thread		 
Material	Stainless steel A4		
Class	35		

d x P	✉	Art.number	d x P	✉	Art.number	d x P	✉	Art.number
M8X1,00	100	55092.080.100	M16X1,50	50	55092.160.150	M24X2,00	10	55092.240.200
M10X1,00	100	55092.100.100	M18X1,50	25	55092.180.150	M27X1,50*	25	55092.270.150
M10X1,25	100	55092.100.125	M20X1,50	25	55092.200.150	M27X2,00*	25	55092.270.200
M12X1,00*	100	55092.120.100	M22X1,50	10	55092.220.150	M30X1,50	10	55092.300.150
M12X1,25	100	55092.120.125	M22X2,00*	25	55092.220.200	M30X2,00*	10	55092.300.200
M12X1,50	100	55092.120.150	M24X1,50	10	55092.240.150	M33X2,00*	10	55092.330.200
M14X1,50	50	55092.140.150						

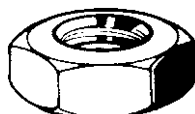
55166	Hexagon thin nut left hand thread MF		R49A
Thread	Metric fine thread		 
Material	Stainless steel A4		
Class	35		

d x P	✉	Art.number	d x P	✉	Art.number
M16X1,50*	50	55166.160.150	M20X1,50*	50	55166.200.150

Hexagon thin nut

DIN 936

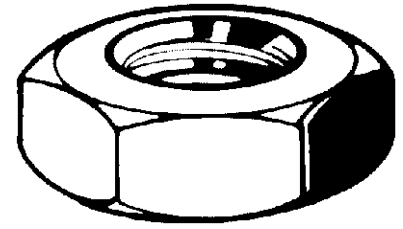
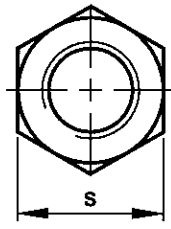
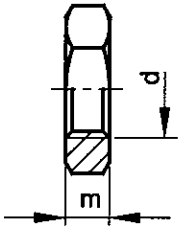

3

Technical Data

d	m	P	s
M8	5	1.25	13
M10	6	1.5	17
M12	7	1.75	19
M14	8	2	22
M16	8	2	24
M18	9	2.5	27
M20	9	2.5	30
M22	10	2.5	32
M24	10	3	36
M27	12	3	41
M30	12	3.5	46
M33	14	3.5	50
M36	14	4	55
M39	16	4	60

Article groups

Thread	Driving features	Material	Code	Page
M	Hexagon	St.St. A2	51221	3-38
M	Hexagon	St.St. A4	55221	3-38

51221 Hexagon thin nut R09A

Thread Metric thread
Material Stainless steel A2



d	Art.number	d	Art.number	d	Art.number
M8*	500 51221.080.001	M18*	50 51221.180.001	M30*	25 51221.300.001
M10*	200 51221.100.001	M20*	50 51221.200.001	M33*	10 51221.330.001
M12*	200 51221.120.001	M22*	50 51221.220.001	M36*	10 51221.360.001
M14*	100 51221.140.001	M24*	25 51221.240.001	M39*	10 51221.390.001
M16*	100 51221.160.001	M27*	25 51221.270.001		

55221 Hexagon thin nut R49A

Thread Metric thread
Material Stainless steel A4

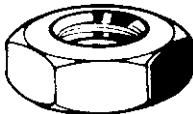

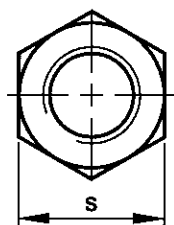
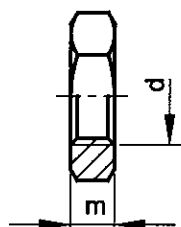

d	Art.number	d	Art.number	d	Art.number
M10*	200 55221.100.001	M16*	100 55221.160.001	M24*	25 55221.240.001
M12*	200 55221.120.001	M20*	50 55221.200.001	M27*	25 55221.270.001
M14*	100 55221.140.001				

Hexagon thin nut DIN 936 MF

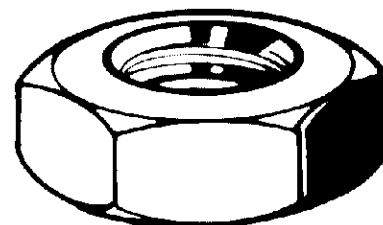

DIN 936



Technical Data

d	m	P	s
M10	6	17	1
M12	7	19	1
M20	9	30	1.5
M24	10	36	2

51222 Hexagon thin nut DIN 936 MF

R09A

Thread Metric fine thread
Material Stainless steel A2
Class 35

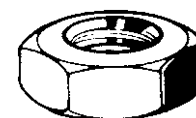

d x P	Art.number	d x P	Art.number	d x P	Art.number
M10X1,00*	100 51222.100.100	M20X1,50*	100 51222.200.150	M24X2,00*	50 51222.240.200
M12X1,00*	100 51222.120.100				

Hexagon nut ISO 4035

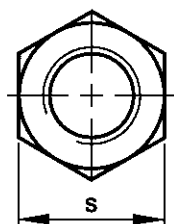
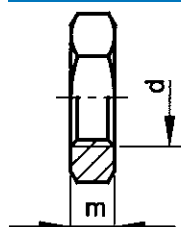

ISO 4035

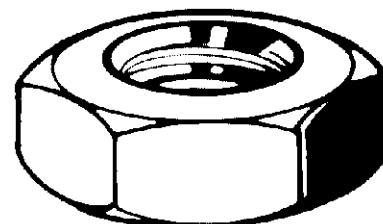

Technical Data

d	m (max.)	P	s
M12	6	1.75	18
M16	8	2	24
M20	10	2.5	30
M24	12	3	36
M27	14	3	41
M30	15	3.5	46
M36	18	4	55

01587 Hexagon nut ISO 4035

A08A

Thread Metric thread
Material Steel
Surface treatment Hot dip galvanized

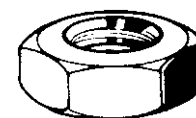

d	Art.number	d	Art.number	d	Art.number
M12	100 01587.120.001	M24	50 01587.240.001	M30	25 01587.300.001
M16	100 01587.160.001	M27	50 01587.270.001	M36	10 01587.360.001
M20	100 01587.200.001				

- These hexagon nuts are used among other to hot dip galvanized bolts and screws with ISO-METRIC FITTING thread and to hot dip galvanized threaded rods with ISO-METRIC FITTING thread.
- The nuts are tapped AFTER galvanizing and meet the tolerances 6H.
- The corrosion resistance is not influenced disadvantageously, with assembled nuts, by the uncoated thread.

Jamnut turned UNC

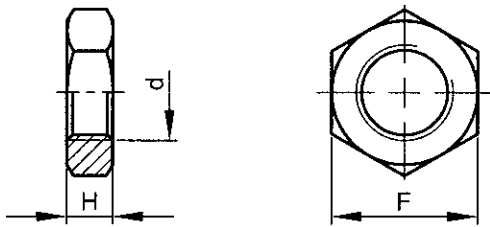

ASME ≈B18.2.2

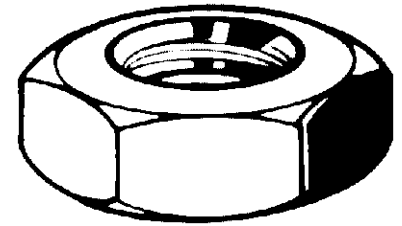

3

Technical Data

d	F	H (mm)	Threads per inch	d	F	H (mm)	Threads per inch
1/4	7/16	4	20	3/4	1.1/8	10.7	10
5/16	1/2	4.8	18	7/8	1.5/16	12.3	9
3/8	9/16	5.6	16	1 Inch	1.1/2	13.9	8
7/16	11/16	6.4	14	1.1/8	1.11/16	18.3	7
1/2	3/4	7.9	13	1.1/4	1.7/8	18.3	7
5/8	15/16	9.5	11	1.1/2	2.1/4	21.4	6

11840 Jamnut turned UNC

X09A

Thread Unified National Coarse
 Material Free-cutting steel
 Class 04
 Surface treatment Zinc plated

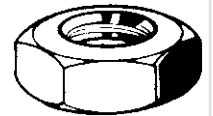

d	☒	Art.number	d	☒	Art.number	d	☒	Art.number
1/4	250	11840.063.001	1/2	100	11840.127.001	1 Inch	25	11840.254.001
5/16	250	11840.079.001	5/8	100	11840.158.001	1.1/8	10	11840.285.001
3/8	250	11840.096.001	3/4	50	11840.191.001	1.1/4	10	11840.317.001
7/16	100	11840.111.001	7/8	25	11840.222.001	1.1/2	5	11840.381.001

Pipe nut parallel thread

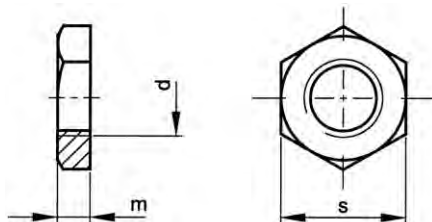

DIN 431 A

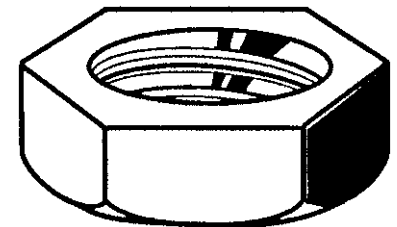

Technical Data

d	m (max.)	s	Threads per inch	d	m (max.)	s	Threads per inch
G 1/8	6.48	18	28	G 7/8	9.58	41	14
G 1/4	6.48	21	19	G 1 Inch	10.58	46	11
G 3/8	7.58	27	19	G 1.1/4	11.7	55	11
G 1/2	8.58	34	14	G 1.1/2	12.7	60	11
G 5/8	8.58	34	14	G 2 Inch	13.7	75	11
G 3/4	9.58	36	14				

Article groups

Thread	Driving features	Material	Code	Page
G	Hexagon	St.St. A2	51200	3-41
G	Hexagon	St.St. A4	55200	3-41

51200 Pipe nut parallel thread			R09A				
Thread	Cylindrical pipe thread						
Material	Stainless steel A2						
d	☒	Art.number	d	☒	Art.number		
G1/8*	100	51200.031.001	G5/8*	25	51200.158.001		
G1/4*	100	51200.063.001	G3/4*	25	51200.191.001		
G3/8*	50	51200.096.001	G7/8*	10	51200.222.001		
G1/2*	50	51200.127.001	G1 Inch*	10	51200.254.001		
					G1.1/4*	5	51200.317.001
					G1.1/2*	5	51200.381.001
					G2 Inch*	5	51200.508.001

55200 Pipe nut parallel thread			R49A				
Thread	Cylindrical pipe thread						
Material	Stainless steel A4						
d	☒	Art.number	d	☒	Art.number		
G1/8	50	55200.031.001	G1/2	25	55200.127.001		
G1/4	50	55200.063.001	G5/8	25	55200.158.001		
G5/16*	10	55200.079.001	G3/4	10	55200.191.001		
G3/8	50	55200.096.001	G1 Inch	4	55200.254.001		
					G1.1/4	1	55200.317.001
					G1.1/2	1	55200.381.001
					G2 Inch	1	55200.508.001

Trackshoe nut

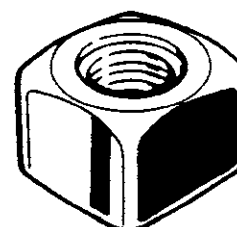
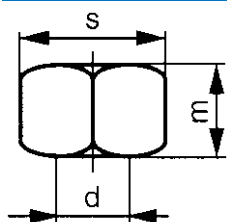

Technical Data

d x m	s (mm)	Threads per inch	d x m	s (mm)	Threads per inch
7/16x16	19	20	3/4x19	28	16
1/2x18	19	20	3/4x21	28	16
9/16x19	22	18	7/8x23	33.3	14
5/8x18	24	18	1 Inchx25.2	38.1	14
5/8x19	25	18	1 Inchx33	38.1	14

- The 1 Inch trackshoe nuts are class 6.
- For corresponding Trackshoe bolts see Section 1.

Article groups

Thread	Driving features	Material	Class	Code	Page
UNF	Hexagon	Free-cutting steel		06060	3-41
UNF	Hexagon	St	12	06070	3-42
UNF	Square head	St	12	06080	3-42

06060 Hexagon trackshoe nut high type			Y90A
Thread	Unified National Fine		
Material	Free-cutting steel		
d x m	☒	Art.number	
1 Inchx33	25	06060.256.001	

06070 Hexagon trackshoe nut thin						Y90A		
Thread	Unified National Fine							
Material	Steel							
Class	12							
d x m	✉	Art.number	d x m	✉	Art.number	d x m	✉	Art.number
5/8x18	50	06070.158.001	7/8x23	25	06070.222.001	1 Inchx25,2	25	06070.256.001
3/4x21	50	06070.191.001						

06080 Square trackshoe nut						Y90A		
Thread	Unified National Fine							
Material	Steel							
Class	12							
d x m	✉	Art.number	d x m	✉	Art.number	d x m	✉	Art.number
7/16x16	100	06080.111.001	5/8x19	50	06080.158.001	7/8x23	25	06080.222.001
1/2x18	100	06080.127.001	3/4x19	50	06080.191.001	1 Inchx25,2	25	06080.256.001
9/16x19	50	06080.142.001						

Exhaust nut

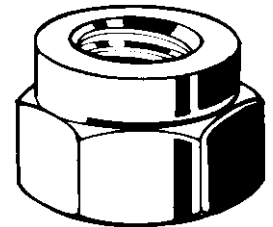
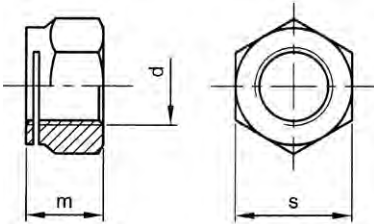

Article groups

Thread	Driving features	Material	Surface treatment		Code	Page
M	Hexagon	St	Copper plated	prevailing torque type	72130	3-42
MF	Hexagon	St	Copper plated	prevailing torque type	72131	3-42
UNC	Hexagon	Br			72122	3-43
UNF	Hexagon	Br			72123	3-43

72130 THERMAG Exhaust nut						Y92F		
Thread	Metric thread							
Material	Steel							
Surface treatment	Copper plated							
d	✉	Art.number	d	✉	Art.number	d	✉	Art.number
M8 s=12	100	72130.080.120	M10 s=14	100	72130.100.140	M12 s=17	50	72130.120.170
M8 s=13	100	72130.080.130	M10 s=17	100	72130.100.170			

• Temperature resistance from -70°C till +400°C

72131 THERMAG Exhaust nut						Y92F	
Thread	Metric fine thread						
Material	Steel						
Surface treatment	Copper plated						
d x P	✉	Art.number					
M10X1,25 s=14	100	72131.100.125					

• Temperature resistance from -70°C till +400°C

72122	Exhaust nut				Y92F
Thread	Unified National Coarse				
Material	Brass				
					
					

d	☒	Art.number	d	☒	Art.number
5/16		50 72122.079.001	3/8		25 72122.096.001

72123	Exhaust nut				Y92F
Thread	Unified National Fine				
Material	Brass				
					
					

d	☒	Art.number	d	☒	Art.number	d	☒	Art.number
5/16		50 72123.079.001	3/8		25 72123.096.001	1/2		10 72123.127.001

Hexagon connection nut height 3 x d

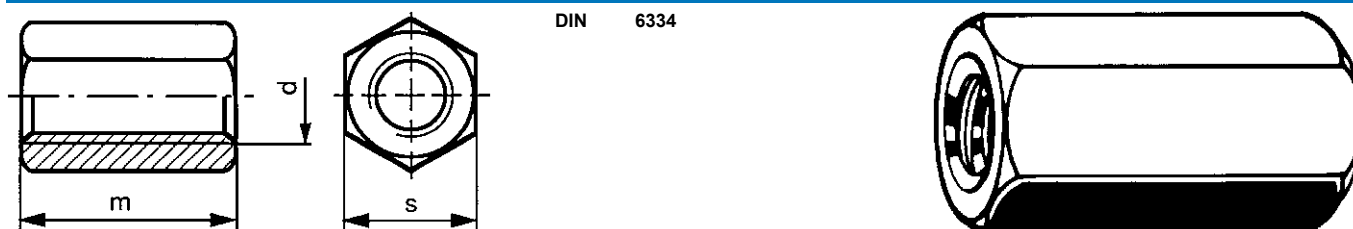

Technical Data							
d	m	P	s	d	m	P	s
M5	15	0.8	8	M20	60	2.5	30
M6	18	1	10	M22	66	2.5	32
M8	24	1.25	13	M24	72	3	36
M10	30	1.5	17	M27	81	3	41
M12	36	1.75	19	M30	90	3.5	46
M14	42	2	22	M36	108	4	55
M16	48	2	24	M42	126	4.5	65
M18	54	2.5	27	M48	144	5	75

• These connection nuts are used among others for connecting of threaded rods.

Article groups						
Thread	Driving features	Material	Class	Surface treatment	Code	Page
M	Hexagon	Free-cutting steel		Zipl	11400	3-43
M	Hexagon	St		Hot d.g.	ISO metric	11417 3-44
M	Hexagon	St		Hot d.g.	oversized	11411 3-44
M	Hexagon	St	[10]	Zipl		11418 3-44
M	Hexagon	St.St. A1				51106 3-44
M	Hexagon	St.St. A4				55106 3-44
M	Hexagon	Br				47195 3-45

11400	Hexagon connection nut height 3 x d				F01C
Thread	Metric thread				
Material	Free-cutting steel				
Surface treatment	Zinc plated				
					
					



d	☒	Art.number	d	☒	Art.number	d	☒	Art.number
M5		100 11400.050.001	M12		50 11400.120.001	M24		10 11400.240.001
M6		100 11400.060.001	M14		25 11400.140.001	M27		10 11400.270.001
M8		100 11400.080.001	M16		25 11400.160.001	M30		10 11400.300.001
M10		50 11400.100.001	M20		25 11400.200.001			

11417 Hexagon connection nut ISO-Metric fitting thread		F01A
Thread	Metric thread	 
Material	Steel	
Surface treatment	Hot dip galvanized	

d	☒	Art.number	d	☒	Art.number	d	☒	Art.number
M16	25	11417.160.001	M24	10	11417.240.001	M42	5	11417.420.001
M20	25	11417.200.001	M30	10	11417.300.001			

3

- These hexagon nuts are used among other to hot dip galvanized bolts and screws with ISO-METRIC FITTING thread and to hot dip galvanized threaded rods with ISO-METRIC FITTING thread.
- The nuts are tapped AFTER galvanizing and meet the tolerances 6H.
- The corrosion resistance is not influenced disadvantageously, with assembled nuts, by the uncoated thread.

11411 Hexagon connection nut oversized thread		F01A
Thread	Metric thread	 
Material	Steel	
Surface treatment	Hot dip galvanized	

d	☒	Art.number	d	☒	Art.number	d	☒	Art.number
M10	100	11411.100.001	M16	25	11411.160.001	M24	10	11411.240.001
M12	100	11411.120.001	M20	25	11411.200.001	M30	10	11411.300.001

11418 Hexagon connection nut height 3 x d		F01C
Thread	Metric thread	 
Material	Steel	
Class	[10]	
Surface treatment	Zinc plated	

d	☒	Art.number	d	☒	Art.number	d	☒	Art.number
M6	50	11418.060.001	M16	25	11418.160.001	M30	5	11418.300.001
M8	50	11418.080.001	M18	10	11418.180.001	M36	3	11418.360.001
M10	50	11418.100.001	M20	10	11418.200.001	M42	3	11418.420.001
M12	25	11418.120.001	M22	10	11418.220.001	M48	3	11418.480.001
M14	25	11418.140.001	M24	5	11418.240.001			

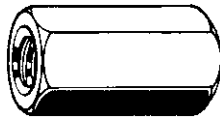

51106 Hexagon connection nut height 3 x d		R09A
Thread	Metric thread	 
Material	Stainless steel A1	

d	☒	Art.number	d	☒	Art.number	d	☒	Art.number
M5	50	51106.050.001	M12	25	51106.120.001	M20	10	51106.200.001
M6	50	51106.060.001	M14*	50	51106.140.001	M24	5	51106.240.001
M8	50	51106.080.001	M16	10	51106.160.001	M30*	10	51106.300.001
M10	25	51106.100.001						

- Depending on availability A1 can be supplied as well as A2.

55106 Hexagon connection nut height 3 x d		R49A
Thread	Metric thread	 
Material	Stainless steel A4	

d	☒	Art.number	d	☒	Art.number	d	☒	Art.number
M5	50	55106.050.001	M12	25	55106.120.001	M20	10	55106.200.001
M6	50	55106.060.001	M14*	50	55106.140.001	M24	5	55106.240.001
M8	50	55106.080.001	M16	10	55106.160.001	M30*	10	55106.300.001
M10	25	55106.100.001						

47195	Hexagon connection nut height 3 x d		M11C
Thread	Metric thread		
Material	Brass		
			

d	☒	Art.number	d	☒	Art.number	d	☒	Art.number
M5	100	47195.050.001	M10	50	47195.100.001	M20	25	47195.200.001
M6	100	47195.060.001	M12	50	47195.120.001	M24	10	47195.240.001
M8	100	47195.080.001	M16	25	47195.160.001			

Hexagon connection nut high

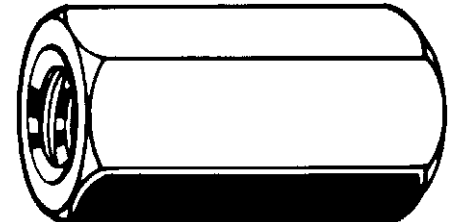
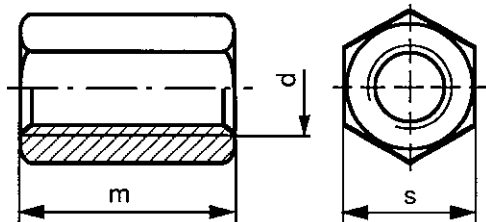

Technical Data		
d	P	s
M6	1	10
M8	1.25	13
M10	1.5	17
M12	1.75	19
M16	2	24
M20	2.5	30
M24	3	36
M30	3.5	46

Article groups						
Thread	Driving features	Material	Class	Surface treatment	Code	Page
M	Hexagon	Free-cutting steel		Zipl	11408	3-45
M	Hexagon	St.St. A2	50		51101	3-45
M	Hexagon	St.St. A4	50		55101	3-46

11408	Hexagon connection nut high		F01C
Thread	Metric thread		
Material	Free-cutting steel		
Surface treatment	Zinc plated		
			

d x m	☒	Art.number	d x m	☒	Art.number	d x m	☒	Art.number
M6X30	100	11408.060.030	M10X40	100	11408.100.040	M12X40	50	11408.120.040
M8X30	100	11408.080.030						

51101	Hexagon connection nut high		R09A
Thread	Metric thread		
Material	Stainless steel A2		
Class	50		
			

d x m	☒	Art.number	d x m	☒	Art.number	d x m	☒	Art.number
M6X25*	100	51101.060.025	M10X40*	100	51101.100.040	M16X50*	25	51101.160.050
M6X30*	100	51101.060.030	M12X30*	50	51101.120.030	M20X50*	25	51101.200.050
M8X25*	100	51101.080.025	M12X40*	50	51101.120.040	M24X50*	25	51101.240.050
M8X30*	100	51101.080.030	M16X40*	25	51101.160.040	M30X60*	10	51101.300.060
M10X25*	100	51101.100.025						

55101	Hexagon connection nut high	R49A
Thread	Metric thread	
Material	Stainless steel A4	
Class	50	
		

d x m	☒	Art.number	d x m	☒	Art.number	d x m	☒	Art.number
M6X25*	100	55101.060.025	M12X30*	50	55101.120.030	M24X50*	25	55101.240.050
M8X30*	100	55101.080.030	M16X40*	25	55101.160.040	M30X60*	10	55101.300.060
M10X30*	100	55101.100.030	M20X50*	25	55101.200.050			

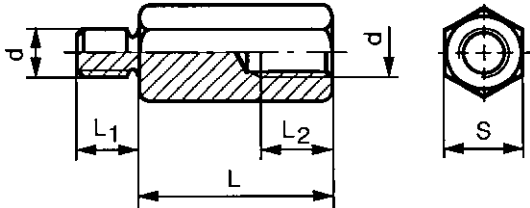

3

Spacer with internal thread and external threaded stud type H1202



Technical Data

d	L ₁	P	s	d	L ₁	P	s
M2.5	5.6	0.45	4	M4	8	0.7	7
M3	6	0.5	5.5	M5	10	0.8	8

11398	Spacer with internal thread and external threaded stud type H1202	F01C
Thread	Metric thread	
Material	Free-cutting steel	
Class	[6]	
Surface treatment	Zinc plated	
		

d x L x L ₂	☒	Art.number	d x L x L ₂	☒	Art.number	d x L x L ₂	☒	Art.number
M2,5X10X3	100	11398.025.010	M3X25X7	100	11398.030.025	M4X35X9	100	11398.040.035
M2,5X15X7	100	11398.025.015	M3X30X7	100	11398.030.030	M4X40X9	100	11398.040.040
M2,5X20X7	100	11398.025.020	M3X35X7	100	11398.030.035	M4X50X9	100	11398.040.050
M2,5X25X7	100	11398.025.025	M3X40X7	100	11398.030.040	M5X10X6	100	11398.050.010
M3X5X3	100	11398.030.005	M3X45X7	100	11398.030.045	M5X15X11	100	11398.050.015
M3X8X5	100	11398.030.008	M3X50X7	100	11398.030.050	M5X20X11	100	11398.050.020
M3X10X7	100	11398.030.010	M4X5X3	100	11398.040.005	M5X25X11	100	11398.050.025
M3X12X7	100	11398.030.012	M4X10X6	100	11398.040.010	M5X30X11	100	11398.050.030
M3X13,5X7	100	11398.030.013	M4X15X9	100	11398.040.015	M5X35X11	100	11398.050.035
M3X15X7	100	11398.030.015	M4X20X9	100	11398.040.020	M5X40X11	100	11398.050.040
M3X18X7	100	11398.030.018	M4X25X9	100	11398.040.025	M5X50X11	100	11398.050.050
M3X20X7	100	11398.030.020	M4X30X9	100	11398.040.030			

Spacer with 2x internal thread H1200

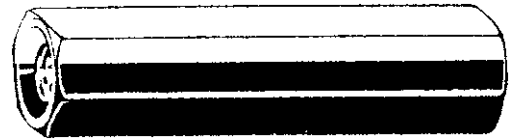
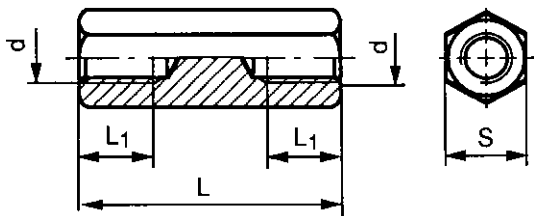

Technical Data

d	P	s	d	P	s
M2.5	0.45	4	M4	0.7	7
M3	0.5	5.5	M5	0.8	8

11396 Spacer with 2x internal thread H1200

F01C

Thread Metric thread
Material Free-cutting steel
Class [6]
Surface treatment Zinc plated

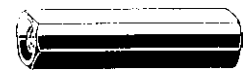

d x L x L ₁	☒	Art.number	d x L x L ₁	☒	Art.number	d x L x L ₁	☒	Art.number
M2,5X15X7	100	11396.025.015	M3X35X7	100	11396.030.035	M4X40X9	100	11396.040.040
M2,5X20X7	100	11396.025.020	M3X40X7	100	11396.030.040	M4X50X9	100	11396.040.050
M2,5X25X7	100	11396.025.025	M3X45X7	100	11396.030.045	M5X15X15	100	11396.050.015
M3X5X5	100	11396.030.005	M3X50X7	100	11396.030.050	M5X20X9	100	11396.050.020
M3X8,5X8,5	100	11396.030.008	M4X10X10	100	11396.040.010	M5X25X9	100	11396.050.025
M3X10X10	100	11396.030.010	M4X15X15	100	11396.040.015	M5X30X9	100	11396.050.030
M3X12X12	100	11396.030.012	M4X20X9	100	11396.040.020	M5X35X9	100	11396.050.035
M3X15X7	100	11396.030.015	M4X25X9	100	11396.040.025	M5X40X9	100	11396.050.040
M3X20X7	100	11396.030.020	M4X30X9	100	11396.040.030	M5X45X9	100	11396.050.045
M3X25X7	100	11396.030.025	M4X35X9	100	11396.040.035	M5X50X9	100	11396.050.050
M3X30X7	100	11396.030.030						

Reducer

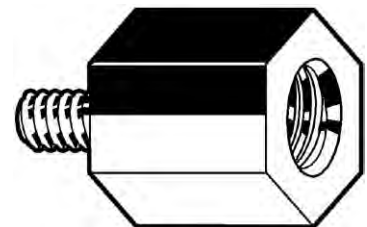
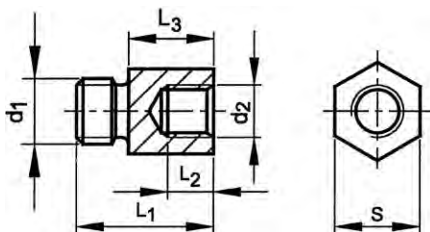

Technical Data

d ₂ / d ₁	L ₁	L ₂	L ₃	P/P	s
M6/M8	20	7	12	1/1.25	13
M6/M10	21	7	13	1/1.25	13
M8/M6	19	7	12	1.25/1	13
M8/M10	21	7	13	1.25/1.5	13
M8/M12	23	7	13	1.25/1.75	13
M10/M6	22	9	15	1.5/1	13
M10/M8	23	9	15	1.5/1.25	13
M10/M12	23	8	13	1.5/1.75	13
M10/M16	32	9	18	1.5/2	19
M12/M8	23	8	15	1.75/1.25	17
M12/M10	25	8	15	1.75/1.5	17
M16/M10	32	13	22	2/1.5	24
M16/M12	32	13	22	2/1.75	24

11393	Reducer	F01C
Thread	Metric thread	
Material	Free-cutting steel	
Surface treatment	Zinc plated	

$d_2/d_1 \times s$	☒	Art.number	$d_2/d_1 \times s$	☒	Art.number	$d_2/d_1 \times s$	☒	Art.number
M6XM8/s=13	25	11393.060.080	M10XM6/s=13	25	11393.100.060	M12XM8/s=17	10	11393.120.080
M6XM10/s=13	25	11393.060.100	M10XM8/s=13	25	11393.100.080	M12XM10/s=17	10	11393.120.100
M8XM6/s=13	25	11393.080.060	M10XM12/s=13	25	11393.100.120	M16XM10/s=24	5	11393.160.100
M8XM10/s=13	25	11393.080.100	M10XM16/s=17	10	11393.100.160	M16XM12/s=24	5	11393.160.120
M8XM12/s=13	25	11393.080.120						

3

Prevailing torque type hexagon nut with non-metallic insert

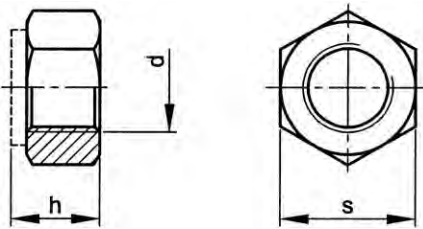

DIN 985 (1987)
ISO 7040
NF E25-412

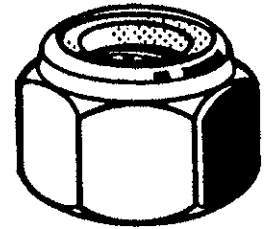

Technical Data

d	h	P	s	d	h	P	s
M2.5 (#DIN)	3.5	0.45	5	M24	24	3	36
M3	4	0.5	5.5	M27	27	3	41
M4	5	0.7	7	M30	30	3.5	46
M5	5	0.8	8	M33	33	3.5	50
M6	6	1	10	M36	36	4	55
M7	7.5	1	11	M39	39	4	60
M8	8	1.25	13	M42	42	4.5	65
M10	10	1.5	17	M45	45	4.5	70
M12	12	1.75	19	M48	48	5	75
M14	14	2	22	M52 (#DIN)	52	5	80
M16	16	2	24	M56 (#DIN)	56	5.5	85
M18	18.5	2.5	27	M60 (#DIN)	60	5.5	90
M20	20	2.5	30	M64 (#DIN)	64	6	95
M22	22	2.5	32				



Article groups

Thread	Driving features	Material	Class	Surface treatment	Code	Page
M	Hexagon	St	≥ 5	Zipl	12300	3-48
M	Hexagon	St	≥ 5	Zipl	12310	3-49
M	Hexagon	St	≥ 5	Zipl yell.p.	12302	3-49
M	Hexagon	St	6	FLZNNC-NC6	12307	3-49
M	Hexagon	St	8	Zipl	12348	3-49
M	Hexagon	St	8	Zipl yell.p.	12350	3-50
M	Hexagon	St	10	Zipl	12410	3-50
M	Hexagon	St	10	Zipl yell.p.	12450	3-50
M	Hexagon	St.St. A2			51730	3-50
M	Hexagon	St.St. A2		METALFORM	51729	3-50
M	Hexagon	St.St. A2		METALFORM	51728	3-51
M	Hexagon	St.St. A4			55730	3-51
M	Hexagon	Al Dural			45110	3-51



12300	Prevailing torque type hexagon nut with non-metallic insert	F06A
Thread	Metric thread	
Material	Steel	
Class	≥ 5	
Surface treatment	Zinc plated	



d	☒	Art.number	d	☒	Art.number	d	☒	Art.number
M2,5	250	12300.025.001	M5	250	12300.050.001	M8	250	12300.080.001
M3	250	12300.030.001	M6	250	12300.060.001	M10	200	12300.100.001
M4	250	12300.040.001	M7	250	12300.070.001	M12	100	12300.120.001

12300 Prevailing torque type hexagon nut with non-metallic insert								
d	☒	Art.number	d	☒	Art.number	d	☒	Art.number
M14		100 12300.140.001	M27		10 12300.270.001	M45		4 12300.450.001
M16		50 12300.160.001	M30		10 12300.300.001	M48		4 12300.480.001
M18		50 12300.180.001	M33		5 12300.330.001	M52		1 12300.520.001
M20		25 12300.200.001	M36		5 12300.360.001	M56		1 12300.560.001
M22		25 12300.220.001	M39		5 12300.390.001	M60		1 12300.600.001
M24		25 12300.240.001	M42		5 12300.420.001	M64		1 12300.640.001

12310 Prevailing torque type hexagon nut with non-metallic insert								F06A
Thread	Metric thread							
Material	Steel							
Class	≥ 5							
Surface treatment	Zinc plated							
								
d	☒	Art.number	d	☒	Art.number	d	☒	Art.number
M3		2500 12310.030.001	M6		2500 12310.060.001	M12		500 12310.120.001
M4		2500 12310.040.001	M8		2000 12310.080.001	M16		250 12310.160.001
M5		2500 12310.050.001	M10		750 12310.100.001			

12302 Prevailing torque type hexagon nut with non-metallic insert								F05A
Thread	Metric thread							
Material	Steel							
Class	≥ 5							
Surface treatment	Zinc plated yellow passivated							
d	☒	Art.number	d	☒	Art.number	d	☒	Art.number
M3		250 12302.030.001	M8		250 12302.080.001	M18		50 12302.180.001
M4		250 12302.040.001	M10		100 12302.100.001	M20		25 12302.200.001
M5		250 12302.050.001	M12		100 12302.120.001	M22		25 12302.220.001
M6		250 12302.060.001	M14		100 12302.140.001	M24		25 12302.240.001
M7		200 12302.070.001	M16		50 12302.160.001			

12307 Prevailing torque type hexagon nut with non-metallic insert								A96A
Thread	Metric thread							
Material	Steel							
Class	6							
Surface treatment	Zinc flake Cr ⁶⁺ free - ISO 10683 flZnnc							
								
d	☒	Art.number	d	☒	Art.number	d	☒	Art.number
M6		250 12307.060.001	M14		100 12307.140.001	M22		25 12307.220.001
M8		250 12307.080.001	M16		50 12307.160.001	M24		25 12307.240.001
M10		200 12307.100.001	M18		50 12307.180.001	M27		10 12307.270.001
M12		100 12307.120.001	M20		25 12307.200.001	M30		10 12307.300.001

12348 Prevailing torque type hexagon nut with non-metallic insert								F05A
Thread	Metric thread							
Material	Steel							
Class	8							
Surface treatment	Zinc plated							
								
d	☒	Art.number	d	☒	Art.number	d	☒	Art.number
M4		250 12348.040.001	M14		100 12348.140.001	M27		10 12348.270.001
M5		250 12348.050.001	M16		50 12348.160.001	M30		10 12348.300.001
M6		250 12348.060.001	M18		50 12348.180.001	M33		5 12348.330.001
M8		250 12348.080.001	M20		25 12348.200.001	M36		5 12348.360.001
M10		200 12348.100.001	M22		25 12348.220.001			
M12		100 12348.120.001	M24		25 12348.240.001			

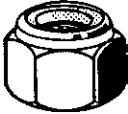
12350	Prevailing torque type hexagon nut with non-metallic insert		F05A
Thread	Metric thread		
Material	Steel		
Class	8		
Surface treatment	Zinc plated yellow passivated		

d	☒	Art.number	d	☒	Art.number	d	☒	Art.number
M6	250	12350.060.001	M14	100	12350.140.001	M24	25	12350.240.001
M8	250	12350.080.001	M16	50	12350.160.001	M27	10	12350.270.001
M10	200	12350.100.001	M20	25	12350.200.001	M30	10	12350.300.001
M12	100	12350.120.001						

12410	Prevailing torque type hexagon nut with non-metallic insert		F05A
Thread	Metric thread		
Material	Steel		
Class	10		
Surface treatment	Zinc plated		



d	☒	Art.number	d	☒	Art.number	d	☒	Art.number
M5	250	12410.050.001	M14	100	12410.140.001	M22	25	12410.220.001
M6	250	12410.060.001	M16	50	12410.160.001	M24	25	12410.240.001
M8	250	12410.080.001	M18	50	12410.180.001	M27	10	12410.270.001
M10	200	12410.100.001	M20	25	12410.200.001	M30	10	12410.300.001
M12	100	12410.120.001						

12450	Prevailing torque type hexagon nut with non-metallic insert		F05A
Thread	Metric thread		
Material	Steel		
Class	10		
Surface treatment	Zinc plated yellow passivated		

d	☒	Art.number	d	☒	Art.number	d	☒	Art.number
M6	250	12450.060.001	M14	100	12450.140.001	M24	25	12450.240.001
M8	250	12450.080.001	M16	50	12450.160.001	M27	10	12450.270.001
M10	200	12450.100.001	M20	25	12450.200.001	M30	10	12450.300.001
M12	100	12450.120.001						

51730	Prevailing torque type hexagon nut with non-metallic insert		R09A
Thread	Metric thread		
Material	Stainless steel A2		



d	☒	Art.number	d	☒	Art.number	d	☒	Art.number
M2,5	200	51730.025.001	M10	100	51730.100.001	M22	25	51730.220.001
M3	200	51730.030.001	M12	50	51730.120.001	M24	10	51730.240.001
M4	200	51730.040.001	M14	50	51730.140.001	M27	5	51730.270.001
M5	200	51730.050.001	M16	20	51730.160.001	M30	5	51730.300.001
M6	200	51730.060.001	M18	50	51730.180.001	M36	5	51730.360.001
M8	100	51730.080.001	M20	20	51730.200.001			

- Stainless steel prevailing torque type hexagon nuts with plastic insert can cause seizing of the bolt thread resulting in fracture.
- It is recommended to use METALFORM stainless steel prevailing torque type hexagon nuts with plastic insert (51729 and 51728) or Molykote P-37 (90710.000.500) or Loctite 8009 (90008.009.454) anti-seize and lubricating compound.

51729	Prevailing torque type hexagon nut with non-metallic insert, Metalform		R09A
Thread	Metric thread		
Material	Stainless steel A2		
Surface treatment	METALFORM		



d	☒	Art.number	d	☒	Art.number	d	☒	Art.number
M4	100	51729.040.001	M8	50	51729.080.001	M16	10	51729.160.001
M5	100	51729.050.001	M10	50	51729.100.001	M20	10	51729.200.001
M6	100	51729.060.001	M12	25	51729.120.001			

51729 Prevailing torque type hexagon nut with non-metallic insert, Metalform ←

- Special features of METALFORM:
- Is a dry partly visible lubricant which eliminates the possibility of seizure of threaded stainless steel fasteners.
- In addition the friction coefficient is reduced to a more constant value.
- In a bolt/nut combination its sufficient that only the nut is lubricated to prevent seizure with METALFORM.
- Can be removed very easily with a solvent after application, so theres no objection of using this application in the food industry

51728 Prevailing torque type hexagon nut with non-metallic insert, Metalform R09A

Thread Metric thread
Material Stainless steel A2
Surface treatment METALFORM

3

d	✉	Art.number	d	✉	Art.number	d	✉	Art.number
M6		1000 51728.060.001	M8		500 51728.080.001	M10		500 51728.100.001

- Special features of METALFORM:
- Is a dry partly visible lubricant which eliminates the possibility of seizure of threaded stainless steel fasteners.
- In addition the friction coefficient is reduced to a more constant value.
- In a bolt/nut combination its sufficient that only the nut is lubricated to prevent seizure with METALFORM.
- Can be removed very easily with a solvent after application, so theres no objection of using this application in the food industry

55730 Prevailing torque type hexagon nut with non-metallic insert R49A

Thread Metric thread
Material Stainless steel A4



d	✉	Art.number	d	✉	Art.number	d	✉	Art.number
M2,5*		500 55730.025.001	M10		100 55730.100.001	M22*		25 55730.220.001
M3		200 55730.030.001	M12		50 55730.120.001	M24		10 55730.240.001
M4		200 55730.040.001	M14		50 55730.140.001	M27		5 55730.270.001
M5		200 55730.050.001	M16		20 55730.160.001	M30		5 55730.300.001
M6		200 55730.060.001	M18		50 55730.180.001	M33		5 55730.330.001
M8		100 55730.080.001	M20		20 55730.200.001			

- Stainless steel prevailing torque type hexagon nuts with plastic insert can cause seizing of the bolt thread resulting in fracture.
- It is recommended to use METALFORM stainless steel prevailing torque type hexagon nuts with plastic insert (51729 and 51728) or Molykote P-37 (90710.000.500) or Loctite 8009 (90008.009.454) anti-seize and lubricating compound.

45110 Prevailing torque type hexagon nut with non-metallic insert W010

Thread Metric thread **DIN** ≈985 (1987)
Material Aluminium Dural **ISO** ≈7040
NF ≈E25-412

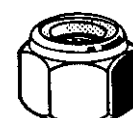

d	✉	Art.number	d	✉	Art.number	d	✉	Art.number
M3		200 45110.030.001	M6		200 45110.060.001	M12		50 45110.120.001
M4		200 45110.040.001	M8		100 45110.080.001	M16		20 45110.160.001
M5		200 45110.050.001	M10		100 45110.100.001			

Prevailing torque type hexagon nut with non-metallic insert MF

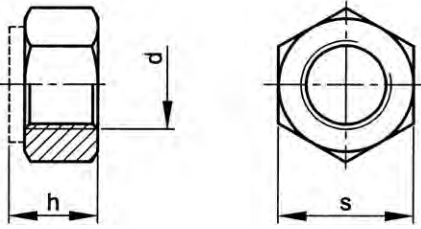

DIN 985 (1987)
ISO 10512
NF E25-412

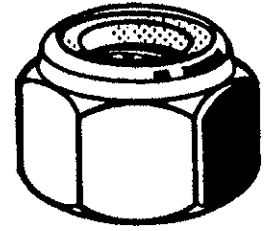

3

Technical Data

d	h	s	d	h	s
M8	8	13	M27	27	41
M10	10	17	M30	30	46
M12	12	19	M33	33	50
M14	14	22	M36	36	55
M16	16	24	M39	39	60
M18	18.5	27	M42	42	65
M20	20	30	M45	45	70
M22	22	32	M48	48	75
M24	24	36			

Article groups

Thread	Driving features	Material	Class	Surface treatment	Code	Page
MF	Hexagon	St	≥ 5	Zipl	12320	3-52
MF	Hexagon	St	8	Zipl yell.p.	12352	3-52
MF	Hexagon	St	10	Zipl yell.p.	12422	3-53
MF	Hexagon	St.St. A2		Gleitmo	51739	3-53
MF	Hexagon	St.St. A4		Gleitmo	55739	3-53

12320 Prevailing torque type hexagon nut with non-metallic insert MF

F05A

Thread Metric fine thread
Material Steel
Class ≥|5|
Surface treatment Zinc plated

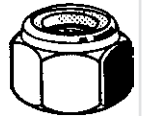

d x P	☒	Art.number	d x P	☒	Art.number	d x P	☒	Art.number
M8X1,00	250	12320.080.100	M20X2,00	25	12320.200.200	M33X2,00	5	12320.330.200
M10X1,00	200	12320.100.100	M22X1,50	25	12320.220.150	M36X1,50 (≠DIN)	5	12320.360.150
M10X1,25	200	12320.100.125	M24X1,50 (≠DIN)	25	12320.240.150	M36X3,00	5	12320.360.300
M12X1,00 (≠DIN)	100	12320.120.100	M24X2,00	25	12320.240.200	M39X3,00	5	12320.390.300
M12X1,25	100	12320.120.125	M27X1,50 (≠DIN)	10	12320.270.150	M42X1,50 (≠DIN)	5	12320.420.150
M12X1,50	100	12320.120.150	M27X2,00	10	12320.270.200	M42X3,00	5	12320.420.300
M14X1,50	100	12320.140.150	M30X1,50 (≠DIN)	10	12320.300.150	M45X3,00	4	12320.450.300
M16X1,50	50	12320.160.150	M30X2,00	10	12320.300.200	M48X1,50 (≠DIN)	4	12320.480.150
M18X1,50	50	12320.180.150	M33X1,50 (≠DIN)	5	12320.330.150	M48X3,00	4	12320.480.300
M20X1,50	25	12320.200.150						

12352 Prevailing torque type hexagon nut with non-metallic insert MF

F05A

Thread Metric fine thread
Material Steel
Class |8|
Surface treatment Zinc plated yellow passivated

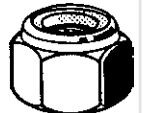

d x P	☒	Art.number	d x P	☒	Art.number	d x P	☒	Art.number
M10X1,00	200	12352.100.100	M12X1,50	100	12352.120.150	M20X1,50	25	12352.200.150
M10X1,25	200	12352.100.125	M14X1,50	100	12352.140.150	M24X2,00	25	12352.240.200
M12X1,25	100	12352.120.125	M16X1,50	50	12352.160.150			

12422 Prevailing torque type hexagon nut with non-metallic insert MF		F05A
Thread	Metric fine thread	
Material	Steel	
Class	10	
Surface treatment	Zinc plated yellow passivated	

d x P	Art.number	d x P	Art.number	d x P	Art.number
M8X1,00	250 12422.080.100	M14X1,50	100 12422.140.150	M20X1,50	25 12422.200.150
M10X1,00	200 12422.100.100	M16X1,50	50 12422.160.150	M24X1,50	25 12422.240.150
M12X1,50	100 12422.120.150	M18X1,50	50 12422.180.150		

51739 Prevailing torque type hexagon nut with non-metallic insert MF		R09A
Thread	Metric fine thread	
Material	Stainless steel A2	
Surface treatment	Gleitmo	



d x P	Art.number	d x P	Art.number	d x P	Art.number
M12X1,50*	200 51739.120.150	M14X1,50*	100 51739.140.150	M16X1,50*	100 51739.160.150

55739 Prevailing torque type hexagon nut with non-metallic insert MF		R49A
Thread	Metric fine thread	
Material	Stainless steel A4	
Surface treatment	Gleitmo	



d x P	Art.number	d x P	Art.number
M10X1,00*	200 55739.100.100	M14X1,50*	100 55739.140.150

Prevailing torque type hexagon nut with non-metallic insert high type

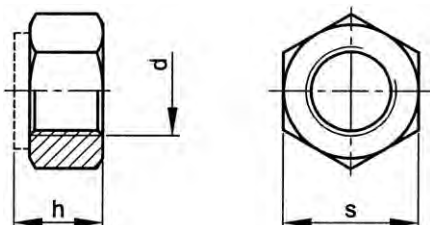

DIN 982
ISO ≈7040
NF ≈E25-409

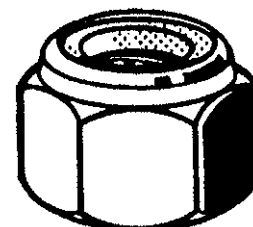

Technical Data

d	h	P	s	d	h	P	s
M4	4.7	0.7	7	M14	16	2	22
M5	6.3	0.8	8	M16	18	2	24
M6	8	1	10	M18	20	2.5	27
M8	9.5	1.25	13	M20	22	2.5	30
M10	11.5	1.5	17	M22	25	2.5	32
M12	14	1.75	19	M24	28	3	36

Article groups

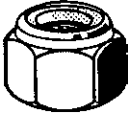

Thread	Driving features	Material	Class	Surface treatment	Code	Page
M	Hexagon	St	8	Zipl	12600	3-54
M	Hexagon	St	10	Zipl yell.p.	12662	3-54
M	Hexagon	St.St. A2			51718	3-54
M	Hexagon	St.St. A4			55718	3-54

12600	Prevailing torque type hexagon nut with non-metallic insert high type		F05A
Thread	Metric thread		 
Material	Steel		
Class	8		
Surface treatment	Zinc plated		

d	☒	Art.number	d	☒	Art.number	d	☒	Art.number
M5	250	12600.050.001	M12	100	12600.120.001	M20	25	12600.200.001
M6	250	12600.060.001	M14	100	12600.140.001	M22	25	12600.220.001
M8	250	12600.080.001	M16	50	12600.160.001	M24	25	12600.240.001
M10	200	12600.100.001	M18	50	12600.180.001			

12662	Prevailing torque type hexagon nut with non-metallic insert high type		F05A
Thread	Metric thread		
Material	Steel		
Class	10		
Surface treatment	Zinc plated yellow passivated		

d	☒	Art.number	d	☒	Art.number	d	☒	Art.number
M6	250	12662.060.001	M12	100	12662.120.001	M20	25	12662.200.001
M8	250	12662.080.001	M14	100	12662.140.001	M24	25	12662.240.001
M10	200	12662.100.001	M16	50	12662.160.001			

51718	Prevailing torque type hexagon nut with non-metallic insert high type		R09A
Thread	Metric thread		 
Material	Stainless steel A2		
	DIN ≈982		

d	☒	Art.number	d	☒	Art.number	d	☒	Art.number
M4	200	51718.040.001	M10	100	51718.100.001	M16*	50	51718.160.001
M5*	200	51718.050.001	M12	50	51718.120.001	M20*	25	51718.200.001
M6	200	51718.060.001	M14*	50	51718.140.001	M24*	10	51718.240.001
M8	200	51718.080.001						

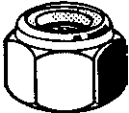
55718	Prevailing torque type hexagon nut with non-metallic insert high type		R49A
Thread	Metric thread		 
Material	Stainless steel A4		
	DIN ≈982		

d	☒	Art.number	d	☒	Art.number	d	☒	Art.number
M5	200	55718.050.001	M10	50	55718.100.001	M16	10	55718.160.001
M6	100	55718.060.001	M12	25	55718.120.001	M20	10	55718.200.001
M8	50	55718.080.001	M14	25	55718.140.001	M24	5	55718.240.001

- Stainless steel prevailing torque type hexagon nuts with plastic insert can cause seizing of the bolt thread resulting in fracture.
- It is recommended to use METALFORM stainless steel prevailing torque type hexagon nuts with plastic insert (51729 and 51728) or Molykote P-37 (90710.000.500) or Loctite 8009 (90008.009.454) anti-seize and lubricating compound.

Prevailing torque Lock nut with plastic insert, ASME B18.16.6, NE UNC

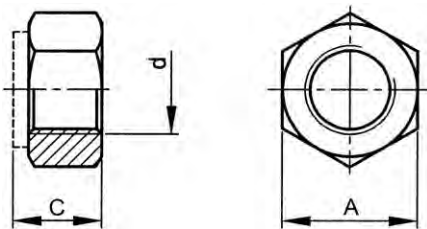

ASME B18.16.6

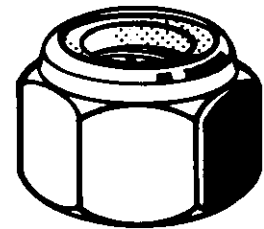

Technical Data

d	A	C	Threads per inch	d	A	C	Threads per inch
No.2	0.251	0.153	56	7/16	0.627	0.468	14
No.3	0.251	0.153	48	1/2	0.752	0.609	13
No.4	0.251	0.153	40	9/16	0.877	0.656	12
No.5	0.251	0.153	40	5/8	0.940	0.765	11
No.6	0.313	0.188	32	3/4	1.064	0.890	10
No.8	0.345	0.239	32	7/8	1.252	0.999	9
No.10	0.376	0.249	24	1 Inch	1.440	1.078	8
1/4	0.439	0.328	20	1.1/8	1.627	1.203	7
5/16	0.502	0.359	18	1.1/4	1.815	1.422	7
3/8	0.564	0.468	16	1.1/2	2.197	1.640	6

Article groups

Thread	Driving features	Material	Class	Surface treatment	Code	Page
UNC	Hexagon	St	Grade 2	Zipl	U12300	3-55
UNC	Hexagon	St	Grade 5	Zipl	U12348	3-55
UNC	Hexagon	St	Grade 8		U12411	3-56
UNC	Hexagon	St	Grade 8	Zipl yell.p.	U12450	3-56
UNC	Hexagon	St.St. A2 (AISI304/18-8)			U51738	3-56
UNC	Hexagon	St.St. A4 (AISI316/18-10)			U55730	3-56

U12300 Lock nut Nylon insert -NE

X09A

Thread	Unified National Coarse
Material	Steel
Class	Grade 2
Surface treatment	Zinc plated



d	Art.number	d	Art.number	d	Art.number
NO.2-56*	100 U12300.008.0001	1/4-20*	100 U12300.025.0001	3/4-10*	10 U12300.075.0001
NO.3-48*	100 U12300.009.0001	5/16-18*	100 U12300.031.0001	7/8-9*	5 U12300.087.0001
NO.4-40*	100 U12300.011.0001	3/8-16*	50 U12300.037.0001	1-8*	5 U12300.100.0001
NO.5-40*	100 U12300.012.0001	7/16-14*	25 U12300.043.0001	1.1/8-7*	5 U12300.112.0001
NO.6-32*	100 U12300.013.0001	1/2-13*	25 U12300.050.0001	1.1/4-7*	5 U12300.125.0001
NO.8-32*	100 U12300.016.0001	9/16-12*	25 U12300.056.0001	1.1/2-6*	5 U12300.150.0001
NO.10-24*	100 U12300.019.0001	5/8-11*	10 U12300.062.0001		

U12348 Lock nut Nylon insert -NE

X01A

Thread	Unified National Coarse
Material	Steel
Class	Grade 5
Surface treatment	Zinc plated



d	Art.number	d	Art.number	d	Art.number
1/4-20*	100 U12348.025.0001	1/2-13*	25 U12348.050.0001	3/4-10*	10 U12348.075.0001
5/16-18*	100 U12348.031.0001	9/16-12*	25 U12348.056.0001	7/8-9*	5 U12348.087.0001
3/8-16*	50 U12348.037.0001	5/8-11*	10 U12348.062.0001	1-8*	5 U12348.100.0001
7/16-14*	25 U12348.043.0001				

U12411	Lock nut Nylon insert -NE	X01A
Thread	Unified National Coarse	
Material	Steel	
Class	Grade 8	
		

d	☒	Art.number	d	☒	Art.number	d	☒	Art.number
1/4-20*	100	U12411.025.0001	9/16-12*	25	U12411.056.0001	1.-8*	5	U12411.100.0001
5/16-18*	100	U12411.031.0001	5/8-11*	10	U12411.062.0001	1.1/8-7*	5	U12411.112.0001
3/8-16*	50	U12411.037.0001	3/4-10*	10	U12411.075.0001	1.1/4-7*	5	U12411.125.0001
7/16-14*	25	U12411.043.0001	7/8-9*	5	U12411.087.0001	1.1/2-6*	5	U12411.150.0001
1/2-13*	25	U12411.050.0001						

U12450	Lock nut Nylon insert -NE	X01A
Thread	Unified National Coarse	
Material	Steel	
Class	Grade 8	
Surface treatment	Zinc plated yellow passivated	

d	☒	Art.number	d	☒	Art.number	d	☒	Art.number
1/4-20*	100	U12450.025.0001	9/16-12*	25	U12450.056.0001	1.-8*	5	U12450.100.0001
5/16-18*	100	U12450.031.0001	5/8-11*	10	U12450.062.0001	1.1/8-7*	5	U12450.112.0001
3/8-16*	50	U12450.037.0001	3/4-10*	10	U12450.075.0001	1.1/4-7*	5	U12450.125.0001
7/16-14*	25	U12450.043.0001	7/8-9*	5	U12450.087.0001	1.1/2-6*	5	U12450.150.0001
1/2-13*	25	U12450.050.0001						

U51738	Lock nut Nylon insert -NE	X15A
Thread	Unified National Coarse	
Material	Stainless steel A2 (AISI 304/18-8)	
		

d	☒	Art.number	d	☒	Art.number	d	☒	Art.number
NO.2-56*	50	U51738.008.0001	1/4-20*	50	U51738.025.0001	3/4-10*	5	U51738.075.0001
NO.3-48*	50	U51738.009.0001	5/16-18*	50	U51738.031.0001	7/8-9*	5	U51738.087.0001
NO.4-40*	50	U51738.011.0001	3/8-16*	50	U51738.037.0001	1.-8*	5	U51738.100.0001
NO.5-40*	50	U51738.012.0001	7/16-14*	25	U51738.043.0001	1.1/8-7*	2	U51738.112.0001
NO.6-32*	50	U51738.013.0001	1/2-13*	10	U51738.050.0001	1.1/4-7*	2	U51738.125.0001
NO.8-32*	50	U51738.016.0001	9/16-12*	10	U51738.056.0001	1.1/2-6*	2	U51738.150.0001
NO.10-24*	50	U51738.019.0001	5/8-11*	10	U51738.062.0001			

U55730	Lock nut Nylon insert -NE	X15A
Thread	Unified National Coarse	
Material	Stainless steel A4 (AISI 316/18-10)	
		

d	☒	Art.number	d	☒	Art.number	d	☒	Art.number
NO.4-40*	50	U55730.011.0001	5/16-18*	50	U55730.031.0001	5/8-11*	10	U55730.062.0001
NO.6-32*	50	U55730.013.0001	3/8-16*	50	U55730.037.0001	3/4-10*	5	U55730.075.0001
NO.8-32*	50	U55730.016.0001	7/16-14*	25	U55730.043.0001	7/8-9*	5	U55730.087.0001
NO.10-24*	50	U55730.019.0001	1/2-13*	10	U55730.050.0001	1.-8*	5	U55730.100.0001
1/4-20*	50	U55730.025.0001	9/16-12*	10	U55730.056.0001			

Prevailing torque Lock nut with plastic insert, ASME B18.16.6, NTE UNC

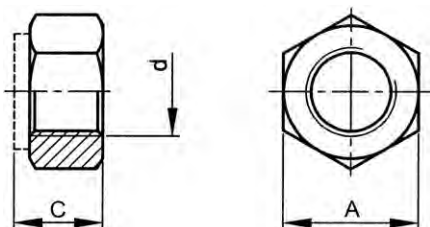

ASME B18.16.6

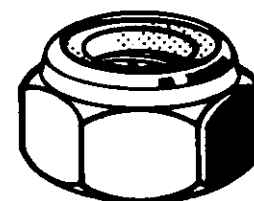

Technical Data

d	A	C	Threads per inch
No.4	0.251	0.124	40
No.5	0.251	0.124	40
No.6	0.313	0.140	32
No.8	0.345	0.187	32
No.10	0.376	0.187	24
1/4	0.439	0.218	20
5/16	0.502	0.265	18
3/8	0.564	0.281	16
7/16	0.627	0.328	14
1/2	0.752	0.328	13
9/16	0.877	0.374	12
5/8	0.940	0.406	11
3/4	1.064	0.421	10
7/8	1.252	0.484	9
1 Inch	1.44	0.578	8

Article groups

Thread	Driving features	Material	Class	Surface treatment	Code	Page
UNC	Hexagon	St	Grade 2	Zipl	U12423	3-57
UNC	Hexagon	St.St. A2 (AISI304/18-8)			U51730	3-57

U12423 Jam Lock nut Nylon insert -NTE

X01A

Thread	Unified National Coarse
Material	Steel
Class	Grade 2
Surface treatment	Zinc plated



d	Art.number	d	Art.number	d	Art.number
NO.4-40*	100 U12423.011.0001	1/4-20*	100 U12423.025.0001	9/16-12*	25 U12423.056.0001
NO.5-40*	100 U12423.012.0001	5/16-18*	100 U12423.031.0001	5/8-11*	10 U12423.062.0001
NO.6-32*	100 U12423.013.0001	3/8-16*	50 U12423.037.0001	3/4-10*	10 U12423.075.0001
NO.8-32*	100 U12423.016.0001	7/16-14*	25 U12423.043.0001	7/8-9*	5 U12423.087.0001
NO.10-24*	100 U12423.019.0001	1/2-13*	25 U12423.050.0001	1-8*	5 U12423.100.0001

U51730 Jam Lock nut Nylon insert -NTE

X15A

Thread	Unified National Coarse
Material	Stainless steel A2 (AISI 304/18-8)



d	Art.number	d	Art.number	d	Art.number
NO.4-40*	50 U51730.011.0001	1/4-20*	50 U51730.025.0001	5/8-11*	10 U51730.062.0001
NO.5-40*	50 U51730.012.0001	5/16-18*	50 U51730.031.0001	3/4-10*	5 U51730.075.0001
NO.6-32*	50 U51730.013.0001	3/8-16*	50 U51730.037.0001	7/8-9*	5 U51730.087.0001
NO.8-32*	50 U51730.016.0001	7/16-14*	25 U51730.043.0001	1-8*	5 U51730.100.0001
NO.10-24*	50 U51730.019.0001	1/2-13*	10 U51730.050.0001		

Prevailing torque nut with plastic insert, ASME B18.16.6, NTE UNF

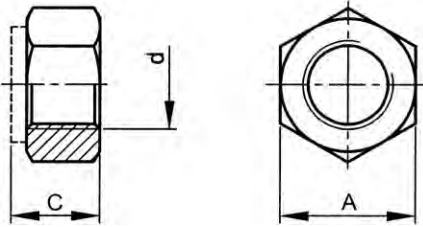

ASME B18.16.6

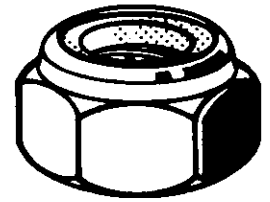

3

Technical Data

d	A	C	Threads per inch
No.10	0.187	0.376	32
1/4	0.218	0.439	28
5/16	0.265	0.502	24
3/8	0.281	0.564	24
7/16	0.328	0.627	20
1/2	0.328	0.752	20
9/16	0.374	0.877	18
5/8	0.406	0.94	18
3/4	0.421	1.064	16
7/8	0.484	1.252	14
1 Inch	0.578	1.440	14
1.1/8	0.672	1.627	12
1.1/4	0.765	1.815	12
1.1/2	0.828	2.197	12

Article groups

Thread	Driving features	Material	Class	Surface treatment	Code	Page
UNF	Hexagon	St	Grade 2	Zipl	U12380	3-58
UNF	Hexagon	St	Grade 8	Zipl	U12381	3-58
UNF	Hexagon	St.St. A2 (AISI304/18-8)			U51422	3-59

U12380 Jam Lock nut Nylon insert -NTE

X01A

Thread	Unified National Fine
Material	Steel
Class	Grade 2
Surface treatment	Zinc plated



d	⊗	Art.number	d	⊗	Art.number	d	⊗	Art.number
NO.10-32*	100	U12380.019.0002	1/2-20*	25	U12380.050.0002	1.-14*	5	U12380.101.0002
1/4-28*	100	U12380.025.0002	9/16-18*	25	U12380.056.0002	1.1/8-12*	5	U12380.112.0002
5/16-24*	100	U12380.031.0002	5/8-18*	10	U12380.062.0002	1.1/4-12*	5	U12380.125.0002
3/8-24*	50	U12380.037.0002	3/4-16*	10	U12380.075.0002	1.1/2-12*	5	U12380.150.0002
7/16-20*	25	U12380.043.0002	7/8-14*	5	U12380.087.0002			

U12381 Jam Lock nut Nylon insert -NTE

X01A

Thread	Unified National Fine
Material	Steel
Class	Grade 8
Surface treatment	Zinc plated



d	⊗	Art.number	d	⊗	Art.number	d	⊗	Art.number
1/4-28*	100	U12381.025.0002	3/4-16*	10	U12381.075.0002	1.1/8-12*	5	U12381.112.0002
5/16-24*	100	U12381.031.0002	7/8-14*	5	U12381.087.0002	1.1/4-12*	5	U12381.125.0002
1/2-20*	25	U12381.050.0002	1.-14*	5	U12381.101.0002	1.1/2-12*	5	U12381.150.0002
5/8-18*	10	U12381.062.0002						

U51422	Jam Lock nut Nylon insert -NTE	X15A
Thread	Unified National Fine	
Material	Stainless steel A2 (AISI 304/18-8)	
		

d	☒	Art.number	d	☒	Art.number	d	☒	Art.number
NO.10-32*	50	U51422.019.0002	7/16-20*	25	U51422.043.0002	3/4-16*	5	U51422.075.0002
1/4-28*	50	U51422.025.0002	1/2-20*	10	U51422.050.0002	7/8-14*	5	U51422.087.0002
5/16-24*	50	U51422.031.0002	5/8-18*	10	U51422.062.0002	1.-14*	5	U51422.101.0002
3/8-24*	50	U51422.037.0002						

Prevailing torque Lock nut with plastic insert, ASME B18.16.6, NU UNC

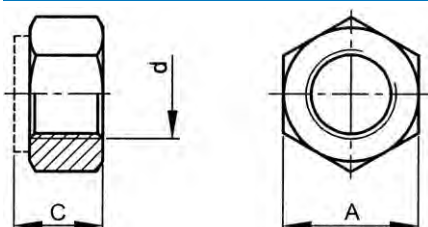

ASME B18.16.6

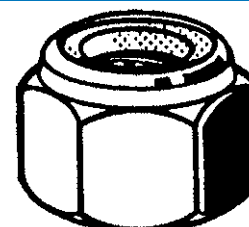

Technical Data			
d	A	C	Threads per inch
1/4	0.506	0.39	20
5/16	0.566	0.453	18
3/8	0.691	0.562	16
7/16	0.754	0.609	14
1/2	0.879	0.718	13
9/16	0.942	0.812	12
5/8	1.067	0.874	11
3/4	1.255	1.015	10
7/8	1.444	1.14	9
1 Inch	1.632	1.312	8
1.1/8	1.82	1.469	7
1.1/4	2.008	1.672	7
1.1/2	2.384	1.953	6

Article groups						
Thread	Driving features	Material	Class	Surface treatment	Code	Page
UNC	Hexagon	St	Grade 2	Zipl	U12601	3-59
UNC	Hexagon	St.St. A2 (AISI304/18-8)			U51718	3-60

U12601	Heavy Lock nut Nylon insert -NU	X01A
Thread	Unified National Coarse	
Material	Steel	
Class	Grade 2	
Surface treatment	Zinc plated	
		

d	☒	Art.number	d	☒	Art.number	d	☒	Art.number
1/4-20*	100	U12601.025.0001	9/16-12*	25	U12601.056.0001	1.-8*	5	U12601.100.0001
5/16-18*	100	U12601.031.0001	5/8-11*	10	U12601.062.0001	1.1/8-7*	5	U12601.112.0001
3/8-16*	50	U12601.037.0001	3/4-10*	10	U12601.075.0001	1.1/4-7*	5	U12601.125.0001
7/16-14*	25	U12601.043.0001	7/8-9*	5	U12601.087.0001	1.1/2-6*	5	U12601.150.0001
1/2-13*	25	U12601.050.0001						

U51718	Heavy Lock nut Nylon insert -NU-	X15A
Thread	Unified National Coarse	
Material	Stainless steel A2 (AISI 304/18-8)	
		

d	☒	Art.number	d	☒	Art.number	d	☒	Art.number
1/4-20*	50	U51718.025.0001	5/8-11*	10	U51718.062.0001	1.1/8-7*	5	U51718.112.0001
5/16-18*	50	U51718.031.0001	3/4-10*	5	U51718.075.0001	1.1/4-7*	5	U51718.125.0001
3/8-16*	50	U51718.037.0001	7/8-9*	5	U51718.087.0001	1.1/2-6*	2	U51718.150.0001
1/2-13*	10	U51718.050.0001	1.-8*	5	U51718.100.0001			

3

Prevailing torque Lock nut with plastic insert, ASME B18.16.6, NTU UNC

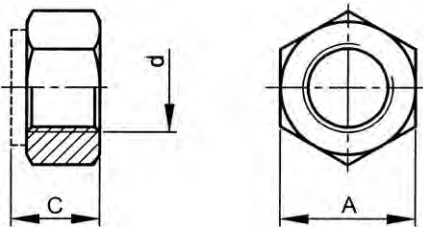

ASME B18.16.6

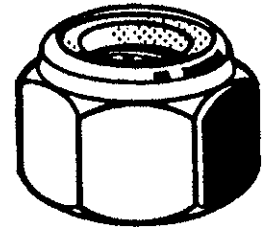

Technical Data			
d	A	C	Threads per inch
1/4	0.502	0.296	20
5/16	0.564	0.328	18
3/8	0.690	0.421	16
7/16	0.752	0.453	14
1/2	0.877	0.546	13
9/16	0.940	0.578	12
5/8	1.064	0.624	11
3/4	1.252	0.718	10
7/8	1.440	0.796	9
1 Inch	1.627	0.922	8
1.1/8	1.814	1.000	7
1.1/4	2.008	1.14	7
1.1/2	2.384	1.344	6

Article groups						
Thread	Driving features	Material	Class	Surface treatment	Code	Page
UNC	Hexagon	St	Grade 2	Zipl	U12705	3-60
UNC	Hexagon	St.St. A2 (AISI304/18-8)			U51705	3-61

U12705	Heavy Jam Lock nut Nylon insert -NTU	X01A
Thread	Unified National Coarse	
Material	Steel	
Class	Grade 2	
Surface treatment	Zinc plated	
		

d	☒	Art.number	d	☒	Art.number	d	☒	Art.number
1/4-20*	100	U12705.025.0001	9/16-12*	25	U12705.056.0001	1.-8*	5	U12705.100.0001
5/16-18*	100	U12705.031.0001	5/8-11*	10	U12705.062.0001	1.1/8-7*	5	U12705.112.0001
3/8-16*	50	U12705.037.0001	3/4-10*	10	U12705.075.0001	1.1/4-7*	5	U12705.125.0001
7/16-14*	25	U12705.043.0001	7/8-9*	5	U12705.087.0001	1.1/2-6*	5	U12705.150.0001
1/2-13*	25	U12705.050.0001						

U51705	Heavy Jam Lock nut Nylon insert -NTU	X15A
Thread	Unified National Coarse	
Material	Stainless steel A2 (AISI 304/18-8)	
		

d	☒	Art.number	d	☒	Art.number	d	☒	Art.number
1/4-20*	50	U51705.025.0001	7/16-14*	25	U51705.043.0001	3/4-10*	5	U51705.075.0001
5/16-18*	50	U51705.031.0001	1/2-13*	10	U51705.050.0001	7/8-9*	5	U51705.087.0001
3/8-16*	50	U51705.037.0001	5/8-11*	10	U51705.062.0001	1-8*	5	U51705.100.0001

3

Prevailing torque Lock nut with plastic insert, ASME B18.16.6, NE UNF

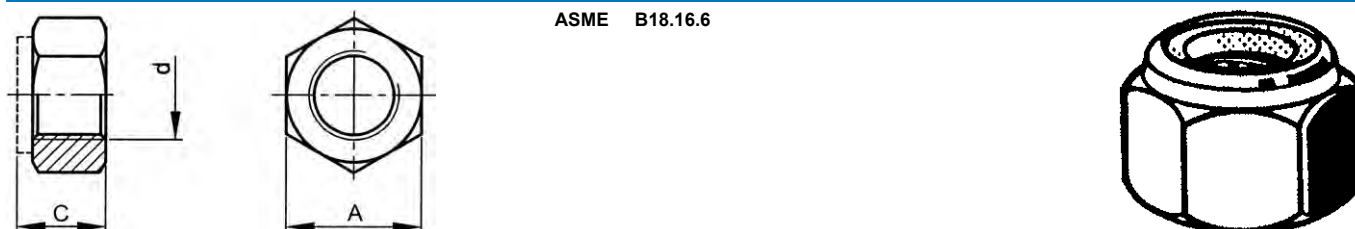

Technical Data

d	A	C	Threads per inch	d	A	C	Threads per inch
No.10	0.376	0.249	32	3/4	1.064	0.890	16
1/4	0.439	0.328	28	7/8	1.252	0.999	14
5/16	0.502	0.359	24	1 Inch-12G	1.440	1.078	12
3/8	0.564	0.468	24	1 Inch-14G	1.440	1.078	14
7/16	0.627	0.468	20	1.1/8	1.627	1.203	12
1/2	0.752	0.609	20	1.1/4	1.815	1.422	12
9/16	0.877	0.656	18	1.1/2	2.197	1.640	12
5/8	0.940	0.765	18				



- Depending on availability the dimensions may deviate.
- If when ordering, UNF 1 inch-12 is not stated, then we supply the type with 14 threads per inch (UNS).

Article groups

Thread	Driving features	Material	Class	Surface treatment	Code	Page
UNF	Hexagon	St	Grade 2	Zipl	U12320	3-61
UNF	Hexagon	St	Grade 5	Zipl	U12353	3-62
UNF	Hexagon	St	Grade 8		U12421	3-62
UNF	Hexagon	St	Grade 8	Zipl yell.p.	U12422	3-62
UNF	Hexagon	St.St. A2 (AISI304/18-8)			U51411	3-62
UNF	Hexagon	St.St. A4 (AISI316/18-10)			U55411	3-62

U12320	Lock nut Nylon insert -NE	X09A
Thread	Unified National Fine	
Material	Steel	
Class	Grade 2	
Surface treatment	Zinc plated	

d	☒	Art.number	d	☒	Art.number	d	☒	Art.number
NO.10-32*	100	U12320.019.0002	1/2-20*	25	U12320.050.0002	1-14*	5	U12320.101.0002
1/4-28*	100	U12320.025.0002	9/16-18*	25	U12320.056.0002	1.1/8-12*	5	U12320.112.0002
5/16-24*	100	U12320.031.0002	5/8-18*	10	U12320.062.0002	1.1/4-12*	5	U12320.125.0002
3/8-24*	50	U12320.037.0002	3/4-16*	10	U12320.075.0002	1.1/2-12*	5	U12320.150.0002
7/16-20*	25	U12320.043.0002	7/8-14*	5	U12320.087.0002			

U12353	Lock nut Nylon insert -NE				X01A
Thread	Unified National Fine				
Material	Steel				
Class	Grade 5				
Surface treatment	Zinc plated				
					



d	☒	Art.number	d	☒	Art.number	d	☒	Art.number
1/4-28*	100	U12353.025.0002	7/16-20*	25	U12353.043.0002	5/8-18*	10	U12353.062.0002
5/16-24*	100	U12353.031.0002	1/2-20*	25	U12353.050.0002	3/4-16*	10	U12353.075.0002
3/8-24*	50	U12353.037.0002						

U12421	Lock nut Nylon insert -NE				X01A
Thread	Unified National Fine				
Material	Steel				
Class	Grade 8				
Surface treatment					
					

d	☒	Art.number	d	☒	Art.number	d	☒	Art.number
1/4-28*	100	U12421.025.0002	9/16-18*	25	U12421.056.0002	1.-14*	5	U12421.101.0002
5/16-24*	100	U12421.031.0002	5/8-18*	10	U12421.062.0002	1.1/8-12*	5	U12421.112.0002
3/8-24*	50	U12421.037.0002	3/4-16*	10	U12421.075.0002	1.1/4-12*	5	U12421.125.0002
7/16-20*	25	U12421.043.0002	7/8-14*	5	U12421.087.0002	1.1/2-12*	5	U12421.150.0002
1/2-20*	25	U12421.050.0002						

U12422	Lock nut Nylon insert -NE				X01A
Thread	Unified National Fine				
Material	Steel				
Class	Grade 8				
Surface treatment	Zinc plated yellow passivated				
					

d	☒	Art.number	d	☒	Art.number	d	☒	Art.number
1/4-28*	100	U12422.025.0002	9/16-18*	25	U12422.056.0002	1.-14*	5	U12422.101.0002
5/16-24*	100	U12422.031.0002	5/8-18*	10	U12422.062.0002	1.1/8-12*	5	U12422.112.0002
3/8-24*	50	U12422.037.0002	3/4-16*	10	U12422.075.0002	1.1/4-12*	5	U12422.125.0002
7/16-20*	25	U12422.043.0002	7/8-14*	5	U12422.087.0002	1.1/2-12*	5	U12422.150.0002
1/2-20*	25	U12422.050.0002						

U51411	Lock nut Nylon insert -NE				X15A
Thread	Unified National Fine				
Material	Stainless steel A2 (AISI 304/18-8)				
Class					
Surface treatment					
					

d	☒	Art.number	d	☒	Art.number	d	☒	Art.number
NO.10-32*	50	U51411.019.0002	7/16-20*	25	U51411.043.0002	3/4-16*	5	U51411.075.0002
1/4-28*	50	U51411.025.0002	1/2-20*	10	U51411.050.0002	7/8-14*	5	U51411.087.0002
5/16-24*	50	U51411.031.0002	9/16-18*	10	U51411.056.0002	1.-14*	5	U51411.101.0002
3/8-24*	50	U51411.037.0002	5/8-18*	10	U51411.062.0002			

U55411	Lock nut Nylon insert -NE				X15A
Thread	Unified National Fine				
Material	Stainless steel A4 (AISI 316/18-10)				
Class					
Surface treatment					
					

d	☒	Art.number	d	☒	Art.number	d	☒	Art.number
NO.10-32*	50	U55411.019.0002	7/16-20*	25	U55411.043.0002	3/4-16*	5	U55411.075.0002
1/4-28*	50	U55411.025.0002	1/2-20*	10	U55411.050.0002	7/8-14*	5	U55411.087.0002
5/16-24*	50	U55411.031.0002	9/16-18*	10	U55411.056.0002	1.-14*	5	U55411.101.0002
3/8-24*	50	U55411.037.0002	5/8-18*	10	U55411.062.0002			

Prevailing torque type hexagon nut with non-metallic insert BSW

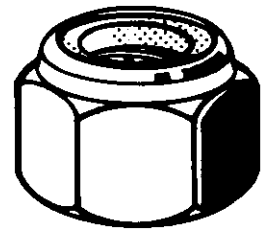
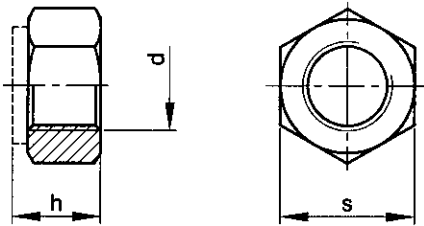

Technical Data

d	h	s	Threads per inch	d	h	s	Threads per inch
1/4	8.3	7/16	20	5/8	19.4	15/16	11
5/16	9.1	1/2	18	3/4	22.6	1.1/8	10
3/8	11.9	9/16	16	7/8	25.3	1.5/16	9
1/2	15.5	3/4	12	1 Inch	27.6	1.1/2	8

- These prevailing torque type hexagon nuts are not standardised. Depending on availability the dimensions may deviate.
- Whitworth thread (BSW/BSF) is not internationally recommended. It is advised to use metric (M/MF) or unified threads (UNC/UNF).

12340 Prevailing torque type hexagon nut with non-metallic insert BSW

X08A

Thread	British Standard Whitworth
Material	Steel
Class	6
Surface treatment	Zinc plated

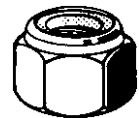

d	☒	Art.number	d	☒	Art.number	d	☒	Art.number
1/4	100	12340.063.001	1/2	50	12340.127.001	7/8	10	12340.222.001
5/16	100	12340.079.001	5/8	25	12340.158.001	1 Inch	10	12340.254.001
3/8	100	12340.096.001	3/4	25	12340.191.001			

Prevailing torque type hexagon nut with non-metallic insert BSF

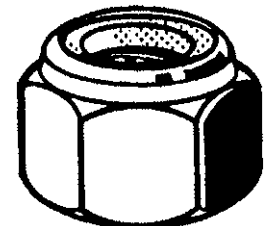
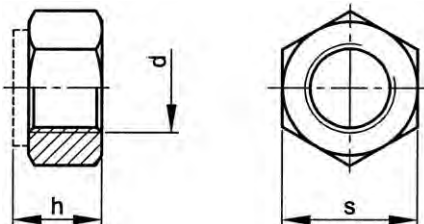

Technical Data

d	h	s	Threads per inch	d	h	s	Threads per inch
1/4	8.3	7/16	26	1/2	15.5	3/4	16
5/16	9.1	1/2	22	9/16	16.7	7/8	16
3/8	11.9	9/16	20	5/8	19.4	15/16	14
7/16	11.9	11/16	18	3/4	22.6	1.1/8	12

- These prevailing torque type hexagon nuts are not standardised. Depending on availability the dimensions may deviate.
- Whitworth thread (BSW/BSF) is not internationally recommended. It is advised to use metric (M/MF) or unified threads (UNC/UNF).

12400 Prevailing torque type hexagon nut with non-metallic insert BSF

X90A

Thread	British Standard Fine
Material	Steel
Class	6
Surface treatment	Zinc plated

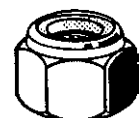

d	☒	Art.number	d	☒	Art.number	d	☒	Art.number
1/4	100	12400.063.001	7/16	100	12400.111.001	5/8	25	12400.158.001
5/16	100	12400.079.001	1/2	50	12400.127.001	3/4	25	12400.191.001
3/8	100	12400.096.001	9/16	50	12400.142.001			

Prevailing torque type hexagon nut all Stainless steel

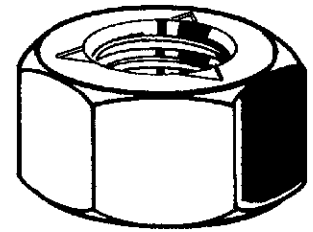
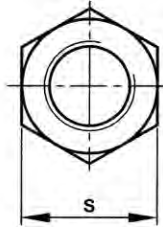
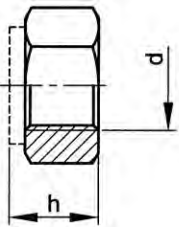

3

Technical Data

d	h	P	s	d	h	P	s
M3	2.4	0.5	5.5	M12	10	1.75	19
M4	3.2	0.7	7	M14	11	2	22
M5	4	0.8	8	M16	13	2	24
M6	5	1	10	M20	16	2.5	30
M7	5.5	1	11	M24	19	3	36
M8	6.5	1.25	13	M18	15	2.5	27
M10	8	1.5	17	M22	18	2.5	32

- The locking is achieved by local radial deformation of the screwthread.

Article groups

Thread	Driving features	Material	Class	Code	Page
M	Hexagon	St.St. A2	70	51720	3-64
M	Hexagon	St.St. A4	80	55720	3-64

51720 Prevailing torque type hexagon nut all Stainless steel

R09A

Thread Metric thread
Material Stainless steel A2
Class 70

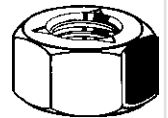

d	☒	Art.number	d	☒	Art.number	d	☒	Art.number
M3	100	51720.030.001	M8	50	51720.080.001	M18*	50	51720.180.001
M4	100	51720.040.001	M10	50	51720.100.001	M20	10	51720.200.001
M5	100	51720.050.001	M12	25	51720.120.001	M22*	25	51720.220.001
M6	100	51720.060.001	M14	25	51720.140.001	M24	5	51720.240.001
M7*	200	51720.070.001	M16	10	51720.160.001			

55720 Prevailing torque type hexagon nut all Stainless steel

R49A

Thread Metric thread
Material Stainless steel A4
Class 80

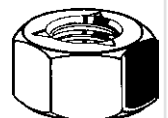

d	☒	Art.number	d	☒	Art.number	d	☒	Art.number
M3*	200	55720.030.001	M8*	200	55720.080.001	M16*	50	55720.160.001
M4*	200	55720.040.001	M10*	100	55720.100.001	M20*	50	55720.200.001
M5*	200	55720.050.001	M12*	100	55720.120.001	M24*	10	55720.240.001
M6*	200	55720.060.001	M14*	50	55720.140.001			

Prevailing torque type hexagon nut plastic

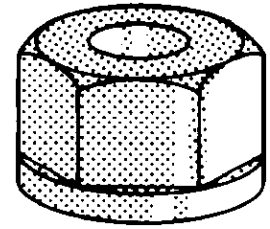
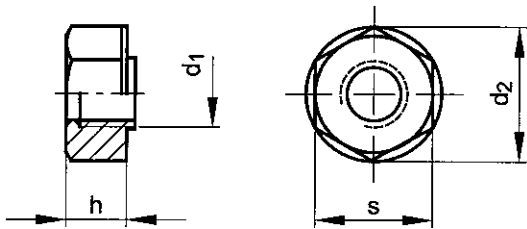

Technical Data

d ₁	d ₂	h	P	s	d ₁	d ₂	h	P	s
M4	9.3	6.4	0.7	7	M6	11.4	8	1	10
M5	10.5	7.3	0.8	9	M8	16.2	10.3	1.25	14

56220 Prevailing torque type hexagon nut plastic

W02A

Thread Metric thread
Material Plastic Polyamide (nylon)
Class PA 6.6
Color White

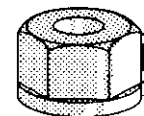

d ₁	☒	Art.number	d ₁	☒	Art.number	d ₁	☒	Art.number
M4		100 56220.040.001	M6		100 56220.060.001	M8		50 56220.080.001
M5		100 56220.050.001						

Prevailing torque type hexagon nut all metal

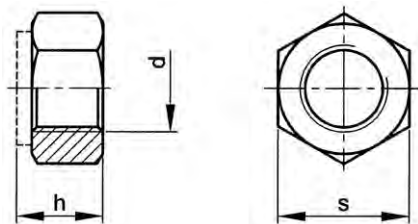

DIN 980V(1987)
ISO 7042
NEN 2452
NF E25-410
BS 4929-1

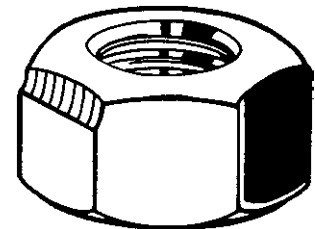

Technical Data

d	h (max.)	P	s	d	h (max.)	P	s
M5	5.1	0.8	8	M18	18	2.5	27
M6	6	1	10	M20	20	2.5	30
M8	8	1.25	13	M22	22	2.5	32
M10	10	1.5	17	M24	24	3	36
M12	12	1.75	19	M27	27	3	41
M14	14	2	22	M30	30	3.5	46
M16	16	2	24	M36	36	4	55

Article groups

Thread	Driving features	Material	Class	Surface treatment	Code	Page
M	Hexagon	St	8	Zipl	12858	3-65
M	Hexagon	St	8	Zipl yell.p.	12880	3-66
M	Hexagon	St	10	Zipl	12910	3-66

12858 STOVER Prevailing torque type hexagon nut all metal

F01J

Thread Metric thread
Material Steel
Class 8
Surface treatment Zinc plated

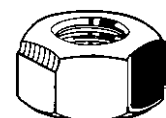

d	☒	Art.number	d	☒	Art.number	d	☒	Art.number
M5		250 12858.050.001	M14		100 12858.140.001	M24		25 12858.240.001
M6		250 12858.060.001	M16		50 12858.160.001	M27		25 12858.270.001
M8		250 12858.080.001	M18		25 12858.180.001	M30		25 12858.300.001
M10		200 12858.100.001	M20		25 12858.200.001	M36		10 12858.360.001
M12		100 12858.120.001	M22		25 12858.220.001			

12858 STOVER Prevailing torque type hexagon nut all metal

Special features of type STOVER prevailing torque type hexagon nuts:

- Is a one piece all metal class I8I nut, acc. to DIN 980 V.
- The locking is achieved by local radial deformation of a part of the nut. First the nut runs freely on the thread until the locking part is reached, after which the clamping force increases gradually to a maximum. This progressive locking action with distributed pressure over a large surface prevents damage of the thread.
- Resistant to shocks, vibrations and dynamic loads.
- Re-usable.

12880 STOVER Prevailing torque type hexagon nut all metal
F01J

Thread	Metric thread
Material	Steel
Class	8
Surface treatment	Zinc plated yellow passivated

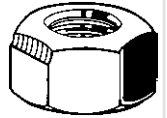

d	✉	Art.number	d	✉	Art.number	d	✉	Art.number
M6	4000	12880.060.001	M10	750	12880.100.001	M14	250	12880.140.001
M8	2000	12880.080.001	M12	500	12880.120.001	M16	100	12880.160.001

Special features of type STOVER prevailing torque type hexagon nuts:

- Is a one piece all metal class I8I nut, acc. to DIN 980 V.
- The locking is achieved by local radial deformation of a part of the nut. First the nut runs freely on the thread until the locking part is reached, after which the clamping force increases gradually to a maximum. This progressive locking action with distributed pressure over a large surface prevents damage of the thread.
- Resistant to shocks, vibrations and dynamic loads.
- Re-usable.

12910 Prevailing torque type hexagon nut all metal
F01J

Thread	Metric thread
Material	Steel
Class	10
Surface treatment	Zinc plated

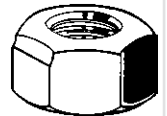

d	✉	Art.number	d	✉	Art.number	d	✉	Art.number
M6	250	12910.060.001	M14	100	12910.140.001	M22	50	12910.220.001
M8	250	12910.080.001	M16	50	12910.160.001	M24	50	12910.240.001
M10	200	12910.100.001	M18	50	12910.180.001	M30	25	12910.300.001
M12	100	12910.120.001	M20	50	12910.200.001			

Special features of prevailing torque type hexagon nuts:

- Is a one piece all metal class 10 nut, acc. to DIN 980 V.
- The locking is achieved by local radial deformation of a part of the nut. First the nut runs freely on the thread until the locking part is reached, after which the clamping force increases gradually to a maximum. This progressive locking action with distributed pressure over a large surface prevents damage of the thread.
- Resistant to shocks, vibrations and dynamic loads.
- Re-usable.

Prevailing torque type hexagon nut all metal MF

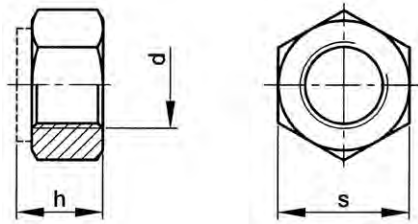

DIN 980V(1987)
ISO 10513
NEN 2452
NF E25-410

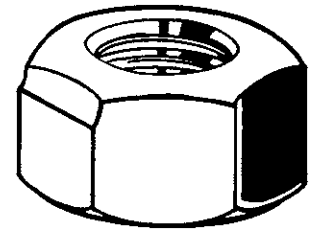

Technical Data

d	h (max.)	s	d	h (max.)	s
M8	8	13	M16	16	24
M10	10	17	M18	18	27
M12	12	19	M20	20	30
M14	14	22	M24	24	36

12912 Prevailing torque type hexagon nut all metal MF

F01J

Thread Metric fine thread
Material Steel
Class |8|
Surface treatment Zinc plated

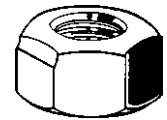

d x P	☒	Art.number	d x P	☒	Art.number	d x P	☒	Art.number
M8X1,00	250	12912.080.100	M12X1,50	200	12912.120.150	M20X1,50	50	12912.200.150
M10X1,00	250	12912.100.100	M14X1,50	200	12912.140.150	M24X1,50	50	12912.240.150
M10X1,25	250	12912.100.125	M16X1,50	100	12912.160.150	M24X2,00	50	12912.240.200
M12X1,25	200	12912.120.125	M18X1,50	100	12912.180.150			

- Special features of prevailing torque type hexagon nuts:
- Is a one piece all metal class |8| nut, acc. to DIN 980 V.
- The locking is achieved by local radial deformation of a part of the nut. First the nut runs freely on the thread until the locking part is reached, after which the clamping force increases gradually to a maximum. This progressive locking action with distributed pressure over a large surface prevents damage of the thread.
- Resistant to shocks, vibrations and dynamic loads.
- Re-usable.

Prevailing torque nuts, all metal IFI-100/107 Toplock UNC

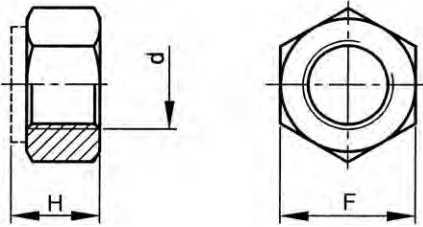

IFI 100/107

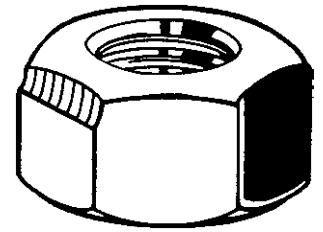

3

Technical Data

d	F	H	Threads per inch
No.8	11/32	0.171	32
1/4	7/16	0.288	20
5/16	1/2	0.336	18
3/8	9/16	0.415	16
7/16	11/16	0.463	14
1/2	3/4	0.573	13
9/16	7/8	0.621	12
5/8	15/16	0.731	11
3/4	1.1/8	0.827	10
7/8	1.5/16	0.922	9
1 Inch	1.1/2	1.018	8
1.1/8	1.11/16	1.176	7
1.1/4	1.7/8	1.272	7
1.1/2	2.1/4	1.526	6

Article groups

Thread	Driving features	Material	Class	Surface treatment	Code	Page
UNC	Hexagon	St	Grade 8	Zipl	U12910	3-68
UNC	Hexagon	St	Grade 8	Zipl yell.p.	U12920	3-68
UNC	Hexagon	St.St. A2 (AISI304/18-8)			U51915	3-69
UNC	Hexagon	St.St. A4 (AISI316/18-10)			U55915	3-69

U12910 Lock nut all metal conical Toplock (IFI-100/107)

X01A

Thread	Unified National Coarse
Material	Steel
Class	Grade 8
Surface treatment	Zinc plated

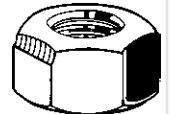

d	☒	Art.number	d	☒	Art.number	d	☒	Art.number
1/4-20*	100	U12910.025.0001	9/16-12*	25	U12910.056.0001	1.-8*	5	U12910.100.0001
5/16-18*	100	U12910.031.0001	5/8-11*	10	U12910.062.0001	1.1/8-7*	5	U12910.112.0001
3/8-16*	50	U12910.037.0001	3/4-10*	10	U12910.075.0001	1.1/4-7*	5	U12910.125.0001
7/16-14*	25	U12910.043.0001	7/8-9*	5	U12910.087.0001	1.1/2-6*	5	U12910.150.0001
1/2-13*	25	U12910.050.0001						

U12920 Lock nut all metal conical Toplock (IFI-100/107)

X01A

Thread	Unified National Coarse
Material	Steel
Class	Grade 8
Surface treatment	Zinc plated yellow passivated

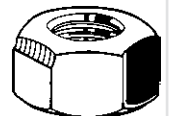

d	☒	Art.number	d	☒	Art.number	d	☒	Art.number
1/4-20*	100	U12920.025.0001	1/2-13*	25	U12920.050.0001	1.-8*	5	U12920.100.0001
5/16-18*	100	U12920.031.0001	5/8-11*	10	U12920.062.0001	1.1/8-7*	5	U12920.112.0001
3/8-16*	50	U12920.037.0001	3/4-10*	10	U12920.075.0001	1.1/4-7*	5	U12920.125.0001
7/16-14*	25	U12920.043.0001	7/8-9*	5	U12920.087.0001	1.1/2-6*	5	U12920.150.0001

U51915	Lock nut all metal conical Toplock (IFI-100/107)	X15A
Thread	Unified National Coarse	
Material	Stainless steel A2 (AISI 304/18-8)	
		

d	☒	Art.number	d	☒	Art.number	d	☒	Art.number
NO 8-32	50	U51915.016.0001	7/16-14*	25	U51915.043.0001	3/4-10*	5	U51915.075.0001
1/4-20*	50	U51915.025.0001	1/2-13*	10	U51915.050.0001	7/8-9*	5	U51915.087.0001
5/16-18*	50	U51915.031.0001	9/16-12*	10	U51915.056.0001	1.-8*	5	U51915.100.0001
3/8-16*	50	U51915.037.0001	5/8-11*	10	U51915.062.0001			

U55915	Lock nut all metal conical Toplock (IFI-100/107)	X15A
Thread	Unified National Coarse	
Material	Stainless steel A4 (AISI 316/18-10)	
		

d	☒	Art.number	d	☒	Art.number	d	☒	Art.number
1/4-20*	50	U55915.025.0001	1/2-13*	10	U55915.050.0001	3/4-10*	5	U55915.075.0001
5/16-18*	50	U55915.031.0001	9/16-12*	10	U55915.056.0001	7/8-9*	5	U55915.087.0001
3/8-16*	50	U55915.037.0001	5/8-11*	10	U55915.062.0001	1.-8*	5	U55915.100.0001
7/16-14*	25	U55915.043.0001						

Prevailing torque nut, all metal IFI-100/107 Toplock UNF

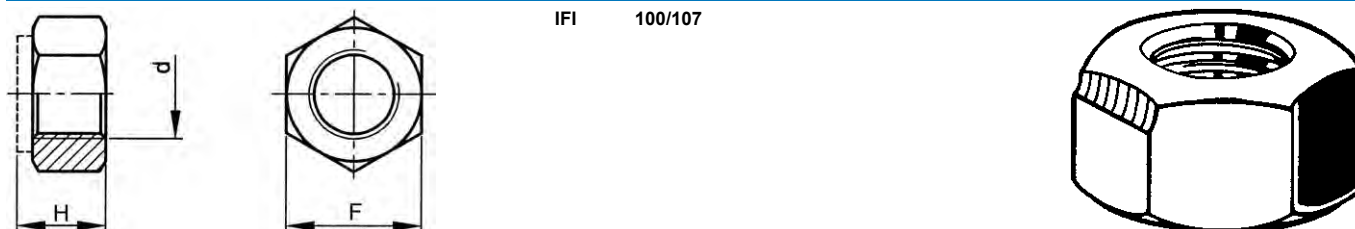

Technical Data			
d	F	H	Threads per inch
No.10	3/8	0.241	32
1/4	7/16	0.288	28
5/16	1/2	0.336	24
3/8	9/16	0.415	24
7/16	11/16	0.463	20
1/2	3/4	0.573	20
9/16	7/8	0.621	18
5/8	15/16	0.731	18
3/4	1.1/8	0.827	16
7/8	1.5/16	0.922	14
1 Inch	1.1/2	1.018	14
1.1/8	1.11/16	1.176	12
1.1/4	1.7/8	1.272	12
1.1/2	2.1/4	1.526	12

Article groups						
Thread	Driving features	Material	Class	Surface treatment	Code	Page
UNF	Hexagon	St	Grade 8	Zipl	U12950	3-70
UNF	Hexagon	St	Grade 8	Zipl yell.p.	U12960	3-70
UNF	Hexagon	St.St. A2 (AISI304/18-8)			U51960	3-70

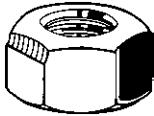
U12950	Lock nut all metal conical Toplock (IFI-100/107)	X01A
Thread	Unified National Fine	 
Material	Steel	
Class	Grade 8	
Surface treatment	Zinc plated	

d	☒	Art.number	d	☒	Art.number	d	☒	Art.number
1/4-28*	100	U12950.025.0002	9/16-18*	25	U12950.056.0002	1.-14*	5	U12950.101.0002
5/16-24*	100	U12950.031.0002	5/8-18*	10	U12950.062.0002	1.1/8-12*	5	U12950.112.0002
3/8-24*	50	U12950.037.0002	3/4-16*	10	U12950.075.0002	1.1/4-12*	5	U12950.125.0002
7/16-20*	25	U12950.043.0002	7/8-14*	5	U12950.087.0002	1.1/2-12*	5	U12950.150.0002
1/2-20*	25	U12950.050.0002						

U12960	Lock nut all metal conical Toplock (IFI-100/107)	X01A
Thread	Unified National Fine	
Material	Steel	
Class	Grade 8	
Surface treatment	Zinc plated yellow passivated	

d	☒	Art.number	d	☒	Art.number	d	☒	Art.number
1/4-28*	100	U12960.025.0002	1/2-20*	25	U12960.050.0002	3/4-16*	10	U12960.075.0002
5/16-24*	100	U12960.031.0002	9/16-18*	25	U12960.056.0002	7/8-14*	5	U12960.087.0002
3/8-24*	50	U12960.037.0002	5/8-18*	10	U12960.062.0002	1.-14*	5	U12960.101.0002

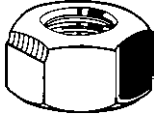
U51960	Lock nut all metal conical Toplock (IFI-100/107)	X15A
Thread	Unified National Fine	 
Material	Stainless steel A2 (AISI 304/18-8)	

d	☒	Art.number	d	☒	Art.number	d	☒	Art.number
NO.10-32*	50	U51960.019.0002	3/8-24*	50	U51960.037.0002	5/8-18*	10	U51960.062.0002
1/4-28*	50	U51960.025.0002	7/16-20*	25	U51960.043.0002	3/4-16*	5	U51960.075.0002
5/16-24*	50	U51960.031.0002	1/2-20*	10	U51960.050.0002			

Prevailing torque hexagon nut type H100-ESN

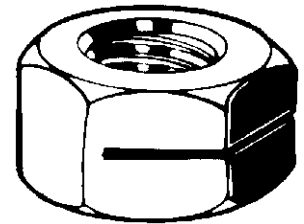
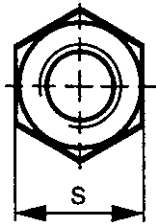
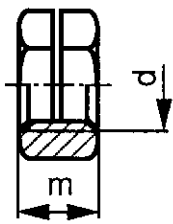

Technical Data

d	m	P	s	d	m	P	s
M4	4	0.7	7	M14	14	2	21
M5	5	0.8	8	M16	16	2	24
M6	6	1	10	M18	18	2.5	27
M7	7	1	11	M20	20	2.5	30
M8	8	1.25	13	M22	22	2.5	34
M10	10	1.5	16	M24	24	3	36
M12	12	1.75	18	M27	27	3	41

- These SNEP prevailing torque hexagon nuts should be used in combination with bolts of property class ≤ 6.8 .

Article groups

Thread	Driving features	Material	Surface treatment	Code	Page
M	Hexagon	St	Zipl	13100	3-71
M	Hexagon	St.St. A1/A2		51710	3-71
M	Hexagon	Al P60	Anod.	45300	3-72

13100 SNEP Prevailing torque hexagon nut all metal type H100-ESN

F01E

Thread	Metric thread
Material	Steel
Surface treatment	Zinc plated

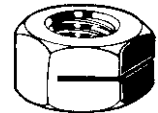

d	☒	Art.number	d	☒	Art.number	d	☒	Art.number
M4	250	13100.040.001	M10	200	13100.100.001	M20	25	13100.200.001
M5	250	13100.050.001	M12	100	13100.120.001	M22	25	13100.220.001
M6	250	13100.060.001	M14	100	13100.140.001	M24	25	13100.240.001
M7	250	13100.070.001	M16	50	13100.160.001	M27	10	13100.270.001
M8	250	13100.080.001	M18	50	13100.180.001			

Special features of SNEP prevailing torque type hexagon nuts:

- Is a one piece all metal nut.
- The locking is realised by elastic, axial displacement of the partly separated and compressed parts of the nut in relation to each other. First the nut runs freely on the bolt until the groove is reached, the clamping on the thread is achieved by the elastic reaction of the material independent of the torque.
- Zinc plated with a layer thickness of approx. 7 μm .
- Resistant to shocks, vibrations and dynamic loads.
- Re-useable.
- Temperature resistant from -100°C up to $+260^\circ\text{C}$.

51710 SNEP Prevailing torque hexagon nut all Stainless steel A1 type H100-ESN

R09A

Thread	Metric thread
Material	Stainless steel A1/A2

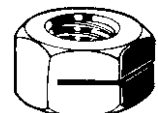

d	☒	Art.number	d	☒	Art.number	d	☒	Art.number
M4	100	51710.040.001	M8	50	51710.080.001	M12	25	51710.120.001
M5	100	51710.050.001	M10	50	51710.100.001	M16	10	51710.160.001
M6	100	51710.060.001						

Special features of SNEP prevailing torque type hexagon nuts:

- Is a one piece all stainless steel nut
- The locking is realised by elastic, axial displacement of the partly separated and compressed parts of the nut in relation to each other. First the nut runs freely on the bolt until the groove is reached, the clamping on the thread is achieved by the elastic reaction of the material independent of the torque
- Resistant to shocks, vibrations and dynamic loads
- Re-useable
- Temperature resistant from -100°C up to $+260^\circ\text{C}$
- Stainless steel SNEP prevailing torque type hexagon nuts are provided with a special lubricant to prevent seizing.
- Depending on availability A1 can be supplied as well as A2.

45300 SNEP Prevailing torque hexagon nut all Aluminium W01A

Thread: Metric thread
 Material: Aluminium P60
 Surface treatment: Anodized





d	☒	Art.number	d	☒	Art.number	d	☒	Art.number
M8	200	45300.080.001	M12	100	45300.120.001	M16	50	45300.160.001
M10	100	45300.100.001						

3

- Colourless anodized.

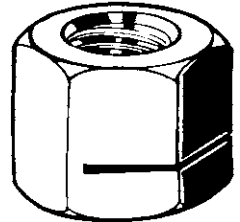
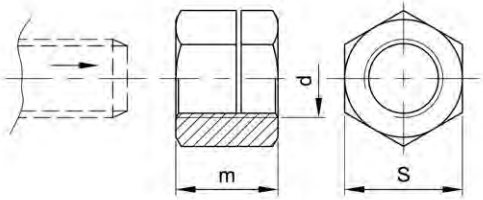
Prevailing torque hexagon nut all metal type H130-ESN



Technical Data

d	m	P	s	d	m	P	s
M4	5.2	0.7	7	M12	15.6	1.75	18
M5	6.5	0.8	8	M14	18.2	2	21
M6	7.8	1	10	M16	20.8	2	24
M7	9.1	1	11	M18	23.4	2.5	27
M8	10.4	1.25	13	M20	26	2.5	30
M10	13	1.5	16	M24	31.2	3	36

13200 SNEP Prevailing torque hexagonal nut all metal type H130-ESN F01E

Thread: Metric thread
 Material: Steel
 Surface treatment: Zinc plated





d	☒	Art.number	d	☒	Art.number	d	☒	Art.number
M4	250	13200.040.001	M8	250	13200.080.001	M16	50	13200.160.001
M5	250	13200.050.001	M10	200	13200.100.001	M18	50	13200.180.001
M6	250	13200.060.001	M12	100	13200.120.001	M20	25	13200.200.001
M7	250	13200.070.001	M14	100	13200.140.001	M24	25	13200.240.001

- These SNEP prevailing torque hexagon nuts should be used in combination with bolts of property class ≤ 8.8.

Prevailing torque hexagon nut all metal type USN

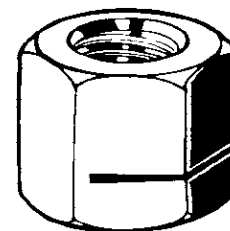
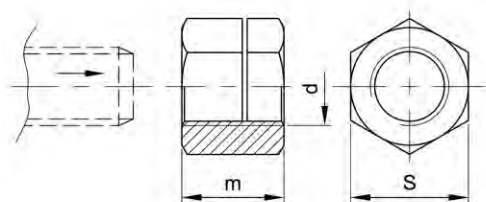

Technical Data

d	m	P	s	d	m	P	s
M30	30	3.5	46	M39	39	4	60
M33	33	3.5	50	M42	42	4.5	65
M36	36	4	55	M45	45	4.5	70

3

13190 SNEP Prevailing torque hexagon nut all metal type USN

F01E

Thread Metric thread
Material Steel
Surface treatment Zinc plated

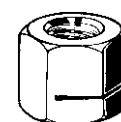

d	Art.number	d	Art.number	d	Art.number
M30	10 13190.300.001	M36	5 13190.360.001	M42	5 13190.420.001
M33	10 13190.330.001	M39	5 13190.390.001	M45	4 13190.450.001

- These SNEP prevailing torque hexagon nuts should be used in combination with bolts of property class ≤ 6.8 .
- SNEP prevailing torque hexagon nuts type USN are available, on request, up to and including M80.

Self-locking hexagon nut with flange

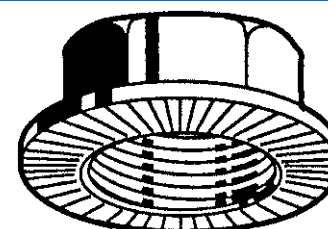
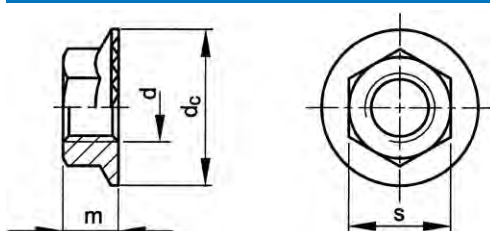

Technical Data

d	d _c	m	P	s	d	d _c	m	P	s
M5	11.2	4.3	0.8	8	M10	21	8.5	1.5	15
M6	14.2	5.5	1	10	M12	24	10	1.75	17
M8	18.2	7	1.25	13	M16	31	14	2	22

Special features of RIPP self-locking hexagon nuts with flange:



- the serrated flange limits surface damage assembly, prevents self-loosening and reduces relaxation
- the flange enables built-up forces under the nut head to be spread over a larger area, consequently resulting in lower surface pressure
- large holes (oversized) and/or tooling holes can be covered by the flange
- a washer and/or a locking element is not necessary



ASSEMBLY PRE-LOAD F_M in Kn and TIGHTENING TORQUE M_A in Nm

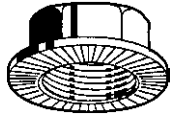

Class	Mating material	M5		M6		M8		M10		M12		M16	
		F_M	M_A	F_M	M_A	F_M	M_A	F_M	M_A	F_M	M_A	F_M	M_A
10	Steel ($R_m < 800 \text{ N/mm}^2$)	9	11	12,6	19	23,2	42	37	85	54	130	102	330
	Steel ($R_m \geq 800 \text{ N/mm}^2$)	9	10	12,6	18	23,2	37	37	80	54	120	102	310
	Malleable iron	9	9	12,6	16	23,2	35	37	75	54	115	102	300

Article groups

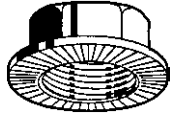
Thread	Driving features	Material	Class	Surface treatment	Code	Page
M	Hexagon	St	10		12470	3-74
M	Hexagon	St	10	Zipl	12471	3-74
M	Hexagon	St	10	FLZNNC-NC6	12474	3-74

12470		RIPP Self-locking hexagon nut with flange				F92A		
Thread	Metric thread							
Material	Steel							
Class	10							
								
								
d	☒	Art.number	d	☒	Art.number	d	☒	Art.number
M5	500	12470.050.001	M8	200	12470.080.001	M12	200	12470.120.001
M6	500	12470.060.001	M10	200	12470.100.001	M16	100	12470.160.001

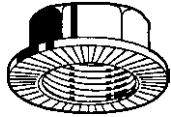
12471		RIPP Self-locking hexagon nut with flange				F92A		
Thread	Metric thread							
Material	Steel							
Class	10							
Surface treatment	Zinc plated							
								
								
d	☒	Art.number	d	☒	Art.number	d	☒	Art.number
M5	500	12471.050.001	M8	200	12471.080.001	M12	200	12471.120.001
M6	500	12471.060.001	M10	200	12471.100.001	M16	100	12471.160.001

12474		RIPP Self-locking hexagon nut with flange				F92A		
Thread	Metric thread							
Material	Steel							
Class	10							
Surface treatment	Zinc flake Cr ⁶⁺ free - ISO 10683 flZnnc							
								
								
d	☒	Art.number	d	☒	Art.number	d	☒	Art.number
M5	250	12474.050.001	M8	200	12474.080.001	M12	200	12474.120.001
M6	250	12474.060.001	M10	200	12474.100.001	M16	100	12474.160.001

Prevailing torque type hexagon nut all metal

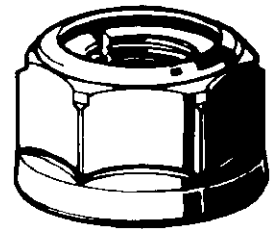
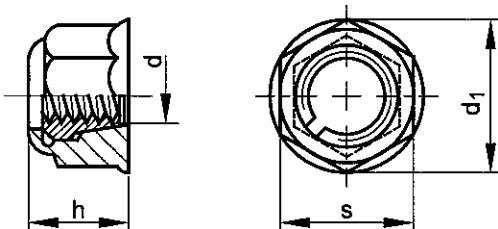

Technical Data

d	d ₁	h	P	s	d	d ₁	h	P	s
M6	12	7.5	1	10	M10	20.4	12.5	1.5	17
M8	16.8	10	1.25	14	M12	25	15	1.75	21

Special features of SECURIT prevailing torque type hexagon nuts:

- is a two-piece all metal nut, consisting of an internal cone in which the thread is tapped and slotted over the full height, and an external cone (being hexagonal with a turner over flange on the top) attached to each other.
- During torquing the internal cone is clamped around the full circumference of the thread with a progressive force.
- re-usable
- temperature resistant up to +350°C.

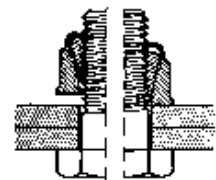

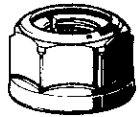
13000		SECURIT Prevailing torque type hexagon nut all metal				F93A		
Thread	Metric thread							
Material	Steel							
Class	6							
Surface treatment	Zinc plated yellow passivated							
								
d	☒	Art.number	d	☒	Art.number	d	☒	Art.number
M6	50	13000.060.001	M10	25	13000.100.001	M12	10	13000.120.001
M8	25	13000.080.001						

Self-locking hexagon nut

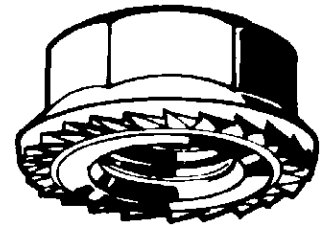
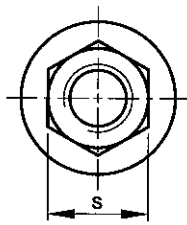
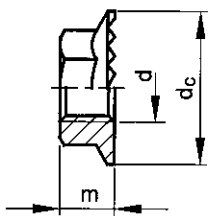

Technical Data

d	d _c	m	P	s	d	d _c	m	P	s
M5	11.2	4.3	0.8	8	M10	21	7.9	1.5	15
M6	14.25	5.5	1	10	M12	24	8.7	1.75	17
M8	18.25	7	1.25	13	M16	31	11.2	2	22

- Class 8 shall be used with property class 8.8 and 90 and class 10 with property class 10.9 and 100.

Special features of self-locking hexagon nuts:

- the resilient serrated flange gives excellent self-locking properties
- inside of the resilient flange serration there is an optimal preloading of the construction with minimal settlement
- a washer and/or locking element is not necessary and is not even advisable

ASSEMBLY PRE-LOAD F_M in kN and TIGHTENING TORQUE M_A in Nm

Class	Mating material	M5		M6		M8		M10		M12		M16	
		F_M	M_A	F_M	M_A	F_M	M_A	F_M	M_A	F_M	M_A	F_M	M_A
8	Steel	6,35	9	9	16	16,5	34	26,2	58	--	--	--	--
	Malleable iron	6,35	7	9	13	16,5	28	26,2	49	--	--	--	--
10	Steel	--	--	--	--	--	--	--	--	54	120	102	280
	Malleable iron	--	--	--	--	--	--	--	--	54	105	102	260

Article groups

Thread	Driving features	Material	Class	Surface treatment	Code	Page
M	Hexagon	St	8/10		01150	3-75
M	Hexagon	St	8/10	Zipl	01149	3-75
M	Hexagon	St	8/10	FLZNNC-NC6	01155	3-76

01150 Self-locking hexagon nut

F92A

Thread Metric thread
Material Steel
Class 8/10

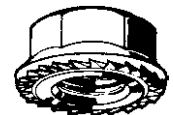

d	Art.number	d	Art.number	d	Art.number
M5 - CL.8	500 01150.050.001	M8 - CL.8	200 01150.080.001	M12 - CL.10	200 01150.120.001
M6 - CL.8	500 01150.060.001	M10 - CL.10	200 01150.100.001	M16 - CL.10	100 01150.160.001

01149 Self-locking hexagon nut

F92A

Thread Metric thread
Material Steel
Class 8/10
Surface treatment Zinc plated

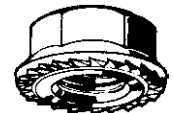

d	Art.number	d	Art.number	d	Art.number
M6 - CL.8	500 01149.060.001	M10 - CL.8	200 01149.100.001	M16 - CL.10	100 01149.160.001
M8 - CL.8	200 01149.080.001	M12 - CL.10	200 01149.120.001		

01155	Self-locking hexagon nut	F92A
Thread	Metric thread	 
Material	Steel	
Class	8/10	
Surface treatment	Zinc flake Cr ⁶⁺ free - ISO 10683 flZnnc	

d	☒	Art.number	d	☒	Art.number	d	☒	Art.number
M6	500	01155.060.001	M10	200	01155.100.001	M16	100	01155.160.001
M8	200	01155.080.001	M12	200	01155.120.001			

3

Hexagon nut with flange

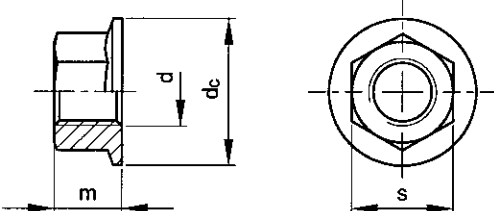

DIN 6923 (1983)
ISO 4161
NF E25-406

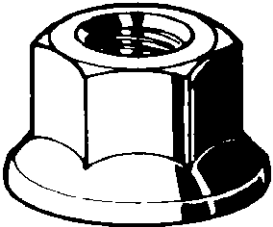

Technical Data

d	d _c (max.)	m (max.)	P	s
M4 (#DIN)	9.8	4.5	0.7	7
M5	11.8	5	0.8	8
M6	14.2	6	1	10
M8	17.9	8	1.25	13
M10	21.8	10	1.5	15
M12	26	12	1.75	18
M14	29.9	14	2	21
M16	34.5	16	2	24
M20	42.8	20	2.5	30
M24 (#DIN)	51	24	3	36

- Special features of hexagon nuts with flange:
- The flange enables built up forces to be spread over a larger area, consequently resulting in lower surface pressure.
- Large holes (oversized) and/or tooling holes can be covered by the flange.
- A washer is not necessary.

Article groups

Thread	Driving features	Material	Class	Surface treatment	Code	Page
M	Hexagon	St	8	Zipl	11590	3-76
M	Hexagon	St	8	Zipl yell.p.	11595	3-77
M	Hexagon	St	10	Zipl	11598	3-77
M	Hexagon	St.St. A2	70		51108	3-77
M	Hexagon	St.St. A4	70		55108	3-77

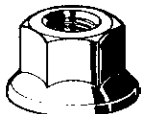
11590	Hexagon nut with flange	F01X
Thread	Metric thread	 
Material	Steel	
Class	8	
Surface treatment	Zinc plated	



d	☒	Art.number	d	☒	Art.number	d	☒	Art.number
M4	250	11590.040.001	M10	100	11590.100.001	M16	50	11590.160.001
M5	250	11590.050.001	M12	100	11590.120.001	M20	50	11590.200.001
M6	250	11590.060.001	M14	50	11590.140.001	M24	25	11590.240.001
M8	250	11590.080.001						

11595 Hexagon nut with flange		F01X
Thread	Metric thread	
Material	Steel	
Class	8	
Surface treatment	Zinc plated yellow passivated	

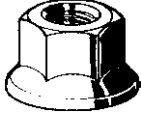

d	☒	Art.number	d	☒	Art.number	d	☒	Art.number
M5		250 11595.050.001	M10		100 11595.100.001	M14		50 11595.140.001
M6		250 11595.060.001	M12		100 11595.120.001	M16		50 11595.160.001
M8		250 11595.080.001						

11598 Hexagon nut with flange		F01X
Thread	Metric thread	
Material	Steel	
Class	10	
Surface treatment	Zinc plated	
		

d	☒	Art.number	d	☒	Art.number	d	☒	Art.number
M5		250 11598.050.001	M10		100 11598.100.001	M16		50 11598.160.001
M6		250 11598.060.001	M12		100 11598.120.001	M20		50 11598.200.001
M8		250 11598.080.001	M14		50 11598.140.001	M24		25 11598.240.001

51108 Hexagon nut with flange		R09A
Thread	Metric thread	
Material	Stainless steel A2	
Class	70	
		

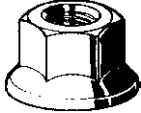
d	☒	Art.number	d	☒	Art.number	d	☒	Art.number
M4		100 51108.040.001	M6		250 51108.060.001	M10		100 51108.100.001
M5		250 51108.050.001	M8		250 51108.080.001	M12		100 51108.120.001

55108 Hexagon nut with flange		R49A
Thread	Metric thread	
Material	Stainless steel A4	
Class	70	
		

d	☒	Art.number	d	☒	Art.number	d	☒	Art.number
M4*		500 55108.040.001	M6*		200 55108.060.001	M8*		100 55108.080.001
M5*		500 55108.050.001						

Hexagon nut with toothed flange

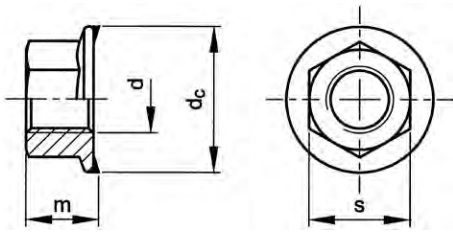

DIN ≈6923
ISO ≈4161
NF ≈E25-406

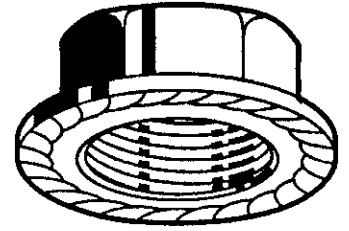

3

Technical Data

d	d _c (max.)	m (max.)	P	s
M3	7.8	3.8	0.5	6
M4 (≠DIN)	9.6	4.5	0.7	7
M5	11.8	5	0.8	8
M6	14.2	6	1	10
M8	17.9	8	1.25	13
M10	21.8	10	1.5	15
M12	26	12	1.75	18
M14	29.9	14	2	21
M16	34.5	16	2	24

- Special features of hexagon nuts with toothed flange:
- The flange enables built up forces to be spread over a larger area, consequently resulting in lower surface pressure.
- Large holes (oversized) and/or tooling holes can be covered by the flange.
- A washer is not necessary.
- Toothened flangebrim gives excellent self-locking properties.

Article groups

Thread	Driving features	Material	Class	Surface treatment	Code	Page
M	Hexagon	St	8		11609	3-78
M	Hexagon	St	8	Zipl	11610	3-78
M	Hexagon	St	8	Zipl yell.p.	11611	3-79
M	Hexagon	St.St. A2			51119	3-79
M	Hexagon	St.St. A4			55119	3-79

11609 Hexagon nut with toothed flange

F01X

Thread Metric thread
Material Steel
Class 8

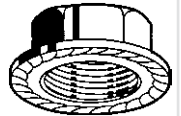

d	Art.number	d	Art.number	d	Art.number
M5	250 11609.050.001	M8	250 11609.080.001	M12	100 11609.120.001
M6	250 11609.060.001	M10	100 11609.100.001	M16	50 11609.160.001

11610 Hexagon nut with toothed flange

F01X

Thread Metric thread
Material Steel
Class 8
Surface treatment Zinc plated



d	Art.number	d	Art.number	d	Art.number
M4	250 11610.040.001	M8	250 11610.080.001	M14	50 11610.140.001
M5	250 11610.050.001	M10	100 11610.100.001	M16	50 11610.160.001
M6	250 11610.060.001	M12	100 11610.120.001		

11611 Hexagon nut with toothed flange		F01X
Thread	Metric thread	
Material	Steel	
Class	8	
Surface treatment	Zinc plated yellow passivated	

d	☒	Art.number	d	☒	Art.number	d	☒	Art.number
M4	250	11611.040.001	M8	250	11611.080.001	M14	50	11611.140.001
M5	250	11611.050.001	M10	100	11611.100.001	M16	50	11611.160.001
M6	250	11611.060.001	M12	100	11611.120.001			

51119 Hexagon nut with toothed flange		R09A
Thread	Metric thread	
Material	Stainless steel A2	

d	☒	Art.number	d	☒	Art.number	d	☒	Art.number
M3	500	51119.030.001	M6	200	51119.060.001	M12*	100	51119.120.001
M4	500	51119.040.001	M8	100	51119.080.001	M16*	50	51119.160.001
M5	500	51119.050.001	M10	100	51119.100.001			

55119 Hexagon nut with toothed flange		R49A
Thread	Metric thread	
Material	Stainless steel A4	

d	☒	Art.number	d	☒	Art.number	d	☒	Art.number
M3*	500	55119.030.001	M6*	200	55119.060.001	M12*	100	55119.120.001
M4*	500	55119.040.001	M8*	100	55119.080.001	M16*	50	55119.160.001
M5*	500	55119.050.001	M10*	100	55119.100.001			

Prevailing torque nut, all metal IFI-100/107, with flange, Imperial UNC

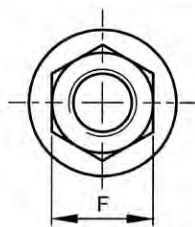
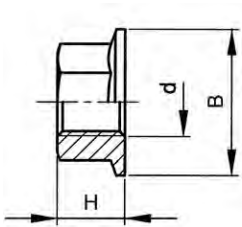

IFI 100/107

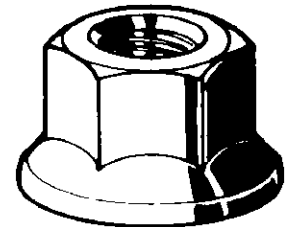

3

Technical Data

d	B	F	H	Threads per inch
No.8	0.375	11/32	0.191	32
No.10	0.475	3/8	0.241	24
1/4	0.560	7/16	0.300	20
5/16	0.680	1/2	0.365	18
3/8	0.810	9/16	0.425	16
7/16	0.930	11/16	0.495	14
1/2	1.07	3/4	0.555	13
5/8	1.330	15/16	0.690	11
3/4	1.585	1.1/8	0.825	10
7/8	1.750	1.5/16	0.790	9
1 Inch	2.06	1.1/2	0.900	8

Article groups

Thread	Driving features	Material	Class	Surface treatment	Code	Page
UNC	Hexagon	St	Grade 2	Zipl	U12100	3-80
UNC	Hexagon	St	Grade 8	Zipl	U12120	3-80

U12100 Lock nut all metal conical flange (IFI-100/107)

X01A

Thread	Unified National Coarse
Material	Steel
Class	Grade 2
Surface treatment	Zinc plated

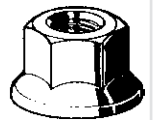

d	☒	Art.number	d	☒	Art.number	d	☒	Art.number
NO.8-32*	100	U12100.016.0001	3/8-16*	50	U12100.037.0001	3/4-10*	10	U12100.075.0001
NO.10-24*	100	U12100.019.0001	7/16-14*	25	U12100.043.0001	7/8-9*	5	U12100.087.0001
1/4-20*	100	U12100.025.0001	1/2-13*	25	U12100.050.0001	1.-8*	5	U12100.100.0001
5/16-18*	100	U12100.031.0001	5/8-11*	10	U12100.062.0001			

U12120 Lock nut all metal conical flange (IFI-100/107)

X01A

Thread	Unified National Coarse
Material	Steel
Class	Grade 8
Surface treatment	Zinc plated

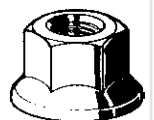

d	☒	Art.number	d	☒	Art.number	d	☒	Art.number
1/4-20*	100	U12120.025.0001	7/16-14*	25	U12120.043.0001	3/4-10*	10	U12120.075.0001
5/16-18*	100	U12120.031.0001	1/2-13*	25	U12120.050.0001	7/8-9*	5	U12120.087.0001
3/8-16*	50	U12120.037.0001	5/8-11*	10	U12120.062.0001	1.-8*	5	U12120.100.0001

Prevailing torque type hexagon flange nut with non-metallic insert

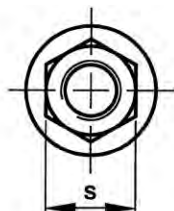
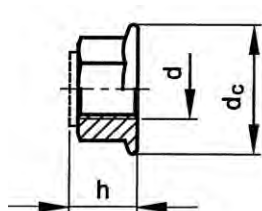

DIN 6926
ISO 7043

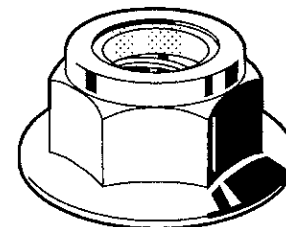

Technical Data

d	d _c (max.)	h (max.)	P	s
M4	10	4.65	0.7	7
M5	11.8	7.1	0.8	8
M6	14.2	9.1	1	10
M8	17.9	11.1	1.25	13
M10	21.8	13.5	1.5	15
M12	26	16.1	1.75	18
M16	34.5	20.3	2	24

Article groups

Thread	Driving features	Material	Class	Surface treatment	Code	Page
M	Hexagon	St	8	Zipl	12460	3-81
M	Hexagon	St.St. A2	70		51738	3-81
M	Hexagon	St.St. A4	70		55738	3-81

12460 Prevailing torque type hexagon flange nut with non-metallic insert

F01X

Thread Metric thread
Material Steel
Class 8
Surface treatment Zinc plated

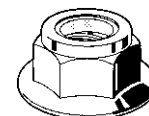

d	Art.number	d	Art.number	d	Art.number
M5	250 12460.050.001	M8	250 12460.080.001	M12	100 12460.120.001
M6	250 12460.060.001	M10	200 12460.100.001	M16	50 12460.160.001

51738 Prevailing torque type hexagon flange nut with non-metallic insert

R09A

Thread Metric thread
Material Stainless steel A2
Class 70

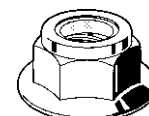

d	Art.number	d	Art.number	d	Art.number
M4*	500 51738.040.001	M6*	500 51738.060.001	M10*	100 51738.100.001
M5*	500 51738.050.001	M8*	100 51738.080.001	M12*	100 51738.120.001

55738 Prevailing torque type hexagon flange nut with non-metallic insert

R49A

Thread Metric thread
Material Stainless steel A4
Class 70

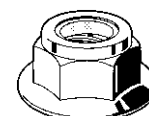

d	Art.number	d	Art.number	d	Art.number
M4*	500 55738.040.001	M6*	500 55738.060.001	M10*	100 55738.100.001
M5*	500 55738.050.001	M8*	100 55738.080.001		

Hexagon flange lock nut serrated

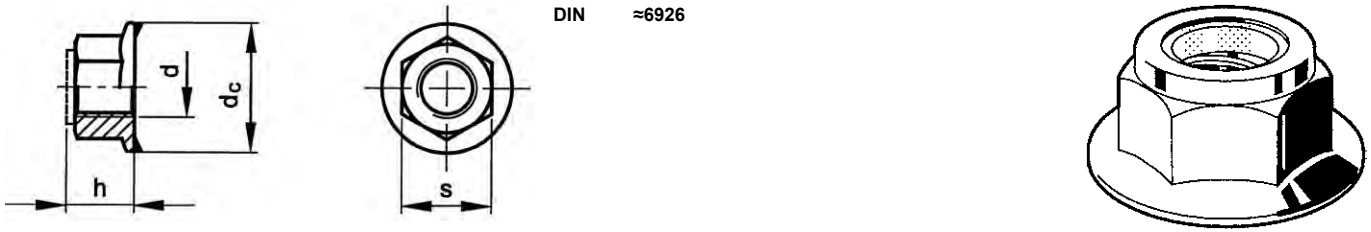

3

Technical Data

d	d _c (max.)	h (max.)	P	s
M4	10	4.65	0.7	7
M5	11.8	7.1	0.8	8
M6	14.2	9.1	1	10
M8	17.9	11.1	1.25	13
M10	21.8	13.5	1.5	15
M12	26	16.1	1.75	18

Article groups

Thread	Driving features	Material	Class	Code	Page
M	Hexagon	St.St. A2	50	51734	3-82
M	Hexagon	St.St. A4	50	55734	3-82

51734 Hexagon flange lock nut with non-metallic insert with serration R09A

Thread Metric thread
Material Stainless steel A2
Class 50

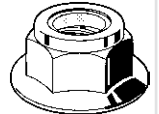

d	☒	Art.number	d	☒	Art.number	d	☒	Art.number
M4*	500	51734.040.001	M6*	500	51734.060.001	M10*	100	51734.100.001
M5*	500	51734.050.001	M8*	100	51734.080.001	M12*	100	51734.120.001

55734 Hexagon flange lock nut with non-metallic insert with serration R49A

Thread Metric thread
Material Stainless steel A4
Class 50

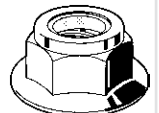

d	☒	Art.number	d	☒	Art.number	d	☒	Art.number
M4*	500	55734.040.001	M6*	100	55734.060.001	M10*	100	55734.100.001
M5*	500	55734.050.001	M8*	100	55734.080.001	M12*	100	55734.120.001

Hexagon wheelnut

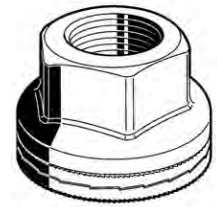
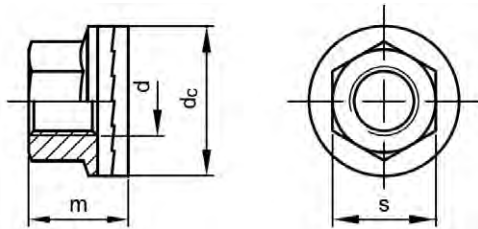

Technical Data

d x P	Assembly pre-load (kN)	d _c	m	s	Tightening torque (Nm)
M22x1.5	≈ 200	46	27	32	600-650

12479 NORD-LOCK Hexagon wheelnut

NL2A

Thread	Metric extra fine thread
Material	Steel
Class	10
Surface treatment	Delta Protokt®

NORD-LOCK
Bolt securing system



d x P	Art.number
M22X1,5	20 12479.220.150

Nut with conical washer

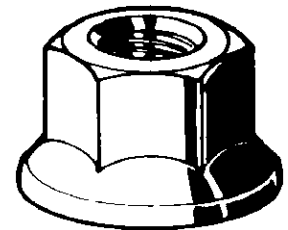
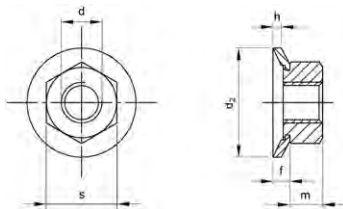

Technical Data

d ₂	d ₂	f	h	m	P	s
M3	8	1	0.5	2.4	0.5	5.5
M4	10	1	0.6	3.2	0.7	5.5
M5	12	1.35	1.25	4	0.8	8
M6	18	1.7	1.5	5	1	10
M8	18	2.2	1.5	6.5	1.25	13
M10	22	1.6	1.7	8	1.5	17

51112 COMBY nut with conical washer

R09A

Thread	Metric thread
Material	Stainless steel A2

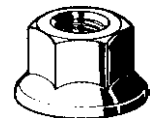

d	Art.number	d	Art.number	d	Art.number
M3*	1000 51112.030.008	M5*	500 51112.050.015	M8*	100 51112.080.018
M4*	1000 51112.040.010	M6*	500 51112.060.018	M10*	200 51112.100.022

Prevailing torque type hexagon nut with captive toothed lock washer

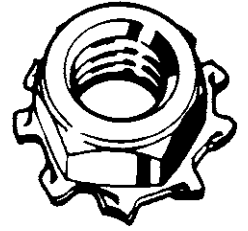
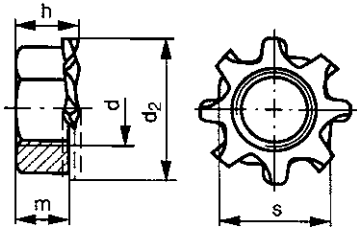

3

Technical Data

d	d ₂	h	m	P	s
M3	6.6	3.1	2.4	0.5	5.5
M4	8	4	3.2	0.7	7
M5	9.2	5.1	4	0.8	8
M6	11.4	6.1	5	1	10
M8	14.9	7.9	6.5	1.25	13

11490 COMBY Prevailing torque type hexagon nut with captive toothed lock washer

F01X

Thread Metric thread
Material Steel
Surface treatment Zinc plated



d	Art.number	d	Art.number	d	Art.number
M3	250 11490.030.001	M5	250 11490.050.001	M8	200 11490.080.001
M4	250 11490.040.001	M6	250 11490.060.001		

Self-locking counter nut

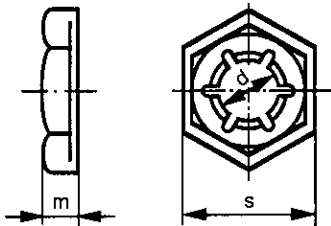

DIN 7967
NF E27-460

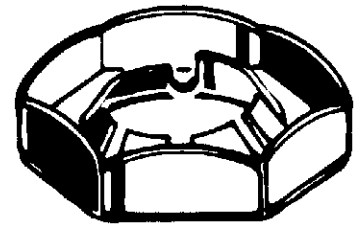

Technical Data

d	m	P	s	d	m	P	s
M4	2.5	0.7	7	M18	5.5	2.5	27
M5	2.5	0.8	8	M20	6	2.5	30
M6	3	1	10	M22	6	2.5	32
M8	3.5	1.25	13	M24	7	3	36
M10	4	1.5	17	M27	7	3	41
M12	4.5	1.75	19	M30	8	3.5	46
M14	5	2	22	M36	9	4	55
M16	5	2	24	M42	11	4.5	65

Special features of PAL self-locking counter nuts:

- have to be spun down the thread until finger-tight, then locked by a quarter to half turn with a spanner. Besides the clamping force A, a simultaneous radial force B will be developed causing a locking action
- are often used as locknut above a hexagon nut
- disassembly by tighten the hexagon nut firmly

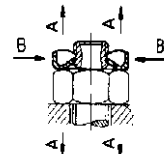

Article groups

Thread	Driving features	Material	Surface treatment	Code	Page
M	Hexagon	Spring steel	Zipl	12530	3-85
M	Hexagon	Spring steel	Hot d.g.	12531	3-85
M	Hexagon	St.St. A2		51735	3-85
M	Hexagon	St.St. A4		55735	3-85

12530 PAL Self-locking counter nut F01X

Thread Metric thread
 Material Spring steel
 Surface treatment Zinc plated





d	☒	Art.number	d	☒	Art.number	d	☒	Art.number
M5	200	12530.050.001	M14	100	12530.140.001	M24	100	12530.240.001
M6	200	12530.060.001	M16	100	12530.160.001	M27	100	12530.270.001
M8	100	12530.080.001	M18	100	12530.180.001	M30	100	12530.300.001
M10	100	12530.100.001	M20	100	12530.200.001	M36	100	12530.360.001
M12	100	12530.120.001	M22	100	12530.220.001	M42	50	12530.420.001

• Warning: electro-galvanizing of these products may cause hydrogen embrittlement.

12531 PAL Self-locking counter nut F01A



Thread Metric thread
 Material Spring steel
 Surface treatment Hot dip galvanized



d	☒	Art.number	d	☒	Art.number	d	☒	Art.number
M10	100	12531.100.001	M20	100	12531.200.001	M30	100	12531.300.001
M12	100	12531.120.001	M24	50	12531.240.001	M36	25	12531.360.001
M16	100	12531.160.001	M27	100	12531.270.001			

51735 PAL Self-locking counter nut R09A



Thread Metric thread
 Material Stainless steel A2
 DIN ≈7967
 NF ≈E27-460

d	☒	Art.number	d	☒	Art.number	d	☒	Art.number
M4*	500	51735.040.001	M8	100	51735.080.001	M16	50	51735.160.001
M5*	500	51735.050.001	M10	100	51735.100.001	M20	50	51735.200.001
M6	200	51735.060.001	M12	50	51735.120.001	M24	50	51735.240.001

55735 PAL Self-locking counter nut R49A

Thread Metric thread
 Material Stainless steel A4
 DIN ≈7967
 NF ≈E27-460



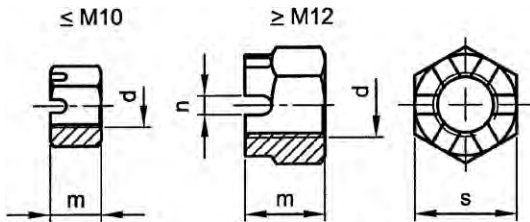

d	☒	Art.number	d	☒	Art.number	d	☒	Art.number
M4*	500	55735.040.001	M10*	100	55735.100.001	M20*	100	55735.200.001
M5*	500	55735.050.001	M12*	100	55735.120.001	M24*	50	55735.240.001
M6	100	55735.060.001	M16*	100	55735.160.001	M27*	50	55735.270.001
M8	100	55735.080.001						

Hexagon slotted and castle nut

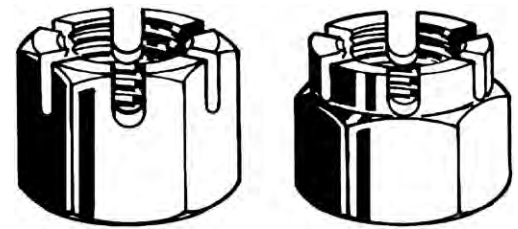

DIN 935-1
NEN 729



3

Technical Data

d	m	n	Number of slots	P	s	Split pin DIN 94
M5	6	1.4	6	0.8	8	1.2x12
M6	7.5	2	6	1	10	1.6x14
M8	9.5	2.5	6	1.25	13	2x16
M10	12	2.8	6	1.5	17 (16)	2.5x20
M12	15	3.5	6	1.75	19 (18)	3.2x22
M14	16	3.5	6	2	22 (21)	3.2x25
M16	19	4.5	6	2	24	4x28
M18	21	4.5	6	2.5	27	4x32
M20	22	4.5	6	2.5	30	4x36
M22	26	5.5	6	2.5	32 (34)	5x36
M24	27	5.5	6	3	36	5x40
M27	30	5.5	6	3	41	5x45
M30	33	7	6	3.5	46	6.3x50
M33	35	7	6	3.5	50	6.3x56
M36	38	7	6	4	55	6.3x63
M39	40	7	6	4	60	6.3x71
M42	46	9	8	4.5	65	8x71
M45	48	9	8	4.5	70	8x80
M48	50	9	8	5	75	8x80
M52	54	9	8	5	80	8x90
M56	57	9	8	5.5	85	8x100
M60	63	11	8	5.5	90	10x100
M64	66	11	8	6	95	10x100

- Guide values for advised split pins (cotter pins) acc. to DIN 94 (ISO 1234).
- Depending on availability the dimensions may deviate.

Article groups

Thread	Driving features	Material	Class	Surface treatment	Code	Page
M	Hexagon	St	4		12000	3-86
M	Hexagon	St	4	Zipl	12010	3-87
M	Hexagon	St.St. A2			51220	3-87
M	Hexagon	St.St. A4			55220	3-87

12000 Hexagon slotted and castle nut

F01D

Thread Metric thread
Material Steel
Class 4

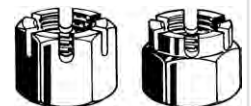

d	☒	Art.number	d	☒	Art.number	d	☒	Art.number
M5	100	12000.050.001	M20	25	12000.200.001	M42	4	12000.420.001
M6	100	12000.060.001	M22	25	12000.220.001	M45	3	12000.450.001
M8	100	12000.080.001	M24	25	12000.240.001	M48	3	12000.480.001
M10	100	12000.100.001	M27	10	12000.270.001	M52	1	12000.520.001
M12	100	12000.120.001	M30	10	12000.300.001	M56	1	12000.560.001
M14	50	12000.140.001	M33	10	12000.330.001	M60	1	12000.600.001
M16	50	12000.160.001	M36	5	12000.360.001	M64	1	12000.640.001
M18	50	12000.180.001	M39	4	12000.390.001			

- Up to and including M12 slotted and castle nuts are class 5, above size M12 class 4.
- Up to and including M39 slotted and castle nuts are provided with 6 slots, above M39 with 8 slots.

12010 Hexagon slotted and castle nut		F01D
Thread	Metric thread	 
Material	Steel	
Class	4	
Surface treatment	Zinc plated	

d	☒	Art.number	d	☒	Art.number	d	☒	Art.number
M6	100	12010.060.001	M16	50	12010.160.001	M27	10	12010.270.001
M8	100	12010.080.001	M20	25	12010.200.001	M30	10	12010.300.001
M10	100	12010.100.001	M22	25	12010.220.001	M33	10	12010.330.001
M12	100	12010.120.001	M24	25	12010.240.001	M36	5	12010.360.001
M14	50	12010.140.001						

- Up to and including M12 slotted and castle nuts are class 5, above size M12 class 4.
- Up to and including M39 slotted and castle nuts are provided with 6 slots, above M39 with 8 slots.

51220 Hexagon slotted and castle nut		R09A
Thread	Metric thread	 
Material	Stainless steel A2	

d	☒	Art.number	d	☒	Art.number	d	☒	Art.number
M5	50	51220.050.001	M14	25	51220.140.001	M22*	25	51220.220.001
M6	50	51220.060.001	M16	10	51220.160.001	M24	5	51220.240.001
M8	50	51220.080.001	M18	10	51220.180.001	M27	3	51220.270.001
M10	50	51220.100.001	M20	5	51220.200.001	M30	1	51220.300.001
M12	25	51220.120.001						

55220 Hexagon slotted and castle nut		R49A
Thread	Metric thread	 
Material	Stainless steel A4	

d	☒	Art.number	d	☒	Art.number	d	☒	Art.number
M5	50	55220.050.001	M12	25	55220.120.001	M20	5	55220.200.001
M6	50	55220.060.001	M14	25	55220.140.001	M24	5	55220.240.001
M8	50	55220.080.001	M16	10	55220.160.001	M27	3	55220.270.001
M10	50	55220.100.001	M18	10	55220.180.001	M30	1	55220.300.001

Hexagon slotted and castle nut MF

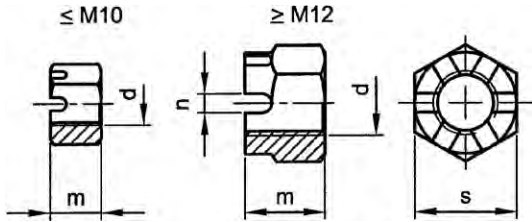

DIN 935
NEN 729

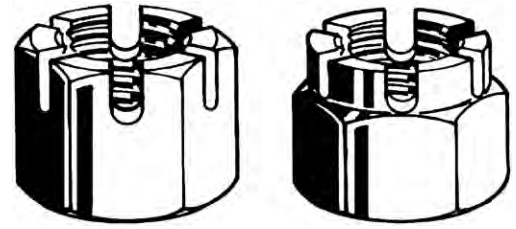

3

Technical Data

d	m	n	Number of slots	s	Split pin DIN 94
M8	9.5	2.5	6	13	2x16
M10	12	2.8	6	17 (16)	2.5x20
M12	15	3.5	6	19 (18)	3.2x22
M14	16	3.5	6	22 (21)	3.2x25
M16	19	4.5	6	24	4x28
M18	21	4.5	6	27	4x32
M20	22	4.5	6	30	4x36
M22	26	5.5	6	32 (34)	5x36
M24	27	5.5	6	36	5x40
M27	30	5.5	6	41	5x45
M30	33	7	6	46	6.3x50
M36	38	7	6	55	6.3x63
M42	46	9	8	65	8x71

- Guide values for advised split pins (cotter pins) acc. to DIN 94 (ISO 1234).
- Depending on availability the dimensions may deviate.

12020 Hexagon slotted and castle nut MF

F01D

Thread Metric fine thread
Material Steel
Class 4

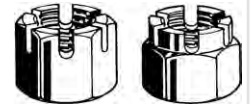

d x P	☒	Art.number	d x P	☒	Art.number	d x P	☒	Art.number
M8X1,00	100	12020.080.100	M18X1,50	50	12020.180.150	M30X1,50 (≠DIN)	10	12020.300.150
M10X1,00	100	12020.100.100	M20X1,50	25	12020.200.150	M30X2,00	10	12020.300.200
M12X1,50	100	12020.120.150	M22X1,50	25	12020.220.150	M36X1,50 (≠DIN)	5	12020.360.150
M14X1,50	50	12020.140.150	M24X1,50 (≠DIN)	25	12020.240.150	M42X1,50 (≠DIN)	5	12020.420.150
M16X1,50	50	12020.160.150	M27X1,50 (≠DIN)	10	12020.270.150			

Hexagon thin slotted and castle nut

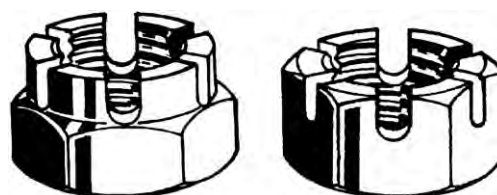
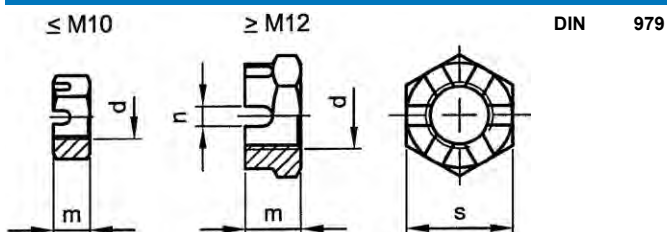

Technical Data

d	m	n	P	s	Split pin DIN 94
M6	5	2	1	10	1.6x14
M8	6.5	2.5	1.25	13	2x16
M10	9	2.8	1.5	17	2.5x20
M12	10	3.5	1.75	19 (18)	3.2x22
M14	11	3.5	2	22 (21)	3.2x25
M16	13	4.5	2	24	4x28
M18	15	4.5	2.5	27	4x32
M20	16	4.5	2.5	30	4x36
M22	18	5.5	2.5	32 (34)	5x36
M24	19	5.5	3	36	5x40
M27	22	5.5	3	41	5x45
M30	24	7	3.5	46	6.3x50

- Guide values for advised split pins (cotter pins) acc. to DIN 94 (ISO 1234).
- Depending on availability the dimensions may deviate.

Article groups

Thread	Driving features	Material	Class	Code	Page
M	Hexagon	St	04	12060	3-89
M	Hexagon	St.St. A2	35	51224	3-89

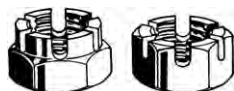
12060 Hexagon thin slotted and castle nut				F01D
Thread	Metric thread	Material	Steel	 
Material	Steel	Class	04	
Class	04			

d	☒	Art.number	d	☒	Art.number	d	☒	Art.number
M8	100	12060.080.001	M16	50	12060.160.001	M24	25	12060.240.001
M10	100	12060.100.001	M18	50	12060.180.001	M27	10	12060.270.001
M12	100	12060.120.001	M20	25	12060.200.001	M30	10	12060.300.001
M14	50	12060.140.001	M22	25	12060.220.001			

51224 Hexagon thin slotted and castle nut				R05A
Thread	Metric thread	Material	Stainless steel A2	 
Material	Stainless steel A2	Class	35	
Class	35			

d	☒	Art.number	d	☒	Art.number	d	☒	Art.number
M8*	50	51224.080.001	M12*	50	51224.120.001	M16*	25	51224.160.001
M10*	50	51224.100.001						

Castle nut low

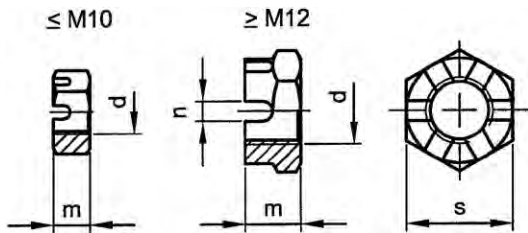

DIN 937

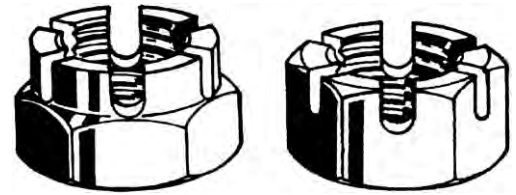

3

Technical Data

d	m	n	P	s	Split pin DIN 94
M6	6	2	1	10	1.6x14
M8	8	2.5	1.25	13	2x16
M10	8	2.8	1.5	17 (16)	2.5x20
M12	10	3.5	1.75	19	3.2x22
M16	12	4.5	2	24	4x28
M18	13	4.5	2.5	27	4x32
M20	13	4.5	2.5	30	4x36

Article groups

Thread	Driving features	Material	Class	Code	Page
M	Hexagon	St.St. A2	35	51225	3-90
M	Hexagon	St.St. A4	35	55225	3-90

51225		Castle nut low		R05A	
Thread	Metric thread	Material	Stainless steel A2		
Material	Stainless steel A2	Class	35		
Class	35			 	

d	☒	Art.number	d	☒	Art.number	d	☒	Art.number
M10*	50	51225.100.001	M16*	50	51225.160.001	M20*	25	51225.200.001

55225		Castle nut low		R45A	
Thread	Metric thread	Material	Stainless steel A4		
Material	Stainless steel A4	Class	35		
Class	35			 	

d	☒	Art.number	d	☒	Art.number	d	☒	Art.number
M6*	100	55225.060.001	M10*	50	55225.100.001	M16*	50	55225.160.001
M8*	100	55225.080.001	M12*	50	55225.120.001	M18*	25	55225.180.001

Hexagon thin slotted and castle nut MF

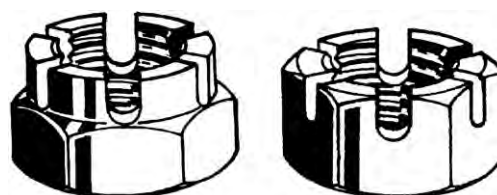
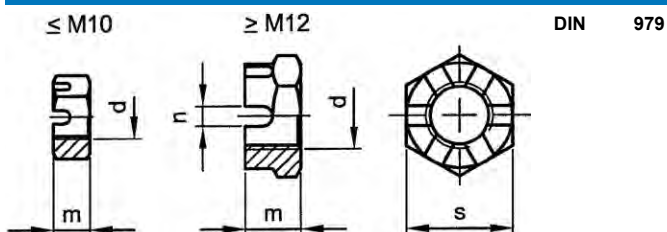

Technical Data

d	m	n	s	Split pin DIN 94
M8	6.5	2.5	13	2X16
M10	8	2.8	17 (16)	2.5X20
M12	10	3.5	19 (18)	3.2X22
M14	11	3.5	22 (21)	3.2X25
M16	13	4.5	24	4X28
M18	15	4.5	27	4X32
M20	16	4.5	30	4X36
M22	18	5.5	32 (34)	5x36
M24	19	5.5	36	5x40
M27	22	5.6	41	5x45
M30	24	7	46	6.3x50
M39	31	7	60	6.3x71

- Guide values for advised split pins (cotter pins) acc. to DIN 94 (ISO 1234).
- Depending on availability the dimensions may deviate.

12080 Hexagon thin slotted and castle nut MF

F01D

Thread Metric fine thread
Material Steel
Class ≥04



d x P	☒	Art.number	d x P	☒	Art.number	d x P	☒	Art.number
M8X1,00	100	12080.080.100	M18X1,50	50	12080.180.150	M27X1,50 (≠DIN)	10	12080.270.150
M10X1,00	100	12080.100.100	M20X1,50	25	12080.200.150	M30X1,50 (≠DIN)	10	12080.300.150
M12X1,50	100	12080.120.150	M22X1,50	25	12080.220.150	M30X2,00	10	12080.300.200
M14X1,50	50	12080.140.150	M24X1,50 (≠DIN)	25	12080.240.150	M39X1,50 (≠DIN)	5	12080.390.150
M16X1,50	50	12080.160.150						

Hexagon slotted and castle nut UNF

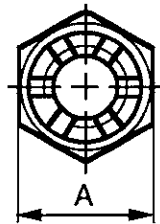
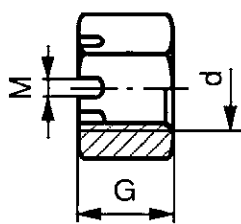

BS ≈1768

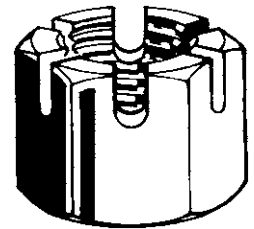

3

Technical Data

d	A	G	M	Threads per inch
1/4	7/16	5.7	2	28
3/8	9/16	8	3.2	24
7/16	11/16	9.7	3.2	20
1/2	3/4	11.2	4	20
5/8	15/16	14	4.8	18
3/4	1.1/8	16.5	4.8	16
7/8	1.5/16	19.3	4.8	14
1 Inch-12G	1.1/2	22.2	6.4	12
1 Inch-14G	1.1/2	22.2	6.4	14
1.1/4	1.7/8	27.6	8	12
1.1/2	2.1/4	33.3	9.5	12

- Depending on availability the dimensions may deviate.
- If when ordering, UNF 1 inch-12 is not stated, then we supply the type with 14 threads per inch.

12161 Hexagon slotted and castle nut UNF

X09A

Thread Unified National Fine
Material Steel
Class 6

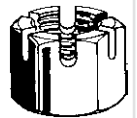

d	☒	Art.number	d	☒	Art.number	d	☒	Art.number
1/4	100	12161.063.001	5/8	25	12161.158.001	1-14G	10	12161.256.001
3/8	100	12161.096.001	3/4	25	12161.191.001	1.1/4	10	12161.317.001
7/16	50	12161.111.001	7/8	25	12161.222.001	1.1/2	5	12161.381.001
1/2	50	12161.127.001	1-12G	10	12161.255.001			

KALEI Press nuts



General

With KALEI press nuts thin sheet material from 1 mm thick can be provided with full loadable thread. This is an ideal solution for the metal- and/or the plastic sheet processing industry.

Principle

The special formed collar seizes firmly into the material so that the KALEI press nut is secured from pulling loose axially and also from twisting round clockwise viewed from the assembly side.

Assembly

Centering the KALEI press nut above the drilled or punched hole, (tolerance hole $d_2 = H11$). Mechanical insertion or by hammer through which the serrated collar is seated in the wall of hole (use of an inserting tool simplifies assembly). Screws are turned into the KALEI press nut from the collar side. During tightening the collar will be even further anchored in the material.

Type

Steel zinc plated and stainless steel with collar heights (kh) from 0,9 mm up to and including 3,9 mm. Special KALEI press nuts with higher collar heights for application in light-weight materials, plastics etc., and also non-metric KALEI press nuts are available on request.

Properties

- ideal method to provide thin sheet material with loadable thread
- simple and quick assembly without welding or riveting
- safe seating in sheet material by a specially inclined serrated and case hardened collar
- applicable in steel, aluminium and plastic
- available for several material thicknesses

Assembly sequence

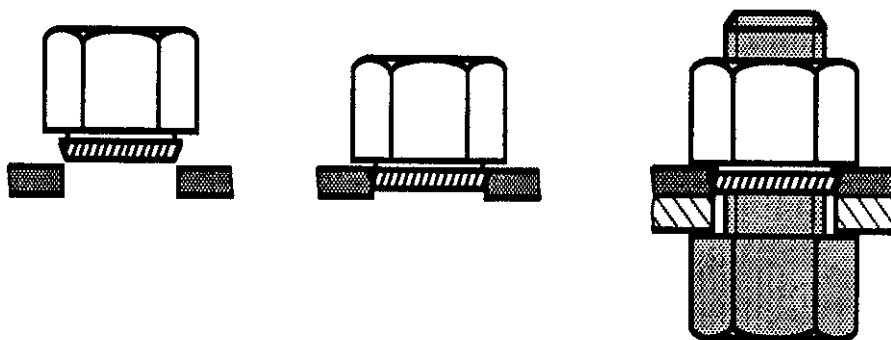

Press nut

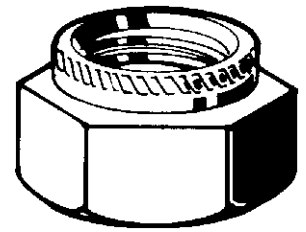
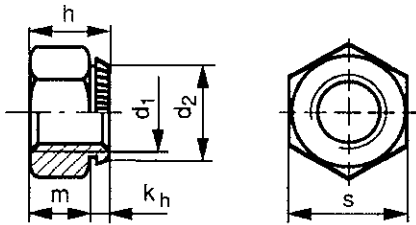

3

Technical Data

d ₁	d ₂	h	Hole ø (H11)	k _h	m	Material thickness (min.)	P	s
M3	4.5	3	4.5	0.9	2.1	1	0.5	5.5
M3 (Kh1.4)	4.5	3	4.5	1.4	1.6	1.5	0.5	5.5
M3 (Kh1.8)	4.5	3	4.5	1.8	1.2	2	0.5	5.5
M4	5.5	3.2	5.5	0.9	2.3	1	0.7	7
M4 (Kh1.4)	5.5	3.2	5.5	1.4	1.8	1.5	0.7	7
M4 (Kh1.8)	5.5	4.5	5.5	1.8	2.7	2	0.7	7
M5	6.5	4	6.5	0.9	3.1	1	0.8	8
M5 (Kh1.4)	6.5	4	6.5	1.4	2.6	1.5	0.8	8
M5 (Kh1.8)	6.5	5	6.5	1.8	3.2	2	0.8	8
M6	8	5	8	0.9	4.1	1	1	10
M6 (Kh1.4)	8	5	8	1.4	3.6	1.5	1	10
M6 (Kh1.8)	8	5	8	1.8	3.2	2	1	10
M8	10	6.5	10	1.8	4.7	2	1.25	13
M10	12.5	8	12.5	1.8	6.2	2	1.5	15
M12	14.5	10	14.5	2.8	7.2	3	1.75	17
M16	18.5	13	18.5	2.4	10.6	3	2	22
M20	23	16	23	3.9	12.1	4	2.5	27

Article groups

Thread	Driving features	Material	Class	Surface treatment	Code	Page	
M	Hexagon	St	6	Zipl	15000	3-94	
M	Hexagon	St.St. A1			15060	3-94	
M	Hexagon	St	6	Zipl	Kh=1,4	15010	3-95
M	Hexagon	St.St. A1			Kh=1,4	15070	3-95
M	Hexagon	St	6	Zipl	Kh=1,8	15020	3-95
M	Hexagon	St.St. A1			Kh=1,8	15080	3-95

15000 KALEI Press nut

F01E

Thread	Metric thread
Material	Steel
Class	6
Surface treatment	Zinc plated

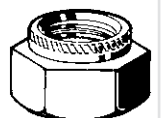

d ₁	Art.number	d ₁	Art.number	d ₁	Art.number
M3	250 15000.030.001	M6	250 15000.060.001	M12	100 15000.120.001
M4	250 15000.040.001	M8	250 15000.080.001	M16	50 15000.160.001
M5	250 15000.050.001	M10	100 15000.100.001	M20	25 15000.200.001

15060 KALEI Press nut

F01E

Thread	Metric thread
Material	Stainless steel A1

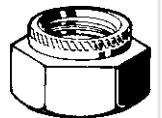

d ₁	Art.number	d ₁	Art.number	d ₁	Art.number
M3	100 15060.030.001	M6	100 15060.060.001	M12	50 15060.120.001
M4	100 15060.040.001	M8	50 15060.080.001	M16	25 15060.160.001
M5	100 15060.050.001	M10	50 15060.100.001		

15010 KALEI Press nut Kh= 1,4 F01E

Thread	Metric thread	 	
Material	Steel		
Class	6		
Surface treatment	Zinc plated		

d_1	☒	Art.number	d_1	☒	Art.number	d_1	☒	Art.number
M3	250	15010.030.001	M5	250	15010.050.001	M6	250	15010.060.001
M4	250	15010.040.001						

15070 KALEI Press nut Kh= 1,4 F01E

Thread	Metric thread	 	
Material	Stainless steel A1		
Class	6		
Surface treatment	Zinc plated		

d_1	☒	Art.number	d_1	☒	Art.number	d_1	☒	Art.number
M3	100	15070.030.001	M5	100	15070.050.001	M6	100	15070.060.001
M4	100	15070.040.001						

15020 KALEI Press nut Kh= 1,8 F01E

Thread	Metric thread	 	
Material	Steel		
Class	6		
Surface treatment	Zinc plated		

d_1	☒	Art.number	d_1	☒	Art.number	d_1	☒	Art.number
M3	250	15020.030.001	M5	250	15020.050.001	M6	250	15020.060.001
M4	250	15020.040.001						

15080 KALEI Press nut Kh= 1,8 F01E

Thread	Metric thread	 	
Material	Stainless steel A1		
Class	6		
Surface treatment	Zinc plated		

d_1	☒	Art.number	d_1	☒	Art.number	d_1	☒	Art.number
M3	100	15080.030.001	M5	100	15080.050.001	M6	100	15080.060.001
M4	100	15080.040.001						

Round rivet bush

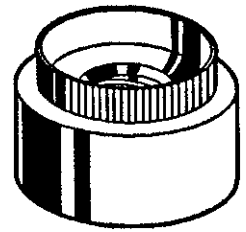
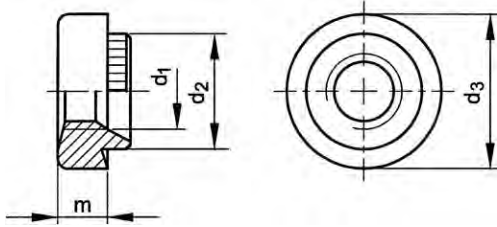

3

Technical Data

d ₁	d ₂	d ₃	Hole ø	m	P
M3	5.8	7.9	5.9	3.2	0.5
M4	6.9	9.5	6.95	3.8	0.7
M5	8.3	11.1	8.35	4.4	0.8
M6	9.6	12.7	9.65	5.7	1
M8	13	15.9	13.1	6.4	1.25
M10	15.4	19.1	15.5	7.6	1.5

12480 Round rivet bush

F01X

Thread	Metric thread
Material	Steel
Surface treatment	Zinc plated

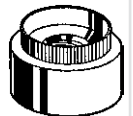

d ₁ - p	☒	Art.number	d ₁ - p	☒	Art.number	d ₁ - p	☒	Art.number
M3-1,0MM	250	12480.030.010	M4-3,0MM	250	12480.040.030	M6-2,5MM	250	12480.060.025
M3-1,5MM	250	12480.030.015	M5-1,0MM	250	12480.050.010	M6-3,0MM	250	12480.060.030
M3-1,8MM	250	12480.030.018	M5-1,5MM	250	12480.050.015	M6-4,0MM	250	12480.060.040
M3-2,5MM	250	12480.030.025	M5-2,0MM	250	12480.050.020	M8-1,5MM	250	12480.080.015
M4-1,0MM	250	12480.040.010	M5-2,5MM	250	12480.050.025	M8-2,0MM	250	12480.080.020
M4-1,5MM	250	12480.040.015	M5-3,0MM	250	12480.050.030	M8-2,5MM	250	12480.080.025
M4-2,0MM	250	12480.040.020	M6-1,5MM	250	12480.060.015	M8-3,0MM	250	12480.080.030
M4-2,5MM	250	12480.040.025	M6-2,0MM	250	12480.060.020	M10-3,0MM	100	12480.100.030

- p = material thickness = grip range.

Hexagon domed cap nut, high type

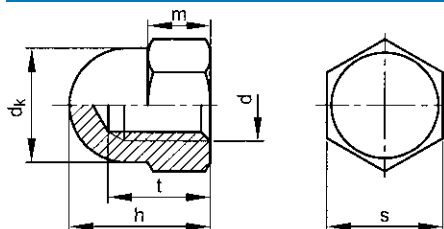

DIN 1587 (1987)
NEN 1618

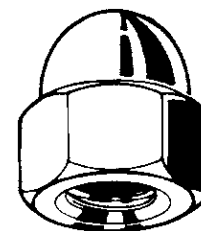

Technical Data

d	d _k (max.)	h	m (max.)	P	s	t
M3 (#DIN)	5	6.5	2.5	0.5	5.5	4.5
M4	6.5	8	3.2	0.7	7	5.5
M5	7.5	10	4	0.8	8	7.5
M6	9.5	12	5	1	10	8
M7 (#DIN)	9.5	12	5	1	10	8
M8	12.5	15	6.5	1.25	13	11
M10	16	18	8	1.5	17	13
M12	18	22	10	1.75	19	16
M14	21	25	11	2	22	18
M16	23	28	13	2	24	21
M18	26	32	15	2.5	27	25
M20	28	34	16	2.5	30	26
M22	31	39	18	2.5	32	29
M24	34	42	19	3	36	31
M27 (#DIN)	40	47	20	3	41	35
M30 (#DIN)	42	52	24	3.5	46	38

Article groups

Thread	Driving features	Material	Class	Surface treatment	Color	Code	Page
M	Hexagon	St	6			16500	3-97
M	Hexagon	St	6	Zipl		16510	3-97
M	Hexagon	St	6	Zipl blk p.		16516	3-98
M	Hexagon	St.St. A1	50			51400	3-98
M	Hexagon	St.St. A4	50			55400	3-98
M	Hexagon	St.St. A4	50		turned	55402	3-98
M	Hexagon	Br Cu3				47340	3-98
M	Hexagon	Br Cu3		Ni.pl.		47360	3-99
M	Hexagon	Plastic PA	PA 6.6		White	56250	3-99

16500 Hexagon domed cap nut, high type

F01H

Thread Metric thread
Material Steel
Class |6|



d	Art.number	d	Art.number	d	Art.number
M6	250 16500.060.001	M16	50 16500.160.001	M24	10 16500.240.001
M8	250 16500.080.001	M18	50 16500.180.001	M27	10 16500.270.001
M10	200 16500.100.001	M20	25 16500.200.001	M30	10 16500.300.001
M12	100 16500.120.001				

16510 Hexagon domed cap nut, high type

F01H

Thread Metric thread
Material Steel
Class |6|
Surface treatment Zinc plated

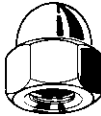

d	Art.number	d	Art.number	d	Art.number
M3	250 16510.030.001	M10	200 16510.100.001	M18	25 16510.180.001
M4	250 16510.040.001	M12	100 16510.120.001	M20	25 16510.200.001
M5	250 16510.050.001	M14	50 16510.140.001	M22	10 16510.220.001
M6	250 16510.060.001	M16	50 16510.160.001	M24	10 16510.240.001
M8	250 16510.080.001				

16516	Hexagon domed cap nut, high type		F01H
Thread	Metric thread		
Material	Steel		
Class	[6]		
Surface treatment	Zinc plated black passivated		

d	☒	Art.number	d	☒	Art.number	d	☒	Art.number
M5		250 16516.050.001	M6		250 16516.060.001	M8		250 16516.080.001

3

51400	Hexagon domed cap nut, high type		R09A
Thread	Metric thread		
Material	Stainless steel A1		
Class	50		



d	☒	Art.number	d	☒	Art.number	d	☒	Art.number
M3		100 51400.030.001	M10		50 51400.100.001	M22		5 51400.220.001
M4		100 51400.040.001	M12		25 51400.120.001	M24		5 51400.240.001
M5		100 51400.050.001	M14		10 51400.140.001	M27		3 51400.270.001
M6		100 51400.060.001	M16		10 51400.160.001	M30		1 51400.300.001
M7*		200 51400.070.001	M18		10 51400.180.001			
M8		50 51400.080.001	M20		5 51400.200.001			

• Depending on availability A1 can be supplied as well as A2.

55400	Hexagon domed cap nut, high type		R49A
Thread	Metric thread		
Material	Stainless steel A4		
Class	50		



d	☒	Art.number	d	☒	Art.number	d	☒	Art.number
M3		100 55400.030.001	M10		50 55400.100.001	M20		5 55400.200.001
M4		100 55400.040.001	M12		25 55400.120.001	M22		5 55400.220.001
M5		100 55400.050.001	M14		10 55400.140.001	M24		5 55400.240.001
M6		100 55400.060.001	M16		10 55400.160.001	M27		3 55400.270.001
M8		50 55400.080.001	M18		10 55400.180.001	M30		1 55400.300.001

55402	Hexagon domed cap nut turned		R49A
Thread	Metric thread		
Material	Stainless steel A4		
Class	50		

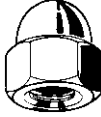

d	☒	Art.number	d	☒	Art.number	d	☒	Art.number
M5*		100 55402.050.001	M18*		25 55402.180.001	M24*		10 55402.240.001
M6*		100 55402.060.001						

47340	Hexagon domed cap nut, high type		M11C
Thread	Metric thread		
Material	Brass Cu3		

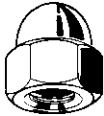

d	☒	Art.number	d	☒	Art.number	d	☒	Art.number
M3		500 47340.030.001	M8		100 47340.080.001	M16		10 47340.160.001
M4		200 47340.040.001	M10		50 47340.100.001	M20		10 47340.200.001
M5		200 47340.050.001	M12		25 47340.120.001	M24		5 47340.240.001
M6		200 47340.060.001	M14		25 47340.140.001			

47360	Hexagon domed cap nut, high type		M11C
Thread	Metric thread		
Material	Brass Cu3		
Surface treatment	Nickel plated		
			

d	☒	Art.number	d	☒	Art.number	d	☒	Art.number
M3	500	47360.030.001	M6	200	47360.060.001	M12	25	47360.120.001
M4	200	47360.040.001	M8	100	47360.080.001	M16	10	47360.160.001
M5	200	47360.050.001	M10	50	47360.100.001	M20	10	47360.200.001

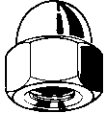
56250	Hexagon domed cap nut, high type plastic		W02A	
Thread	Metric thread			
Material	Plastic Polyamide (nylon)			
Class	PA 6.6			
Color	White			
			DIN	≈1587 (1987)
			NEN	≈1618
			NF	≈E27-453

d	☒	Art.number	d	☒	Art.number	d	☒	Art.number
M3	100	56250.030.001	M5	100	56250.050.001	M8	50	56250.080.001
M4	100	56250.040.001	M6	100	56250.060.001	M10	50	56250.100.001

Hexagon domed cap nut BSW



Technical Data				Technical Data			
d	h	s	Threads per inch	d	h	s	Threads per inch
1/4	12	11	20	5/8	32	27	11
5/16	15	13	18	3/4	39	32	10
1/2	25	22	12	7/8	42	36	9

- Whitworth thread (BSW/BSF) is not internationally recommended.
- It is advised to use metric (M/MF) or unified threads (UNC/UNF).

16540	Hexagon domed cap nut BSW		X08A
Thread	British Standard Whitworth		
Material	Steel		
Class	6		
			

d	☒	Art.number	d	☒	Art.number	d	☒	Art.number
1/4	200	16540.063.001	1/2	25	16540.127.001	3/4	10	16540.191.001
5/16	100	16540.079.001	5/8	10	16540.158.001	7/8	10	16540.222.001

Hexagon domed cap nut with welded cap ≈ DIN 1587

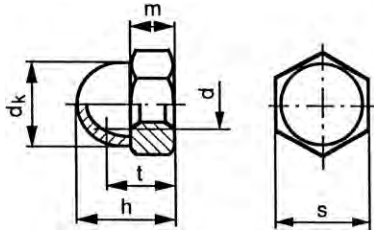

3

Technical Data

d	dk (max.)	h	m (max.)	P	s	t
M3	5	6.5	2.5	0.5	5.5	3
M4	6.5	6.5	3.2	0.7	7	4
M5	7.5	10	4	0.8	8	8
M6	9.5	12	5	1	10	10
M8	12.5	15	6.5	1.25	13	13
M10	16	18	8	1.5	16	15
M12	18	22	10	1.75	18	19
M16	23	28	13	2	24	26
M20	28	34	16	2.5	30	31

16300 Hexagon domed cap nut, high type with welded cap

F01H

Thread Metric thread
Material Steel
Class [6]
Surface treatment Chrome plated



d	☒	Art.number	d	☒	Art.number	d	☒	Art.number
M3	250	16300.030.001	M6	200	16300.060.001	M12	50	16300.120.001
M4	200	16300.040.001	M8	200	16300.080.001	M16	25	16300.160.001
M5	200	16300.050.001	M10	100	16300.100.001	M20	10	16300.200.001

Hexagon cap nut low type

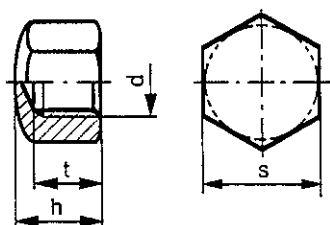

DIN 917
ISO 1617

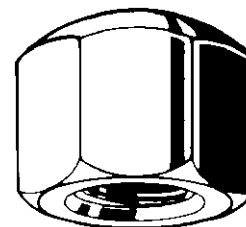

Technical Data

d	h	P	s	t (min.)
M3 (#DIN)	4.5	0.5	5.5	3.5
M4	5.5	0.7	7	4.16
M5	7	0.8	8	4.96
M6	9	1	10	6.71
M8	12	1.25	13	9.21
M10	14	1.5	16	10.65
M12	16	1.75	18	13.15
M14	18	2	21	14.65
M16	20	2	24	16.65
M18	22	2.5	27	18.58
M20	25	2.5	30	20.58
M22	28	2.5	34	21.58
M24	30	3	36	23.58
M27	32	3	41	25.58
M30	34	3.5	46	27.58

Article groups

Thread	Driving features	Material	Class	Surface treatment	Code	Page
M	Hexagon	St	[6]	Zipl	16410	3-101
M	Hexagon	St.St. A1	50		51380	3-101
M	Hexagon	St.St. A4	50		55380	3-102
M	Hexagon	Br Cu3			47300	3-102

16410 Hexagon cap nut low type

F01H

Thread Metric thread
Material Steel
Class [6]
Surface treatment Zinc plated

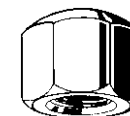

d	Art.number	d	Art.number	d	Art.number
M4	250 16410.040.001	M8	250 16410.080.001	M16	50 16410.160.001
M5	250 16410.050.001	M10	200 16410.100.001	M20	25 16410.200.001
M6	250 16410.060.001	M12	100 16410.120.001	M24	10 16410.240.001

51380 Hexagon cap nut low type

R09A

Thread Metric thread
Material Stainless steel A1
Class 50



d	Art.number	d	Art.number	d	Art.number
M3	200 51380.030.001	M10	50 51380.100.001	M20	5 51380.200.001
M4	100 51380.040.001	M12	25 51380.120.001	M22*	25 51380.220.001
M5	100 51380.050.001	M14*	50 51380.140.001	M24*	10 51380.240.001
M6	100 51380.060.001	M16	10 51380.160.001	M27*	10 51380.270.001
M8	50 51380.080.001	M18*	50 51380.180.001	M30*	10 51380.300.001

* Depending on availability A1 can be supplied as well as A2.

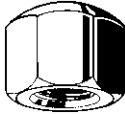
55380	Hexagon cap nut low type		R49A
Thread	Metric thread		 
Material	Stainless steel A4		
Class	50		

d	☒	Art.number	d	☒	Art.number	d	☒	Art.number
M4	100	55380.040.001	M10	50	55380.100.001	M20	5	55380.200.001
M5	100	55380.050.001	M12	25	55380.120.001	M24	5	55380.240.001
M6	100	55380.060.001	M14*	50	55380.140.001	M27	1	55380.270.001
M8	50	55380.080.001	M16	10	55380.160.001	M30*	10	55380.300.001

47300	Hexagon cap nut low type		M11C
Thread	Metric thread		 
Material	Brass Cu3		
Class			

d	☒	Art.number	d	☒	Art.number	d	☒	Art.number
M3	200	47300.030.001	M8	100	47300.080.001	M14	25	47300.140.001
M4	200	47300.040.001	M10	50	47300.100.001	M16	10	47300.160.001
M5	200	47300.050.001	M12	25	47300.120.001	M20	10	47300.200.001
M6	200	47300.060.001						

Prevailing torque type hexagon domed cap nut with non-metallic insert

DIN 986

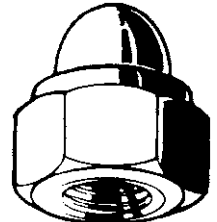
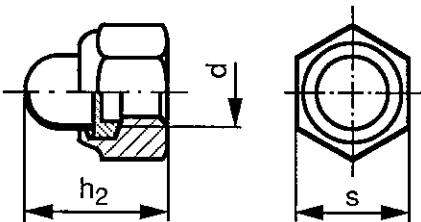



Technical Data



d	h ₂	P	s	d	h ₂	P	s
M4	9.6	0.7	7	M10	18.1	1.5	16
M5	10.5	0.8	8	M12	22.5	1.75	18
M6	12	1	10	M16	27.5	2	24
M8	14	1.25	13	M20	35	2.5	30

Article groups

Thread	Driving features	Material	Class	Surface treatment	Code	Page
M	Hexagon	St	≥ 6	Zipl	16450	3-102
M	Hexagon	St.St. A2			51405	3-103

16450	Prevailing torque type hexagon domed cap nut with non-metallic insert		F01H
Thread	Metric thread		 
Material	Steel		
Class	≥ 6		
Surface treatment	Zinc plated		

d	☒	Art.number	d	☒	Art.number	d	☒	Art.number
M4	250	16450.040.001	M8	200	16450.080.001	M16	50	16450.160.001
M5	200	16450.050.001	M10	200	16450.100.001	M20	25	16450.200.001
M6	200	16450.060.001	M12	100	16450.120.001			

51405	Prevailing torque type hexagon domed cap nut with non-metallic insert	R09A
Thread	Metric thread	
Material	Stainless steel A2	
		
		

d	☒	Art.number	d	☒	Art.number	d	☒	Art.number
M4	100	51405.040.001	M8	50	51405.080.001	M12	25	51405.120.001
M5	100	51405.050.001	M10	50	51405.100.001	M16*	50	51405.160.001
M6	100	51405.060.001						

Wing nut (American) type



Technical Data				
d	e ≈	h ≈	m ≈	P
M3	18.5	8.8	3	0.5
M4	18.5	8.8	3	0.7
M5	22	10.5	4	0.8
M6	26.8	12.9	4.9	1
M8	30.3	14.8	5.4	1.25
M10	35.3	17.3	6.3	1.5
M12	47.5	22.5	7.9	1.75
M14	65	30.8	10.6	2
M16	65	30.8	10.6	2
M20	66.5	31.2	12.2	2.5

Article groups						
Thread	Driving features	Material	Class	Surface treatment	Code	Page
M	Wing	St	04	Zipl	16250	3-103
M	Wing	St.St. A2			51810	3-103
M	Wing	St.St. A4			55810	3-104

16250	Wing nut (American) type	F01X
Thread	Metric thread	
Material	Steel	
Class	04	
Surface treatment	Zinc plated	
		
		

d	☒	Art.number	d	☒	Art.number	d	☒	Art.number
M3	250	16250.030.001	M6	250	16250.060.001	M12	50	16250.120.001
M4	250	16250.040.001	M8	100	16250.080.001	M16	25	16250.160.001
M5	250	16250.050.001	M10	100	16250.100.001	M20	10	16250.200.001

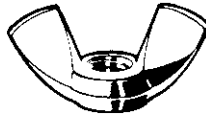
51810	Wing nut (American) type	R09A
Thread	Metric thread	
Material	Stainless steel A2	
		
		

d	☒	Art.number	d	☒	Art.number	d	☒	Art.number
M3	100	51810.030.001	M8	50	51810.080.001	M14	5	51810.140.001
M4	100	51810.040.001	M10	25	51810.100.001	M16	5	51810.160.001
M5	100	51810.050.001	M12	10	51810.120.001	M20	3	51810.200.001
M6	50	51810.060.001						

55810	Wing nut (American) type	R49A
Thread	Metric thread	
Material	Stainless steel A4	
		 

d	☒	Art.number	d	☒	Art.number	d	☒	Art.number
M3	100	55810.030.001	M6	50	55810.060.001	M12	10	55810.120.001
M4	100	55810.040.001	M8	50	55810.080.001	M14*	50	55810.140.001
M5	100	55810.050.001	M10	25	55810.100.001	M16	5	55810.160.001

3

Wing nut rounded wings

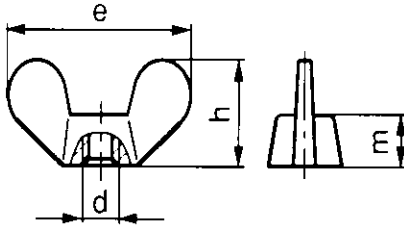

DIN 315
NEN 1625

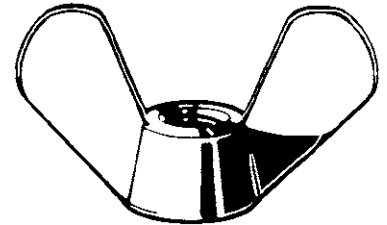

Technical Data



d	e (max.)	h (max.)	m (min.)	P
M3 (#DIN)	17.6	8.6	2.9	0.5
M4	20	10.5	3.2	0.7
M5	26	13	4	0.8
M6	33	17	5	1
M8	39	20	6.5	1.25
M10	51	25	8	1.5
M12	65	33.5	10	1.75
M14 (#DIN)	65	33.5	11.2	2
M16	73	37.5	13	2
M20	90	46.5	16	2.5
M24	110	56.5	20	3

Article groups

Thread	Driving features	Material	Surface treatment	Code	Page
M	Wing	CI		16260	3-104
M	Wing	CI	Zipl	16270	3-104
M	Wing	St.St. A2		51800	3-105
M	Wing	St.St. A4		55800	3-105
M	Wing	Br		47550	3-105
M	Wing	Br	Ni.pl.	47560	3-105

16260	Wing nut rounded wings	F01X
Thread	Metric thread	
Material	Cast iron	
		 

d	☒	Art.number	d	☒	Art.number	d	☒	Art.number
M6	200	16260.060.001	M10	100	16260.100.001	M12	50	16260.120.001
M8	100	16260.080.001						

16270	Wing nut rounded wings	F01X
Thread	Metric thread	
Material	Cast iron	
Surface treatment	Zinc plated	
		 

d	☒	Art.number	d	☒	Art.number	d	☒	Art.number
M4	250	16270.040.001	M8	100	16270.080.001	M14	50	16270.140.001
M5	250	16270.050.001	M10	100	16270.100.001	M16	20	16270.160.001
M6	200	16270.060.001	M12	50	16270.120.001	M20	10	16270.200.001

16270 Wing nut rounded wings

d	⊗	Art.number
M24	5	16270.240.001

51800 Wing nut rounded wings Q01A

Thread	Metric thread	
Material	Stainless steel A2	
		

d	⊗	Art.number	d	⊗	Art.number	d	⊗	Art.number
M4*	50	51800.040.001	M8	25	51800.080.001	M14*	10	51800.140.001
M5*	50	51800.050.001	M10	25	51800.100.001	M16*	10	51800.160.001
M6	50	51800.060.001	M12	25	51800.120.001			

55800 Wing nut rounded wings Q41A

Thread	Metric thread	
Material	Stainless steel A4	
		

d	⊗	Art.number	d	⊗	Art.number	d	⊗	Art.number
M4*	50	55800.040.001	M8*	50	55800.080.001	M14*	10	55800.140.001
M5*	50	55800.050.001	M10*	50	55800.100.001	M16*	10	55800.160.001
M6*	50	55800.060.001	M12*	25	55800.120.001			

47550 Wing nut rounded wings M11D

Thread	Metric thread	
Material	Brass	
		

d	⊗	Art.number	d	⊗	Art.number	d	⊗	Art.number
M3	250	47550.030.001	M8	100	47550.080.001	M16	20	47550.160.001
M4	250	47550.040.001	M10	100	47550.100.001	M20	10	47550.200.001
M5	250	47550.050.001	M12	50	47550.120.001	M24	5	47550.240.001
M6	200	47550.060.001	M14	50	47550.140.001			

47560 Wing nut rounded wings M11D

Thread	Metric thread	
Material	Brass	
Surface treatment	Nickel plated	
		

d	⊗	Art.number	d	⊗	Art.number	d	⊗	Art.number
M4	250	47560.040.001	M8	100	47560.080.001	M12	50	47560.120.001
M5	250	47560.050.001	M10	100	47560.100.001	M16	20	47560.160.001
M6	200	47560.060.001						

Wing nut BSW

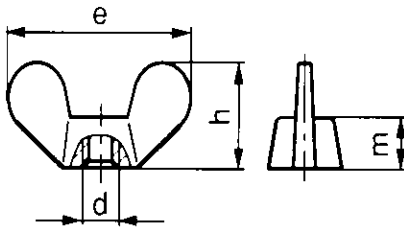

DIN ≈313 (1956)
NEN ≈2324 (1960)



3

Technical Data

d	e	h	m	Threads per inch
1/8 (#DIN)	17.6	8.6	2.9	40
5/32 (#DIN)	20	10.5	3.2	32
3/16 (#DIN)	26	13	4	24
1/4	33	17	5	20
5/16	39	20	6.5	18
3/8	51	25	8	16
1/2	65	33.5	10	12
5/8	73	37.5	13	11

- Whitworth thread (BSW/BSF) is not internationally recommended. It is advised to use metric (M/MF) or unified threads (UNC/UNF).
- Depending on availability the dimensions may deviate.
- The 1/8 inch wing nuts are the light American type.

Article groups

Thread	Driving features	Material	Code	Page
BSW	Wing	CI	16280	3-106
BSW	Wing	Br Cu2	47570	3-106

16280 Wing nut BSW

X08A

Thread British Standard Whitworth
Material Cast iron



d	Art.number	d	Art.number	d	Art.number
1/8	250 16280.031.001	1/4	200 16280.063.001	1/2	50 16280.127.001
5/32	250 16280.039.001	5/16	100 16280.079.001	5/8	20 16280.158.001
3/16	250 16280.047.001	3/8	100 16280.096.001		

47570 Wing nut BSW

X08A

Thread British Standard Whitworth
Material Brass Cu2



d	Art.number	d	Art.number	d	Art.number
5/32	250 47570.039.001	1/4	200 47570.063.001	3/8	100 47570.096.001
3/16	250 47570.047.001	5/16	100 47570.079.001		

Toggle nut

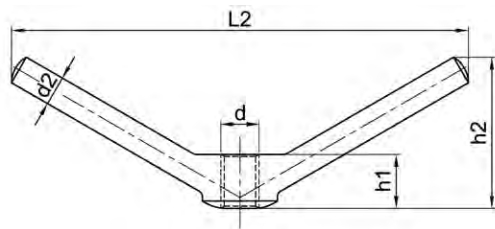

DIN 80701



Technical Data

d (h11)	d ₂	h ₁	h ₂	L ₂	P
M16	16	25	75	240	2
M20	16	25	75	240	2.5
M24	16	25	75	240	3

55792 Toggle nut

R49A

Thread Metric thread
Material Stainless steel A4
Class 50



d	☒	Art.number	d	☒	Art.number	d	☒	Art.number
M16*	5	55792.160.001	M20*	5	55792.200.001	M24*	5	55792.240.001

Bow nut

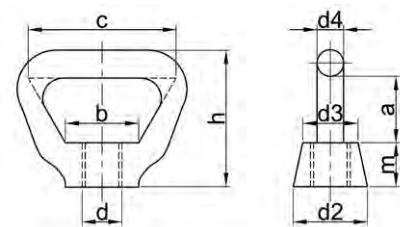

DIN 80704



Technical Data

a	a	b	c	d ₂	d ₃	d ₄	h	m	P
M6	15	14	25	14	11.5	5	28	8	1.00
M8	20	18	32	18	15	6.5	36	10	1.25
M10	25	23	42	23	19	8	50	10	1.50
M12	27	27	48	24	20	10	52	15	1.75
M16	29	32	56	30	24	12	59	18	2.00
M20	32	36	64	36	28	13	66	21	2.50
M24	36	45	75	45	36	14	75	25	3.00

55793 Bow nut

R49A

Thread Metric thread
Material Stainless steel A4
Class 50



d	☒	Art.number	d	☒	Art.number	d	☒	Art.number
M6*	10	55793.060.001	M12*	5	55793.120.001	M20*	5	55793.200.001
M8*	10	55793.080.001	M16*	5	55793.160.001	M24*	5	55793.240.001
M10*	10	55793.100.001						

Wing nut with collar

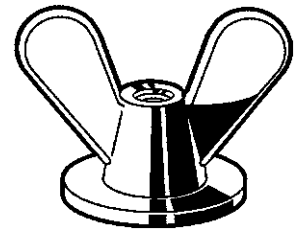
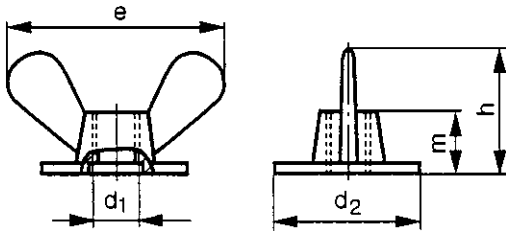

3

Technical Data

d ₁	d ₂	e	h	m	P
M5	24	35	24	14	0.8
M6	24	35	24	14	1
M8	24	35	24	14	1.25

56290 Wing nut with collar plastic

W02A

Thread Metric thread
Material Plastic Polyamide (nylon)
Class PA 6.6
Color White

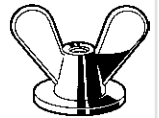

d ₁	☒	Art.number	d ₁	☒	Art.number	d ₁	☒	Art.number
M5	100	56290.050.001	M6	50	56290.060.001	M8	50	56290.080.001

Wing nut plastic

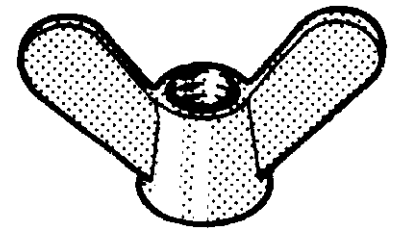
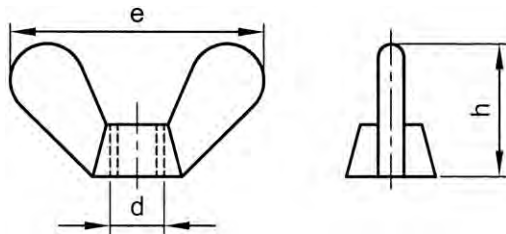

Technical Data

d	e	h	m	P
M4	35	22	6	0.7
M5	35	22	6	0.8
M6	35	22	6	1
M8	35	22	14	1.25
M10	41	25	17	1.5

56280 Wing nut plastic

W02A

Thread Metric thread
Material Plastic Polyamide (nylon)
Class PA 6.6
Color White

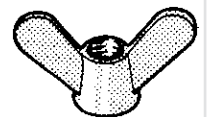

d	☒	Art.number	d	☒	Art.number	d	☒	Art.number
M4	100	56280.040.001	M6	50	56280.060.001	M10	25	56280.100.001
M5	100	56280.050.001	M8	50	56280.080.001			

Hexagon weld nut

DIN 929

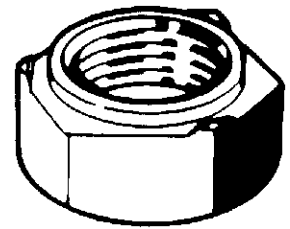
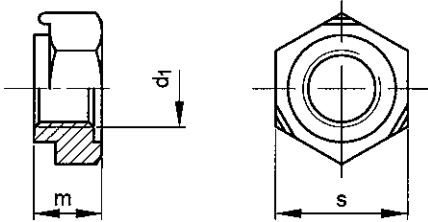

Technical Data

d ₁	Hole ø (H11)	m (h14)	P	s (h13)
M3	4.5	3	0.5	7.5
M4	6	3.5	0.7	9
M5	7	4	0.8	10
M6	8	5	1	11
M8	10.5	6.5	1.25	14
M10	12.5	8	1.5	17
M12	14.8	10	1.75	19
M14	16.8	11	2	22
M16	18.8	13	2	24

Article groups

Thread	Driving features	Material	Code	Page
M	Hexagon	St Max. 0,25%C	14020	3-109
M	Hexagon	St.St. A2	51180	3-109
M	Hexagon	St.St. A4	55180	3-109

14020 Hexagon weld nut		F01F
Thread	Metric thread	
Material	Steel Max. 0,25%C	
		

d ₁	⊗	Art.number	d ₁	⊗	Art.number	d ₁	⊗	Art.number
M3	1000	14020.030.001	M6	1000	14020.060.001	M12	100	14020.120.001
M4	1000	14020.040.001	M8	1000	14020.080.001	M14	100	14020.140.001
M5	1000	14020.050.001	M10	500	14020.100.001	M16	100	14020.160.001

- These weld nuts can be used with bolts class < 8.8.

51180 Hexagon weld nut		R09A
Thread	Metric thread	
Material	Stainless steel A2	
		

d ₁	⊗	Art.number	d ₁	⊗	Art.number	d ₁	⊗	Art.number
M3	100	51180.030.001	M6	100	51180.060.001	M12	25	51180.120.001
M4	100	51180.040.001	M8	50	51180.080.001	M16	25	51180.160.001
M5	100	51180.050.001	M10	50	51180.100.001			

55180 Hexagon weld nut		R49A
Thread	Metric thread	
Material	Stainless steel A4	
		

d ₁	⊗	Art.number	d ₁	⊗	Art.number	d ₁	⊗	Art.number
M3	100	55180.030.001	M6	100	55180.060.001	M12	25	55180.120.001
M4	100	55180.040.001	M8	50	55180.080.001	M16	25	55180.160.001
M5	100	55180.050.001	M10	50	55180.100.001			

Weld nut with smooth flange

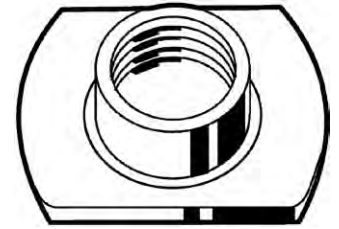
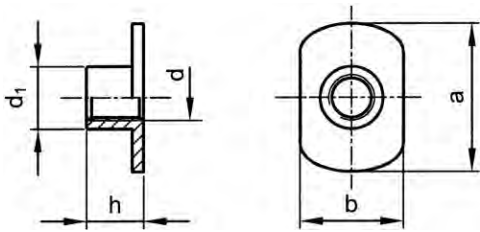

3

Technical Data

d x a	a	b	d ₁	h	P
M3X17	17	9	4.6	5	0.5
M4X17	17	9	5	6	0.7
M5X19	19	11	6.4	7.5	0.8
M6X19	19	14	7.7	8.5	1
M6X22	22	14	7.7	8.5	1
M8X22	22	18	10.1	10	1.25
M8X26	26	18	10.1	10	1.25
M10X26	26	18	11.9	10.5	1.5

Article groups

Thread	Material	Code	Page
M	St	14230	3-110
M	St.St. A2	51182	3-110

14230	Weld nut with smooth flange	F01F
Thread	Metric thread	
Material	Steel	
		

d x a	Art.number	d x a	Art.number	d x a	Art.number
M4X17	1000 14230.040.001	M6X22	1000 14230.060.001	M10X26	500 14230.100.001
M5X19	1000 14230.050.001	M8X26	1000 14230.080.001		

51182	Weld nut with smooth flange	R09A
Thread	Metric thread	
Material	Stainless steel A2	
		

d x a	Art.number	d x a	Art.number	d x a	Art.number
M3X17*	100 51182.030.017	M6X19*	100 51182.060.019	M8X26*	100 51182.080.026
M4X17*	100 51182.040.017	M6X22*	100 51182.060.022	M10X26*	100 51182.100.026
M5X19*	100 51182.050.019	M8X22*	100 51182.080.022		

Spot weld nut

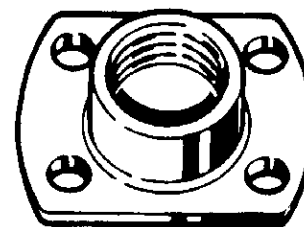
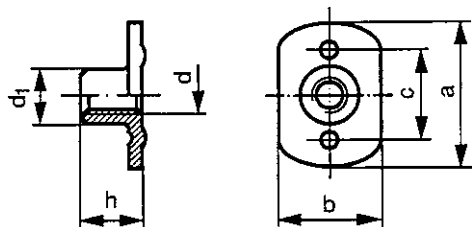

Technical Data

d x d ₁	a	b	c	h	Number of welding spots	P
M4X4.9	17	9	12	6	2	0.7
M4X5	17	9	12	6	2	0.7
M5X6.1	19	11	13	7.5	2	0.8
M5X6.4	19	11	14	7.5	2	0.8
M6X7.5	22	14	14	8.5	4	1
M6X7.7	22	14	16	8.5	2	1
M8X9.7	26	18	16	11	4	1.25
M8X10.1	26	18	16	10	4	1.25
M10X11.5	26	18	16	10.5	4	1.5
M10X11.9	26	18	16	10.5	4	1.5

Article groups

Thread	Material	Surface treatment	Code	Page
M	St		14200	3-111
M	St	Zipl	14210	3-111
M	St.St. A2		51183	3-111

14200 Spot weld nut

F01F

Thread Metric thread
Material Steel

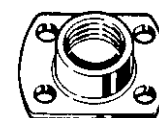

d x d ₁	Art.number	d x d ₁	Art.number	d x d ₁	Art.number
M4X5	1000 14200.040.001	M6X7,7	1000 14200.060.001	M10X11,9	500 14200.100.001
M5X6,4	1000 14200.050.001	M8X10,1	1000 14200.080.001		

14210 Spot weld nut

F01F

Thread Metric thread
Material Steel
Surface treatment Zinc plated

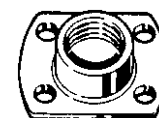

d x d ₁	Art.number	d x d ₁	Art.number	d x d ₁	Art.number
M5x6,4	1000 14210.050.001	M8x10,1	1000 14210.080.001	M10x11,9	500 14210.100.001
M6x7,7	1000 14210.060.001				

51183 Spot weld nut

R09A

Thread Metric thread
Material Stainless steel A2

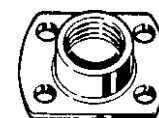

d x d ₁	Art.number	d x d ₁	Art.number	d x d ₁	Art.number
M4x4,9	250 51183.040.001	M6x7,5	250 51183.060.001	M10x11,5	100 51183.100.001
M5x6,1	250 51183.050.001	M8x9,7	250 51183.080.001		

Square weld nut

DIN 928

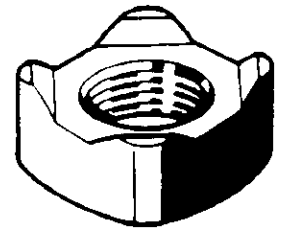
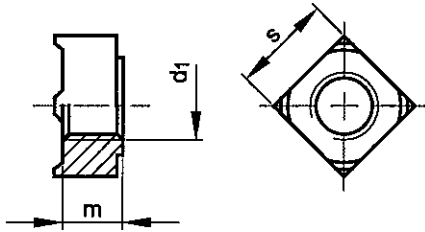

3

Technical Data

d ₁	Hole ø (H11)	m (h14)	P	s (h14)
M4	6	3.5	0.7	7
M5	7	4.2	0.8	9
M5 (#DIN)	7	4.2	0.8	8
M6	8	5	1	10
M8	10.5	6.5	1.25	14
M10	12.5	8	1.5	17
M12	14.8	9.5	1.75	19
M14	16.8	11.4	2	22

Article groups

Thread	Driving features	Material	Code	Page
M	Square	St Max. 0,25%C	14000	3-112
M	Square	St.St. A2	51178	3-112
M	Square	St.St. A4	55178	3-112

14000 Square weld nut

F01F

Thread Metric thread
Material Steel Max. 0,25%C



d ₁	Art.number	d ₁	Art.number	d ₁	Art.number
M4	1000 14000.040.001	M8	1000 14000.080.001	M12	100 14000.120.001
M5	1000 14000.050.001	M10	500 14000.100.001	M14	100 14000.140.001
M6	1000 14000.060.001				

• These weld nuts can be used with bolts class < 8.8.

51178 Square weld nut

R09A

Thread Metric thread
Material Stainless steel A2



d ₁	Art.number	d ₁	Art.number	d ₁	Art.number
M5	100 51178.050.001	M6	100 51178.060.001	M8	50 51178.080.001

55178 Square weld nut

R49A

Thread Metric thread
Material Stainless steel A4



d	Art.number	d	Art.number	d	Art.number
M5*	200 55178.050.001	M6*	200 55178.060.001	M8*	200 55178.080.001

Knurled thumb nut high type

DIN 466

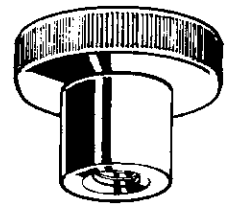
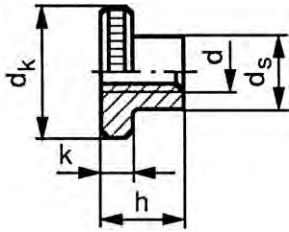

Technical Data

d	dk	ds	h	k	P
M2	9	4.5	5.3	2	0.4
M3	12	6	7.5	2.5	0.5
M4	16	8	9.5	3.5	0.7
M5	20	10	11.5	4	0.8
M6	24	12	15	5	1
M8	30	16	18	6	1.25
M10	36	20	23	8	1.5

Article groups

Thread	Material	Class	Surface treatment	Code	Page
M	St	5	Zipl	16680	3-113
M	St.St. A1	50		51830	3-113
M	Br Cu3			47500	3-113

16680 Knurled thumb nut high type

F01X

Thread Metric thread
Material Steel
Class |5|
Surface treatment Zinc plated



d	Art.number	d	Art.number	d	Art.number
M3	100 16680.030.001	M5	50 16680.050.001	M8	25 16680.080.001
M4	50 16680.040.001	M6	25 16680.060.001	M10	10 16680.100.001

51830 Knurled thumb nut high type

R09A

Thread Metric thread
Material Stainless steel A1
Class 50



d	Art.number	d	Art.number	d	Art.number
M2*	100 51830.020.001	M5	25 51830.050.001	M8	10 51830.080.001
M3	50 51830.030.001	M6	10 51830.060.001	M10	5 51830.100.001
M4	25 51830.040.001				

47500 Knurled thumb nut high type

M11D

Thread Metric thread
Material Brass Cu3



d	Art.number	d	Art.number	d	Art.number
M3	100 47500.030.001	M5	50 47500.050.001	M8	25 47500.080.001
M4	50 47500.040.001	M6	25 47500.060.001	M10	10 47500.100.001

Knurled thumb nut thin type

DIN 467

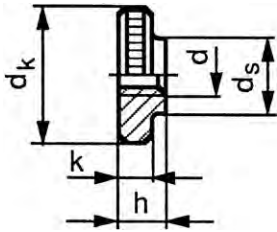

3

Technical Data

d	dk	ds	h	k	P
M3	12	6	3	2.5	0.5
M4	16	8	4	3.5	0.7
M5	20	10	5	4	0.8
M6	24	12	6	5	1
M8	30	16	8	6	1.25
M10	36	20	10	8	1.5

Article groups

Thread	Material	Class	Surface treatment	Code	Page
M	St	5	Zipl	16690	3-114
M	St.St. A1	50		51840	3-114
M	Br Cu3			47510	3-114
M	Br Cu3		Ni.pl.	47511	3-115

16690 Knurled thumb nut thin type F01X

Thread: Metric thread
 Material: Steel
 Class: |5|
 Surface treatment: Zinc plated

d	Art.number	d	Art.number	d	Art.number
M3	100 16690.030.001	M5	50 16690.050.001	M8	25 16690.080.001
M4	50 16690.040.001	M6	25 16690.060.001	M10	10 16690.100.001

51840 Knurled thumb nut thin type R09A

Thread: Metric thread
 Material: Stainless steel A1
 Class: 50

d	Art.number	d	Art.number	d	Art.number
M3	50 51840.030.001	M5	25 51840.050.001	M8	10 51840.080.001
M4	25 51840.040.001	M6	10 51840.060.001	M10	5 51840.100.001

47510 Knurled thumb nut thin type M11D

Thread: Metric thread
 Material: Brass Cu3

d	Art.number	d	Art.number	d	Art.number
M3	100 47510.030.001	M5	50 47510.050.001	M8	25 47510.080.001
M4	100 47510.040.001	M6	50 47510.060.001	M10	25 47510.100.001

47511 Knurled thumb nut thin type		M01D
Thread	Metric thread	
Material	Brass Cu3	
Surface treatment	Nickel plated	

d	☒	Art.number	d	☒	Art.number	d	☒	Art.number
M3	100	47511.030.001	M5	50	47511.050.001	M8	25	47511.080.001
M4	100	47511.040.001	M6	50	47511.060.001	M10	25	47511.100.001

Knurled thumb nut

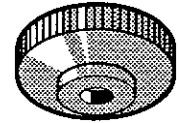
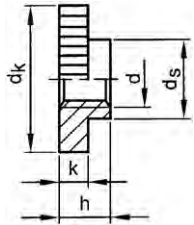

Technical Data					
d	dk	ds	h	k	P
M4	16	10	6	4.6	0.7
M5	16	10	6	4.6	0.8
M6	16	10	6	4.6	1

56240 Knurled thumb nut plastic		W02A
Thread	Metric thread	
Material	Plastic Polyamide (nylon)	
Class	PA 6.6	
Color	White	

d	☒	Art.number	d	☒	Art.number	d	☒	Art.number
M4	100	56240.040.001	M5	100	56240.050.001	M6	50	56240.060.001

Square thin nut

DIN 562

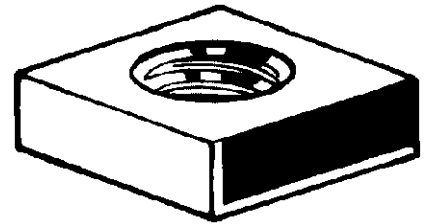
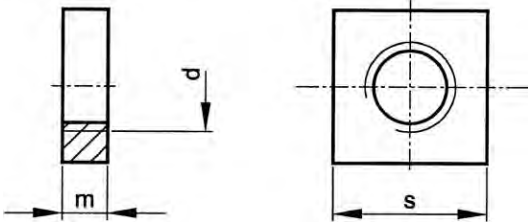

3

Technical Data

d	m	P	s
M2	1.2	0.4	4
M2.5	1.6	0.45	5
M3	1.8	0.5	5.5
M4	2.2	0.7	7
M5	2.7	0.8	8
M6	3.2	1	10
M8	4	1.25	13
M10	5	1.5	16

Article groups

Thread	Driving features	Material	Class	Surface treatment	Code	Page
M	Square	St	04	Zipl	24769	3-116
M	Square	St	04	Zipl	24770	3-116
M	Square	St.St. A2			51095	3-116
M	Square	St.St. A4			55095	3-117

24769 Square thin nut F01X

Thread Metric thread
Material Steel
Class 04
Surface treatment Zinc plated

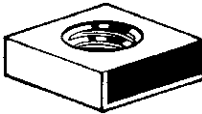
d	Art.number	d	Art.number	d	Art.number
M3	250 24769.030.001	M5	250 24769.050.001	M8	250 24769.080.001
M4	250 24769.040.001	M6	250 24769.060.001	M10	250 24769.100.001

24770 Square thin nut F01X

Thread Metric thread
Material Steel
Class 04
Surface treatment Zinc plated



d	Art.number	d	Art.number	d	Art.number
M3	2500 24770.030.001	M5	2500 24770.050.001	M8	1000 24770.080.001
M4	2500 24770.040.001	M6	2500 24770.060.001	M10	500 24770.100.001

51095 Square thin nut R09A

Thread Metric thread
Material Stainless steel A2





d	Art.number	d	Art.number	d	Art.number
M2*	500 51095.020.001	M4	250 51095.040.001	M8	250 51095.080.001
M2.5*	500 51095.025.001	M5	250 51095.050.001	M10*	100 51095.100.001
M3	250 51095.030.001	M6	250 51095.060.001		

55095	Square thin nut	R49A
Thread	Metric thread	
Material	Stainless steel A4	

d	☒	Art.number	d	☒	Art.number	d	☒	Art.number
M3	250	55095.030.001	M5	250	55095.050.001	M8	250	55095.080.001
M4	250	55095.040.001	M6	250	55095.060.001	M10*	100	55095.100.001

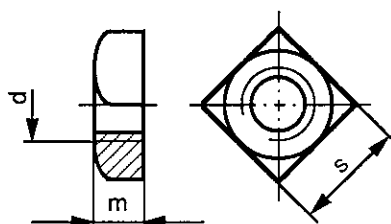
Square nut



DIN 557
NF E25-404

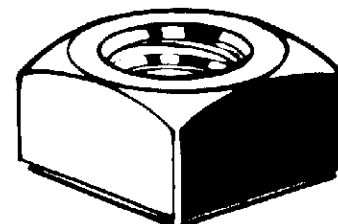

Technical Data

d	m (h15)	P	s
M4 (#DIN)	3.2	0.7	7
M5	4	0.8	8
M6	5	1	10
M8	6.5	1.25	13
M10	8	1.5	17
M12	10	1.75	19

Article groups

Thread	Driving features	Material	Class	Surface treatment	Code	Page
M	Square	St	≥5		11120	3-117
M	Square	St	≥5	Zipl	11140	3-117
M	Square	St.St. A2			51088	3-118
M	Square	St.St. A4			55088	3-118





11120	Square nut	F01A
Thread	Metric thread	
Material	Steel	
Class	≥5	



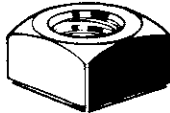

d	☒	Art.number	d	☒	Art.number	d	☒	Art.number
M4	250	11120.040.001	M6	250	11120.060.001	M10	250	11120.100.001
M5	250	11120.050.001	M8	250	11120.080.001	M12	100	11120.120.001

11140	Square nut	F01A
Thread	Metric thread	
Material	Steel	
Class	≥5	
Surface treatment	Zinc plated	

d	☒	Art.number	d	☒	Art.number	d	☒	Art.number
M4	250	11140.040.001	M6	250	11140.060.001	M10	250	11140.100.001
M5	250	11140.050.001	M8	250	11140.080.001	M12	100	11140.120.001

3



51088		Square nut				R09A		
Thread		Metric thread						
Material		Stainless steel A2						
								
d		Art.number	d		Art.number	d		Art.number
M5	200	51088.050.001	M8*	200	51088.080.001	M12*	100	51088.120.001
M6*	200	51088.060.001	M10*	100	51088.100.001	M16*	100	51088.160.001

55088		Square nut				R49A		
Thread		Metric thread						
Material		Stainless steel A4						
								
d		Art.number	d		Art.number	d		Art.number
M5	200	55088.050.001	M8	100	55088.080.001	M12*	100	55088.120.001
M6	200	55088.060.001	M10	100	55088.100.001	M16*	100	55088.160.001

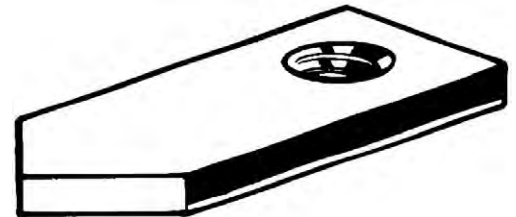
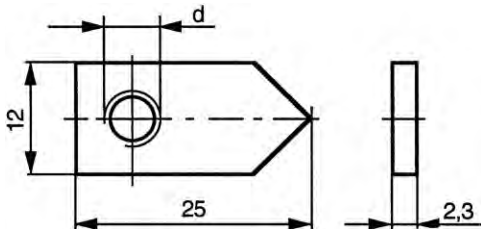
Pointed nut



• Application in combination with double slotted mushroom head screws in boxes and cabinets.

24700		Pointed nut				F01X	
Thread		Metric thread					
Material		Steel					
Surface treatment		Zinc plated					
d x P		Art.number					
M6X1	1000	24700.060.001					

Speednuts type SMG

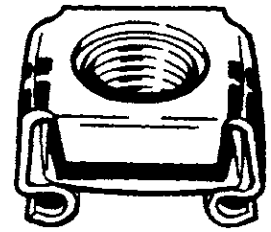
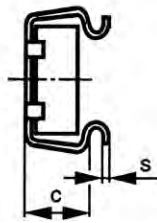
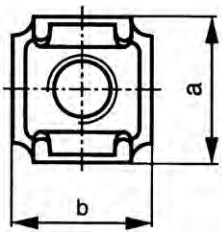

Technical Data

Type	a	b	c	For screw	g (tol. - 0,2mm)	Material thickness	r	s
M4-A	13.5	13.2	6	M4	9.5	0.7-1.6	0.5	0.5
M4-B	13.5	13.2	6	M4	9.5	1.7-2.7	0.5	0.5
M5-A	13.5	13.2	6	M5	9.5	0.7-1.6	0.5	0.5
M5-B	13.5	13.2	6	M5	9.5	1.7-2.7	0.5	0.5
M6-A	13.5	13.2	6	M6	9.5	0.7-1.6	0.5	0.5
M6-B	13.5	13.2	6	M6	9.5	1.7-2.7	0.5	0.5
M6-C	13.5	13.2	4.5	M6	9.5	1.7-2.7	0.5	0.5
M8-A	16.6	16	7.8	M8	12.3	1.0-1.7	0.5	0.6
M8-B	16.6	16	7.8	M8	12.3	1.8-3.2	0.5	0.6
M8-C	16.6	16	5.5	M8	12.3	1.8-3.2	0.5	0.6
M10-A	16.6	16	7.8	M10	12.3	1.0-1.7	0.5	0.6
M10-B	16.6	16	7.8	M10	12.3	1.8-3.2	0.5	0.6
M10-C	16.6	16	5.5	M10	12.3	1.8-3.2	0.5	0.6

3

Assembly data

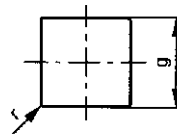
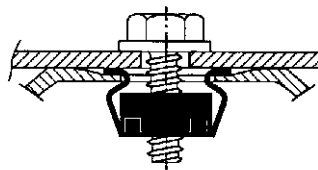

Article groups

Thread	Material	Surface treatment	Code	Page
M	Spring steel	Zipl	72350	3-119
M	St.St. A2		51128	3-119

72350 Speednuts type SMG

Y93A

Thread Metric thread
Material Spring steel
Surface treatment Zinc plated

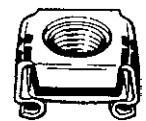

Type	Art.number	Type	Art.number	Type	Art.number
M4 TYPE A	25 72350.040.001	M6 TYPE A	25 72350.060.001	M8 TYPE B	25 72350.080.002
M4 TYPE B	25 72350.040.002	M6 TYPE B	25 72350.060.002	M10 TYPE A	25 72350.100.001
M5 TYPE A	25 72350.050.001	M8 TYPE A	25 72350.080.001	M10 TYPE B	25 72350.100.002
M5 TYPE B	25 72350.050.002				

51128 Speednuts type SMG

R05A

Thread Metric thread
Material Stainless steel A2

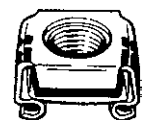

d	Art.number	d	Art.number	d	Art.number
M6 TYPE C*	500 51128.060.001	M8 TYPE C*	100 51128.080.001	M10 TYPE C*	100 51128.100.001

Speednut type SNU

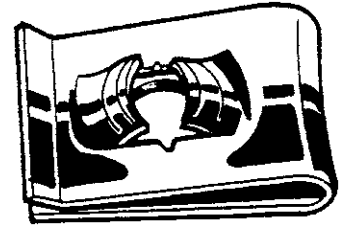
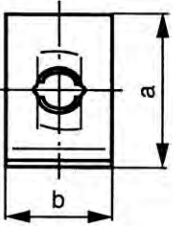

3

Technical Data

Type	a	b	c	For screw	Material thickness	s	x (min.)	y (min.)
SNU 1812	11.1	7.9	4.8	ST2.9	0.7-1.2	0.5	8.3	5.5
SNU 1219	16.4	11	6.7	ST3.5	0.7-1.6	0.6	11.4	6.1
SNU 0536	16.5	11	6.7	ST4.2	0.7-1.6	0.6	11.4	7.6
SNU 1561	24.6	11.1	15	ST4.2	0.7-1.6	0.6	11.4	10.7
SNU 0537	19.8	12.7	7.9	ST4.8	0.9-2.0	0.7	12.9	9.4
SNU 1747	12.2	16	5.5	ST4.8	0.9-1.6	0.7	-	-
SNU 0538	26.2	15.1	11.1	ST5.5	0.9-2.6	0.8	15.4	9.9
SNU 5113	27.3	14.3	13.1	ST6.3	0.8-1.8	0.9	14.7	10
SNU-M5	20.4	15	-	M5	-	0.6	-	-
SNU-M6	23.6	16	-	M6	-	0.8	-	-
SNU-M8	27.5	18	-	M8	-	1	-	-

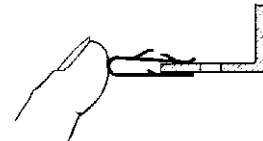
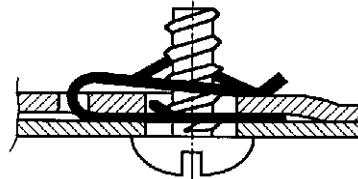
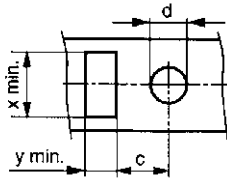

• Warning: electro-galvanizing of these products may cause hydrogen embrittlement.

Assembly data



Article groups

Thread	Material	Surface treatment	Code	Page
M	Spring steel	Zipl	72340	3-120
ST	Spring steel	Zipl yell.p.	72293	3-120

72340	Speednut type SNU	Y93A
Thread	Metric thread	
Material	Spring steel	
Surface treatment	Zinc plated	
		 

Type	☒	Art.number	Type	☒	Art.number	Type	☒	Art.number
M5	50	72340.050.001	M6	50	72340.060.001	M8	50	72340.080.001

72293	Speednut type SNU	Y93A
Thread	Self tapping thread	
Material	Spring steel	
Surface treatment	Zinc plated yellow passivated	
		

Type	☒	Art.number	Type	☒	Art.number	Type	☒	Art.number
2,9MM = No.1812	100	72293.029.001	4,2MM = No.1561	50	72293.042.002	5,5MM = No.0538	50	72293.055.001
3,5MM = No.1219	100	72293.035.001	4,8MM = No.0537	50	72293.048.001	6,3MM = No.5113	50	72293.063.001
4,2MM = No.0536	50	72293.042.001	4,8MM = No.1747	50	72293.048.002			

Jacknut

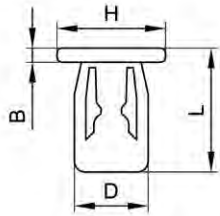

Technical Data

Type	4SJN	6SJN	8SJN
B	1.9	1.9	1.9
D	7.8	9.7	11.1
For nom. size	M4	M5	M6
H	11.9	13.5	15.9
Hole $\varnothing \approx$	8.25	9.95	11.25
L	16.6	18.2	18.6
Material thickness (max.)	4.8	4.8	4.8
Material thickness (min.)	0.4	0.4	0.4
Pull-out force (kN)	1.4	2.8	4.7
Tightening torque (Nm)	1.3	2.2	3.4

- Assembly data: values valid for 1,5mm steel plate

Assembly sequence

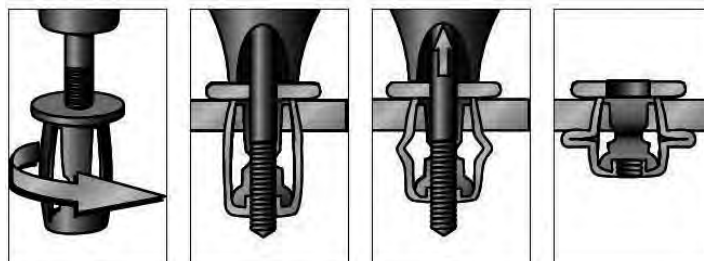

65411	Jacknut	N61B
Thread	Metric thread	
Material	Steel	
Surface treatment	Zinc plated	

Type	☒	Art.number	Type	☒	Art.number	Type	☒	Art.number
4SJN		100 65411.040.015	6SJN		100 65411.050.017	8SJN		100 65411.060.018

Slotted round nut for hook spanners

DIN 1804 W

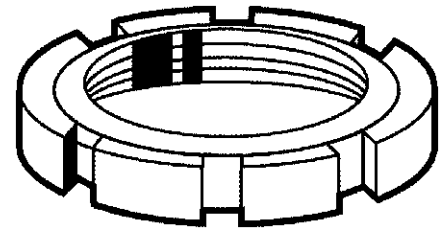
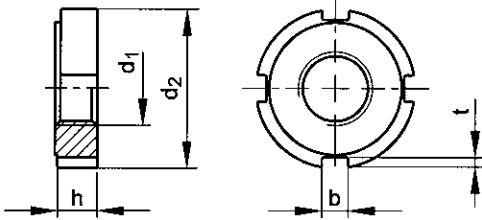

3

Technical Data

d_1	b	d_2 (h11)	h (h14)	Number of slots	t
M10	5	25	6	4	2
M12	5	28	6	4	2
M14	5	30	7	4	2
M16	5	32	7	4	2
M18	6	34	8	4	2.5
M20	6	36	8	4	2.5
M22	6	40	9	4	2.5
M24	6	42	9	4	2.5
M26	7	45	10	4	3
M28	7	50	10	4	3
M30	7	50	10	4	3
M32	7	52	11	4	3
M35	7	55	11	4	3
M38	8	58	11	4	3.5
M40	8	62	12	4	3.5
M42	8	62	12	4	3.5
M45	8	68	12	6	3.5
M48	8	75	13	6	3.5
M50	8	75	13	6	3.5
M55	10	80	13	6	4
M58	10	90	13	6	4
M60	10	90	13	6	4
M62	10	95	14	6	4
M65	10	95	14	6	4
M68	10	100	14	6	4
M70	10	100	14	6	4
M72	10	110	14	6	4
M75	10	110	14	6	4
M80	10	115	16	6	4
M85	10	120	16	6	4
M90	10	130	16	6	4
M95	12	135	16	6	5
M100	12	145	16	6	5

- Slotted round nuts for hookspanners are applicable with internal tab washers acc. to DIN 462 and are easily to assemble with hook wrench acc. to DIN 1810.

Example of application / Assembly data

slotted round nut for
hookspanners acc. to
DIN 1804 W

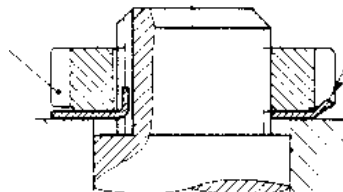

internal tab washer
acc. to DIN 462

11572	Slotted round nut for hook spanners	F01X
Thread	Metric fine thread	
Material	Steel	
Class	[5]	

$d_1 \times P$	☒	Art.number	$d_1 \times P$	☒	Art.number	$d_1 \times P$	☒	Art.number
M10X1,00	25	11572.100.100	M32X1,50	5	11572.320.150	M62X1,50	1	11572.620.150
M12X1,50	25	11572.120.150	M35X1,50	5	11572.350.150	M65X1,50	1	11572.650.150
M14X1,50	10	11572.140.150	M38X1,50	5	11572.380.150	M68X1,50	1	11572.680.150
M16X1,50	10	11572.160.150	M40X1,50	5	11572.400.150	M70X1,50	1	11572.700.150
M18X1,50	10	11572.180.150	M42X1,50	5	11572.420.150	M72X1,50	1	11572.720.150
M20X1,50	10	11572.200.150	M45X1,50	5	11572.450.150	M75X1,50	1	11572.750.150
M22X1,50	10	11572.220.150	M48X1,50	5	11572.480.150	M80X2,00	1	11572.800.200
M24X1,50	5	11572.240.150	M50X1,50	5	11572.500.150	M85X2,00	1	11572.850.200
M26X1,50	5	11572.260.150	M55X1,50	5	11572.550.150	M90X2,00	1	11572.900.200
M28X1,50	5	11572.280.150	M58X1,50	5	11572.580.150	M95X2,00	1	11572.950.200
M30X1,50	5	11572.300.150	M60X1,50	1	11572.600.150	M100X2,00	1	11572.982.200

3

Slotted round nut

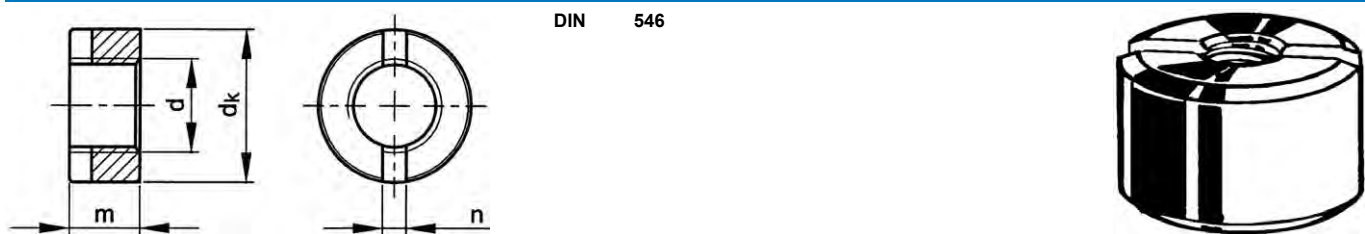

Technical Data				
d	d_k	m	n	P
M2	4.5	2	1	0.4
M2.5	5.5	2.2	1.2	0.45
M3	6	2.5	1.2	0.5
M4	8	3.5	1.4	0.7
M5	9	4.2	2	0.8
M6	11	5	2.5	1
M8	14	6.5	3	1.25
M10	18	8	3.5	1.5

• Slotted round nuts are often used in the electrotechnical and fine mechanical industries, they are easily to assemble with a screwdriver acc. to DIN 3115. Fabory product group: P0044.

Article groups					
Thread	Driving features	Material	Surface treatment	Code	Page
M	Slotted	Free-cutting steel	Zipl	11772	3-123
M	Slotted	St.St. A1		51098	3-124
M	Slotted	St.St. A4		55098	3-124

11772	Slotted round nut	F01X
Thread	Metric thread	
Material	Free-cutting steel	
Surface treatment	Zinc plated	

d	☒	Art.number	d	☒	Art.number	d	☒	Art.number
M2	100	11772.020.001	M5	100	11772.050.001	M8	50	11772.080.001
M3	100	11772.030.001	M6	100	11772.060.001	M10	50	11772.100.001
M4	100	11772.040.001						

51098	Slotted round nut	R09A
Thread	Metric thread	 
Material	Stainless steel A1	

d	☒	Art.number	d	☒	Art.number	d	☒	Art.number
M2*	200	51098.020.001	M4*	200	51098.040.001	M8*	100	51098.080.001
M2,5*	200	51098.025.001	M5*	200	51098.050.001	M10*	50	51098.100.001
M3*	200	51098.030.001	M6*	100	51098.060.001			

55098	Slotted round nut	R49A
Thread	Metric thread	 
Material	Stainless steel A4	

d	☒	Art.number	d	☒	Art.number	d	☒	Art.number
M4*	200	55098.040.001	M6*	100	55098.060.001	M8*	100	55098.080.001
M5*	200	55098.050.001						

Round connection nut

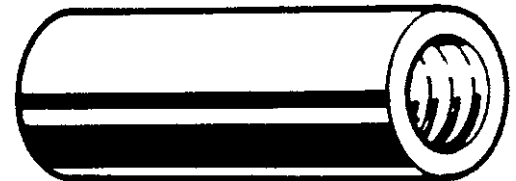
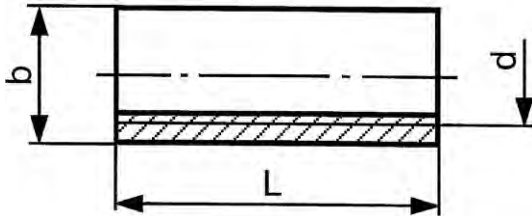

Technical Data

d	b	P	d	b	P
M5	8	0.8	M12	15	1.75
M6	10	1	M16	25	2
M8	11	1.25	M20	28	2.5
M10	13	1.5			

• These connection nuts are used among others for connection of threaded rods.

Article groups

Thread	Material	Class	Surface treatment	Code	Page
M	Free-cutting steel		Zipl	11401	3-124
M	St.St. A2	50		51113	3-125
M	St.St. A4	50		55113	3-125

11401	Round connection nut	F01C
Thread	Metric thread	 
Material	Free-cutting steel	
Surface treatment	Zinc plated	

d x L	☒	Art.number	d x L	☒	Art.number	d x L	☒	Art.number
M5X20	100	11401.050.020	M8X30	100	11401.080.030	M10X40	100	11401.100.040
M6X20	100	11401.060.020	M8X40	100	11401.080.040	M12X20	50	11401.120.020
M6X30	100	11401.060.030	M10X20	100	11401.100.020	M12X30	50	11401.120.030
M8X20	100	11401.080.020	M10X30	100	11401.100.030	M12X40	50	11401.120.040

51113 Round connection nut		R09A
Thread	Metric thread	 
Material	Stainless steel A2	
Class	50	

d x L	☒	Art.number	d x L	☒	Art.number	d x L	☒	Art.number
M6X20*	100	51113.060.020	M8X40*	100	51113.080.040	M12X30*	50	51113.120.030
M6X25*	100	51113.060.025	M8X50*	100	51113.080.050	M12X40*	50	51113.120.040
M6X30*	100	51113.060.030	M10X20*	100	51113.100.020	M12X50*	50	51113.120.050
M8X20*	100	51113.080.020	M10X25*	100	51113.100.025	M16X40*	25	51113.160.040
M8X25*	100	51113.080.025	M10X30*	100	51113.100.030	M16X50*	25	51113.160.050
M8X30*	100	51113.080.030	M10X40*	100	51113.100.040	M20X50*	25	51113.200.050
M8X35*	100	51113.080.035						

3

55113 Round connection nut		R49A
Thread	Metric thread	 
Material	Stainless steel A4	
Class	50	

d x L	☒	Art.number	d x L	☒	Art.number	d x L	☒	Art.number
M6X25*	100	55113.060.025	M10X30*	100	55113.100.030	M16X40*	25	55113.160.040
M8X30*	100	55113.080.030	M12X30*	50	55113.120.030	M20X50*	25	55113.200.050

Prevailing torque type slotted round nut with non-metallic insert type GUK

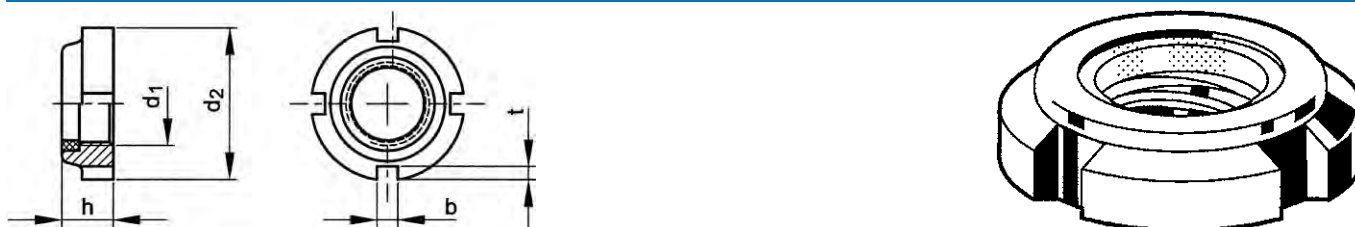

Technical Data					
d ₁	b	d ₂	h	Number of slots	t
M10	3	18	7.4	4	2
M12	3	22	7.4	4	2
M15	4	25	8.4	4	2
M17	4	28	8.4	4	2
M20	4	32	9.4	4	2.5
M25	5	38	10.3	4	2.5
M30	5	44	10.9	4	3
M35	5	50	11.1	4	3
M40	6	56	12.1	4	3
M45	6	62	12.1	4	3.5
M50	6	68	12.7	4	3.5
M55	7	75	13.2	6	3.5
M60	7	80	13.2	6	3.5
M65	7	85	14.3	6	3.5
M70	8	92	14.3	6	4
M75	8	98	15.3	6	4
M80	10	105	16.3	8	4
M85	10	110	17.3	8	4
M90	10	120	17.5	8	5
M95	10	125	18.5	8	5
M100	10	130	19.5	8	5

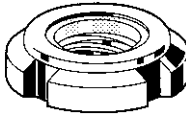
11790	Prevailing torque type slotted round nut with non-metallic insert type GUK	F01X
Thread	Metric fine thread	
Material	Steel	
Surface treatment	Zinc plated yellow passivated	

$d_1 \times P$	☒	Art.number	$d_1 \times P$	☒	Art.number	$d_1 \times P$	☒	Art.number
M10X0,75	10	11790.100.075	M35X1,50	5	11790.350.150	M70X2,00	1	11790.700.200
M12X1,00	10	11790.120.100	M40X1,50	5	11790.400.150	M75X2,00	1	11790.750.200
M15X1,00	10	11790.150.100	M45X1,50	2	11790.450.150	M80X2,00	1	11790.800.200
M17X1,00	10	11790.170.100	M50X1,50	2	11790.500.150	M85X2,00	1	11790.850.200
M20X1,00	10	11790.200.100	M55X2,00	1	11790.550.200	M90X2,00	1	11790.900.200
M25X1,50	5	11790.250.150	M60X2,00	1	11790.600.200	M95X2,00	1	11790.950.200
M30X1,50	5	11790.300.150	M65X2,00	1	11790.650.200	M100X2,00	1	11790.982.200

3

Slotted countersunk (110°) nut

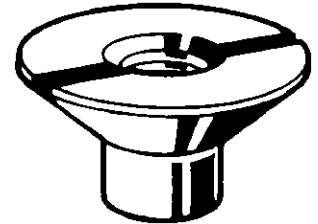
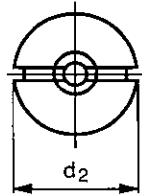
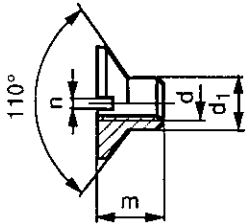

Technical Data

d	d_1	d_2	m	n	P
M3	4	10	6	1	0.5
M4	5	12	6	1	0.7
M5	6	14	7	2	0.8
M6	7	16	8	2	1
M8	9	20	10	2	1.25
M10	12	24	12	2.5	1.5

• Slotted countersunk nuts are used among others in wood connections, where the outside has to be flat.

11560	Slotted countersunk (110°) nut	F01X
Thread	Metric thread	
Material	Free-cutting steel	
Surface treatment	Zinc plated	



d	☒	Art.number	d	☒	Art.number	d	☒	Art.number
M3	250	11560.030.010	M5	250	11560.050.014	M8	250	11560.080.020
M4	250	11560.040.012	M6	250	11560.060.016	M10	250	11560.100.024

Fabory Blind rivet nuts and bolts

Fabory's blind rivet nut and bolt range is an expert range of more than 14 different series of blind rivet nuts and bolts. It offers a wide variety of sizes, alloys, head and body types, all from stock.



Sizes: M3 up to M12
 Alloys: aluminium, steel, stainless steel (A2 and A4)
 Head types: cylindrical, countersunk, reduced countersunk
 Body types: round, hexagonal, open and closed end

The diameters of the blind rivet nuts have been adapted to the use of standard drill diameters. The blind riveting bolt provides an external thread connection and is available in 4 different thread sizes with 4 different lengths each, serving an 8.8 strength class

Advantages

- Can be set in thin material easily.
- The time consuming tapping of a thread or welding of a blind rivet nut is no longer required.
- Blind rivet nuts have the same properties as a tapped thread in solid material, because of the strong 'flush flange' that remains after deformation of the rivet nuts.
- Can be set from one side when the rear of the material and the inside of the object are inaccessible.
- The material will not be damaged.
- Will not deform or cause discolouration of the material

Fabory hand tools for blind rivet nuts and bolts

The Fabory range of hand tools for blind rivet nuts and bolts, offers you one of the widest and most innovative ranges of professional riveting tools in the market. All the Fabory blind insert hand tools are equipped with a (patented) quick release mandrel system enabling you to exchange mandrels with your bare hands without using additional spanners. All tools are supplied in representative packaging with full sets of mandrels/adaptors and anvils.

Fabory's hand tools for blind rivet nuts and bolts are distinctive in a number of relevant areas

- Wide choice
- High professional quality
- Competitive price levels
- Continuous product development and innovations
- Complete supply of tools with full set of conversion kits and stroke regulation devices
- Quick-release system

Quick-release mandrel system for blind rivet nut and bolt tools

1. Release the nosepiece and contra nut
2. Move protective sleeve forwards
3. Hold security part backwards and unscrew mandrel/adaptor



Fabory carries also high quality hydraulic/pneumatic blind rivet nut tools. Please take a look at www.fabory.com for detailed information.

Blind rivet nut cylindrical open serrated shank

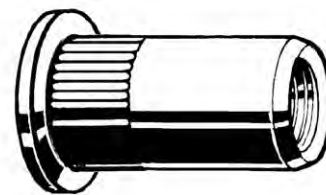
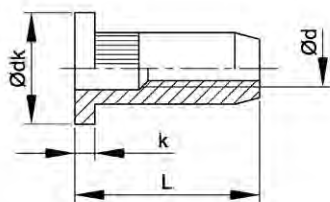

3

Technical Data

Type	Drill ϕ	Grip range	k	L [+0,5/-0]	ϕ d	ϕ d _k
3 OCH 25	5.0	0.5-2.5	≤ 0.9	10.5	M3	7.0
3 OCH 35	5.0	2.5-3.5	≤ 0.9	11.5	M3	7.0
3 OCH 40	5.0	2.5-4.0	≤ 0.9	11.5	M3	7.0
4 OCH 30	6.0	0.5-3.0	≤ 1.1	11.0	M4	9.0
4 OCH 45	6.0	3.0-5.0	≤ 1.1	14.0	M4	9.0
4 OCH 55	6.0	3.0-5.5	≤ 1.1	14.0	M4	9.0
5 OCH 30	7.0	0.5-3.0	≤ 1.1	13.0	M5	10.0
5 OCH 55	7.0	3.0-5.5	≤ 1.1	16.0	M5	10.0
5 OCH 80	7.0	5.5-8.0	≤ 1.1	19.0	M5	10.0
6 OCH 30	9.0	0.5-3.0	≤ 1.6	16.0	M6	12.0
6 OCH 55	9.0	3.0-5.5	≤ 1.6	18.5	M6	12.0
6 OCH 80	9.0	5.5-8.0	≤ 1.6	21.0	M6	12.0
8 OCH 30	11.0	0.5-3.0	≤ 1.6	17.5	M8	15.0
8 OCH 55	11.0	3.0-5.5	≤ 1.6	20.0	M8	15.0
8 OCH 80	11.0	5.5-9.0	≤ 1.6	22.5	M8	15.0
8 OCH 105	11.0	8.0-10.5	≤ 1.6	25.0	M8	15.0
10 OCH 30	12.0	0.5-3.0	≤ 2.1	19.0	M10	16.0
10 OCH 60	12.0	3.0-6.0	≤ 2.1	24.0	M10	16.0
10 OCH 90	12.0	6.0-9.0	≤ 2.1	27.0	M10	16.0
10 OCH 120	12.0	9.0-12.0	≤ 2.1	30.0	M10	16.0
12 OCH 40	16.0	1.0-4.0	≤ 2.1	25.0	M12	22.0
12 OCH 70	16.0	4.0-7.0	≤ 2.1	28.0	M12	22.0
12 OCH 100	16.0	7.0-10.0	≤ 2.1	31.0	M12	22.0

Article groups

Material	Surface treatment	Code	Page
St	Zipl	69135	3-128
St.St. A4		69526	3-129
Al		69315	3-129

69135 Blind rivet nut cylindrical open serrated shank

F07A

Material Steel
Surface treatment Zinc plated

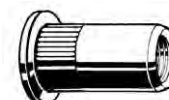

Type	☒	Art.number	Type	☒	Art.number	Type	☒	Art.number
3 OCH 25	250	69135.030.025	6 OCH 30	250	69135.060.030	10 OCH 30	250	69135.100.030
3 OCH 40	250	69135.030.040	6 OCH 55	250	69135.060.055	10 OCH 60	250	69135.100.060
4 OCH 30	250	69135.040.030	6 OCH 80	250	69135.060.080	10 OCH 90	100	69135.100.090
4 OCH 55	250	69135.040.055	8 OCH 30	250	69135.080.030	10 OCH 120	100	69135.100.120
5 OCH 30	250	69135.050.030	8 OCH 55	250	69135.080.055	12 OCH 40	100	69135.120.040
5 OCH 55	250	69135.050.055	8 OCH 80	250	69135.080.080	12 OCH 70	100	69135.120.070
5 OCH 80	250	69135.050.080	8 OCH 105	250	69135.080.105	12 OCH 100	100	69135.120.100

69526 Blind rivet nut cylindrical open serrated shank F07A

Material: Stainless steel A4

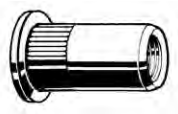
Type	Art.number	Type	Art.number	Type	Art.number
5OCH30	250 69526.050.030	6OCH30	250 69526.060.030	8OCH30	250 69526.080.030

69315 Blind rivet nut cylindrical open serrated shank F07A

Material: Aluminium



Type	Art.number	Type	Art.number	Type	Art.number
3 OCH 25	250 69315.030.025	6 OCH 30	250 69315.060.030	10 OCH 30	250 69315.100.030
3 OCH 35	250 69315.030.035	6 OCH 55	250 69315.060.055	10 OCH 60	250 69315.100.060
4 OCH 30	250 69315.040.030	6 OCH 80	250 69315.060.080	10 OCH 90	100 69315.100.090
4 OCH 45	250 69315.040.045	8 OCH 30	250 69315.080.030	10 OCH 120	100 69315.100.120
5 OCH 30	250 69315.050.030	8 OCH 55	250 69315.080.055	12 OCH 40	100 69315.120.040
5 OCH 55	250 69315.050.055	8 OCH 80	250 69315.080.080	12 OCH 70	100 69315.120.070
5 OCH 80	250 69315.050.080	8 OCH 105	250 69315.080.105	12 OCH 100	100 69315.120.100

Blind rivet nut cylindrical open serrated shank

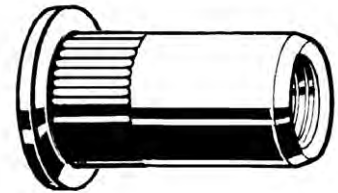
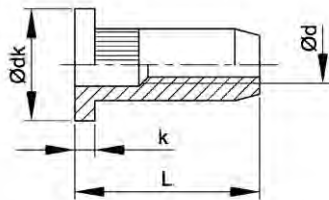

Technical Data						
Type	Drill ø	Grip range	k	L [+0,5/-0]	ø d	ø d _k
4 OCH 30	6.0	0.5-3.0	≤ 1.1	11.0	M4	9.0
4 OCH 45	6.0	3.0-4.5	≤ 1.1	14.0	M4	9.0
5 OCH 30	7.0	0.5-3.0	≤ 1.1	13.0	M5	10.0
5 OCH 55	7.0	3.0-5.5	≤ 1.1	16.0	M5	10.0
5 OCH 80	7.0	5.5-8.0	≤ 1.1	19.0	M5	10.0
6 OCH 30	9.0	0.5-3.0	≤ 1.6	16.0	M6	12.0
6 OCH 55	9.0	3.0-5.5	≤ 1.6	18.5	M6	12.0
8 OCH 30	11.0	0.5-3.0	≤ 1.6	17.5	M8	15.0
8 OCH 55	11.0	3.0-5.5	≤ 1.6	20.0	M8	15.0
10 OCH 30	13.0	0.5-3.0	≤ 2.1	19.0	M10	16.0
10 OCH 60	13.0	3.0-6.0	≤ 2.1	24.0	M10	16.0

69025 Blind rivet nut cylindrical open serrated shank F07A

Material: Stainless steel A2



Type	Art.number	Type	Art.number	Type	Art.number
4 OCH 30	250 69025.040.030	5 OCH 80	250 69025.050.080	8 OCH 55	250 69025.080.055
4 OCH 45	250 69025.040.045	6 OCH 30	250 69025.060.030	10 OCH 30	250 69025.100.030
5 OCH 30	250 69025.050.030	6 OCH 55	250 69025.060.055	10 OCH 60	250 69025.100.060
5 OCH 55	250 69025.050.055	8 OCH 30	250 69025.080.030		

Blind rivet nut cylindrical open hexagon shank

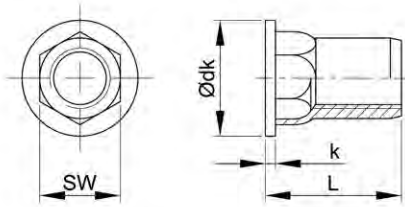

3

Technical Data

Type	dk ø	Grip range	Hole hexagon	k	L [+0,5/-0]	ø d
4 OCH 30	9	0.5-3.0	6	1.1	11	M4
5 OCH 30	10	0.5-3.0	7	1.1	13	M5
6 OCH 30	12	0.5-3.0	9	1.6	16	M6
8 OCH 30	15	0.5-3.0	11	1.6	17.5	M8
10 OCH 30	16	0.5-3.0	12	2.1	19	M10

Article groups

Material	Surface treatment	Code	Page
St	Zipl	69400	3-130
St.St. A2		69407	3-130

69400 Blind rivet nut cylindrical open hexagon shank

F07A

Material Steel
Surface treatment Zinc plated



Type	⊠	Art.number	Type	⊠	Art.number	Type	⊠	Art.number
4OCH30	250	69400.040.030	6OCH30	250	69400.060.030	10OCH30	250	69400.100.030
5OCH30	250	69400.050.030	8OCH30	250	69400.080.030			

69407 Blind rivet nut cylindrical open hexagon shank

F07A

Material Stainless steel A2



Type	⊠	Art.number	Type	⊠	Art.number	Type	⊠	Art.number
4OCH30	250	69407.040.030	6OCH30	250	69407.060.030	10OCH30	250	69407.100.030
5OCH30	250	69407.050.030	8OCH30	250	69407.080.030			

Blind rivet nut countersunk open serrated shank

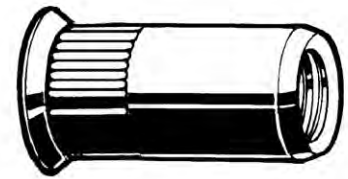
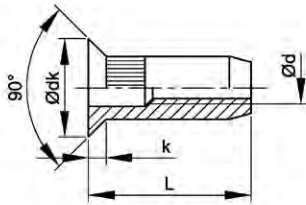

3

Technical Data

Type	Drill ø	Grip range	k	L [+0,5/-0]	ø d	ø dk
3 OCSH 35	5.0	1.5-3.5	≤ 1.5	11.5	M3	7.5
3 OCSH 50	5.0	3.5-5.0	≤ 1.5	12.5	M3	7.5
4 OCSH 40	6.0	1.5-4.0	≤ 1.5	12.5	M4	8.5
4 OCSH 65	6.0	4.0-6.5	≤ 1.5	15.0	M4	8.5
5 OCSH 40	7.0	1.5-4.0	≤ 1.5	13.5	M5	9.5
5 OCSH 65	7.0	4.0-6.5	≤ 1.5	16.0	M5	9.5
5 OCSH 90	7.0	6.5-9.0	≤ 1.5	18.5	M5	9.5
6 OCSH 40	9.0	1.4-4.0	≤ 1.5	15.5	M6	11.5
6 OCSH 65	9.0	4.0-6.5	≤ 1.5	18.0	M6	11.5
6 OCSH 90	9.0	6.5-9.0	≤ 1.5	20.5	M6	11.5
8 OCSH 40	11.0	1.5-4.0	≤ 1.5	18.5	M8	13.5
8 OCSH 65	11.0	4.0-6.5	≤ 1.5	21.0	M8	13.5
8 OCSH 90	11.0	6.5-9.0	≤ 1.5	23.5	M8	13.5
10 OCSH 45	12.0	2.0-4.5	≤ 1.7	21.0	M10	14.5
10 OCSH 75	12.0	4.5-7.5	≤ 1.7	24.0	M10	14.5
10 OCSH 105	12.0	7.5-10.5	≤ 1.7	27.0	M10	14.5
12 OCSH 45	16.0	2.0-4.5	≤ 1.9	24.5	M12	19.0
12 OCSH 75	16.0	4.5-7.5	≤ 1.9	27.5	M12	19.0
12 OCSH 105	16.0	7.5-10.5	≤ 1.9	31.0	M12	19.0

69155 Blind rivet nut countersunk open serrated shank

F07A

Material Steel
Surface treatment Zinc plated

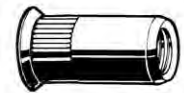

Type	☒	Art.number	Type	☒	Art.number	Type	☒	Art.number
3 OCSH 35	250	69155.030.035	6 OCSH 40	250	69155.060.040	10 OCSH 45	250	69155.100.045
3 OCSH 50	250	69155.030.050	6 OCSH 65	250	69155.060.065	10 OCSH 75	250	69155.100.075
4 OCSH 40	250	69155.040.040	6 OCSH 90	250	69155.060.090	10 OCSH 105	100	69155.100.105
4 OCSH 65	250	69155.040.065	8 OCSH 40	250	69155.080.040	12 OCSH 45	100	69155.120.045
5 OCSH 40	250	69155.050.040	8 OCSH 65	250	69155.080.065	12 OCSH 75	100	69155.120.075
5 OCSH 65	250	69155.050.065	8 OCSH 90	250	69155.080.090	12 OCSH 105	100	69155.120.105
5 OCSH 90	250	69155.050.090						

Blind rivet nuts countersunk open

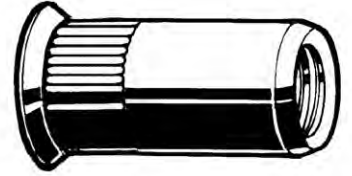
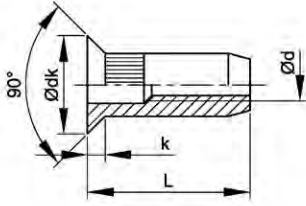

3

Technical Data

Type	Drill ϕ	Grip range	k	L [+0,5/-0]	ϕ d	ϕ d _k
4 OCSH 40	6.0	1.5-4.0	≤ 1.5	12.5	M4	8.5
5 OCSH 40	7.0	1.5-4.0	≤ 1.5	13.5	M5	9.5
6 OCSH 40	9.0	1.5-4.0	≤ 1.5	15.5	M6	11.5
8 OCSH 40	11.0	1.5-4.0	≤ 1.5	18.5	M8	13.5
10 OCSH 45	13.0	2.0-4.5	≤ 1.8	21.0	M10	15.5

Article groups

Material	Code	Page
St.St. A2	69045	3-132
St.St. A4	69525	3-132

69045 Blind rivet nut countersunk open Stainless steel serrated shank F07A

Material Stainless steel A2

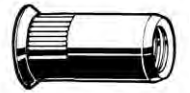

Type	⊠	Art.number	Type	⊠	Art.number	Type	⊠	Art.number
4 OCSH 40	250	69045.040.040	6 OCSH 40	250	69045.060.040	10 OCSH 45	250	69045.100.045
5 OCSH 40	250	69045.050.040	8 OCSH 40	250	69045.080.040			

69525 Blind rivet nut countersunk open Stainless steel smooth shank F07A

Material Stainless steel A4



Type	⊠	Art.number	Type	⊠	Art.number	Type	⊠	Art.number
5OCSH40	250	69525.050.040	6OCSH40	250	69525.060.040	8OCSH40	250	69525.080.040

Blind rivet nut countersunk open serrated shank

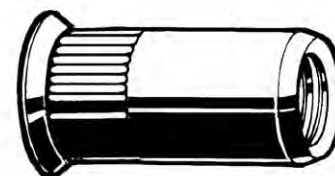
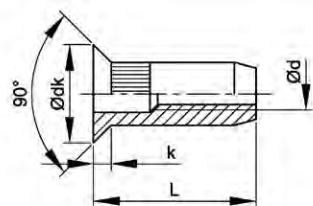

Technical Data

Type	Drill ø	Grip range	k	L [+0,5/-0]	ø d	ø d _k
3 OCSH 35	5.0	1.5-3.5	≤ 1.5	11.5	M3	7.5
3 OCSH 45	5.0	3.5-4.5	≤ 1.5	12.5	M3	7.5
4 OCSH 40	6.0	1.5-4.0	≤ 1.5	12.5	M4	8.5
4 OCSH 55	6.0	4.0-5.5	≤ 1.5	15.0	M4	8.5
5 OCSH 40	7.0	1.5-4.0	≤ 1.5	13.5	M5	9.5
5 OCSH 65	7.0	4.0-6.5	≤ 1.5	16.0	M5	9.5
5 OCSH 90	7.0	6.5-9.0	≤ 1.5	18.5	M5	9.5
6 OCSH 40	9.0	1.5-4.0	≤ 1.5	15.5	M6	11.5
6 OCSH 65	9.0	4.0-6.5	≤ 1.5	18.0	M6	11.5
6 OCSH 90	9.0	6.5-9.0	≤ 1.5	20.5	M6	11.5
8 OCSH 40	11.0	1.5-4.0	≤ 1.5	18.5	M8	13.5
8 OCSH 65	11.0	4.0-6.5	≤ 1.5	21.0	M8	13.5
8 OCSH 90	11.0	6.5-9.0	≤ 1.5	23.5	M8	13.5
10 OCSH 45	12.0	2.0-4.5	≤ 1.7	21.0	M10	14.5
10 OCSH 75	12.0	4.5-7.5	≤ 1.7	24.0	M10	14.5
10 OCSH 105	12.0	7.5-10.5	≤ 1.7	27.0	M10	14.5
12 OCSH 45	16.0	2.0-4.5	≤ 1.9	24.5	M12	19.0
12 OCSH 75	16.0	4.5-7.5	≤ 1.9	27.5	M12	19.0
12 OCSH 105	16.0	7.5-10.5	≤ 1.9	31.0	M12	19.0

69335 Blind rivet nut countersunk open serrated shank

F07A

Material Aluminium

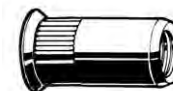

Type	☒	Art.number	Type	☒	Art.number	Type	☒	Art.number
3 OCSH 35	250	69335.030.035	6 OCSH 40	250	69335.060.040	10 OCSH 45	250	69335.100.045
3 OCSH 45	250	69335.030.045	6 OCSH 65	250	69335.060.065	10 OCSH 75	250	69335.100.075
4 OCSH 40	250	69335.040.040	6 OCSH 90	250	69335.060.090	10 OCSH 105	100	69335.100.105
4 OCSH 55	250	69335.040.055	8 OCSH 40	250	69335.080.040	12 OCSH 45	100	69335.120.045
5 OCSH 40	250	69335.050.040	8 OCSH 65	250	69335.080.065	12 OCSH 75	100	69335.120.075
5 OCSH 65	250	69335.050.065	8 OCSH 90	250	69335.080.090	12 OCSH 105	100	69335.120.105
5 OCSH 90	250	69335.050.090						

Blind rivet nut reduced countersunk open serrated shank

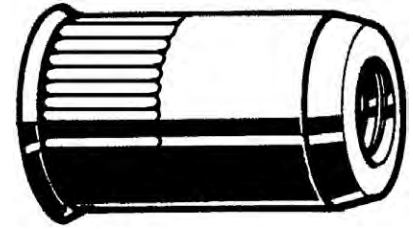
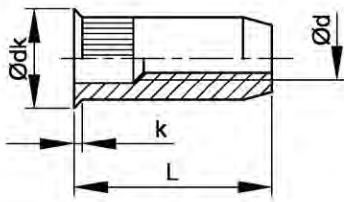

3

Technical Data

Type	Drill ϕ	Grip range	k	L [+0,5/-0]	ϕ d	ϕ d _k
3 ORCSH 25	5.0	0.5-2.5	≤ 0.7	9.5	M3	6.0
4 ORCSH 30	6.0	0.5-3.0	≤ 0.7	10.0	M4	7.0
5 ORCSH 30	7.0	0.5-3.0	≤ 0.7	11.5	M5	8.0
6 ORCSH 30	9.0	0.5-3.0	≤ 0.7	14.0	M6	10.0
8 ORCSH 30	11.0	0.5-3.0	≤ 0.7	15.0	M8	12.0
10 ORCSH 35	12.0	0.8-3.5	≤ 0.9	19.5	M10	13.5

69435 Blind rivet nut reduced countersunk open serrated shank

F07A

Material Steel
Surface treatment Zinc plated

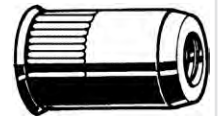

Type	Art.number	Type	Art.number	Type	Art.number
3 ORCSH 25	250 69435.030.025	5 ORCSH 30	250 69435.050.030	8 ORCSH 30	250 69435.080.030
4 ORCSH 30	250 69435.040.030	6 ORCSH 30	250 69435.060.030	10 ORCSH 35	250 69435.100.035

Blind rivet nut reduced countersunk open serrated shank

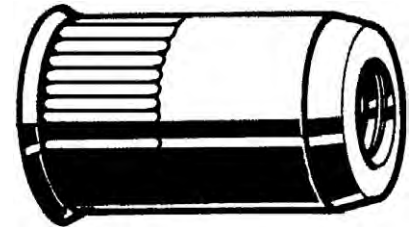
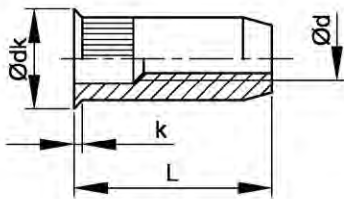

Technical Data

Type	dk ϕ	Drill ϕ	Grip range	k	L [+0,5/-0]	ϕ d
4 ORCSH 30	7	6	0.5-3.0	0.9	10	M4
5 ORCSH 30	8	7	0.5-3.0	0.9	11.5	M5
6 ORCSH 30	10	9	0.5-3.0	0.9	14	M6
8 ORCSH 30	12	11	0.5-3.0	0.9	15.5	M8
10 ORCSH 35	14.5	13	0.8-3.5	1.1	19.5	M10

69035 Blind rivet nut reduced countersunk open serrated shank

F07A

Material Stainless steel A2

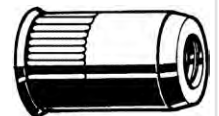

Type	Art.number	Type	Art.number	Type	Art.number
4ORCSH30	250 69035.040.030	6ORCSH30	250 69035.060.030	10ORCSH35	250 69035.100.035
5ORCSH30	250 69035.050.030	8ORCSH30	250 69035.080.030		

Blind rivet nut reduced countersunk open serrated shank

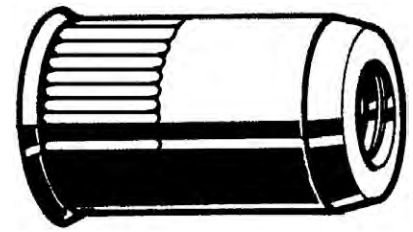
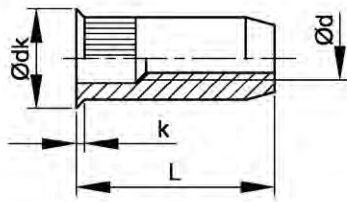

Technical Data

Type	dk ø	Drill ø	Grip range	k	L [+0,5/-0]	ø d
3 ORCSH 25	6	5	0.5-2.5	0.7	9.5	M3
4 ORCSH 30	7	6	0.5-3.0	0.7	10	M4
5 ORCSH 30	8	7	0.5-3.0	0.7	11.5	M5
6 ORCSH 30	10	9	0.5-3.0	0.7	14	M6
8 ORCSH 30	12	11	0.5-3.0	0.7	15.5	M8

69445 Blind rivet nut reduced countersunk open serrated shank

F07A

Material Aluminium

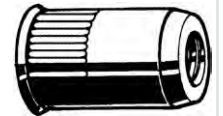

Type	Art.number	Type	Art.number	Type	Art.number
3ORCSH25	250 69445.030.025	5ORCSH30	250 69445.050.030	8ORCSH30	250 69445.080.030
4ORCSH30	250 69445.040.030	6ORCSH30	250 69445.060.030		

Blind rivet nut reduced countersunk open hexagon shank

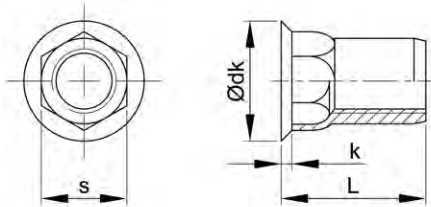

Technical Data

Type	Grip range	Hole hexagon	k	L [+0,5/-0]	Width across flats (s)	ø d	ø d _k
3 ORCSH 25	0.5-2.5	5.1	≤ 0.8	10.5	5.0	M3	6.5
4 ORCSH 30	0.5-3.0	6.1	≤ 0.8	12.5	6.0	M4	7.0
5 ORCSH 30	0.5-3.0	7.1	≤ 0.8	14.0	7.0	M5	8.0
6 ORCSH 30	0.5-3.0	9.1	≤ 0.8	16.0	9.0	M6	10.0
8 ORCSH 30	0.5-3.0	11.1	≤ 0.8	17.0	11.0	M8	12.0
10 ORCSH 35	0.8-3.5	13.1	≤ 0.8	20.5	13.0	M10	14.5

69450 Blind rivet nut reduced countersunk open hexagon shank

F07A

Material Steel
Surface treatment Zinc plated



Type	Art.number	Type	Art.number	Type	Art.number
3 ORCSH 25	250 69450.030.025	5 ORCSH 30	250 69450.050.030	8 ORCSH 30	250 69450.080.030
4 ORCSH 30	250 69450.040.030	6 ORCSH 30	250 69450.060.030	10 ORCSH 35	250 69450.100.035

Blind rivet nut reduced countersunk open hexagon shank

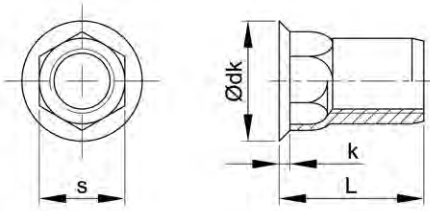

3

Technical Data

Type	Grip range	Hole hexagon	k	L [+0,5/-0]	Width across flats (s)	ø d	ø d _k
4 ORCSH 30	0.5-3.0	6.1	≤ 0.9	12.5	6.0	M4	7.0
5 ORCSH 30	0.5-3.0	7.1	≤ 0.9	14.0	7.0	M5	8.0
6 ORCSH 30	0.5-3.0	9.1	≤ 0.9	16.0	9.0	M6	10.0
8 ORCSH 30	0.5-3.0	11.1	≤ 0.9	17.0	11.0	M8	12.0
10 ORCSH 35	0.8-6.5	13.1	≤ 1.1	20.5	13.0	M10	14.5

69440 Blind rivet nut reduced countersunk open hexagon shank

F07A

Material Stainless steel A2



Type	☒	Art.number	Type	☒	Art.number	Type	☒	Art.number
4 ORCSH 30	250	69440.040.030	6 ORCSH30	250	69440.060.030	10 ORCSH 35	250	69440.100.035
5 ORCSH 30	250	69440.050.030	8 ORCSH 30	250	69440.080.030			

Blind rivet nut cylindrical closed serrated shank

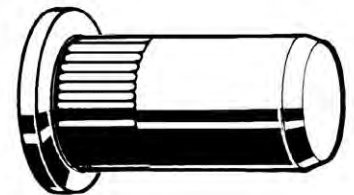
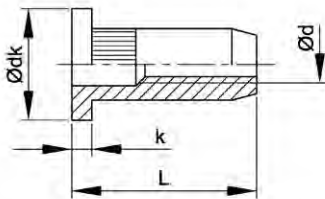

Technical Data

Type	Drill ø	Grip range	k	L [+0,5/-0]	ø d	ø d _k
3 CCH 25	5.0	0.5-2.5	≤ 0.9	15.0	M3	7.0
3 CCH 40	5.0	2.0-4.0	≤ 0.9	16.0	M3	7.0
4 CCH 30	6.0	0.5-3.0	≤ 1.1	16.0	M4	9.0
4 CCH 55	6.0	3.0-5.5	≤ 1.1	19.0	M4	9.0
5 CCH 30	7.0	0.5-3.0	≤ 1.1	18.5	M5	10.0
5 CCH 55	7.0	3.0-5.5	≤ 1.1	21.5	m5	10.0
5 CCH 80	7.0	5.5-8.0	≤ 1.1	24.5	M5	10.0
6 CCH 30	9.0	0.5-3.0	≤ 1.6	21.5	M6	12.0
6 CCH 55	9.0	3.0-5.5	≤ 1.6	24.0	M6	12.0
6 CCH 80	9.0	5.5-8.0	≤ 1.6	26.5	M6	12.0
8 CCH 30	11.0	0.5-3.0	≤ 1.6	26.0	M8	15.0
8 CCH 55	11.0	3.0-5.5	≤ 1.6	28.5	M8	15.0
8 CCH 80	11.0	5.5-8.0	≤ 1.6	31.0	M8	15.0
8 CCH 105	11.0	8.0-10.5	≤ 1.6	33.5	M8	15.0
10 CCH 30	12.0	0.5-3.0	≤ 2.1	28.0	M10	16.0
10 CCH 60	12.0	3.0-6.0	≤ 2.1	33.0	M10	16.0
10 CCH 90	12.0	6.0-9.0	≤ 2.1	36.0	M10	16.0
10 CCH 120	12.0	9.0-12.0	≤ 2.1	39.0	M10	16.0

69190		Blind rivet nut cylindrical closed serrated shank		F07A	
Material	Steel				
Surface treatment	Zinc plated				

Type	☒	Art.number	Type	☒	Art.number	Type	☒	Art.number
3 CCH 25	250	69190.030.025	5 CCH 80	250	69190.050.080	8 CCH 80	250	69190.080.080
3 CCH 40	250	69190.030.040	6 CCH 30	250	69190.060.030	8 CCH 105	250	69190.080.105
4 CCH 30	250	69190.040.030	6 CCH 55	250	69190.060.055	10 CCH 30	250	69190.100.030
4 CCH 55	250	69190.040.055	6 CCH 80	250	69190.060.080	10 CCH 60	250	69190.100.060
5 CCH 30	250	69190.050.030	8 CCH 30	250	69190.080.030	10 CCH 90	100	69190.100.090
5 CCH 55	250	69190.050.055	8 CCH 55	250	69190.080.055	10 CCH 120	100	69190.100.120

3

Blind rivet nut cylindrical closed serrated shank

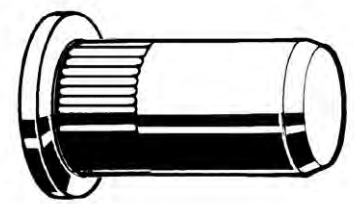
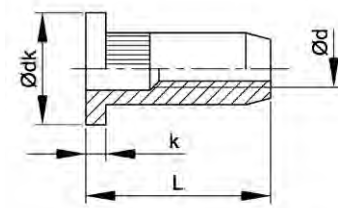

Technical Data						
Type	Drill ø	Grip range	k	L [+0,5/-0]	ø d	ø dk
3 CCH 25	5.0	0.5-2.5	≤ 0.9	15.0	M3	7.0
3 CCH 35	5.0	2.5-3.5	≤ 0.9	16.0	M3	7.0
4 CCH 30	6.0	0.5-3.0	≤ 1.1	16.0	M4	9.0
4 CCH 45	6.0	3.0-4.5	≤ 1.1	19.0	M4	9.0
5 CCH 30	7.0	0.5-3.0	≤ 1.1	18.5	M5	10.0
5 CCH 55	7.0	3.0-5.5	≤ 1.1	21.5	M5	10.0
5 CCH 80	7.0	5.5-8.0	≤ 1.1	24.5	M5	10.0
6 CCH 30	9.0	0.5-3.0	≤ 1.6	21.5	M6	12.0
6 CCH 55	9.0	3.0-5.5	≤ 1.6	24.0	M6	12.0
6 CCH 80	9.0	5.5-8.0	≤ 1.6	26.5	M6	12.0
8 CCH 30	11.0	0.5-3.0	≤ 1.6	26.0	M8	15.0
8 CCH 55	11.0	3.0-5.5	≤ 1.6	28.5	M8	15.0
8 CCH 80	11.0	5.5-8.0	≤ 1.6	31.0	M8	15.0
8 CCH 105	11.0	8.0-10.5	≤ 1.6	33.5	M8	15.0
10 CCH 30	12.0	0.5-3.0	≤ 2.1	28.0	M10	16.0
10 CCH 60	12.0	3.0-6.0	≤ 2.1	33.0	M10	16.0
10 CCH 90	12.0	6.0-9.0	≤ 2.1	36.0	M10	16.0
10 CCH 120	12.0	9.0-10.5	≤ 2.1	39.0	M10	16.0

69355		Blind rivet nut cylindrical closed serrated shank		F07A	
Material	Aluminium				

Type	☒	Art.number	Type	☒	Art.number	Type	☒	Art.number
3 CCH 25	250	69355.030.025	5 CCH 80	250	69355.050.080	8 CCH 80	250	69355.080.080
3 CCH 35	250	69355.030.035	6 CCH 30	250	69355.060.030	8 CCH 105	250	69355.080.105
4 CCH 30	250	69355.040.030	6 CCH 55	250	69355.060.055	10 CCH 30	250	69355.100.030
4 CCH 45	250	69355.040.045	6 CCH 80	250	69355.060.080	10 CCH 60	250	69355.100.060
5 CCH 30	250	69355.050.030	8 CCH 30	250	69355.080.030	10 CCH 90	100	69355.100.090
5 CCH 55	250	69355.050.055	8 CCH 55	250	69355.080.055	10 CCH 120	100	69355.100.120

Blind rivet nut countersunk closed serrated shank

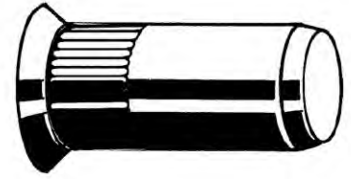
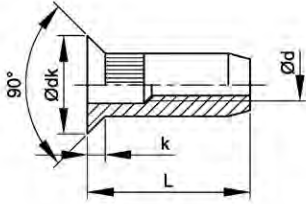

3

Technical Data

Type	Drill ø	Grip range	k	L [+0,5/-0]	ø d	ø d _k
3 CCSH 35	5.0	1.5-3.5	≤ 1.5	16.0	M3	7.5
3 CCSH 50	5.0	3.5-5.0	≤ 1.5	17.0	M3	7.5
4 CCSH 40	6.0	1.5-4.0	≤ 1.5	17.5	M4	8.5
4 CCSH 65	6.0	4.0-6.5	≤ 1.5	20.0	M4	8.5
5 CCSH 40	7.0	1.5-4.0	≤ 1.5	20.0	M5	9.5
5 CCSH 65	7.0	4.0-6.5	≤ 1.5	22.5	M5	9.5
5 CCSH 90	7.0	6.5-9.0	≤ 1.5	25.0	M5	9.5
6 CCSH 40	8.0	1.5-4.0	≤ 1.5	23.0	M6	11.5
6 CCSH 65	8.0	4.0-6.5	≤ 1.5	25.5	M6	11.5
6 CCSH 90	8.0	6.5-9.0	≤ 1.5	28.0	M6	11.5
8 CCSH 40	11.0	1.5-4.0	≤ 1.5	27.0	M8	13.5
8 CCSH 65	11.0	4.0-6.5	≤ 1.5	29.5	M8	13.5
8 CCSH 90	11.0	6.5-9.0	≤ 1.5	32.0	M8	13.5
10 CCSH 45	12.0	2.0-4.5	≤ 1.7	30.0	M10	14.5
10 CCSH 75	12.0	4.5-7.5	≤ 1.7	33.0	M10	14.5
10 CCSH 105	12.0	7.5-10.5	≤ 1.7	36.0	M10	14.5
12 CCSH 45	16.0	2.0-4.5	≤ 1.9	34.5	M12	19.0
12 CCSH 75	16.0	4.5-7.5	≤ 1.9	37.5	M12	19.0
12 CCSH 110	16.0	7.5-11.0	≤ 1.9	41.0	M12	19.0

69195 Blind rivet nut countersunk closed serrated shank

F07A

Material Steel
Surface treatment Zinc plated

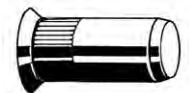

Type	☒	Art.number	Type	☒	Art.number	Type	☒	Art.number
3 CCSH 35	250	69195.030.035	6 CCSH 40	250	69195.060.040	10 CCSH 45	250	69195.100.045
3 CCSH 50	250	69195.030.050	6 CCSH 65	250	69195.060.065	10 CCSH 75	250	69195.100.075
4 CCSH 40	250	69195.040.040	6 CCSH 90	250	69195.060.090	10 CCSH 105	100	69195.100.105
4 CCSH 65	250	69195.040.065	8 CCSH 40	250	69195.080.040	12 CCSH 45	100	69195.120.045
5 CCSH 40	250	69195.050.040	8 CCSH 65	250	69195.080.065	12 CCSH 75	100	69195.120.075
5 CCSH 65	250	69195.050.065	8 CCSH 90	250	69195.080.090	12 CCSH 110	100	69195.120.110
5 CCSH 90	250	69195.050.090						

Blind rivet screw cylindrical

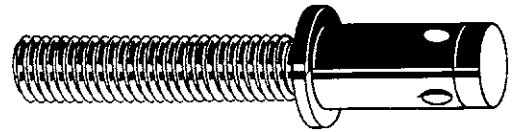
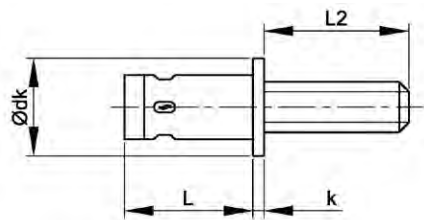

Technical Data

Type	Drill ϕ	Grip range	k	L [+1/-0,5]	L ₂	ϕ d _k
M4X2010	5.5	0.5-2.0	0.5	8.0	10	8.0
M4X2015	5.5	0.5-2.0	0.5	8.0	15	8.0
M4X3010	5.5	2.0-3.0	0.5	8.0	10	8.0
M4X3015	5.5	2.0-3.0	0.5	8.0	15	8.0
M5X2010	6.6	0.5-2.0	0.8	9.0	10	9.0
M5X2015	6.6	0.5-2.0	0.8	9.0	15	9.0
M5X3510	6.6	2.0-3.5	0.8	10.5	10	9.0
M5X3515	6.6	2.0-3.5	0.8	10.5	15	9.0
M6X2510	7.8	0.5-2.5	1.0	10.0	10	10.0
M6X2515	7.8	0.5-2.5	1.0	10.0	15	10.0
M6X4010	7.8	2.5-4.0	1.0	11.5	10	10.0
M6X4015	7.8	2.5-4.0	1.0	11.5	15	10.0
M8X3020	9.9	1.0-3.0	1.5	12.5	20	12.0
M8x3515	9.9	1.0-3.0	1.5	12.5	20	12.0
M8X5015	9.9	3.0-5.0	1.5	15.0	15	12.0
M8X5020	9.9	3.0-5.0	1.5	15.0	20	12.0

69975 Blind rivet screw cylindrical

F09A

Material Steel
Surface treatment Zinc plated



Type	☒	Art.number	Type	☒	Art.number	Type	☒	Art.number
M4X2010	250	69975.042.010	M5X3510	250	69975.053.510	M8X3020	250	69975.083.020
M4X2015	250	69975.042.015	M5X3515	250	69975.053.515	M8X3015	250	69975.083.515
M4X3010	250	69975.043.010	M6X2510	250	69975.062.510	M8X5015	250	69975.085.015
M4X3015	250	69975.043.015	M6X2515	250	69975.062.515	M8X5020	250	69975.085.020
M5X2010	250	69975.052.010	M6X4010	250	69975.064.010			
M5X2015	250	69975.052.015	M6X4015	250	69975.064.015			

Blind rivet nut hand tool FABORY



3

		M3			M4			M5			M6			M8			M10			M12			
		Al	St	St.st.	Al	St	St.st.	Al	St	St.st.	Al	St	St.st.	Al	St	St.st.	Al	St	St.st.	Al	St	St.st.	
F 360																							
F 510																							
F 511																							
F 612																							
FEZ 12																							

additional option
 recommended capacity

69685	Blind rivet nut hand tool FABORY	T90A
--------------	---	-------------



Type	☒	Art.number		
FEZ 12	1	69685.012.001	<ul style="list-style-type: none"> • Unique hand tool with built-in transmission of power, allowing setting of large size blind rivet nuts with little effort. • Equipped with stroke setting mechanism and a quick-release mandrel system. • Capacity: M5 - M12. • Weight: 2,5 kg. • Dimensions: 555 mm. • Body: Aluminium. • Lever: Steel. • Equipment: Conversion kit blind rivet nuts M5 - M12. 	
F 360	1	69685.360.001	<ul style="list-style-type: none"> • Professional hand tool for setting blind rivet nuts and blind rivet bolts. • Equipped with stroke setting mechanism and quick-release mandrel system. • Capacity: M3 - M6. • Weight: 0,8 kg. • Dimensions: 280 mm. • Body: Aluminium. • Lever: Steel. • Equipment: Conversion kit blind rivet nuts M3 - M6. • Equipment: Conversion kit blind rivet bolts M4 - M6. 	
F 510	1	69685.510.001	<ul style="list-style-type: none"> • Powerful tool for setting blind rivet nuts and bolts, equipped with both a stroke setting mechanism ensuring every blind rivet nut and bolt to be set with equal clamping force, and a quick-release mandrel system. • Capacity: M5 - M10. • Weight: 2,2 kg. • Dimensions: 555 mm. • Body: ABS plastic with steel parts. • Lever: Steel. • Equipment: Conversion kit blind rivet nuts M5 - M10. • Equipment: Conversion kit blind rivet bolts M5 - M8. 	
F 511	1	69685.511.001	<ul style="list-style-type: none"> • Powerful tool for setting blind rivet nuts and bolts, equipped with both a stroke setting mechanism ensuring every blind rivet nut and bolt to be set with equal clamping force, and a quick-release mandrel system. • The quick-release spindle provides quick installation. • Capacity: M5 - M10. • Weight: 2,4 kg. • Dimensions: 555 mm. • Body: ABS plastic with steel parts. • Lever: Steel. • Equipment: Conversion kit blind rivet nuts M5 - M10. • Equipment: Conversion kit blind rivet bolts M5 - M8. 	

69685		Blind rivet nut hand tool FABORY		←
Type	✉	Art.number		
F 612	1	69685.612.001	<ul style="list-style-type: none"> • Powerful compact blind rivet nut tool with built-in ratched key. • Especially suited to place large size blind rivet nuts in small areas. • Equipped with ideal stroke setting mechanism and quick-release mandrel system. • Capacity: M6 - M12. • Weight: 1,1 kg. • Dimensions: 210 mm. • Body: Steel. • Lever: Steel. • Equipment: Conversion kit blind rivet nuts M6 - M12. • Equipment: Conversion kit blind rivet bolts M5 - M8. 	

Blind rivet nut assortment



69670		Blind rivet nut assortment		F90A
				

Type	✉	Art.number		
F360	1	69670.360.001	<ul style="list-style-type: none"> • Set in aluminium case. • F360 Robust hand tool for blind rivet nuts and blind rivet bolts with 6 (x 30 pieces) sizes of aluminium rivet nuts: M4, M5, M6 (cylindrical and reduced countersunk). 	

AMECOIL Wire thread inserts

3

Application

AMECOIL wire thread inserts are not only economical for recovering worn or damaged screw threads but also very suitable to achieve high-loadable internal thread in metal and non-metal materials. AMECOIL wire thread inserts can be used at temperatures from -40°C up to +400°C.

Material

AMECOIL wire thread inserts are produced from a stainless steel A2 wire of diamond cross-section, that is wound in a coil like a spring.

Threads

The internal screw thread of the nut-part of the AMECOIL wire thread insert is conforming to the normal tolerance field 6H. For details concerning the external screw thread in the material see DIN 8140-2.

Assembly

For assembly of AMECOIL wire thread inserts see also the assembly sequence:

- drill the hole (do not countersink)
- tapping the thread with the special AMECOIL tap, the sizes of the thread of the special AMECOIL taps are larger than of a standard tap!
- screwing in the AMECOIL wire thread insert with AMECOIL manual fitting tool by 1/4 to 1/2 pitch under the surface of the part
- breaking-off the engaging stem of the AMECOIL wire thread insert up to \varnothing 18 mm after fitting with the AMECOIL tang break, for sizes larger than M18 resp. 5/8 UNC/UNF a pointed plier has to be used
- assembly ready
- disassembly of a AMECOIL wire thread insert is possible with the special extractor.

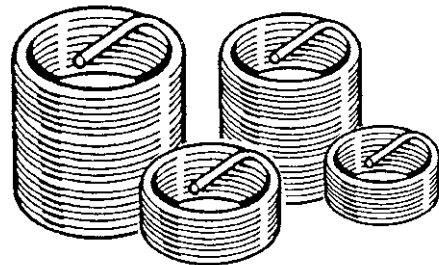

Guide values for determination of the nominal length L ^①

Tensile strenght material R_m in N/mm ²		Property class/yield strength bolt in N/mm ² ^②			
above	up to and incl.	5.8/400	8.8/640	10.9/900	12.9/1080
-	150	2 d	2,5 d	2,5 d	2,5 d
150	200	1,5 d	2 d	2 d	2,5 d
200	250	1,5 d	1,5 d	2 d	2,5 d
250	300	1 d	1,5 d	1,5 d	2 d
300	400	1 d	1 d	1,5 d	1,5 d



^① Corresponding to the proofloads of DIN ISO 898-2.

^② d = nominal size of the wire thread insert.

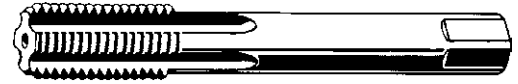

Machine oversized tap for wire thread insert M





- ATTENTION: the sizes of the thread of the special AMECOIL taps are larger than of a standard tap!

3

Article groups			
Material		Code	Page
St HSS	for blind holes	71310	3-143
St HSS	for blind holes	71410	3-143

71310 AMECOIL Machine tap oversized for wire thread insert		S91A
Material	Steel HSS	 

d	☒	Art.number	d	☒	Art.number	d	☒	Art.number
M3	1	71310.030.001	M8	1	71310.080.001	M18	1	71310.180.001
M4	1	71310.040.001	M10	1	71310.100.001	M20	1	71310.200.001
M5	1	71310.050.001	M12	1	71310.120.001	M22	1	71310.220.001
M6	1	71310.060.001	M14	1	71310.140.001	M24	1	71310.240.001
M7	1	71310.070.001	M16	1	71310.160.001	M27	1	71310.270.001

71410 AMECOIL Machine tap oversized for wire thread insert		S91A
Material	Steel HSS	 

d	☒	Art.number	d	☒	Art.number	d	☒	Art.number
M6	1	71410.060.001	M10	1	71410.100.001	M16	1	71410.160.001
M8	1	71410.080.001	M12	1	71410.120.001			

- Recommended for blind holes.
- Machinetap up to and including M8 sharp pointed and over M8 with flat point.

Machine tap for wire thread insert MF

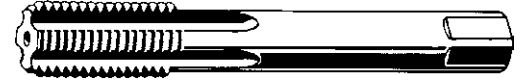

3

- ATTENTION: the sizes of the thread of the special AMECOIL taps are larger than of a standard tap!

71320		AMECOIL Machine tap for wire thread insert MF				S91A		
Material		Steel HSS		AMECA				
d x P	☒	Art.number	d x P	☒	Art.number	d x P	☒	Art.number
M8X1,00	1	71320.080.100	M12X1,50	1	71320.120.150	M18X1,50	1	71320.180.150
M10X1,00	1	71320.100.100	M14X1,25	1	71320.140.125	M20X1,50	1	71320.200.150
M10X1,25	1	71320.100.125	M14X1,50	1	71320.140.150	M22X1,50	1	71320.220.150
M12X1,00	1	71320.120.100	M16X1,50	1	71320.160.150	M24X1,50	1	71320.240.150
M12X1,25	1	71320.120.125						

Staged tap for spark plug wire thread inserts



- ATTENTION: the sizes of the thread of the special AMECOIL taps are larger than of a standard tap!

71930		AMECOIL Staged tap for spark plug wire thread inserts				S91A	
Material		Steel HSS		AMECA			
d x P	☒	Art.number	d x P	☒	Art.number		
M12X1,25	1	71930.120.125	M14X1,25	1	71930.140.125		

Machine tap for wire thread insert UNC



- ATTENTION: the sizes of the thread of the special AMECOIL taps are larger than of a standard tap!

3

71340 AMECOIL Machine tap for wire thread inserts				S91A				
Material		Steel HSS		AMECA				
d	☒	Art.number	d	☒	Art.number	d	☒	Art.number
1/4	1	71340.063.001	1/2	1	71340.127.001	3/4	1	71340.191.001
5/16	1	71340.079.001	9/16	1	71340.142.001	7/8	1	71340.222.001
3/8	1	71340.096.001	5/8	1	71340.158.001	1 Inch	1	71340.254.001
7/16	1	71340.111.001						

Machine tap for wire thread insert UNF

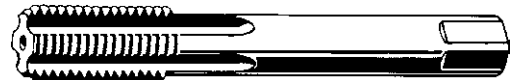

- ATTENTION: the sizes of the thread of the special AMECOIL taps are larger than of a standard tap!

71330 AMECOIL Machine tap for wire thread inserts				S91A				
Material		Steel HSS		AMECA				
d	☒	Art.number	d	☒	Art.number	d	☒	Art.number
1/4	1	71330.063.001	1/2	1	71330.127.001	3/4	1	71330.191.001
5/16	1	71330.079.001	9/16	1	71330.142.001	7/8	1	71330.222.001
3/8	1	71330.096.001	5/8	1	71330.158.001	1 Inch	1	71330.255.001
7/16	1	71330.111.001						

Wire thread insert

DIN 8140-1A

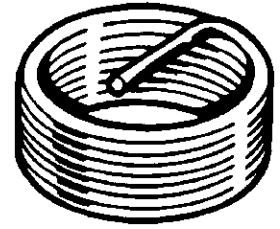
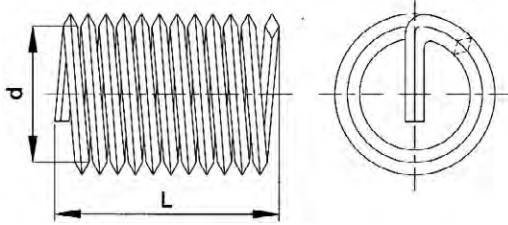

3

Technical Data

d (nom.)	Drill ø	P	d (nom.)	Drill ø	P
M3	3.2	0.5	M14	14.5	2
M4	4.2	0.7	M16	16.5	2
M5	5.2	0.8	M18	18.75	2.5
M6	6.3	1	M20	20.75	2.5
M7	7.3	1	M22	22.75	2.5
M8	8.4	1.25	M24	24.75	3
M10	10.5	1.5	M27	27.75	3
M12	12.5	1.75			

- L - P = thread length after assembly.

Article groups

Thread	Material	Color	Code	Page
M	St.St. A2		71110	3-146
M	St.St. A2	prevailing torque type	Red	3-146

71110 AMECOIL Wire thread insert

S07A

Thread Metric thread
Material Stainless steel A2

AMEGA



d (nom.) x L	☒	Art.number	d (nom.) x L	☒	Art.number	d (nom.) x L	☒	Art.number
M3X4,5	50	71110.030.004	M7X10,5	50	71110.070.010	M14X28	25	71110.140.028
M4X4	50	71110.040.004	M8X8	50	71110.080.008	M16X16	25	71110.160.016
M4X6	50	71110.040.006	M8X12	50	71110.080.012	M16X24	25	71110.160.024
M4X8	50	71110.040.008	M8X16	50	71110.080.016	M16X32	25	71110.160.032
M5X5	50	71110.050.005	M10X10	25	71110.100.010	M18X27	10	71110.180.027
M5X7,5	50	71110.050.007	M10X15	25	71110.100.015	M20X30	10	71110.200.030
M5X10	50	71110.050.010	M10X20	25	71110.100.020	M20X40	10	71110.200.040
M6X6	50	71110.060.006	M12X12	25	71110.120.012	M22X33	10	71110.220.033
M6X9	50	71110.060.009	M12X18	25	71110.120.018	M24X36	10	71110.240.036
M6X12	50	71110.060.012	M12X24	25	71110.120.024	M27X40,5	10	71110.270.040
M6X18	50	71110.060.018	M14X21	25	71110.140.021			

71210 AMECOIL Prevailing torque type wire thread insert

S07A

Thread Metric thread
Material Stainless steel A2
Color Red

DIN 8140-1B

AMEGA



d (nom.) x L	☒	Art.number	d (nom.) x L	☒	Art.number	d (nom.) x L	☒	Art.number
M6X9	50	71210.060.009	M10X15	25	71210.100.015	M16X24	25	71210.160.024
M8X12	50	71210.080.012	M12X18	25	71210.120.018			

- The prevailing torque type wire thread insert achieves its locking ability, between bolt and AMECOIL, by polygonal deformation of one or more spirals of the wire thread insert.
- They are painted red for easier identification with the standard type.

Wire thread insert MF

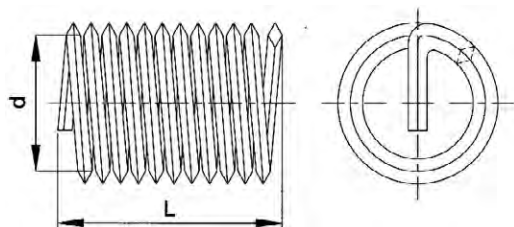

DIN 8140-1A

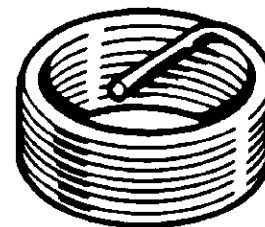

Technical Data

d (nom.) x P	Drill ø	d (nom.) x P	Drill ø
M8x1	8.3	M14x1.5	14.5
M10x1.25	10.4	M16x1.5	16.5
M12x1.5	12.5		

- L - P = thread length after assembly.

71120 AMECOIL Wire thread insert

S07A

Thread Metric fine thread
Material Stainless steel A2

AMECA



d (nom.) x P x L	☒	Art.number	d (nom.) x P x L	☒	Art.number	d (nom.) x P x L	☒	Art.number
M8X1,00X12	50	71120.080.012	M10X1,25X20	25	71120.100.020	M14X1,50X21	25	71120.140.021
M10X1,25X10	25	71120.100.010	M12X1,50X18	25	71120.120.018	M16X1,50X16	25	71120.160.016
M10X1,25X15	25	71120.100.015	M14X1,50X14	25	71120.140.014	M16X1,50X24	25	71120.160.024

Wire thread insert MEF

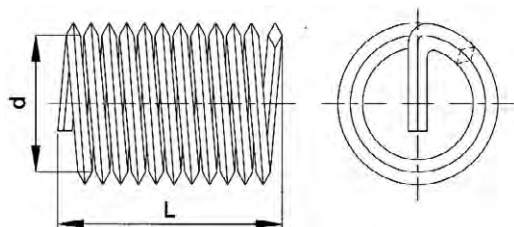

DIN 8140-1A

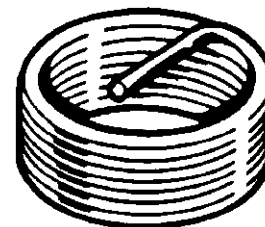

Technical Data

d (nom.) x P	Drill ø	d (nom.) x P	Drill ø
M10x1	10.25	M18x1.5	18.5
M12x1	12.4	M20x1.5	20.5
M12x1.25	12.4	M22x1.5	22.5
M14x1.25	14.4	M24x1.5	24.5

- L - P = thread length after assembly.

Article groups

Thread	Material	Code	Page
MEF	St.St. A2	71121	3-147
MEF	St.St. A2	for spark plug 71920	3-148

71121 AMECOIL Wire thread insert

S07A



Thread Metric extra fine thread
Material Stainless steel A2

AMECA

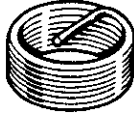

d (nom.) x P x L	☒	Art.number	d (nom.) x P x L	☒	Art.number	d (nom.) x P x L	☒	Art.number
M10X1,00X15	25	71121.100.015	M14X1,25X14	25	71121.140.014	M18X1,50X27	10	71121.180.027
M12X1,25X18	25	71121.120.018	M18X1,50X12	10	71121.180.012	M20X1,50X20	10	71121.200.020
M12X1,00X18	25	71121.121.018	M18X1,50X18	10	71121.180.018	M20X1,50X30	10	71121.200.030

71121 AMECOIL Wire thread insert					
d (nom.) x P x L	☒	Art.number	d (nom.) x P x L	☒	Art.number
M22X1,50X22	10	71121.220.022	M24X1,50X24	10	71121.240.024

71920 AMECOIL Wire thread insert for spark plugs						S07A		
Thread Material		Metric extra fine thread Stainless steel A2		AMECA				
								
d (nom.) x P x L	☒	Art.number	d (nom.) x P x L	☒	Art.number	d (nom.) x P x L	☒	Art.number
M12X1,25X10,5	25	71920.120.010	M14X1,25X10,5	25	71920.140.010	M14X1,25X18	25	71920.140.018
M14X1,25X7,5	25	71920.140.007						

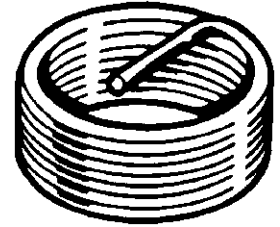
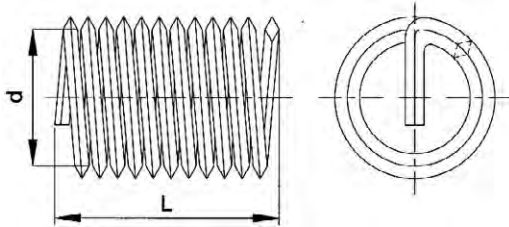

Wire thread insert UNC



Technical Data

d (nom.)	Drill ø	Threads per inch	d (nom.)	Drill ø	Threads per inch
1/4	6.7	20	9/16	14.9	12
5/16	8.4	18	5/8	16.5	11
3/8	10	16	3/4	19.8	10
7/16	11.6	14	7/8	23	9
1/2	13.2	13	1 Inch	26.4	8

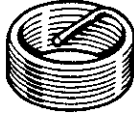
• L - P = thread length after assembly.

71140 AMECOIL Wire thread insert						S07A		
Thread Material		Unified National Coarse Stainless steel A2		AMECA				
								
d (nom.) x L	☒	Art.number	d (nom.) x L	☒	Art.number	d (nom.) x L	☒	Art.number
1/4X9,5	50	71140.063.009	1/2X19,1	25	71140.127.019	3/4X28,6	10	71140.191.028
5/16X11,9	50	71140.079.011	9/16X21,4	25	71140.142.021	7/8X33,3	10	71140.222.033
3/8X14,3	25	71140.096.014	5/8X23,8	25	71140.158.023	1 Inch X38,1	10	71140.254.038
7/16X16,7	25	71140.111.016						

Wire thread insert UNF

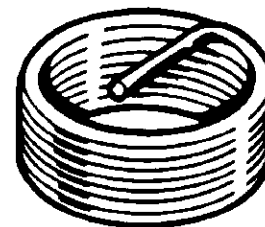
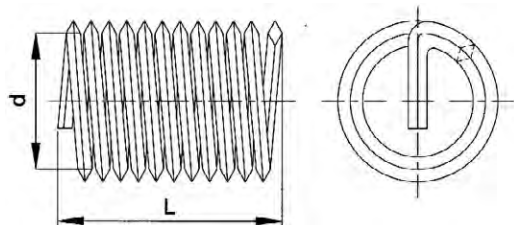

Technical Data

d (nom.)	Drill ø	Threads per inch	d (nom.)	Drill ø	Threads per inch
1/4	6.7	28	9/16	14.7	18
5/16	8.3	24	5/8	16.3	18
3/8	9.9	24	3/4	19.5	16
7/16	11.5	20	7/8	22.7	14
1/2	13.1	20	1 Inch	26	12

- L - P = thread length after assembly.

71130 AMECOIL Wire thread insert		S07A
Thread	Unified National Fine	
Material	Stainless steel A2	

d (nom.) x L	☒	Art.number	d (nom.) x L	☒	Art.number	d (nom.) x L	☒	Art.number
1/4X9,5	50	71130.063.009	1/2X19,1	25	71130.127.019	3/4X19,1	10	71130.191.019
5/16X11,9	50	71130.079.011	9/16X14,3	25	71130.142.014	7/8X22,2	10	71130.222.022
3/8X14,3	25	71130.096.014	5/8X15,9	25	71130.158.015	1.IN.-12GX25,4	10	71130.255.025
7/16X16,7	25	71130.111.016						

Workshop kit wire thread insert M

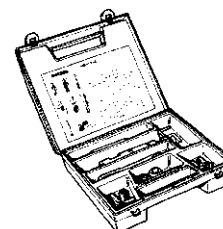

71010 AMECOIL Workshop kit wire thread insert		S90A
Material	Stainless steel A2	

d (nom.) x L	☒	Art.number	d (nom.) x L	☒	Art.number	d (nom.) x L	☒	Art.number
M3X4,5 (25PC)	1	71010.030.004	M8X12 (25PC)	1	71010.080.012	M18X27 (10PC)	1	71010.180.027
M4X6 (25PC)	1	71010.040.006	M10X15 (25PC)	1	71010.100.015	M20X30 (10PC)	1	71010.200.030
M5X7,5 (25PC)	1	71010.050.007	M12X18 (15PC)	1	71010.120.018	M22X33 (10PC)	1	71010.220.033
M6X9 (25PC)	1	71010.060.009	M14X21 (15PC)	1	71010.140.021	M24X36 (10PC)	1	71010.240.036
M7X10,5 (25PC)	1	71010.070.010	M16X24 (15PC)	1	71010.160.024			

- Contents:
- Complete unidimensional manual fitting tool
- Machine tap (≥ M18 with extra starting tap)
- Tang break
- Stainless steel A2 wire thread inserts acc. to DIN 8140(quantities between brackets).

Workshop kit wire thread insert MF

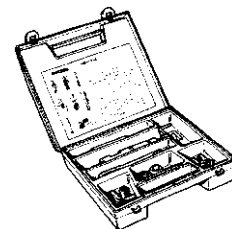

3

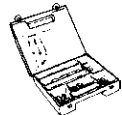
71020	AMECOIL Workshop kit wire thread insert MF	S90A
Material	Stainless steel A2	 

d (nom.) x P x L	☒	Art.number	d (nom.) x P x L	☒	Art.number	d (nom.) x P x L	☒	Art.number
M8X1,00X12 (25PC)	1	71020.080.012	M12X1,50X18 (15PC)	1	71020.120.018	M16X1,50X16 (15PC)	1	71020.160.016
M10X1,25X15 (25PC)	1	71020.100.015	M14X1,50X14 (15PC)	1	71020.140.014			

- Contents:
- Complete unidimensional manuel fitting tool
- Machine tap
- Tang break
- Stainless steel A2 wire thread inserts acc. to DIN 8140 (quantities between brackets).

Workshop kit wire thread insert MEF





Article groups



Material	Code	Page
St.St. A2	71021	3-150
St.St. A2	71910	3-151

71021	AMECOIL Workshop kit wire thread insert MEF	S90A
Material	Stainless steel A2	 

d (nom.) x P x L	☒	Art.number	d (nom.) x P x L	☒	Art.number	d (nom.) x P x L	☒	Art.number
M10X1,00X15 (25PC)	1	71021.100.015	M18X1,50X18 (10PC)	1	71021.180.018	M22X1,50X22 (10PC)	1	71021.220.022
M12X1,25X18 (15PC)	1	71021.120.018	M20X1,50X20 (10PC)	1	71021.200.020	M24X1,50X24 (10PC)	1	71021.240.024
M14X1,25X14 (15PC)	1	71021.140.014						

- These workshop kits are made from plastic, contents wire thread inserts and accessories and are for frequent use of one size.
- Contents:
- Complete unidimensional manuel fitting tool
- Machine tap
- Tang break
- Stainless steel A2 wire thread inserts acc. to DIN 8140-1A (quantities between brackets).

71910	AMECOIL Workshop kit wire thread insert MEF	S90A
Material	Stainless steel A2	 

d (nom.) x P	<input checked="" type="checkbox"/>	Art.number		
M12X1,25	1	71910.120.125	Content: <ul style="list-style-type: none"> • Manual fitting tool with nozzle • Carrier adapted to length for M12 x 1,25 x 10,5 / M12 x 1,25 x 18 • Staged tap • 10 stainless steel A2 wire thread inserts M12 x 1,25 x 10,5 / M12 x 1,25 x 18 acc. to DIN 8140-1A 	
M14X1,25	1	71910.140.125	Content: <ul style="list-style-type: none"> • Manual fitting tool with nozzle • Carrier adapted to length for M14 x 1,25 x 7,5 / M14 x 1,25 x 10,5 / M14 x 1,25 x 18 • Staged tap • 10 stainless steel A2 wire thread inserts M14 x 1,25 x 7,5 acc. to DIN 8140-1A • 20 stainless steel A2 wire thread inserts M14 x 1,25 x 10,5 acc. to DIN 8140-1A • 10 stainless steel A2 wire thread inserts M14 x 1,25 x 18 acc. to DIN 8140-1A 	

- These workshop kits are made from plastic, contents wire thread inserts and accessories and are recommended for general use.

Workshop kit wire thread insert UNC

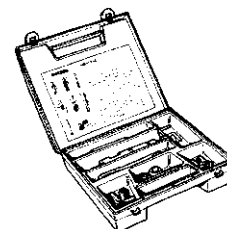

71040	AMECOIL Workshop kit wire thread insert UNC	S90A
Material	Stainless steel A2	 

d (nom.) x L	<input checked="" type="checkbox"/>	Art.number	d (nom.) x L	<input checked="" type="checkbox"/>	Art.number	d (nom.) x L	<input checked="" type="checkbox"/>	Art.number
1/4X9,5 (25PC)	1	71040.063.009	1/2X19,1 (25PC)	1	71040.127.019	3/4X28,6 (10PC)	1	71040.191.028
5/16X11,9 (25PC)	1	71040.079.011	9/16X21,4 (15PC)	1	71040.142.021	7/8X33,3 (10PC)	1	71040.222.033
3/8X14,3 (25PC)	1	71040.096.014	5/8X23,8 (15PC)	1	71040.158.023	1.IN.X38,1 (10PC)	1	71040.254.038
7/16X16,7 (25PC)	1	71040.111.016						

- Contents:
- Complete unidimensional manual fitting tool
- Machine tap ($\geq 5/8$ UNC with extra starting tap)
- Tang break
- Stainless steel A2 wire thread inserts (quantities between brackets).

Workshop kit wire thread insert UNF

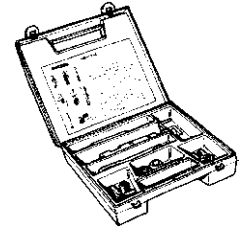

3

71030	AMECOIL Workshop kit wire thread insert UNF	S90A
Material	Stainless steel A2	AMECA 

d (nom.) x L	☒	Art.number	d (nom.) x L	☒	Art.number	d (nom.) x L	☒	Art.number
1/4X9,5 (25PC)	1	71030.063.009	1/2X19,1 (25PC)	1	71030.127.019	3/4X19,1 (10PC)	1	71030.191.019
5/16X11,9 (25PC)	1	71030.079.011	9/16X14,3 (15PC)	1	71030.142.014	7/8X22,2 (10PC)	1	71030.222.022
3/8X14,3 (25PC)	1	71030.096.014	5/8X15,9 (15PC)	1	71030.158.015	1.IN.-12GX25,4 (10PC)	1	71030.255.025
7/16X16,7 (25PC)	1	71030.111.016						

- Contents:
- Complete unidimensional manuel fitting tool
- Machine tap
- Tang break
- Stainless steel A2 wire thread inserts (quantities between brackets).

Workshop kit wire thread insert BSW

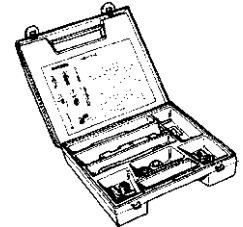

- Whitworth thread (BSW/BSF) is not internationally recommended.
- It is advised to use metric (M/MF) or unified threads (UNC/UNF).

71050	AMECOIL Workshop kit wire thread insert BSW	S90A
Material	Stainless steel A2	AMECA 



d (nom.) x L	☒	Art.number
1/2X19,1 (25PC)	1	71050.127.019





- Contents:
- Complete unidimensional manuel fitting tool
- Machine tap
- Tang break
- Stainless steel A2 wire thread inserts (quantities between brackets).

Repair kit with wire thread inserts



3

71090	AMECOIL Repair kit with wire thread inserts	S90A
Material	Stainless steel A2	 

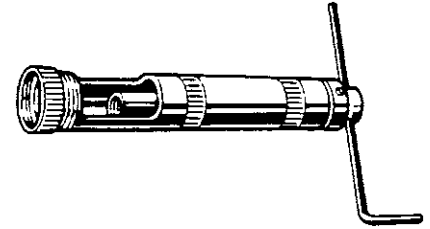

No.	☒	Art.number		
NO.1-MM	1	71090.100.010	<ul style="list-style-type: none"> Repair kit no. 1 with/for metric wire thread inserts Contents: Manual fitting tool no. 3. Nozzle and mandrel for M6 / M8 / M10 and M12. Tang break for each size. Machine tap for each size. 15 stainless steel A2 wire thread inserts M6 x 9 / M8 x 12 / M10 x 15 / M12 x 18 acc. to DIN 8140. ATTENTION: nozzles and mandrels M6 and M8 are specially for manual fitting tool no. 3 adjusted and only replaceable by nozzles and mandrels article group 71711. For nozzles and mandrels M10 / M12, see group code 71710. 	
NO.2-MM	1	71090.100.020	<ul style="list-style-type: none"> Repair kit no. 2 with/for metric wire thread inserts. Contents: Manual fitting tool no. 4. Nozzle and mandrel for M6 / M8 / M10 / M12 / M14 x 1,25. Tang break for each size. Machine tap for each size (for M14 x 1,25 staged tap). 15 stainless steel A2 wire thread inserts M6 x 9 / M8 x 12 / M10 x 15 / M12 x 18 / M14 x 1,25 x 14 acc. to DIN 8140. ATTENTION: nozzles and mandrels M6 / M8 / M10 / M12 / M14 x 1,25 are specially for manual fitting tool no. 4 adjusted and only replaceable by nozzles and mandrels article groups 71712 and 71722 	
NO.1C-NC	1	71090.400.010	<ul style="list-style-type: none"> Repair kit no. 1C with/for UNC wire thread inserts. Contents: Manual fitting tool no. 3. Nozzle and mandrel for 1/4 / 5/16 / 3/8 / 7/16 / 1/2 UNC. Tang break for each size. Machine tap for each size. 15 stainless steel A2 wire thread inserts 1/4 x 9,5 / 5/16 x 11,9 / 3/8 x 14,3 / 7/16 x 16,7 / 1/2 x 19,1 UNC. ATTENTION: nozzles and mandrels 1/4 UNC en 5/16 UNC are specially for manual fitting tool no. 3 adjusted and only replaceable by nozzles and mandrels article group 71741. For nozzles and mandrels 3/8 / 7/16 / 1/2 UNC, see article group 71740. 	
NO.1D-NF	1	71090.500.010	<ul style="list-style-type: none"> Repair kit no. 1D with/for UNF wire thread inserts. Contents: Manual fitting tool no. 3. Nozzle and mandrel for 1/4 / 5/16 / 3/8 / 7/16 / 1/2 UNF. Tang break for each size. Machine tap for each size. 15 stainless steel A2 wire thread inserts 1/4 x 9,5 / 5/16 x 11,9 / 3/8 x 14,3 / 7/16 x 16,7 / 1/2 x 19,1 UNF. ATTENTION: nozzles and mandrels 1/4 UNF en 5/16 UNF are specially for manual fitting tool no. 3 adjusted and only replaceable by nozzles and mandrels article group 71731. For nozzles and mandrels 3/8 / 7/16 / 1/2 UNF, see article group 71730. 	

Multidimensional manual fitting tool

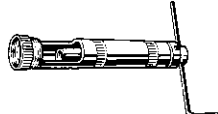
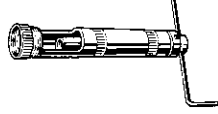
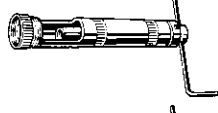

3

71510	AMECOIL Multidimensional manual fitting tool	S91A
AMECA		

No.	☒	Art.number		
NO.1	1	71510.000.001	<ul style="list-style-type: none"> • Suitable for wire thread insert: • M4 / M5 	
NO.2	1	71510.000.002	<ul style="list-style-type: none"> • Suitable for wire thread insert: • M6 / M7 / M8 / M8x1 / 1/4 UNC / 5/16 UNC / 1/4 UNF / 5/16 UNF 	
NO.3	1	71510.000.003	<ul style="list-style-type: none"> • Suitable for wire thread insert: • M10 / M12 / M10x1 / M10x1,25 / M12x1 / M12x1,25 / M12x1,5 / 3/8 UNC / 7/16 UNC / 1/2 UNC / 3/8 UNF / 7/16 UNF / 1/2 UNF 	
NO.4	1	71510.000.004	<ul style="list-style-type: none"> • Suitable for wire thread insert: • M14 / M16 / M14x1,25 / M14x1,5 / M16x1,5 / 9/16 UNC / 5/8 UNC / 9/16 UNF / 5/8 UNF / 1/2 BSW 	

- Intended for the fitting of wire thread inserts.
- Excl. nozzle and mandrel, these have to be ordered, per diameter, separately.
- Aluminium body with steel inside work.

Complete manual fitting tool

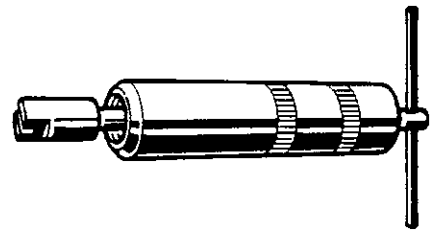

3

Article groups

Code	Page
71610	3-155
71620	3-155
71940	3-155
71640	3-156

71610 AMECOIL Complete manual fitting tool Metric S91A

AMECA

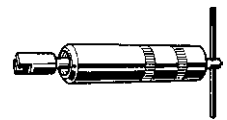

d	☒	Art.number	d	☒	Art.number	d	☒	Art.number
M18	1	71610.180.001	M22	1	71610.220.001	M27	1	71610.270.001
M20	1	71610.200.001	M24	1	71610.240.001			

- Complete manual fitting tool.
- Intended for the fitting of metric wire thread inserts.
- Aluminium with steel inside work.

71620 AMECOIL Complete manual fitting tool Metric fine S91A

AMECA

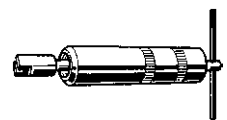

d x P	☒	Art.number	d x P	☒	Art.number	d x P	☒	Art.number
M18X1,50	1	71620.180.150	M22X1,50	1	71620.220.150	M24X1,50	1	71620.240.150
M20X1,50	1	71620.200.150						

- Complete manual fitting tool.
- Intended for the fitting of metric extra fine wire thread inserts.
- Aluminium with steel inside work.

71940 AMECOIL Manual fitting tool with nozzle Metric S91A

AMECA

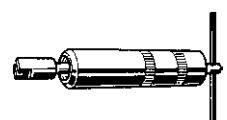

d x P	☒	Art.number	d x P	☒	Art.number
M12X1,25	1	71940.120.125	M14X1,25	1	71940.140.125

- Manual fitting tool with nozzle.
- Suitable the fitting of spark plug wire thread inserts.
- Excl. carrier adapted to length, to be ordered separately per diameter and length (d nom. x L) wire thread insert.
- Aluminium body with steel inside work.

71640 AMECOIL Complete manual fitting tool UNC

S91A

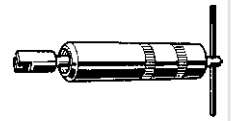

d	☒	Art.number	d	☒	Art.number	d	☒	Art.number
3/4	1	71640.191.001	7/8	1	71640.222.001	1 Inch	1	71640.254.001

- Complete manual fitting tool.
- Intended for the fitting of UNC wire thread inserts.
- Aluminium with steel inside work.

3

Nozzle and mandrel for manual fitting

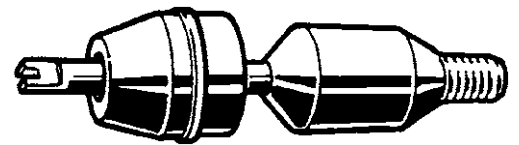

Article groups

Code	Page
71710	3-156
71711	3-157
71720	3-157
71740	3-157
71730	3-158

71710 AMECOIL Nozzle and mandrel for manual fitting Metric



S91A



d	☒	Art.number		
M3	1	71710.030.001	• Nozzle and mandrel for manual fitting tool no. 1 • Suitable for wire thread insert: M3	
M4	1	71710.040.001	• Nozzle and mandrel for manual fitting tool no. 1 • Suitable for wire thread insert: M4	
M5	1	71710.050.001	• Nozzle and mandrel for manual fitting tool no. 1 • Suitable for wire thread insert: M5	
M6	1	71710.060.001	• Nozzle and mandrel for manual fitting tool no. 2 • Suitable for wire thread insert: M6.	
M7	1	71710.070.001	• Nozzle and mandrel for manual fitting tool no. 2 • Suitable for wire thread insert: M7	
M8	1	71710.080.001	• Nozzle and mandrel for manual fitting tool no. 2 • Suitable for wire thread insert: M8	
M10	1	71710.100.001	• Nozzle and mandrel for manual fitting tool no. 3 • Suitable for wire thread insert: M10	
M12	1	71710.120.001	• Nozzle and mandrel for manual fitting tool no.3 • Suitable for wire thread insert: M12	
M14	1	71710.140.001	• Nozzle and mandrel for manual fitting tool no. 4 • Suitable for wire thread insert: M14	
M16	1	71710.160.001	• Nozzle and mandrel for manual fitting tool no. 4 • Suitable for wire thread insert: M16	

71711 AMECOIL Nozzle and mandrel for manual fitting Metric S91A



AMECA 

d		☒	Art.number		
M6-ASS1	1		71711.060.001	<ul style="list-style-type: none"> Nozzle and mandrel for manual fitting tool no. 3 (repair kit no.1) Suitable for wire thread insert: M6 	
M8-ASS1	1		71711.080.001	<ul style="list-style-type: none"> Nozzle and mandrel for manual fitting tool no. 3 (repair kit no. 1) Suitable for wire thread insert: M8 	

3







71720 AMECOIL Nozzle and mandrel for manual fitting Metric fine S91A

AMECA 

d x P		☒	Art.number		
M8X1,00	1		71720.080.100	<ul style="list-style-type: none"> Nozzle and mandrel for manual fitting tool no. 2 Suitable for wire thread insert: M8x1 	
M10X1,00	1		71720.100.100	<ul style="list-style-type: none"> Nozzle and mandrel for manual fitting tool no. 3 Suitable for wire thread insert: M10x1 	
M10X1,25	1		71720.100.125	<ul style="list-style-type: none"> Nozzle and mandrel for manual fitting tool no. 3 Suitable for wire thread insert: M10x1,25 	
M12X1,00	1		71720.120.100	<ul style="list-style-type: none"> Nozzle and mandrel for manual fitting tool no. 3 Suitable for wire thread insert: M12x1 	
M12X1,25	1		71720.120.125	<ul style="list-style-type: none"> Nozzle and mandrel for manual fitting tool no. 3 Suitable for wire thread insert: M12x1,25 	
M12X1,50	1		71720.120.150	<ul style="list-style-type: none"> Nozzle and mandrel for manual fitting tool no. 3 Suitable for wire thread insert: M12x1,5 	
M14X1,25	1		71720.140.125	<ul style="list-style-type: none"> Nozzle and mandrel for manual fitting tool no. 4 Suitable for wire thread insert: M14x1,25 	
M14X1,50	1		71720.140.150	<ul style="list-style-type: none"> Nozzle and mandrel for manual fitting tool no. 4 Suitable for wire thread insert: M14x1,5 	
M16X1,50	1		71720.160.150	<ul style="list-style-type: none"> Nozzle and mandrel for manual fitting tool no. 4 Suitable for wire thread insert: M16x1,5 	







71740 AMECOIL Nozzle and mandrel for manual fitting UNC S91A

AMECA 

d		☒	Art.number		
1/4	1		71740.063.001	<ul style="list-style-type: none"> Nozzle and mandrel for manual fitting tool no. 2 Suitable for wire thread insert: 1/4 UNC 	
5/16	1		71740.079.001	<ul style="list-style-type: none"> Nozzle and mandrel for manual fitting tool no. 2 Suitable for wire thread insert: 5/16 UNC 	
3/8	1		71740.096.001	<ul style="list-style-type: none"> Nozzle and mandrel for manual fitting tool no. 3 Suitable for wire thread insert: 3/8 UNC 	
7/16	1		71740.111.001	<ul style="list-style-type: none"> Nozzle and mandrel for manual fitting tool no. 3 Suitable for wire thread insert: 7/16 UNC 	
1/2	1		71740.127.001	<ul style="list-style-type: none"> Nozzle and mandrel for manual fitting tool no. 3 Suitable for wire thread insert: 1/2 UNC 	
9/16	1		71740.142.001	<ul style="list-style-type: none"> Nozzle and mandrel for manual fitting tool no. 4 Suitable for wire thread insert: 9/16 UNC 	

71740		AMECOIL Nozzle and mandrel for manual fitting UNC		←
d	<input type="checkbox"/>	Art.number		
5/8	1	71740.158.001	<ul style="list-style-type: none"> Nozzle and mandrel for manual fitting tool no. 4 Suitable for wire thread insert: 5/8 UNC 	

71730		AMECOIL Nozzle and mandrel for manual fitting UNF		S91A
				AMECA
				

d	<input type="checkbox"/>	Art.number		
1/4	1	71730.063.001	<ul style="list-style-type: none"> Nozzle and mandrel for manual fitting tool no. 2 Suitable for wire thread insert: 1/4 UNF 	
5/16	1	71730.079.001	<ul style="list-style-type: none"> Nozzle and mandrel for manual fitting tool no. 2 Suitable for wire thread insert: 5/16 UNF 	
3/8	1	71730.096.001	<ul style="list-style-type: none"> Nozzle and mandrel for manual fitting tool no. 3 Suitable for wire thread insert: 3/8 UNF 	
7/16	1	71730.111.001	<ul style="list-style-type: none"> Nozzle and mandrel for manual fitting tool no. 3 Suitable for wire thread insert: 7/16 UNF 	
1/2	1	71730.127.001	<ul style="list-style-type: none"> Nozzle and mandrel for manual fitting tool no. 3 Suitable for wire thread insert: 1/2 UNF 	
9/16	1	71730.142.001	<ul style="list-style-type: none"> Nozzle and mandrel for manual fitting tool no. 4 Suitable for wire thread insert: 9/16 UNF 	
5/8	1	71730.158.001	<ul style="list-style-type: none"> Nozzle and mandrel for manual fitting tool no. 4 Suitable for wire thread insert: 5/8 UNF 	

Carrier adapted

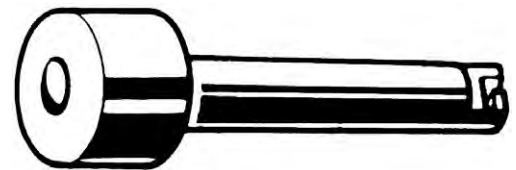

71950		AMECOIL Carrier adapted		S91A
				AMECA
				

d x P x L	<input type="checkbox"/>	Art.number	d x P x L	<input type="checkbox"/>	Art.number	d x P x L	<input type="checkbox"/>	Art.number
M12X1,25X10,5	1	71950.120.010	M14X1,25X7,5	1	71950.140.007	M14X1,25X18	1	71950.140.018
M12X1,25X18	1	71950.120.018	M14X1,25X10,5	1	71950.140.010			

- For manual fitting tool with nozzle.

Tang breaking tool



3

71810 AMECOIL Tang break S91A

For use with nr.	☒	Art.number	For use with nr.	☒	Art.number	For use with nr.	☒	Art.number
M3	1	71810.030.001	M7	1	71810.070.001	M14 - 9/16	1	71810.140.001
M4	1	71810.040.001	M8 - 5/16	1	71810.080.001	M16 - 5/8	1	71810.160.001
M5	1	71810.050.001	M10 - 3/8 - 7/16	1	71810.100.001	M18	1	71810.180.001
M6 - 1/4	1	71810.060.001	M12 - 1/2	1	71810.120.001			

- Intended to use for breaking off the engaging stem after fitting of the wire thread insert.
- ATTENTION: for sizes larger than M18 resp. 5/8 UNC/UNF a pointed plier has to be used.

Extractor

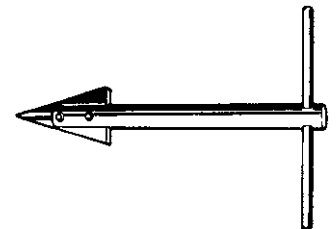

71860 AMECOIL Extractor S91A



No.	☒	Art.number	
NO.1	1	71860.000.001	<ul style="list-style-type: none"> • Suitable for wire thread insert: • M3 / M4 / M5 / M6 / M7 / M8 / 1/4 / 5/16
NO.2	1	71860.000.002	<ul style="list-style-type: none"> • Suitable for wire thread insert: • M5 / M6 / M7 / M8 / M10 / M12 / 1/4 / 5/16 / 3/8 / 7/16
NO.3	1	71860.000.003	<ul style="list-style-type: none"> • Suitable for wire thread insert: • M10 / M12 / M14 / M16 / M18 / M20 / M22 / M24 / 3/8 / 7/16 / 1/2 / 9/16 / 5/8

- Intended to use when an inserted wire thread insert has been poorly positioned and has to be extracted (metric / metric fine / UNC / UNF / BSW).
- ATTENTION: if the screwthread has not been damaged, a new wire thread insert can be fitted.

Thread repair kit Metric Rapid



3



71788	V-COIL Thread repair kit Metric Rapid	V01A
Material	Stainless steel A2	 

d (nom.) x P x L	☒	Art.number	d (nom.) x P x L	☒	Art.number	d (nom.) x P x L	☒	Art.number
M2,5X0,45X3,75	1	71788.025.045	M5X0,8X7,5	1	71788.050.080	M10X1,5X15	1	71788.100.150
M3X0,5X4,5	1	71788.030.050	M6X1,0X9	1	71788.060.100	M12X1,75X18	1	71788.120.175
M4X0,7X6	1	71788.040.070	M8X1,25X12	1	71788.080.125			

- Content:
- Inserting tool
- Tang break tool
- Machine tap
- Drill
- Bitholder
- Stainless steel A2 wire thread inserts acc. to DIN 8140: M2,5 - M10, 10 pieces / M12, 6 pieces.

Thread repair kit Metric



71760	V-COIL Thread repair kit Metric	V01A
Material	Stainless steel A2	 

d (nom.) x P x L	☒	Art.number	d (nom.) x P x L	☒	Art.number	d (nom.) x P x L	☒	Art.number
M2X0,4X3	1	71760.020.040	M10X1,5X15	1	71760.100.150	M18X1,5X24	1	71760.180.150
M2,5X0,45X3,75	1	71760.025.040	M11X1,5X16,5	1	71760.110.150	M18X2,0X24	1	71760.180.200
M3X0,5X4,5	1	71760.030.050	M12X1,0X18	1	71760.120.100	M18X2,5X24	1	71760.180.250
M3,5X0,6X5,25	1	71760.035.060	M12X1,25X18	1	71760.120.125	M20X1,5X30	1	71760.200.150
M4X0,7X6	1	71760.040.070	M12X1,5X18	1	71760.120.150	M20X2,0X30	1	71760.200.200
M5X0,8X7,5	1	71760.050.080	M12X1,75X18	1	71760.120.175	M20X2,5X30	1	71760.200.250
M6X1,0X9	1	71760.060.100	M14X1,0X21	1	71760.140.100	M22X1,5X33	1	71760.220.150
M7X1,0X10,5	1	71760.070.100	M14X1,25X21	1	71760.140.125	M22X2,0X33	1	71760.220.200
M8X1,0X12	1	71760.080.100	M14X1,5X21	1	71760.140.150	M22X2,5X33	1	71760.220.250
M8X1,25X12	1	71760.080.125	M14X2,0X21	1	71760.140.200	M24X1,5X36	1	71760.240.150
M9X1,25X13,5	1	71760.090.125	M16X1,5X24	1	71760.160.150	M24X2,0X36	1	71760.240.200
M10X1,0X15	1	71760.100.100	M16X2,0X24	1	71760.160.200	M24X3,0X36	1	71760.240.300
M10X1,25X15	1	71760.100.125						

- Content:
- Inserting tool.
- Tang break tool (up to and including M12); for > M12 use long nose pliers.
- Machine tap.
- Drill (up to and including M12); for > M12 order drill separately.
- Stainless steel A2 wire thread inserts acc. to DIN 8140: M2 - M8, 20 pieces / M9 - M10, 15 pieces / M11 - M16, 10 pieces / M18 - M24, 5 pieces.

Thread repair kit Non Metric



3

Article groups

Material	Code	Page
St.St. A2	71766	3-161
St.St. A2	71768	3-161
St.St. A2	71770	3-161
St.St. A2	71772	3-162

71766 V-COIL Thread repair kit UNC V01A

Material	Stainless steel A2		
-----------------	--------------------	---	---

d (nom.) x L	☒	Art.number	d (nom.) x L	☒	Art.number	d (nom.) x L	☒	Art.number
NO.2X3,28	1	71766.021.001	NO.12X8,23	1	71766.054.001	9/16X21,4	1	71766.142.001
NO.4X4,27	1	71766.028.001	1/4X9,5	1	71766.063.001	5/8X23,8	1	71766.158.001
NO.5X4,76	1	71766.031.001	5/16X11,9	1	71766.079.001	3/4X28,6	1	71766.191.001
NO.6X5,26	1	71766.035.001	3/8X14,3	1	71766.096.001	7/8X33,3	1	71766.222.001
NO.8X6,25	1	71766.041.001	7/16X16,7	1	71766.111.001	1 Inch X38,1	1	71766.254.001
NO.10X7,24	1	71766.048.001	1/2X19,1	1	71766.127.001			

- Content:
- Inserting tool
- Tang break tool (up to and including 1/2x19,1); for > 1/2x19,1 use long nose pliers.
- Machine tap
- Drill (up to and including 1/2x19,1); for > 1/2x19,1 order drill separately.
- Stainless steel A2 wire thread inserts acc. to DIN 8140: No.2 - 5/16, 20 pieces / 3/8 - 15 pieces / 7/16 - 5/8, 10 pieces / 3/4 - 7/8, 5 pieces / 1.IN., 4 pieces.



71768 V-COIL Thread repair kit UNF V01A

Material	Stainless steel A2		
-----------------	--------------------	---	---

d (nom.) x L	☒	Art.number	d (nom.) x L	☒	Art.number	d (nom.) x L	☒	Art.number
NO.4X4,27	1	71768.028.001	5/16X11,9	1	71768.079.001	5/8X23,8	1	71768.158.001
NO.6X5,26	1	71768.035.001	3/8X14,3	1	71768.096.001	3/4X28,6	1	71768.191.001
NO.8X6,25	1	71768.041.001	7/16X16,7	1	71768.111.001	7/8X33,3	1	71768.222.001
NO.10X7,24	1	71768.048.001	1/2X19,1	1	71768.127.001	1 Inch X38,1	1	71768.254.001
1/4X9,5	1	71768.063.001	9/16X21,4	1	71768.142.001			

- Content:
- Inserting tool
- Tang break tool (up to and including 1/2x19,1); for > 1/2x20 use long nose pliers.
- Machine tap
- Drill (up to and including 1/2x19,1); for > 1/2x19,1 order drill separately.
- Stainless steel A2 wire thread inserts acc. to DIN 8140: No.4 - 5/16, 20 pieces / 3/8 - 15 pieces / 7/16 - 5/8, 10 pieces / 3/4 - 7/8, 5 pieces / 1.IN., 4 pieces.

71770 V-COIL Thread repair kit BSW V01A

Material	Stainless steel A2		
-----------------	--------------------	---	---

d (nom.) x L	☒	Art.number	d (nom.) x L	☒	Art.number	d (nom.) x L	☒	Art.number
1/8X4,75	1	71770.031.001	3/8X14,3	1	71770.096.001	5/8X23,8	1	71770.158.001
3/16X7,14	1	71770.047.001	7/16X16,7	1	71770.111.001	3/4X28,6	1	71770.191.001
1/4X9,5	1	71770.063.001	1/2X19,1	1	71770.127.001	7/8X33,3	1	71770.222.001
5/16X11,9	1	71770.079.001	9/16X21,4	1	71770.142.001	1 Inch X38,1	1	71770.254.001

71770 V-COIL Thread repair kit BSW

- Content:
- Inserting tool
- Tang break tool (up to and including 1/2x19,1); for > 1/2x20 use long nose pliers.
- Machine tap
- Drill (up to and including 1/2x19,1); for > 1/2x19,1 order drill separately.
- Stainless steel A2 wire thread inserts acc. to DIN 8140: 1/8 - 5/16, 20 pieces / 3/8 - 15 pieces / 7/16 - 5/8, 10 pieces / 3/4 - 7/8, 5 pieces / 1.IN., 4 pieces.

71772 V-COIL Thread repair kit BSF
V01A
Material Stainless steel A2

d (nom.) x L	☒	Art.number	d (nom.) x L	☒	Art.number	d (nom.) x L	☒	Art.number
3/16X7,14	1	71772.047.001	7/16X16,7	1	71772.111.001	3/4X28,6	1	71772.191.001
1/4X9,5	1	71772.063.001	1/2X19,1	1	71772.127.001	7/8X33,3	1	71772.222.001
5/16X11,9	1	71772.079.001	9/16X21,4	1	71772.142.001	1.INX38,1	1	71772.254.001
3/8X14,3	1	71772.096.001	5/8X23,8	1	71772.158.001			

- Content:
- Inserting tool
- Tang break tool (up to and including 1/2x19,1); for > 1/2x20 use long nose pliers.
- Machine tap
- Drill (up to and including 1/2x19,1); for > 1/2x19,1 order drill separately.
- Stainless steel A2 wire thread inserts acc. to DIN 8140: 3/16 - 5/16, 20 pieces / 3/8 - 15 pieces / 7/16 - 5/8, 10 pieces / 3/4 - 7/8, 5 pieces / 1.IN., 4 pieces.

Thread repair kit spark plug

71764 V-COIL Thread repair kit spark plug
V01A
Material Stainless steel A2

d (nom.) x P x L	☒	Art.number	d (nom.) x P x L	☒	Art.number	d (nom.) x P x L	☒	Art.number
M6X1,0X9	1	71764.060.100	M10X1,25X15	1	71764.100.125	M14X1,25X21	1	71764.140.125
M8X1,25X12	1	71764.080.125	M10X1,5X15	1	71764.100.150	M18X1,5X24	1	71764.180.150
M10X1,0X15	1	71764.100.100	M12X1,25X18	1	71764.120.125			

- Content:
- Inserting tool
- Machine tap
- Stainless steel A2 wire thread inserts acc. to DIN 8140: M6 - M12, 10 pieces (L=1,5d) / M14, 3x5 pieces (L=8,4mm/12,4mm/16,4mm) / M18, 5 pieces (L=1,5d).

Assortment Metric



71762	V-COIL Assortment Metric	V01A
Material	Stainless steel A2	



Size	☒	Art.number		
M5-M12	1	71762.000.001	Assortment with/for metric wire inserts. Content: <ul style="list-style-type: none"> • Inserting tool for each diameter. • Tang break tool for each diameter. • Machine tap for each diameter. • Drill for each diameter. • M5-M6-M8-M10; for each diameter 25 stainless steel A2 wire thread inserts acc. DIN 8140. • M12; 10 stainless steel A2 wire thread inserts acc. DIN 8140. 	
M6-M14X1,25	1	71762.000.002	Assortment with/for metric wire inserts. Content: <ul style="list-style-type: none"> • Inserting tool for each diameter. • Tang break tool for each diameter except for M14 (use long nose pliers instead). • Machine tap for each diameter. • Drill for each diameter except for M14 (order separately). • M6-M8-M10; for each diameter 25 stainless steel A2 wire thread inserts acc. DIN 8140. • M12-M14x1,25; for each diameter 10 stainless steel A2 wire thread inserts acc. DIN 8140. 	
M6-M14X1,25/PT	1	71762.000.003	Assortment with/for metric wire inserts sparkplug. Content: <ul style="list-style-type: none"> • Inserting tool for each diameter. • Tang break tool for each diameter except for M14 (use long nose pliers instead). • Machine tap for each diameter. • Drill for each diameter except for M14 (order separately). • M6-M8-M10; for each diameter 25 stainless steel A2 wire thread inserts acc. DIN 8140. • M12-M14x1,25; for each diameter 10 stainless steel A2 wire thread inserts acc. DIN 8140. 	
M6-M10	1	71762.000.004	Assortment with/for metric wire inserts. Content: <ul style="list-style-type: none"> • Inserting tool for each diameter. • Tang break tool for each diameter. • Machine tap for each diameter. • Drill for each diameter. • M6-M8-M10; for each diameter 25 stainless steel A2 wire thread inserts acc. DIN 8140. 	

Thread repair kit Metric Rapid



3

71790	V-COIL Thread repair kit Metric Rapid	V01A
Material	Stainless steel A2	 



Size	☒	Art.number		
M5-M12	1	71790.000.001	Assortment with/for metric wire inserts Rapid. Content:	
			<ul style="list-style-type: none"> • Inserting tool for each diameter. • Tang break tool for each diameter. • Machine tap for each diameter. • Drill for each diameter. • Bitholder • M5-M6-M8-M10-M12; for each diameter 10 stainless steel A2 wire thread inserts acc. DIN 8140. 	
M6-M10	1	71790.000.002	Assortment with/for metric wire inserts Rapid. Content:	
			<ul style="list-style-type: none"> • Inserting tool for each diameter. • Tang break tool for each diameter. • Machine tap for each diameter. • Drill for each diameter. • Bitholder • M6-M8-M10; for each diameter 10 stainless steel A2 wire thread inserts acc. DIN 8140. 	

Assortment Non-Metric



Article groups

Material	Code	Page
St.St. A2	71774	3-164
St.St. A2	71776	3-165
St.St. A2	71778	3-165
St.St. A2	71780	3-165



71774	V-COIL Assortment	V01A
Material	Stainless steel A2	 

Size	☒	Art.number		
1/4-1/2	1	71774.000.001	Assortment with/for UNC wire inserts. Content:	
			<ul style="list-style-type: none"> • Inserting tool for each diameter. • Tang break tool for each diameter. • Machine tap for each diameter. • Drill for each diameter. • Stainless steel A2 wire thread inserts acc. DIN 8140: 1/4-5/16-3/8 - 25 pieces / 7/16-1/2 - 10 pieces. 	

71776	V-COIL Assortment		V01A
Material	Stainless steel A2		 

Size	<input checked="" type="checkbox"/>	Art.number	
1/4-1/2	1	71776.000.001	Assortment with/for UNF wire inserts. Content: <ul style="list-style-type: none"> • Inserting tool for each diameter. • Tang break tool for each diameter. • Machine tap for each diameter. • Drill for each diameter. • Stainless steel A2 wire thread inserts acc. DIN 8140: 1/4-5/16-3/8 - 25 pieces / 7/16-1/2 - 10 pieces. 

3

71778	V-COIL Assortment		V01A
Material	Stainless steel A2		 

Size	<input checked="" type="checkbox"/>	Art.number	
1/4-1/2	1	71778.000.001	Assortment with/for BSW wire inserts. Content: <ul style="list-style-type: none"> • Inserting tool for each diameter. • Tang break tool for each diameter. • Machine tap for each diameter. • Drill for each diameter. • Stainless steel A2 wire thread inserts acc. DIN 8140: 1/4-5/16-3/8 - 25 pieces / 7/16-1/2 - 10 pieces. 

71780	V-COIL Assortment		V01A
Material	Stainless steel A2		 

Size	<input checked="" type="checkbox"/>	Art.number	
1/4-1/2	1	71780.000.001	Assortment with/for BSF wire inserts. Content: <ul style="list-style-type: none"> • Inserting tool for each diameter. • Tang break tool for each diameter. • Machine tap for each diameter. • Drill for each diameter. • Stainless steel A2 wire thread inserts acc. DIN 8140: 1/4-5/16-3/8 - 25 pieces / 7/16-1/2 - 10 pieces. 

Tools for wire thread inserts V-COIL















3













Article groups

Material	Code	Page
St	71782	3-166
St	71784	3-167
St	71786	3-168









71782	V-COIL Tang break tool	V01A
Material	Steel	 



No.	☒	Art.number		
NO.2	1	71782.020.001	<ul style="list-style-type: none"> Suitable for wire thread insert: M2 / M2,2 / UNC No.2 	
NO.3	1	71782.030.001	<ul style="list-style-type: none"> Suitable for wire thread insert: M2,5 	
NO.4	1	71782.040.001	<ul style="list-style-type: none"> Suitable for wire thread insert: M3 / UNC-UNF No.4 	
NO.5	1	71782.050.001	<ul style="list-style-type: none"> Suitable for wire thread insert: M3,5 / UNC-UNF No.6 	
NO.6	1	71782.060.001	<ul style="list-style-type: none"> Suitable for wire thread insert: M4 / UNC-UNF No.8 / UNC No.10 / BSF 3/16 	
NO.8	1	71782.080.001	<ul style="list-style-type: none"> Suitable for wire thread insert: M5 / UNF No.10 / UNC No.12 / BSW 3/16 	
NO.9	1	71782.090.001	<ul style="list-style-type: none"> Suitable for wire thread insert: M6 / UNC-UNF-BSW-BSF 1/4 	
NO.11	1	71782.110.001	<ul style="list-style-type: none"> Suitable for wire thread insert: M7 / M8 / UNC-UNF-BSW-BSF 5/16 	
NO.12	1	71782.120.001	<ul style="list-style-type: none"> Suitable for wire thread insert: M9 / UNC-BSW-BSF 3/8 	
NO.13	1	71782.130.001	<ul style="list-style-type: none"> Suitable for wire thread insert: M10 / UNF 3/8 	
NO.14	1	71782.140.001	<ul style="list-style-type: none"> Suitable for wire thread insert: M11 / UNC-UNF-BSW-BSF 7/16 	
NO.15	1	71782.150.001	<ul style="list-style-type: none"> Suitable for wire thread insert: M12 / UNC-UNF-BSW-BSF 1/2 	



71784	V-COIL Inserting tool	V01A
Material	Steel	 

No.	☒	Art.number		
NO.2	1	71784.020.001	<ul style="list-style-type: none"> • Suitable for wire thread insert: M2 / M2,2 / UNC No.2 	
NO.3	1	71784.030.001	<ul style="list-style-type: none"> • Suitable for wire thread insert: M2,5 	
NO.4	1	71784.040.001	<ul style="list-style-type: none"> • Suitable for wire thread insert: M3 / UNC-UNF No.4 / UNC No.5 / BSW 1/8 	
NO.5	1	71784.050.001	<ul style="list-style-type: none"> • Suitable for wire thread insert: M3,5 / UNC-UNF No.6 	
NO.6	1	71784.060.001	<ul style="list-style-type: none"> • Suitable for wire thread insert: M4 / UNC-UNF No.8 	
NO.7	1	71784.070.001	<ul style="list-style-type: none"> • Suitable for wire thread insert: BSW 3/16 / UNC No.10 	
NO.8	1	71784.080.001	<ul style="list-style-type: none"> • Suitable for wire thread insert: M5 / UNF No.10 / UNC No.12 / BSW 3/16 	
NO.9	1	71784.090.001	<ul style="list-style-type: none"> • Suitable for wire thread insert: M6 / UNC-UNF-BSW-BSF 1/4 	
NO.10	1	71784.100.001	<ul style="list-style-type: none"> • Suitable for wire thread insert: M7 / UNC-BSW 5/16 	
NO.11	1	71784.110.001	<ul style="list-style-type: none"> • Suitable for wire thread insert: M8 / UNF-BSF 5/16 	
NO.12	1	71784.120.001	<ul style="list-style-type: none"> • Suitable for wire thread insert: M9 / UNC-BSW 3/8 	
NO.13	1	71784.130.001	<ul style="list-style-type: none"> • Suitable for wire thread insert: M10 / UNF-BSF 3/8 	
NO.14	1	71784.140.001	<ul style="list-style-type: none"> • Suitable for wire thread insert: M11 / UNC-UNF-BSW-BSF 7/16 	

3

71784		V-COIL Inserting tool				←
No.	☒	Art.number				
NO.15	1	71784.150.001	<ul style="list-style-type: none"> Suitable for wire thread insert: M12 / UNC-UNF-BSW-BSF 1/2 			
NO.16	1	71784.160.001	<ul style="list-style-type: none"> Suitable for wire thread insert: M14 / UNC-UNF-BSW-BSF 9/16 			
NO.17	1	71784.170.001	<ul style="list-style-type: none"> Suitable for wire thread insert: M14 			
NO.18	1	71784.180.001	<ul style="list-style-type: none"> Suitable for wire thread insert: M16 / UNC-UNF-BSW-BSF 5/8 			
NO.20	1	71784.200.001	<ul style="list-style-type: none"> Suitable for wire thread insert: M18 / UNC- BSW-BSF 3/4 			
NO.21	1	71784.210.001	<ul style="list-style-type: none"> Suitable for wire thread insert: M11 / UNC-UNF-BSW-BSF 7/16 			
NO.22	1	71784.220.001	<ul style="list-style-type: none"> Suitable for wire thread insert: M22 / UNC-UNF-BSW-BSF 7/8 			
NO.23	1	71784.230.001	<ul style="list-style-type: none"> Suitable for wire thread insert: M24 / UNC-UNF-BSW-BSF 1.IN. 			

71786		V-COIL Extracting tool				V01A
Material	Steel					

No.	☒	Art.number			
NO.2	1	71786.020.001	<ul style="list-style-type: none"> Suitable for wire thread insert: M3 - M10 / 3/16 - 3/8 		
NO.3	1	71786.030.001	<ul style="list-style-type: none"> Suitable for wire thread insert: M11 - M24 / 3/8 - 1.IN. 		

Tools for wire thread inserts V-COIL Rapid



3

Article groups

Material	Code	Page
St	71792	3-169
St	71794	3-169
St	71796	3-169
St	71798	3-170

71792 V-COIL Drill Rapid V01A

Material	Steel	 
-----------------	-------	---

d = For nom. size.	☒	Art.number	d = For nom. size.	☒	Art.number	d = For nom. size.	☒	Art.number
2,6MM	1	71792.000.026	5,2MM	1	71792.000.052	10,4MM	1	71792.000.104
3,2MM	1	71792.000.032	6,3MM	1	71792.000.063	12,4MM	1	71792.000.124
4,2MM	1	71792.000.042	8,3MM	1	71792.000.083			

71794 V-COIL Machine tap Rapid V01A

Material	Steel	 
-----------------	-------	---

d (nom.) x P	☒	Art.number	d (nom.) x P	☒	Art.number	d (nom.) x P	☒	Art.number
M2,5X0,45	1	71794.025.045	M5X0,8	1	71794.050.080	M10X1,5	1	71794.100.150
M3X0,5	1	71794.030.050	M6X1,0	1	71794.060.100	M12X1,75	1	71794.120.175
M4X0,7	1	71794.040.070	M8X1,25	1	71794.080.125			

71796 V-COIL Tang break tool Rapid V01A

Material	Steel	 
-----------------	-------	---

No.	☒	Art.number	
NO.3	1	71796.030.001	• Suitable for wire thread insert: • M2,5
NO.4	1	71796.040.001	• Suitable for wire thread insert: • M3
NO.6	1	71796.060.001	• Suitable for wire thread insert: • M4
NO.8	1	71796.080.001	• Suitable for wire thread insert: • M5





3

71796 V-COIL Tang break tool Rapid ←

No.	<input type="checkbox"/>	Art.number		
NO.9	1	71796.090.001	• Suitable for wire thread insert: • M6	
NO.11	1	71796.110.001	• Suitable for wire thread insert: • M8	
NO.13	1	71796.130.001	• Suitable for wire thread insert: • M10	
NO.15	1	71796.150.001	• Suitable for wire thread insert: • M12	

71798 V-COIL Extracting tool Rapid V01A

Material: Steel

d = For nom. size.	<input type="checkbox"/>	Art.number	d = For nom. size.	<input type="checkbox"/>	Art.number	d = For nom. size.	<input type="checkbox"/>	Art.number
M2,5	1	71798.025.001	M5	1	71798.050.001	M10	1	71798.100.001
M3	1	71798.030.001	M6	1	71798.060.001	M12	1	71798.120.001
M4	1	71798.040.001	M8	1	71798.080.001			

FABORY Self-cutting threaded inserts

General

The principle of the FABORY self-cutting threaded insert is quite simple. Not only "soft" materials i.e. aluminium, copper, brass, plastic and hardwood, but also metal with a tensile-strength of up to 420 N/mm² can easily be fitted with a reliable metric screw thread, and pretapping, is not necessary. Worn and damaged screw threads can now be quickly and easily repaired with a FABORY self-cutting threaded insert.

Function

The FABORY self-cutting threaded insert uses an external thread to cut its way into the workpiece, and the metric internal thread offers an exceptional fixing with high-tensile values.

Fitting

For fitting the FABORY self-tapping thread inserts, three handy tools are available:

- hand tool **type 610**
- hand/machine tool **type 620**
- hand/machine tool **type 6102**
 - exclusively suitable for the FABORY self-tapping thread inserts with a hexagon socket, **types 302 2 and 308 2**

For application in materials with a high tensile strength, we recommend:

- the use of a suitable lubricant, and/or
- pre-tapping with hand tap no. 1 (taper tap, marked with one ring)

Types of thread insert

- **Type 302**, provided with two flutes and:
 - o in steel version, applicable in somewhat softer materials, with a tensile strength up to 300 N/mm²
 - o in stainless steel version, applicable in materials with a tensile strength up to 320 N/mm²
- **Type 307**, provided with three radial cutting holes, and applicable in somewhat harder materials, with a tensile strength from 360 to 420 N/mm²
- **Type 308**, same as type 307, but this type is the longer version of type 307
- **Type 302 2**, provided with two flutes, with hexagon socket, and applicable in somewhat softer materials with a tensile strength up to 300 N/mm²
- **Type 308 2**, provided with three radial cutting holes, with hexagon socket, long version, and applicable in somewhat harder materials, with a tensile strength from 360 to 420 N/mm²

Hole diameters		Guidelines for type 302				Guidelines for types 307 and 308			
workpiece material	light metal with tensile strength R_m (N/mm ²)	$R_m < 250$				$R_m < 300$			
		$R_m < 300$				$R_m < 350$			
		$R_m < 350$				$R_m > 350$			
	Brass, bronze, non-ferrous metal					$R_m > 350$			
Cast iron HB = Brinell hardness	HB < 150				HB < 150				
	HB < 200				HB < 200				
	HB > 200				HB > 200				
thread insert internal thread	M3		4,6	4,7	4,8	4,6	4,7	4,8	
	M4	5,9	6,0	6,1	6,2	6,0	6,1	6,2	
	M5	7,2	7,3	7,5	7,6	7,4	7,5	7,6	7,7
	M6	8,8	9,0	9,2	9,4	9,3	9,4	9,5	9,6
	M8	10,8	11,0	11,2	11,4	11,1	11,2	11,3	11,5
	M10	12,8	13,0	13,2	13,4	13,1	13,2	13,3	13,5
	M12	14,8	15,0	15,2	15,4	15,0	15,1	15,2	15,4
	M14	16,8	17,0	17,2	17,4	17,0	17,1	17,2	17,4
	M16	18,8	19,0	19,2	19,4	19,0	19,1	19,2	19,4
	M20	24,8	25,0	25,2	25,4				
	M24	28,8	29,0	29,2	29,4				
M27	32,8	33,0	33,2	33,4					
M30	34,8	35,0	35,2	35,4					
Flank overlap approx.		60 %	50 %	40 %	30 %	80 %	70 %	60 %	50 %

Recommended hole diameters for problem-free fitting. For the other hole diameters, lubrication or pre-tapping may be necessary.

Assembly sequence:

- 1) bore hole (see table above)
- 2) countersink hole (recommended)
- 3) screw insertion device into thread insert
- 4) screw thread insert in to approx. 0.1 to 0.2 mm below surface of workpiece
- 5) remove insertion device
- 6) component can be fitted

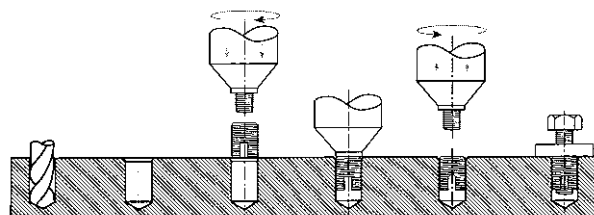

Self-cutting threaded insert type 302

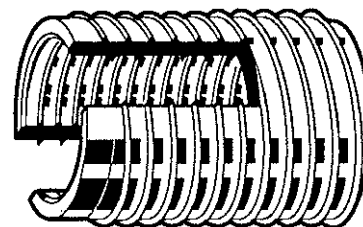
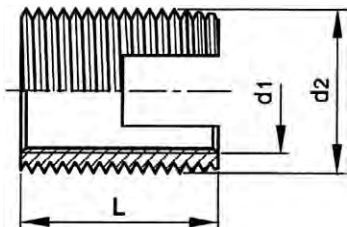

3

Technical Data

$d_1 \times L$	d_2	Drill depth (min.)	P (d_1)	P (d_2)
M3x6	5	8	0.5	0.5
M4x8	6.5	10	0.7	0.75
M5x10	8	13	0.8	1
M6x10	10	13	1	1.5
M6x12	10	15	1	1.5
M6x14	10	17	1	1.5
M8x12	12	15	1.25	1.5
M8x15	12	18	1.25	1.5
M10x15	14	18	1.5	1.5
M10x18	14	22	1.5	1.5
M12x22	16	26	1.75	1.5
M14x24	18	28	2	1.5
M16x22	20	27	2	1.5
M20x27	26	32	2.5	1.5
M24x30	30	36	3	1.5
M27x30	34	36	3.5	1.5
M30x40	36	46	3.5	1.5

- Drill depth (min.) = Minimum bore depth for blind holes.

Article groups

Thread	Material	Surface treatment	Code	Page
M	St Case-hardened	Zipl yell.p.	71550	3-172
M	St.St. A1		71566	3-172
M	St.St. C4		71560	3-173

71550 Self-cutting threaded insert type 302

S93A

Thread Metric thread
Material Steel Case-hardened
Surface treatment Zinc plated yellow passivated

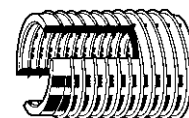

$d_1 \times L$	☒	Art.number	$d_1 \times L$	☒	Art.number	$d_1 \times L$	☒	Art.number
M3X6	50	71550.030.001	M8X15	50	71550.080.001	M16X22	25	71550.160.001
M4X8	50	71550.040.001	M8X12	50	71550.080.012	M20X27	10	71550.200.001
M5X10	50	71550.050.001	M10X18	25	71550.100.001	M24X30	10	71550.240.001
M6X14	50	71550.060.001	M10X15	25	71550.100.015	M27X30	5	71550.270.001
M6X10	50	71550.060.010	M12X22	25	71550.120.001	M30X40	5	71550.300.001
M6X12	50	71550.060.012	M14X24	25	71550.140.001			

- For use in materials with tensile strength up to 300 N/mm².
- Light metal alloys, cast iron, brass, bronze, non-ferrous metals, plastics and hardwoods.

71566 Self-cutting threaded insert type 302

S93A

Thread Metric thread
Material Stainless steel A1

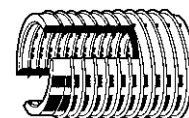

$d_1 \times L$	☒	Art.number	$d_1 \times L$	☒	Art.number	$d_1 \times L$	☒	Art.number
M3X6	25	71566.030.001	M6X14	25	71566.060.001	M12X22	10	71566.120.001
M4X8	25	71566.040.001	M8X15	25	71566.080.001	M16X22	10	71566.160.001
M5X10	25	71566.050.001	M10X18	10	71566.100.001			

- For use in materials with tensile strength up to 320 N/mm².

71560 Self-cutting threaded insert type 302		S93A
Thread	Metric thread	
Material	Stainless steel C4	

$d_1 \times L$	☒	Art.number	$d_1 \times L$	☒	Art.number	$d_1 \times L$	☒	Art.number
M3X6	25	71560.030.001	M6X14	25	71560.060.001	M12X22	10	71560.120.001
M4X8	25	71560.040.001	M8X15	25	71560.080.001	M16X22	10	71560.160.001
M5X10	25	71560.050.001	M10X18	10	71560.100.001			

- For use in materials with tensile strength up to 320 N/mm².

Self-cutting threaded insert type 307/308

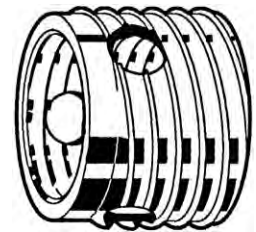
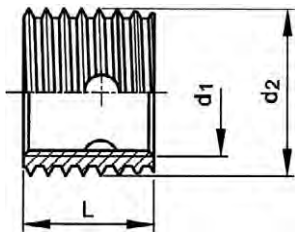

Technical Data				
$d_1 \times L$	d_2	Drill depth (min.)	P (d_1)	P (d_2)
M3x4	5	6	0.5	0.6
M3x6	5	8	0.5	0.6
M4x6	6.5	8	0.7	0.8
M4x8	6.5	10	0.7	0.8
M5x7	8	9	0.8	1
M5x10	8	13	0.8	1
M6x8	10	10	1	1.25
M6x12	10	15	1	1.25
M8x9	12	11	1.25	1.5
M8x14	12	17	1.25	1.5
M10x10	14	13	1.5	1.5
M10x18	14	22	1.5	1.5
M12x12	16	15	1.75	1.75
M12x22	16	26	1.75	1.75
M16x14	20	17	2	2
M16x24	20	28	2	2

- Drill depth (min.) = Minimum bore depth for blind holes.

Article groups				
Thread	Material	Surface treatment	Code	Page
M	St	Zipl yell.p.	307	71552
M	St	Zipl yell.p.	308	71554

71552 Self-cutting threaded insert type 307		S93A
Thread	Metric thread	
Material	Steel	
Surface treatment	Zinc plated yellow passivated	

$d_1 \times L$	☒	Art.number	$d_1 \times L$	☒	Art.number	$d_1 \times L$	☒	Art.number
M3X4	50	71552.030.001	M6X8	50	71552.060.001	M12X12	25	71552.120.001
M4X6	50	71552.040.001	M8X9	50	71552.080.001	M16X14	25	71552.160.001
M5X7	50	71552.050.001	M10X10	25	71552.100.001			

- For use in materials with tensile strength from 360 to 420 N/mm².
- Aluminium and aluminium alloys, magnesium alloys, duroplastic and thermoplastic polymers.

71554 Self-cutting threaded insert type 308		S93A	
Thread	Metric thread		
Material	Steel		
Surface treatment	Zinc plated yellow passivated		

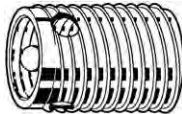

$d_1 \times L$	☒	Art.number	$d_1 \times L$	☒	Art.number	$d_1 \times L$	☒	Art.number
M3X6	50	71554.030.001	M6X12	50	71554.060.001	M12X22	25	71554.120.001
M4X8	50	71554.040.001	M8X14	50	71554.080.001	M16X24	25	71554.160.001
M5X10	50	71554.050.001	M10X18	25	71554.100.001			

3

- For use in materials with tensile strength from 360 to 420 N/mm².
- Aluminium and aluminium alloys, magnesium alloys, duroplastic and thermoplastic polymers.

Self-cutting threaded insert with hexagon socket type 302 2

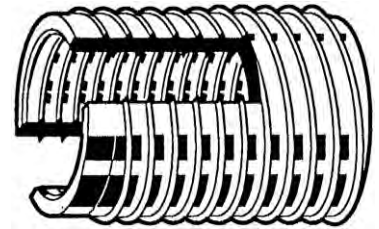
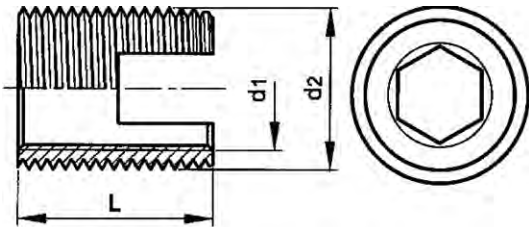

Technical Data

$d_1 \times L$	d_2	Drill depth (min.)	P (d_1)	P (d_2)	S (+0,1mm)	Thickness
M4x8	6.5	10	0.7	0.75	3.2	8
M5x10	8	13	0.8	1	4.1	10
M6x14	10	17	1	1.5	4.9	14
M8x15	12	18	1.25	1.5	6.6	15
M10x18	14	22	1.5	1.5	8.3	18
M12x22	16	27	1.75	1.5	10.1	22

- Drill depth (min.) = Minimum bore depth for blind holes.
- Thickness = min. material thickness.
- S = W.a.f. hexagon socket.

71551 Self-cutting threaded insert with hexagon socket type 302 2		S93A	
Thread	Metric thread		
Material	Steel Case-hardened		
Surface treatment	Zinc plated yellow passivated		

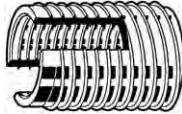

$d_1 \times L$	☒	Art.number	$d_1 \times L$	☒	Art.number	$d_1 \times L$	☒	Art.number
M4X8	50	71551.040.008	M6X14	50	71551.060.014	M10X18	25	71551.100.018
M5X10	50	71551.050.010	M8X15	50	71551.080.015	M12X22	25	71551.120.022

- For use in materials with tensile strength up to 300 N/mm².
- Light metal alloys, cast iron, brass, bronze, non-ferrous metals, plastics and hardwoods.
- Advantages of the self-cutting thread inserts with hexagon socket:
- Thread insert does not have to be screwed onto device: saves up to 50% of fitting time.
- Simple insertion tool type 6102: use with tommy bar or optionally by machine.
- Insertion device only needs to turn clockwise.
- Thread inserts are simple to unscrew.

Self-cutting threaded insert with hexagon socket type 308 2

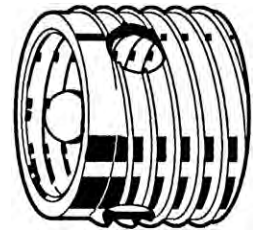
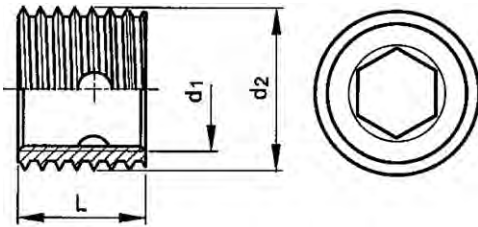

Technical Data

$d_1 \times L$	d_2	Drill depth (min.)	P (d_1)	P (d_2)	S (+0,1mm)	Thickness
M4x8	6.5	10	0.7	0.8	3.2	8
M5x10	8	13	0.8	1	4.1	10
M6x12	10	15	1	1.25	4.9	12
M8x14	12	17	1.25	1.5	6.6	14
M10x18	14	22	1.5	1.5	8.3	18
M12x22	16	26	1.75	1.75	10.1	22

- Drill depth (min.) = Minimum bore depth for blind holes.
- Thickness = min. material thickness.
- S = W.a.f. hexagon socket.

71556 Self-cutting threaded insert with hexagon socket type 308 2

S93A

Thread	Metric thread
Material	Steel Case-hardened
Surface treatment	Zinc plated yellow passivated



$d_1 \times L$	☒	Art.number	$d_1 \times L$	☒	Art.number	$d_1 \times L$	☒	Art.number
M4X8	50	71556.040.008	M6X12	50	71556.060.012	M10X18	25	71556.100.018
M5X10	50	71556.050.010	M8X14	50	71556.080.014	M12X22	25	71556.120.022

- For use in materials with tensile strength from 360 to 420 N/mm².
- Aluminium and aluminium alloys, magnesium alloys, duroplastic and thermoplastic polymers.
- Advantages of the self-tapping thread inserts with hexagon socket:
- Thread insert does not have to be screwed onto device: saves up to 50% of fitting time.
- Simple insertion tool type 6102: use with tommy bar or optionally by machine.
- Insertion device only needs to turn clockwise.
- Thread inserts are simple to unscrew.

Self-cutting threaded insert tool type 610

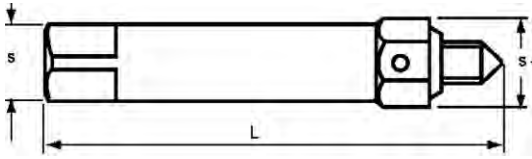

3

Technical Data

d ₁	L	S	S ₁	d ₁	L	S	S ₁
M3	55	5	7	M8	75	8	13
M4	60	5	7	M10	95	12.5	19
M5	75	8	13	M12	95	12.5	19
M6	75	8	13				

- L = Total length.
- S = Square s.
- S₁ = Contra-nut s.
- For manual insertion of self-tapping thread inserts types 302, 307 and 308 (with aid of tommy bar and open-ended spanner).

71595	Self-cutting threaded insert tool type 610	S94A
Material	Steel	

Nom. size d ₁	☒	Art.number	Nom. size d ₁	☒	Art.number	Nom. size d ₁	☒	Art.number
M3	1	71595.030.001	M6	1	71595.060.001	M10	1	71595.100.001
M4	1	71595.040.001	M8	1	71595.080.001	M12	1	71595.120.001
M5	1	71595.050.001						

- No spare parts are available for this hand tool.

Self-cutting threaded insert tool type 620

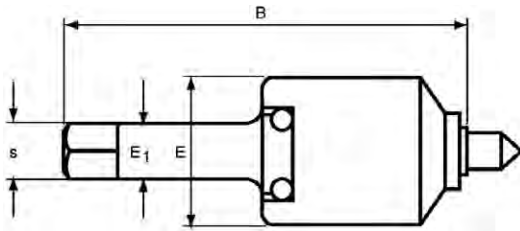

Technical Data

d ₁	B	E	E ₁	S	d ₁	B	E	E ₁	S
M3	78	18	8	6.3	M14	145	50	25	20
M4	78	18	8	6.3	M16	145	50	25	20
M5	95	24	12.5	10	M20	169	58	25	20
M6	95	24	12.5	10	M24	198	70	30	25
M8	95	24	12.5	10	M27	198	70	30	25
M10	118	32	16	12.5	M30	198	70	30	25
M12	118	32	16	12.5					

- d₁ = For dimension d₁.
- E = Housing E diameter
- E₁ = Shaft diameter E₁.
- S = Square w.a.f.
- B = Length B.
- For insertion manually (with aid of tommy bar) or by machine of self-tapping thread inserts types 302, 307 and 308.
- For this 620 device, spare threaded studs are available, group code 71597.

71592 Self-cutting threaded insert tool type 620

S94A

Material Steel



d ₁	✉	Art.number	d ₁	✉	Art.number	d ₁	✉	Art.number
M3	1	71592.030.001	M10	1	71592.100.001	M20	1	71592.200.001
M4	1	71592.040.001	M12	1	71592.120.001	M24	1	71592.240.001
M5	1	71592.050.001	M14	1	71592.140.001	M27	1	71592.270.001
M6	1	71592.060.001	M16	1	71592.160.001	M30	1	71592.300.001
M8	1	71592.080.001						

Spare threaded pin for tool type 620

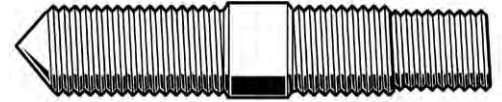

3

71597 Spare threaded pin for tool type 620 S94A



d	☒	Art.number	d	☒	Art.number	d	☒	Art.number
M3	1	71597.030.001	M10	1	71597.100.001	M20	1	71597.200.001
M4	1	71597.040.001	M12	1	71597.120.001	M22	1	71597.220.001
M5	1	71597.050.001	M14	1	71597.140.001	M24	1	71597.240.001
M6	1	71597.060.001	M16	1	71597.160.001	M30	1	71597.300.001
M8	1	71597.080.001						

Self-tapping thread insert with hexagon socket tool type 6102

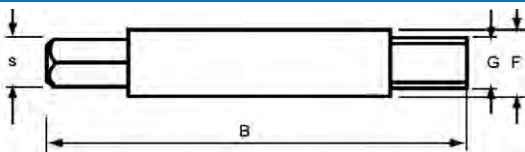

Technical Data

For nom.size d ₁	B	F	G	s	For nom.size d ₁	B	F	G	s
M4	80	6	4.9	3.2	M8	100	10	8	6.6
M5	90	8	6.2	4.1	M10	110	12	9	8.3
M6	100	10	8	4.9	M12	125	14	11	10.1

- s = Hex stud s (nom.).
- F = Shaft diameter F.
- G = Square G.
- B = Length B.

71580 Self-tapping thread insert with hexagon socket tool type 6102 S94A

Material Steel



For nom. size d ₁	☒	Art.number	For nom. size d ₁	☒	Art.number	For nom. size d ₁	☒	Art.number
M4	1	71580.040.001	M6	1	71580.060.001	M10	1	71580.100.001
M5	1	71580.050.001	M8	1	71580.080.001	M12	1	71580.120.001

- Hand/machine tool 6102 is exclusively for use with self-tapping thread inserts with hexagon socket, types 302 2 and 308 2.
- Advantages of the self-tapping thread inserts with hexagon socket:
- Thread insert does not have to be screwed onto device: saves up to 50% of fitting time.
- Simple insertion tool type 6102: use with tommy bar or optionally by machine.
- Insertion device only needs to turn clockwise.
- Thread inserts are simple to unscrew.

FABORY Self-cutting threaded inserts

Fitting tip

For fitting the *FABORY* self-tapping thread inserts, the three handy tools mentioned earlier are available, namely:

- *FABORY* self-tapping thread inserts with hexagon socket **types 302 2** and **308 2** can be fitted with hand/machine tool **type 6102**
- hand tool **type 610**
- hand/machine tool **type 620**

Both suitable for the *FABORY* self-tapping thread inserts WITHOUT hexagon socket: types 302, 307 and 308.

For emergency or rapid fitting of only a few of these types of *FABORY* self-tapping thread inserts, it is also possible to use a nut and bolt of correct size.

FABORY self-tapping thread inserts of type 302 are also available in a selection case (S572). 420 items in total, in sizes from M3 up to M16, in materials steel, zinc plated yellow passivated and some sizes in C4 stainless steel (art. no. 41010.000.572).

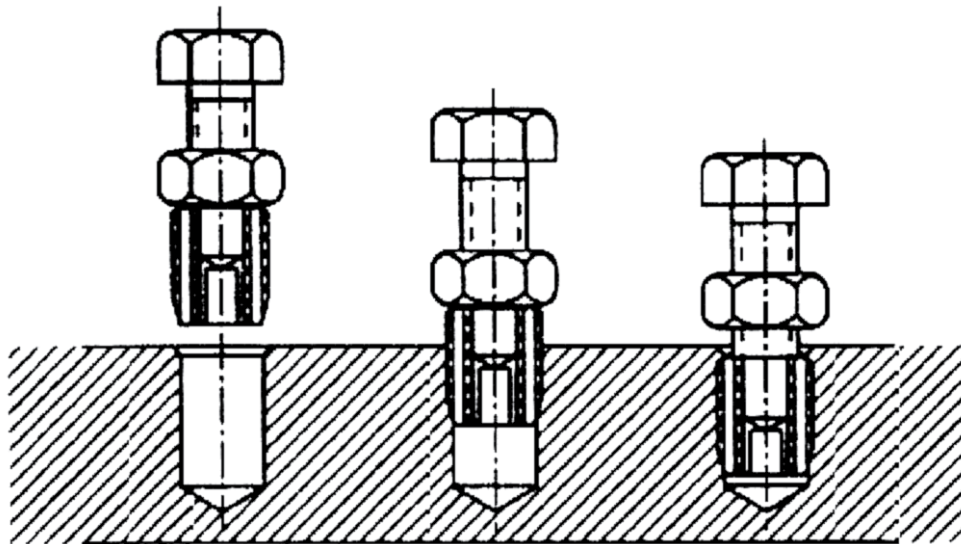

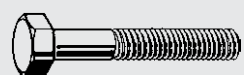

1 Bolts



2 Hexagon socket products



3 Nuts, rivet nuts & inserts



4 Threaded rods & studbolts



5 Hook & eye products



6 Screws

I Index



7 Washers & O-rings

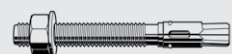

8 Anchoring products

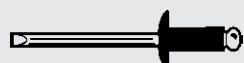

9 Rivets, pins & keys



10 Systems, furniture & security fasteners



11 Assortments & storage systems

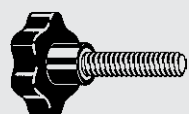



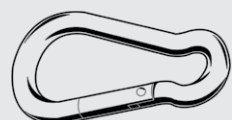

















12 Engineering parts & machine parts

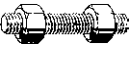
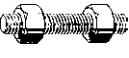

13 Maritime products

T Fastening technology

Threaded rods & studbolts 4

 Page 4-2 DIN 976-1A Metric	 Page 4-12 DIN ≈976-1 Metric fine	 Page 4-14 ASME B18.31.3 UNC	 Page 4-17 ASME B18.31.3 UNF	 Page 4-20 BSW
 Page 4-21 PERMAGLAS Metric	 Page 4-22 PERMAGLAS Metric	 Page 4-23 PERMAGLAS	 Page 4-24 Tr	 Page 4-25 Tr
 Page 4-26 Tr Bronze	 Page 4-27 DIN 938 ≈ 1xd Metric	 Page 4-29 DIN 939 ≈ 1,25xd Metric	 Page 4-33 DIN ≈939 (1955) ≈ 1,25xd BSW	 Page 4-34 DIN 835 ≈ 2d Metric
 Page 4-37 ASTM UNC	 Page 4-38 ASTM Metric	 Page 4-39 ASME B16.5 UNC	 Page 4-55 BS ≈4882 Metric	 Page 4-57 ASME B18.2.2 ASTM UNC
 Page 4-59 ASTM Metric	 Page 4-61 DIN 2510 L/NF Metric	 Page 4-62 DIN 2510 NF For double ended studs Metric		

Threaded rod

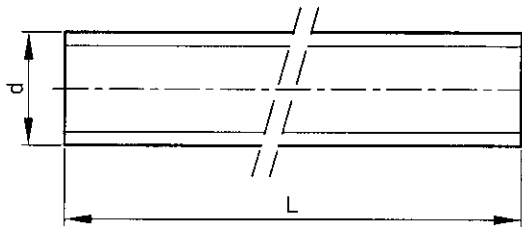

DIN 976-1A
NEN ≈2369
NF ≈25-136

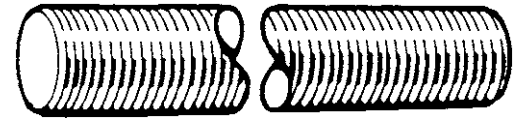

Technical Data

d	P	d	P
M2	0.4	M27	3
M2.5	0.45	M30	3.5
M3	0.5	M33	3.5
M4	0.7	M36	4
M5	0.8	M39	4
M6	1	M42	4.5
M7 (#DIN)	1	M45	4.5
M8	1.25	M48	5
M10	1.5	M52	5
M12	1.75	M56	5.5
M14	2	M60	5.5
M16	2	M64	6
M18	2.5	M68	6
M20	2.5	M72	6
M22	2.5	M76 (#DIN)	6
M24	3	M80 (#DIN)	6

The end of the threaded rod is painted to improve the recognisability of the quality.

Colour code threaded rods		
Property class	Material	Colour
4.8	Plain steel and zinc plated	selfcolour
4.8	ISO metric hot dip galvanised	light blue
4.8	Oversized metric hot dip galvanised	orange
8.8	Plain steel, zinc plated and yellow passivated	yellow
8.8	ISO metric hot dip galvanised	steel grey
8.8	Oversized metric hot dip galvanised	purple
10.9	Plain steel	white
12.9	Plain steel	black
ASTM-B7	Plain steel (UNC & 8UN)	selfcolour
ASTM-B7	Plain steel (metric)	selfcolour
RVS-A2	Stainless steel A2 metric	green
RVS-A4	Stainless steel A4 metric	red

Article groups

Thread	Material	Class	Surface treatment	Color	Code	Page
M	St	≥4.8	Zipl yell.p.		20108	4-3
M	St.St. A2	70			51068	4-3
M	St.St. A4	70			55068	4-4
M	St	≥4.8		1 meter	20200	4-4
M	St	≥4.8	Zipl	1 meter	20300	4-5
M	St	≥4.8	Zipl	1 meter left hand	20380	4-5
M	St	≥4.8	Zipl yell.p.	1 meter	20302	4-5
M	St	≥4.8	Hot d.g.	1 meter oversized	20140	4-5
M	St	≥4.8	Hot d.g.	1 meter ISO	20160	4-5
M	St	8.8		1 meter	20220	4-6
M	St	8.8	Zipl	1 meter	20230	4-6
M	St	8.8	Zipl	1 meter left hand	20376	4-6
M	St	8.8	Zipl yell.p.	1 meter	20232	4-6
M	St	8.8	Hot d.g.	1 meter oversized	20150	4-7
M	St	8.8	Hot d.g.	1 meter ISO	20170	4-7
M	St	10.9		1 meter	20130	4-7
M	St	12.9		1 meter	20132	4-7
M	St.St. A2	70		1 meter	51070	4-8
M	St.St. A2	70		1 meter/Large pack	51064	4-8

Article groups						
Thread	Material	Class	Surface treatment	Color	Code	Page
M	St.St. A4	70			55070	4-8
M	St.St. A2	70			51074	4-8
M	St.St. A4	70			55074	4-9
M	Al P40				45070	4-9
M	Al P60				45270	4-9
M	Ti	Gr.2			45940	4-9
M	Br Cu2/Cu3				46090	4-9
M	Plastic PA	PA 6.6		White	56170	4-9
M	St	≥4.8	Zipl		20330	4-10
M	St	≥4.8	Hot d.g.		20145	4-10
M	St	8.8	Zipl		20372	4-10
M	St	8.8	Hot d.g.		20155	4-10
M	St.St. A2	70			51071	4-10
M	St.St. A4	70			55071	4-11
M	St	≥4.8	Zipl		20410	4-11
M	St	≥4.8	Hot d.g.		20147	4-11
M	St	8.8	Zipl		20395	4-11
M	St	8.8	Hot d.g.		20157	4-11
M	St.St. A2	70			51072	4-12
M	St.St. A4	70			55072	4-12

20108 Stud bolt		G05A
Thread	Metric thread	
Material	Steel	
Class	≥4.8	
Surface treatment	Zinc plated yellow passivated	

d x L	☒	Art.number	d x L	☒	Art.number	d x L	☒	Art.number
M3X20	200	20108.030.020	M5X120	100	20108.050.120	M8X150	50	20108.080.150
M3X30	200	20108.030.030				M8X160	50	20108.080.160
M3X40	200	20108.030.040	M6X20	200	20108.060.020			
M3X50	200	20108.030.050	M6X30	200	20108.060.030	M10X30	100	20108.100.030
M3X60	200	20108.030.060	M6X40	200	20108.060.040	M10X40	100	20108.100.040
M3X70	200	20108.030.070	M6X50	200	20108.060.050	M10X50	100	20108.100.050
M3X80	200	20108.030.080	M6X60	200	20108.060.060	M10X60	100	20108.100.060
M3X90	200	20108.030.090	M6X70	200	20108.060.070	M10X70	100	20108.100.070
M3X100	200	20108.030.100	M6X80	100	20108.060.080	M10X80	100	20108.100.080
			M6X90	100	20108.060.090	M10X90	100	20108.100.090
M4X20	200	20108.040.020	M6X100	100	20108.060.100	M10X100	100	20108.100.100
M4X30	200	20108.040.030	M6X120	100	20108.060.120	M10X120	50	20108.100.120
M4X40	200	20108.040.040	M6X130	100	20108.060.130	M10X130	50	20108.100.130
M4X50	200	20108.040.050	M6X140	100	20108.060.140	M10X140	50	20108.100.140
M4X60	200	20108.040.060	M6X150	100	20108.060.150	M10X150	50	20108.100.150
M4X70	200	20108.040.070	M6X160	100	20108.060.160	M10X160	50	20108.100.160
M4X80	200	20108.040.080						
M4X90	100	20108.040.090	M8X30	200	20108.080.030	M12X40	100	20108.120.040
M4X100	100	20108.040.100	M8X40	200	20108.080.040	M12X50	100	20108.120.050
			M8X50	200	20108.080.050	M12X60	100	20108.120.060
M5X20	200	20108.050.020	M8X60	100	20108.080.060	M12X70	50	20108.120.070
M5X30	200	20108.050.030	M8X70	100	20108.080.070	M12X80	50	20108.120.080
M5X40	200	20108.050.040	M8X75	100	20108.080.075	M12X90	50	20108.120.090
M5X50	200	20108.050.050	M8X80	100	20108.080.080	M12X100	50	20108.120.100
M5X60	200	20108.050.060	M8X90	100	20108.080.090	M12X120	50	20108.120.120
M5X70	200	20108.050.070	M8X100	100	20108.080.100	M12X130	50	20108.120.130
M5X80	100	20108.050.080	M8X120	100	20108.080.120	M12X140	50	20108.120.140
M5X90	100	20108.050.090	M8X130	100	20108.080.130	M12X150	50	20108.120.150
M5X100	100	20108.050.100	M8X140	50	20108.080.140	M12X160	25	20108.120.160

51068 Stud bolt		R09A
Thread	Metric thread	
Material	Stainless steel A2	
Class	70	



d x L	☒	Art.number	d x L	☒	Art.number	d x L	☒	Art.number
M4X20	100	51068.040.020	M5X30	100	51068.050.030	M5X80	50	51068.050.080
M4X30	100	51068.040.030	M5X40	100	51068.050.040	M5X90	50	51068.050.090
M4X40	100	51068.040.040	M5X50	100	51068.050.050	M5X100	50	51068.050.100
M4X50	100	51068.040.050	M5X60	100	51068.050.060	M5X120	50	51068.050.120
M4X60	100	51068.040.060	M5X70	100	51068.050.070			

51068 Stud bolt								
d x L	☒	Art.number	d x L	☒	Art.number	d x L	☒	Art.number
M6X30	100	51068.060.030	M8X100	50	51068.080.100	M12X40	50	51068.120.040
M6X40	100	51068.060.040	M8X120	50	51068.080.120	M12X50	50	51068.120.050
M6X50	100	51068.060.050	M8X130	50	51068.080.130	M12X60	50	51068.120.060
M6X60	100	51068.060.060	M8X140	25	51068.080.140	M12X65	25	51068.120.065
M6X70	100	51068.060.070	M8X150	25	51068.080.150	M12X70	25	51068.120.070
M6X80	50	51068.060.080	M8X160	25	51068.080.160	M12X80	25	51068.120.080
M6X90	50	51068.060.090	M8X200	25	51068.080.200	M12X90	25	51068.120.090
M6X100	50	51068.060.100				M12X100	25	51068.120.100
M6X120	50	51068.060.120	M10X40	50	51068.100.040	M12X120	25	51068.120.120
M6X130	50	51068.060.130	M10X50	50	51068.100.050	M12X130	25	51068.120.130
M6X140	50	51068.060.140	M10X60	50	51068.100.060	M12X140	25	51068.120.140
M6X150	50	51068.060.150	M10X70	50	51068.100.070	M12X150	25	51068.120.150
M6X160	50	51068.060.160	M10X80	50	51068.100.080	M12X160	10	51068.120.160
			M10X90	50	51068.100.090			
M8X30	100	51068.080.030	M10X100	50	51068.100.100	M16X65	10	51068.160.065
M8X40	100	51068.080.040	M10X120	25	51068.100.120	M16X80	10	51068.160.080
M8X50	100	51068.080.050	M10X130	25	51068.100.130			
M8X60	50	51068.080.060	M10X140	25	51068.100.140	M20X100	10	51068.200.100
M8X70	50	51068.080.070	M10X150	25	51068.100.150	M20X150	10	51068.200.150
M8X80	50	51068.080.080	M10X160	25	51068.100.160			
M8X90	50	51068.080.090						

• Sizes with a diameter > M24 are at least property class 50.

55068 Stud bolt								R49A
Thread	Metric thread							
Material	Stainless steel A4							
Class	70							
d x L	☒	Art.number	d x L	☒	Art.number	d x L	☒	Art.number
M4X20	100	55068.040.020	M8X50	100	55068.080.050	M10X140	25	55068.100.140
			M8X60	50	55068.080.060	M10X150	25	55068.100.150
M5X30	100	55068.050.030	M8X70	50	55068.080.070			
M5X40	100	55068.050.040	M8X80	50	55068.080.080	M12X40	50	55068.120.040
M5X50	100	55068.050.050	M8X100	50	55068.080.100	M12X50	50	55068.120.050
M5X60	100	55068.050.060	M8X120	50	55068.080.120	M12X60	50	55068.120.060
M5X80	50	55068.050.080	M8X130	50	55068.080.130	M12X70	25	55068.120.070
			M8X160	25	55068.080.160	M12X80	25	55068.120.080
M6X30	100	55068.060.030				M12X100	25	55068.120.100
M6X40	100	55068.060.040	M10X40	50	55068.100.040	M12X120	25	55068.120.120
M6X50	100	55068.060.050	M10X50	50	55068.100.050	M12X130	25	55068.120.130
M6X60	100	55068.060.060	M10X60	50	55068.100.060	M12X150	25	55068.120.150
M6X70	100	55068.060.070	M10X70	50	55068.100.070	M12X160	10	55068.120.160
M6X80	50	55068.060.080	M10X80	50	55068.100.080			
M6X100	50	55068.060.100	M10X90	50	55068.100.090	M16X50	10	55068.160.050
			M10X100	50	55068.100.100	M16X60	50	55068.160.060
M8X30	100	55068.080.030	M10X120	25	55068.100.120			
M8X40	100	55068.080.040	M10X130	25	55068.100.130	M20X340	1	55068.200.340

• Sizes with a diameter > M24 are at least property class 50.

20200 Threaded rod length 1 meter								G01A
Thread	Metric thread							
Material	Steel							
Class	≥4.8							
d	☒	Art.number	d	☒	Art.number	d	☒	Art.number
M2	20	20200.020.001	M18	5	20200.180.001	M45	2	20200.450.001
M3	20	20200.030.001	M20	2	20200.200.001	M48	2	20200.480.001
M4	20	20200.040.001	M22	2	20200.220.001	M52	1	20200.520.001
M5	10	20200.050.001	M24	2	20200.240.001	M56	1	20200.560.001
M6	10	20200.060.001	M27	2	20200.270.001	M60	1	20200.600.001
M7	10	20200.070.001	M30	2	20200.300.001	M64	1	20200.640.001
M8	10	20200.080.001	M33	2	20200.330.001	M68	1	20200.680.001
M10	10	20200.100.001	M36	2	20200.360.001	M72	1	20200.720.001
M12	10	20200.120.001	M39	2	20200.390.001	M76	1	20200.760.001
M14	5	20200.140.001	M42	2	20200.420.001	M80	1	20200.800.001
M16	5	20200.160.001						

20300 Threaded rod length 1 meter		G03A	
Thread	Metric thread		
Material	Steel		
Class	≥4.8		
Surface treatment	Zinc plated		

d	☒	Art.number	d	☒	Art.number	d	☒	Art.number
M3		20 20300.030.001	M12		10 20300.120.001	M27		2 20300.270.001
M4		20 20300.040.001	M14		5 20300.140.001	M30		2 20300.300.001
M5		10 20300.050.001	M16		5 20300.160.001	M33		2 20300.330.001
M6		10 20300.060.001	M18		5 20300.180.001	M36		2 20300.360.001
M7		10 20300.070.001	M20		2 20300.200.001	M39		2 20300.390.001
M8		10 20300.080.001	M22		2 20300.220.001	M42		2 20300.420.001
M10		10 20300.100.001	M24		2 20300.240.001	M45		1 20300.450.001

20380 Threaded rod length 1 meter left-hand thread		G05A	
Thread	Metric thread		
Material	Steel		
Class	≥4.8		
Surface treatment	Zinc plated		

d	☒	Art.number	d	☒	Art.number	d	☒	Art.number
M3		10 20380.030.001	M10		2 20380.100.001	M20		1 20380.200.001
M4		10 20380.040.001	M12		2 20380.120.001	M22		1 20380.220.001
M5		5 20380.050.001	M14		1 20380.140.001	M24		1 20380.240.001
M6		2 20380.060.001	M16		1 20380.160.001	M27		1 20380.270.001
M8		2 20380.080.001	M18		1 20380.180.001	M30		1 20380.300.001

20302 Threaded rod length 1 meter		G03A	
Thread	Metric thread		
Material	Steel		
Class	≥4.8		
Surface treatment	Zinc plated yellow passivated		

d	☒	Art.number	d	☒	Art.number	d	☒	Art.number
M5		10 20302.050.001	M10		10 20302.100.001	M20		2 20302.200.001
M6		10 20302.060.001	M12		10 20302.120.001	M24		2 20302.240.001
M8		10 20302.080.001	M16		5 20302.160.001			

20140 Threaded rod length 1 meter oversized thread		A08C	
Thread	Metric thread		
Material	Steel		
Class	≥4.8		
Surface treatment	Hot dip galvanized		

d	☒	Art.number	d	☒	Art.number	d	☒	Art.number
M10		5 20140.100.001	M20		3 20140.200.001	M30		2 20140.300.001
M12		5 20140.120.001	M24		3 20140.240.001	M33		2 20140.330.001
M16		5 20140.160.001	M27		2 20140.270.001	M36		2 20140.360.001

- For hot dip galvanized threaded rods with OVERSIZED thread the zinc layer is applied ON the normal thread, so AFTER galvanizing these threaded rods are no longer ISO-metric mating, but thicker: so called OVERSIZED.
- They do not mate the usual fit of screwthread and cannot be used in e.g. normal threaded holes.
- The corresponding OVERSIZED nuts have been tapped about 0,3 mm larger AFTER galvanizing running perfectly onto these threaded rods.

20160 Threaded rod length 1 meter ISO-Metric fitting thread		A08C	
Thread	Metric thread		
Material	Steel		
Class	≥4.8		
Surface treatment	Hot dip galvanized		

d	☒	Art.number	d	☒	Art.number	d	☒	Art.number
M10		5 20160.100.001	M20		3 20160.200.001	M30		2 20160.300.001
M12		5 20160.120.001	M24		3 20160.240.001	M36		2 20160.360.001
M16		5 20160.160.001	M27		2 20160.270.001			

20160 Threaded rod length 1 meter ISO-Metric fitting thread ←

- For hot dip galvanized threaded rods with ISO-METRIC FITTING thread, the thread is rolled undersize so that it will meet the go-gauge with tolerance class h AFTER galvanizing.
- The advantage of this way of manufacturing is that the threaded rods can be used in any threaded hole without any problem.
- The corresponding ISO-METRIC FITTING nuts have been Oversize tapped according to ISO 965-5 AFTER galvanizing so that they perfectly fit onto the threaded rods.

20220 Threaded rod length 1 meter G04A

Thread	Metric thread
Material	Steel
Class	8.8

d	☒	Art.number	d	☒	Art.number	d	☒	Art.number
M5	10	20220.050.001	M20	3	20220.200.001	M42	1	20220.420.001
M6	10	20220.060.001	M22	3	20220.220.001	M45	1	20220.450.001
M8	10	20220.080.001	M24	3	20220.240.001	M48	1	20220.480.001
M10	10	20220.100.001	M27	2	20220.270.001	M52	1	20220.520.001
M12	5	20220.120.001	M30	2	20220.300.001	M56	1	20220.560.001
M14	5	20220.140.001	M33	2	20220.330.001	M60	1	20220.600.001
M16	5	20220.160.001	M36	2	20220.360.001	M64	1	20220.640.001
M18	3	20220.180.001	M39	1	20220.390.001			

20230 Threaded rod length 1 meter G04A

Thread	Metric thread
Material	Steel
Class	8.8
Surface treatment	Zinc plated

d	☒	Art.number	d	☒	Art.number	d	☒	Art.number
M4	10	20230.040.001	M18	3	20230.180.001	M39	1	20230.390.001
M5	10	20230.050.001	M20	3	20230.200.001	M42	1	20230.420.001
M6	10	20230.060.001	M22	3	20230.220.001	M45	1	20230.450.001
M8	10	20230.080.001	M24	3	20230.240.001	M48	1	20230.480.001
M10	10	20230.100.001	M27	2	20230.270.001	M52	1	20230.520.001
M12	5	20230.120.001	M30	2	20230.300.001	M56	1	20230.560.001
M14	5	20230.140.001	M33	2	20230.330.001	M60	1	20230.600.001
M16	5	20230.160.001	M36	2	20230.360.001	M64	1	20230.640.001

20376 Threaded rod length 1 meter left-hand thread G05A

Thread	Metric thread
Material	Steel
Class	8.8
Surface treatment	Zinc plated

d	☒	Art.number	d	☒	Art.number	d	☒	Art.number
M6	2	20376.060.001	M12	2	20376.120.001	M24	1	20376.240.001
M8	2	20376.080.001	M16	1	20376.160.001	M30	1	20376.300.001
M10	2	20376.100.001	M20	1	20376.200.001			

20232 Threaded rod length 1 meter G06A

Thread	Metric thread
Material	Steel
Class	8.8
Surface treatment	Zinc plated yellow passivated

d	☒	Art.number	d	☒	Art.number	d	☒	Art.number
M6	10	20232.060.001	M14	5	20232.140.001	M20	3	20232.200.001
M8	10	20232.080.001	M16	5	20232.160.001	M22	3	20232.220.001
M10	10	20232.100.001	M18	3	20232.180.001	M24	3	20232.240.001
M12	5	20232.120.001						



4

20150 Threaded rod length 1 meter oversized thread		A08C
Thread	Metric thread	
Material	Steel	
Class	8.8	
Surface treatment	Hot dip galvanized	
		

d	☒	Art.number	d	☒	Art.number	d	☒	Art.number
M10	5	20150.100.001	M27	2	20150.270.001	M39	1	20150.390.001
M12	5	20150.120.001	M30	2	20150.300.001	M42	1	20150.420.001
M16	5	20150.160.001	M33	2	20150.330.001	M45	1	20150.450.001
M20	3	20150.200.001	M36	2	20150.360.001	M48	1	20150.480.001
M24	3	20150.240.001						

- For hot dip galvanized threaded rods with OVERSIZED thread the zinc layer is applied ON the normal thread, so AFTER galvanizing these threaded rods are no longer ISO-metric mating, but thicker: so called OVERSIZED.
- They do not mate the usual fit of screwthread and cannot be used in e.g. normal threaded holes.
- The corresponding OVERSIZED nuts have been tapped about 0,3 mm larger AFTER galvanizing running perfectly onto these threaded rods.

4

20170 Threaded rod length 1 meter ISO-Metric fitting thread		A08C
Thread	Metric thread	
Material	Steel	
Class	8.8	
Surface treatment	Hot dip galvanized	
		

d	☒	Art.number	d	☒	Art.number	d	☒	Art.number
M10	5	20170.100.001	M24	3	20170.240.001	M39	1	20170.390.001
M12	5	20170.120.001	M27	2	20170.270.001	M42	1	20170.420.001
M16	5	20170.160.001	M30	2	20170.300.001	M45	1	20170.450.001
M20	3	20170.200.001	M36	2	20170.360.001			

- For hot dip galvanized threaded rods with ISO-METRIC FITTING thread, the thread is rolled undersize so that it will meet the go-gauge with tolerance class h AFTER galvanizing.
- The advantage of this way of manufacturing is that the threaded rods can be used in any threaded hole without any problem.
- The corresponding ISO-METRIC FITTING nuts have been threaded according to the tolerance class 6H AFTER galvanizing so that they perfectly fit onto the threaded rods.

20130 Threaded rod length 1 meter		G04A
Thread	Metric thread	
Material	Steel	
Class	10.9	
		

d	☒	Art.number	d	☒	Art.number	d	☒	Art.number
M5	5	20130.050.001	M16	3	20130.160.001	M30	2	20130.300.001
M6	5	20130.060.001	M18	3	20130.180.001	M33	2	20130.330.001
M8	5	20130.080.001	M20	3	20130.200.001	M36	2	20130.360.001
M10	5	20130.100.001	M22	3	20130.220.001	M39	2	20130.390.001
M12	5	20130.120.001	M24	3	20130.240.001	M42	1	20130.420.001
M14	5	20130.140.001	M27	2	20130.270.001	M45	1	20130.450.001

- Warning: electro-galvanizing of these products may cause hydrogen embrittlement.

20132 Threaded rod length 1 meter		G04A
Thread	Metric thread	
Material	Steel	
Class	12.9	
		

d	☒	Art.number	d	☒	Art.number	d	☒	Art.number
M8	5	20132.080.001	M16	3	20132.160.001	M27	2	20132.270.001
M10	5	20132.100.001	M20	3	20132.200.001	M30	2	20132.300.001
M12	5	20132.120.001	M24	3	20132.240.001			

- Warning: electro-galvanizing of these products may cause hydrogen embrittlement.

51070 Threaded rod length 1 meter Q03A

Thread Material Class Metric thread Stainless steel A2 70





d	☒	Art.number	d	☒	Art.number	d	☒	Art.number
M2*	20	51070.020.001	M12	5	51070.120.001	M30	1	51070.300.001
M2,5*	20	51070.025.001	M14	5	51070.140.001	M33	1	51070.330.001
M3	10	51070.030.001	M16	5	51070.160.001	M36	1	51070.360.001
M4	10	51070.040.001	M18	3	51070.180.001	M39*	5	51070.390.001
M5	10	51070.050.001	M20	3	51070.200.001	M42*	5	51070.420.001
M6	10	51070.060.001	M22	2	51070.220.001	M45*	5	51070.450.001
M8	10	51070.080.001	M24	2	51070.240.001	M48*	5	51070.480.001
M10	10	51070.100.001	M27	1	51070.270.001	M52*	1	51070.520.001

• Sizes with a diameter > M24 are at least property class 50.

51064 Threaded rod length 1 meter Q03A

Thread Material Class Metric thread Stainless steel A2 70





d	☒	Art.number	d	☒	Art.number	d	☒	Art.number
M6	50	51064.060.001	M10	25	51064.100.001	M16	15	51064.160.001
M8	25	51064.080.001	M12	25	51064.120.001			

• Sizes with a diameter > M24 are at least property class 50.

55070 Threaded rod length 1 meter Q43A

Thread Material Class Metric thread Stainless steel A4 70



d	☒	Art.number	d	☒	Art.number	d	☒	Art.number
M2	10	55070.020.001	M12	5	55070.120.001	M30	1	55070.300.001
M2,5	10	55070.025.001	M14	5	55070.140.001	M33	1	55070.330.001
M3	10	55070.030.001	M16	5	55070.160.001	M36	1	55070.360.001
M4	10	55070.040.001	M18	3	55070.180.001	M39*	5	55070.390.001
M5	10	55070.050.001	M20	3	55070.200.001	M42*	5	55070.420.001
M6	10	55070.060.001	M22	2	55070.220.001	M45*	5	55070.450.001
M8	10	55070.080.001	M24	2	55070.240.001	M48*	5	55070.480.001
M10	10	55070.100.001	M27	1	55070.270.001	M52*	1	55070.520.001

• Sizes with a diameter > M24 are at least property class 50.

51074 Threaded rod length 1 meter left-hand thread R09A

Thread Material Class Metric thread Stainless steel A2 70





d	☒	Art.number	d	☒	Art.number	d	☒	Art.number
M5*	100	51074.050.001	M12	2	51074.120.001	M18*	10	51074.180.001
M6	2	51074.060.001	M14*	10	51074.140.001	M20	1	51074.200.001
M8	2	51074.080.001	M16	1	51074.160.001	M24	1	51074.240.001
M10	2	51074.100.001						

• Sizes with a diameter > M24 are at least property class 50.

4

55074 Threaded rod length 1 meter left-hand thread		R09A
Thread	Metric thread	 
Material	Stainless steel A4	
Class	70	

d	☒	Art.number	d	☒	Art.number	d	☒	Art.number
M5*		100 55074.050.001	M10*		25 55074.100.001	M16*		10 55074.160.001
M6*		100 55074.060.001	M12*		20 55074.120.001	M18*		10 55074.180.001
M8*		50 55074.080.001	M14*		10 55074.140.001	M20*		5 55074.200.001

45070 Threaded rod length 1 meter		W01A
Thread	Metric thread	
Material	Aluminium P40	
Class		

d	☒	Art.number	d	☒	Art.number	d	☒	Art.number
M4		1 45070.040.001	M6		10 45070.060.001	M10		5 45070.100.001
M5		10 45070.050.001	M8		5 45070.080.001			

45270 Threaded rod length 1 meter		W01A
Thread	Metric thread	
Material	Aluminium P60	
Class		

d	☒	Art.number	d	☒	Art.number	d	☒	Art.number
M8		5 45270.080.001	M10		5 45270.100.001	M12		5 45270.120.001

45940 Threaded rod length 1 meter		W01A
Thread	Metric thread	 
Material	Titanium	
Class	Gr.2	

d	☒	Art.number	d	☒	Art.number	d	☒	Art.number
M6		1 45940.060.001	M8		1 45940.080.001	M10		1 45940.100.001

46090 Threaded rod length 1 meter		M01A
Thread	Metric thread	 
Material	Brass Cu2/Cu3	
Class		

d	☒	Art.number	d	☒	Art.number	d	☒	Art.number
M3		10 46090.030.001	M8		10 46090.080.001	M16		2 46090.160.001
M4		10 46090.040.001	M10		5 46090.100.001	M18		2 46090.180.001
M5		10 46090.050.001	M12		5 46090.120.001	M20		2 46090.200.001
M6		10 46090.060.001	M14		2 46090.140.001	M22		2 46090.220.001

56170 Threaded rod length 1 meter plastic		W02A
Thread	Metric thread	
Material	Plastic Polyamide (nylon)	
Class	PA 6.6	
Color	White	

d	☒	Art.number	d	☒	Art.number	d	☒	Art.number
M3		10 56170.030.001	M8		5 56170.080.001	M14		2 56170.140.001
M4		10 56170.040.001	M10		5 56170.100.001	M16		2 56170.160.001
M5		5 56170.050.001	M12		2 56170.120.001	M20		1 56170.200.001
M6		5 56170.060.001						

20330 Threaded rod length 2 meter		G06A	
Thread	Metric thread		
Material	Steel		
Class	≥4.8		
Surface treatment	Zinc plated		

d	☒	Art.number	d	☒	Art.number	d	☒	Art.number
M5	10	20330.050.001	M12	10	20330.120.001	M24	2	20330.240.001
M6	10	20330.060.001	M16	5	20330.160.001	M27	1	20330.270.001
M8	10	20330.080.001	M20	2	20330.200.001	M30	1	20330.300.001
M10	10	20330.100.001						

20145 Threaded rod length 2 meter oversized thread		A08A	
Thread	Metric thread		
Material	Steel		
Class	≥4.8		
Surface treatment	Hot dip galvanized		

d	☒	Art.number	d	☒	Art.number	d	☒	Art.number
M10	1	20145.100.001	M16	1	20145.160.001	M24	1	20145.240.001
M12	1	20145.120.001	M20	1	20145.200.001	M27	1	20145.270.001

20372 Threaded rod length 2 meter		G05A	
Thread	Metric thread		
Material	Steel		
Class	8.8		
Surface treatment	Zinc plated		

d	☒	Art.number	d	☒	Art.number	d	☒	Art.number
M5	10	20372.050.001	M12	10	20372.120.001	M22	2	20372.220.001
M6	10	20372.060.001	M14	5	20372.140.001	M24	2	20372.240.001
M8	10	20372.080.001	M16	5	20372.160.001	M30	1	20372.300.001
M10	10	20372.100.001	M20	2	20372.200.001	M36	1	20372.360.001

20155 Threaded rod length 2 meter oversized thread		A08A	
Thread	Metric thread		
Material	Steel		
Class	8.8		
Surface treatment	Hot dip galvanized		

d	☒	Art.number	d	☒	Art.number	d	☒	Art.number
M12	1	20155.120.001	M20	1	20155.200.001	M30	1	20155.300.001
M16	1	20155.160.001	M24	1	20155.240.001	M36	1	20155.360.001

- For hot dip galvanized threaded rods with OVERSIZED thread the zinc layer is applied ON the normal thread, so AFTER galvanizing these threaded rods are no longer ISO-metric mating, but thicker: so called OVERSIZED.
- They do not mate the usual fit of screwthread and cannot be used in e.g. normal threaded holes.
- The corresponding OVERSIZED nuts have been tapped about 0,3 mm larger AFTER galvanizing running perfectly onto these threaded rods.

51071 Threaded rod length 2 meter		R09A	
Thread	Metric thread		
Material	Stainless steel A2		
Class	70		

d	☒	Art.number	d	☒	Art.number	d	☒	Art.number
M6	5	51071.060.001	M18*	5	51071.180.001	M33*	1	51071.330.001
M8	5	51071.080.001	M20	1	51071.200.001	M36*	1	51071.360.001
M10	2	51071.100.001	M22*	1	51071.220.001	M39*	1	51071.390.001
M12	2	51071.120.001	M24	1	51071.240.001	M42*	1	51071.420.001
M14*	10	51071.140.001	M27*	1	51071.270.001	M45*	1	51071.450.001
M16	2	51071.160.001	M30*	1	51071.300.001			

- Sizes with a diameter > M24 are at least property class 50.

55071 Threaded rod length 2 meter		R49A
Thread	Metric thread	
Material	Stainless steel A4	
Class	70	
		

d	☒	Art.number	d	☒	Art.number	d	☒	Art.number
M6	5	55071.060.001	M18*	5	55071.180.001	M36*	1	55071.360.001
M8	5	55071.080.001	M20	1	55071.200.001	M39*	1	55071.390.001
M10	2	55071.100.001	M22*	1	55071.220.001	M42*	1	55071.420.001
M12	2	55071.120.001	M27*	1	55071.270.001	M45*	1	55071.450.001
M14*	10	55071.140.001	M30*	1	55071.300.001			
M16	2	55071.160.001	M33*	1	55071.330.001			

• Sizes with a diameter > M24 are at least property class 50.

20410 Threaded rod length 3 meter		G05A
Thread	Metric thread	
Material	Steel	
Class	≥4.8	
Surface treatment	Zinc plated	

d	☒	Art.number	d	☒	Art.number	d	☒	Art.number
M6	10	20410.060.001	M12	5	20410.120.001	M24	2	20410.240.001
M8	10	20410.080.001	M16	2	20410.160.001	M30	1	20410.300.001
M10	5	20410.100.001	M20	2	20410.200.001			

20147 Threaded rod length 3 meter oversized thread		A08A
Thread	Metric thread	
Material	Steel	
Class	≥4.8	
Surface treatment	Hot dip galvanized	

d	☒	Art.number	d	☒	Art.number	d	☒	Art.number
M12	1	20147.120.001	M24	1	20147.240.001	M30	1	20147.300.001
M16	1	20147.160.001	M27	1	20147.270.001	M36	1	20147.360.001
M20	1	20147.200.001						

- For hot dip galvanized threaded rods with OVERSIZED thread the zinc layer is applied ON the normal thread, so AFTER galvanizing these threaded rods are no longer ISO-metric mating, but thicker: so called OVERSIZED.
- They do not mate the usual fit of screwthread and cannot be used in e.g. normal threaded holes.
- The corresponding OVERSIZED nuts have been tapped about 0,3 mm larger AFTER galvanizing running perfectly onto these threaded rods.



20395 Threaded rod length 3 meter		G05A
Thread	Metric thread	
Material	Steel	
Class	8.8	
Surface treatment	Zinc plated	

d	☒	Art.number	d	☒	Art.number	d	☒	Art.number
M6	10	20395.060.001	M12	5	20395.120.001	M24	1	20395.240.001
M8	10	20395.080.001	M16	2	20395.160.001	M30	1	20395.300.001
M10	5	20395.100.001	M20	1	20395.200.001	M36	1	20395.360.001

20157 Threaded rod length 3 meter oversized thread		A08A
Thread	Metric thread	
Material	Steel	
Class	8.8	
Surface treatment	Hot dip galvanized	

d	☒	Art.number	d	☒	Art.number	d	☒	Art.number
M12	1	20157.120.001	M24	1	20157.240.001	M30	1	20157.300.001
M16	1	20157.160.001	M27	1	20157.270.001	M36	1	20157.360.001
M20	1	20157.200.001						

- For hot dip galvanized threaded rods with OVERSIZED thread the zinc layer is applied ON the normal thread, so AFTER galvanizing these threaded rods are no longer ISO-metric mating, but thicker: so called OVERSIZED.
- They do not mate the usual fit of screwthread and cannot be used in e.g. normal threaded holes.
- The corresponding OVERSIZED nuts have been tapped about 0,3 mm larger AFTER galvanizing running perfectly onto these threaded rods.

51072	Threaded rod length 3 meter	R09A
Thread Material Class	Metric thread Stainless steel A2 70	
		

d	☒	Art.number	d	☒	Art.number	d	☒	Art.number
M6	5	51072.060.001	M18*	5	51072.180.001	M33*	1	51072.330.001
M8	5	51072.080.001	M20	1	51072.200.001	M36*	1	51072.360.001
M10	2	51072.100.001	M22*	1	51072.220.001	M39*	1	51072.390.001
M12	2	51072.120.001	M24	1	51072.240.001	M42*	1	51072.420.001
M14*	10	51072.140.001	M27*	1	51072.270.001	M45*	1	51072.450.001
M16	2	51072.160.001	M30*	1	51072.300.001			

* Sizes with a diameter > M24 are at least property class 50.

4

55072	Threaded rod length 3 meter	R49A
Thread Material Class	Metric thread Stainless steel A4 70	
		

d	☒	Art.number	d	☒	Art.number	d	☒	Art.number
M6	5	55072.060.001	M18*	5	55072.180.001	M33*	1	55072.330.001
M8	5	55072.080.001	M20	1	55072.200.001	M36*	1	55072.360.001
M10	2	55072.100.001	M24	1	55072.240.001	M39*	1	55072.390.001
M12	2	55072.120.001	M27*	1	55072.270.001	M42*	1	55072.420.001
M16	2	55072.160.001	M30	1	55072.300.001	M45*	1	55072.450.001

* Sizes with a diameter > M24 are at least property class 50.

Threaded rod MF

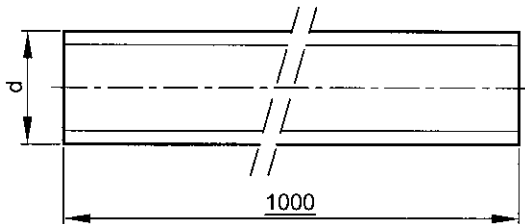

DIN ≈976-1
NEN ≈2369
NF ≈25-136

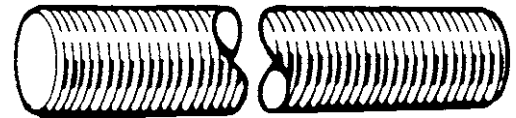



The end of the threaded rod is painted to improve the recognisability of the quality.

Colour code threaded rods		
Property class	Material	Colour
4.8	Plain steel and zinc plated	selfcolour
4.8	ISO metric hot dip galvanised	light blue
4.8	Oversized metric hot dip galvanised	orange
8.8	Plain steel, zinc plated and yellow passivated	yellow
8.8	ISO metric hot dip galvanised	steel grey
8.8	Oversized metric hot dip galvanised	purple
10.9	Plain steel	white
12.9	Plain steel	black
ASTM-B7	Plain steel (UNC & 8UN)	selfcolour
ASTM-B7	Plain steel (metric)	selfcolour
RVS-A2	Stainless steel A2 metric	green
RVS-A4	Stainless steel A4 metric	red

Article groups

Thread	Material	Class	Surface treatment	Code	Page
MF	St	≥4.8	Zipl	1 meter 20360	4-13
MF	St	8.8	Zipl	1 meter 20235	4-13
MF	St.St. A4	70		1 meter 55067	4-13

20360 Threaded rod length 1 meter				G05A	
Thread	Metric fine thread	DIN	976-1	 	
Material	Steel				
Class	≥4.8				
Surface treatment	Zinc plated				

d x P	☒	Art.number	d x P	☒	Art.number	d x P	☒	Art.number
M8X1,00	2	20360.080.100	M16X1,50	1	20360.160.150	M27X1,50 (#DIN)	1	20360.270.150
M10X1,00	2	20360.100.100	M18X1,50	1	20360.180.150	M27X2,00	1	20360.270.200
M10X1,25	2	20360.100.125	M20X1,50	1	20360.200.150	M30X1,50 (#DIN)	1	20360.300.150
M12X1,25	2	20360.120.125	M22X1,50	1	20360.220.150	M30X2,00	1	20360.300.200
M12X1,50	2	20360.120.150	M24X1,50 (#DIN)	1	20360.240.150			
M14X1,50	1	20360.140.150	M24X2,00	1	20360.240.200			

20235 Threaded rod length 1 meter				G05A	
Thread	Metric fine thread			 	
Material	Steel				
Class	8.8				
Surface treatment	Zinc plated				

d x P	☒	Art.number	d x P	☒	Art.number	d x P	☒	Art.number
M8X1,00	2	20235.080.100	M16X1,50	1	20235.160.150	M27X1,50	1	20235.270.150
M10X1,00	2	20235.100.100	M18X1,50	1	20235.180.150	M27X2,00	1	20235.270.200
M10X1,25	2	20235.100.125	M20X1,50	1	20235.200.150	M30X1,50	1	20235.300.150
M12X1,25	2	20235.120.125	M22X1,50	1	20235.220.150	M30X2,00	1	20235.300.200
M12X1,50	2	20235.120.150	M24X1,50	1	20235.240.150			
M14X1,50	1	20235.140.150	M24X2,00	1	20235.240.200			

55067 Threaded rod length 1 meter				R49A	
Thread	Metric fine thread			 	
Material	Stainless steel A4				
Class	70				

d x P	☒	Art.number	d x P	☒	Art.number	d x P	☒	Art.number
M8X1,00	2	55067.080.100	M12X1,50	2	55067.120.150	M22X1,50	1	55067.220.150
M10X1,00	2	55067.100.100	M14X1,50	1	55067.140.150	M24X1,50 (#DIN)	1	55067.240.150
M10X1,25	2	55067.100.125	M16X1,50	1	55067.160.150	M24X2,00	1	55067.240.200
M12X1,25	2	55067.120.125	M20X1,50	1	55067.200.150			

• Sizes with a diameter > M24 are at least property class 50.

Threaded rod UNC

ASME B18.31.3

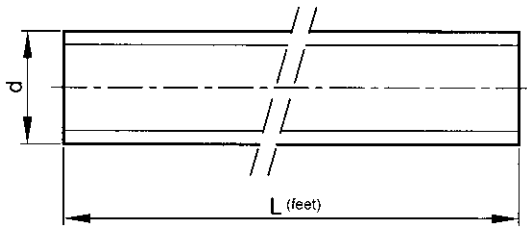

Technical Data

d	Threads per inch	d	Threads per inch
No.2	56	9/16	12
No.3	48	5/8	11
No.4	40	3/4	10
No.5	40	7/8	9
No.6	32	1 Inch	8
No.8	32	1.1/8	7
No.10	24	1.1/4	7
1/4	20	1.3/8	6
5/16	18	1.1/2	6
3/8	16	1.3/4	5
7/16	14	2 Inch	4.5
1/2	13		

Article groups

Thread	Material	Class	Surface treatment	Code	Page
UNC	St	Gr.2		various lengths	U20200 4-14
UNC	St	Gr.2	Zipl	various lengths	U20300 4-15
UNC	St	Gr.2	Hot d.g.	various lengths	U20170 4-16
UNC	St.St. A2 (AISI304/18-8)	F593		various lengths	U51070 4-16
UNC	St.St. A4 (AISI316/18-10)	F593		various lengths	U55070 4-17

U20200 Threaded rod

X09A

Thread Unified National Coarse
Material Steel
Class Gr.2





d x L	Art.number	d x L	Art.number	d x L	Art.number
NO.2-56X2*	U20200.008.2400	1/4-20X1*	U20200.025.1200	1/2-13X10*	U20200.050.8888
NO.2-56X3*	U20200.008.3600	1/4-20X2*	U20200.025.2400	1/2-13X12*	U20200.050.9999
NO.2-56X6*	U20200.008.7200	1/4-20X3*	U20200.025.3600		
		1/4-20X6*	U20200.025.7200	9/16-12X1*	U20200.056.1200
NO.3-48X3*	U20200.009.3600	1/4-20X10*	U20200.025.8888	9/16-12X2*	U20200.056.2400
		1/4-20X12*	U20200.025.9999	9/16-12X3*	U20200.056.3600
NO.4-40X2*	U20200.011.2400			9/16-12X6*	U20200.056.7200
NO.4-40X3*	U20200.011.3600	5/16-18X1*	U20200.031.1200	9/16-12X10*	U20200.056.8888
NO.4-40X6*	U20200.011.7200	5/16-18X2*	U20200.031.2400	9/16-12X12*	U20200.056.9999
		5/16-18X3*	U20200.031.3600		
NO.5-40X2*	U20200.012.2400	5/16-18X6*	U20200.031.7200	5/8-11X1*	U20200.062.1200
NO.5-40X3*	U20200.012.3600	5/16-18X10*	U20200.031.8888	5/8-11X2*	U20200.062.2400
NO.5-40X6*	U20200.012.7200	5/16-18X12*	U20200.031.9999	5/8-11X3*	U20200.062.3600
				5/8-11X6*	U20200.062.7200
NO.6-32X1*	U20200.013.1200	3/8-16X1*	U20200.037.1200	5/8-11X10*	U20200.062.8888
NO.6-32X2*	U20200.013.2400	3/8-16X2*	U20200.037.2400	5/8-11X12*	U20200.062.9999
NO.6-32X3*	U20200.013.3600	3/8-16X3*	U20200.037.3600		
NO.6-32X6*	U20200.013.7200	3/8-16X6*	U20200.037.7200	3/4-10X1*	U20200.075.1200
		3/8-16X10*	U20200.037.8888	3/4-10X2*	U20200.075.2400
		3/8-16X12*	U20200.037.9999	3/4-10X3*	U20200.075.3600
NO.8-32X1*	U20200.016.1200			3/4-10X6*	U20200.075.7200
NO.8-32X2*	U20200.016.2400	7/16-14X1*	U20200.043.1200	3/4-10X10*	U20200.075.8888
NO.8-32X3*	U20200.016.3600	7/16-14X2*	U20200.043.2400	3/4-10X12*	U20200.075.9999
NO.8-32X6*	U20200.016.7200	7/16-14X3*	U20200.043.3600		
		7/16-14X6*	U20200.043.7200	7/8-9X1*	U20200.087.1200
NO.10-24X1*	U20200.019.1200	7/16-14X10*	U20200.043.8888	7/8-9X2*	U20200.087.2400
NO.10-24X2*	U20200.019.2400			7/8-9X3*	U20200.087.3600
NO.10-24X3*	U20200.019.3600	1/2-13X1*	U20200.050.1200	7/8-9X6*	U20200.087.7200
NO.10-24X6*	U20200.019.7200	1/2-13X2*	U20200.050.2400	7/8-9X10*	U20200.087.8888
NO.10-24X10*	U20200.019.8888	1/2-13X3*	U20200.050.3600	7/8-9X12*	U20200.087.9999
NO.10-24X12*	U20200.019.9999	1/2-13X6*	U20200.050.7200		

U20200		Threaded rod						
d x L	☒	Art.number	d x L	☒	Art.number	d x L	☒	Art.number
1.-8X1*	1	U20200.100.1200	1.1/4-7X3*	1	U20200.125.3600	1.1/2-6X10*	1	U20200.150.8888
1.-8X2*	1	U20200.100.2400	1.1/4-7X6*	1	U20200.125.7200	1.1/2-6X12*	1	U20200.150.9999
1.-8X3*	1	U20200.100.3600	1.1/4-7X10*	1	U20200.125.8888			
1.-8X6*	1	U20200.100.7200	1.1/4-7X12*	1	U20200.125.9999	1.3/4-5X1*	1	U20200.175.1200
1.-8X10*	1	U20200.100.8888				1.3/4-5X2*	1	U20200.175.2400
1.-8X12*	1	U20200.100.9999	1.3/8-6X1*	1	U20200.137.1200	1.3/4-5X3*	1	U20200.175.3600
			1.3/8-6X2*	1	U20200.137.2400	1.3/4-5X6*	1	U20200.175.7200
1.1/8-7X1*	1	U20200.112.1200	1.3/8-6X3*	1	U20200.137.3600	1.3/4-5X10*	1	U20200.175.8888
1.1/8-7X2*	1	U20200.112.2400	1.3/8-6X6*	1	U20200.137.7200	1.3/4-5X12*	1	U20200.175.9999
1.1/8-7X3*	1	U20200.112.3600	1.3/8-6X10*	1	U20200.137.8888			
1.1/8-7X6*	1	U20200.112.7200	1.3/8-6X12*	1	U20200.137.9999	2.-4.5X1*	1	U20200.200.1200
1.1/8-7X10*	1	U20200.112.8888				2.-4.5X2*	1	U20200.200.2400
1.1/8-7X12*	1	U20200.112.9999	1.1/2-6X1*	1	U20200.150.1200	2.-4.5X3*	1	U20200.200.3600
			1.1/2-6X2*	1	U20200.150.2400	2.-4.5X6*	1	U20200.200.7200
1.1/4-7X1*	1	U20200.125.1200	1.1/2-6X3*	1	U20200.150.3600	2.-4.5X10*	1	U20200.200.8888
1.1/4-7X2*	1	U20200.125.2400	1.1/2-6X6*	1	U20200.150.7200	2.-4.5X12*	1	U20200.200.9999

U20300		Threaded rod				X09A	
Thread Material Class		Unified National Coarse Steel					
Surface treatment		Zinc plated					

d x L	☒	Art.number	d x L	☒	Art.number	d x L	☒	Art.number
NO.2-56X3*	1	U20300.008.3600	3/8-16X12*	1	U20300.037.9999	1.-8X6*	1	U20300.100.7200
NO.2-56X6*	1	U20300.008.7200				1.-8X10*	1	U20300.100.8888
			7/16-14X1*	1	U20300.043.1200	1.-8X12*	1	U20300.100.9999
NO.4-40X2*	1	U20300.011.2400	7/16-14X2*	1	U20300.043.2400			
NO.4-40X3*	1	U20300.011.3600	7/16-14X3*	1	U20300.043.3600	1.1/8-7X1*	1	U20300.112.1200
NO.4-40X6*	1	U20300.011.7200	7/16-14X6*	1	U20300.043.7200	1.1/8-7X2*	1	U20300.112.2400
			7/16-14X10*	1	U20300.043.8888	1.1/8-7X3*	1	U20300.112.3600
NO.5-40X2*	1	U20300.012.2400				1.1/8-7X6*	1	U20300.112.7200
NO.5-40X3*	1	U20300.012.3600	1/2-13X1*	1	U20300.050.1200	1.1/8-7X10*	1	U20300.112.8888
NO.5-40X6*	1	U20300.012.7200	1/2-13X2*	1	U20300.050.2400	1.1/8-7X12*	1	U20300.112.9999
			1/2-13X3*	1	U20300.050.3600			
NO.6-32X1*	1	U20300.013.1200	1/2-13X6*	1	U20300.050.7200	1.1/4-7X1*	1	U20300.125.1200
NO.6-32X2*	1	U20300.013.2400	1/2-13X10*	1	U20300.050.8888	1.1/4-7X2*	1	U20300.125.2400
NO.6-32X3*	1	U20300.013.3600	1/2-13X12*	1	U20300.050.9999	1.1/4-7X3*	1	U20300.125.3600
NO.6-32X6*	1	U20300.013.7200				1.1/4-7X6*	1	U20300.125.7200
			9/16-12X1*	1	U20300.056.1200	1.1/4-7X10*	1	U20300.125.8888
NO.8-32X1*	1	U20300.016.1200	9/16-12X2*	1	U20300.056.2400	1.1/4-7X12*	1	U20300.125.9999
NO.8-32X2*	1	U20300.016.2400	9/16-12X3*	1	U20300.056.3600			
NO.8-32X3*	1	U20300.016.3600	9/16-12X6*	1	U20300.056.7200	1.3/8-6X1*	1	U20300.137.1200
NO.8-32X6*	1	U20300.016.7200	9/16-12X10*	1	U20300.056.8888	1.3/8-6X2*	1	U20300.137.2400
			9/16-12X12*	1	U20300.056.9999	1.3/8-6X3*	1	U20300.137.3600
NO.10-24X1*	1	U20300.019.1200				1.3/8-6X6*	1	U20300.137.7200
NO.10-24X2*	1	U20300.019.2400	5/8-11X1*	1	U20300.062.1200	1.3/8-6X10*	1	U20300.137.8888
NO.10-24X3*	1	U20300.019.3600	5/8-11X2*	1	U20300.062.2400	1.3/8-6X12*	1	U20300.137.9999
NO.10-24X6*	1	U20300.019.7200	5/8-11X3*	1	U20300.062.3600			
NO.10-24X10*	1	U20300.019.8888	5/8-11X6*	1	U20300.062.7200	1.1/2-6X1*	1	U20300.150.1200
			5/8-11X10*	1	U20300.062.8888	1.1/2-6X2*	1	U20300.150.2400
1/4-20X1*	1	U20300.025.1200	5/8-11X12*	1	U20300.062.9999	1.1/2-6X3*	1	U20300.150.3600
1/4-20X2*	1	U20300.025.2400				1.1/2-6X6*	1	U20300.150.7200
1/4-20X3*	1	U20300.025.3600	3/4-10X1*	1	U20300.075.1200	1.1/2-6X10*	1	U20300.150.8888
1/4-20X6*	1	U20300.025.7200	3/4-10X2*	1	U20300.075.2400	1.1/2-6X12*	1	U20300.150.9999
1/4-20X10*	1	U20300.025.8888	3/4-10X3*	1	U20300.075.3600			
1/4-20X12*	1	U20300.025.9999	3/4-10X6*	1	U20300.075.7200	1.3/4-5X1*	1	U20300.175.1200
			3/4-10X10*	1	U20300.075.8888	1.3/4-5X2*	1	U20300.175.2400
5/16-18X1*	1	U20300.031.1200	3/4-10X12*	1	U20300.075.9999	1.3/4-5X3*	1	U20300.175.3600
5/16-18X2*	1	U20300.031.2400				1.3/4-5X6*	1	U20300.175.7200
5/16-18X3*	1	U20300.031.3600	7/8-9X1*	1	U20300.087.1200	1.3/4-5X10*	1	U20300.175.8888
5/16-18X6*	1	U20300.031.7200	7/8-9X2*	1	U20300.087.2400	1.3/4-5X12*	1	U20300.175.9999
5/16-18X10*	1	U20300.031.8888	7/8-9X3*	1	U20300.087.3600			
5/16-18X12*	1	U20300.031.9999	7/8-9X6*	1	U20300.087.7200	2.-4.5X1*	1	U20300.200.1200
			7/8-9X10*	1	U20300.087.8888	2.-4.5X2*	1	U20300.200.2400
3/8-16X1*	1	U20300.037.1200	7/8-9X12*	1	U20300.087.9999	2.-4.5X3*	1	U20300.200.3600
3/8-16X2*	1	U20300.037.2400				2.-4.5X6*	1	U20300.200.7200
3/8-16X3*	1	U20300.037.3600	1.-8X1*	1	U20300.100.1200	2.-4.5X10*	1	U20300.200.8888
3/8-16X6*	1	U20300.037.7200	1.-8X2*	1	U20300.100.2400	2.-4.5X12*	1	U20300.200.9999
3/8-16X10*	1	U20300.037.8888	1.-8X3*	1	U20300.100.3600			

U20170 Threaded rod		X09A	
Thread	Unified National Coarse		
Material	Steel		
Class	Gr.2		
Surface treatment	Hot dip galvanized		

d x L	☒	Art.number	d x L	☒	Art.number	d x L	☒	Art.number
3/8-16X2*	1	U20170.037.2400	5/8-11X10*	1	U20170.062.8888	1.1/8-7X2*	1	U20170.112.2400
3/8-16X3*	1	U20170.037.3600	5/8-11X12*	1	U20170.062.9999	1.1/8-7X3*	1	U20170.112.3600
3/8-16X6*	1	U20170.037.7200				1.1/8-7X12*	1	U20170.112.9999
3/8-16X10*	1	U20170.037.8888	3/4-10X2*	1	U20170.075.2400	1.1/4-7X2*	1	U20170.125.2400
3/8-16X12*	1	U20170.037.9999	3/4-10X3*	1	U20170.075.3600	1.1/4-7X3*	1	U20170.125.3600
			3/4-10X6*	1	U20170.075.7200	1.1/4-7X6*	1	U20170.125.7200
7/16-14X3*	1	U20170.043.3600	3/4-10X10*	1	U20170.075.8888	1.1/4-7X12*	1	U20170.125.9999
			3/4-10X12*	1	U20170.075.9999			
1/2-13X2*	1	U20170.050.2400	7/8-9X2*	1	U20170.087.2400	1.3/8-6X3*	1	U20170.137.3600
1/2-13X3*	1	U20170.050.3600	7/8-9X3*	1	U20170.087.3600			
1/2-13X6*	1	U20170.050.7200	7/8-9X6*	1	U20170.087.7200	1.1/2-6X2*	1	U20170.150.2400
1/2-13X10*	1	U20170.050.8888	7/8-9X12*	1	U20170.087.9999	1.1/2-6X3*	1	U20170.150.3600
1/2-13X12*	1	U20170.050.9999				1.1/2-6X6*	1	U20170.150.7200
			1.-8X2*	1	U20170.100.2400	1.1/2-6X12*	1	U20170.150.9999
9/16-12X3*	1	U20170.056.3600	1.-8X3*	1	U20170.100.3600			
			1.-8X6*	1	U20170.100.7200	1.3/4-5X3*	1	U20170.175.3600
5/8-11X2*	1	U20170.062.2400	1.-8X12*	1	U20170.100.9999			
5/8-11X3*	1	U20170.062.3600				2.-4.5X3*	1	U20170.200.3600
5/8-11X6*	1	U20170.062.7200						

- For hot dip galvanized threaded rods with OVERSIZED thread the zinc layer is applied ON the normal thread, so AFTER galvanizing these threaded rods are no longer ISO-metric mating, but thicker: so called OVERSIZED.
- They do not mate the usual fit of screwthread and cannot be used in e.g. normal threaded holes.
- The corresponding OVERSIZED nuts have been tapped AFTER galvanizing running perfectly onto these threaded rods.

U51070 Threaded rod		X15A	
Thread	Unified National Coarse		
Material	Stainless steel A2 (AISI 304/18-8)		
Class	F593		

d x L	☒	Art.number	d x L	☒	Art.number	d x L	☒	Art.number
NO.6-32X1*	1	U51070.013.1200	3/8-16X3*	1	U51070.037.3600	3/4-10X2*	1	U51070.075.2400
NO.6-32X2*	1	U51070.013.2400	3/8-16X6*	1	U51070.037.7200	3/4-10X3*	1	U51070.075.3600
NO.6-32X3*	1	U51070.013.3600	3/8-16X12*	1	U51070.037.9999	3/4-10X6*	1	U51070.075.7200
NO.6-32X6*	1	U51070.013.7200				3/4-10X12*	1	U51070.075.9999
			7/16-14X1*	1	U51070.043.1200			
NO.8-32X1*	1	U51070.016.1200	7/16-14X2*	1	U51070.043.2400	7/8-9X1*	1	U51070.087.1200
NO.8-32X2*	1	U51070.016.2400	7/16-14X3*	1	U51070.043.3600	7/8-9X2*	1	U51070.087.2400
NO.8-32X3*	1	U51070.016.3600	7/16-14X6*	1	U51070.043.7200	7/8-9X3*	1	U51070.087.3600
NO.8-32X6*	1	U51070.016.7200	7/16-14X12*	1	U51070.043.9999	7/8-9X6*	1	U51070.087.7200
						7/8-9X12*	1	U51070.087.9999
NO.10-24X1*	1	U51070.019.1200	1/2-13X1*	1	U51070.050.1200			
NO.10-24X2*	1	U51070.019.2400	1/2-13X2*	1	U51070.050.2400	1.-8X1*	1	U51070.100.1200
NO.10-24X3*	1	U51070.019.3600	1/2-13X3*	1	U51070.050.3600	1.-8X2*	1	U51070.100.2400
NO.10-24X6*	1	U51070.019.7200	1/2-13X6*	1	U51070.050.7200	1.-8X3*	1	U51070.100.3600
			1/2-13X12*	1	U51070.050.9999	1.-8X6*	1	U51070.100.7200
1/4-20X1*	1	U51070.025.1200				1.-8X12*	1	U51070.100.9999
1/4-20X2*	1	U51070.025.2400	9/16-12X1*	1	U51070.056.1200			
1/4-20X3*	1	U51070.025.3600	9/16-12X2*	1	U51070.056.2400	1.1/8-7X3*	1	U51070.112.3600
1/4-20X6*	1	U51070.025.7200	9/16-12X3*	1	U51070.056.3600			
1/4-20X12*	1	U51070.025.9999	9/16-12X6*	1	U51070.056.7200	1.1/4-7X1*	1	U51070.125.1200
			9/16-12X12*	1	U51070.056.9999	1.1/4-7X2*	1	U51070.125.2400
5/16-18X1*	1	U51070.031.1200				1.1/4-7X3*	1	U51070.125.3600
5/16-18X2*	1	U51070.031.2400	5/8-11X1*	1	U51070.062.1200	1.1/4-7X6*	1	U51070.125.7200
5/16-18X3*	1	U51070.031.3600	5/8-11X2*	1	U51070.062.2400			
5/16-18X6*	1	U51070.031.7200	5/8-11X3*	1	U51070.062.3600	1.1/2-6X1*	1	U51070.150.1200
5/16-18X12*	1	U51070.031.9999	5/8-11X6*	1	U51070.062.7200	1.1/2-6X2*	1	U51070.150.2400
			5/8-11X12*	1	U51070.062.9999	1.1/2-6X3*	1	U51070.150.3600
3/8-16X1*	1	U51070.037.1200				1.1/2-6X6*	1	U51070.150.7200
3/8-16X2*	1	U51070.037.2400	3/4-10X1*	1	U51070.075.1200			

U55070	Threaded rod	X15A
Thread Material Class	Unified National Coarse Stainless steel A4 (AISI 316/18-10) F593	
		

d x L	☒	Art.number	d x L	☒	Art.number	d x L	☒	Art.number
NO.6-32X1*	1	U55070.013.1200	5/16-18X6*	1	U55070.031.7200	7/8-9X2*	1	U55070.087.2400
NO.6-32X2*	1	U55070.013.2400				7/8-9X3*	1	U55070.087.3600
NO.6-32X3*	1	U55070.013.3600	3/8-16X1*	1	U55070.037.1200	7/8-9X6*	1	U55070.087.7200
NO.6-32X6*	1	U55070.013.7200	3/8-16X2*	1	U55070.037.2400			
			3/8-16X3*	1	U55070.037.3600	1.-8X1*	1	U55070.100.1200
NO.8-32X1*	1	U55070.016.1200	3/8-16X6*	1	U55070.037.7200	1.-8X2*	1	U55070.100.2400
NO.8-32X2*	1	U55070.016.2400				1.-8X3*	1	U55070.100.3600
NO.8-32X3*	1	U55070.016.3600	1/2-13X1*	1	U55070.050.1200	1.-8X6*	1	U55070.100.7200
NO.8-32X6*	1	U55070.016.7200	1/2-13X2*	1	U55070.050.2400			
			1/2-13X3*	1	U55070.050.3600	1.1/8-7X1*	1	U55070.112.1200
NO.10-24X1*	1	U55070.019.1200	1/2-13X6*	1	U55070.050.7200	1.1/8-7X2*	1	U55070.112.2400
NO.10-24X2*	1	U55070.019.2400				1.1/8-7X3*	1	U55070.112.3600
NO.10-24X3*	1	U55070.019.3600	5/8-11X1*	1	U55070.062.1200	1.1/8-7X6*	1	U55070.112.7200
NO.10-24X6*	1	U55070.019.7200	5/8-11X2*	1	U55070.062.2400			
			5/8-11X3*	1	U55070.062.3600	1.1/4-7X1*	1	U55070.125.1200
1/4-20X1*	1	U55070.025.1200	5/8-11X6*	1	U55070.062.7200	1.1/4-7X2*	1	U55070.125.2400
1/4-20X2*	1	U55070.025.2400				1.1/4-7X3*	1	U55070.125.3600
1/4-20X3*	1	U55070.025.3600	3/4-10X1*	1	U55070.075.1200	1.1/4-7X6*	1	U55070.125.7200
1/4-20X6*	1	U55070.025.7200	3/4-10X2*	1	U55070.075.2400			
			3/4-10X3*	1	U55070.075.3600	1.1/2-6X1*	1	U55070.150.1200
5/16-18X1*	1	U55070.031.1200	3/4-10X6*	1	U55070.075.7200	1.1/2-6X2*	1	U55070.150.2400
5/16-18X2*	1	U55070.031.2400				1.1/2-6X3*	1	U55070.150.3600
5/16-18X3*	1	U55070.031.3600	7/8-9X1*	1	U55070.087.1200	1.1/2-6X6*	1	U55070.150.7200

4

Threaded rod UNF

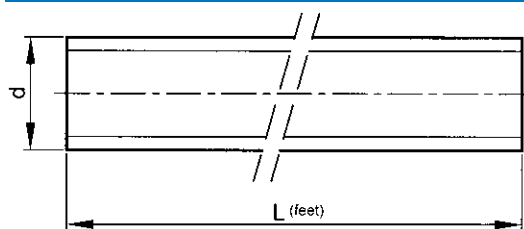

ASME B18.31.3



Technical Data

d	Threads per inch	d	Threads per inch
No.10	32	7/8	14
1/4	28	1 Inch-12G	12
5/16	24	1 Inch	12
3/8	24	1.1/8	12
7/16	20	1.1/4	12
1/2	20	1.3/8	12
9/16	18	1.1/2	12
5/8	18	1.3/4	12
3/4	16	2 Inch	12

Article groups

Thread	Material	Class	Surface treatment	Code	Page
UNF	St	Gr.2		various lengths	U20360 4-18
UNF	St	Gr.2	Zipl	various lengths	U20365 4-18
UNF	St.St. A2 (AISI304/18-8)	F593		various lengths	U51067 4-19
UNF	St.St. A4 (AISI316/18-10)	F593		various lengths	U55067 4-19

U20360	Threaded rod			X09A
Thread Material Class	Unified National Fine Steel Gr.2			
				
				

d x L	☒	Art.number	d x L	☒	Art.number	d x L	☒	Art.number
NO.10-32X1*	1	U20360.019.1200	1/2-20X12*	1	U20360.050.9999	1.1/8-12X2*	1	U20360.112.2400
NO.10-32X2*	1	U20360.019.2400				1.1/8-12X3*	1	U20360.112.3600
NO.10-32X3*	1	U20360.019.3600	9/16-18X1*	1	U20360.056.1200	1.1/8-12X6*	1	U20360.112.7200
NO.10-32X6*	1	U20360.019.7200	9/16-18X2*	1	U20360.056.2400	1.1/8-12X12*	1	U20360.112.9999
			9/16-18X3*	1	U20360.056.3600			
1/4-28X1*	1	U20360.025.1200	9/16-18X6*	1	U20360.056.7200	1.1/4-12X1*	1	U20360.125.1200
1/4-28X2*	1	U20360.025.2400	9/16-18X10*	1	U20360.056.8888	1.1/4-12X2*	1	U20360.125.2400
1/4-28X3*	1	U20360.025.3600	9/16-18X12*	1	U20360.056.9999	1.1/4-12X3*	1	U20360.125.3600
1/4-28X6*	1	U20360.025.7200				1.1/4-12X6*	1	U20360.125.7200
1/4-28X12*	1	U20360.025.9999	5/8-18X1*	1	U20360.062.1200	1.1/4-12X12*	1	U20360.125.9999
			5/8-18X2*	1	U20360.062.2400			
5/16-24X1*	1	U20360.031.1200	5/8-18X3*	1	U20360.062.3600	1.3/8-12X1*	1	U20360.137.1200
5/16-24X2*	1	U20360.031.2400	5/8-18X6*	1	U20360.062.7200	1.3/8-12X2*	1	U20360.137.2400
5/16-24X3*	1	U20360.031.3600	5/8-18X12*	1	U20360.062.9999	1.3/8-12X3*	1	U20360.137.3600
5/16-24X6*	1	U20360.031.7200				1.3/8-12X6*	1	U20360.137.7200
5/16-24X12*	1	U20360.031.9999	3/4-16X1*	1	U20360.075.1200	1.3/8-12X12*	1	U20360.137.9999
			3/4-16X2*	1	U20360.075.2400			
3/8-24X1*	1	U20360.037.1200	3/4-16X3*	1	U20360.075.3600	1.1/2-12X1*	1	U20360.150.1200
3/8-24X2*	1	U20360.037.2400	3/4-16X6*	1	U20360.075.7200	1.1/2-12X2*	1	U20360.150.2400
3/8-24X3*	1	U20360.037.3600	3/4-16X12*	1	U20360.075.9999	1.1/2-12X3*	1	U20360.150.3600
3/8-24X6*	1	U20360.037.7200				1.1/2-12X6*	1	U20360.150.7200
3/8-24X12*	1	U20360.037.9999	7/8-14X1*	1	U20360.087.1200	1.1/2-12X12*	1	U20360.150.9999
			7/8-14X2*	1	U20360.087.2400			
7/16-20X1*	1	U20360.043.1200	7/8-14X3*	1	U20360.087.3600	1.3/4-12X1*	1	U20360.175.1200
7/16-20X2*	1	U20360.043.2400	7/8-14X6*	1	U20360.087.7200	1.3/4-12X2*	1	U20360.175.2400
7/16-20X3*	1	U20360.043.3600	7/8-14X12*	1	U20360.087.9999	1.3/4-12X3*	1	U20360.175.3600
7/16-20X6*	1	U20360.043.7200				1.3/4-12X6*	1	U20360.175.7200
7/16-20X12*	1	U20360.043.9999	1.-12X1*	1	U20360.100.1200	1.3/4-12X12*	1	U20360.175.9999
			1.-12X2*	1	U20360.100.2400			
1/2-20X1*	1	U20360.050.1200	1.-12X3*	1	U20360.100.3600	2.-12X1*	1	U20360.200.1200
1/2-20X2*	1	U20360.050.2400	1.-12X12*	1	U20360.100.9999	2.-12X2*	1	U20360.200.2400
1/2-20X3*	1	U20360.050.3600				2.-12X3*	1	U20360.200.3600
1/2-20X6*	1	U20360.050.7200	1.1/8-12X1*	1	U20360.112.1200	2.-12X6*	1	U20360.200.7200

U20365	Threaded rod			X09A
Thread Material Class	Unified National Fine Steel Gr.2			
Surface treatment	Zinc plated			
				
				



d x L	☒	Art.number	d x L	☒	Art.number	d x L	☒	Art.number
NO.10-32X1*	1	U20365.019.1200	1/2-20X2*	1	U20365.050.2400	1.-12X1*	1	U20365.100.1200
NO.10-32X2*	1	U20365.019.2400	1/2-20X3*	1	U20365.050.3600	1.-12X2*	1	U20365.100.2400
NO.10-32X3*	1	U20365.019.3600	1/2-20X6*	1	U20365.050.7200	1.-12X3*	1	U20365.100.3600
NO.10-32X6*	1	U20365.019.7200	1/2-20X10*	1	U20365.050.8888	1.-12X12*	1	U20365.100.9999
			1/2-20X12*	1	U20365.050.9999			
1/4-28X1*	1	U20365.025.1200	9/16-18X1*	1	U20365.056.1200	1.1/8-12X1*	1	U20365.112.1200
1/4-28X2*	1	U20365.025.2400	9/16-18X2*	1	U20365.056.2400	1.1/8-12X2*	1	U20365.112.2400
1/4-28X3*	1	U20365.025.3600	9/16-18X3*	1	U20365.056.3600	1.1/8-12X3*	1	U20365.112.3600
1/4-28X6*	1	U20365.025.7200	9/16-18X6*	1	U20365.056.7200	1.1/8-12X6*	1	U20365.112.7200
1/4-28X10*	1	U20365.025.8888	9/16-18X10*	1	U20365.056.8888	1.1/8-12X12*	1	U20365.112.9999
			9/16-18X12*	1	U20365.056.9999			
5/16-24X1*	1	U20365.031.1200	5/8-18X1*	1	U20365.062.1200	1.1/4-12X1*	1	U20365.125.1200
5/16-24X2*	1	U20365.031.2400	5/8-18X2*	1	U20365.062.2400	1.1/4-12X2*	1	U20365.125.2400
5/16-24X3*	1	U20365.031.3600	5/8-18X3*	1	U20365.062.3600	1.1/4-12X3*	1	U20365.125.3600
5/16-24X6*	1	U20365.031.7200	5/8-18X6*	1	U20365.062.7200	1.1/4-12X6*	1	U20365.125.7200
5/16-24X12*	1	U20365.031.9999	5/8-18X12*	1	U20365.062.9999	1.1/4-12X12*	1	U20365.125.9999
3/8-24X1*	1	U20365.037.1200	3/4-16X1*	1	U20365.075.1200	1.3/8-12X1*	1	U20365.137.1200
3/8-24X2*	1	U20365.037.2400	3/4-16X2*	1	U20365.075.2400	1.3/8-12X3*	1	U20365.137.3600
3/8-24X3*	1	U20365.037.3600	3/4-16X3*	1	U20365.075.3600	1.3/8-12X6*	1	U20365.137.7200
3/8-24X6*	1	U20365.037.7200	3/4-16X6*	1	U20365.075.7200	1.3/8-12X12*	1	U20365.137.9999
3/8-24X12*	1	U20365.037.9999	3/4-16X12*	1	U20365.075.9999			
7/16-20X1*	1	U20365.043.1200	7/8-14X1*	1	U20365.087.1200	1.1/2-12X1*	1	U20365.150.1200
7/16-20X2*	1	U20365.043.2400	7/8-14X2*	1	U20365.087.2400	1.1/2-12X2*	1	U20365.150.2400
7/16-20X3*	1	U20365.043.3600	7/8-14X3*	1	U20365.087.3600	1.1/2-12X3*	1	U20365.150.3600
7/16-20X6*	1	U20365.043.7200	7/8-14X6*	1	U20365.087.7200	1.1/2-12X6*	1	U20365.150.7200
7/16-20X12*	1	U20365.043.9999	7/8-14X12*	1	U20365.087.9999			
1/2-20X1*	1	U20365.050.1200				1.3/4-12X1*	1	U20365.175.1200
						1.3/4-12X6*	1	U20365.175.7200

U20365 Threaded rod ←

d x L	☒	Art.number
1.3/4-12X12*	1	U20365.175.9999

U51067 Threaded rod X15A

Thread	Unified National Fine
Material	Stainless steel A2 (AISI 304/18-8)
Class	F593

d x L	☒	Art.number	d x L	☒	Art.number	d x L	☒	Art.number
NO.10-32X1*	1	U51067.019.1200	3/8-24X2*	1	U51067.037.2400	5/8-18X1*	1	U51067.062.1200
NO.10-32X2*	1	U51067.019.2400	3/8-24X3*	1	U51067.037.3600	5/8-18X2*	1	U51067.062.2400
NO.10-32X3*	1	U51067.019.3600	3/8-24X6*	1	U51067.037.7200	5/8-18X3*	1	U51067.062.3600
NO.10-32X6*	1	U51067.019.7200				5/8-18X6*	1	U51067.062.7200
			7/16-20X1*	1	U51067.043.1200			
1/4-28X1*	1	U51067.025.1200	7/16-20X2*	1	U51067.043.2400	3/4-16X1*	1	U51067.075.1200
1/4-28X2*	1	U51067.025.2400	7/16-20X3*	1	U51067.043.3600	3/4-16X2*	1	U51067.075.2400
1/4-28X3*	1	U51067.025.3600	7/16-20X6*	1	U51067.043.7200	3/4-16X3*	1	U51067.075.3600
1/4-28X6*	1	U51067.025.7200				3/4-16X6*	1	U51067.075.7200
			1/2-20X1*	1	U51067.050.1200			
5/16-24X1*	1	U51067.031.1200	1/2-20X2*	1	U51067.050.2400	7/8-14X1*	1	U51067.087.1200
5/16-24X2*	1	U51067.031.2400	1/2-20X3*	1	U51067.050.3600	7/8-14X2*	1	U51067.087.2400
5/16-24X3*	1	U51067.031.3600	1/2-20X6*	1	U51067.050.7200	7/8-14X3*	1	U51067.087.3600
5/16-24X6*	1	U51067.031.7200				7/8-14X6*	1	U51067.087.7200
3/8-24X1*	1	U51067.037.1200	9/16-18X3*	1	U51067.056.3600			
						1.1/8-12X3*	1	U51067.112.3600

4
U55067 Threaded rod X15A

Thread	Unified National Fine
Material	Stainless steel A4 (AISI 316/18-10)
Class	F593



d x L	☒	Art.number	d x L	☒	Art.number	d x L	☒	Art.number
NO.10-32X1*	1	U55067.019.1200	3/8-24X1*	1	U55067.037.1200	5/8-18X1*	1	U55067.062.1200
NO.10-32X2*	1	U55067.019.2400	3/8-24X2*	1	U55067.037.2400	5/8-18X2*	1	U55067.062.2400
NO.10-32X3*	1	U55067.019.3600	3/8-24X3*	1	U55067.037.3600	5/8-18X3*	1	U55067.062.3600
NO.10-32X6*	1	U55067.019.7200	3/8-24X6*	1	U55067.037.7200	5/8-18X6*	1	U55067.062.7200
1/4-28X1*	1	U55067.025.1200	7/16-20X3*	1	U55067.043.3600	3/4-16X1*	1	U55067.075.1200
1/4-28X2*	1	U55067.025.2400				3/4-16X2*	1	U55067.075.2400
1/4-28X3*	1	U55067.025.3600	1/2-20X1*	1	U55067.050.1200	3/4-16X3*	1	U55067.075.3600
1/4-28X6*	1	U55067.025.7200	1/2-20X2*	1	U55067.050.2400	3/4-16X6*	1	U55067.075.7200
			1/2-20X3*	1	U55067.050.3600			
5/16-24X1*	1	U55067.031.1200	1/2-20X6*	1	U55067.050.7200	7/8-14X3*	1	U55067.087.3600
5/16-24X2*	1	U55067.031.2400						
5/16-24X3*	1	U55067.031.3600	9/16-18X3*	1	U55067.056.3600			
5/16-24X6*	1	U55067.031.7200						

Threaded rod BSW

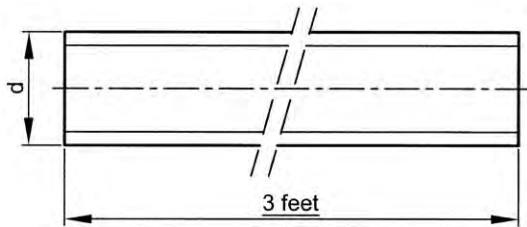

Technical Data

d	Threads per inch	d	Threads per inch
1/8	40	5/8	11
5/32	32	3/4	10
3/16	24	7/8	9
1/4	20	1 Inch	8
5/16	18	1.1/8	7
3/8	16	1.1/4	7
7/16	14	1.1/2	6
1/2	12		

- Whitworth thread (BSW/BSF) is not internationally recommended.
- It is advised to use metric (M/MF) or unified threads (UNC/UNF).

Article groups

Thread	Material	Class	Surface treatment	Code	Page
BSW	St	≥4.8		1 meter	20240
BSW	St	≥4.8	Zipl	1 meter	20252
BSW	Br Cu2/Cu3			1 meter	46290

20240 Threaded rod BSW X08A

Thread: British Standard Whitworth
 Material: Steel
 Class: ≥4.8

d	⊗	Art.number	d	⊗	Art.number	d	⊗	Art.number
1/8	20	20240.031.001	3/8	10	20240.096.001	7/8	2	20240.222.001
5/32	20	20240.039.001	7/16	10	20240.111.001	1 Inch	2	20240.254.001
3/16	10	20240.047.001	1/2	10	20240.127.001	1.1/8	2	20240.285.001
1/4	10	20240.063.001	5/8	5	20240.158.001	1.1/4	2	20240.317.001
5/16	10	20240.079.001	3/4	2	20240.191.001	1.1/2	1	20240.381.001

20252 Threaded rod BSW X08A

Thread: British Standard Whitworth
 Material: Steel
 Class: ≥4.8
 Surface treatment: Zinc plated

d	⊗	Art.number	d	⊗	Art.number	d	⊗	Art.number
1/4	10	20252.063.001	1/2	10	20252.127.001	7/8	2	20252.222.001
5/16	10	20252.079.001	5/8	5	20252.158.001	1 Inch	2	20252.254.001
3/8	10	20252.096.001	3/4	2	20252.191.001			

46290 Threaded rod BSW X08A

Thread: British Standard Whitworth
 Material: Brass Cu2/Cu3

d	⊗	Art.number	d	⊗	Art.number	d	⊗	Art.number
5/32	10	46290.039.001	5/16	10	46290.079.001	5/8	2	46290.158.001
3/16	10	46290.047.001	3/8	5	46290.096.001	3/4	1	46290.191.001
1/4	10	46290.063.001	1/2	2	46290.127.001	7/8	1	46290.222.001

Threaded rod Permaglas

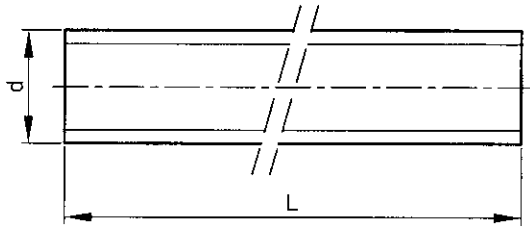

Technical Data

d	P	d	P
M8	1.25	M16	2
M10	1.5	M20	2.5
M12	1.75	M24	3

- Special features PERMAGLAS:
- Glass-fiber reinforced epoxy
- Temperature resistant -270°C up to +155°C
- Light weight (gravity 1,8)
- Corrosion resistant
- Resistant to aggressive chemicals and gases
- Electrical- and thermal insulated
- Non-magnetic
- Higher mechanical properties as f.i. Polyamid

4

56050 Threaded rod Permaglas		W05G
Thread	Metric thread	
Material	Glass-fibre reinforced plastic Permaglas ME 771	
Color	Red	

d x L	☒	Art.number	d x L	☒	Art.number	d x L	☒	Art.number
M8X950	1	56050.080.950	M12X1900	1	56050.121.900	M20X1900	1	56050.201.900
M10X950	1	56050.100.950	M16X1900	1	56050.161.900	M24X1900	1	56050.241.900

Hexagon nut Permaglas

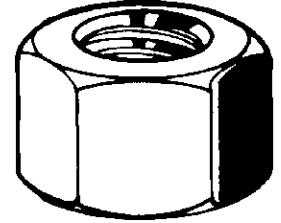
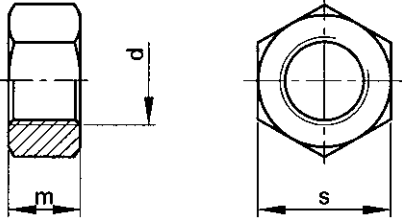

Technical Data

d	m	P	s	d	m	P	s
M8	8	1.25	13	M16	16	2	24
M10	10	1.5	17	M20	20	2.5	30
M12	12	1.75	19	M24	24	3	36

4

- Special features PERMAGLAS:
- Glass-fiber reinforced epoxy
- Temperature resistant -270°C up to +155°C
- Light weight (gravity 1,8)
- Corrosion resistant
- Resistant to aggressive chemicals and gases
- Electrical- and thermal insulated
- Non-magnetic
- Higher mechanical properties as f.i. Polyamid

56052 Hexagon nut Permaglas		W05G
Thread	Metric thread	
Material	Glass-fibre reinforced plastic Permaglas ME 730	
Color	Beige	

d	☒	Art.number	d	☒	Art.number	d	☒	Art.number
M8	8	56052.080.001	M12	8	56052.120.001	M20	4	56052.200.001
M10	8	56052.100.001	M16	4	56052.160.001	M24	4	56052.240.001

Plain washer without chamfer Permaglas

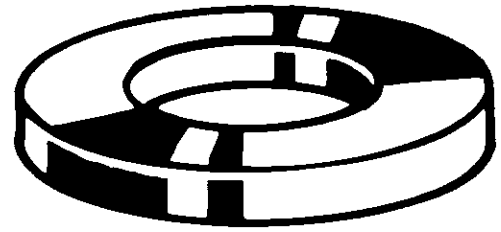
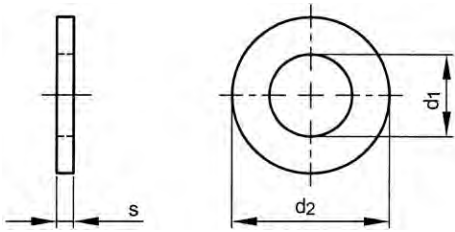

Technical Data

d	d ₁	d ₂	s	d	d ₁	d ₂	s
M8	9	18	1.5	M16	18	32	3
M10	11	22	2	M20	22	40	3
M12	14	27	2.5	M24	27	50	4

- Special features PERMAGLAS:
- Glass-fiber reinforced epoxy.
- Temperature resistant -270°C up to +155°C.
- Light weight (gravity 1,8).
- Corrosion resistant.
- Resistant to aggressive chemicals and gases.
- Electrical- and thermal insulated.
- Non-magnetic.
- Higher mechanical properties as f.i. Polyamid.

4

56054 Plain washer without chamfer Permaglas		W05G
Material	Glass-fibre reinforced plastic Permaglas ME 730	
Color	Beige	

d	☒	Art.number	d	☒	Art.number	d	☒	Art.number
M8	8	56054.080.001	M12	8	56054.120.001	M20	4	56054.200.001
M10	8	56054.100.001	M16	4	56054.160.001	M24	4	56054.240.001

Threaded rod Tr

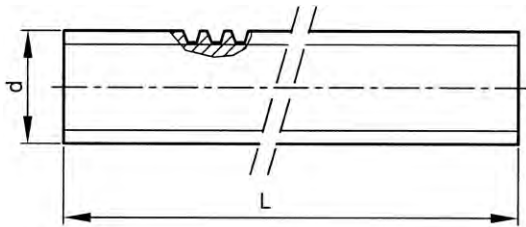



- Trapezoidal thread according to DIN 103, straightness of threaded rods according to DIN 7168-2, tolerance class U.

Article groups

Thread	Material	Class		Code	Page
Tr	St	5.8	1 meter	20460	4-24
Tr	St	5.8	1 meter left hand	20466	4-24
Tr	St.St. A2		1 meter	51076	4-24
Tr	St	5.8	3 meter	20464	4-24
Tr	St.St. A2		3 meter	51077	4-25

20460 Threaded rod length 1 meter						G05A
Thread	Trapezoidal thread					
Material	Steel					
Class	5.8					
						
						

d x P	☒	Art.number	d x P	☒	Art.number	d x P	☒	Art.number
Tr10X3 (#DIN)	5	20460.100.003	Tr22X5	2	20460.220.005	Tr36X6	1	20460.360.006
Tr12X3	5	20460.120.003	Tr24X5	2	20460.240.005	Tr40X7	1	20460.400.007
Tr14X4	3	20460.140.004	Tr26X5	1	20460.260.005	Tr44X7	1	20460.440.007
Tr16X4	3	20460.160.004	Tr28X5	1	20460.280.005	Tr50X8	1	20460.500.008
Tr18X4	2	20460.180.004	Tr30X6	1	20460.300.006	Tr60X9	1	20460.600.009
Tr20X4	2	20460.200.004	Tr32X6	1	20460.320.006			

20466 Threaded rod length 1 meter left hand thread						G05A
Thread	Trapezoidal thread					
Material	Steel					
Class	5.8					
						
						



d x P	☒	Art.number	d x P	☒	Art.number	d x P	☒	Art.number
Tr12X3	3	20466.120.003	Tr24X5	1	20466.240.005	Tr36X6	1	20466.360.006
Tr16X4	2	20466.160.004	Tr30X6	1	20466.300.006	Tr40X7	1	20466.400.007
Tr20X4	1	20466.200.004						

51076 Threaded rod length 1 meter						R09A
Thread	Trapezoidal thread					
Material	Stainless steel A2					
						
						

d x P	☒	Art.number	d x P	☒	Art.number	d x P	☒	Art.number
Tr12X3	1	51076.120.003	Tr20X4	1	51076.200.004	Tr30X6	1	51076.300.006
Tr16X4	1	51076.160.004	Tr24X5	1	51076.240.005			

20464	Threaded rod length 3 meter	G05A
Thread	Trapezoidal thread	
Material	Steel	
Class	5.8	
		

d x P	☒	Art.number	d x P	☒	Art.number	d x P	☒	Art.number
Tr10X3 (#DIN)	1	20464.100.003	Tr20X4	1	20464.200.004	Tr36X6	1	20464.360.006
Tr12X3	1	20464.120.003	Tr24X5	1	20464.240.005	Tr40X7	1	20464.400.007
Tr16X4	1	20464.160.004	Tr30X6	1	20464.300.006			

51077	Threaded rod length 3 meter	R09A
Thread	Trapezoidal thread	
Material	Stainless steel A2	
		

d x P	☒	Art.number	d x P	☒	Art.number	d x P	☒	Art.number
Tr12X3	1	51077.120.003	Tr20X4	1	51077.200.004	Tr30X6	1	51077.300.006
Tr16X4	1	51077.160.004	Tr24X5	1	51077.240.005	Tr36X6	1	51077.360.006

Round nut Tr

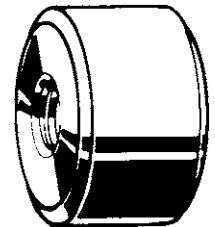
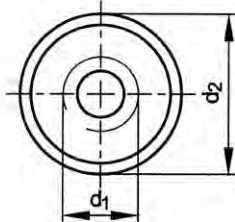
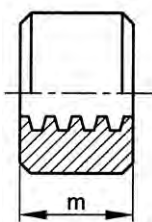



Technical Data

d ₁	d ₂	m	d ₁	d ₂	m
Tr10 (#DIN)	22	15	Tr28	60	42
Tr12	26	18	Tr30	60	45
Tr14	30	21	Tr32	60	48
Tr16	36	24	Tr36	75	54
Tr18	40	27	Tr40	80	60
Tr20	45	30	Tr44	80	66
Tr22	45	33	Tr50	90	75
Tr24	50	36	Tr60	100	90
Tr26	50	39			

- Trapezoidal thread acc. to DIN 103.

Article groups

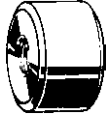
Thread	Material	Code	Page
Tr	Free-cutting steel	20470	4-25
Tr	Free-cutting steel	left hand	4-26
Tr	St.St. A1	51170	4-26

20470	Round nut Tr	G05A
Thread	Trapezoidal thread	
Material	Free-cutting steel	
		

d ₁ x P	☒	Art.number	d ₁ x P	☒	Art.number	d ₁ x P	☒	Art.number
Tr10X3 (#DIN)	10	20470.100.003	Tr22X5	4	20470.220.005	Tr36X6	2	20470.360.006
Tr12X3	10	20470.120.003	Tr24X5	4	20470.240.005	Tr40X7	2	20470.400.007
Tr14X4	6	20470.140.004	Tr26X5	2	20470.260.005	Tr44X7	2	20470.440.007
Tr16X4	6	20470.160.004	Tr28X5	2	20470.280.005	Tr50X8	2	20470.500.008
Tr18X4	4	20470.180.004	Tr30X6	2	20470.300.006	Tr60X9	2	20470.600.009
Tr20X4	4	20470.200.004	Tr32X6	2	20470.320.006			

20476	Round nut left hand thread	G05A
Thread	Trapezoidal thread	
Material	Free-cutting steel	

$d_1 \times P$	☒	Art.number	$d_1 \times P$	☒	Art.number	$d_1 \times P$	☒	Art.number
Tr12X3	6	20476.120.003	Tr24X5	2	20476.240.005	Tr36X6	2	20476.360.006
Tr16X4	4	20476.160.004	Tr30X6	2	20476.300.006	Tr40X7	2	20476.400.007
Tr20X4	2	20476.200.004	Tr32X6	2	20476.320.006			

51170	Round nut Tr	R09A
Thread	Trapezoidal thread	
Material	Stainless steel A1	

$d_1 \times P$	☒	Art.number	$d_1 \times P$	☒	Art.number	$d_1 \times P$	☒	Art.number
Tr12X3	1	51170.120.003	Tr20X4	1	51170.200.004	Tr30X6	1	51170.300.006
Tr16X4	1	51170.160.004	Tr24X5	1	51170.240.005			

4

Round nut Tr

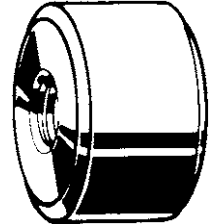
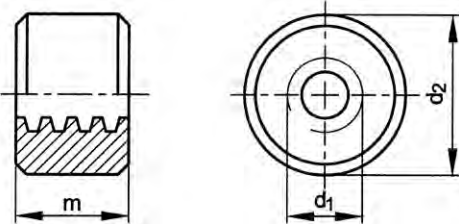

Technical Data

d_1	d_2	m	d_1	d_2	m
Tr12	26	24	Tr30	60	60
Tr16	36	32	Tr36	75	72
Tr20	45	40	Tr40	80	80
Tr24	50	48			

- Trapezoidal thread acc. to DIN 103.

Article groups

Thread	Material	Code	Page
Tr	Bronze Cu4	20474	4-26
Tr	Bronze Cu4	left hand	20478

20474	Round nut Tr	G05A
Thread	Trapezoidal thread	
Material	Bronze Cu4	

$d_1 \times P$	☒	Art.number	$d_1 \times P$	☒	Art.number	$d_1 \times P$	☒	Art.number
Tr12X3	6	20474.120.003	Tr24X5	2	20474.240.005	Tr36X6	1	20474.360.006
Tr16X4	4	20474.160.004	Tr30X6	1	20474.300.006	Tr40X7	1	20474.400.007
Tr20X4	2	20474.200.004						

20478	Round nut Tr Left hand	G05A
Thread	Trapezoidal thread	
Material	Bronze Cu4	

d x P	✉	Art.number	d x P	✉	Art.number
TR20X4	2	20478.200.004	TR24X5	1	20478.240.005

Stud metal end $\approx 1d$

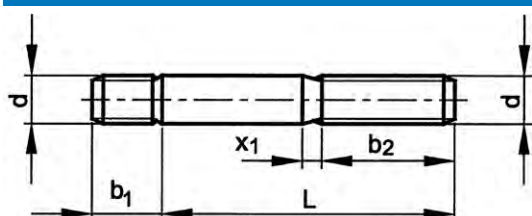

DIN 938
NEN 2331
NF E25-135



4

Technical Data

d	$b_1 \approx 1d$	b_2	$b_2 = L - (x_1 + 3) \text{ t/m } L \leq$	P	x_1
M5	5	16	20	0.8	2.0
M6	6	18	22	1	2.5
M8	8	22	28	1.25	3.2
M10	10	26	30	1.5	3.8
M12	12	30	35	1.75	4.3
M14	14	34	40	2	5.0
M16	16	38	45	2	5.0
M20	20	46	55	2.5	6.3
M24	24	54	65	3	7.5
M30	30	66	80	3.5	9.0

- ATTENTION: when ordering studs acc. to DIN the diameter d x the effective length L has to be stated e.g. stud M10 x 70 - DIN 938, where L = 70 mm is the working length and $b_1 = 10$ mm the metal end. The total length is $70 + 10 = 80$ mm. The thread length on the outside $b_2 = 26$ mm.
- The screw-in threaded end has been made with tolerance Sk6, acc. to DIN 13-51, meaning "heavy fit", and prevents loosening of studs during disassembly.
- Studs acc. to DIN 938 with a metal end $\approx 1d$ have many applications, among others in steel.

Article groups

Thread	Material	Class	Code	Page
M	St	8.8	21560	4-27
M	St.St. A2	70	51280	4-28
M	St.St. A4	70	55280	4-28

21560	Stud metal end $\approx 1d$	G07A
Thread	Metric thread	
Material	Steel	
Class	8.8	



d x L	✉	Art.number	d x L	✉	Art.number	d x L	✉	Art.number
M6X20	200	21560.060.020	M10X35	100	21560.100.035	M12X100	50	21560.120.100
M6X25	200	21560.060.025	M10X40	100	21560.100.040	M16X35	50	21560.160.035
M6X30	200	21560.060.030	M10X45	100	21560.100.045	M16X40	50	21560.160.040
M6X40	200	21560.060.040	M10X50	100	21560.100.050	M16X45	50	21560.160.045
M6X50	200	21560.060.050	M10X55	100	21560.100.055	M16X50	50	21560.160.050
M8X20	100	21560.080.020	M10X60	100	21560.100.060	M16X60	50	21560.160.060
M8X25	100	21560.080.025	M10X70	100	21560.100.070	M16X70	25	21560.160.070
M8X30	100	21560.080.030	M12X25	100	21560.120.025	M16X80	25	21560.160.080
M8X35	100	21560.080.035	M12X30	100	21560.120.030	M16X90	25	21560.160.090
M8X40	100	21560.080.040	M12X35	100	21560.120.035	M16X100	25	21560.160.100
M8X50	100	21560.080.050	M12X40	100	21560.120.040	M20X40	25	21560.200.040
M8X60	100	21560.080.060	M12X45	100	21560.120.045	M20X45	25	21560.200.045
M8X70	100	21560.080.070	M12X50	50	21560.120.050	M20X50	25	21560.200.050
M10X20	100	21560.100.020	M12X60	50	21560.120.060	M20X55	25	21560.200.055
M10X25	100	21560.100.025	M12X70	50	21560.120.070	M20X60	25	21560.200.060
M10X30	100	21560.100.030	M12X80	50	21560.120.080	M20X70	25	21560.200.070
			M12X90	50	21560.120.090			

21560 Stud metal end ≈ 1d								
d x L	☒	Art.number	d x L	☒	Art.number	d x L	☒	Art.number
M20X80	25	21560.200.080				M24X80	10	21560.240.080
M20X100	10	21560.200.100	M24X60	10	21560.240.060			
M20X120	10	21560.200.120	M24X70	10	21560.240.070			

51280 Stud metal end ≈ 1d								R09A
Thread	Metric thread							
Material	Stainless steel A2							
Class	70							
								

d x L	☒	Art.number	d x L	☒	Art.number	d x L	☒	Art.number
M5X16*	200	51280.050.016	M10X65*	100	51280.100.065	M16X65	10	51280.160.065
M5X20*	200	51280.050.020	M10X70	25	51280.100.070	M16X70*	50	51280.160.070
			M10X80*	100	51280.100.080	M16X75*	50	51280.160.075
M6X16*	200	51280.060.016	M10X90*	100	51280.100.090	M16X80	10	51280.160.080
M6X20	100	51280.060.020	M10X100*	100	51280.100.100	M16X85*	50	51280.160.085
M6X25	100	51280.060.025	M10X110*	100	51280.100.110	M16X90*	50	51280.160.090
M6X30	100	51280.060.030				M16X100*	50	51280.160.100
M6X35	100	51280.060.035	M12X20*	100	51280.120.020	M16X110*	50	51280.160.110
M6X40	100	51280.060.040	M12X25*	100	51280.120.025			
M6X45*	200	51280.060.045	M12X30	10	51280.120.030	M20X35*	50	51280.200.035
M6X50*	200	51280.060.050	M12X35	10	51280.120.035	M20X40	5	51280.200.040
M6X55*	200	51280.060.055	M12X40	10	51280.120.040	M20X45	5	51280.200.045
			M12X45	10	51280.120.045	M20X50	5	51280.200.050
M8X16*	200	51280.080.016	M12X50	10	51280.120.050	M20X55	5	51280.200.055
M8X20	50	51280.080.020	M12X55	10	51280.120.055	M20X60	5	51280.200.060
M8X25	50	51280.080.025	M12X60	10	51280.120.060	M20X65*	50	51280.200.065
M8X30	50	51280.080.030	M12X65*	100	51280.120.065	M20X70	5	51280.200.070
M8X35	50	51280.080.035	M12X70	10	51280.120.070	M20X75	5	51280.200.075
M8X40	50	51280.080.040	M12X75*	100	51280.120.075	M20X80	5	51280.200.080
M8X45*	200	51280.080.045	M12X80	10	51280.120.080	M20X85*	50	51280.200.085
M8X50	50	51280.080.050	M12X90*	100	51280.120.090	M20X90*	50	51280.200.090
M8X55*	200	51280.080.055	M12X100*	100	51280.120.100	M20X100*	50	51280.200.100
M8X60	50	51280.080.060	M12X110*	100	51280.120.110			
M8X70	50	51280.080.070				M24X50*	50	51280.240.050
			M14X30*	50	51280.140.030	M24X60*	50	51280.240.060
M10X16*	100	51280.100.016	M14X40*	50	51280.140.040	M24X65*	50	51280.240.065
M10X20	25	51280.100.020	M14X50*	50	51280.140.050	M24X70*	50	51280.240.070
M10X25	25	51280.100.025				M24X75*	50	51280.240.075
M10X30	25	51280.100.030	M16X30*	50	51280.160.030	M24X80*	50	51280.240.080
M10X35	25	51280.100.035	M16X35	10	51280.160.035			
M10X40	25	51280.100.040	M16X40	10	51280.160.040	M27X85*	25	51280.270.085
M10X45*	100	51280.100.045	M16X45	10	51280.160.045			
M10X50	25	51280.100.050	M16X50	10	51280.160.050	M30X80*	25	51280.300.080
M10X55	25	51280.100.055	M16X55	10	51280.160.055	M30X90*	25	51280.300.090
M10X60	25	51280.100.060	M16X60	10	51280.160.060			

• Sizes with a diameter > M24 and sizes with a length > 8xd are minimal property class 50.

55280 Stud metal end ≈ 1d								R49A
Thread	Metric thread							
Material	Stainless steel A4							
Class	70							
								

d x L	☒	Art.number	d x L	☒	Art.number	d x L	☒	Art.number
M5X20*	200	55280.050.020	M8X25*	200	55280.080.025	M10X50*	100	55280.100.050
			M8X30*	200	55280.080.030	M10X55*	100	55280.100.055
M6X16*	200	55280.060.016	M8X35*	200	55280.080.035	M10X60*	100	55280.100.060
M6X20*	200	55280.060.020	M8X40*	200	55280.080.040	M10X70*	100	55280.100.070
M6X25*	200	55280.060.025	M8X45*	200	55280.080.045	M10X85*	100	55280.100.085
M6X30*	200	55280.060.030	M8X50*	200	55280.080.050	M10X90*	100	55280.100.090
M6X35*	200	55280.060.035	M8X55*	200	55280.080.055			
M6X40*	200	55280.060.040	M8X60*	200	55280.080.060	M12X25*	100	55280.120.025
M6X50*	200	55280.060.050	M8X75*	200	55280.080.075	M12X30*	100	55280.120.030
M6X55*	200	55280.060.055	M8X90*	200	55280.080.090	M12X35*	100	55280.120.035
M6X60*	200	55280.060.060	M8X95*	200	55280.080.095	M12X40	100	55280.120.040
M6X65*	200	55280.060.065				M12X45*	100	55280.120.045
M6X70*	200	55280.060.070	M10X20*	100	55280.100.020	M12X50*	100	55280.120.050
M6X80*	200	55280.060.080	M10X25*	100	55280.100.025	M12X55*	100	55280.120.055
M6X90*	200	55280.060.090	M10X30*	100	55280.100.030	M12X60*	100	55280.120.060
			M10X35	100	55280.100.035	M12X65*	100	55280.120.065
M8X16*	200	55280.080.016	M10X40*	100	55280.100.040	M12X70*	100	55280.120.070
M8X20*	200	55280.080.020	M10X45*	100	55280.100.045	M12X75*	100	55280.120.075

55280 Stud metal end $\approx 1d$								
d x L	☒	Art.number	d x L	☒	Art.number	d x L	☒	Art.number
M12X80*	100	55280.120.080	M16X55*	50	55280.160.055	M20X40*	50	55280.200.040
M12X85*	100	55280.120.085	M16X60*	50	55280.160.060	M20X45*	50	55280.200.045
M12X90*	100	55280.120.090	M16X65*	50	55280.160.065	M20X50*	50	55280.200.050
M12X95*	100	55280.120.095	M16X70*	50	55280.160.070	M20X55*	50	55280.200.055
			M16X75*	50	55280.160.075	M20X60*	50	55280.200.060
M14X80*	50	55280.140.080	M16X80*	50	55280.160.080	M20X65*	50	55280.200.065
			M16X85*	50	55280.160.085	M20X70*	50	55280.200.070
M16X30	50	55280.160.030	M16X90*	50	55280.160.090	M20X75*	50	55280.200.075
M16X35*	50	55280.160.035	M16X100*	50	55280.160.100	M20X80*	50	55280.200.080
M16X40*	50	55280.160.040	M16X110*	50	55280.160.110	M20X90*	50	55280.200.090
M16X45*	50	55280.160.045				M20X100*	50	55280.200.100
M16X50*	50	55280.160.050	M20X35*	50	55280.200.035	M20X120*	50	55280.200.120

• Sizes with a diameter > M24 and sizes with a length > 8xd are minimal property class 5.0.

Stud metal end $\approx 1,25d$

4

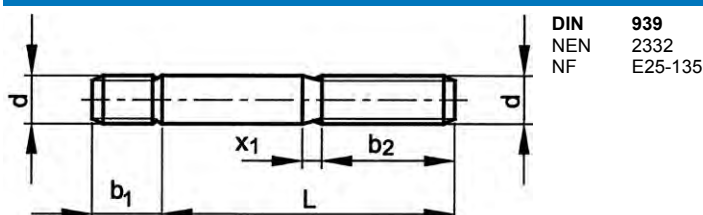

Technical Data

d	$b_1 \approx 1,25d$	$b_2: L \leq 125\text{mm}$	$b_2: 125\text{mm} < L \leq 200\text{mm}$	$b_2 = L - (x_1 + 3) \text{ t/m } L \leq$	P	x_1
M6	7.5	18	24	20	1	2.5
M8	10	22	28	25	1.25	3.2
M10	12	26	32	30	1.5	3.8
M12	15	30	36	35	1.75	4.3
M14	18	34	40	40	2	5.0
M16	20	38	44	45	2	5.0
M18	22	42	48	50	2.5	6.3
M20	25	46	52	55	2.5	6.3
M22	28	50	56	60	2.5	6.3
M24	30	54	60	65	3	7.5
M27	35	60	66	70	3	7.5

- ATTENTION: when ordering studs acc. to DIN the diameter d x the effective length L has to be stated e.g. stud M10 x 65 - DIN 939, where L = 65 mm is the working length and $b_1 = 12$ mm the metal end. The total length is $65 + 12 = 77$ mm. The threadlength on the outside $b_2 = 26$ mm.
- The screw-in threaded end has been made with tolerance Sk6, acc. to DIN 13-51, meaning "heavy fit", and prevents loosening of studs during disassembly.
- Studs acc. to DIN 939 (5.6/5.8/8.8) with a metal end $\approx 1,25d$ have many applications, among others in cast-iron.



Article groups

Thread	Material	Class	Surface treatment	Code	Page
M	St	5.6/5.8		21500	4-29
M	St	5.6/5.8	Zipl	21510	4-30
M	St	5.6/5.8	Zipl yell.p.	21515	4-30
M	St	8.8		21520	4-31
M	St.St. A2	70		51270	4-31
M	St.St. A4	70		55270	4-32

21500 Stud metal end $\approx 1,25d$		G07A
Thread	Metric thread	
Material	Steel	
Class	5.6/5.8	

d x L	☒	Art.number	d x L	☒	Art.number	d x L	☒	Art.number
M6X20	200	21500.060.020	M6X55	200	21500.060.055	M8X45	100	21500.080.045
M6X25	200	21500.060.025				M8X50	100	21500.080.050
M6X30	200	21500.060.030	M8X20	100	21500.080.020	M8X60	100	21500.080.060
M6X35	200	21500.060.035	M8X25	100	21500.080.025	M8X65	100	21500.080.065
M6X40	200	21500.060.040	M8X30	100	21500.080.030	M8X70	100	21500.080.070
M6X45	200	21500.060.045	M8X35	100	21500.080.035			
M6X50	200	21500.060.050	M8X40	100	21500.080.040	M10X20	100	21500.100.020

21500		Stud metal end ≈ 1,25d						←
d x L	☒	Art.number	d x L	☒	Art.number	d x L	☒	Art.number
M10X25	100	21500.100.025	M14X40	50	21500.140.040	M20X80	25	21500.200.080
M10X30	100	21500.100.030	M14X50	50	21500.140.050	M20X90	10	21500.200.090
M10X35	100	21500.100.035	M14X60	50	21500.140.060	M20X100	10	21500.200.100
M10X40	100	21500.100.040				M20X110	10	21500.200.110
M10X45	100	21500.100.045	M16X30	50	21500.160.030	M20X120	10	21500.200.120
M10X50	100	21500.100.050	M16X35	50	21500.160.035	M20X140	10	21500.200.140
M10X55	100	21500.100.055	M16X40	50	21500.160.040			
M10X60	100	21500.100.060	M16X45	50	21500.160.045	M22X50	10	21500.220.050
M10X65	100	21500.100.065	M16X50	50	21500.160.050	M22X60	10	21500.220.060
M10X70	100	21500.100.070	M16X55	50	21500.160.055	M22X70	10	21500.220.070
			M16X60	50	21500.160.060	M22X80	10	21500.220.080
M12X25	100	21500.120.025	M16X65	25	21500.160.065	M22X90	10	21500.220.090
M12X30	100	21500.120.030	M16X70	25	21500.160.070	M22X100	10	21500.220.100
M12X35	100	21500.120.035	M16X75	25	21500.160.075	M22X110	10	21500.220.110
M12X40	100	21500.120.040	M16X80	25	21500.160.080	M22X120	10	21500.220.120
M12X45	100	21500.120.045	M16X90	25	21500.160.090	M22X140	10	21500.220.140
M12X50	50	21500.120.050	M16X100	25	21500.160.100			
M12X55	50	21500.120.055				M24X50	10	21500.240.050
M12X60	50	21500.120.060	M20X40	25	21500.200.040	M24X60	10	21500.240.060
M12X65	50	21500.120.065	M20X45	25	21500.200.045	M24X70	10	21500.240.070
M12X70	50	21500.120.070	M20X50	25	21500.200.050	M24X80	10	21500.240.080
M12X75	50	21500.120.075	M20X55	25	21500.200.055	M24X90	10	21500.240.090
M12X80	50	21500.120.080	M20X60	25	21500.200.060	M24X100	10	21500.240.100
M12X90	50	21500.120.090	M20X65	25	21500.200.065	M24X110	10	21500.240.110
M12X100	50	21500.120.100	M20X70	25	21500.200.070	M24X120	10	21500.240.120
			M20X75	25	21500.200.075	M24X140	10	21500.240.140

21510		Stud metal end ≈ 1,25d						G07A
Thread	Metric thread							
Material	Steel							
Class	5.6/5.8							
Surface treatment	Zinc plated							
								

d x L	☒	Art.number	d x L	☒	Art.number	d x L	☒	Art.number
M6X20	200	21510.060.020	M8X50	100	21510.080.050	M12X30	100	21510.120.030
M6X25	200	21510.060.025	M8X60	100	21510.080.060	M12X35	100	21510.120.035
M6X30	200	21510.060.030				M12X40	100	21510.120.040
M6X35	200	21510.060.035	M10X20	100	21510.100.020	M12X50	50	21510.120.050
M6X40	200	21510.060.040	M10X25	100	21510.100.025	M12X60	50	21510.120.060
M6X45	200	21510.060.045	M10X30	100	21510.100.030			
M6X50	200	21510.060.050	M10X35	100	21510.100.035	M16X35	50	21510.160.035
			M10X40	100	21510.100.040	M16X40	50	21510.160.040
M8X20	100	21510.080.020	M10X50	100	21510.100.050	M16X45	50	21510.160.045
M8X25	100	21510.080.025	M10X60	100	21510.100.060	M16X50	50	21510.160.050
M8X30	100	21510.080.030				M16X55	50	21510.160.055
M8X35	100	21510.080.035	M12X25	100	21510.120.025	M16X60	50	21510.160.060
M8X40	100	21510.080.040						

21515		Stud metal end ≈ 1,25d						G07A
Thread	Metric thread							
Material	Steel							
Class	5.6/5.8							
Surface treatment	Zinc plated yellow passivated							

d x L	☒	Art.number	d x L	☒	Art.number	d x L	☒	Art.number
M6X20	200	21515.060.020	M8X50	100	21515.080.050	M12X30	100	21515.120.030
M6X25	200	21515.060.025	M8X60	100	21515.080.060	M12X35	100	21515.120.035
M6X30	200	21515.060.030				M12X40	100	21515.120.040
M6X35	200	21515.060.035	M10X20	100	21515.100.020	M12X50	50	21515.120.050
M6X40	200	21515.060.040	M10X25	100	21515.100.025	M12X60	50	21515.120.060
M6X45	200	21515.060.045	M10X30	100	21515.100.030			
M6X50	200	21515.060.050	M10X35	100	21515.100.035	M16X35	50	21515.160.035
			M10X40	100	21515.100.040	M16X40	50	21515.160.040
M8X20	100	21515.080.020	M10X50	100	21515.100.050	M16X45	50	21515.160.045
M8X25	100	21515.080.025	M10X60	100	21515.100.060	M16X50	50	21515.160.050
M8X30	100	21515.080.030				M16X55	50	21515.160.055
M8X35	100	21515.080.035	M12X25	100	21515.120.025	M16X60	50	21515.160.060
M8X40	100	21515.080.040						

21520 Stud metal end ≈ 1,25d G07A

Thread Material Class: Metric thread Steel 8.8



d x L	☒	Art.number	d x L	☒	Art.number	d x L	☒	Art.number
M6X20	200	21520.060.020	M12X25	100	21520.120.025	M16X100	25	21520.160.100
M6X25	200	21520.060.025	M12X30	100	21520.120.030	M20X40	25	21520.200.040
M6X30	200	21520.060.030	M12X35	100	21520.120.035	M20X45	25	21520.200.045
M6X35	200	21520.060.035	M12X40	100	21520.120.040	M20X50	25	21520.200.050
M6X40	200	21520.060.040	M12X45	100	21520.120.045	M20X55	25	21520.200.055
M6X45	200	21520.060.045	M12X50	50	21520.120.050	M20X60	25	21520.200.060
M6X50	200	21520.060.050	M12X55	50	21520.120.055	M20X65	25	21520.200.065
M6X55	200	21520.060.055	M12X60	50	21520.120.060	M20X70	25	21520.200.070
M8X20	100	21520.080.020	M12X65	50	21520.120.065	M20X75	25	21520.200.075
M8X25	100	21520.080.025	M12X70	50	21520.120.070	M20X80	25	21520.200.080
M8X30	100	21520.080.030	M12X75	50	21520.120.075	M20X90	10	21520.200.090
M8X35	100	21520.080.035	M12X80	50	21520.120.080	M20X100	10	21520.200.100
M8X40	100	21520.080.040	M12X90	50	21520.120.090	M20X110	10	21520.200.110
M8X45	100	21520.080.045	M12X100	50	21520.120.100	M20X120	10	21520.200.120
M8X50	100	21520.080.050	M14X30	50	21520.140.030	M20X140	10	21520.200.140
M8X60	100	21520.080.060	M14X35	50	21520.140.035	M22X60	10	21520.220.060
M8X65	100	21520.080.065	M14X40	50	21520.140.040	M22X70	10	21520.220.070
M8X70	100	21520.080.070	M14X50	50	21520.140.050	M22X80	10	21520.220.080
M10X20	100	21520.100.020	M14X60	50	21520.140.060	M24X50	10	21520.240.050
M10X25	100	21520.100.025	M16X35	50	21520.160.035	M24X60	10	21520.240.060
M10X30	100	21520.100.030	M16X40	50	21520.160.040	M24X70	10	21520.240.070
M10X35	100	21520.100.035	M16X45	50	21520.160.045	M24X75	10	21520.240.075
M10X40	100	21520.100.040	M16X50	50	21520.160.050	M24X80	10	21520.240.080
M10X45	100	21520.100.045	M16X55	50	21520.160.055	M24X90	10	21520.240.090
M10X50	100	21520.100.050	M16X60	50	21520.160.060	M24X100	10	21520.240.100
M10X55	100	21520.100.055	M16X65	25	21520.160.065	M24X110	10	21520.240.110
M10X60	100	21520.100.060	M16X70	25	21520.160.070	M24X120	10	21520.240.120
M10X65	100	21520.100.065	M16X75	25	21520.160.075	M27X100	10	21520.270.100
M10X70	100	21520.100.070	M16X80	25	21520.160.080			
			M16X90	25	21520.160.090			

4

51270 Stud metal end ≈ 1,25d R09A

Thread Material Class: Metric thread Stainless steel A2 70





d x L	☒	Art.number	d x L	☒	Art.number	d x L	☒	Art.number
M6X16*	200	51270.060.016	M10X20	25	51270.100.020	M12X80	10	51270.120.080
M6X20	100	51270.060.020	M10X22*	100	51270.100.022	M12X90	10	51270.120.090
M6X25	100	51270.060.025	M10X25	25	51270.100.025	M12X100	10	51270.120.100
M6X30	100	51270.060.030	M10X30	25	51270.100.030	M12X110*	100	51270.120.110
M6X35	100	51270.060.035	M10X35	25	51270.100.035	M12X120*	100	51270.120.120
M6X40	100	51270.060.040	M10X40	25	51270.100.040	M14X40*	50	51270.140.040
M6X45	100	51270.060.045	M10X45	25	51270.100.045	M14X70*	50	51270.140.070
M6X50	100	51270.060.050	M10X50	25	51270.100.050	M16X25*	50	51270.160.025
M6X55*	200	51270.060.055	M10X55	25	51270.100.055	M16X30	10	51270.160.030
M6X60	100	51270.060.060	M10X60	25	51270.100.060	M16X35	10	51270.160.035
M6X70	100	51270.060.070	M10X65	25	51270.100.065	M16X40	10	51270.160.040
M6X80	100	51270.060.080	M10X70	25	51270.100.070	M16X45	10	51270.160.045
M6X90	100	51270.060.090	M10X75	25	51270.100.075	M16X50	10	51270.160.050
M6X100	100	51270.060.100	M10X80	25	51270.100.080	M16X55	10	51270.160.055
M8X16	200	51270.080.016	M10X90	10	51270.100.090	M16X60	10	51270.160.060
M8X20	50	51270.080.020	M10X100	10	51270.100.100	M16X65	10	51270.160.065
M8X25	50	51270.080.025	M10X120*	100	51270.100.120	M16X70	10	51270.160.070
M8X30	50	51270.080.030	M12X20	10	51270.120.020	M16X75	10	51270.160.075
M8X35	50	51270.080.035	M12X25	10	51270.120.025	M16X80	10	51270.160.080
M8X40	50	51270.080.040	M12X30	10	51270.120.030	M16X90	10	51270.160.090
M8X45	50	51270.080.045	M12X35	10	51270.120.035	M16X100	10	51270.160.100
M8X50	50	51270.080.050	M12X40	10	51270.120.040	M16X110*	50	51270.160.110
M8X55*	200	51270.080.055	M12X45	10	51270.120.045	M20X35*	50	51270.200.035
M8X60	50	51270.080.060	M12X50	10	51270.120.050	M20X40	5	51270.200.040
M8X70	50	51270.080.070	M12X55	10	51270.120.055	M20X45	5	51270.200.045
M8X75*	200	51270.080.075	M12X60	10	51270.120.060	M20X50	5	51270.200.050
M8X80	50	51270.080.080	M12X65	10	51270.120.065	M20X55	5	51270.200.055
M8X90	25	51270.080.090	M12X70	10	51270.120.070	M20X60	5	51270.200.060
M8X100	25	51270.080.100	M12X75	10	51270.120.075			
M8X110*	200	51270.080.110						

51270 Stud metal end ≈ 1,25d								
d x L	☒	Art.number	d x L	☒	Art.number	d x L	☒	Art.number
M20X65	5	51270.200.065	M20X100	5	51270.200.100	M24X80*	50	51270.240.080
M20X70	5	51270.200.070	M20X110*	50	51270.200.110	M24X90	50	51270.240.090
M20X75	5	51270.200.075	M20X120	5	51270.200.120	M24X100*	50	51270.240.100
M20X80	5	51270.200.080						
M20X85*	50	51270.200.085	M24X65*	50	51270.240.065	M27X75*	25	51270.270.075
M20X90	5	51270.200.090	M24X70*	50	51270.240.070			

* Sizes with a diameter > M24 and sizes with a length > 8xd are minimal property class 50.

55270 Stud metal end ≈ 1,25d		R49A
Thread	Metric thread	
Material	Stainless steel A4	
Class	70	

d x L	☒	Art.number	d x L	☒	Art.number	d x L	☒	Art.number
M6X16*	200	55270.060.016	M10X50	25	55270.100.050	M16X55	10	55270.160.055
M6X20	100	55270.060.020	M10X55	25	55270.100.055	M16X60	10	55270.160.060
M6X25	100	55270.060.025	M10X60	25	55270.100.060	M16X65	10	55270.160.065
M6X30	100	55270.060.030	M10X65	25	55270.100.065	M16X70	10	55270.160.070
M6X35	100	55270.060.035	M10X70	25	55270.100.070	M16X75	10	55270.160.075
M6X40	100	55270.060.040	M10X75*	100	55270.100.075	M16X80	10	55270.160.080
M6X45	100	55270.060.045	M10X80	25	55270.100.080	M16X90*	50	55270.160.090
M6X50	100	55270.060.050	M10X90	10	55270.100.090	M16X100	10	55270.160.100
M6X60	100	55270.060.060	M10X100	10	55270.100.100	M16X120*	50	55270.160.120
M6X65*	200	55270.060.065						
M6X70	100	55270.060.070	M12X20	10	55270.120.020	M18X45*	50	55270.180.045
M6X80	100	55270.060.080	M12X25	10	55270.120.025			
M6X100	100	55270.060.100	M12X30	10	55270.120.030	M20X40	5	55270.200.040
			M12X35	10	55270.120.035	M20X45	5	55270.200.045
M8X16*	200	55270.080.016	M12X40	10	55270.120.040	M20X50	5	55270.200.050
M8X20	50	55270.080.020	M12X45	10	55270.120.045	M20X55	5	55270.200.055
M8X25	50	55270.080.025	M12X50	10	55270.120.050	M20X60	5	55270.200.060
M8X30	50	55270.080.030	M12X55	10	55270.120.055	M20X65	5	55270.200.065
M8X35	50	55270.080.035	M12X60*	100	55270.120.060	M20X70	5	55270.200.070
M8X40	50	55270.080.040	M12X65	10	55270.120.065	M20X75	5	55270.200.075
M8X45	50	55270.080.045	M12X70	10	55270.120.070	M20X80	5	55270.200.080
M8X50	50	55270.080.050	M12X75	10	55270.120.075	M20X85*	50	55270.200.085
M8X55*	200	55270.080.055	M12X80*	100	55270.120.080	M20X90	5	55270.200.090
M8X60	50	55270.080.060	M12X90	10	55270.120.090	M20X100	5	55270.200.100
M8X65*	200	55270.080.065	M12X100	10	55270.120.100	M20X110*	50	55270.200.110
M8X70	50	55270.080.070	M12X110*	100	55270.120.110	M20X120	5	55270.200.120
M8X80	50	55270.080.080	M12X120*	100	55270.120.120			
M8X100	25	55270.080.100						
			M14X35*	50	55270.140.035	M24X50*	50	55270.240.050
M10X20	25	55270.100.020				M24X60	5	55270.240.060
M10X25	25	55270.100.025	M16X30	10	55270.160.030	M24X70	5	55270.240.070
M10X30	25	55270.100.030	M16X35	10	55270.160.035	M24X80	5	55270.240.080
M10X35	25	55270.100.035	M16X40	10	55270.160.040	M24X90	5	55270.240.090
M10X40	25	55270.100.040	M16X45	10	55270.160.045	M24X100	5	55270.240.100
M10X45	25	55270.100.045	M16X50	10	55270.160.050			

* Sizes with a diameter > M24 and sizes with a length > 8xd are minimal property class 50.

Stud metal end $\approx 1,25d$ BSW

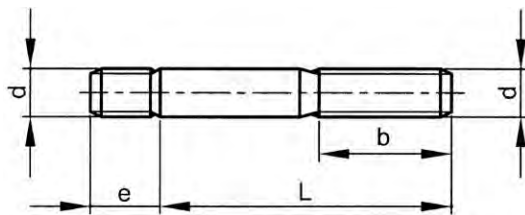

DIN ≈ 939 (1955)
NEN ≈ 2346 (1962)



Technical Data

d	b	$e \approx 1,25d$	Threads per inch	d	b	$e \approx 1,25d$	Threads per inch
5/16	18	10	18	5/8	28	20	11
3/8	20	12	16	3/4	32	25	10
1/2	25-30	16	12	1 Inch	40-55	35	8

- Whitworth thread (BSW) is not internationally recommended.
- It is advised to use metric (M).
- ATTENTION: when ordering studs according to DIN the diameter d x the effective length L has to be stated e.g. stud 5/16 x 25, where $L = 25$ mm is the working length and $e = 10$ mm the metal end.
- The total length is $25 + 10 = 35$ mm.
- The threadlength on the outside $b = 18$ mm.
- Studs acc. to \approx DIN 939 (1955) with a metal end $e \approx 1,25 d$ have many applications, among others in cast-iron.
- The screw-in threaded end has been made with tolerance Sk6, acc. to DIN 13 and 14, Beiblatt 14 (1944), meaning "heavy fit", and prevents loosening of studs during disassembly.

21540 Stud metal end $\approx 1,25d$ BSW		X08A
Thread	British Standard Whitworth	
Material	Steel	
Class	5.6/5.8	

d x L	☒	Art.number	d x L	☒	Art.number	d x L	☒	Art.number
5/16X25MM	100	21540.079.025	1/2X35MM	50	21540.127.035	5/8X70MM	25	21540.158.070
5/16X30MM	100	21540.079.030	1/2X40MM	50	21540.127.040	5/8X80MM	25	21540.158.080
5/16X35MM	100	21540.079.035	1/2X45MM	50	21540.127.045			
			1/2X50MM	50	21540.127.050	3/4X50MM	25	21540.191.050
3/8X25MM	100	21540.096.025	1/2X60MM	50	21540.127.060	3/4X60MM	25	21540.191.060
3/8X30MM	100	21540.096.030	1/2X70MM	50	21540.127.070	3/4X70MM	25	21540.191.070
3/8X35MM	100	21540.096.035	1/2X80MM	50	21540.127.080	3/4X80MM	10	21540.191.080
3/8X40MM	100	21540.096.040				1.IN.X50MM	10	21540.254.050
3/8X50MM	100	21540.096.050	5/8X45MM	25	21540.158.045	1.IN.X60MM	10	21540.254.060
			5/8X50MM	25	21540.158.050	1.IN.X100MM	10	21540.254.100
1/2X30MM	50	21540.127.030	5/8X60MM	25	21540.158.060			

- Depending on availability class 5.8 can be supplied.

Stud metal end $\approx 2d$

DIN 835

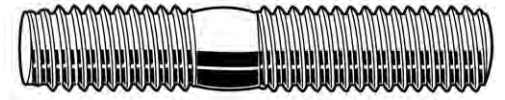
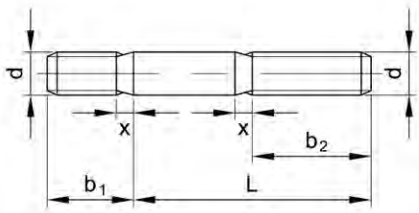

Technical Data

d	b ₁	b ₂ = L - (x + 3mm) t/m L ≤	b ₂ : 125mm < L ≤ 200mm	b ₂ : L ≤ 125mm	b ₂ : L ≥ 200mm	P	x
M6	12	20	24	18	-	1	2.5
M8	16	25	28	22	-	1.25	3.2
M10	20	28	32	26	45	1.5	3.8
M12	24	35	36	30	49	1.75	4.3
M16	32	45	44	38	57	2	5

Article groups

Thread	Material	Code	Page
M	St.St. A2	51285	4-34
M	St.St. A4	55285	4-34

51285 Stud metal end $\approx 2d$

R09A

Thread Metric thread
Material Stainless steel A2



d x L	☒	Art.number	d x L	☒	Art.number	d x L	☒	Art.number
M6X20*	200	51285.060.020	M8X50*	200	51285.080.050	M12X70*	100	51285.120.070
M6X50*	200	51285.060.050	M8X65*	200	51285.080.065	M12X80*	100	51285.120.080
M8X20*	200	51285.080.020	M8X90*	200	51285.080.090	M16X45*	50	51285.160.045
M8X25*	200	51285.080.025	M10X30*	100	51285.100.030	M16X60*	50	51285.160.060
M8X30*	200	51285.080.030	M10X35*	100	51285.100.035	M16X85*	50	51285.160.085
M8X35*	200	51285.080.035	M10X40*	100	51285.100.040			
M8X40*	200	51285.080.040	M10X45*	100	51285.100.045			
M8X45*	200	51285.080.045	M10X60*	100	51285.100.060			

55285 Stud metal end $\approx 2d$

R49A

Thread Metric thread
Material Stainless steel A4



d x L	☒	Art.number	d x L	☒	Art.number	d x L	☒	Art.number
M10X35*	100	55285.100.035				M12X40*	100	55285.120.040

FABORY, GLOBAL PARTNER FOR STUD BOLTS

Fabory delivers a broad and well-balanced studbolt assortment in almost any grade, any diameter, any length, any thread (imperial as well as metric)

4

- Materials may vary from standard (e.g. steel / stainless steel) to highly specialized (e.g. Hastelloy)
- Several surface treatments
- All required standards and certificates
- Fully equipped in-house machinery for tailor made studbolts solutions
- 24/7 available Emergency manufacturing
- Fully certified, fully traceable

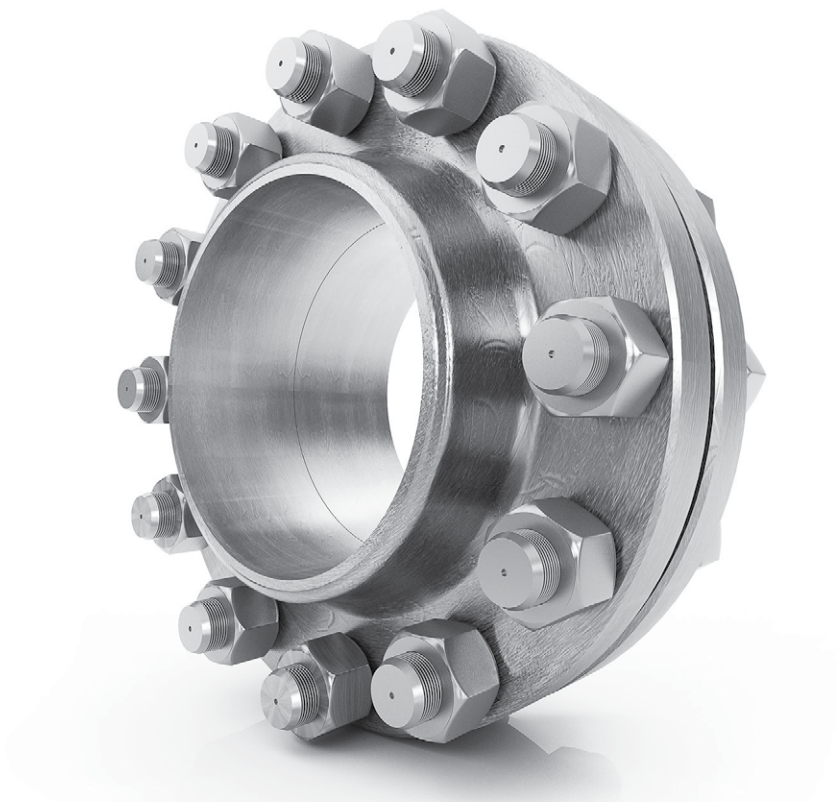

Please check our website, www.fabory.com, for the most up-to-date stud bolt assortment

Studbolts - threaded rods - heavy hexagon nuts for the petrochemical- and off shore industry

Grades

For studbolts and threaded rods Grade B7 acc. to ASTM A193 is the most popular Grade. Also ferritic steel Grade B16 acc. to ASTM A193 (for higher temperatures), Grade L7 acc. to ASTM A320 (for lower temperatures) and austenitic stainless steel Grade B8, B8M and B8T acc. to ASTM A193 (applicable for a very wide temperature range), can be supplied. For the matching heavy hex. nuts is Grade 2H acc. to ASTM A194 the most popular Grade. Also ferritic steel Grade 4* and Grade 7 acc. to ASTM A194 and austenitic stainless steel Grade B8, B8M and B8T acc. to ASTM A194 can be supplied ex-stock.

Grade 4 is expected to be withdrawn in the near future.
Grade 7 is an acceptable substitute for Grade 4.

Mechanical properties

ASTM A193 Grade B8, B8M en B8T comply with Class 1. Class 2 can be supplied on request.
The mechanical properties mentioned below of ASTM A193 Grade B7 and B16 as well as ASTM A320 Grade L7, apply to diameters of 2 1/2 inch or 65 mm.

Temperature range

Recommended max. operating temperature acc. to BS 4882: Grade B7 and L7 = 400°C / Grade B16 = 525°C / Grade B8, B8M and B8T = 575°C.
The cold-resistant steel A320 Grade L7 complies with a min. impact value of 20J at -101°C (average min. 27J).

Certificates

Occasionally with the delivery of studbolts and heavy hex nuts a 3.1 certificate acc. to EN 10204 is required.

Specials

Studbolts and heavy hex nuts with a corrosion resistant surface treatment such as zinc plated, hot dip galvanised, Xylan 1070 (PTFE coating), zinc flake (e.g. Geomet 500) etc. can be supplied on request.
Even less usual materials such as Duplex ASTM A453 Grade 660, Monel etc. can be supplied on request.

Studbolts and threaded bolts

Most important chemical elements									Corresponding materials			
Standard	Grade	C	Mn	Cr	Ni	Mo	V	Ti	AISI	AFNOR	DIN	BS
Ferritic steel												
ASTM A193	B7	0,37-0,49	0,65-1,10	0,75-1,20	-	0,15-0,25	-	-	4140/4142/4145	42CD4	42CrMo4	1506-621 Gr A
ASTM A193	B16	0,36-0,47	0,45-0,70	0,80-1,15	-	0,50-0,65	0,25-0,35	-	-	40CDV4-06	24CrMoV55	1506-661
ASTM A320	L7	0,38-0,48	0,75-1,00	0,80-1,10	-	0,15-0,25	-	-	4142/4145	42CD4	42CrMo4	1506-621 Gr A
Austenitic stainless steel												
ASTM A193	B8	max. 0,08	max. 2,00	18,0-20,0	8,0-10,5	-	-	-	304	Z6CN18-09	X5CrNi18-09	1506-801 Gr B
ASTM A193	B8M	max. 0,08	max. 2,00	16,0-18,0	10,0-14,0	2,0-3,0	-	-	316	Z6CND17-11	X5CrNiMo18-10	1506-845
ASTM A193	B8T	max. 0,08	max. 2,00	17,0-19,0	9,0-12,0	-	-	min. 5 x C%	321	Z6CNT18-11	X10CrNiTi18-09	1506-821 Gr Ti
Mechanical properties												
Norm	Grade	Tensile strength N/mm2		0,2% yieldstrength N/mm2		Elongation min. %		Reduction of area min. %		Hardness HB		
Ferritic steel												
ASTM A193	B7	860		720		16		50		max. 321		
ASTM A193	B16	860		725		18		50		max. 321		
ASTM A320	L7	860		725		16		50		-		
Austenitic stainless steel												
ASTM A193	B8	515		205		30		50		max. 223		
ASTM A193	B8M	515		205		30		50		max. 223		
ASTM A193	B8T	515		205		30		50		max. 223		

Hexagon nuts

Most important elements									Corresponding materials			
Standard	Grade	C	Mn	Cr	Ni	Mo	Ti	Hardness HB	AISI	AFNOR	DIN	BS
Ferritic steel												
ASTM A194	2H 4	min. 0,40	max. 1,00	-	-	-	-	248-352	-	C45d	C45	1506-162
ASTM A194	7	0,40-0,50	0,70-0,90	-	-	0,20-0,30	-	248-352	-	-	24CrMo5	1506-240
ASTM A194		0,37-0,49	0,65-1,10	0,75-1,20	-	0,15-0,25	-	248-352	4140/4142/4145	42CD4	42CrMo4	1506-621 Gr A
Austenitic stainless steel												
ASTM A194	8	max. 0,08	max. 2,00	18,0-20,0	8,0-10,5	-	-	126-300	304	Z6CN18-09	X5CrNi18-09	1506-801 Gr B
ASTM A194	8M	max. 0,08	max. 2,00	16,0-18,0	10,0-14,0	2,0-3,0	-	max. 223	316	Z6CND17-11	X5CrNiMo18-10	1506-845
ASTM A194	8T	max. 0,08	max. 2,00	17,0-19,0	9,0-12,0	-	min.5xC%	126-300	321	Z6CNT18-11	X10CrNiTi18-09	1506-821 Gr Ti

Threaded rod ASTM

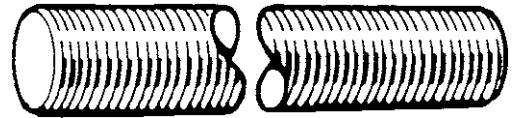
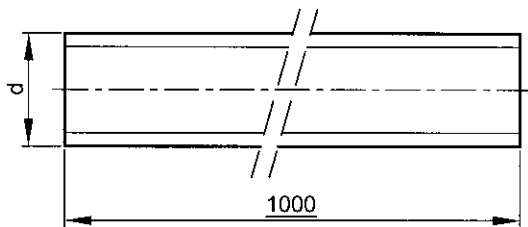

Technical Data



d	Threads per inch	d	Threads per inch
1/4	20	1.1/4	8
5/16	18	1.3/8	8
3/8	16	1.1/2	8
7/16	14	1.5/8	8
1/2	13	1.3/4	8
9/16	12	1.7/8	8
5/8	11	2 Inch	8
3/4	10	2.1/4	8
7/8	9	2.1/2	8
1 Inch	8	2.3/4	8
1.1/8	8		

Article groups

Thread	Material	Class		Code	Page
UNC	St ASTM A193	Gr.B7	1 meter	22180	4-37
8 UN	St ASTM A193	Gr.B7	1 meter	22190	4-37

22180 Threaded rod ASTM G09A

Thread Unified National Coarse
Material Steel ASTM A193
Class Gr.B7

d	☒	Art.number	d	☒	Art.number	d	☒	Art.number
1/4	1	22180.063.001	1/2	1	22180.127.001	7/8	1	22180.222.001
5/16	1	22180.079.001	5/8	1	22180.158.001	1 Inch	1	22180.254.001
3/8	1	22180.096.001	3/4	1	22180.191.001			

22190 Threaded rod ASTM G09A

Thread 8 Unified National
Material Steel ASTM A193
Class Gr.B7

d	☒	Art.number	d	☒	Art.number	d	☒	Art.number
1.1/8	1	22190.285.001	1.5/8	1	22190.412.001	2.1/4	1	22190.571.001
1.1/4	1	22190.317.001	1.3/4	1	22190.444.001	2.1/2	1	22190.635.001
1.3/8	1	22190.349.001	1.7/8	1	22190.476.001	2.3/4	1	22190.698.001
1.1/2	1	22190.381.001	2 Inch	1	22190.508.001			

Threaded rod ASTM metric

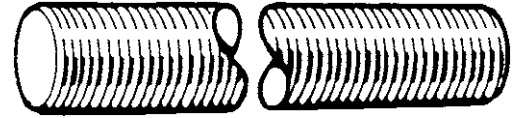
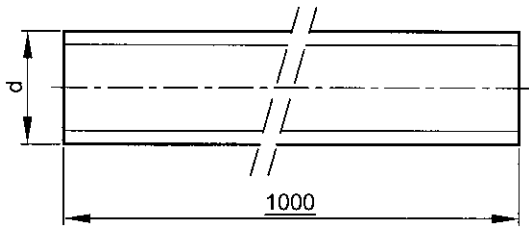

Technical Data

d	P	d	P
M10	1.5	M30	3.5
M12	1.75	M33	3.5
M14	2	M36	4
M16	2	M39	4
M18	2.5	M42	4.5
M20	2.5	M45	4.5
M22	2.5	M48	5
M24	3	M52	5
M27	3		

4

22100 Threaded rod ASTM metric G09A

Thread Metric thread
Material Steel ASTM A193
Class Gr.B7



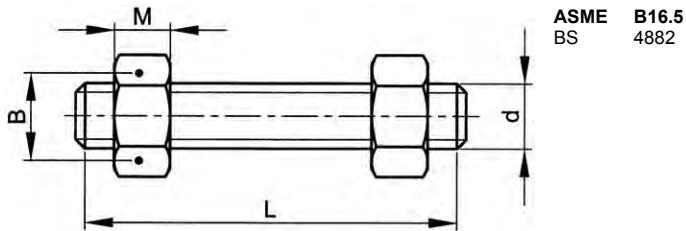

d	☒	Art.number	d	☒	Art.number	d	☒	Art.number
M10	1	22100.100.001	M22	1	22100.220.001	M39	1	22100.390.001
M12	1	22100.120.001	M24	1	22100.240.001	M42	1	22100.420.001
M14	1	22100.140.001	M27	1	22100.270.001	M45	1	22100.450.001
M16	1	22100.160.001	M30	1	22100.300.001	M48	1	22100.480.001
M18	1	22100.180.001	M33	1	22100.330.001	M52	1	22100.520.001
M20	1	22100.200.001	M36	1	22100.360.001			

Studbolt with 2 hexagon nuts

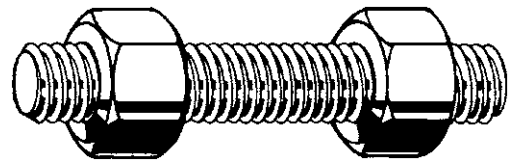

ASME B16.5
BS 4882



Technical Data

d	B	M	Threads per inch	d	B	M	Threads per inch
3/8	11/16	9	16	1.1/2	2.3/8	37.3	8
1/2	7/8	12.3	13	1.5/8	2.9/16	40.5	8
5/8	1.1/16	15.5	11	1.3/4	2.3/4	43.6	8
3/4	1.1/4	18.7	10	1.7/8	2.15/16	46.8	8
7/8	1.7/16	21.8	9	2 Inch	3.1/8	50.0	8
1 Inch	1.5/8	25.0	8	2.1/4	3.1/2	56.0	8
1.1/8	1.13/16	28.2	8	2.1/2	3.7/8	62.3	8
1.1/4	2.IN.	31.0	8	2.3/4	4.1/4	68.7	8
1.3/8	2.3/16	34.1	8	3 Inch	4.5/8	75.0	8

- Tolerances of the total length of the studbolts acc. to ASTM A 193 Par. 11.
- L is the nominal length of the studbolt of the first to the last full thread excluding the chamfered at each end.

Article groups

Thread	Driving features	Material	Class	Surface treatment	Code	Page
UNC	Hexagon	St ASTM A193 - ASTM A194	Gr.B7 - Gr.2H		22080	4-39
UNC	Hexagon	St ASTM A193 - ASTM A194	Gr.B7 - Gr.2H	Zipl	22082	4-41
8 UN	Hexagon	St ASTM A193 - ASTM A194	Gr.B7 - Gr.2H		22090	4-42
UNC	Hexagon	St ASTM A320 - ASTM A194	Gr.L7 - Gr.4		22320	4-45
8 UN	Hexagon	St ASTM A320 - ASTM A194	Gr.L7 - Gr.4		22330	4-47
UNC	Hexagon	St.St. ASTM A193 - ASTM A194	Gr.B8 Cl.1 - Gr.8		22534	4-50
UNC	Hexagon	St.St. ASTM A193 - ASTM A194	Gr.B8M Cl.2 - Gr.8M		22538	4-51
UNC	Hexagon	St ASTM A193 - ASTM A194	Gr.B16 - Gr.2H		22551	4-53
UNC	Hexagon	St ASTM A193 - ASTM A194	Gr.B16 - Gr.4		22554	4-53

22080 Studbolt with 2 hexagon nuts

G09A

Thread Unified National Coarse
Material Steel ASTM A193 - ASTM A194
Class Gr.B7 - Gr.2H

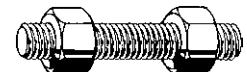

d x L mm (L Inch)	☒	Art.number	d x L mm (L Inch)	☒	Art.number	d x L mm (L Inch)	☒	Art.number
3/8X25 (1)	1	22080.096.025	1/2X140 (5.1/2)	1	22080.127.139	5/8X80 (3.1/4)	1	22080.158.082
3/8X40 (1.1/2)	1	22080.096.038	1/2X145 (5.3/4)	1	22080.127.146	5/8X85 (3.3/8)	1	22080.158.085
3/8X45 (1.3/4)	1	22080.096.044	1/2X150 (6)	1	22080.127.152	5/8X90 (3.1/2)	1	22080.158.088
3/8X60 (2.3/8)	1	22080.096.060	1/2X155 (6.1/8)	1	22080.127.155	5/8X95 (3.3/4)	1	22080.158.095
3/8X95 (3.3/4)	1	22080.096.095	1/2X160 (6.1/4)	1	22080.127.158	5/8X100 (4)	1	22080.158.101
3/8X175 (6.7/8)	1	22080.096.175	1/2X165 (6.1/2)	1	22080.127.165	5/8X105 (4.1/8)	1	22080.158.105
3/8X185 (7.1/4)	1	22080.096.184	1/2X170 (6.3/4)	1	22080.127.171	5/8X110 (4.1/4)	1	22080.158.107
			1/2X175 (6.7/8)	1	22080.127.175	5/8X115 (4.1/2)	1	22080.158.114
1/2X40 (1.1/2)	1	22080.127.038	1/2X180 (7)	1	22080.127.177	5/8X120 (4.3/4)	1	22080.158.120
1/2X45 (1.3/4)	1	22080.127.044	1/2X185 (7.1/4)	1	22080.127.184	5/8X125 (5)	1	22080.158.127
1/2X50 (2)	1	22080.127.050	1/2X190 (7.1/2)	1	22080.127.190	5/8X130 (5.1/8)	1	22080.158.130
1/2X55 (2.1/4)	1	22080.127.057	1/2X195 (7.3/4)	1	22080.127.196	5/8X135 (5.1/4)	1	22080.158.133
1/2X60 (2.3/8)	1	22080.127.060	1/2X200 (8)	1	22080.127.203	5/8X140 (5.1/2)	1	22080.158.139
1/2X65 (2.1/2)	1	22080.127.063	1/2X205 (8.1/8)	1	22080.127.205	5/8X145 (5.3/4)	1	22080.158.146
1/2X70 (2.3/4)	1	22080.127.069	1/2X210 (8.1/4)	1	22080.127.209	5/8X150 (6)	1	22080.158.152
1/2X75 (3)	1	22080.127.076	1/2X225 (8.7/8)	1	22080.127.225	5/8X155 (6.1/8)	1	22080.158.155
1/2X80 (3.1/4)	1	22080.127.082	1/2X250 (9.3/4)	1	22080.127.247	5/8X160 (6.1/4)	1	22080.158.158
1/2X85 (3.3/8)	1	22080.127.085	1/2X280 (11)	1	22080.127.279	5/8X165 (6.1/2)	1	22080.158.165
1/2X90 (3.1/2)	1	22080.127.088				5/8X170 (6.3/4)	1	22080.158.171
1/2X95 (3.3/4)	1	22080.127.095	5/8X40 (1.1/2)	1	22080.158.038	5/8X175 (6.7/8)	1	22080.158.175
1/2X100 (4)	1	22080.127.101	5/8X45 (1.3/4)	1	22080.158.044	5/8X180 (7)	1	22080.158.177
1/2X105 (4.1/8)	1	22080.127.105	5/8X50 (2)	1	22080.158.050	5/8X185 (7.1/4)	1	22080.158.184
1/2X110 (4.1/4)	1	22080.127.107	5/8X55 (2.1/4)	1	22080.158.057	5/8X190 (7.1/2)	1	22080.158.190
1/2X115 (4.1/2)	1	22080.127.114	5/8X60 (2.3/8)	1	22080.158.060	5/8X195 (7.3/4)	1	22080.158.196
1/2X120 (4.3/4)	1	22080.127.120	5/8X65 (2.1/2)	1	22080.158.063	5/8X200 (8)	1	22080.158.203
1/2X125 (5)	1	22080.127.127	5/8X70 (2.3/4)	1	22080.158.069	5/8X205 (8.1/8)	1	22080.158.205
1/2X130 (5.1/8)	1	22080.127.130	5/8X75 (3)	1	22080.158.076	5/8X210 (8.1/4)	1	22080.158.209
1/2X135 (5.1/4)	1	22080.127.133						

22080 Studbolt with 2 hexagon nuts								
d x L mm (L Inch)	☒	Art.number	d x L mm (L Inch)	☒	Art.number	d x L mm (L Inch)	☒	Art.number
1.IN.X320 (12.5/8)	1	22080.254.320	1.IN.X380 (15)	1	22080.254.381	1.IN.X445 (17.1/2)	1	22080.254.444
1.IN.X325 (12.3/4)	1	22080.254.323	1.IN.X385 (15.1/4)	1	22080.254.387	1.IN.X450 (17.3/4)	1	22080.254.450
1.IN.X330 (13)	1	22080.254.330	1.IN.X390 (15.3/8)	1	22080.254.390	1.IN.X455 (18)	1	22080.254.457
1.IN.X335 (13.1/4)	1	22080.254.337	1.IN.X395 (15.1/2)	1	22080.254.393	1.IN.X460 (18.1/8)	1	22080.254.460
1.IN.X340 (13.3/8)	1	22080.254.340	1.IN.X400 (15.3/4)	1	22080.254.400	1.IN.X470 (18.1/2)	1	22080.254.469
1.IN.X345 (13.1/2)	1	22080.254.342	1.IN.X410 (16.1/8)	1	22080.254.410	1.IN.X485 (19)	1	22080.254.482
1.IN.X350 (13.3/4)	1	22080.254.349	1.IN.X415 (16.1/4)	1	22080.254.412	1.IN.X505 (19.7/8)	1	22080.254.505
1.IN.X355 (14)	1	22080.254.355	1.IN.X420 (16.1/2)	1	22080.254.419	1.IN.X515 (20.1/4)	1	22080.254.514
1.IN.X360 (14.1/4)	1	22080.254.361	1.IN.X425 (16.3/4)	1	22080.254.425	1.IN.X520 (20.1/2)	1	22080.254.520
1.IN.X365 (14.3/8)	1	22080.254.365	1.IN.X430 (17)	1	22080.254.431	1.IN.X595 (23.1/2)	1	22080.254.596
1.IN.X370 (14.1/2)	1	22080.254.368	1.IN.X435 (17.1/8)	1	22080.254.435	1.IN.X730 (28.3/4)	1	22080.254.730
1.IN.X375 (14.3/4)	1	22080.254.374	1.IN.X440 (17.1/4)	1	22080.254.438			

22082 Studbolt with 2 hexagon nuts		G09A
Thread	Unified National Coarse	
Material	Steel ASTM A193 - ASTM A194	
Class	Gr.B7 - Gr.2H	
Surface treatment	Zinc plated	
		

4

d x L mm (L Inch)	☒	Art.number	d x L mm (L Inch)	☒	Art.number	d x L mm (L Inch)	☒	Art.number
3/8X25 (1)	1	22082.096.025	5/8X70 (2.3/4)	1	22082.158.069	3/4X50 (2)	1	22082.191.050
3/8X40 (1.1/2)	1	22082.096.038	5/8X75 (3)	1	22082.158.076	3/4X55 (2.1/4)	1	22082.191.057
3/8X45 (1.3/4)	1	22082.096.044	5/8X80 (3.1/4)	1	22082.158.082	3/4X60 (2.3/8)	1	22082.191.060
3/8X60 (2.3/8)	1	22082.096.060	5/8X85 (3.3/8)	1	22082.158.085	3/4X65 (2.1/2)	1	22082.191.063
3/8X65 (2.1/2)	1	22082.096.063	5/8X90 (3.1/2)	1	22082.158.088	3/4X70 (2.3/4)	1	22082.191.069
3/8X70 (2.3/4)	1	22082.096.069	5/8X95 (3.3/4)	1	22082.158.095	3/4X75 (3)	1	22082.191.076
3/8X80 (3.1/4)	1	22082.096.082	5/8X100 (4)	1	22082.158.101	3/4X80 (3.1/4)	1	22082.191.082
3/8X95 (3.3/4)	1	22082.096.095	5/8X105 (4.1/8)	1	22082.158.105	3/4X85 (3.3/8)	1	22082.191.085
3/8X100 (4)	1	22082.096.101	5/8X110 (4.1/4)	1	22082.158.107	3/4X90 (3.1/2)	1	22082.191.088
3/8X175 (6.7/8)	1	22082.096.175	5/8X115 (4.1/2)	1	22082.158.114	3/4X95 (3.3/4)	1	22082.191.095
3/8X185 (7.1/4)	1	22082.096.184	5/8X120 (4.3/4)	1	22082.158.120	3/4X100 (4)	1	22082.191.101
			5/8X125 (5)	1	22082.158.127	3/4X105 (4.1/8)	1	22082.191.105
1/2X30 (1.1/4)	1	22082.127.031	5/8X130 (5.1/8)	1	22082.158.130	3/4X110 (4.1/4)	1	22082.191.107
1/2X40 (1.1/2)	1	22082.127.038	5/8X135 (5.1/4)	1	22082.158.133	3/4X115 (4.1/2)	1	22082.191.114
1/2X45 (1.3/4)	1	22082.127.044	5/8X140 (5.1/2)	1	22082.158.139	3/4X120 (4.3/4)	1	22082.191.120
1/2X50 (2)	1	22082.127.050	5/8X145 (5.3/4)	1	22082.158.146	3/4X125 (5)	1	22082.191.127
1/2X55 (2.1/4)	1	22082.127.057	5/8X150 (6)	1	22082.158.152	3/4X130 (5.1/8)	1	22082.191.130
1/2X60 (2.3/8)	1	22082.127.060	5/8X155 (6.1/8)	1	22082.158.155	3/4X135 (5.1/4)	1	22082.191.133
1/2X65 (2.1/2)	1	22082.127.063	5/8X160 (6.1/4)	1	22082.158.158	3/4X140 (5.1/2)	1	22082.191.139
1/2X70 (2.3/4)	1	22082.127.069	5/8X165 (6.1/2)	1	22082.158.165	3/4X145 (5.3/4)	1	22082.191.146
1/2X75 (3)	1	22082.127.076	5/8X170 (6.3/4)	1	22082.158.171	3/4X150 (6)	1	22082.191.152
1/2X80 (3.1/4)	1	22082.127.082	5/8X175 (6.7/8)	1	22082.158.175	3/4X155 (6.1/8)	1	22082.191.155
1/2X85 (3.3/8)	1	22082.127.085	5/8X180 (7)	1	22082.158.177	3/4X160 (6.1/4)	1	22082.191.158
1/2X90 (3.1/2)	1	22082.127.088	5/8X185 (7.1/4)	1	22082.158.184	3/4X165 (6.1/2)	1	22082.191.165
1/2X95 (3.3/4)	1	22082.127.095	5/8X190 (7.1/2)	1	22082.158.190	3/4X170 (6.3/4)	1	22082.191.171
1/2X100 (4)	1	22082.127.101	5/8X195 (7.3/4)	1	22082.158.196	3/4X175 (6.7/8)	1	22082.191.175
1/2X105 (4.1/8)	1	22082.127.105	5/8X200 (8)	1	22082.158.203	3/4X180 (7)	1	22082.191.177
1/2X110 (4.1/4)	1	22082.127.107	5/8X205 (8.1/8)	1	22082.158.205	3/4X185 (7.1/4)	1	22082.191.184
1/2X115 (4.1/2)	1	22082.127.114	5/8X210 (8.1/4)	1	22082.158.209	3/4X190 (7.1/2)	1	22082.191.190
1/2X120 (4.3/4)	1	22082.127.120	5/8X215 (8.1/2)	1	22082.158.215	3/4X195 (7.3/4)	1	22082.191.196
1/2X125 (5)	1	22082.127.127	5/8X220 (8.3/4)	1	22082.158.222	3/4X200 (8)	1	22082.191.203
1/2X130 (5.1/8)	1	22082.127.130	5/8X225 (8.7/8)	1	22082.158.225	3/4X205 (8.1/8)	1	22082.191.205
1/2X135 (5.1/4)	1	22082.127.133	5/8X230 (9)	1	22082.158.228	3/4X210 (8.1/4)	1	22082.191.209
1/2X140 (5.1/2)	1	22082.127.139	5/8X235 (9.1/4)	1	22082.158.234	3/4X215 (8.1/2)	1	22082.191.215
1/2X145 (5.3/4)	1	22082.127.146	5/8X240 (9.1/2)	1	22082.158.241	3/4X220 (8.3/4)	1	22082.191.222
1/2X150 (6)	1	22082.127.152	5/8X245 (9.5/8)	1	22082.158.245	3/4X225 (8.7/8)	1	22082.191.225
1/2X155 (6.1/8)	1	22082.127.155	5/8X250 (9.3/4)	1	22082.158.247	3/4X230 (9)	1	22082.191.228
1/2X160 (6.1/4)	1	22082.127.158	5/8X255 (10)	1	22082.158.254	3/4X235 (9.1/4)	1	22082.191.234
1/2X165 (6.1/2)	1	22082.127.165	5/8X260 (10.1/4)	1	22082.158.260	3/4X240 (9.1/2)	1	22082.191.241
1/2X170 (6.3/4)	1	22082.127.171	5/8X265 (10.1/2)	1	22082.158.266	3/4X245 (9.5/8)	1	22082.191.245
1/2X175 (6.7/8)	1	22082.127.175	5/8X270 (10.5/8)	1	22082.158.270	3/4X250 (9.3/4)	1	22082.191.247
1/2X180 (7)	1	22082.127.177	5/8X275 (10.3/4)	1	22082.158.273	3/4X255 (10)	1	22082.191.254
1/2X185 (7.1/4)	1	22082.127.184	5/8X280 (11)	1	22082.158.279	3/4X260 (10.1/4)	1	22082.191.260
1/2X190 (7.1/2)	1	22082.127.190	5/8X285 (11.1/4)	1	22082.158.285	3/4X265 (10.1/2)	1	22082.191.266
1/2X195 (7.3/4)	1	22082.127.196	5/8X290 (11.3/8)	1	22082.158.290	3/4X270 (10.5/8)	1	22082.191.270
1/2X200 (8)	1	22082.127.203	5/8X295 (11.1/2)	1	22082.158.292	3/4X275 (10.3/4)	1	22082.191.273
1/2X205 (8.1/8)	1	22082.127.205	5/8X300 (11.3/4)	1	22082.158.298	3/4X280 (11)	1	22082.191.279
1/2X210 (8.1/4)	1	22082.127.209	5/8X305 (12)	1	22082.158.304	3/4X285 (11.1/4)	1	22082.191.285
1/2X225 (8.7/8)	1	22082.127.225	5/8X310 (12.1/4)	1	22082.158.311	3/4X290 (11.3/8)	1	22082.191.290
1/2X250 (9.3/4)	1	22082.127.247	5/8X315 (12.1/2)	1	22082.158.317	3/4X295 (11.1/2)	1	22082.191.292
1/2X280 (11)	1	22082.127.279	5/8X320 (12.5/8)	1	22082.158.320	3/4X300 (11.3/4)	1	22082.191.298
			5/8X325 (12.3/4)	1	22082.158.323	3/4X305 (12)	1	22082.191.304
5/8X40 (1.1/2)	1	22082.158.038	5/8X330 (13)	1	22082.158.330	3/4X310 (12.1/4)	1	22082.191.311
5/8X45 (1.3/4)	1	22082.158.044	5/8X335 (13.1/4)	1	22082.158.337	3/4X315 (12.1/2)	1	22082.191.317
5/8X50 (2)	1	22082.158.050	5/8X340 (13.3/8)	1	22082.158.340	3/4X320 (12.3/8)	1	22082.191.320
5/8X55 (2.1/4)	1	22082.158.057	5/8X370 (14.1/2)	1	22082.158.368	3/4X325 (12.3/4)	1	22082.191.323
5/8X60 (2.3/8)	1	22082.158.060	5/8X375 (14.3/4)	1	22082.158.374	3/4X330 (13)	1	22082.191.330
5/8X65 (2.1/2)	1	22082.158.063						

22082 Studbolt with 2 hexagon nuts ←

d x L mm (L Inch)	☒	Art.number	d x L mm (L Inch)	☒	Art.number	d x L mm (L Inch)	☒	Art.number
3/4X335 (13.1/4)	1	22082.191.337	7/8X255 (10)	1	22082.222.254	1.IN.X180 (7)	1	22082.254.177
3/4X340 (13.3/8)	1	22082.191.340	7/8X260 (10.1/4)	1	22082.222.260	1.IN.X185 (7.1/4)	1	22082.254.184
3/4X345 (13.1/2)	1	22082.191.342	7/8X265 (10.1/2)	1	22082.222.266	1.IN.X190 (7.1/2)	1	22082.254.190
3/4X350 (13.3/4)	1	22082.191.349	7/8X270 (10.5/8)	1	22082.222.270	1.IN.X195 (7.3/4)	1	22082.254.196
3/4X355 (14)	1	22082.191.355	7/8X275 (10.3/4)	1	22082.222.273	1.IN.X200 (8)	1	22082.254.203
3/4X360 (14.1/4)	1	22082.191.361	7/8X280 (11)	1	22082.222.279	1.IN.X205 (8.1/8)	1	22082.254.205
3/4X365 (14.3/8)	1	22082.191.365	7/8X285 (11.1/4)	1	22082.222.285	1.IN.X210 (8.1/4)	1	22082.254.209
3/4X370 (14.1/2)	1	22082.191.368	7/8X290 (11.3/8)	1	22082.222.290	1.IN.X215 (8.1/2)	1	22082.254.215
3/4X375 (14.3/4)	1	22082.191.374	7/8X295 (11.1/2)	1	22082.222.292	1.IN.X220 (8.3/4)	1	22082.254.222
3/4X380 (15)	1	22082.191.381	7/8X300 (11.3/4)	1	22082.222.298	1.IN.X225 (8.7/8)	1	22082.254.225
3/4X385 (15.1/4)	1	22082.191.387	7/8X305 (12)	1	22082.222.304	1.IN.X230 (9)	1	22082.254.228
3/4X390 (15.3/8)	1	22082.191.390	7/8X310 (12.1/4)	1	22082.222.311	1.IN.X235 (9.1/4)	1	22082.254.234
3/4X395 (15.1/2)	1	22082.191.393	7/8X315 (12.1/2)	1	22082.222.317	1.IN.X240 (9.1/2)	1	22082.254.241
3/4X400 (15.3/4)	1	22082.191.400	7/8X320 (12.5/8)	1	22082.222.320	1.IN.X245 (9.5/8)	1	22082.254.245
3/4X405 (16)	1	22082.191.406	7/8X325 (12.3/4)	1	22082.222.323	1.IN.X250 (9.3/4)	1	22082.254.247
3/4X410 (16.1/8)	1	22082.191.410	7/8X330 (13)	1	22082.222.330	1.IN.X255 (10)	1	22082.254.254
3/4X415 (16.1/4)	1	22082.191.412	7/8X335 (13.1/4)	1	22082.222.337	1.IN.X260 (10.1/4)	1	22082.254.260
3/4X420 (16.1/2)	1	22082.191.419	7/8X340 (13.3/8)	1	22082.222.340	1.IN.X265 (10.1/2)	1	22082.254.266
3/4X430 (17)	1	22082.191.431	7/8X345 (13.1/2)	1	22082.222.342	1.IN.X270 (10.5/8)	1	22082.254.270
3/4X440 (17.1/4)	1	22082.191.438	7/8X350 (13.3/4)	1	22082.222.349	1.IN.X275 (10.3/4)	1	22082.254.273
3/4X450 (17.3/4)	1	22082.191.450	7/8X355 (14)	1	22082.222.355	1.IN.X280 (11)	1	22082.254.279
3/4X455 (18)	1	22082.191.457	7/8X360 (14.1/4)	1	22082.222.361	1.IN.X285 (11.1/4)	1	22082.254.285
3/4X470 (18.1/2)	1	22082.191.469	7/8X365 (14.3/8)	1	22082.222.365	1.IN.X290 (11.3/8)	1	22082.254.290
3/4X480 (18.7/8)	1	22082.191.480	7/8X370 (14.1/2)	1	22082.222.368	1.IN.X295 (11.1/2)	1	22082.254.292
3/4X485 (19)	1	22082.191.482	7/8X375 (14.3/4)	1	22082.222.375	1.IN.X300 (11.3/4)	1	22082.254.298
3/4X580 (22.7/8)	1	22082.191.580	7/8X380 (15)	1	22082.222.381	1.IN.X305 (12)	1	22082.254.304
3/4X625 (24.5/8)	1	22082.191.625	7/8X385 (15.1/4)	1	22082.222.382	1.IN.X310 (12.1/4)	1	22082.254.311
7/8X70 (2.3/4)	1	22082.222.069	7/8X390 (15.3/8)	1	22082.222.390	1.IN.X315 (12.1/2)	1	22082.254.317
7/8X75 (3)	1	22082.222.076	7/8X395 (15.1/2)	1	22082.222.393	1.IN.X320 (12.5/8)	1	22082.254.320
7/8X80 (3.1/4)	1	22082.222.082	7/8X400 (15.3/4)	1	22082.222.400	1.IN.X325 (12.3/4)	1	22082.254.323
7/8X85 (3.3/8)	1	22082.222.085	7/8X405 (16)	1	22082.222.406	1.IN.X330 (13)	1	22082.254.330
7/8X90 (3.1/2)	1	22082.222.088	7/8X410 (16.1/8)	1	22082.222.410	1.IN.X335 (13.1/4)	1	22082.254.337
7/8X95 (3.3/4)	1	22082.222.095	7/8X415 (16.1/4)	1	22082.222.412	1.IN.X340 (13.3/8)	1	22082.254.340
7/8X100 (4)	1	22082.222.101	7/8X420 (16.1/2)	1	22082.222.419	1.IN.X345 (13.1/2)	1	22082.254.342
7/8X105 (4.1/8)	1	22082.222.105	7/8X425 (16.3/4)	1	22082.222.425	1.IN.X350 (13.3/4)	1	22082.254.349
7/8X110 (4.1/4)	1	22082.222.107	7/8X430 (17)	1	22082.222.431	1.IN.X355 (14)	1	22082.254.355
7/8X115 (4.1/2)	1	22082.222.114	7/8X440 (17.1/4)	1	22082.222.438	1.IN.X360 (14.1/4)	1	22082.254.361
7/8X120 (4.3/4)	1	22082.222.120	7/8X450 (17.3/4)	1	22082.222.450	1.IN.X365 (14.3/8)	1	22082.254.365
7/8X125 (5)	1	22082.222.127	7/8X455 (18)	1	22082.222.457	1.IN.X370 (14.1/2)	1	22082.254.368
7/8X130 (5.1/8)	1	22082.222.130	7/8X470 (18.1/2)	1	22082.222.469	1.IN.X375 (14.3/4)	1	22082.254.374
7/8X135 (5.1/4)	1	22082.222.133	7/8X485 (19)	1	22082.222.482	1.IN.X380 (15)	1	22082.254.381
7/8X140 (5.1/2)	1	22082.222.139	7/8X495 (19.1/2)	1	22082.222.495	1.IN.X385 (15.1/4)	1	22082.254.387
7/8X145 (5.3/4)	1	22082.222.146	7/8X510 (20)	1	22082.222.508	1.IN.X390 (15.3/8)	1	22082.254.390
7/8X150 (6)	1	22082.222.152	7/8X515 (20.1/4)	1	22082.222.514	1.IN.X395 (15.1/2)	1	22082.254.393
7/8X155 (6.1/8)	1	22082.222.155	7/8X525 (20.3/4)	1	22082.222.527	1.IN.X400 (15.3/4)	1	22082.254.400
7/8X160 (6.1/4)	1	22082.222.158	1.IN.X80 (3.1/4)	1	22082.254.082	1.IN.X405 (16)	1	22082.254.406
7/8X165 (6.1/2)	1	22082.222.165	1.IN.X85 (3.3/8)	1	22082.254.085	1.IN.X410 (16.1/8)	1	22082.254.410
7/8X170 (6.3/4)	1	22082.222.171	1.IN.X90 (3.1/2)	1	22082.254.088	1.IN.X415 (16.1/4)	1	22082.254.412
7/8X175 (6.7/8)	1	22082.222.175	1.IN.X95 (3.3/4)	1	22082.254.095	1.IN.X420 (16.1/2)	1	22082.254.419
7/8X180 (7)	1	22082.222.177	1.IN.X100 (4)	1	22082.254.101	1.IN.X425 (16.3/4)	1	22082.254.425
7/8X185 (7.1/4)	1	22082.222.184	1.IN.X105 (4.1/8)	1	22082.254.105	1.IN.X430 (17)	1	22082.254.431
7/8X190 (7.1/2)	1	22082.222.190	1.IN.X110 (4.1/4)	1	22082.254.107	1.IN.X435 (17.1/8)	1	22082.254.435
7/8X195 (7.3/4)	1	22082.222.196	1.IN.X115 (4.1/2)	1	22082.254.114	1.IN.X440 (17.1/4)	1	22082.254.438
7/8X200 (8)	1	22082.222.203	1.IN.X120 (4.3/4)	1	22082.254.120	1.IN.X445 (17.1/2)	1	22082.254.444
7/8X205 (8.1/8)	1	22082.222.205	1.IN.X125 (5)	1	22082.254.127	1.IN.X450 (17.3/4)	1	22082.254.450
7/8X210 (8.1/4)	1	22082.222.209	1.IN.X130 (5.1/8)	1	22082.254.130	1.IN.X455 (18)	1	22082.254.457
7/8X215 (8.1/2)	1	22082.222.215	1.IN.X135 (5.1/4)	1	22082.254.133	1.IN.X460 (18.1/8)	1	22082.254.460
7/8X220 (8.3/4)	1	22082.222.222	1.IN.X140 (5.1/2)	1	22082.254.139	1.IN.X470 (18.1/2)	1	22082.254.469
7/8X225 (8.7/8)	1	22082.222.225	1.IN.X145 (5.3/4)	1	22082.254.146	1.IN.X485 (19)	1	22082.254.482
7/8X230 (9)	1	22082.222.228	1.IN.X150 (6)	1	22082.254.152	1.IN.X505 (19.7/8)	1	22082.254.505
7/8X235 (9.1/4)	1	22082.222.234	1.IN.X155 (6.1/8)	1	22082.254.155	1.IN.X515 (20.1/4)	1	22082.254.514
7/8X240 (9.1/2)	1	22082.222.241	1.IN.X160 (6.1/4)	1	22082.254.158	1.IN.X520 (20.1/2)	1	22082.254.520
7/8X245 (9.5/8)	1	22082.222.245	1.IN.X165 (6.1/2)	1	22082.254.165	1.IN.X595 (23.1/2)	1	22082.254.596
7/8X250 (9.3/4)	1	22082.222.247	1.IN.X175 (6.7/8)	1	22082.254.175	1.IN.X730 (28.3/4)	1	22082.254.730

22090 Studbolt with 2 hexagon nuts G09A

Thread 8 Unified National
Material Steel ASTM A193 - ASTM A194
Class Gr.B7 - Gr.2H

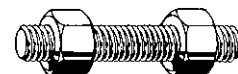



d x L mm (L Inch)	☒	Art.number	d x L mm (L Inch)	☒	Art.number	d x L mm (L Inch)	☒	Art.number
1.1/8X100 (4)	1	22090.285.101	1.1/8X125 (5)	1	22090.285.127	1.1/8X150 (6)	1	22090.285.152
1.1/8X105 (4.1/8)	1	22090.285.105	1.1/8X130 (5.1/8)	1	22090.285.130	1.1/8X155 (6.1/8)	1	22090.285.155
1.1/8X110 (4.1/4)	1	22090.285.107	1.1/8X135 (5.1/4)	1	22090.285.133	1.1/8X160 (6.1/4)	1	22090.285.158
1.1/8X115 (4.1/2)	1	22090.285.114	1.1/8X140 (5.1/2)	1	22090.285.139	1.1/8X165 (6.1/2)	1	22090.285.165
1.1/8X120 (4.3/4)	1	22090.285.120	1.1/8X145 (5.3/4)	1	22090.285.146	1.1/8X170 (6.3/4)	1	22090.285.171

22090 Studbolt with 2 hexagon nuts								
d x L mm (L Inch)	☒	Art.number	d x L mm (L Inch)	☒	Art.number	d x L mm (L Inch)	☒	Art.number
1.7/8X500 (19.3/4)	1	22090.476.501	2.IN.X475 (18.3/4)	1	22090.508.476	2.1/2X490 (19.1/4)	1	22090.635.488
1.7/8X510 (20)	1	22090.476.508	2.IN.X480 (18.7/8)	1	22090.508.480	2.1/2X495 (19.1/2)	1	22090.635.495
1.7/8X555 (21.7/8)	1	22090.476.555	2.IN.X485 (19)	1	22090.508.482	2.1/2X510 (20)	1	22090.635.508
1.7/8X560 (22)	1	22090.476.558	2.IN.X490 (19.1/4)	1	22090.508.488	2.1/2X520 (20.1/2)	1	22090.635.520
1.7/8X565 (22.1/4)	1	22090.476.565	2.IN.X495 (19.1/2)	1	22090.508.495	2.1/2X530 (20.7/8)	1	22090.635.530
1.7/8X600 (23.5/8)	1	22090.476.600	2.IN.X500 (19.3/4)	1	22090.508.501	2.1/2X535 (21)	1	22090.635.533
1.7/8X620 (24.1/2)	1	22090.476.622	2.IN.X510 (20)	1	22090.508.508	2.1/2X545 (21.1/2)	1	22090.635.546
1.7/8X675 (26.1/2)	1	22090.476.673	2.IN.X550 (21.3/4)	1	22090.508.552	2.1/2X560 (22)	1	22090.635.558
1.7/8X685 (27)	1	22090.476.685	2.IN.X565 (22.1/4)	1	22090.508.565	2.1/2X570 (22.1/2)	1	22090.635.571
			2.IN.X600 (23.5/8)	1	22090.508.600	2.1/2X585 (23)	1	22090.635.584
2.IN.X205 (8.1/8)	1	22090.508.205	2.IN.X650 (25.5/8)	1	22090.508.650	2.1/2X590 (23.1/4)	1	22090.635.590
2.IN.X255 (10)	1	22090.508.254	2.IN.X655 (25.3/4)	1	22090.508.654	2.1/2X600 (23.5/8)	1	22090.635.600
2.IN.X305 (12)	1	22090.508.304	2.IN.X660 (26)	1	22090.508.660	2.1/2X630 (24.3/4)	1	22090.635.628
2.IN.X310 (12.1/4)	1	22090.508.311	2.IN.X670 (26.3/8)	1	22090.508.670	2.1/2X650 (25.5/8)	1	22090.635.650
2.IN.X315 (12.1/2)	1	22090.508.317	2.IN.X680 (26.3/4)	1	22090.508.679	2.1/2X730 (28.3/4)	1	22090.635.730
2.IN.X320 (12.5/8)	1	22090.508.320	2.IN.X690 (27.1/4)	1	22090.508.692	2.1/2X780 (30.3/4)	1	22090.635.781
2.IN.X325 (12.3/4)	1	22090.508.323	2.IN.X700 (27.1/2)	1	22090.508.698	2.1/2X805 (31.3/4)	1	22090.635.806
2.IN.X330 (13)	1	22090.508.330	2.IN.X740 (29.1/4)	1	22090.508.742	2.1/2X845 (33.1/4)	1	22090.635.844
2.IN.X335 (13.1/4)	1	22090.508.337	2.IN.X750 (29.1/2)	1	22090.508.749	2.1/2X890 (35)	1	22090.635.889
2.IN.X340 (13.3/8)	1	22090.508.340	2.IN.X755 (29.3/4)	1	22090.508.755	2.1/2X950 (37.3/8)	1	22090.635.950
2.IN.X345 (13.1/2)	1	22090.508.342						
2.IN.X350 (13.3/4)	1	22090.508.349	2.1/4X280 (11)	1	22090.571.279	2.3/4X450 (17.3/4)	1	22090.698.450
2.IN.X355 (14)	1	22090.508.355	2.1/4X375 (14.3/4)	1	22090.571.374	2.3/4X500 (19.3/4)	1	22090.698.501
2.IN.X360 (14.1/4)	1	22090.508.361	2.1/4X390 (15.3/8)	1	22090.571.390	2.3/4X520 (20.1/2)	1	22090.698.520
2.IN.X365 (14.3/8)	1	22090.508.365	2.1/4X405 (16)	1	22090.571.406	2.3/4X535 (21)	1	22090.698.533
2.IN.X370 (14.1/2)	1	22090.508.368	2.1/4X425 (16.3/4)	1	22090.571.425	2.3/4X600 (23.5/8)	1	22090.698.600
2.IN.X375 (14.3/4)	1	22090.508.374	2.1/4X430 (17)	1	22090.571.431	2.3/4X630 (24.3/4)	1	22090.698.628
2.IN.X380 (15)	1	22090.508.381	2.1/4X470 (18.1/2)	1	22090.571.469	2.3/4X660 (26)	1	22090.698.660
2.IN.X385 (15.1/4)	1	22090.508.387	2.1/4X485 (19)	1	22090.571.482	2.3/4X690 (27.1/4)	1	22090.698.692
2.IN.X390 (15.3/8)	1	22090.508.390	2.1/4X510 (20)	1	22090.571.508	2.3/4X710 (28)	1	22090.698.711
2.IN.X395 (15.1/2)	1	22090.508.393	2.1/4X520 (20.1/2)	1	22090.571.520	2.3/4X720 (28.3/8)	1	22090.698.720
2.IN.X400 (15.3/4)	1	22090.508.400	2.1/4X550 (21.3/4)	1	22090.571.552	2.3/4X730 (28.3/4)	1	22090.698.730
2.IN.X405 (16)	1	22090.508.406	2.1/4X585 (23)	1	22090.571.584			
2.IN.X410 (16.1/8)	1	22090.508.410	2.1/4X590 (23.1/4)	1	22090.571.590	3.IN.X355 (14)	1	22090.762.355
2.IN.X415 (16.1/4)	1	22090.508.412	2.1/4X600 (23.5/8)	1	22090.571.600	3.IN.X475 (18.3/4)	1	22090.762.476
2.IN.X420 (16.1/2)	1	22090.508.419	2.1/4X695 (27.3/8)	1	22090.571.695	3.IN.X585 (23)	1	22090.762.584
2.IN.X425 (16.3/4)	1	22090.508.425	2.1/4X700 (27.1/2)	1	22090.571.698	3.IN.X590 (23.1/4)	1	22090.762.590
2.IN.X430 (17)	1	22090.508.431	2.1/4X870 (34.1/4)	1	22090.571.869	3.IN.X650 (25.5/8)	1	22090.762.650
2.IN.X435 (17.1/8)	1	22090.508.435				3.IN.X660 (26)	1	22090.762.660
2.IN.X440 (17.1/4)	1	22090.508.438	2.1/2X380 (15)	1	22090.635.381	3.IN.X700 (27.1/2)	1	22090.762.698
2.IN.X445 (17.1/2)	1	22090.508.444	2.1/2X405 (16)	1	22090.635.406	3.IN.X710 (28)	1	22090.762.711
2.IN.X450 (17.3/4)	1	22090.508.450	2.1/2X435 (17.1/8)	1	22090.635.435	3.IN.X735 (29)	1	22090.762.736
2.IN.X455 (18)	1	22090.508.457	2.1/2X440 (17.1/4)	1	22090.635.438	3.IN.X800 (31.1/2)	1	22090.762.800
2.IN.X460 (18.1/8)	1	22090.508.460	2.1/2X445 (17.1/2)	1	22090.635.444	3.IN.X850 (33.1/2)	1	22090.762.850
2.IN.X465 (18.1/4)	1	22090.508.463	2.1/2X470 (18.1/2)	1	22090.635.469			
2.IN.X470 (18.1/2)	1	22090.508.469	2.1/2X485 (19)	1	22090.635.482			

22320 Studbolt with 2 hexagon nuts								G10A
Thread	Unified National Coarse							
Material	Steel ASTM A320 - ASTM A194							
Class	Gr.L7 - Gr.4							

d x L mm (L Inch)	☒	Art.number	d x L mm (L Inch)	☒	Art.number	d x L mm (L Inch)	☒	Art.number
3/8X25 (1)	1	22320.096.025	1/2X100 (4)	1	22320.127.101	5/8X40 (1.1/2)	1	22320.158.038
3/8X40 (1.1/2)	1	22320.096.038	1/2X105 (4.1/8)	1	22320.127.105	5/8X45 (1.3/4)	1	22320.158.044
3/8X45 (1.3/4)	1	22320.096.044	1/2X110 (4.1/4)	1	22320.127.107	5/8X50 (2)	1	22320.158.050
3/8X60 (2.3/8)	1	22320.096.060	1/2X115 (4.1/2)	1	22320.127.114	5/8X55 (2.1/4)	1	22320.158.057
3/8X65 (2.1/2)	1	22320.096.063	1/2X120 (4.3/4)	1	22320.127.120	5/8X60 (2.3/8)	1	22320.158.060
3/8X70 (2.3/4)	1	22320.096.069	1/2X130 (5.1/8)	1	22320.127.130	5/8X65 (2.1/2)	1	22320.158.063
3/8X80 (3.1/4)	1	22320.096.082	1/2X135 (5.1/4)	1	22320.127.133	5/8X70 (2.3/4)	1	22320.158.069
3/8X95 (3.3/4)	1	22320.096.095	1/2X140 (5.1/2)	1	22320.127.139	5/8X75 (3)	1	22320.158.076
3/8X100 (4)	1	22320.096.101	1/2X150 (6)	1	22320.127.152	5/8X80 (3.1/4)	1	22320.158.082
3/8X175 (6.7/8)	1	22320.096.175	1/2X155 (6.1/8)	1	22320.127.155	5/8X85 (3.3/8)	1	22320.158.085
3/8X185 (7.1/4)	1	22320.096.184	1/2X165 (6.1/2)	1	22320.127.165	5/8X90 (3.1/2)	1	22320.158.088
			1/2X170 (6.3/4)	1	22320.127.171	5/8X95 (3.3/4)	1	22320.158.095
1/2X40 (1.1/2)	1	22320.127.038	1/2X175 (6.7/8)	1	22320.127.175	5/8X100 (4)	1	22320.158.101
1/2X45 (1.3/4)	1	22320.127.044	1/2X180 (7)	1	22320.127.177	5/8X105 (4.1/8)	1	22320.158.105
1/2X50 (2)	1	22320.127.050	1/2X190 (7.1/2)	1	22320.127.190	5/8X110 (4.1/4)	1	22320.158.107
1/2X55 (2.1/4)	1	22320.127.057	1/2X195 (7.3/4)	1	22320.127.196	5/8X115 (4.1/2)	1	22320.158.114
1/2X60 (2.3/8)	1	22320.127.060	1/2X200 (8)	1	22320.127.203	5/8X120 (4.3/4)	1	22320.158.120
1/2X65 (2.1/2)	1	22320.127.063	1/2X205 (8.1/8)	1	22320.127.205	5/8X125 (5)	1	22320.158.127
1/2X70 (2.3/4)	1	22320.127.069	1/2X210 (8.1/4)	1	22320.127.209	5/8X130 (5.1/8)	1	22320.158.130
1/2X75 (3)	1	22320.127.076	1/2X220 (8.3/4)	1	22320.127.222	5/8X135 (5.1/4)	1	22320.158.133
1/2X80 (3.1/4)	1	22320.127.082	1/2X225 (8.7/8)	1	22320.127.225	5/8X140 (5.1/2)	1	22320.158.139
1/2X85 (3.3/8)	1	22320.127.085	1/2X250 (9.3/4)	1	22320.127.247	5/8X145 (5.3/4)	1	22320.158.146
1/2X90 (3.1/2)	1	22320.127.088	1/2X280 (11)	1	22320.127.279	5/8X150 (6)	1	22320.158.152
1/2X95 (3.3/4)	1	22320.127.095	1/2X300 (11.3/4)	1	22320.127.298			

22320 Studbolt with 2 hexagon nuts								
d x L mm (L Inch)		Art.number	d x L mm (L Inch)		Art.number	d x L mm (L Inch)		Art.number
5/8X155 (6.1/8)	1	22320.158.155	3/4X245 (9.5/8)	1	22320.191.245	7/8X260 (10.1/4)	1	22320.222.260
5/8X160 (6.1/4)	1	22320.158.158	3/4X250 (9.3/4)	1	22320.191.247	7/8X265 (10.1/2)	1	22320.222.266
5/8X165 (6.1/2)	1	22320.158.165	3/4X255 (9.10)	1	22320.191.254	7/8X270 (10.5/8)	1	22320.222.270
5/8X170 (6.3/4)	1	22320.158.171	3/4X260 (10.1/4)	1	22320.191.260	7/8X275 (10.3/4)	1	22320.222.273
5/8X175 (6.7/8)	1	22320.158.175	3/4X265 (10.1/2)	1	22320.191.266	7/8X280 (11)	1	22320.222.279
5/8X180 (7)	1	22320.158.177	3/4X270 (10.5/8)	1	22320.191.270	7/8X285 (11.1/4)	1	22320.222.285
5/8X185 (7.1/4)	1	22320.158.184	3/4X275 (10.3/4)	1	22320.191.273	7/8X290 (11.3/8)	1	22320.222.290
5/8X190 (7.1/2)	1	22320.158.190	3/4X280 (11)	1	22320.191.279	7/8X295 (11.1/2)	1	22320.222.292
5/8X195 (7.3/4)	1	22320.158.196	3/4X285 (11.1/4)	1	22320.191.285	7/8X300 (11.3/4)	1	22320.222.298
5/8X200 (8)	1	22320.158.203	3/4X290 (11.3/8)	1	22320.191.290	7/8X305 (12)	1	22320.222.304
5/8X205 (8.1/8)	1	22320.158.205	3/4X295 (11.1/2)	1	22320.191.292	7/8X310 (12.1/4)	1	22320.222.311
5/8X210 (8.1/4)	1	22320.158.209	3/4X300 (11.3/4)	1	22320.191.298	7/8X315 (12.1/2)	1	22320.222.317
5/8X215 (8.1/2)	1	22320.158.215	3/4X305 (12)	1	22320.191.304	7/8X320 (12.5/8)	1	22320.222.320
5/8X220 (8.3/4)	1	22320.158.222	3/4X310 (12.1/4)	1	22320.191.311	7/8X325 (12.3/4)	1	22320.222.323
5/8X225 (8.7/8)	1	22320.158.225	3/4X315 (12.1/2)	1	22320.191.317	7/8X330 (13)	1	22320.222.330
5/8X230 (9)	1	22320.158.228	3/4X320 (12.3/8)	1	22320.191.320	7/8X335 (13.1/4)	1	22320.222.336
5/8X235 (9.1/2)	1	22320.158.241	3/4X325 (12.3/4)	1	22320.191.323	7/8X340 (13.3/8)	1	22320.222.340
5/8X245 (9.5/8)	1	22320.158.245	3/4X330 (13)	1	22320.191.330	7/8X345 (13.1/2)	1	22320.222.342
5/8X250 (9.3/4)	1	22320.158.247	3/4X335 (13.1/4)	1	22320.191.336	7/8X350 (13.3/4)	1	22320.222.349
5/8X255 (10)	1	22320.158.254	3/4X340 (13.3/8)	1	22320.191.340	7/8X355 (14)	1	22320.222.355
5/8X260 (10.1/4)	1	22320.158.260	3/4X345 (13.1/2)	1	22320.191.342	7/8X360 (14.1/4)	1	22320.222.361
5/8X265 (10.1/2)	1	22320.158.266	3/4X350 (13.3/4)	1	22320.191.349	7/8X365 (14.3/8)	1	22320.222.365
5/8X270 (10.5/8)	1	22320.158.270	3/4X355 (14)	1	22320.191.355	7/8X370 (14.1/2)	1	22320.222.368
5/8X275 (10.3/4)	1	22320.158.273	3/4X360 (14.1/4)	1	22320.191.361	7/8X375 (14.3/4)	1	22320.222.375
5/8X280 (11)	1	22320.158.279	3/4X365 (14.3/8)	1	22320.191.365	7/8X380 (15)	1	22320.222.381
5/8X285 (11.1/4)	1	22320.158.285	3/4X370 (14.1/2)	1	22320.191.368	7/8X385 (15.1/4)	1	22320.222.382
5/8X290 (11.3/8)	1	22320.158.290	3/4X375 (14.3/4)	1	22320.191.374	7/8X390 (15.3/8)	1	22320.222.390
5/8X295 (11.1/2)	1	22320.158.292	3/4X380 (15)	1	22320.191.381	7/8X395 (15.1/2)	1	22320.222.393
5/8X300 (11.3/4)	1	22320.158.298	3/4X385 (15.1/4)	1	22320.191.387	7/8X400 (15.3/4)	1	22320.222.400
5/8X305 (12)	1	22320.158.304	3/4X390 (15.3/8)	1	22320.191.390	7/8X405 (16)	1	22320.222.406
5/8X310 (12.1/4)	1	22320.158.311	3/4X395 (15.1/2)	1	22320.191.393	7/8X410 (16.1/8)	1	22320.222.410
5/8X315 (12.1/2)	1	22320.158.317	3/4X400 (15.3/4)	1	22320.191.400	7/8X415 (16.1/4)	1	22320.222.412
5/8X320 (12.5/8)	1	22320.158.320	3/4X405 (16)	1	22320.191.406	7/8X420 (16.1/2)	1	22320.222.419
5/8X325 (12.3/4)	1	22320.158.323	3/4X410 (16.1/8)	1	22320.191.410	7/8X425 (16.3/4)	1	22320.222.425
5/8X330 (13)	1	22320.158.330	3/4X415 (16.1/4)	1	22320.191.412	7/8X430 (17)	1	22320.222.431
5/8X335 (13.1/4)	1	22320.158.336	3/4X420 (16.1/2)	1	22320.191.419	7/8X440 (17.1/4)	1	22320.222.438
5/8X340 (13.3/8)	1	22320.158.340	3/4X430 (17)	1	22320.191.431	7/8X450 (17.3/4)	1	22320.222.450
5/8X345 (13.1/2)	1	22320.158.342	3/4X440 (17.1/4)	1	22320.191.438	7/8X455 (18)	1	22320.222.457
5/8X370 (14.1/2)	1	22320.158.368	3/4X450 (17.3/4)	1	22320.191.450	7/8X470 (18.1/2)	1	22320.222.469
5/8X375 (14.3/4)	1	22320.158.374	3/4X455 (18)	1	22320.191.457	7/8X485 (19)	1	22320.222.482
5/8X385 (15.1/4)	1	22320.158.387	3/4X470 (18.1/2)	1	22320.191.469	7/8X495 (19.1/2)	1	22320.222.495
5/8X420 (16.1/2)	1	22320.158.419	3/4X480 (18.7/8)	1	22320.191.480	7/8X510 (20)	1	22320.222.508
3/4X50 (2)	1	22320.191.050	3/4X485 (19)	1	22320.191.482	7/8X515 (20.1/4)	1	22320.222.514
3/4X55 (2.1/4)	1	22320.191.057	3/4X580 (22.7/8)	1	22320.191.580	7/8X525 (20.3/4)	1	22320.222.527
3/4X60 (2.3/8)	1	22320.191.060	3/4X625 (25.5/8)	1	22320.191.625			
3/4X65 (2.1/2)	1	22320.191.063	7/8X70 (2.3/4)	1	22320.222.069	1.IN.X85 (3.3/8)	1	22320.254.085
3/4X70 (2.3/4)	1	22320.191.069	7/8X75 (3)	1	22320.222.076	1.IN.X100 (4)	1	22320.254.101
3/4X75 (3)	1	22320.191.076	7/8X80 (3.1/4)	1	22320.222.082	1.IN.X105 (4.1/8)	1	22320.254.105
3/4X80 (3.1/4)	1	22320.191.082	7/8X90 (3.1/2)	1	22320.222.088	1.IN.X110 (4.1/4)	1	22320.254.107
3/4X85 (3.3/8)	1	22320.191.085	7/8X100 (4)	1	22320.222.101	1.IN.X115 (4.1/2)	1	22320.254.114
3/4X90 (3.1/2)	1	22320.191.088	7/8X105 (4.1/8)	1	22320.222.105	1.IN.X120 (4.3/4)	1	22320.254.120
3/4X95 (3.3/4)	1	22320.191.095	7/8X105 (4.1/4)	1	22320.222.107	1.IN.X125 (5)	1	22320.254.127
3/4X100 (4)	1	22320.191.101	7/8X115 (4.1/2)	1	22320.222.114	1.IN.X130 (5.1/8)	1	22320.254.130
3/4X105 (4.1/8)	1	22320.191.105	7/8X120 (4.3/4)	1	22320.222.120	1.IN.X135 (5.1/4)	1	22320.254.133
3/4X110 (4.1/4)	1	22320.191.107	7/8X125 (5)	1	22320.222.127	1.IN.X140 (5.1/2)	1	22320.254.139
3/4X115 (4.1/2)	1	22320.191.114	7/8X130 (5.1/8)	1	22320.222.130	1.IN.X145 (5.3/4)	1	22320.254.146
3/4X120 (4.3/4)	1	22320.191.120	7/8X135 (5.1/4)	1	22320.222.133	1.IN.X150 (6)	1	22320.254.152
3/4X125 (5)	1	22320.191.127	7/8X140 (5.1/2)	1	22320.222.139	1.IN.X155 (6.1/8)	1	22320.254.155
3/4X130 (5.1/8)	1	22320.191.130	7/8X145 (5.3/4)	1	22320.222.146	1.IN.X160 (6.1/4)	1	22320.254.158
3/4X135 (5.1/4)	1	22320.191.133	7/8X150 (6)	1	22320.222.152	1.IN.X165 (6.1/2)	1	22320.254.165
3/4X140 (5.1/2)	1	22320.191.139	7/8X155 (6.1/8)	1	22320.222.155	1.IN.X170 (6.3/4)	1	22320.254.171
3/4X145 (5.3/4)	1	22320.191.146	7/8X160 (6.1/4)	1	22320.222.158	1.IN.X175 (6.7/8)	1	22320.254.175
3/4X150 (6)	1	22320.191.152	7/8X165 (6.1/2)	1	22320.222.165	1.IN.X180 (7)	1	22320.254.177
3/4X155 (6.1/8)	1	22320.191.155	7/8X170 (6.3/4)	1	22320.222.171	1.IN.X185 (7.1/4)	1	22320.254.184
3/4X160 (6.1/4)	1	22320.191.158	7/8X175 (6.7/8)	1	22320.222.175	1.IN.X190 (7)	1	22320.254.190
3/4X165 (6.1/2)	1	22320.191.165	7/8X180 (7)	1	22320.222.177	1.IN.X195 (7.3/4)	1	22320.254.196
3/4X170 (6.3/4)	1	22320.191.171	7/8X185 (7.1/4)	1	22320.222.184	1.IN.X200 (8)	1	22320.254.203
3/4X175 (6.7/8)	1	22320.191.175	7/8X190 (7.1/2)	1	22320.222.190	1.IN.X205 (8.1/8)	1	22320.254.205
3/4X180 (7)	1	22320.191.177	7/8X195 (7.3/4)	1	22320.222.196	1.IN.X210 (8.1/4)	1	22320.254.209
3/4X185 (7.1/4)	1	22320.191.184	7/8X200 (8)	1	22320.222.203	1.IN.X215 (8.1/2)	1	22320.254.215
3/4X190 (7.1/2)	1	22320.191.190	7/8X205 (8.1/8)	1	22320.222.205	1.IN.X220 (8.3/4)	1	22320.254.222
3/4X195 (7.3/4)	1	22320.191.196	7/8X210 (8.1/4)	1	22320.222.209	1.IN.X225 (8.7/8)	1	22320.254.225
3/4X200 (8)	1	22320.191.203	7/8X215 (8.1/2)	1	22320.222.215	1.IN.X230 (9)	1	22320.254.228
3/4X205 (8.1/8)	1	22320.191.205	7/8X220 (8.3/4)	1	22320.222.222	1.IN.X235 (9.1/4)	1	22320.254.234
3/4X210 (8.1/4)	1	22320.191.209	7/8X225 (8.7/8)	1	22320.222.225	1.IN.X240 (9.1/2)	1	22320.254.241
3/4X215 (8.1/2)	1	22320.191.215	7/8X230 (9)	1	22320.222.228	1.IN.X245 (9.5/8)	1	22320.254.245
3/4X220 (8.3/4)	1	22320.191.222	7/8X235 (9.1/4)	1	22320.222.234	1.IN.X250 (9.3/4)	1	22320.254.247
3/4X225 (8.7/8)	1	22320.191.225	7/8X240 (9.1/2)	1	22320.222.241	1.IN.X255 (10)	1	22320.254.254
3/4X230 (9)	1	22320.191.228	7/8X245 (9.5/8)	1	22320.222.245	1.IN.X260 (10.1/4)	1	22320.254.260
3/4X235 (9.1/4)	1	22320.191.234	7/8X250 (9.3/4)	1	22320.222.247	1.IN.X265 (10.1/2)	1	22320.254.266
3/4X240 (9.1/2)	1	22320.191.241	7/8X255 (10)	1	22320.222.254	1.IN.X270 (10.5/8)	1	22320.254.270
						1.IN.X275 (10.3/4)	1	22320.254.273

22320 Studbolt with 2 hexagon nuts								
d x L mm (L Inch)	☒	Art.number	d x L mm (L Inch)	☒	Art.number	d x L mm (L Inch)	☒	Art.number
1.IN.X280 (11)	1	22320.254.279	1.IN.X355 (14)	1	22320.254.355	1.IN.X430 (17)	1	22320.254.431
1.IN.X285 (11.1/4)	1	22320.254.285	1.IN.X360 (14.1/4)	1	22320.254.361	1.IN.X435 (17.1/8)	1	22320.254.435
1.IN.X290 (11.3/8)	1	22320.254.290	1.IN.X365 (14.3/8)	1	22320.254.365	1.IN.X440 (17.1/4)	1	22320.254.438
1.IN.X295 (11.1/2)	1	22320.254.292	1.IN.X370 (14.1/2)	1	22320.254.368	1.IN.X445 (17.1/2)	1	22320.254.444
1.IN.X300 (11.3/4)	1	22320.254.298	1.IN.X375 (14.3/4)	1	22320.254.374	1.IN.X450 (17.3/4)	1	22320.254.450
1.IN.X305 (12)	1	22320.254.304	1.IN.X380 (15)	1	22320.254.381	1.IN.X455 (18)	1	22320.254.457
1.IN.X310 (12.1/4)	1	22320.254.311	1.IN.X385 (15.1/4)	1	22320.254.387	1.IN.X460 (18.1/8)	1	22320.254.460
1.IN.X315 (12.1/2)	1	22320.254.317	1.IN.X390 (15.3/8)	1	22320.254.390	1.IN.X470 (18.1/2)	1	22320.254.469
1.IN.X320 (12.5/8)	1	22320.254.320	1.IN.X395 (15.1/2)	1	22320.254.393	1.IN.X485 (19)	1	22320.254.482
1.IN.X325 (12.3/4)	1	22320.254.323	1.IN.X405 (16)	1	22320.254.406	1.IN.X505 (19.7/8)	1	22320.254.505
1.IN.X330 (13)	1	22320.254.330	1.IN.X410 (16.1/8)	1	22320.254.410	1.IN.X515 (20.1/4)	1	22320.254.514
1.IN.X335 (13.1/4)	1	22320.254.336	1.IN.X415 (16.1/4)	1	22320.254.412	1.IN.X520 (20.1/2)	1	22320.254.520
1.IN.X340 (13.3/8)	1	22320.254.340	1.IN.X420 (16.1/2)	1	22320.254.419	1.IN.X595 (23.1/2)	1	22320.254.596
1.IN.X345 (13.1/2)	1	22320.254.342	1.IN.X425 (16.3/4)	1	22320.254.425			

22330 Studbolt with 2 hexagon nuts		G10A
Thread	8 Unified National	
Material	Steel ASTM A320 - ASTM A194	
Class	Gr.L7 - Gr.4	
		
		

d x L mm (L Inch)	☒	Art.number	d x L mm (L Inch)	☒	Art.number	d x L mm (L Inch)	☒	Art.number
1.1/8X100 (4)	1	22330.285.101	1.1/8X435 (17.1/8)	1	22330.285.435	1.1/4X250 (9.3/4)	1	22330.317.247
1.1/8X105 (4.1/8)	1	22330.285.105	1.1/8X440 (17.1/4)	1	22330.285.438	1.1/4X255 (10)	1	22330.317.254
1.1/8X110 (4.1/4)	1	22330.285.107	1.1/8X445 (17.1/2)	1	22330.285.444	1.1/4X260 (10.1/4)	1	22330.317.260
1.1/8X115 (4.1/2)	1	22330.285.114	1.1/8X450 (17.3/4)	1	22330.285.450	1.1/4X270 (10.5/8)	1	22330.317.270
1.1/8X120 (4.3/4)	1	22330.285.120	1.1/8X455 (18)	1	22330.285.457	1.1/4X280 (11)	1	22330.317.279
1.1/8X125 (5)	1	22330.285.127	1.1/8X460 (18.1/8)	1	22330.285.460	1.1/4X285 (11.1/4)	1	22330.317.285
1.1/8X130 (5.1/8)	1	22330.285.130	1.1/8X465 (18.1/4)	1	22330.285.463	1.1/4X290 (11.3/8)	1	22330.317.290
1.1/8X135 (5.1/4)	1	22330.285.133	1.1/8X470 (18.1/2)	1	22330.285.469	1.1/4X295 (11.1/2)	1	22330.317.292
1.1/8X140 (5.1/2)	1	22330.285.139	1.1/8X475 (18.3/4)	1	22330.285.476	1.1/4X300 (11.3/4)	1	22330.317.298
1.1/8X145 (5.3/4)	1	22330.285.146	1.1/8X480 (18.7/8)	1	22330.285.480	1.1/4X310 (12.1/4)	1	22330.317.311
1.1/8X150 (6)	1	22330.285.152	1.1/8X485 (19)	1	22330.285.482	1.1/4X315 (12.1/2)	1	22330.317.317
1.1/8X155 (6.1/8)	1	22330.285.155	1.1/8X490 (19.1/4)	1	22330.285.488	1.1/4X325 (12.3/4)	1	22330.317.323
1.1/8X160 (6.1/4)	1	22330.285.158	1.1/8X495 (19.1/2)	1	22330.285.495	1.1/4X335 (13.1/4)	1	22330.317.336
1.1/8X165 (6.1/2)	1	22330.285.165	1.1/8X500 (19.3/4)	1	22330.285.501	1.1/4X335 (13.1/4)	1	22330.317.337
1.1/8X170 (6.3/4)	1	22330.285.171	1.1/8X505 (19.7/8)	1	22330.285.505	1.1/4X340 (13.3/8)	1	22330.317.340
1.1/8X175 (6.7/8)	1	22330.285.175	1.1/8X510 (20)	1	22330.285.508	1.1/4X345 (13.1/2)	1	22330.317.342
1.1/8X180 (7)	1	22330.285.177	1.1/8X515 (20.1/4)	1	22330.285.514	1.1/4X350 (13.3/4)	1	22330.317.349
1.1/8X185 (7.1/4)	1	22330.285.184	1.1/8X520 (20.1/2)	1	22330.285.520	1.1/4X355 (14)	1	22330.317.355
1.1/8X190 (7.1/2)	1	22330.285.190	1.1/8X525 (20.3/4)	1	22330.285.527	1.1/4X360 (14.1/4)	1	22330.317.361
1.1/8X195 (7.3/4)	1	22330.285.196	1.1/8X530 (20.7/8)	1	22330.285.530	1.1/4X365 (14.3/8)	1	22330.317.365
1.1/8X200 (8)	1	22330.285.203	1.1/8X540 (21.1/4)	1	22330.285.539	1.1/4X370 (14.1/2)	1	22330.317.368
1.1/8X205 (8.1/8)	1	22330.285.205	1.1/8X550 (21.3/4)	1	22330.285.550	1.1/4X375 (14.3/4)	1	22330.317.374
1.1/8X210 (8.1/4)	1	22330.285.209	1.1/8X560 (22)	1	22330.285.558	1.1/4X380 (15)	1	22330.317.381
1.1/8X215 (8.1/2)	1	22330.285.215	1.1/8X570 (22.1/2)	1	22330.285.571	1.1/4X385 (15.1/4)	1	22330.317.387
1.1/8X220 (8.3/4)	1	22330.285.222	1.1/8X585 (23)	1	22330.285.584	1.1/4X390 (15.3/8)	1	22330.317.390
1.1/8X230 (9)	1	22330.285.228	1.1/8X590 (23.1/4)	1	22330.285.590	1.1/4X395 (15.1/2)	1	22330.317.393
1.1/8X235 (9.1/4)	1	22330.285.234	1.1/8X610 (24)	1	22330.285.609	1.1/4X400 (15.3/4)	1	22330.317.400
1.1/8X240 (9.1/2)	1	22330.285.241	1.1/8X620 (24.1/2)	1	22330.285.622	1.1/4X405 (16)	1	22330.317.406
1.1/8X245 (9.5/8)	1	22330.285.245	1.1/8X800 (31.1/2)	1	22330.285.800	1.1/4X410 (16.1/8)	1	22330.317.410
1.1/8X250 (9.3/4)	1	22330.285.247				1.1/4X415 (16.1/4)	1	22330.317.412
1.1/8X285 (11.1/4)	1	22330.285.285	1.1/4X105 (4.1/8)	1	22330.317.105	1.1/4X420 (16.1/2)	1	22330.317.419
1.1/8X300 (11.3/4)	1	22330.285.298	1.1/4X125 (5)	1	22330.317.127	1.1/4X425 (16.3/4)	1	22330.317.425
1.1/8X305 (12)	1	22330.285.304	1.1/4X130 (5.1/8)	1	22330.317.130	1.1/4X430 (17)	1	22330.317.431
1.1/8X310 (12.1/4)	1	22330.285.311	1.1/4X135 (5.1/4)	1	22330.317.133	1.1/4X435 (17.1/8)	1	22330.317.435
1.1/8X320 (12.5/8)	1	22330.285.320	1.1/4X140 (5.1/2)	1	22330.317.139	1.1/4X440 (17.1/4)	1	22330.317.438
1.1/8X325 (12.3/4)	1	22330.285.323	1.1/4X145 (5.3/4)	1	22330.317.146	1.1/4X445 (17.1/2)	1	22330.317.444
1.1/8X330 (13)	1	22330.285.330	1.1/4X150 (6)	1	22330.317.152	1.1/4X450 (17.3/4)	1	22330.317.450
1.1/8X335 (13.1/4)	1	22330.285.336	1.1/4X155 (6.1/8)	1	22330.317.155	1.1/4X450 (18)	1	22330.317.457
1.1/8X340 (13.3/8)	1	22330.285.340	1.1/4X160 (6.1/4)	1	22330.317.158	1.1/4X460 (18.1/4)	1	22330.317.460
1.1/8X350 (13.3/4)	1	22330.285.349	1.1/4X165 (6.1/2)	1	22330.317.165	1.1/4X470 (18.1/4)	1	22330.317.463
1.1/8X355 (14)	1	22330.285.355	1.1/4X170 (6.3/4)	1	22330.317.171	1.1/4X470 (18.1/2)	1	22330.317.469
1.1/8X360 (14.1/4)	1	22330.285.361	1.1/4X175 (6.7/8)	1	22330.317.175	1.1/4X475 (18.3/4)	1	22330.317.476
1.1/8X365 (14.3/8)	1	22330.285.365	1.1/4X180 (7)	1	22330.317.177	1.1/4X480 (18.7/8)	1	22330.317.480
1.1/8X370 (14.1/2)	1	22330.285.368	1.1/4X185 (7.1/4)	1	22330.317.184	1.1/4X485 (19)	1	22330.317.482
1.1/8X375 (14.3/4)	1	22330.285.374	1.1/4X190 (7.1/2)	1	22330.317.190	1.1/4X490 (19.1/4)	1	22330.317.488
1.1/8X380 (15)	1	22330.285.381	1.1/4X195 (7.3/4)	1	22330.317.196	1.1/4X495 (19.1/2)	1	22330.317.495
1.1/8X385 (15.1/4)	1	22330.285.387	1.1/4X200 (8)	1	22330.317.203	1.1/4X500 (19.3/4)	1	22330.317.501
1.1/8X390 (15.3/8)	1	22330.285.390	1.1/4X205 (8.1/8)	1	22330.317.205	1.1/4X510 (20)	1	22330.317.508
1.1/8X395 (15.1/2)	1	22330.285.393	1.1/4X210 (8.1/4)	1	22330.317.209	1.1/4X520 (20.1/2)	1	22330.317.520
1.1/8X400 (15.3/4)	1	22330.285.400	1.1/4X215 (8.1/2)	1	22330.317.215	1.1/4X530 (20.7/8)	1	22330.317.530
1.1/8X405 (16)	1	22330.285.406	1.1/4X220 (8.3/4)	1	22330.317.222	1.1/4X540 (21.1/4)	1	22330.317.539
1.1/8X410 (16.1/8)	1	22330.285.410	1.1/4X225 (8.7/8)	1	22330.317.225	1.1/4X550 (21.3/4)	1	22330.317.550
1.1/8X415 (16.1/4)	1	22330.285.412	1.1/4X230 (9)	1	22330.317.228	1.1/4X560 (22)	1	22330.317.558
1.1/8X420 (16.1/2)	1	22330.285.419	1.1/4X235 (9.1/4)	1	22330.317.234	1.1/4X600 (23.5/8)	1	22330.317.600
1.1/8X425 (16.3/4)	1	22330.285.425	1.1/4X240 (9.1/2)	1	22330.317.241	1.1/4X610 (24)	1	22330.317.609
1.1/8X430 (17)	1	22330.285.431	1.1/4X245 (9.5/8)	1	22330.317.245	1.1/4X630 (24.3/4)	1	22330.317.628

22330 Studbolt with 2 hexagon nuts

d x L mm (L Inch)	☒	Art.number	d x L mm (L Inch)	☒	Art.number	d x L mm (L Inch)	☒	Art.number
1.3/4X385 (15.1/4)	1	22330.444.387	1.7/8X485 (19)	1	22330.476.482	2.IN.X755 (29.3/4)	1	22330.508.755
1.3/4X390 (15.3/8)	1	22330.444.390	1.7/8X490 (19.1/4)	1	22330.476.488			
1.3/4X395 (15.1/2)	1	22330.444.393	1.7/8X495 (19.1/2)	1	22330.476.495	2.1/4X280 (11)	1	22330.571.279
1.3/4X400 (15.3/4)	1	22330.444.400	1.7/8X500 (19.3/4)	1	22330.476.501	2.1/4X375 (14.3/4)	1	22330.571.374
1.3/4X405 (16)	1	22330.444.406	1.7/8X510 (20)	1	22330.476.508	2.1/4X390 (15.3/8)	1	22330.571.390
1.3/4X410 (16.1/8)	1	22330.444.410	1.7/8X555 (21.7/8)	1	22330.476.555	2.1/4X405 (16)	1	22330.571.406
1.3/4X415 (16.1/4)	1	22330.444.412	1.7/8X560 (22)	1	22330.476.558	2.1/4X425 (16.3/4)	1	22330.571.425
1.3/4X420 (16.1/2)	1	22330.444.419	1.7/8X565 (22.1/4)	1	22330.476.565	2.1/4X430 (17)	1	22330.571.431
1.3/4X425 (16.3/4)	1	22330.444.425	1.7/8X600 (23.5/8)	1	22330.476.600	2.1/4X470 (18.1/2)	1	22330.571.469
1.3/4X430 (17)	1	22330.444.431	1.7/8X620 (24.1/2)	1	22330.476.622	2.1/4X485 (19)	1	22330.571.482
1.3/4X435 (17.1/8)	1	22330.444.435	1.7/8X675 (26.1/2)	1	22330.476.673	2.1/4X510 (20)	1	22330.571.508
1.3/4X440 (17.1/4)	1	22330.444.438	1.7/8X685 (27)	1	22330.476.685	2.1/4X520 (20.1/2)	1	22330.571.520
1.3/4X445 (17.1/2)	1	22330.444.444				2.1/4X550 (21.3/4)	1	22330.571.552
1.3/4X450 (17.3/4)	1	22330.444.450	2.IN.X205 (8.1/8)	1	22330.508.205	2.1/4X585 (23)	1	22330.571.584
1.3/4X455 (18)	1	22330.444.457	2.IN.X255 (10)	1	22330.508.254	2.1/4X590 (23.1/4)	1	22330.571.590
1.3/4X460 (18.1/8)	1	22330.444.460	2.IN.X305 (12)	1	22330.508.304	2.1/4X600 (23.5/8)	1	22330.571.600
1.3/4X470 (18.1/2)	1	22330.444.469	2.IN.X310 (12.1/4)	1	22330.508.311	2.1/4X695 (27.3/8)	1	22330.571.695
1.3/4X480 (18.7/8)	1	22330.444.480	2.IN.X315 (12.1/2)	1	22330.508.317	2.1/4X700 (27.1/2)	1	22330.571.698
1.3/4X485 (19)	1	22330.444.482	2.IN.X320 (12.5/8)	1	22330.508.320	2.1/4X870 (34.1/4)	1	22330.571.869
1.3/4X490 (19.1/4)	1	22330.444.488	2.IN.X325 (12.3/4)	1	22330.508.323			
1.3/4X495 (19.1/2)	1	22330.444.495	2.IN.X330 (13)	1	22330.508.330	2.1/2X380 (15)	1	22330.635.381
1.3/4X500 (19.3/4)	1	22330.444.501	2.IN.X335 (13.1/4)	1	22330.508.336	2.1/2X405 (16)	1	22330.635.406
1.3/4X510 (20)	1	22330.444.508	2.IN.X340 (13.3/8)	1	22330.508.340	2.1/2X435 (17.1/8)	1	22330.635.435
1.3/4X520 (20.1/2)	1	22330.444.520	2.IN.X345 (13.1/2)	1	22330.508.342	2.1/2X440 (17.1/4)	1	22330.635.438
1.3/4X570 (22.1/2)	1	22330.444.571	2.IN.X350 (13.3/4)	1	22330.508.349	2.1/2X445 (17.1/2)	1	22330.635.444
1.3/4X580 (22.7/8)	1	22330.444.580	2.IN.X355 (14)	1	22330.508.355	2.1/2X470 (18.1/2)	1	22330.635.469
1.3/4X595 (23.1/2)	1	22330.444.596	2.IN.X360 (14.1/4)	1	22330.508.361	2.1/2X485 (19)	1	22330.635.482
1.3/4X600 (23.5/8)	1	22330.444.600	2.IN.X365 (14.3/8)	1	22330.508.365	2.1/2X490 (19.1/4)	1	22330.635.488
1.3/4X610 (24)	1	22330.444.609	2.IN.X370 (14.1/2)	1	22330.508.368	2.1/2X495 (19.1/2)	1	22330.635.495
1.3/4X625 (24.5/8)	1	22330.444.625	2.IN.X375 (14.3/4)	1	22330.508.374	2.1/2X510 (20)	1	22330.635.508
1.3/4X650 (25.5/8)	1	22330.444.650	2.IN.X380 (15)	1	22330.508.381	2.1/2X520 (20.1/2)	1	22330.635.520
1.3/4X685 (27)	1	22330.444.685	2.IN.X385 (15.1/4)	1	22330.508.387	2.1/2X530 (20.7/8)	1	22330.635.530
1.3/4X710 (28)	1	22330.444.711	2.IN.X390 (15.3/8)	1	22330.508.390	2.1/2X535 (21)	1	22330.635.533
			2.IN.X395 (15.1/2)	1	22330.508.393	2.1/2X545 (21.1/2)	1	22330.635.546
1.7/8X255 (10)	1	22330.476.254	2.IN.X400 (15.3/4)	1	22330.508.400	2.1/2X560 (22)	1	22330.635.558
1.7/8X280 (11)	1	22330.476.279	2.IN.X405 (16)	1	22330.508.406	2.1/2X570 (22.1/2)	1	22330.635.571
1.7/8X305 (12)	1	22330.476.304	2.IN.X410 (16.1/8)	1	22330.508.410	2.1/2X585 (23)	1	22330.635.584
1.7/8X310 (12.1/4)	1	22330.476.311	2.IN.X415 (16.1/4)	1	22330.508.412	2.1/2X590 (23.1/4)	1	22330.635.590
1.7/8X315 (12.1/2)	1	22330.476.317	2.IN.X420 (16.1/2)	1	22330.508.419	2.1/2X600 (23.5/8)	1	22330.635.600
1.7/8X320 (12.5/8)	1	22330.476.320	2.IN.X425 (16.3/4)	1	22330.508.425	2.1/2X630 (24.3/4)	1	22330.635.628
1.7/8X325 (12.3/4)	1	22330.476.323	2.IN.X430 (17)	1	22330.508.431	2.1/2X650 (25.5/8)	1	22330.635.650
1.7/8X330 (13)	1	22330.476.330	2.IN.X435 (17.1/8)	1	22330.508.435	2.1/2X730 (28.3/4)	1	22330.635.730
1.7/8X335 (13.1/4)	1	22330.476.336	2.IN.X440 (17.1/4)	1	22330.508.438	2.1/2X780 (30.3/4)	1	22330.635.781
1.7/8X340 (13.3/8)	1	22330.476.340	2.IN.X445 (17.1/2)	1	22330.508.444	2.1/2X805 (31.3/4)	1	22330.635.806
1.7/8X345 (13.1/2)	1	22330.476.342	2.IN.X450 (17.3/4)	1	22330.508.450	2.1/2X845 (33.1/4)	1	22330.635.844
1.7/8X350 (13.3/4)	1	22330.476.349	2.IN.X455 (18)	1	22330.508.457	2.1/2X890 (35)	1	22330.635.889
1.7/8X355 (14)	1	22330.476.355	2.IN.X460 (18.1/8)	1	22330.508.460	2.1/2X950 (37.3/8)	1	22330.635.950
1.7/8X360 (14.1/4)	1	22330.476.361	2.IN.X465 (18.1/4)	1	22330.508.463			
1.7/8X365 (14.3/8)	1	22330.476.365	2.IN.X470 (18.1/2)	1	22330.508.469	2.3/4X450 (17.3/4)	1	22330.698.450
1.7/8X370 (14.1/2)	1	22330.476.368	2.IN.X475 (18.3/4)	1	22330.508.476	2.3/4X500 (19.3/4)	1	22330.698.501
1.7/8X375 (14.3/4)	1	22330.476.374	2.IN.X480 (18.7/8)	1	22330.508.480	2.3/4X520 (20.1/2)	1	22330.698.520
1.7/8X380 (15)	1	22330.476.381	2.IN.X485 (19)	1	22330.508.482	2.3/4X535 (21)	1	22330.698.533
1.7/8X385 (15.1/4)	1	22330.476.387	2.IN.X490 (19.1/4)	1	22330.508.488	2.3/4X600 (23.5/8)	1	22330.698.600
1.7/8X390 (15.3/8)	1	22330.476.390	2.IN.X495 (19.1/2)	1	22330.508.495	2.3/4X620 (24.1/2)	1	22330.698.622
1.7/8X395 (15.1/2)	1	22330.476.393	2.IN.X500 (19.3/4)	1	22330.508.501	2.3/4X630 (24.3/4)	1	22330.698.628
1.7/8X400 (15.3/4)	1	22330.476.400	2.IN.X510 (20)	1	22330.508.508	2.3/4X660 (26)	1	22330.698.660
1.7/8X405 (16)	1	22330.476.406	2.IN.X550 (21.3/4)	1	22330.508.552	2.3/4X690 (27.1/4)	1	22330.698.692
1.7/8X410 (16.1/8)	1	22330.476.410	2.IN.X565 (22.1/4)	1	22330.508.565	2.3/4X710 (28)	1	22330.698.711
1.7/8X415 (16.1/4)	1	22330.476.412	2.IN.X570 (22.1/2)	1	22330.508.571	2.3/4X720 (28.3/8)	1	22330.698.720
1.7/8X420 (16.1/2)	1	22330.476.419	2.IN.X595 (23.1/2)	1	22330.508.596	2.3/4X730 (28.3/4)	1	22330.698.730
1.7/8X425 (16.3/4)	1	22330.476.425	2.IN.X600 (23.5/8)	1	22330.508.600			
1.7/8X430 (17)	1	22330.476.431	2.IN.X645 (18.1/2)	1	22330.508.647	3.IN.X355 (14)	1	22330.762.355
1.7/8X435 (17.1/8)	1	22330.476.435	2.IN.X650 (25.5/8)	1	22330.508.650	3.IN.X475 (18.3/4)	1	22330.762.476
1.7/8X440 (17.1/4)	1	22330.476.438	2.IN.X655 (25.3/4)	1	22330.508.654	3.IN.X585 (23)	1	22330.762.584
1.7/8X445 (17.1/2)	1	22330.476.444	2.IN.X660 (26)	1	22330.508.660	3.IN.X590 (23.1/4)	1	22330.762.590
1.7/8X450 (17.3/4)	1	22330.476.450	2.IN.X670 (26.3/8)	1	22330.508.670	3.IN.X650 (25.5/8)	1	22330.762.650
1.7/8X455 (18)	1	22330.476.457	2.IN.X680 (26.3/4)	1	22330.508.679	3.IN.X660 (26)	1	22330.762.660
1.7/8X460 (18.1/8)	1	22330.476.460	2.IN.X690 (27.1/4)	1	22330.508.692	3.IN.X700 (27.1/2)	1	22330.762.698
1.7/8X465 (18.1/4)	1	22330.476.463	2.IN.X700 (27.1/2)	1	22330.508.698	3.IN.X710 (28)	1	22330.762.711
1.7/8X470 (18.1/2)	1	22330.476.469	2.IN.X710 (28)	1	22330.508.711	3.IN.X735 (29)	1	22330.762.736
1.7/8X475 (18.3/4)	1	22330.476.476	2.IN.X740 (29.1/4)	1	22330.508.742	3.IN.X800 (31.1/2)	1	22330.762.800
1.7/8X480 (18.7/8)	1	22330.476.480	2.IN.X750 (29.1/2)	1	22330.508.749	3.IN.X850 (33.1/2)	1	22330.762.850

Thread Unified National Coarse
Material Stainless steel ASTM A193 - ASTM A194
Class Gr.B8 Cl.1 - Gr.8

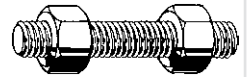
4

d x L mm (L Inch)	☒	Art.number	d x L mm (L Inch)	☒	Art.number	d x L mm (L Inch)	☒	Art.number
3/8X25 (1)	1	22534.096.025	5/8X140 (5.1/2)	1	22534.158.139	3/4X200 (8)	1	22534.191.203
3/8X30 (1.1/4)	1	22534.096.031	5/8X145 (5.3/4)	1	22534.158.146	3/4X205 (8.1/8)	1	22534.191.205
3/8X40 (1.1/2)	1	22534.096.038	5/8X150 (6)	1	22534.158.152	3/4X210 (8.1/4)	1	22534.191.209
3/8X45 (1.3/4)	1	22534.096.044	5/8X155 (6.1/8)	1	22534.158.155	3/4X215 (8.1/2)	1	22534.191.215
3/8X60 (2.3/8)	1	22534.096.060	5/8X160 (6.1/4)	1	22534.158.158	3/4X220 (8.3/4)	1	22534.191.222
3/8X65 (2.1/2)	1	22534.096.063	5/8X165 (6.1/2)	1	22534.158.165	3/4X225 (8.7/8)	1	22534.191.225
3/8X70 (2.3/4)	1	22534.096.069	5/8X170 (6.3/4)	1	22534.158.171	3/4X230 (9)	1	22534.191.228
3/8X80 (3.1/4)	1	22534.096.082	5/8X175 (6.7/8)	1	22534.158.175	3/4X235 (9.1/4)	1	22534.191.234
3/8X95 (3.3/4)	1	22534.096.095	5/8X180 (7)	1	22534.158.177	3/4X240 (9.1/2)	1	22534.191.241
3/8X100 (4)	1	22534.096.101	5/8X185 (7.1/4)	1	22534.158.184	3/4X245 (9.5/8)	1	22534.191.245
3/8X150 (6)	1	22534.096.152	5/8X190 (7.1/2)	1	22534.158.190	3/4X250 (9.3/4)	1	22534.191.247
3/8X175 (6.7/8)	1	22534.096.175	5/8X195 (7.3/4)	1	22534.158.196	3/4X255 (10)	1	22534.191.254
3/8X185 (7.1/4)	1	22534.096.184	5/8X200 (8)	1	22534.158.203	3/4X260 (10.1/4)	1	22534.191.260
3/8X215 (8.1/2)	1	22534.096.215	5/8X205 (8.1/8)	1	22534.158.205	3/4X265 (10.1/2)	1	22534.191.266
			5/8X210 (8.1/4)	1	22534.158.209	3/4X270 (10.5/8)	1	22534.191.270
1/2X40 (1.1/2)	1	22534.127.038	5/8X215 (8.1/2)	1	22534.158.215	3/4X275 (10.3/4)	1	22534.191.273
1/2X45 (1.3/4)	1	22534.127.044	5/8X220 (8.3/4)	1	22534.158.222	3/4X280 (11)	1	22534.191.279
1/2X50 (2)	1	22534.127.050	5/8X225 (8.7/8)	1	22534.158.225	3/4X285 (11.1/4)	1	22534.191.285
1/2X55 (2.1/4)	1	22534.127.057	5/8X230 (9)	1	22534.158.228	3/4X290 (11.3/8)	1	22534.191.290
1/2X60 (2.3/8)	1	22534.127.060	5/8X235 (9.1/4)	1	22534.158.234	3/4X295 (11.1/2)	1	22534.191.292
1/2X65 (2.1/2)	1	22534.127.063	5/8X240 (9.1/2)	1	22534.158.241	3/4X300 (11.3/4)	1	22534.191.298
1/2X70 (2.3/4)	1	22534.127.069	5/8X245 (9.5/8)	1	22534.158.245	3/4X305 (12)	1	22534.191.304
1/2X75 (3)	1	22534.127.076	5/8X250 (9.3/4)	1	22534.158.247	3/4X310 (12.1/4)	1	22534.191.311
1/2X80 (3.1/4)	1	22534.127.082	5/8X255 (10)	1	22534.158.254	3/4X315 (12.1/2)	1	22534.191.317
1/2X85 (3.3/8)	1	22534.127.085	5/8X260 (10.1/4)	1	22534.158.260	3/4X320 (12.3/8)	1	22534.191.320
1/2X90 (3.1/2)	1	22534.127.088	5/8X265 (10.1/2)	1	22534.158.266	3/4X325 (12.3/4)	1	22534.191.323
1/2X95 (3.3/4)	1	22534.127.095	5/8X270 (10.5/8)	1	22534.158.270	3/4X330 (13)	1	22534.191.330
1/2X100 (4)	1	22534.127.101	5/8X275 (10.3/4)	1	22534.158.273	3/4X335 (13.1/4)	1	22534.191.336
1/2X105 (4.1/8)	1	22534.127.105	5/8X280 (11)	1	22534.158.279	3/4X340 (13.3/8)	1	22534.191.340
1/2X110 (4.1/4)	1	22534.127.107	5/8X285 (11.1/4)	1	22534.158.285	3/4X345 (13.1/2)	1	22534.191.342
1/2X115 (4.1/2)	1	22534.127.114	5/8X290 (11.3/8)	1	22534.158.290	3/4X350 (13.3/4)	1	22534.191.349
1/2X120 (4.3/4)	1	22534.127.120	5/8X295 (11.1/2)	1	22534.158.292	3/4X355 (14)	1	22534.191.355
1/2X125 (5)	1	22534.127.127	5/8X300 (11.3/4)	1	22534.158.298	3/4X360 (14.1/4)	1	22534.191.361
1/2X130 (5.1/8)	1	22534.127.130	5/8X305 (12)	1	22534.158.304	3/4X365 (14.3/8)	1	22534.191.365
1/2X135 (5.1/4)	1	22534.127.133	5/8X310 (12.1/4)	1	22534.158.311	3/4X370 (14.1/2)	1	22534.191.368
1/2X140 (5.1/2)	1	22534.127.139	5/8X315 (12.1/2)	1	22534.158.317	3/4X375 (14.3/4)	1	22534.191.374
1/2X145 (5.3/4)	1	22534.127.146	5/8X320 (12.5/8)	1	22534.158.320	3/4X380 (15)	1	22534.191.381
1/2X150 (6)	1	22534.127.152	5/8X325 (12.3/4)	1	22534.158.323	3/4X385 (15.1/4)	1	22534.191.387
1/2X155 (6.1/8)	1	22534.127.155	5/8X330 (13)	1	22534.158.330	3/4X390 (15.3/8)	1	22534.191.390
1/2X160 (6.1/4)	1	22534.127.158	5/8X335 (13.1/4)	1	22534.158.336	3/4X395 (15.1/2)	1	22534.191.393
1/2X165 (6.1/2)	1	22534.127.165	5/8X340 (13.3/8)	1	22534.158.340	3/4X400 (15.3/4)	1	22534.191.400
1/2X170 (6.3/4)	1	22534.127.171	5/8X370 (14.1/2)	1	22534.158.368	3/4X405 (16)	1	22534.191.406
1/2X175 (6.7/8)	1	22534.127.175	5/8X375 (14.3/4)	1	22534.158.374	3/4X410 (16.1/8)	1	22534.191.410
1/2X180 (7)	1	22534.127.177	5/8X385 (15.1/4)	1	22534.158.387	3/4X415 (16.1/4)	1	22534.191.412
1/2X185 (7.1/4)	1	22534.127.184				3/4X420 (16.1/2)	1	22534.191.419
1/2X190 (7.1/2)	1	22534.127.190	3/4X50 (2)	1	22534.191.050	3/4X430 (17)	1	22534.191.431
1/2X195 (7.3/4)	1	22534.127.196	3/4X55 (2.1/4)	1	22534.191.057	3/4X440 (17.1/4)	1	22534.191.438
1/2X200 (8)	1	22534.127.203	3/4X60 (2.3/8)	1	22534.191.060	3/4X450 (17.3/4)	1	22534.191.450
1/2X205 (8.1/8)	1	22534.127.205	3/4X65 (2.1/2)	1	22534.191.063	3/4X455 (18)	1	22534.191.457
1/2X210 (8.1/4)	1	22534.127.209	3/4X70 (2.3/4)	1	22534.191.069	3/4X470 (18.1/2)	1	22534.191.469
1/2X225 (8.7/8)	1	22534.127.225	3/4X75 (3)	1	22534.191.076	3/4X480 (18.7/8)	1	22534.191.480
1/2X230 (9)	1	22534.127.228	3/4X80 (3.1/4)	1	22534.191.082	3/4X485 (19)	1	22534.191.482
1/2X250 (9.3/4)	1	22534.127.247	3/4X85 (3.3/8)	1	22534.191.085	3/4X580 (22.7/8)	1	22534.191.580
1/2X280 (11)	1	22534.127.279	3/4X90 (3.1/2)	1	22534.191.088	3/4X625 (24.5/8)	1	22534.191.625
			3/4X95 (3.3/4)	1	22534.191.095			
5/8X40 (1.1/2)	1	22534.158.038	3/4X100 (4)	1	22534.191.101	7/8X70 (2.3/4)	1	22534.222.069
5/8X45 (1.3/4)	1	22534.158.044	3/4X105 (4.1/8)	1	22534.191.105	7/8X75 (3)	1	22534.222.076
5/8X50 (2)	1	22534.158.050	3/4X110 (4.1/4)	1	22534.191.107	7/8X80 (3.1/4)	1	22534.222.082
5/8X55 (2.1/4)	1	22534.158.057	3/4X115 (4.1/2)	1	22534.191.114	7/8X85 (3.3/8)	1	22534.222.085
5/8X60 (2.3/8)	1	22534.158.060	3/4X120 (4.3/4)	1	22534.191.120	7/8X90 (3.1/2)	1	22534.222.088
5/8X65 (2.1/2)	1	22534.158.063	3/4X125 (5)	1	22534.191.127	7/8X95 (3.3/4)	1	22534.222.095
5/8X70 (2.3/4)	1	22534.158.069	3/4X130 (5.1/8)	1	22534.191.130	7/8X100 (4)	1	22534.222.101
5/8X75 (3)	1	22534.158.076	3/4X135 (5.1/4)	1	22534.191.133	7/8X105 (4.1/8)	1	22534.222.105
5/8X80 (3.1/4)	1	22534.158.082	3/4X140 (5.1/2)	1	22534.191.139	7/8X110 (4.1/4)	1	22534.222.107
5/8X85 (3.3/8)	1	22534.158.085	3/4X145 (5.3/4)	1	22534.191.146	7/8X115 (4.1/2)	1	22534.222.114
5/8X90 (3.1/2)	1	22534.158.088	3/4X150 (6.IN.)	1	22534.191.152	7/8X120 (4.3/4)	1	22534.222.120
5/8X95 (3.3/4)	1	22534.158.095	3/4X155 (6.1/8)	1	22534.191.155	7/8X125 (5)	1	22534.222.127
5/8X100 (4)	1	22534.158.101	3/4X160 (6.1/4)	1	22534.191.158	7/8X130 (5.1/8)	1	22534.222.130
5/8X105 (4.1/8)	1	22534.158.105	3/4X165 (6.1/2)	1	22534.191.165	7/8X135 (5.1/4)	1	22534.222.133
5/8X110 (4.1/4)	1	22534.158.107	3/4X170 (6.3/4)	1	22534.191.171	7/8X140 (5.1/2)	1	22534.222.139
5/8X115 (4.1/2)	1	22534.158.114	3/4X175 (6.7/8)	1	22534.191.175	7/8X145 (5.3/4)	1	22534.222.146
5/8X120 (4.3/4)	1	22534.158.120	3/4X180 (7)	1	22534.191.177	7/8X150 (6)	1	22534.222.152
5/8X125 (5)	1	22534.158.127	3/4X185 (7.1/4)	1	22534.191.184	7/8X155 (6.1/8)	1	22534.222.155
5/8X130 (5.1/8)	1	22534.158.130	3/4X190 (7.1/2)	1	22534.191.190	7/8X160 (6.1/4)	1	22534.222.158
5/8X135 (5.1/4)	1	22534.158.133	3/4X195 (7.3/4)	1	22534.191.196	7/8X165 (6.1/2)	1	22534.222.165

22534 Studbolt with 2 hexagon nuts

d x L mm (L Inch)	☒	Art.number	d x L mm (L Inch)	☒	Art.number	d x L mm (L Inch)	☒	Art.number
7/8X170 (6.3/4)	1	22534.222.171	7/8X415 (16.1/4)	1	22534.222.412	1.IN.X255 (10)	1	22534.254.254
7/8X175 (6.7/8)	1	22534.222.175	7/8X420 (16.1/2)	1	22534.222.419	1.IN.X260 (10.1/4)	1	22534.254.260
7/8X180 (7)	1	22534.222.177	7/8X425 (16.3/4)	1	22534.222.425	1.IN.X265 (10.1/2)	1	22534.254.266
7/8X185 (7.1/4)	1	22534.222.184	7/8X430 (17)	1	22534.222.431	1.IN.X270 (10.5/8)	1	22534.254.270
7/8X190 (7.1/2)	1	22534.222.190	7/8X440 (17.1/4)	1	22534.222.438	1.IN.X275 (10.3/4)	1	22534.254.273
7/8X195 (7.3/4)	1	22534.222.196	7/8X450 (17.3/4)	1	22534.222.450	1.IN.X280 (11)	1	22534.254.279
7/8X200 (8)	1	22534.222.203	7/8X455 (18)	1	22534.222.457	1.IN.X285 (11.1/4)	1	22534.254.285
7/8X205 (8.1/8)	1	22534.222.205	7/8X470 (18.1/2)	1	22534.222.469	1.IN.X290 (11.3/8)	1	22534.254.290
7/8X210 (8.1/4)	1	22534.222.209	7/8X485 (19)	1	22534.222.482	1.IN.X295 (11.1/2)	1	22534.254.292
7/8X215 (8.1/2)	1	22534.222.215	7/8X495 (19.1/2)	1	22534.222.495	1.IN.X300 (11.3/4)	1	22534.254.298
7/8X220 (8.3/4)	1	22534.222.222	7/8X510 (20)	1	22534.222.508	1.IN.X305 (12)	1	22534.254.304
7/8X225 (8.7/8)	1	22534.222.225	7/8X515 (20.1/4)	1	22534.222.514	1.IN.X310 (12.1/4)	1	22534.254.311
7/8X230 (9)	1	22534.222.228	7/8X525 (20.3/4)	1	22534.222.527	1.IN.X315 (12.1/2)	1	22534.254.317
7/8X235 (9.1/4)	1	22534.222.234	1.IN.X80 (3.1/4)	1	22534.254.082	1.IN.X320 (12.5/8)	1	22534.254.320
7/8X240 (9.1/2)	1	22534.222.241	1.IN.X85 (3.3/8)	1	22534.254.085	1.IN.X325 (12.3/4)	1	22534.254.323
7/8X245 (9.5/8)	1	22534.222.245	1.IN.X90 (3.1/2)	1	22534.254.088	1.IN.X330 (13)	1	22534.254.330
7/8X250 (9.3/4)	1	22534.222.247	1.IN.X95 (3.3/4)	1	22534.254.095	1.IN.X335 (13.1/4)	1	22534.254.336
7/8X255 (10)	1	22534.222.254	1.IN.X100 (4)	1	22534.254.101	1.IN.X340 (13.3/8)	1	22534.254.340
7/8X260 (10.1/4)	1	22534.222.260	1.IN.X105 (4.1/8)	1	22534.254.105	1.IN.X345 (13.1/2)	1	22534.254.342
7/8X265 (10.1/2)	1	22534.222.266	1.IN.X110 (4.1/4)	1	22534.254.107	1.IN.X350 (13.3/4)	1	22534.254.349
7/8X270 (10.5/8)	1	22534.222.270	1.IN.X115 (4.1/2)	1	22534.254.114	1.IN.X355 (14)	1	22534.254.355
7/8X275 (10.3/4)	1	22534.222.273	1.IN.X120 (4.3/4)	1	22534.254.124	1.IN.X360 (14.1/4)	1	22534.254.361
7/8X280 (11)	1	22534.222.279	1.IN.X125 (5)	1	22534.254.127	1.IN.X365 (14.3/8)	1	22534.254.365
7/8X285 (11.1/4)	1	22534.222.285	1.IN.X130 (5.1/8)	1	22534.254.130	1.IN.X370 (14.1/2)	1	22534.254.368
7/8X290 (11.3/8)	1	22534.222.290	1.IN.X135 (5.1/4)	1	22534.254.133	1.IN.X375 (14.3/4)	1	22534.254.374
7/8X295 (11.1/2)	1	22534.222.292	1.IN.X140 (5.1/2)	1	22534.254.139	1.IN.X380 (15)	1	22534.254.381
7/8X300 (11.3/4)	1	22534.222.298	1.IN.X145 (5.3/4)	1	22534.254.146	1.IN.X385 (15.1/4)	1	22534.254.387
7/8X305 (12)	1	22534.222.304	1.IN.X150 (6)	1	22534.254.152	1.IN.X390 (15.3/8)	1	22534.254.390
7/8X310 (12.1/4)	1	22534.222.311	1.IN.X155 (6.1/8)	1	22534.254.155	1.IN.X395 (15.1/2)	1	22534.254.393
7/8X315 (12.1/2)	1	22534.222.317	1.IN.X160 (6.1/4)	1	22534.254.158	1.IN.X400 (15.3/4)	1	22534.254.400
7/8X320 (12.5/8)	1	22534.222.320	1.IN.X165 (6.1/2)	1	22534.254.165	1.IN.X405 (16)	1	22534.254.406
7/8X325 (12.3/4)	1	22534.222.323	1.IN.X170 (6.3/4)	1	22534.254.171	1.IN.X410 (16.1/8)	1	22534.254.410
7/8X330 (13)	1	22534.222.330	1.IN.X175 (6.7/8)	1	22534.254.175	1.IN.X415 (16.1/4)	1	22534.254.412
7/8X335 (13.1/4)	1	22534.222.336	1.IN.X180 (7)	1	22534.254.177	1.IN.X420 (16.1/2)	1	22534.254.419
7/8X340 (13.3/8)	1	22534.222.340	1.IN.X185 (7.1/4)	1	22534.254.184	1.IN.X425 (16.3/4)	1	22534.254.425
7/8X345 (13.1/2)	1	22534.222.342	1.IN.X190 (7.1/2)	1	22534.254.190	1.IN.X430 (17)	1	22534.254.431
7/8X350 (13.3/4)	1	22534.222.349	1.IN.X195 (7.3/4)	1	22534.254.196	1.IN.X435 (17.1/8)	1	22534.254.435
7/8X355 (14)	1	22534.222.355	1.IN.X200 (8)	1	22534.254.203	1.IN.X440 (17.1/4)	1	22534.254.438
7/8X360 (14.1/4)	1	22534.222.361	1.IN.X205 (8.1/8)	1	22534.254.205	1.IN.X445 (17.1/2)	1	22534.254.444
7/8X365 (14.3/8)	1	22534.222.365	1.IN.X210 (8.1/4)	1	22534.254.209	1.IN.X450 (17.3/4)	1	22534.254.450
7/8X370 (14.1/2)	1	22534.222.368	1.IN.X215 (8.1/2)	1	22534.254.215	1.IN.X455 (18)	1	22534.254.457
7/8X375 (14.3/4)	1	22534.222.375	1.IN.X220 (8.3/4)	1	22534.254.222	1.IN.X460 (18.1/8)	1	22534.254.460
7/8X380 (15)	1	22534.222.381	1.IN.X225 (8.7/8)	1	22534.254.225	1.IN.X470 (18.1/2)	1	22534.254.469
7/8X385 (15.1/4)	1	22534.222.382	1.IN.X230 (9)	1	22534.254.228	1.IN.X485 (19)	1	22534.254.482
7/8X390 (15.3/8)	1	22534.222.390	1.IN.X235 (9.1/4)	1	22534.254.234	1.IN.X505 (19.7/8)	1	22534.254.505
7/8X395 (15.1/2)	1	22534.222.393	1.IN.X240 (9.1/2)	1	22534.254.241	1.IN.X515 (20.1/4)	1	22534.254.514
7/8X400 (15.3/4)	1	22534.222.400	1.IN.X245 (9.5/8)	1	22534.254.245	1.IN.X520 (20.1/2)	1	22534.254.520
7/8X405 (16)	1	22534.222.406	1.IN.X250 (9.3/4)	1	22534.254.247	1.IN.X595 (23.1/2)	1	22534.254.596
7/8X410 (16.1/8)	1	22534.222.410				1.IN.X730 (28.3/4)	1	22534.254.730

4
22538 Studbolt with 2 hexagon nuts
G12A

Thread Unified National Coarse
Material Stainless steel ASTM A193 - ASTM A194
Class Gr.B8M Cl.2 - Gr.8M

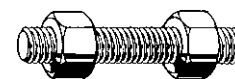

d x L mm (L Inch)	☒	Art.number	d x L mm (L Inch)	☒	Art.number	d x L mm (L Inch)	☒	Art.number
3/8X25 (1)	1	22538.096.025	1/2X70 (2.3/4)	1	22538.127.069	1/2X175 (6.7/8)	1	22538.127.175
3/8X40 (1.1/2)	1	22538.096.038	1/2X75 (3)	1	22538.127.076	1/2X180 (7)	1	22538.127.177
3/8X45 (1.3/4)	1	22538.096.044	1/2X80 (3.1/4)	1	22538.127.082	1/2X185 (7.1/4)	1	22538.127.184
3/8X55 (2.1/4)	1	22538.096.057	1/2X85 (3.3/8)	1	22538.127.085	1/2X190 (7.1/2)	1	22538.127.190
3/8X60 (2.3/8)	1	22538.096.060	1/2X90 (3.1/2)	1	22538.127.088	1/2X195 (7.3/4)	1	22538.127.196
3/8X65 (2.1/2)	1	22538.096.063	1/2X95 (3.3/4)	1	22538.127.095	1/2X200 (8)	1	22538.127.203
3/8X70 (2.3/4)	1	22538.096.069	1/2X100 (4)	1	22538.127.101	1/2X205 (8.1/8)	1	22538.127.205
3/8X75 (3)	1	22538.096.076	1/2X105 (4.1/8)	1	22538.127.105	1/2X210 (8.1/4)	1	22538.127.209
3/8X80 (3.1/4)	1	22538.096.082	1/2X110 (4.1/4)	1	22538.127.107	1/2X215 (8.1/2)	1	22538.127.215
3/8X95 (3.3/4)	1	22538.096.095	1/2X115 (4.1/2)	1	22538.127.114	1/2X220 (8.3/4)	1	22538.127.222
3/8X100 (4)	1	22538.096.101	1/2X120 (4.3/4)	1	22538.127.120	1/2X225 (8.7/8)	1	22538.127.225
3/8X175 (6.7/8)	1	22538.096.175	1/2X125 (5)	1	22538.127.127	1/2X230 (9)	1	22538.127.228
3/8X185 (7.1/4)	1	22538.096.184	1/2X130 (5.1/8)	1	22538.127.130	1/2X235 (9.1/4)	1	22538.127.234
			1/2X135 (5.1/4)	1	22538.127.133	1/2X240 (9.1/2)	1	22538.127.241
1/2X30 (1.1/4)	1	22538.127.031	1/2X140 (5.1/2)	1	22538.127.139	1/2X245 (9.5/8)	1	22538.127.245
1/2X40 (1.1/2)	1	22538.127.038	1/2X145 (5.3/4)	1	22538.127.146	1/2X250 (9.3/4)	1	22538.127.247
1/2X45 (1.3/4)	1	22538.127.044	1/2X150 (6)	1	22538.127.152	1/2X255 (10)	1	22538.127.254
1/2X50 (2)	1	22538.127.050	1/2X155 (6.1/8)	1	22538.127.155	1/2X260 (10.1/4)	1	22538.127.260
1/2X55 (2.1/4)	1	22538.127.057	1/2X160 (6.1/4)	1	22538.127.158	1/2X265 (10.1/2)	1	22538.127.266
1/2X60 (2.3/8)	1	22538.127.060	1/2X165 (6.1/2)	1	22538.127.165	1/2X270 (10.5/8)	1	22538.127.270
1/2X65 (2.1/2)	1	22538.127.063	1/2X170 (6.3/4)	1	22538.127.171	1/2X275 (10.3/4)	1	22538.127.273

22538 Studbolt with 2 hexagon nuts								
d x L mm (L Inch)	☒	Art.number	d x L mm (L Inch)	☒	Art.number	d x L mm (L Inch)	☒	Art.number
7/8X345 (13.1/2)	1	22538.222.342	1.IN.X115 (4.1/2)	1	22538.254.114	1.IN.X325 (12.3/4)	1	22538.254.326
7/8X350 (13.3/4)	1	22538.222.349	1.IN.X120 (4.3/4)	1	22538.254.120	1.IN.X330 (13)	1	22538.254.330
7/8X355 (14)	1	22538.222.355	1.IN.X125 (5)	1	22538.254.127	1.IN.X335 (13.1/4)	1	22538.254.336
7/8X360 (14.1/4)	1	22538.222.361	1.IN.X130 (5.1/8)	1	22538.254.130	1.IN.X335 (13.1/4)	1	22538.254.337
7/8X365 (14.3/8)	1	22538.222.365	1.IN.X135 (5.1/4)	1	22538.254.133	1.IN.X340 (13.3/8)	1	22538.254.340
7/8X370 (14.1/2)	1	22538.222.368	1.IN.X140 (5.1/2)	1	22538.254.139	1.IN.X345 (13.1/2)	1	22538.254.342
7/8X375 (14.3/4)	1	22538.222.374	1.IN.X145 (5.3/4)	1	22538.254.146	1.IN.X350 (13.3/4)	1	22538.254.349
7/8X380 (15)	1	22538.222.381	1.IN.X150 (6)	1	22538.254.152	1.IN.X355 (14)	1	22538.254.355
7/8X385 (15.1/4)	1	22538.222.387	1.IN.X155 (6.1/8)	1	22538.254.155	1.IN.X360 (14.1/4)	1	22538.254.361
7/8X390 (15.3/8)	1	22538.222.390	1.IN.X160 (6.1/4)	1	22538.254.158	1.IN.X365 (14.3/8)	1	22538.254.365
7/8X395 (15.1/2)	1	22538.222.393	1.IN.X165 (6.1/2)	1	22538.254.165	1.IN.X370 (14.1/2)	1	22538.254.368
7/8X400 (15.3/4)	1	22538.222.400	1.IN.X170 (6.3/4)	1	22538.254.171	1.IN.X375 (14.3/4)	1	22538.254.374
7/8X405 (16)	1	22538.222.406	1.IN.X175 (6.7/8)	1	22538.254.175	1.IN.X380 (15)	1	22538.254.381
7/8X410 (16.1/8)	1	22538.222.410	1.IN.X180 (7)	1	22538.254.177	1.IN.X385 (15.1/4)	1	22538.254.387
7/8X415 (16.1/4)	1	22538.222.412	1.IN.X185 (7.1/4)	1	22538.254.184	1.IN.X390 (15.3/8)	1	22538.254.390
7/8X420 (16.1/2)	1	22538.222.419	1.IN.X190 (7.1/2)	1	22538.254.190	1.IN.X395 (15.1/2)	1	22538.254.393
7/8X425 (16.3/4)	1	22538.222.425	1.IN.X195 (7.3/4)	1	22538.254.196	1.IN.X400 (15.3/4)	1	22538.254.400
7/8X430 (17)	1	22538.222.431	1.IN.X200 (8)	1	22538.254.203	1.IN.X405 (16)	1	22538.254.406
7/8X435 (17.1/8)	1	22538.222.435	1.IN.X205 (8.1/8)	1	22538.254.205	1.IN.X410 (16.1/8)	1	22538.254.410
7/8X440 (17.1/4)	1	22538.222.438	1.IN.X210 (8.1/4)	1	22538.254.209	1.IN.X415 (16.1/4)	1	22538.254.412
7/8X445 (17.1/2)	1	22538.222.444	1.IN.X215 (8.1/2)	1	22538.254.215	1.IN.X420 (16.1/2)	1	22538.254.419
7/8X450 (17.3/4)	1	22538.222.450	1.IN.X220 (8.3/4)	1	22538.254.222	1.IN.X425 (16.3/4)	1	22538.254.425
7/8X455 (18)	1	22538.222.457	1.IN.X225 (8.7/8)	1	22538.254.225	1.IN.X430 (17)	1	22538.254.431
7/8X460 (18.1/8)	1	22538.222.460	1.IN.X230 (9)	1	22538.254.228	1.IN.X435 (17.1/8)	1	22538.254.435
7/8X465 (18.1/4)	1	22538.222.463	1.IN.X235 (9.1/4)	1	22538.254.234	1.IN.X440 (17.1/4)	1	22538.254.438
7/8X470 (18.1/2)	1	22538.222.469	1.IN.X240 (9.1/2)	1	22538.254.241	1.IN.X445 (17.1/2)	1	22538.254.444
7/8X475 (18.3/4)	1	22538.222.476	1.IN.X245 (9.5/8)	1	22538.254.245	1.IN.X450 (17.3/4)	1	22538.254.450
7/8X480 (18.7/8)	1	22538.222.480	1.IN.X250 (9.3/4)	1	22538.254.247	1.IN.X455 (18)	1	22538.254.457
7/8X485 (19)	1	22538.222.482	1.IN.X255 (10)	1	22538.254.254	1.IN.X460 (18.1/8)	1	22538.254.460
7/8X490 (19.1/4)	1	22538.222.488	1.IN.X260 (10.1/4)	1	22538.254.260	1.IN.X465 (18.1/4)	1	22538.254.463
7/8X495 (19.1/2)	1	22538.222.495	1.IN.X265 (10.1/2)	1	22538.254.266	1.IN.X470 (18.1/2)	1	22538.254.469
7/8X500 (19.3/4)	1	22538.222.501	1.IN.X270 (10.5/8)	1	22538.254.270	1.IN.X475 (18.3/4)	1	22538.254.476
7/8X510 (20)	1	22538.222.508	1.IN.X275 (10.3/4)	1	22538.254.273	1.IN.X480 (18.7/8)	1	22538.254.480
7/8X515 (20.1/4)	1	22538.222.514	1.IN.X280 (11)	1	22538.254.279	1.IN.X485 (19)	1	22538.254.482
7/8X525 (20.3/4)	1	22538.222.527	1.IN.X285 (11.1/4)	1	22538.254.285	1.IN.X490 (19.1/4)	1	22538.254.488
1.IN.X80 (3.1/4)	1	22538.254.082	1.IN.X290 (11.3/8)	1	22538.254.290	1.IN.X495 (19.1/2)	1	22538.254.495
1.IN.X85 (3.3/8)	1	22538.254.085	1.IN.X295 (11.1/2)	1	22538.254.292	1.IN.X500 (19.3/4)	1	22538.254.501
1.IN.X90 (3.1/2)	1	22538.254.088	1.IN.X300 (11.3/4)	1	22538.254.298	1.IN.X505 (19.7/8)	1	22538.254.505
1.IN.X95 (3.3/4)	1	22538.254.095	1.IN.X305 (12)	1	22538.254.304	1.IN.X515 (20.1/4)	1	22538.254.514
1.IN.X100 (4)	1	22538.254.101	1.IN.X310 (12.1/4)	1	22538.254.311	1.IN.X520 (20.1/2)	1	22538.254.520
1.IN.X105 (4.1/8)	1	22538.254.105	1.IN.X315 (12.1/2)	1	22538.254.317	1.IN.X595 (23.1/2)	1	22538.254.596
1.IN.X110 (4.1/4)	1	22538.254.107	1.IN.X320 (12.5/8)	1	22538.254.320	1.IN.X730 (28.3/4)	1	22538.254.730
			1.IN.X325 (12.3/4)	1	22538.254.323			

22551 Studbolt with 2 hexagon nuts								G11A
Thread	Unified National Coarse							
Material	Steel ASTM A193 - ASTM A194							
Class	Gr.B16 - Gr.2H							
								

d x L mm (L Inch)	☒	Art.number	d x L mm (L Inch)	☒	Art.number	d x L mm (L Inch)	☒	Art.number
1/2X65 (2.1/2)	1	22551.127.063	5/8X90 (3.1/2)	1	22551.158.088	3/4X120 (4.3/4)	1	22551.191.120
1/2X70 (2.3/4)	1	22551.127.069	5/8X95 (3.3/4)	1	22551.158.095	3/4X125 (5)	1	22551.191.127
1/2X75 (3)	1	22551.127.076	5/8X100 (4)	1	22551.158.101			
1/2X80 (3.1/4)	1	22551.127.082	5/8X110 (4.1/4)	1	22551.158.107	7/8X115 (4.1/2)	1	22551.222.114
1/2X90 (3.1/2)	1	22551.127.088	5/8X115 (4.1/2)	1	22551.158.114	7/8X120 (4.3/4)	1	22551.222.120
1/2X95 (3.3/4)	1	22551.127.095	5/8X120 (4.3/4)	1	22551.158.120	7/8X125 (5)	1	22551.222.127
1/2X100 (4)	1	22551.127.101	5/8X125 (5)	1	22551.158.127	7/8X135 (5.1/4)	1	22551.222.133
5/8X65 (2.1/2)	1	22551.158.063				7/8X140 (5.1/2)	1	22551.222.139
5/8X70 (2.3/4)	1	22551.158.069	3/4X95 (3.3/4)	1	22551.191.095	7/8X145 (5.3/4)	1	22551.222.146
5/8X75 (3)	1	22551.158.076	3/4X100 (4)	1	22551.191.101	7/8X150 (6)	1	22551.222.152
5/8X80 (3.1/4)	1	22551.158.082	3/4X110 (4.1/4)	1	22551.191.107			
			3/4X115 (4.1/2)	1	22551.191.114	1X165 (6.1/2)	1	22551.254.165

22554 Studbolt with 2 hexagon nuts								G11A
Thread	Unified National Coarse							
Material	Steel ASTM A193 - ASTM A194							
Class	Gr.B16 - Gr.4							
								

d x L mm (L Inch)	☒	Art.number	d x L mm (L Inch)	☒	Art.number	d x L mm (L Inch)	☒	Art.number
3/8X25 (1)	1	22554.096.025	3/8X60 (2.3/8)	1	22554.096.060	3/8X80 (3.1/4)	1	22554.096.082
3/8X40 (1.1/2)	1	22554.096.038	3/8X65 (2.1/2)	1	22554.096.063	3/8X95 (3.3/4)	1	22554.096.095
3/8X45 (1.3/4)	1	22554.096.044	3/8X70 (2.3/4)	1	22554.096.069	3/8X100 (4)	1	22554.096.101

22554 Studbolt with 2 hexagon nuts								
d x L mm (L Inch)	☒	Art.number	d x L mm (L Inch)	☒	Art.number	d x L mm (L Inch)	☒	Art.number
7/8X335 (13.1/4)	1	22554.222.336	1.IN.X125 (5)	1	22554.254.127	1.IN.X315 (12.1/2)	1	22554.254.317
7/8X340 (13.3/8)	1	22554.222.340	1.IN.X130 (5.1/8)	1	22554.254.130	1.IN.X320 (12.5/8)	1	22554.254.320
7/8X345 (13.1/2)	1	22554.222.342	1.IN.X135 (5.1/4)	1	22554.254.133	1.IN.X325 (12.3/4)	1	22554.254.323
7/8X350 (13.3/4)	1	22554.222.349	1.IN.X140 (5.1/2)	1	22554.254.139	1.IN.X330 (13)	1	22554.254.330
7/8X355 (14)	1	22554.222.355	1.IN.X145 (5.3/4)	1	22554.254.146	1.IN.X335 (13.1/4)	1	22554.254.336
7/8X360 (14.1/4)	1	22554.222.361	1.IN.X150 (6)	1	22554.254.152	1.IN.X340 (13.3/8)	1	22554.254.340
7/8X365 (14.3/8)	1	22554.222.365	1.IN.X155 (6.1/8)	1	22554.254.155	1.IN.X345 (13.1/2)	1	22554.254.342
7/8X370 (14.1/2)	1	22554.222.368	1.IN.X160 (6.1/4)	1	22554.254.158	1.IN.X350 (13.3/4)	1	22554.254.349
7/8X375 (14.3/4)	1	22554.222.375	1.IN.X165 (6.1/2)	1	22554.254.165	1.IN.X355 (14)	1	22554.254.355
7/8X380 (15)	1	22554.222.381	1.IN.X170 (6.3/4)	1	22554.254.171	1.IN.X360 (14.1/4)	1	22554.254.361
7/8X385 (15.1/4)	1	22554.222.382	1.IN.X175 (6.7/8)	1	22554.254.175	1.IN.X365 (14.3/8)	1	22554.254.365
7/8X390 (15.3/8)	1	22554.222.390	1.IN.X180 (7)	1	22554.254.177	1.IN.X370 (14.1/2)	1	22554.254.368
7/8X395 (15.1/2)	1	22554.222.393	1.IN.X185 (7.1/4)	1	22554.254.184	1.IN.X375 (14.3/4)	1	22554.254.374
7/8X400 (15.3/4)	1	22554.222.400	1.IN.X190 (7.1/2)	1	22554.254.190	1.IN.X380 (15)	1	22554.254.381
7/8X405 (16)	1	22554.222.406	1.IN.X195 (7.3/4)	1	22554.254.196	1.IN.X385 (15.1/4)	1	22554.254.387
7/8X410 (16.1/8)	1	22554.222.410	1.IN.X200 (8)	1	22554.254.203	1.IN.X390 (15.3/8)	1	22554.254.390
7/8X415 (16.1/4)	1	22554.222.412	1.IN.X205 (8.1/8)	1	22554.254.205	1.IN.X395 (15.1/2)	1	22554.254.393
7/8X420 (16.1/2)	1	22554.222.419	1.IN.X210 (8.1/4)	1	22554.254.209	1.IN.X400 (15.3/4)	1	22554.254.400
7/8X425 (16.3/4)	1	22554.222.425	1.IN.X215 (8.1/2)	1	22554.254.215	1.IN.X405 (16)	1	22554.254.406
7/8X430 (17)	1	22554.222.431	1.IN.X220 (8.3/4)	1	22554.254.222	1.IN.X410 (16.1/8)	1	22554.254.410
7/8X440 (17.1/4)	1	22554.222.438	1.IN.X225 (8.7/8)	1	22554.254.225	1.IN.X415 (16.1/4)	1	22554.254.412
7/8X450 (17.3/4)	1	22554.222.450	1.IN.X230 (9)	1	22554.254.228	1.IN.X420 (16.1/2)	1	22554.254.419
7/8X455 (18)	1	22554.222.457	1.IN.X235 (9.1/4)	1	22554.254.234	1.IN.X425 (16.3/4)	1	22554.254.425
7/8X470 (18.1/2)	1	22554.222.469	1.IN.X240 (9.1/2)	1	22554.254.241	1.IN.X430 (17)	1	22554.254.431
7/8X485 (19)	1	22554.222.482	1.IN.X245 (9.5/8)	1	22554.254.245	1.IN.X435 (17.1/8)	1	22554.254.435
7/8X495 (19.1/2)	1	22554.222.495	1.IN.X250 (9.3/4)	1	22554.254.247	1.IN.X440 (17.1/4)	1	22554.254.438
7/8X510 (20)	1	22554.222.508	1.IN.X255 (10)	1	22554.254.254	1.IN.X445 (17.1/2)	1	22554.254.444
7/8X515 (20.1/4)	1	22554.222.514	1.IN.X260 (10.1/4)	1	22554.254.260	1.IN.X450 (17.3/4)	1	22554.254.450
7/8X525 (20.3/4)	1	22554.222.527	1.IN.X265 (10.1/2)	1	22554.254.266	1.IN.X455 (18)	1	22554.254.457
1.IN.X80 (3.1/4)	1	22554.254.082	1.IN.X270 (10.5/8)	1	22554.254.270	1.IN.X460 (18.1/8)	1	22554.254.460
1.IN.X85 (3.3/8)	1	22554.254.085	1.IN.X275 (10.3/4)	1	22554.254.273	1.IN.X470 (18.1/2)	1	22554.254.469
1.IN.X90 (3.1/2)	1	22554.254.088	1.IN.X280 (11)	1	22554.254.279	1.IN.X485 (19)	1	22554.254.482
1.IN.X95 (3.3/4)	1	22554.254.095	1.IN.X285 (11.1/4)	1	22554.254.285	1.IN.X505 (19.7/8)	1	22554.254.505
1.IN.X100 (4)	1	22554.254.101	1.IN.X290 (11.3/8)	1	22554.254.290	1.IN.X515 (20.1/4)	1	22554.254.514
1.IN.X105 (4.1/8)	1	22554.254.105	1.IN.X295 (11.1/2)	1	22554.254.292	1.IN.X520 (20.1/2)	1	22554.254.520
1.IN.X110 (4.1/4)	1	22554.254.107	1.IN.X300 (11.3/4)	1	22554.254.298	1.IN.X595 (23.1/2)	1	22554.254.596
1.IN.X115 (4.1/2)	1	22554.254.114	1.IN.X305 (12)	1	22554.254.304	1.IN.X615 (24.1/4)	1	22554.254.615
			1.IN.X310 (12.1/4)	1	22554.254.311	1.IN.X730 (28.3/4)	1	22554.254.730

Studbolt with 2 hexagon nuts

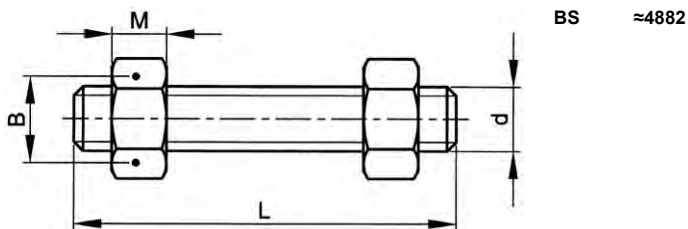

BS ≈4882

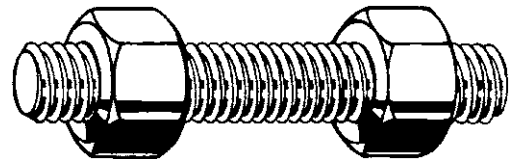

Technical Data

d	B	M	P	d	B	M	P
M12	19	12	1.75	M24	36	24	3
M14	22	14	2	M27	41	27	3
M16	24	16	2	M30	46	30	3.5
M18	27	18	2.5	M33	50	33	3.5
M20	30	20	2.5	M36	55	36	4
M22	32	22	2.5				

- Nut height 'M' is not acc. to BS 4882.
- L is the nominal length of the studbolt including the chamfered ends.

22060 Studbolt with 2 hexagon nuts

G09A

Thread Metric thread
Material Steel ASTM A193M - ASTM A194M
Class Gr.B7 - Gr.2H

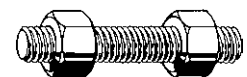

d x L	☒	Art.number	d x L	☒	Art.number	d x L	☒	Art.number
M12X55	1	22060.120.055	M12X70	1	22060.120.070	M12X85	1	22060.120.085
M12X60	1	22060.120.060	M12X75	1	22060.120.075	M12X90	1	22060.120.090
M12X65	1	22060.120.065	M12X80	1	22060.120.080	M12X95	1	22060.120.095

22060 Studbolt with 2 hexagon nuts ←

d x L	✉	Art.number	d x L	✉	Art.number	d x L	✉	Art.number
M12X100	1	22060.120.100	M20X135	1	22060.200.135	M24X320	1	22060.240.320
M12X120	1	22060.120.120	M20X140	1	22060.200.140	M24X365	1	22060.240.365
M12X125	1	22060.120.125	M20X145	1	22060.200.145			
M12X140	1	22060.120.140	M20X150	1	22060.200.150	M27X125	1	22060.270.125
			M20X160	1	22060.200.160	M27X130	1	22060.270.130
M14X55	1	22060.140.055	M20X165	1	22060.200.165	M27X135	1	22060.270.135
M14X65	1	22060.140.065	M20X170	1	22060.200.170	M27X140	1	22060.270.140
M14X70	1	22060.140.070	M20X180	1	22060.200.180	M27X150	1	22060.270.150
M14X75	1	22060.140.075	M20X190	1	22060.200.190	M27X165	1	22060.270.165
M14X80	1	22060.140.080	M20X195	1	22060.200.195	M27X175	1	22060.270.175
M14X85	1	22060.140.085	M20X200	1	22060.200.200	M27X190	1	22060.270.190
M14X90	1	22060.140.090	M20X210	1	22060.200.210	M27X215	1	22060.270.215
M14X100	1	22060.140.100	M20X230	1	22060.200.230	M27X230	1	22060.270.230
M14X120	1	22060.140.120	M20X240	1	22060.200.240	M27X240	1	22060.270.240
			M20X245	1	22060.200.245	M27X250	1	22060.270.250
M16X55	1	22060.160.055	M20X250	1	22060.200.250	M27X275	1	22060.270.275
M16X60	1	22060.160.060	M20X320	1	22060.200.320			
M16X65	1	22060.160.065	M20X340	1	22060.200.340	M30X135	1	22060.300.135
M16X70	1	22060.160.070	M20X400	1	22060.200.400	M30X140	1	22060.300.140
M16X75	1	22060.160.075				M30X150	1	22060.300.150
M16X80	1	22060.160.080	M22X95	1	22060.220.095	M30X155	1	22060.300.155
M16X85	1	22060.160.085	M22X100	1	22060.220.100	M30X170	1	22060.300.170
M16X90	1	22060.160.090	M22X110	1	22060.220.110	M30X175	1	22060.300.175
M16X95	1	22060.160.095	M22X120	1	22060.220.120	M30X180	1	22060.300.180
M16X100	1	22060.160.100	M22X130	1	22060.220.130	M30X185	1	22060.300.185
M16X110	1	22060.160.110	M22X140	1	22060.220.140	M30X215	1	22060.300.215
M16X120	1	22060.160.120	M22X150	1	22060.220.150	M30X220	1	22060.300.220
M16X125	1	22060.160.125	M22X160	1	22060.220.160	M30X230	1	22060.300.230
M16X130	1	22060.160.130	M22X170	1	22060.220.170	M30X240	1	22060.300.240
M16X140	1	22060.160.140	M22X190	1	22060.220.190	M30X250	1	22060.300.250
M16X150	1	22060.160.150	M22X200	1	22060.220.200	M30X500	1	22060.300.500
M16X160	1	22060.160.160	M22X210	1	22060.220.210	M30X590	1	22060.300.590
M16X165	1	22060.160.165						
M16X175	1	22060.160.175	M24X80	1	22060.240.080	M33X150	1	22060.330.150
M16X190	1	22060.160.190	M24X110	1	22060.240.110	M33X170	1	22060.330.170
M16X220	1	22060.160.220	M24X115	1	22060.240.115	M33X175	1	22060.330.175
M16X240	1	22060.160.240	M24X120	1	22060.240.120	M33X185	1	22060.330.185
M16X300	1	22060.160.300	M24X125	1	22060.240.125	M33X190	1	22060.330.190
			M24X130	1	22060.240.130	M33X200	1	22060.330.200
M18X100	1	22060.180.100	M24X140	1	22060.240.140	M33X210	1	22060.330.210
M18X120	1	22060.180.120	M24X145	1	22060.240.145	M33X220	1	22060.330.220
			M24X150	1	22060.240.150	M33X230	1	22060.330.230
M20X75	1	22060.200.075	M24X160	1	22060.240.160	M33X330	1	22060.330.330
M20X80	1	22060.200.080	M24X165	1	22060.240.165			
M20X85	1	22060.200.085	M24X170	1	22060.240.170	M36X175	1	22060.360.175
M20X90	1	22060.200.090	M24X180	1	22060.240.180	M36X190	1	22060.360.190
M20X95	1	22060.200.095	M24X185	1	22060.240.185	M36X200	1	22060.360.200
M20X100	1	22060.200.100	M24X190	1	22060.240.190	M36X210	1	22060.360.210
M20X105	1	22060.200.105	M24X200	1	22060.240.200	M36X220	1	22060.360.220
M20X110	1	22060.200.110	M24X220	1	22060.240.220	M36X230	1	22060.360.230
M20X115	1	22060.200.115	M24X230	1	22060.240.230	M36X240	1	22060.360.240
M20X120	1	22060.200.120	M24X240	1	22060.240.240	M36X250	1	22060.360.250
M20X125	1	22060.200.125	M24X250	1	22060.240.250	M36X260	1	22060.360.260
M20X130	1	22060.200.130	M24X275	1	22060.240.275			

4

Hexagon nut ASTM A194

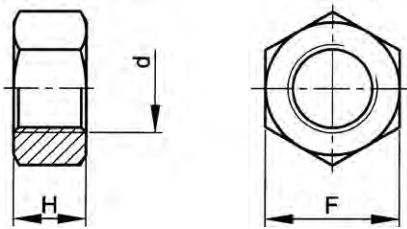

ASME B18.2.2
BS 1769

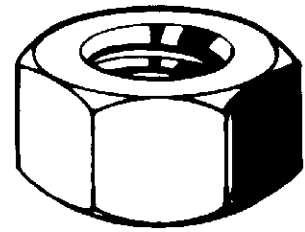

Technical Data



d	F	H	Threads per inch	d	F	H	Threads per inch
3/8	11/16	9	16	1.1/2	2.3/8	37.3	8
1/2	7/8	12.3	13	1.5/8	2.9/16	40.5	8
5/8	1.1/16	15.5	11	1.3/4	2.3/4	43.65	8
3/4	1.1/4	18.65	10	1.7/8	2.15/16	46.85	8
7/8	1.7/16	21.85	9	2 Inch	3.1/8	50	8
1 Inch	1.5/8	25	8	2.1/4	3.1/2	55.95	8
1.1/8	1.13/16	28.2	8	2.1/2	3.7/8	62.3	8
1.1/4	2 Inch	30.95	8	2.3/4	4.1/4	68.25	8
1.3/8	2.3/16	34.15	8	3 Inch	4.5/8	75	8

Article groups

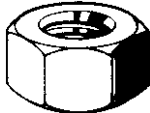

Thread	Driving features	Material	Class	Code	Page
UNC	Hexagon	St ASTM A194	Gr.2H	22280	4-57
8 UN	Hexagon	St ASTM A194	Gr.2H	22290	4-57
UNC	Hexagon	St ASTM A194	Gr.4	22380	4-58
8 UN	Hexagon	St ASTM A194	Gr.4	22390	4-58
UNC	Hexagon	St ASTM A194	Gr.7	22382	4-58
UNC	Hexagon	St.St. ASTM A194	Gr.8	22383	4-58
8 UN	Hexagon	St.St. ASTM A194	Gr.8	22393	4-58
UNC	Hexagon	St.St. ASTM A194	Gr.8M	22384	4-58
UNC	Hexagon	St.St. ASTM A194	Gr.8T	22386	4-59

22280 Hexagon nut ASTM A194						G09A
Thread	Unified National Coarse					
Material	Steel ASTM A194					
Class	Gr.2H					
						

d	☒	Art.number	d	☒	Art.number	d	☒	Art.number
1/2	1	22280.127.001	3/4	1	22280.191.001	1 Inch	1	22280.254.001
5/8	1	22280.158.001	7/8	1	22280.222.001			

22290 Hexagon nut ASTM A194						G09A
Thread	8 Unified National					
Material	Steel ASTM A194					
Class	Gr.2H					
						

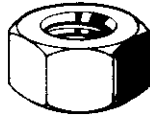

d	☒	Art.number	d	☒	Art.number	d	☒	Art.number
1.1/8	1	22290.285.001	1.5/8	1	22290.412.001	2.1/4	1	22290.571.001
1.1/4	1	22290.317.001	1.3/4	1	22290.444.001	2.1/2	1	22290.635.001
1.3/8	1	22290.349.001	1.7/8	1	22290.476.001	2.3/4	1	22290.698.001
1.1/2	1	22290.381.001	2 Inch	1	22290.508.001	3 Inch	1	22290.762.001

22380	Hexagon nut ASTM A194		G10A
Thread Material Class	Unified National Coarse Steel ASTM A194 Gr.4		
			

d	☒	Art.number	d	☒	Art.number	d	☒	Art.number
3/8	1	22380.096.001	5/8	1	22380.158.001	7/8	1	22380.222.001
1/2	1	22380.127.001	3/4	1	22380.191.001	1 Inch	1	22380.254.001

22390	Hexagon nut ASTM A194		G10A
Thread Material Class	8 Unified National Steel ASTM A194 Gr.4		
			

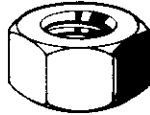

d	☒	Art.number	d	☒	Art.number	d	☒	Art.number
1.1/8	1	22390.285.001	1.1/2	1	22390.381.001	1.7/8	1	22390.476.001
1.1/4	1	22390.317.001	1.5/8	1	22390.412.001	2 Inch	1	22390.508.001
1.3/8	1	22390.349.001	1.3/4	1	22390.444.001			

22382	Hexagon nut ASTM A194		G10A
Thread Material Class	Unified National Coarse Steel ASTM A194 Gr.7		
			

d	☒	Art.number	d	☒	Art.number	d	☒	Art.number
1/2	1	22382.127.001	3/4	1	22382.191.001	1 Inch	1	22382.254.001
5/8	1	22382.158.001	7/8	1	22382.222.001			

22383	Hexagon nut ASTM A194		G12A
Thread Material Class	Unified National Coarse Stainless steel ASTM A194 Gr.8		
			

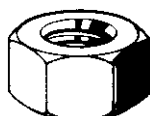
d	☒	Art.number	d	☒	Art.number	d	☒	Art.number
1/2	1	22383.127.001	3/4	1	22383.191.001	1 Inch	1	22383.254.001
5/8	1	22383.158.001	7/8	1	22383.222.001			

22393	Hexagon nut ASTM A194		G12A
Thread Material Class	8 Unified National Stainless steel ASTM A194 Gr.8		
			

d	☒	Art.number	d	☒	Art.number	d	☒	Art.number
1.1/8	1	22393.285.001	1.3/8	1	22393.349.001	1.1/2	1	22393.381.001
1.1/4	1	22393.317.001						

22384	Hexagon nut ASTM A194		G12A
Thread Material Class	Unified National Coarse Stainless steel ASTM A194 Gr.8M		
			

d	☒	Art.number	d	☒	Art.number	d	☒	Art.number
1/2	1	22384.127.001	3/4	1	22384.191.001	1 Inch	1	22384.254.001
5/8	1	22384.158.001	7/8	1	22384.222.001			

22386 Hexagon nut ASTM A194 G12A

Thread Unified National Coarse
Material Stainless steel ASTM A194
Class Gr.8T

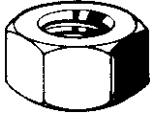
d	☒	Art.number	d	☒	Art.number	d	☒	Art.number
3/8	1	22386.096.001	5/8	1	22386.158.001	7/8	1	22386.222.001
1/2	1	22386.127.001	3/4	1	22386.191.001	1 Inch	1	22386.254.001

Hexagon nut ASTM A194M



4

Technical Data

d	F	H	P	d	F	H	P
M10	17	10	1.5	M30	46	30	3.5
M12	19	12	1.75	M33	50	33	3.5
M14	22	14	2	M36	55	36	4
M16	24	16	2	M39	60	39	4
M18	27	18	2.5	M42	65	42	4.5
M20	30	20	2.5	M45	70	45	4.5
M22	32	22	2.5	M48	75	48	5
M24	36	24	3	M52	80	52	5
M27	41	27	3	M64	95	64	6

22200 Hexagon nut ASTM A194M G09A

Thread Metric thread
Material Steel ASTM A194M
Class Gr.2H

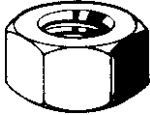
d	☒	Art.number	d	☒	Art.number	d	☒	Art.number
M10	1	22200.100.001	M22	1	22200.220.001	M39	1	22200.390.001
M12	1	22200.120.001	M24	1	22200.240.001	M42	1	22200.420.001
M14	1	22200.140.001	M27	1	22200.270.001	M45	1	22200.450.001
M16	1	22200.160.001	M30	1	22200.300.001	M48	1	22200.480.001
M18	1	22200.180.001	M33	1	22200.330.001	M52	1	22200.520.001
M20	1	22200.200.001	M36	1	22200.360.001	M64	1	22200.640.001

Double end studs

With reduced shank with 2 hexagon nuts

Bolted joints with reduced shaft are particularly effective in constructions that are under dynamic loads and at fluctuating temperatures, to guarantee a high level of resistance to fatigue. Reduced shaft bolts have a much higher level of elongation compared to bolts with shaft, at the same preload. This causes several advantages:

For applications and calculations of double end studs at pressure vessels, we refer to AD 2000 – Merkblatt B7, W7 and W10, published by VdTÜV in Berlin.

4

- Reduced shaft bolts have a higher resistance to fatigue, as the effect of fluctuating external load and temperatures, also bending moments, is reduced.
- The reduction of preload, caused by creep of the clamped materials and the setting of the surfaces in the joint, is reduced.
- Assembly to a specified clamping load is more easy to control

Operating temperature ranges and bolt/nut combinations

SPECIFICATIONS	STANDARD VALUES	MATERIAL NUMBERS AND MARKING SIGNS			
		BOLTS		NUTS	
DIN 267-13/ DIN EN 10269 AD 2000 W7	+ 700° C	2.4952	SB	2.4952	SB
	+ 650° C	1.4986	S	1.4986	S
		1.4980	SD	1.4980	SD
	+ 580° C	1.4923	V	1.4923	V
	+ 540° C	1.4913	VW	1.4923	V
	+ 500° C	1.7709	GA	1.7709	GA
		1.7709	GA	1.7218	KG
		1.7711	GB	1.7709	GA
	+ 400° C	1.7218	KG	1.7218	KG
		1.7218	KG	1.1181	YK
DIN 267-13/ISO 898-1	+ 350° C	8.8			
	- 10° C	5.6			
DIN 267-13/ DIN EN 10269 AD2000 W10	- 60° C	1.7218	KG	1.7218	KG
	- 120° C	1.5680	KB	1.5680	KB
	- 196° C	1.6906	-	1.6906	-

Material properties according to EN 10269

Material designation			Heat Treatment Condition (1)	Temperature range			Diameter mm	Proof strength MPa (min)	Tensile strength MPa	Elongation after fracture % min.	Reduction in area % min.	Impact Energy KJ min.
Product marking	Material name	Material number		Min.	Short Max. (2)	Long Max. (2)						
YK	C35E	1.1181	+QT	-	400°C	500°C	d ≤ 60	300	500-650	22	45	55
							60 < d ≤ 150	300	500-650	22	45	39
KG	25CrMo4	1.7218	+QT	-60°C	500°C	550°C	d ≤ 100	440	600-750	18	60	60
							100 < d ≤ 150	420	600-750	18	60	45
GA	21CrMoV5-7	1.7709	+QT	-	500°C	550°C	d ≤ 160	550	700-850	16	60	63

(1) +QT = quenched and tempered

(2) Short = short time service; Long = long time service. Refer to EN 10269 for more detailed information about strength at elevated temperatures and time frames.

Material properties are applicable at room temperature. For properties at other temperatures, please consult EN 10269.

Double end stud with reduced shank with 2 hexagon nuts

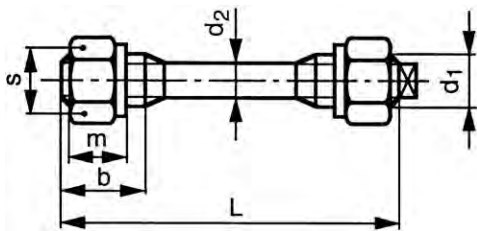

DIN 2510 L/NF

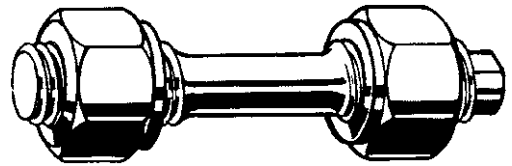

Technical Data

d ₁	b	d ₂	m	P	s
M12	20	8.5	12	1.75	22
M16	23	12	16	2	27
M20	28	15	20	2.5	32
M24	32	18	24	3	36
M27	35	20.5	27	3	41
M30	39	23	30	3.5	46

- For technical data, material properties and an explanation of the markingsigns, see INFO page.
- External thread acc. to DIN 2510-2.

Article groups

Thread	Material	Class	Code	Page
M	St	KG/YK	23510	4-61
M	St	GA/KG	23530	4-61
M	St	YK/YK	23550	4-62

23510 Double end stud with reduced shank with 2 hexagon nuts

G90A

Thread Metric thread
Material Steel 25CrMo4+QT/C35E+QT
Class KG/YK

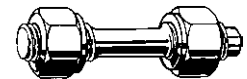

d ₁ x L	☒	Art.number	d ₁ x L	☒	Art.number	d ₁ x L	☒	Art.number
M12X65	10	23510.120.065	M16X95	10	23510.160.095	M24X110	5	23510.240.110
M12X75	10	23510.120.075	M16X110	10	23510.160.110	M24X115	5	23510.240.115
M12X80	10	23510.120.080				M24X120	5	23510.240.120
			M20X100	5	23510.200.100	M24X130	5	23510.240.130
M16X75	10	23510.160.075	M20X105	5	23510.200.105	M24X150	5	23510.240.150
M16X80	10	23510.160.080	M20X110	5	23510.200.110			
M16X85	10	23510.160.085				M27X140	2	23510.270.140
M16X90	10	23510.160.090						

23530 Double end stud with reduced shank with 2 hexagon nuts

G90A

Thread Metric thread
Material Steel 21CrMoV5-7+QT/25CrMo4+QT
Class GA/KG

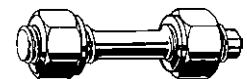

d ₁ x L	☒	Art.number	d ₁ x L	☒	Art.number	d ₁ x L	☒	Art.number
M12X65	10	23530.120.065	M20X110	5	23530.200.110	M24X150	5	23530.240.150
M12X75	10	23530.120.075	M20X120	5	23530.200.120			
			M20X140	5	23530.200.140	M27X130	2	23530.270.130
M16X75	10	23530.160.075				M27X140	2	23530.270.140
M16X85	10	23530.160.085	M24X110	5	23530.240.110			
M16X90	10	23530.160.090	M24X120	5	23530.240.120	M30X160	2	23530.300.160
M16X100	10	23530.160.100	M24X125	5	23530.240.125	M30X180	2	23530.300.180
			M24X130	5	23530.240.130			
M20X100	5	23530.200.100	M24X140	5	23530.240.140			

23550 Double end stud with reduced shank with 2 hexagon nuts G90A

Thread Metric thread
Material Steel C35E+QT
Class YK/YK

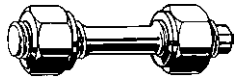



$d_1 \times L$	☒	Art.number	$d_1 \times L$	☒	Art.number	$d_1 \times L$	☒	Art.number
M12X65	10	23550.120.065	M16X100	10	23550.160.100	M24X110	5	23550.240.110
M12X70	10	23550.120.070	M16X105	10	23550.160.105	M24X115	5	23550.240.115
M12X75	10	23550.120.075				M24X125	5	23550.240.125
M12X80	10	23550.120.080	M20X95	5	23550.200.095	M24X130	5	23550.240.130
M16X75	10	23550.160.075	M20X100	5	23550.200.100	M24X140	5	23550.240.140
M16X80	10	23550.160.080	M20X105	5	23550.200.105	M24X150	5	23550.240.150
M16X85	10	23550.160.085	M20X110	5	23550.200.110			
M16X90	10	23550.160.090	M20X120	5	23550.200.120	M30X140	2	23550.300.140

4

Hexagon nut for double end stud

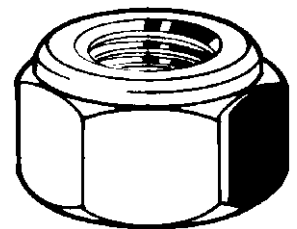
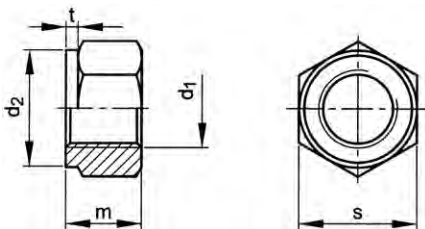
DIN 2510 NF



Technical Data

d_1	d_2	m	P	s	t
M12	21	12	1.75	22	2
M16	26	16	2	27	2
M20	31	20	2.5	32	2
M24	35	24	3	36	3
M27	40	27	3	41	3
M30	45	30	3.5	46	3
M33	49	33	3.5	50	3
M36	53.5	36	4	55	3

* For technical data, material properties and an explanation of the markingsigns, see INFO page. External thread acc. to DIN 2510-2.

Article groups

Thread	Driving features	Material	Class	Code	Page
M	Hexagon	St	KG	23620	4-62
M	Hexagon	St	YK	23660	4-62

23620 Hexagon nut for double end stud G90A

Thread Metric thread
Material Steel 25CrMo4+QT
Class KG





d_1	☒	Art.number	d_1	☒	Art.number	d_1	☒	Art.number
M12	50	23620.120.001	M24	25	23620.240.001	M33	5	23620.330.001
M16	50	23620.160.001	M27	10	23620.270.001	M36	5	23620.360.001
M20	25	23620.200.001	M30	10	23620.300.001			

23660 Hexagon nut for double end stud G90A

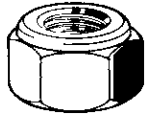
Thread Metric thread
Material Steel C35E+QT
Class YK

d_1	☒	Art.number	d_1	☒	Art.number	d_1	☒	Art.number
M12	50	23660.120.001	M20	25	23660.200.001	M27	10	23660.270.001
M16	50	23660.160.001	M24	25	23660.240.001	M30	10	23660.300.001

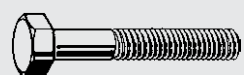

1 Bolts



2 Hexagon socket products



3 Nuts, rivet nuts & inserts



4 Threaded rods & studbolts



5 Hook & eye products



6 Screws

I Index



7 Washers & O-rings



8 Anchoring products

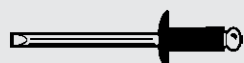

9 Rivets, pins & keys



10 Systems, furniture & security fasteners



11 Assortments & storage systems

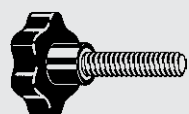



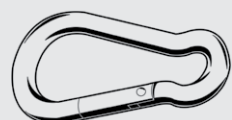

















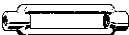

























12 Engineering parts & machine parts

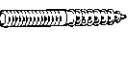
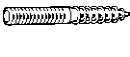

13 Maritime products

T Fastening technology

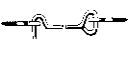
Hook & eye products **5**

 Page 5-2 DIN 186 B Metric	 Page 5-3 Metric	 Page 5-4 DIN 444 B Metric	 Page 5-6 DIN 444 LB Fully threaded Metric	 Page 5-7 DIN 580 Metric CE
 Page 5-9 DIN ≈580 (1957) BSW	 Page 5-10 DIN 582 Metric CE	 Page 5-12 DIN ≈582 (1957) BSW	 Page 5-13 DIN 1478 Made from tubes Metric	 Page 5-13 DIN ≈1479 Hexagon Metric
 Page 5-14 DIN 1480 With two welding ends Metric	 Page 5-15 DIN 1480 Metric	 Page 5-15 DIN ≈1480 With hook and eye	 Page 5-16 DIN ≈1480 With hook and eye Stainless steel	 Page 5-16 DIN ≈1480 With two eyes
 Page 5-17 DIN ≈1480 With two eyes Stainless steel	 Page 5-18 DIN ≈1480 With two hooks	 Page 5-18 DIN ≈1480 With two hooks stainless steel	 Page 5-19 DIN ≈1480 With two flat eyes	 Page 5-19 DIN ≈82101 A Steel
 Page 5-20 Stainless steel	 Page 5-21 Steel	 Page 5-22 Steel	 Page 5-23 Stainless steel	 Page 5-24 DIN 741/555 (1987) Steel
 Page 5-25 Stainless steel	 Page 5-26 Steel/Stainless steel	 Page 5-27 Steel	 Page 5-28 Metric	 Page 5-29 Metric
 Page 5-29 Metric	 Page 5-30 Non Metric	 Page 5-31 Heavy model Non Metric	 Page 5-32 Long model non Metric	 Page 5-32 Non Metric
 Page 5-33 Small hook Non Metric	 Page 5-34 Non Metric	 Page 5-35 Heavy model with cross non Metric	 Page 5-35 With point	 Page 5-36 Dowel screw Steel
 Page 5-37 Dowel screw Stainless steel	 Page 5-37 Dowel screw with hexagon Stainless steel	 Page 5-38 Dowel screw width across flats Stainless steel	 Page 5-39 Dowel screw width across flats and hexalobular	 Page 5-40 Non Metric
 Page 5-41 Metric	 Page 5-41 For swing hooks	 Page 5-42 Non Metric	 Page 5-42 Steel	

T-Head bolt with square neck

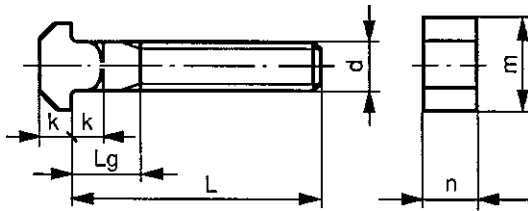

DIN 186 B
NEN 2309

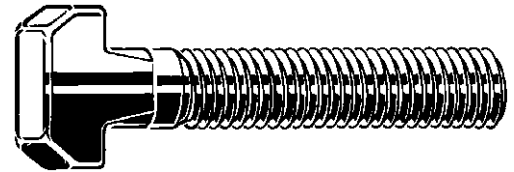

Technical Data

d	k	Lg (max.)	m	n	P
M8	5.5	13	18	8	1.25
M10	7	16	21	10	1.5
M12	8	19	26	12	1.75
M16	10.5	25	30	16	2
M20	13	31	36	20	2.5
M24	15	37	43	24	3
M27 (#DIN)	18	40	48	27	3
M30	19	43	54	30	3.5

• For sizes of T-slots, see DIN 649.

Article groups

Thread	Material	Class	Code	Page
M	St	≥3.6	16190	5-2
M	St.St. A4		55782	5-2

16190 T-Head bolt with square neck

F11D

Thread Metric thread
Material Steel
Class ≥3.6



d x L	☒	Art.number	d x L	☒	Art.number	d x L	☒	Art.number
M8X30	25	16190.080.030	M16X40	10	16190.160.040	M20X180	5	16190.200.180
M8X40	25	16190.080.040	M16X50	10	16190.160.050	M20X200	5	16190.200.200
M8X50	25	16190.080.050	M16X60	10	16190.160.060			
M8X60	25	16190.080.060	M16X70	10	16190.160.070	M24X60	5	16190.240.060
			M16X80	10	16190.160.080	M24X70	5	16190.240.070
M10X30	25	16190.100.030	M16X90	10	16190.160.090	M24X80	5	16190.240.080
M10X40	25	16190.100.040	M16X100	10	16190.160.100	M24X90	5	16190.240.090
M10X50	25	16190.100.050	M16X110	10	16190.160.110	M24X100	5	16190.240.100
M10X60	25	16190.100.060	M16X120	10	16190.160.120	M24X110	5	16190.240.110
M10X70	25	16190.100.070	M16X140	10	16190.160.140	M24X120	5	16190.240.120
			M16X160	10	16190.160.160	M24X140	5	16190.240.140
M12X30	10	16190.120.030	M16X180	10	16190.160.180	M24X160	5	16190.240.160
M12X40	10	16190.120.040	M16X200	10	16190.160.200	M24X180	5	16190.240.180
M12X50	10	16190.120.050				M24X200	5	16190.240.200
M12X60	10	16190.120.060	M20X50	5	16190.200.050			
M12X70	10	16190.120.070	M20X60	5	16190.200.060	M30X90	3	16190.300.090
M12X80	10	16190.120.080	M20X70	5	16190.200.070	M30X100	3	16190.300.100
M12X90	10	16190.120.090	M20X80	5	16190.200.080	M30X110	3	16190.300.110
M12X100	10	16190.120.100	M20X90	5	16190.200.090	M30X120	3	16190.300.120
M12X110	10	16190.120.110	M20X100	5	16190.200.100	M30X130	3	16190.300.130
M12X120	10	16190.120.120	M20X110	5	16190.200.110	M30X140	3	16190.300.140
M12X140	10	16190.120.140	M20X120	5	16190.200.120	M30X160	3	16190.300.160
M12X160	10	16190.120.160	M20X140	5	16190.200.140	M30X200	3	16190.300.200
			M20X160	5	16190.200.160	M30X260	3	16190.300.260

55782 T-Head bolt with square neck

R49A

Thread Metric thread
Material Stainless steel A4

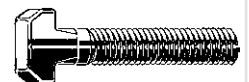

d x L	☒	Art.number	d x L	☒	Art.number	d x L	☒	Art.number
M8X30	10	55782.080.030	M10X70	10	55782.100.070	M16X50	5	55782.160.050
M8X40	10	55782.080.040				M16X70	5	55782.160.070
M8X50	10	55782.080.050	M12X40	5	55782.120.040	M16X80	5	55782.160.080
M8X60	10	55782.080.060	M12X60	5	55782.120.060	M16X100	5	55782.160.100
			M12X70	5	55782.120.070			
M10X30	10	55782.100.030	M12X90	5	55782.120.090	M20X70	3	55782.200.070
M10X40	10	55782.100.040	M12X100	5	55782.120.100	M20X100	3	55782.200.100
M10X50	10	55782.100.050						

T-head bolt type 28/15

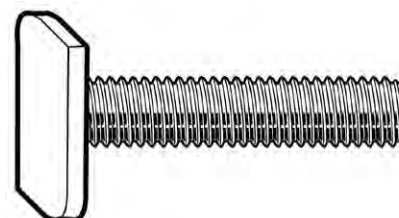
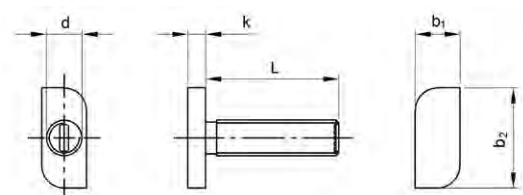

Technical Data

Type	b ₁	b ₂	k
M8	10	22.5	4
M10	10	22.5	4.5

Article groups

Thread	Material	Code	Page
M	St.St. A2	51740	5-3
M	St.St. A4	55740	5-3

51740 T-head bolt type 28/15

R09A

Thread Metric thread
Material Stainless steel A2

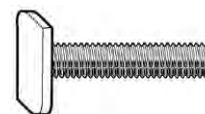

d x L	☒	Art.number	d x L	☒	Art.number	d x L	☒	Art.number
M8X16*	100	51740.080.016	M8X53*	100	51740.080.053	M10X35*	100	51740.100.035
M8X20*	100	51740.080.020	M8X60*	100	51740.080.060	M10X40*	100	51740.100.040
M8X25*	100	51740.080.025	M8X65*	100	51740.080.065	M10X50*	100	51740.100.050
M8X30*	100	51740.080.030	M8X70*	100	51740.080.070	M10X60*	100	51740.100.060
M8X35*	100	51740.080.035	M10X20*	100	51740.100.020	M10X70*	100	51740.100.070
M8X40*	100	51740.080.040	M10X25*	100	51740.100.025	M10X80*	100	51740.100.080
M8X45*	100	51740.080.045	M10X30*	100	51740.100.030	M10X50*	100	51740.100.100
M8X50*	100	51740.080.050						

55740 T-head bolt type 28/15

R09A

Thread Metric thread
Material Stainless steel A4

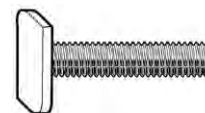

d x L	☒	Art.number	d x L	☒	Art.number	d x L	☒	Art.number
M8X30*	100	55740.080.030	M10X25*	100	55740.100.025	M10X30*	100	55740.100.030
M10X20*	100	55740.100.020						

Eye bolt

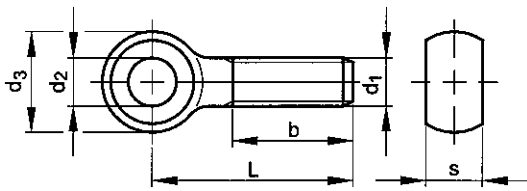

DIN 444 B
NEN 2310 B

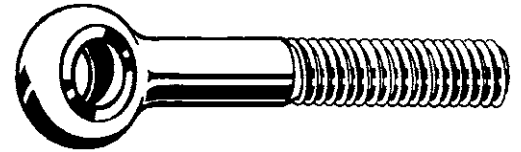

Technical Data

d ₁	b (min.): L≤125mm	b (min.): 125mm<L≤200mm	b (min.): L>200mm	d ₂ (H9)	d ₃ (max.)	P	s (max.)
M6	18	-	-	6	14	1	7
M8	22	28	-	8	18	1.25	9
M10	26	32	-	10	20	1.5	12
M12	30	36	49	12	25	1.75	14
M16	38	44	57	16	32	2	17
M20	46	52	65	18	40	2.5	22
M24	54	60	73	22	45	3	25
M27	60	66	79	25	50	3	27
M30	66	72	85	28	55	3.5	30

Article groups

Thread	Material	Class	Code	Page
M	St	4.6	16180	5-4
M	St.St. A2	50	51790	5-5
M	St.St. A4	50	55790	5-5

16180 Eye bolt

F11D

Thread Metric thread
Material Steel
Class 4.6



d ₁ x L	Art.number	d ₁ x L	Art.number	d ₁ x L	Art.number
M6X30	16180.060.030	M12X60	16180.120.060	M20X140	16180.200.140
M6X40	16180.060.040	M12X70	16180.120.070	M20X150	16180.200.150
M6X50	16180.060.050	M12X80	16180.120.080	M20X160	16180.200.160
M6X60	16180.060.060	M12X90	16180.120.090	M20X180	16180.200.180
M6X70	16180.060.070	M12X100	16180.120.100	M20X200	16180.200.200
M6X80	16180.060.080	M12X110	16180.120.110	M20X260	16180.200.260
M8X40	16180.080.040	M12X120	16180.120.120	M24X80	16180.240.080
M8X45	16180.080.045	M12X130	16180.120.130	M24X100	16180.240.100
M8X50	16180.080.050	M12X140	16180.120.140	M24X110	16180.240.110
M8X60	16180.080.060	M12X150	16180.120.150	M24X120	16180.240.120
M8X70	16180.080.070	M16X60	16180.160.060	M24X130	16180.240.130
M8X80	16180.080.080	M16X70	16180.160.070	M24X140	16180.240.140
M8X90	16180.080.090	M16X80	16180.160.080	M24X150	16180.240.150
M8X100	16180.080.100	M16X90	16180.160.090	M24X160	16180.240.160
M8X110	16180.080.110	M16X100	16180.160.100	M24X180	16180.240.180
M8X120	16180.080.120	M16X110	16180.160.110	M24X200	16180.240.200
M8X130	16180.080.130	M16X120	16180.160.120	M24X220	16180.240.220
M8X140	16180.080.140	M16X130	16180.160.130	M27X120	16180.270.120
M10X40	16180.100.040	M16X140	16180.160.140	M27X140	16180.270.140
M10X50	16180.100.050	M16X150	16180.160.150	M27X160	16180.270.160
M10X60	16180.100.060	M16X160	16180.160.160	M27X180	16180.270.180
M10X65	16180.100.065	M16X180	16180.160.180	M27X200	16180.270.200
M10X70	16180.100.070	M16X200	16180.160.200	M30X120	16180.300.120
M10X80	16180.100.080	M20X60	16180.200.060	M30X140	16180.300.140
M10X90	16180.100.090	M20X80	16180.200.080	M30X160	16180.300.160
M10X100	16180.100.100	M20X100	16180.200.100	M30X180	16180.300.180
M10X110	16180.100.110	M20X110	16180.200.110	M30X200	16180.300.200
M10X120	16180.100.120	M20X120	16180.200.120		
M10X130	16180.100.130	M20X130	16180.200.130		
M10X140	16180.100.140				

51790		Eye bolt		R09A	
Thread	Metric thread	Material	Stainless steel A2		
Class	50				

d₁ x L	☒	Art.number	d₁ x L	☒	Art.number	d₁ x L	☒	Art.number
M6X30	10	51790.060.030	M10X80	10	51790.100.080	M16X160	3	51790.160.160
M6X35	10	51790.060.035	M10X90	10	51790.100.090	M16X180	3	51790.160.180
M6X40	10	51790.060.040	M10X100	10	51790.100.100	M16X200	3	51790.160.200
M6X45	10	51790.060.045	M10X110	5	51790.100.110			
M6X50	10	51790.060.050	M10X120	5	51790.100.120	M20X70*	10	51790.200.070
M6X55	10	51790.060.055	M10X130	5	51790.100.130	M20X75	2	51790.200.075
M6X60	10	51790.060.060	M10X140	5	51790.100.140	M20X80	2	51790.200.080
M6X70	10	51790.060.070				M20X90	2	51790.200.090
M6X80	10	51790.060.080	M12X50	5	51790.120.050	M20X100	2	51790.200.100
			M12X55	5	51790.120.055	M20X110	2	51790.200.110
M8X30	10	51790.080.030	M12X60	5	51790.120.060	M20X120	2	51790.200.120
M8X35	10	51790.080.035	M12X65	5	51790.120.065	M20X130	2	51790.200.130
M8X40	10	51790.080.040	M12X70	5	51790.120.070	M20X140	2	51790.200.140
M8X45	10	51790.080.045	M12X75	5	51790.120.075	M20X150	1	51790.200.150
M8X50	10	51790.080.050	M12X80	5	51790.120.080	M20X160	1	51790.200.160
M8X55	10	51790.080.055	M12X90	5	51790.120.090	M20X180	1	51790.200.180
M8X60	10	51790.080.060	M12X100	5	51790.120.100	M20X200	1	51790.200.200
M8X65*	50	51790.080.065	M12X110	3	51790.120.110			
M8X70	10	51790.080.070	M12X120	3	51790.120.120	M24X80	3	51790.240.080
M8X75	10	51790.080.075	M12X130	3	51790.120.130	M24X90	3	51790.240.090
M8X80	10	51790.080.080	M12X140	3	51790.120.140	M24X100*	10	51790.240.100
M8X90	10	51790.080.090	M12X150	3	51790.120.150	M24X110	3	51790.240.110
M8X100	10	51790.080.100				M24X120	3	51790.240.120
M8X110	5	51790.080.110	M16X60	5	51790.160.060	M24X130	3	51790.240.130
M8X120	5	51790.080.120	M16X65	5	51790.160.065	M24X140	3	51790.240.140
M8X140	5	51790.080.140	M16X70	5	51790.160.070	M24X150	3	51790.240.150
			M16X75*	25	51790.160.075	M24X180	3	51790.240.180
M10X40	10	51790.100.040	M16X80	5	51790.160.080	M24X200	3	51790.240.200
M10X45	10	51790.100.045	M16X90	5	51790.160.090	M24X220	3	51790.240.220
M10X50	10	51790.100.050	M16X100	5	51790.160.100			
M10X55	10	51790.100.055	M16X110	5	51790.160.110	M27X120	3	51790.270.120
M10X60	10	51790.100.060	M16X120	3	51790.160.120	M27X160	3	51790.270.160
M10X65	10	51790.100.065	M16X130	3	51790.160.130	M27X180	3	51790.270.180
M10X70	10	51790.100.070	M16X140	3	51790.160.140	M27X200	3	51790.270.200
M10X75	10	51790.100.075	M16X150	3	51790.160.150			

5

55790		Eye bolt		R49A	
Thread	Metric thread	Material	Stainless steel A4		
Class	50				

d₁ x L	☒	Art.number	d₁ x L	☒	Art.number	d₁ x L	☒	Art.number
M6X30	10	55790.060.030	M10X70	10	55790.100.070	M16X90	5	55790.160.090
M6X35*	50	55790.060.035	M10X75*	25	55790.100.075	M16X100	5	55790.160.100
M6X40	10	55790.060.040	M10X80	10	55790.100.080	M16X110*	25	55790.160.110
M6X45*	50	55790.060.045	M10X90	10	55790.100.090	M16X120	3	55790.160.120
M6X50	10	55790.060.050	M10X100	10	55790.100.100	M16X130	3	55790.160.130
M6X55*	50	55790.060.055	M10X110*	25	55790.100.110	M16X140*	10	55790.160.140
M6X60*	50	55790.060.060	M10X120*	25	55790.100.120	M16X150*	10	55790.160.150
M8X30	10	55790.080.030	M12X50	5	55790.120.050	M20X70*	10	55790.200.070
M8X35*	50	55790.080.035	M12X55*	25	55790.120.055	M20X75*	10	55790.200.075
M8X40	10	55790.080.040	M12X60	5	55790.120.060	M20X80	2	55790.200.080
M8X45*	50	55790.080.045	M12X65*	25	55790.120.065	M20X90	2	55790.200.090
M8X50	10	55790.080.050	M12X70	5	55790.120.070	M20X100	2	55790.200.100
M8X55*	50	55790.080.055	M12X75*	25	55790.120.075	M20X110*	10	55790.200.110
M8X60	10	55790.080.060	M12X80	5	55790.120.080	M20X120	2	55790.200.120
M8X65*	50	55790.080.065	M12X90	5	55790.120.090	M20X130*	10	55790.200.130
M8X70	10	55790.080.070	M12X100	5	55790.120.100	M20X140*	10	55790.200.140
M8X75*	50	55790.080.075	M12X110*	25	55790.120.110	M20X150*	10	55790.200.150
M8X80	10	55790.080.080	M12X120	3	55790.120.120	M20X180	1	55790.200.180
M8X90	10	55790.080.090	M12X130*	25	55790.120.130			
M8X100	10	55790.080.100	M12X140*	10	55790.120.140	M24X80*	10	55790.240.080
			M12X150*	10	55790.120.150	M24X90*	10	55790.240.090
M10X40	10	55790.100.040				M24X100	3	55790.240.100
M10X45*	25	55790.100.045	M16X60*	25	55790.160.060	M24X110*	10	55790.240.110
M10X50	10	55790.100.050	M16X65*	25	55790.160.065	M24X120	3	55790.240.120
M10X55*	25	55790.100.055	M16X70	5	55790.160.070	M24X130*	10	55790.240.130
M10X60	10	55790.100.060	M16X75*	25	55790.160.075	M24X140	3	55790.240.140
M10X65*	25	55790.100.065	M16X80	5	55790.160.080	M24X150*	10	55790.240.150

55790	Eye bolt	←
d₁ x L	☒ Art.number	
M24X220	10 55790.240.220	

Eye bolt fully threaded

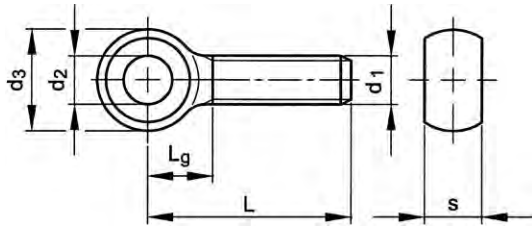



DIN 444 LB
NEN 2310 B



Technical Data

d ₁	d ₂ (H9)	d ₃ (max.)	Lg (max.)	P	s (max.)
M5	5	12	11	0.8	6
M6	6	14	14	1	7
M8	8	18	16	1.25	9
M10	10	20	18	1.5	12
M12	12	25	23	1.75	14
M16	16	32	27	2	17
M20	18	40	32	2.5	22

5

16182	Eye bolt fully threaded	F11D
Thread	Metric thread	
Material	Steel	
Class	4.6	
Surface treatment	Zinc plated	
		 

d ₁ x L	☒	Art.number	d ₁ x L	☒	Art.number	d ₁ x L	☒	Art.number
M5X25	50	16182.050.025	M10X75	25	16182.100.075	M16X90	10	16182.160.090
M5X35	50	16182.050.035	M10X80	25	16182.100.080	M16X100	10	16182.160.100
			M10X100	25	16182.100.100	M16X110	10	16182.160.110
M6X30	25	16182.060.030	M10X120	25	16182.100.120	M16X120	10	16182.160.120
M6X40	25	16182.060.040	M10X140	25	16182.100.140	M16X140	10	16182.160.140
M6X50	25	16182.060.050				M16X160	10	16182.160.160
			M12X60	10	16182.120.060	M16X180	10	16182.160.180
M8X40	25	16182.080.040	M12X70	10	16182.120.070	M16X200	10	16182.160.200
M8X50	25	16182.080.050	M12X80	10	16182.120.080			
M8X60	25	16182.080.060	M12X100	10	16182.120.100	M20X100	5	16182.200.100
M8X80	25	16182.080.080	M12X110	10	16182.120.110	M20X120	5	16182.200.120
			M12X120	10	16182.120.120	M20X140	5	16182.200.140
M10X40	25	16182.100.040	M12X140	10	16182.120.140	M20X150	5	16182.200.150
M10X50	25	16182.100.050				M20X160	5	16182.200.160
M10X60	25	16182.100.060	M16X70	10	16182.160.070	M20X180	5	16182.200.180
M10X70	25	16182.100.070	M16X80	10	16182.160.080	M20X200	5	16182.200.200

Lifting eye bolt with CE marking

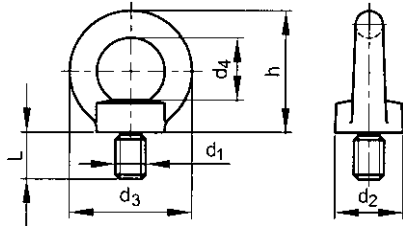

DIN 580
ISO 3266
NEN 1927
BS 4278

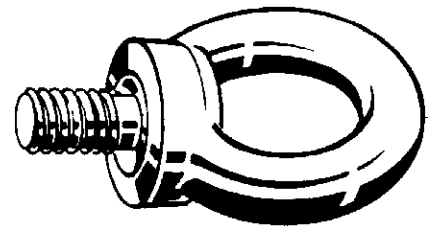

Technical Data

d ₁	d ₂	d ₃	d ₄	h	L	P
M6 (#DIN)	20	36	20	36	13	1
M8	20	36	20	36	13	1.25
M10	25	45	25	45	17	1.5
M12	30	54	30	53	20.5	1.75
M14 (#DIN)	30	54	30	53	20.5	2
M16	35	63	35	62	27	2
M18 (#DIN)	35	63	35	62	27	2.5
M20	40	72	40	71	30	2.5
M22 (#DIN)	40	72	40	71	30	2.5
M24	50	90	50	90	36	3
M27 (#DIN)	50	90	50	90	36	3
M30	65	108	60	109	45	3.5
M33 (#DIN)	65	108	60	109	45	3.5
M36	75	126	70	128	54	4
M39 (#DIN)	75	126	70	128	54	4
M42	85	144	80	147	63	4.5
M45 (#DIN)	85	144	80	147	63	4.5
M48	100	166	90	168	68	5
M52 (#DIN)	110	184	100	187	78	5
M56	110	184	100	187	78	5.5
M64	120	206	110	208	90	6
M72x6	150	260	140	260	100	6

- If lifting eye bolts form part of lifting equipment, CE marking is necessary.
- Lifting eye bolt do not require CE marking if not used for lifting (as towing eyes for example) or is only used once for lifting (such as for moving machines).



Maximum load L (N)

		M6	M8	M10	M12	M14	M16	M18	M20	M22	M24	M27
1 x bolt		900	1400	2300	3400	5000	7000	9300	12000	15000	18000	25000
2 x bolt		600	1000	1700	2400	3500	5000	6500	8600	10500	12900	18300

		M30	M33	M36	M39	M42	M45	M48	M52	M56	M64	M72x6
1 x bolt		32000	42000	46000	60000	63000	78000	86000	99000	115000	160000	200000
2 x bolt		23000	30500	33000	44000	45000	55000	61000	71000	82000	110000	140000

Article groups

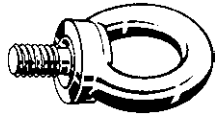

Thread	Material	Class	Surface treatment	Code	Page
M	St C15E			16000	5-8
M	St C15E		Zipl	16010	5-8
M	St.St. A2			51940	5-8
M	St.St. A2	50		51941	5-8
M	St.St. A4			55940	5-8
M	St.St. A4	50		55941	5-9

16000	Lifting eye bolt with CE marking						F11E
Thread	Metric thread						
Material	Steel C15E						
CE							
							
							

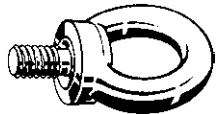

d ₁	☒	Art.number	d ₁	☒	Art.number	d ₁	☒	Art.number
M6	25	16000.060.001	M20	10	16000.200.001	M39	1	16000.390.001
M8	25	16000.080.001	M22	5	16000.220.001	M42	1	16000.420.001
M10	25	16000.100.001	M24	5	16000.240.001	M48	1	16000.480.001
M12	25	16000.120.001	M27	5	16000.270.001	M56	1	16000.560.001
M14	10	16000.140.001	M30	1	16000.300.001	M64	1	16000.640.001
M16	10	16000.160.001	M33	1	16000.330.001			
M18	10	16000.180.001	M36	1	16000.360.001	M72X6,00	1	16000.720.001

16010	Lifting eye bolt with CE marking						F11E
Thread	Metric thread						
Material	Steel C15E						
Surface treatment	Zinc plated						
CE							
							
							

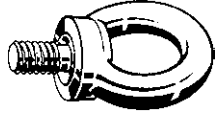

d ₁	☒	Art.number	d ₁	☒	Art.number	d ₁	☒	Art.number
M6	25	16010.060.001	M20	10	16010.200.001	M39	1	16010.390.001
M8	25	16010.080.001	M22	5	16010.220.001	M42	1	16010.420.001
M10	25	16010.100.001	M24	5	16010.240.001	M45	1	16010.450.001
M12	25	16010.120.001	M27	5	16010.270.001	M48	1	16010.480.001
M14	10	16010.140.001	M30	1	16010.300.001	M52	1	16010.520.001
M16	10	16010.160.001	M33	1	16010.330.001	M56	1	16010.560.001
M18	10	16010.180.001	M36	1	16010.360.001	M64	1	16010.640.001

51940	Lifting eye bolt cast						R09A
Thread	Metric thread		DIN	#580			
Material	Stainless steel A2						
							
							

d ₁	☒	Art.number	d ₁	☒	Art.number	d ₁	☒	Art.number
M6	10	51940.060.001	M16	5	51940.160.001	M27	3	51940.270.001
M8	10	51940.080.001	M20	5	51940.200.001	M30	1	51940.300.001
M10	10	51940.100.001	M24	3	51940.240.001	M36*	1	51940.360.001
M12	10	51940.120.001						

51941	Lifting eye bolt forged						R09A
Thread	Metric thread						
Material	Stainless steel A2						
Class	50						
CE							
							
							

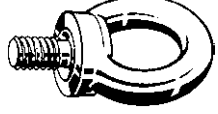
d ₁	☒	Art.number	d ₁	☒	Art.number	d ₁	☒	Art.number
M6*	25	51941.060.001	M16*	10	51941.160.001	M27*	5	51941.270.001
M8*	25	51941.080.001	M20*	10	51941.200.001	M30*	5	51941.300.001
M10*	25	51941.100.001	M24*	5	51941.240.001	M36*	1	51941.360.001
M12*	10	51941.120.001						

55940	Lifting eye bolt cast						R49A
Thread	Metric thread		DIN	#580			
Material	Stainless steel A4						
							
							

d ₁	☒	Art.number	d ₁	☒	Art.number	d ₁	☒	Art.number
M6	10	55940.060.001	M16	5	55940.160.001	M27	3	55940.270.001
M8	10	55940.080.001	M20	5	55940.200.001	M30	1	55940.300.001
M10	10	55940.100.001	M24	3	55940.240.001	M36*	1	55940.360.001
M12	10	55940.120.001						

55941	Lifting eye bolt forged	R49A
Thread	Metric thread	
Material	Stainless steel A4	
Class	50	

d_1	☒	Art.number	d_1	☒	Art.number	d_1	☒	Art.number
M6*	25	55941.060.001	M16*	10	55941.160.001	M27*	5	55941.270.001
M8*	25	55941.080.001	M20*	10	55941.200.001	M30*	5	55941.300.001
M10*	25	55941.100.001	M24*	5	55941.240.001	M36*	1	55941.360.001
M12*	10	55941.120.001						

Lifting eye bolt Non-Metric

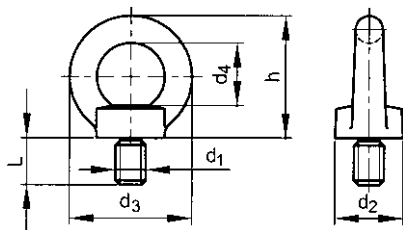

DIN ≈580 (1957)
NEN ≈2347 (1960)

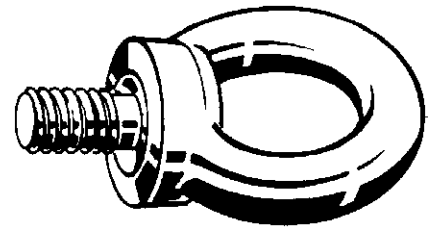

5

Technical Data						
d_1	d_2	d_3	d_4	h	L	Threads per inch
5/16	20	36	20	36	13	18
3/8	25	45	25	45	17	16
1/2	30	54	30	53	22	12
5/8	35	63	35	62	27	11
3/4	40	72	40	71	30	10
7/8	45	81	45	81	35	9
1 Inch	50	90	50	90	36	8
1.1/4	65	108	60	109	45	7
1.1/2	75	126	70	128	55	6
1.3/4	100	166	90	168	70	5
2 Inch	100	166	90	168	70	4.5

- Whitworth thread (BSW) is not internationally recommended. It is advised to use metric (M).
- C15 material has been standardised and has a minimum impact strength of 80 Joule (ISO-testpiece) resp. 90 Joule (DIN-testpiece).

Maximum load (N)

		5/16	3/8	1/2	5/8	3/4	7/8	1.IN.	1.1/4	1.1/2	1.3/4	2.IN.
1 x bolt		1400	2300	3400	7000	12000	18000	18000	46000	63000	86000	115000
2 x bolt		1000	1700	2400	5000	8600	12900	12900	33000	45000	61000	82000

16040	Lifting eye bolt Non-Metric	X08A
Thread	British Standard Whitworth	
Material	Steel C15	

d_1	☒	Art.number	d_1	☒	Art.number	d_1	☒	Art.number
5/16	25	16040.079.001	3/4	10	16040.191.001	1.1/2	1	16040.381.001
3/8	25	16040.096.001	7/8	5	16040.222.001	1.3/4	1	16040.444.001
1/2	25	16040.127.001	1 Inch	5	16040.254.001	2 Inch	1	16040.508.001
5/8	10	16040.158.001	1.1/4	1	16040.317.001			

Lifting eye nut with CE marking

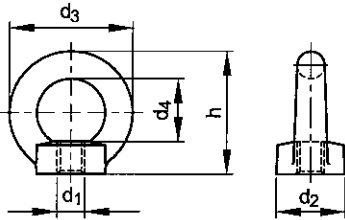

DIN 582
NEN 1928

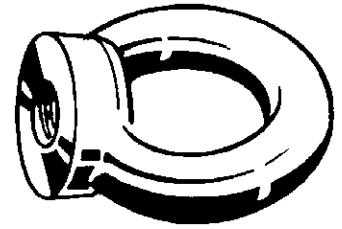

Technical Data

d ₁	d ₂	d ₃	d ₄	h	P
M6 (#DIN)	20	36	20	36	1
M8	20	36	20	36	1.25
M10	25	45	25	45	1.5
M12	30	54	30	53	1.75
M14 (#DIN)	30	54	30	53	2
M16	35	63	35	62	2
M18 (#DIN)	35	63	35	62	2.5
M20	40	72	40	71	2.5
M22 (#DIN)	40	72	40	71	2.5
M24	50	90	50	90	3
M27 (#DIN)	65	108	60	109	3
M30	65	108	60	109	3.5
M33 (#DIN)	65	108	60	109	3.5
M36	75	126	70	128	4
M39 (#DIN)	75	126	70	128	4
M42	85	144	80	147	4.5
M48	100	166	90	168	5
M56	110	184	100	187	5.5
M64	120	206	110	208	6
M72x6	150	260	140	260	6

- If lifting eye nuts form part of lifting equipment, CE marking is necessary.
- Lifting eye nuts do not require CE marking if not used for lifting (as towing eyes for example).

Maximum load L (N)

		M6	M8	M10	M12	M14	M16	M18	M20	M22	M24	M27
1 x nut		900	1400	2300	3400	5000	7000	9300	12000	15000	18000	25000
2 x nut		600	1000	1700	2400	3500	5000	6500	8600	10500	12900	18300

		M30	M33	M36	M39	M42	M45	M48	M52	M56	M64	M72x6
1 x nut		32000	42000	46000	60000	63000	78000	86000	99000	115000	160000	200000
2 x nut		23000	30500	33000	44000	45000	55000	61000	71000	82000	110000	140000

Article groups

Thread	Material	Class	Surface treatment	Code	Page
M	St C15E			16100	5-11
M	St C15E		Zipl	16110	5-11
M	St.St. A2	50		forged 51950	5-11
M	St.St. A2			cast 51951	5-11
M	St.St. A4	50		forged 55950	5-11
M	St.St. A4			cast 55951	5-12

16100 Lifting eye nut with CE marking F11E

Thread Metric thread
Material Steel C15E

CE

d ₁	☒	Art.number	d ₁	☒	Art.number	d ₁	☒	Art.number
M6	25	16100.060.001	M20	10	16100.200.001	M39	1	16100.390.001
M8	25	16100.080.001	M22	5	16100.220.001	M42	1	16100.420.001
M10	25	16100.100.001	M24	5	16100.240.001	M48	1	16100.480.001
M12	25	16100.120.001	M27	5	16100.270.001	M56	1	16100.560.001
M14	10	16100.140.001	M30	1	16100.300.001	M64	1	16100.640.001
M16	10	16100.160.001	M33	1	16100.330.001			
M18	10	16100.180.001	M36	1	16100.360.001	M72X6,00	1	16100.720.001

16110 Lifting eye nut with CE marking F11E

Thread Metric thread
Material Steel C15E
Surface treatment Zinc plated

CE

d ₁	☒	Art.number	d ₁	☒	Art.number	d ₁	☒	Art.number
M6	25	16110.060.001	M20	10	16110.200.001	M36	1	16110.360.001
M8	25	16110.080.001	M22	5	16110.220.001	M39	1	16110.390.001
M10	25	16110.100.001	M24	5	16110.240.001	M42	1	16110.420.001
M12	25	16110.120.001	M27	5	16110.270.001	M48	1	16110.480.001
M14	10	16110.140.001	M30	1	16110.300.001	M56	1	16110.560.001
M16	10	16110.160.001	M33	1	16110.330.001	M64	1	16110.640.001
M18	10	16110.180.001						

51950 Lifting eye nut forged R09A

Thread Metric thread
Material Stainless steel A2
Class 50

CE

d ₁	☒	Art.number	d ₁	☒	Art.number	d ₁	☒	Art.number
M6	10	51950.060.001	M16	5	51950.160.001	M27*	5	51950.270.001
M8	10	51950.080.001	M20	5	51950.200.001	M30*	5	51950.300.001
M10	10	51950.100.001	M24	3	51950.240.001	M36*	1	51950.360.001
M12	10	51950.120.001						

51951 Lifting eye nut cast R09A

Thread Metric thread
Material Stainless steel A2
DIN #582

CE

d ₁	☒	Art.number	d ₁	☒	Art.number	d ₁	☒	Art.number
M6*	25	51951.060.001	M16*	10	51951.160.001	M27*	5	51951.270.001
M8*	25	51951.080.001	M20*	10	51951.200.001	M30*	5	51951.300.001
M10*	25	51951.100.001	M24*	5	51951.240.001	M36*	1	51951.360.001
M12*	10	51951.120.001						

55950 Lifting eye nut forged R49A

Thread Metric thread
Material Stainless steel A4
Class 50

CE

d ₁	☒	Art.number	d ₁	☒	Art.number	d ₁	☒	Art.number
M6*	25	55950.060.001	M12	10	55950.120.001	M24	3	55950.240.001
M8	10	55950.080.001	M16	5	55950.160.001	M27*	5	55950.270.001
M10	10	55950.100.001	M20	5	55950.200.001	M36*	1	55950.360.001

55951 Lifting eye nut cast R49A

Thread: Metric thread
Material: Stainless steel A4
DIN #582

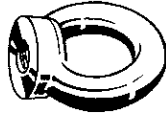

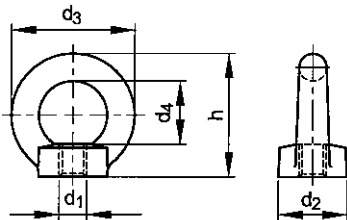

d ₁	☒	Art.number	d ₁	☒	Art.number	d ₁	☒	Art.number
M6*	25	55951.060.001	M16*	10	55951.160.001	M27*	5	55951.270.001
M8*	25	55951.080.001	M20*	10	55951.200.001	M30*	5	55951.300.001
M10*	25	55951.100.001	M24*	5	55951.240.001	M36*	1	55951.360.001
M12*	10	55951.120.001						

Lifting eye nut

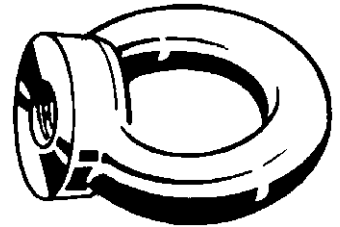

DIN ≈582 (1957)
NEN ≈2348 (1960)



5

Technical Data

d ₁	d ₂	d ₃	d ₄	h	Threads per inch
5/16	20	36	20	36	18
3/8	25	45	25	45	16
1/2	30	54	30	53	12
5/8	35	63	35	62	11
3/4	40	72	40	71	10
7/8	45	81	45	81	9
1 Inch	50	90	50	90	8
1.1/4	65	108	60	109	7
1.1/2	75	126	70	128	6
1.3/4	85	144	80	147	5
2 Inch	100	166	90	168	4.5

- Whitworth thread (BSW) is not internationally recommended.
- It is advised to use metric (M).

Maximum load (N)

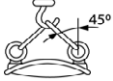
		5/16	3/8	1/2	5/8	3/4	7/8	1.IN.	1.1/4	1.1/2	1.3/4	2.IN.
1 x nut		1400	2300	3400	7000	12000	18000	18000	46000	63000	86000	115000
2 x nut		1000	1700	2400	5000	8600	12900	12900	33000	45000	61000	82000

16140 Lifting eye nut X08A

Thread: British Standard Whitworth
Material: Steel C15



d ₁	☒	Art.number	d ₁	☒	Art.number	d ₁	☒	Art.number
5/16	25	16140.079.001	5/8	10	16140.158.001	1 Inch	5	16140.254.001
3/8	25	16140.096.001	3/4	10	16140.191.001	1.1/4	1	16140.317.001
1/2	25	16140.127.001	7/8	5	16140.222.001	1.1/2	1	16140.381.001

Turnbuckle made from tube

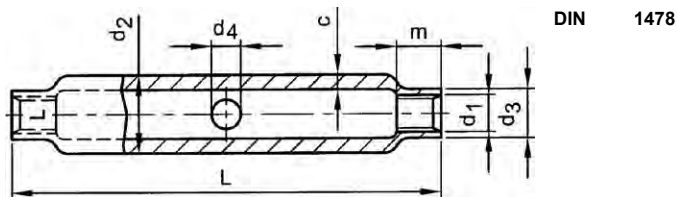

DIN 1478



Technical Data

d_1	Adjustable	c	d_2 (min.)	d_3	d_4	L	m	P
M6	90	2.9	17.2	9	6	110	7.5	1
M8	85	3.6	17.2	12	8	110	10	1.25
M10	95	4	21.3	15	8	125	12	1.5
M12	90	4	25	18	10	125	15	1.75
M16	120	4.5	30	24	10	170	20	2
M20	140	5	33.7	30	12	200	24	2.5
M24	180	5.6	42.4	33	12	255	29	3

16151 Turnbuckle made from tube

F11F

Thread Metric thread
Material Steel
Surface treatment Zinc plated



d_1	☒	Art.number	d_1	☒	Art.number	d_1	☒	Art.number
M6	10	16151.060.001	M12	5	16151.120.001	M20	2	16151.200.001
M8	10	16151.080.001	M16	5	16151.160.001	M24	2	16151.240.001
M10	5	16151.100.001						

Hexagon turnbuckle

DIN ≈1479

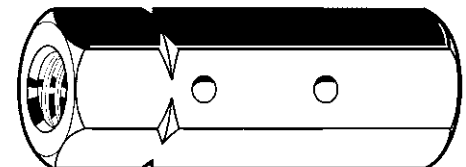
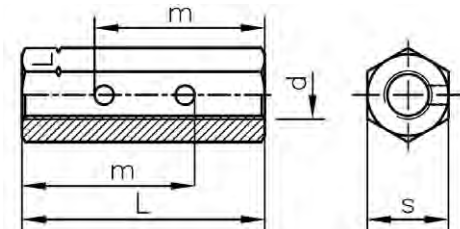

Technical Data

d	Adjustable	L	m	P	s
M6	15	30	22.5	1	10
M8	15	35	25	1.25	13
M10	21	45	33	1.5	16
M12	25	55	40	1.75	18
M16	35	75	55	2	24
M20	47	95	24	2.5	30
M24	57	115	29	3	36

16153 Hexagon turnbuckle

F11F

Thread Metric thread
Material Steel Min.330N/mm²
Surface treatment Zinc plated



d	☒	Art.number	d	☒	Art.number	d	☒	Art.number
M6	10	16153.060.001	M12	5	16153.120.001	M20	2	16153.200.001
M8	10	16153.080.001	M16	5	16153.160.001	M24	2	16153.240.001
M10	5	16153.100.001						

Turnbuckle

DIN 1480

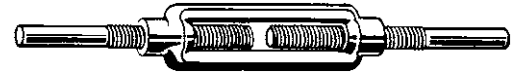
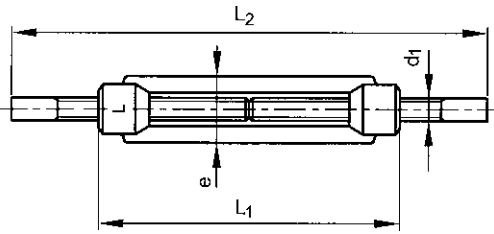

Technical Data

d ₁	e	L ₁	L ₂ (min.)	L ₂ (max.)	P	Allowable load (N)
M6	19	110	240	338	1	2250
M8	23	110	240	338	1.25	4100
M10	30	125	300	407	1.5	6500
M12	34	125	300	407	1.75	9300
M16	42	170	400	543	2	17700
M20	52	200	440	606	2.5	27000
M24	60	255	520	736	3	39200
M30	74	255	520	736	3.5	62500
M36	86	295	600	840	4	91000
M42	104	330	700	967	4.5	125000
M48	135	355	760	1.037	5	165000
M56	135	355	820	1.097	5.5	230000

5

16160 Turnbuckle with two studs for welding made from weldable steel class 3.6

F11F

Thread Metric thread
Material Steel Min.330N/mm²



d ₁	☒	Art.number	d ₁	☒	Art.number	d ₁	☒	Art.number
M6	10	16160.060.001	M16	5	16160.160.001	M36	1	16160.360.001
M8	10	16160.080.001	M20	2	16160.200.001	M42	1	16160.420.001
M10	5	16160.100.001	M24	2	16160.240.001	M48	1	16160.480.001
M12	5	16160.120.001	M30	2	16160.300.001	M56	1	16160.560.001

Turnbuckle

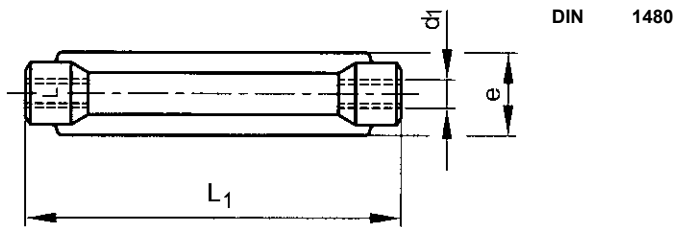

DIN 1480

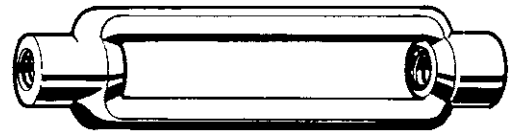

Technical Data

d_1	e	L_1	P	d_1	e	L_1	P
M6	19	110	1	M16	42	170	2
M8	23	110	1.25	M20	52	200	2.5
M10	30	125	1.5	M24	60	255	3
M12	34	125	1.75	M30	74	255	3.5

- The steel (min. tensile strength 330 N/mm²) turnbuckles are zinc plated or hot dip galvanized with ISO-metric mating thread, depending on availability this may deviate. Hooks and eyes are class 3.6 and always zinc plated.

16150 Turnbuckle		F11F
Thread	Metric thread	
Material	Steel Min.330N/mm ²	
Surface treatment	Zinc plated/Hot dip galvanized	

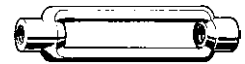

d_1	☒	Art.number	d_1	☒	Art.number	d_1	☒	Art.number
M6 ZINC	10	16150.060.001	M12 ZINC	5	16150.120.001	M24 HOT D.G.	2	16150.240.001
M8 ZINC	10	16150.080.001	M16 HOT D.G.	5	16150.160.001	M30 HOT D.G.	2	16150.300.001
M10 ZINC	5	16150.100.001	M20 HOT D.G.	2	16150.200.001			

Turnbuckle with hook and eye

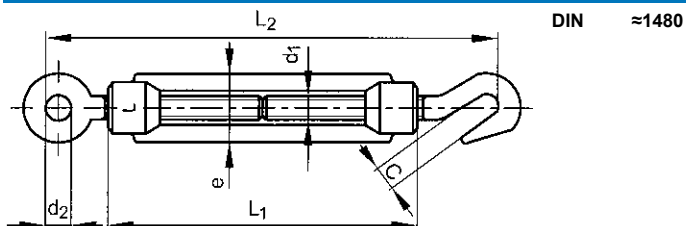

DIN ≈1480

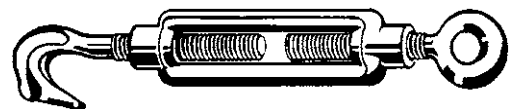

Technical Data

d_1	c	d_2	e	L_1	L_2 (min.)	L_2 (max.)	P	Allowable load (N)
M6	8	10	19	110	150	234	1	750
M8	10	11	23	110	161	245	1.25	1650
M10	13	14	30	125	188	285	1.5	2350
M12	17	17	34	125	208	305	1.75	3200
M16	16.5	23	42	170	299	433	2	5300
M20	17	25	52	200	341	495	2.5	7300
M24	23	34	60	255	394	594	3	15500
M30	29	38	74	255	441	635	3.5	22400

16170 Turnbuckle with hook and eye		F11F
Thread	Metric thread	
Material	Steel Min.330N/mm ²	
Surface treatment	Zinc plated/Hot dip galvanized	



d_1	☒	Art.number	d_1	☒	Art.number	d_1	☒	Art.number
M6 ZINC	10	16170.060.001	M12 ZINC	5	16170.120.001	M24 HOT D.G.	2	16170.240.001
M8 ZINC	10	16170.080.001	M16 HOT D.G.	5	16170.160.001	M30 HOT D.G.	2	16170.300.001
M10 ZINC	5	16170.100.001	M20 HOT D.G.	2	16170.200.001			

- The steel (min. tensile strength 330 N/mm²) turnbuckles are zinc plated or hot dip galvanized with ISO-metric mating thread, depending on availability this may deviate. Hooks and eyes are class 3.6 and always zinc plated.

Turnbuckle with hook and eye Stainless steel

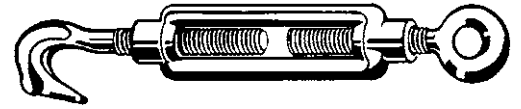
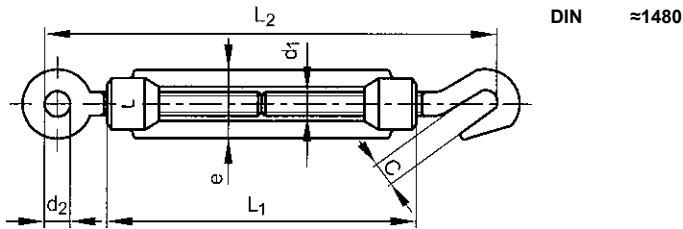

Technical Data

d ₁	c	d ₂	e	L ₁	L ₂ (min.)	L ₂ (max.)	P	Allowable load (N)
M6	10	10	18	90	140	220	1	750
M8	11	14	21	120	180	280	1.25	1650
M10	12	16	25	150	230	360	1.5	2350
M12	14	18	31	200	280	460	1.75	3200
M16	16	26	40	250	370	590	2	5300
M20	18	30	49	300	420	650	2.5	7300

5

51742 Turnbuckle with hook and eye Stainless steel

R09A

Thread Metric thread
Material Stainless steel A4



d ₁	☒	Art.number	d ₁	☒	Art.number	d ₁	☒	Art.number
M6	10	51742.060.001	M10	5	51742.100.001	M16	5	51742.160.001
M8	10	51742.080.001	M12	5	51742.120.001	M20	2	51742.200.001

Turnbuckle with two eyes

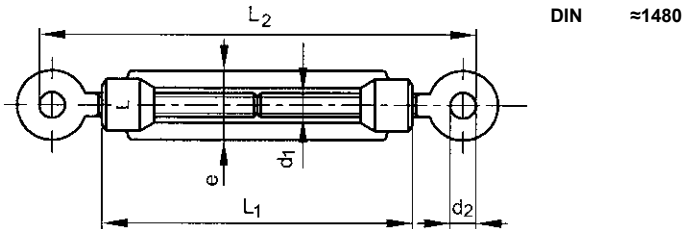

Technical Data

d ₁	d ₂	e	L ₁	L ₂ (min.)	L ₂ (max.)	P	Allowable load (N)
M5 (#DIN)	8	16.6	78.5	119	179	0.8	1400
M6	10	19	110	150	234	1	2250
M8	10	23	110	156	240	1.25	4100
M10	14	30	125	186	282	1.5	6500
M12	17	34	125	196	293	1.75	9300
M14 (#DIN)	17.6	38	140	234	344	2	13200
M16	23	42	170	294	428	2	17700
M20	25	52	200	352	506	2.5	27000
M24	34	60	235	391	589	3	39200
M30	38	74	255	441	636	3.5	62500

16177 Turnbuckle with two eyes

F11F

Thread Metric thread
Material Steel Min.330N/mm²
Surface treatment Zinc plated/Hot dip galvanized



d ₁	☒	Art.number	d ₁	☒	Art.number	d ₁	☒	Art.number
M5 = 3/16 ZINC	10	16177.050.001	M12 ZINC	5	16177.120.001	M20 HOT D.G.	2	16177.200.001
M6 ZINC	10	16177.060.001	M14 = 9/16 ZINC	5	16177.140.001	M24 HOT D.G.	2	16177.240.001
M8 ZINC	10	16177.080.001	M16 HOT D.G.	5	16177.160.001	M30 HOT D.G.	2	16177.300.001
M10 ZINC	5	16177.100.001						

16177 Turnbuckle with two eyes

- The steel (min. tensile strength 330 N/mm²) turnbuckles are zinc plated or hot dip galvanized with ISO-metric mating thread, depending on availability this may deviate. Hooks and eyes are class 3.6 and always zinc plated.

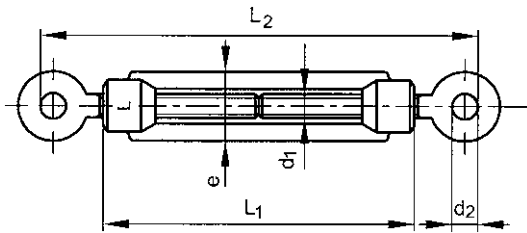
Turnbuckle with two eyes Stainless steel

DIN ≈1480

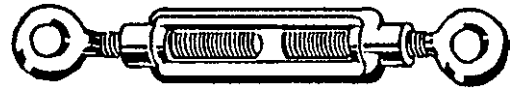
Technical Data

d ₁	d ₂	e	L ₁	L ₂ (min.)	L ₂ (max.)	P	Allowable load (N)
M6	10	18	90	140	220	1	2250
M8	14	21	120	180	280	1.25	4100
M10	16	25	150	230	360	1.5	6500
M12	18	31	200	280	460	1.75	9300
M16	26	40	250	370	590	2	17700
M20	30	49	300	420	650	2.5	27000

5

51744 Turnbuckle with two eyes Stainless steel

R09A

Thread Metric thread
Material Stainless steel A4



d ₁	✉	Art.number	d ₁	✉	Art.number	d ₁	✉	Art.number
M6	10	51744.060.001	M10	5	51744.100.001	M16	5	51744.160.001
M8	10	51744.080.001	M12	5	51744.120.001	M20	2	51744.200.001

Turnbuckle with two hooks

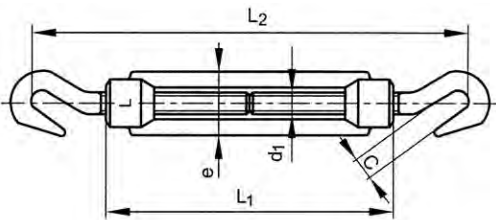

DIN ≈1480

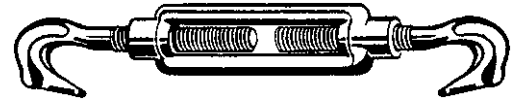

Technical Data

d ₁	c	e	L ₁	L ₂ (min.)	L ₂ (max.)	P	Allowable load (N)
M5 (#DIN)	7	16.5	70	107	157	0.8	500
M6	8	19	110	150	234	1	750
M8	10	23	110	166	250	1.25	1650
M10	13	30	125	189	289	1.5	2350
M12	17	34	125	220	317	1.75	3200
M16	16.5	42	170	304	438	2	5300

5

16178 Turnbuckle with two hooks F11F

Thread: Metric thread
 Material: Steel Min.330N/mm²
 Surface treatment: Zinc plated

d ₁	Art.number	d ₁	Art.number	d ₁	Art.number
M5 = 3/16	10 16178.050.001	M8	10 16178.080.001	M12	5 16178.120.001
M6	10 16178.060.001	M10	5 16178.100.001	M16 = 5/8	5 16178.160.001

The steel (min. tensile strength 330 N/mm²) turnbuckles are zinc plated or hot dip galvanized with ISO-metric mating thread, depending on availability this may deviate. Hooks and eyes are class 3.6 and always zinc plated.

Turnbuckle with two hooks Stainless steel

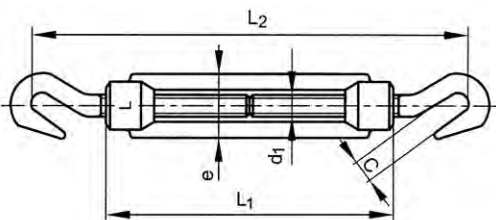

DIN ≈1480

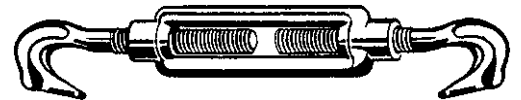

Technical Data

d ₁	c	e	L ₁	L ₂ (min.)	L ₂ (max.)	P	Allowable load (N)
M6	10	18	90	140	220	1	750
M8	11	21	120	180	280	1.25	1650
M10	12	25	150	230	360	1.5	2350
M12	14	31	200	280	460	1.75	3200
M16	16	40	250	370	590	2	5300
M20	18	49	300	420	650	2.5	7300

51743 Turnbuckle with two hooks Stainless steel R09A

Thread: Metric thread
 Material: Stainless steel A4

d ₁	Art.number	d ₁	Art.number	d ₁	Art.number
M6	10 51743.060.001	M10	5 51743.100.001	M16	5 51743.160.001
M8	10 51743.080.001	M12	5 51743.120.001	M20	2 51743.200.001

Turnbuckle with two flat eyes

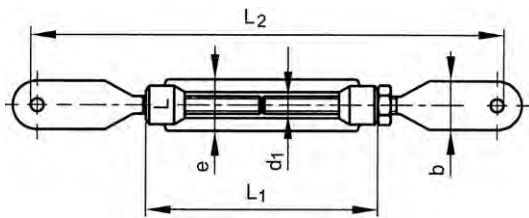

DIN ≈1480

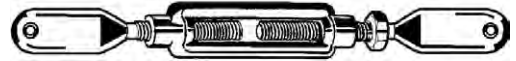

Technical Data

d ₁	b	e	L ₁	L ₂ (min.)	L ₂ (max.)	P	Thickness flat eyes	Allowable load (N)
M12	30	34	125	325	430	1.5	4	9300
M16	40	42	170	472	615	1.75	4	17700
M20	50	52	200	463	630	2	5	27000

16172 Turnbuckle with two flat eyes

F11F

Thread Metric thread
Material Steel Min.330N/mm²
Surface treatment Zinc plated



d ₁	Art.number	d ₁	Art.number	d ₁	Art.number
M12	5 16172.120.001	M16	5 16172.160.001	M20	2 16172.200.001

- The steel (min. tensile strength 330 N/mm²) turnbuckles are zinc plated or hot dip galvanized with ISO-metric mating thread, depending on availability this may deviate. Eyes are class 3.6 and always zinc plated.

D (chain) shackle

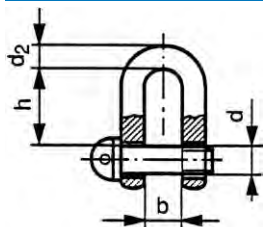

DIN ≈82101 A
 NEN ≈964

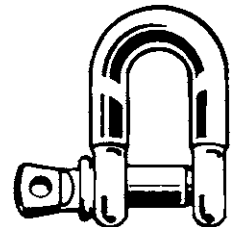

Technical Data

d	Allowable load (kN)	b	d ₂	h
5	1	7	4/5	15.5
6	1.6	8	5/6	18
8	2.5	11	7/8	24
10	4	14	9/10	30
11 (≠DIN)	-	22	11	44
12	6.3	17	10/12	36
14 (≠DIN)	-	28	14	53
16	10	21	13/15	49
19 (≠DIN)	-	38	19	74
20	16	27	17/19	61
22	20	30	19/21	67
24	25	33	21/23	73
25 (≠DIN)	-	51	25	100
28 (≠DIN)	-	57	28	115
32 (≠DIN)	-	64	32	127
38 (≠DIN)	-	76	37	152

- The D (chain) shackles are zinc plated or hot dip galvanized, depending on availability this may deviate.
- Depending on availability the dimensions may deviate.
- Not to be used for lifting applications.

16813 D (chain) shackle F11H

Material Steel
Surface treatment Zinc plated/Hot dip galvanized



d	☒	Art.number	d	☒	Art.number	d	☒	Art.number
5MM ZINC	25	16813.050.001	14MM ZINC	25	16813.140.001	25MM HOT D.G.	3	16813.250.001
6MM ZINC	25	16813.060.001	16MM HOT D.G.	10	16813.160.001	28MM HOT D.G.	1	16813.280.001
8MM ZINC	25	16813.080.001	19MM HOT D.G.	10	16813.190.001	32MM HOT D.G.	1	16813.320.001
10MM ZINC	25	16813.100.001	20MM HOT D.G.	5	16813.200.001	38MM HOT D.G.	1	16813.380.001
11MM ZINC	25	16813.110.001	22MM HOT D.G.	5	16813.220.001			
12MM ZINC	25	16813.120.001	24MM HOT D.G.	5	16813.240.001			

D (chain) shackle Stainless steel

5

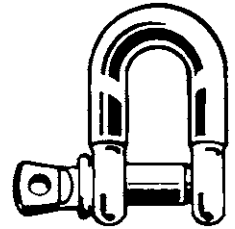
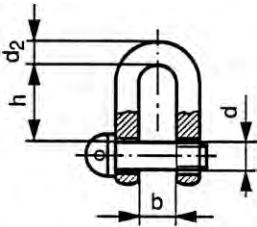

Technical Data

d	b	d ₂	h	d	b	d ₂	h
4	8	4	16	12	24	12	48
5	10	5	20	16	32	16	64/56
6	12	6	24	19	38	19	76
8	16	8	32	24	32	18	80
10	20	10	40				

- Depending on availability the dimensions may deviate.
- Not to be used for lifting applications.

Article groups

Material	Code	Page
St.St. A2	16711	5-20
St.St. A4	16713	5-20

16711 D (chain) shackle Stainless steel R09A

Material Stainless steel A2



d	☒	Art.number	d	☒	Art.number	d	☒	Art.number
5MM	10	16711.050.001	10MM	10	16711.100.001	16MM	5	16711.160.001
6MM	10	16711.060.001	12MM	10	16711.120.001	19MM	2	16711.190.001
8MM	10	16711.080.001						

16713 D (chain) shackle Stainless steel R49A

Material Stainless steel A4



d	☒	Art.number	d	☒	Art.number	d	☒	Art.number
4MM	10	16713.040.001	8MM	10	16713.080.001	16MM	5	16713.160.001
5MM	10	16713.050.001	10MM	10	16713.100.001	19MM	2	16713.190.001
6MM	10	16713.060.001	12MM	10	16713.120.001			

D (chain) shackle, Steel

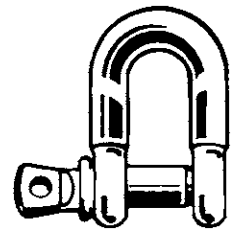
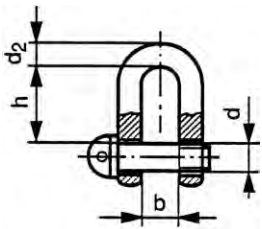

Technical Data

d	b	d ₂	h	d	b	d ₂	h
5	10	5	20	16	32	16	64
6	12	6	24	19	38	19	74
8	16	8	32	22	44	19/21	88
10	20	10	40	25	51	25	100
11	22	11	44	28	57	28	115
12	25	12	50	32	64	32	127
14	28	14	53	38	76	38	152

- The D (chain) shackles are zinc plated or hot dip galvanized, depending on availability this may deviate.
- Depending on availability the dimensions may deviate.
- Not to be used for lifting applications.

5

16812 D (chain) shackle, Steel

F11H

Material Steel
Surface treatment Zinc plated



d	☒	Art.number	d	☒	Art.number	d	☒	Art.number
5MM	25	16812.050.001	12MM	25	16812.120.001	25MM	3	16812.250.001
6MM	25	16812.060.001	14MM	25	16812.140.001	28MM	1	16812.280.001
8MM	25	16812.080.001	16MM	10	16812.160.001	32MM	1	16812.320.001
10MM	25	16812.100.001	19MM	10	16812.190.001	38MM	1	16812.380.001
11MM	25	16812.110.001	22MM	5	16812.220.001			

Bow (anchor) shackle with screw collar pin

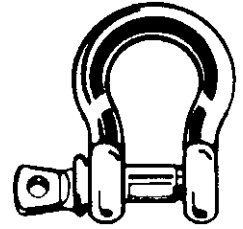
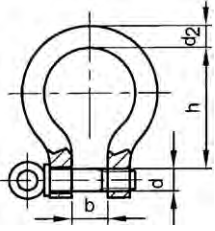

Technical Data

d	b	d ₂	h	d	b	d ₂	h
5	10	5	19	16	32	16	64
6	13	6	25	19	38	19	76
8	16	8	32	22	44	22	89
10	19	10	38	25	51	25	100
11	22	11	46	28	57	28	115
12	25	12	51	32	64	32	127
14	28	14	58	38	76	38	152

5

- The D (chain) shackles are zinc plated or hot dip galvanized, depending on availability this may deviate.
- Depending on availability the dimensions may deviate.
- Not to be used for lifting applications.

16817 Bow (anchor) shackle with screw collar pin

F11H

Material Steel
Surface treatment Zinc plated



d	☒	Art.number	d	☒	Art.number	d	☒	Art.number
5MM	25	16817.050.001	12MM	25	16817.120.001	25MM	5	16817.250.001
6MM	25	16817.060.001	14MM	10	16817.140.001	28MM = 1.1/8	3	16817.280.001
8MM	25	16817.080.001	16MM	10	16817.160.001	32MM = 1.1/4	1	16817.320.001
10MM	25	16817.100.001	19MM	5	16817.190.001	38MM = 1.1/2	1	16817.380.001
11MM	25	16817.110.001	22MM	5	16817.220.001			

Bow (anchor) shackle with screw collar pin Stainless steel

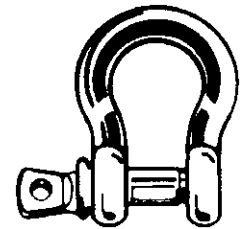
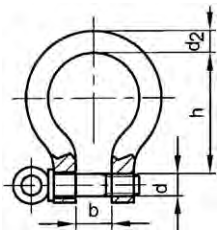

Technical Data

d	b	d ₂	h	d	b	d ₂	h
4	8	4	16	10	20	10	40
5	10	5	20	12	24	12	48
6	12	6	24	16	32	16	64
8	16	8	32				

- The D (chain) shackles are zinc plated or hot dip galvanized, depending on availability this may deviate.
- Depending on availability the dimensions may deviate.
- Not to be used for lifting applications.

Article groups

Material	Code	Page
St.St. A2	16715	5-23
St.St. A4	16717	5-23

5

16715 Bow (anchor) shackle with screw collar pin Stainless steel R09A

Material Stainless steel A2



d	⊗	Art.number	d	⊗	Art.number	d	⊗	Art.number
5MM	10	16715.050.001	8MM	10	16715.080.001	12MM	10	16715.120.001
6MM	10	16715.060.001	10MM	10	16715.100.001	16MM	5	16715.160.001

16717 Bow (anchor) shackle with screw collar pin Stainless steel R49A

Material Stainless steel A4



d	⊗	Art.number	d	⊗	Art.number	d	⊗	Art.number
4MM	10	16717.040.001	8MM	10	16717.080.001	12MM	10	16717.120.001
5MM	10	16717.050.001	10MM	10	16717.100.001	16MM	5	16717.160.001
6MM	10	16717.060.001						

Wire rope clip

DIN 741/555 (1987)

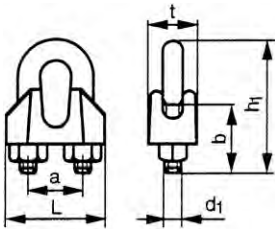
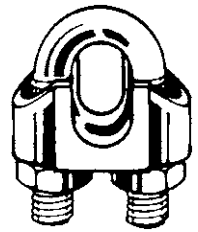

Technical Data

For cable diam.	a	b	d ₁	h ₁	L	Min. amount of clips	t
3	9	12	M4	20	21	3	10
5	11	13	M5	24	23	3	11
6.5	13	15	M5	28	26	3	12
8	16	19	M6	34	30	5	14
10	19	22	M8	42	34	5	18
11	20	22	M8	44	36	5	19
12 (#DIN)	24	26	M10	56	42	5	23
13	24	30	M10	55	42	5	23
14	25	30	M10	57	44	5	23
16	29	33	M12	63	50	6	26
19	32	38	M12	75	54	6	29
22	37	44	M14	85	61	7	33
25 (#DIN)	39	48	M14	95	65	7	34
26	41	45	M14	95	65	8	35
30	48	50	M16	110	74	8	37
34	52	55	M16	120	80	8	42
40	58	60	M16	140	88	8	45

• The corresponding hexagon nuts have a property class \geq I4I.

Assembly data

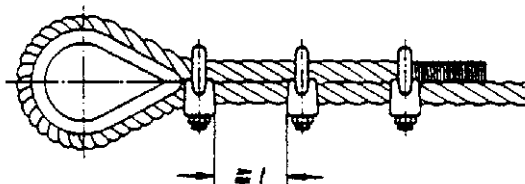

Distance between wire rope clips \geq t of the wire rope clip, see assembly drawing

16829 Wire rope clip

F11M

Material Steel
Surface treatment Zinc plated

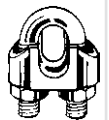

For cable diam.	☒	Art.number	For cable diam.	☒	Art.number	For cable diam.	☒	Art.number
3MM	100	16829.030.001	12MM = 1/2	25	16829.120.001	26MM	10	16829.260.001
5MM	100	16829.050.001	13MM	25	16829.130.001	30MM	5	16829.300.001
6.5MM	100	16829.065.001	14MM	25	16829.140.001	34MM	5	16829.340.001
8MM	100	16829.080.001	16MM	25	16829.160.001	40MM	5	16829.400.001
10MM	50	16829.100.001	19MM	10	16829.190.001			
11MM	50	16829.110.001	22MM	10	16829.220.001			

Wire rope clip Stainless steel

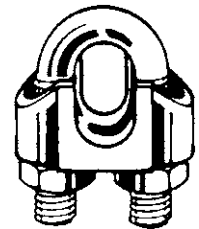
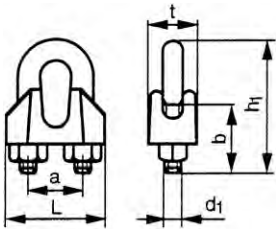

Technical Data

For cable diam.	a	b	d ₁	h ₁	L	Min. amount of clips	t
3	9	12	M3	22	22	3	14
4	9	12	M4	22	22	3	14
5	11	15	M5	24	24	3	16
6	14	18	M6	33	30	3	18
8	16	20	M6	35	33	5	20
10	18	22	M8	43	37	5	22
12	23	30	M10	54	45	5	25
16	28	30	M10	65	53	5	30

- Depending on availability the dimensions may deviate.

Assembly data

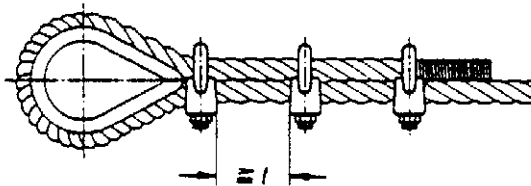

Distance between wire rope clips $\geq t$ of the wire rope clip, see assembly drawing

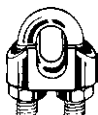
16728 Wire rope clip Stainless steel		R49A
Thread	Metric thread	
Material	Stainless steel A4	
		

For cable diam.	☒	Art.number	For cable diam.	☒	Art.number	For cable diam.	☒	Art.number
3MM	10	16728.030.001	6MM	5	16728.060.001	12MM	5	16728.120.001
4MM	10	16728.040.001	8MM	5	16728.080.001	16MM	5	16728.160.001
5MM	10	16728.050.001	10MM	5	16728.100.001			

Snap hook (carabine hook)

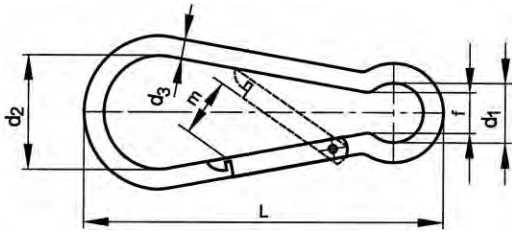

Technical Data

d ₃ x L x f	d ₁	d ₂ (min.)	f	m	Min. breaking load (kN)
5x50x7	7	15	5	6	1.0
6x60x7	8	17	6	7	1.2
7x70x9	10	20	7	8	1.8
8x80x11	12	24	9	10	2.3
10x100x12	15	30	11	11	3.5
11x120x14	16	39	12	17	4.5

- Not to be used for lifting applications.

5

Article groups

Material	Surface treatment	Code	Page
St	Zipl	16833	5-26
St.St. A4		16733	5-26

16833 Snap hook (carabine hook) F11N

Material Steel
Surface treatment Zinc plated



d ₃ x L	⊗	Art.number	d ₃ x L	⊗	Art.number	d ₃ x L	⊗	Art.number
5X50MM	10	16833.050.050	8X80MM	10	16833.080.080	10X100MM	10	16833.100.100
6X60MM	10	16833.060.060						

16733 Snap hook (carabine hook) R49A

Material Stainless steel A4



d ₃ x L	⊗	Art.number	d ₃ x L	⊗	Art.number	d ₃ x L	⊗	Art.number
5X50MM	10	16733.050.050	7X70MM	10	16733.070.070	10X100MM	10	16733.100.100
6X60MM	10	16733.060.060	8X80MM	10	16733.080.080	11X120MM	10	16733.110.120

Thimble

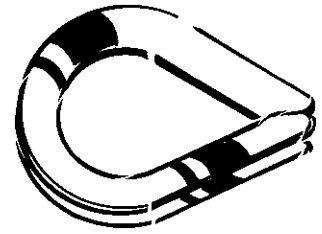
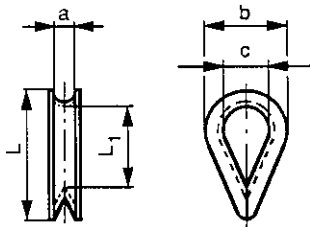

Technical Data

For cable diam.	a	b	c	L	L ₁
3	3	20	12	28	19
4	4	19	11	25	16
5	5	22	16	31	22
6	6	29	19	37	26
8	8	38	24	51	34
10	10	44	32	64	42
12	12	57	38	76	51
14	14	60	40	82	57
16	16	64	42	89	60
18	18	69	45	102	67
20	20	79	51	115	76
22	22	89	54	127	83
24	24	102	64	140	88

16831 Thimble

F11M

Material Steel
Surface treatment Zinc plated



For cable diam.	☒	Art.number	For cable diam.	☒	Art.number	For cable diam.	☒	Art.number
3MM	100	16831.030.001	10MM	50	16831.100.001	18MM	10	16831.180.001
4MM	100	16831.040.001	12MM	50	16831.120.001	20MM	5	16831.200.001
5MM	100	16831.050.001	14MM	10	16831.140.001	22MM	2	16831.220.001
6MM	100	16831.060.001	16MM	10	16831.160.001	24MM	2	16831.240.001
8MM	100	16831.080.001						

Screw eye Metric

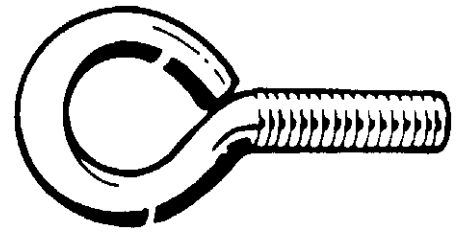
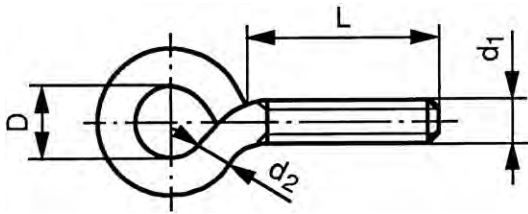

Technical Data

d ₁	d ₂	P	d ₁	d ₂	P
M3	2.6	0.5	M6	5.25	1
M4	3.45	0.7	M8	7.0	1.25
M5	4.4	0.8	M10	8.85	1.5

Article groups

Thread	Material	Surface treatment	Code	Page
M	St	Zipl	17420	5-28
M	St.St. A2		17690	5-28

5

17420	Screw eye article 111G	F11B
Thread	Metric thread	
Material	Steel	
Surface treatment	Zinc plated	

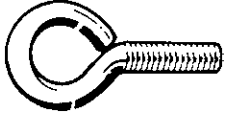
d ₁ x L x D	☒	Art.number	d ₁ x L x D	☒	Art.number	d ₁ x L x D	☒	Art.number
M3X10X6	100	17420.031.006	M5X50X8	100	17420.055.008	M8X40X10	100	17420.084.010
M3X20X5	100	17420.032.006	M5X60X8	100	17420.056.008	M8X50X10	100	17420.085.010
M4X15X6	100	17420.041.506	M6X20X10	100	17420.062.010	M8X60X10	100	17420.086.010
M4X20X6	100	17420.042.006	M6X25X10	100	17420.062.510	M8X80X10	50	17420.088.010
M4X25X6	100	17420.042.506	M6X30X10	100	17420.063.010	M8X100X10	50	17420.089.610
M4X30X6	100	17420.043.006	M6X40X10	100	17420.064.010	M10X40X15	50	17420.104.014
M4X40X6	100	17420.044.006	M6X50X10	100	17420.065.010	M10X50X15	50	17420.105.014
M5X15X8	100	17420.051.508	M6X60X10	100	17420.066.010	M10X60X15	50	17420.106.014
M5X20X8	100	17420.052.008	M6X80X10	100	17420.068.010	M10X80X15	50	17420.108.014
M5X25X8	100	17420.052.508	M6X100X10	100	17420.069.610	M10X90X18	50	17420.109.017
M5X30X8	100	17420.053.008	M8X20X10	100	17420.082.010	M10X100X15	50	17420.109.417
M5X40X8	100	17420.054.008	M8X30X10	100	17420.083.010	M10X120X15	50	17420.109.515

17690	Screw eye article 111R	F11C
Thread	Metric thread	
Material	Stainless steel A2	



d ₁ x L x D	☒	Art.number	d ₁ x L x D	☒	Art.number	d ₁ x L x D	☒	Art.number
M5X15X8	100	17690.051.508	M6X30X10	100	17690.063.010	M8X60X10	100	17690.086.010
M5X30X8	100	17690.053.008	M6X40X10	100	17690.064.010	M8X80X10	50	17690.088.010
M5X50X8	100	17690.055.008	M6X60X10	100	17690.066.010	M10X70X15	50	17690.107.014
M6X20X10	100	17690.062.010						

Cup hook Metric

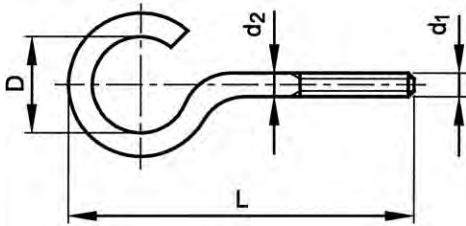

Technical Data

d ₁	D	d ₂	P	d ₁	D	d ₂	P
M4	12	3.45	0.7	M6	16	5.25	1
M5	16	4.4	0.8	M8	15	7.0	1.25

17203 Cup hook article 26

F11A

Thread Metric thread
Material Steel
Surface treatment Zinc plated



d ₁ x L	☒	Art.number	d ₁ x L	☒	Art.number	d ₁ x L	☒	Art.number
M4X50	100	17203.040.050	M6X60	100	17203.060.060	M8X60	100	17203.080.060
M5X50	100	17203.050.050						

Square hook Metric

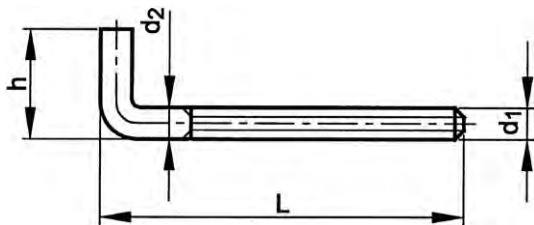

Technical Data

d ₁	d ₂	h	P	d ₁	d ₂	h	P
M4	3.45	15	0.7	M6	5.25	20	1
M5	4.4	20	0.8	M8	7.0	25	1.25

17123 Square hook article 27

F11A

Thread Metric thread
Material Steel
Surface treatment Zinc plated



d ₁ x L	☒	Art.number	d ₁ x L	☒	Art.number	d ₁ x L	☒	Art.number
M4X40	100	17123.040.040	M6X60	100	17123.060.060	M8X60	100	17123.080.060
M5X50	100	17123.050.050						

Screw eye

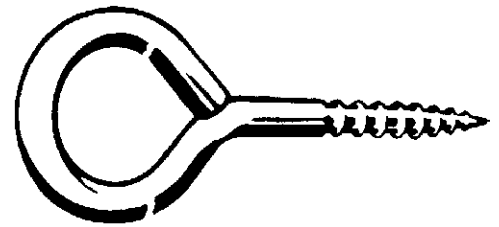
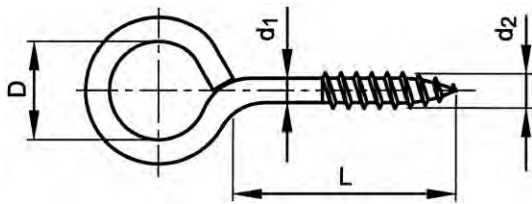

Technical Data

d ₁	d ₂	d ₁	d ₂
1.9	2.4	4.0 (d2=5.1)	5.1
2.2	2.8	4.4	5.5
2.5	3.2	4.5	5.5
2.65	3.4	4.85 (d2=5.8)	5.8
3.0	3.8	4.85 (d2=6.1)	6.1
3.3	4.1	5.25	6.5
3.45	4.3	6.0	7.6
4.0 (d2=4.9)	4.9		

5

Article groups

Material	Surface treatment	Code	Page
St	Zipl	17020	5-30
St.St. A2		17545	5-30
Br		17620	5-31

17020 Screw eye article 1G F11B

Material: Steel
Surface treatment: Zinc plated

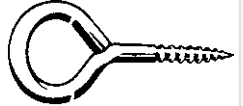
d ₁ x L x D	Art.number	d ₁ x L x D	Art.number	d ₁ x L x D	Art.number
1,9X6X3MM	100 17020.060.003	4,0X20X12MM (d2=5,1)	100 17020.200.012	4,4X40X16MM	100 17020.400.016
2,2X8X4MM	100 17020.080.004	3,45X25X10MM	100 17020.250.010	4,85X40X18MM (d2=6,1)	100 17020.400.018
2,2X10X4MM	100 17020.100.004	4,0X25X12MM (d2=5,1)	100 17020.250.012	5,25X40X20MM	100 17020.400.020
2,5X10X5MM	100 17020.100.005	3,0X20X8MM	100 17020.300.008	4,85X50X15MM (d2=6,1)	100 17020.500.015
2,5X10X6MM	100 17020.100.006	3,45X30X10MM	100 17020.300.010	4,85X50X18MM (d2=6,1)	100 17020.500.018
2,2X12X4MM	100 17020.120.004	4,0X30X12MM (d2=5,1)	100 17020.300.012	4,85X50X18MM (d2=6,1)	100 17020.500.018
2,65X12X6MM	100 17020.120.006	4,0X30X14MM (d2=5,1)	100 17020.300.014	5,25X50X20MM	100 17020.500.020
3,3X12X8MM	100 17020.120.008	4,4X30X16MM	100 17020.300.016	6,0X50X25MM	100 17020.500.025
2,65X16X6MM	100 17020.160.006	4,85X30X18MM (d2=6,1)	100 17020.300.018	5,25X60X20MM	100 17020.600.020
3,0X16X8MM	100 17020.160.008	4,0X40X14MM (d2=5,1)	100 17020.400.014	6,0X60X25MM	100 17020.600.025
3,45X16X10MM	100 17020.160.010	4,85X40X15MM (d2=6,1)	100 17020.400.015		
3,0X20X8MM	100 17020.200.008				
3,45X20X10MM	100 17020.200.010				

17545 Screw eye article 1R F11C

Material: Stainless steel A2

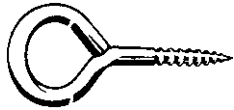

d ₁ x L x D	Art.number	d ₁ x L x D	Art.number	d ₁ x L x D	Art.number
3,45X20X10MM	100 17545.200.010	4,0X30X8MM (d2=5,1)	100 17545.300.008	4,85X30X8MM (d2=5,8)	100 17545.301.008
4,0X25X12MM (d2=5,1)	100 17545.250.012	5,25X30X10MM	100 17545.300.010	4,4X40X16MM	100 17545.400.016

17620	Screw eye article 1M	F11B
Material	Brass	
		 

$d_1 \times L \times D$	☒	Art.number	$d_1 \times L \times D$	☒	Art.number	$d_1 \times L \times D$	☒	Art.number
2,65X12X6MM	100	17620.120.006	3,45X20X10MM	100	17620.200.010	4,0X30X14MM (d2=5,1)	100	17620.300.014
2,65X16X6MM	100	17620.160.006	4,0X25X12MM (d2=4,9)	100	17620.250.012	4,5X40X16MM	100	17620.400.016
3,0X20X8MM	100	17620.200.008						

Screw eye heavy type



Technical Data				
No.	D	d_1	d_2	L
8	8	4	5.1	20
10	8	4.40	5.5	25
15	10	5.25	6.7	35
No.	D	d_1	d_2	L
17	10	7	8.8	40
18	14	7.80	9.5	45

17023	Screw eye heavy type article 3	F11A
Material	Steel	
Surface treatment	Zinc plated	
		 

No.	☒	Art.number	No.	☒	Art.number	No.	☒	Art.number
No.8	100	17023.000.008	No.15	100	17023.000.015	No.18	100	17023.000.018
No.10	100	17023.000.010	No.17	100	17023.000.017			

Screw eye long type

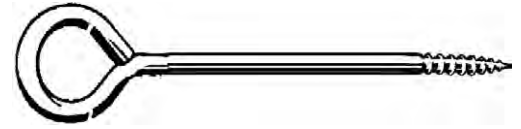
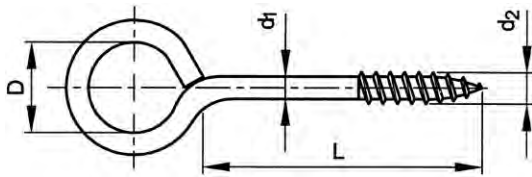

17022	Screw eye long type article 2	F11A
Material	Steel	
Surface treatment	Zinc plated	



d₁ x d₂ x L x D	☒	Art.number	d₁ x d₂ x L x D	☒	Art.number	d₁ x d₂ x L x D	☒	Art.number
7,0X9,0X60X20MM	100	17022.000.060	7,0X9,0X100X20MM	100	17022.000.100	7,0X9,0X140X20MM	100	17022.000.140

5

Cup hook

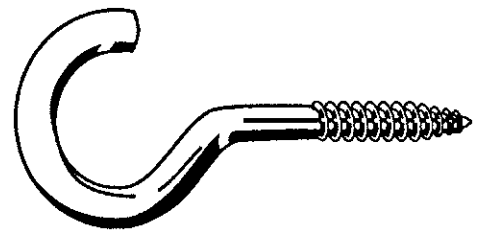
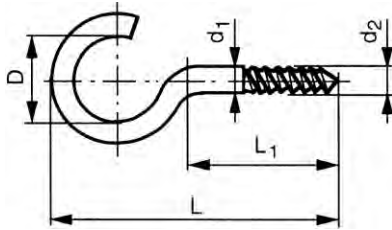

Technical Data

d ₁ x L ₁ /L	D	d ₂	d ₁ x L ₁ /L	D	d ₂
2.0x10/20	7	2.6	4.4x32/60	18	5.5
2.0x11/23	7	2.6	4.4x50/80	20	5.5
2.4x12/25	9	3	4.75x32/60	18	6.1
2.4x15/30	9	3	5.0x47/85	25	6.3
3.2x20/40	12	4.1	5.25x82/120	25	6.5
3.3x13/30	9	4.1	6.0x45/80	25	7.6
3.3x20/40	12	4.1	6.0x62/100	25	7.6
3.45x30/50	14	4.3	6.0x82/120	25	7.6
4.0x27/55	18	5.1	7.0x100/140	25	9.0
4.4x25/50	16	5.5	7.0x120/160	25	9.0

Article groups

Material	Surface treatment		Code	Page
St	Zipl	11	17200	5-32
St	W.Epoxy	11W	17199	5-33
St	Zipl	15	17220	5-33

17200	Cup hook article 11	F11B
Material	Steel	
Surface treatment	Zinc plated	

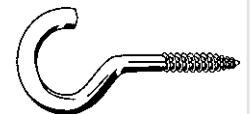

d₁ x L₁/L	☒	Art.number	d₁ x L₁/L	☒	Art.number	d₁ x L₁/L	☒	Art.number
2,0X10/20MM	100	17200.000.020	3,45X30/50MM	100	17200.000.050	2,4X12/25MM	100	17200.025.025
2,0X11/25MM	100	17200.000.025	4,4X32/60MM	100	17200.000.060	3,3X13/30MM	100	17200.030.030
2,4X15/30MM	100	17200.000.030	4,4X50/80MM	100	17200.000.080	4,0X27/55MM	100	17200.040.055
3,3X20/40MM	100	17200.000.040	5,25X82/120MM	100	17200.000.120	5,0X47/85MM	100	17200.050.085



17199 Cup hook article 11W		F11B	
Material	Steel		
Surface treatment	White epoxy		



$d_1 \times L_1/L$	☒	Art.number	$d_1 \times L_1/L$	☒	Art.number	$d_1 \times L_1/L$	☒	Art.number
2,0X10/20MM	100	17199.000.020	2,4X15/30MM	100	17199.000.030	3,45X30/50MM	100	17199.000.050
2,0X11/23MM	100	17199.000.025	3,2X20/40MM	100	17199.000.040	4,4X32/60MM	100	17199.000.060

• Steel zinc plated, white epoxy coating (60-80 µm), for extra surface protection and decoration.

17220 Cup hook heavy type article 15		F11A	
Material	Steel		
Surface treatment	Zinc plated		

$d_1 \times L_1/L$	☒	Art.number	$d_1 \times L_1/L$	☒	Art.number	$d_1 \times L_1/L$	☒	Art.number
4,4X25/50MM	100	17220.044.050	6,0X62/100MM	100	17220.060.100	7,0X100/140MM	100	17220.069.140
4,75X32/60MM	100	17220.047.060	6,0X82/120MM	100	17220.062.120	7,0X120/160MM	100	17220.069.160
6,0X45/80MM	100	17220.060.080						

5

Cup hook small



Technical Data		
d_1	D	d_2
3.3	8	4.1
4.0	14	5.1
4.4	16	5.6

17210 Cup hook small type article 13		F11A	
Material	Steel		
Surface treatment	Zinc plated		



$d_1 \times L_1/L$	☒	Art.number	$d_1 \times L_1/L$	☒	Art.number	$d_1 \times L_1/L$	☒	Art.number
3,3X26/40MM	100	17210.000.040	4,0X58/80MM	100	17210.000.080	4,4X95/120MM	100	17210.000.120
4,0X37/60MM	100	17210.000.060	4,4X75/100MM	100	17210.000.100			

Square hook

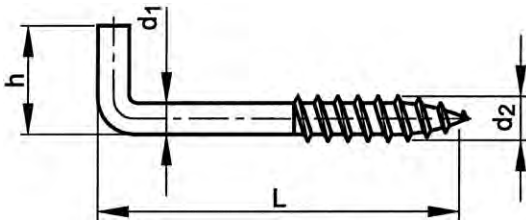

Technical Data

d ₁ x L	d ₂	h	d ₁ x L	d ₂	h
2.0x20	2.8	10	4.0x60	5.1	20
2.5x25	3.2	11	4.4x60	5.5	20
2.65x30	4	14	4.4x80	5.5	22
3.3x40	4	16	5.0x50	6.3	22
3.45x50	4.3	18	5.0x60	6.3	22
3.5x40	4.3	16	5.0x70	6.3	22
4.0x40	5.1	18	5.25x100	6.5	24
4.0x50	5.1	18			

5

Article groups

Material	Surface treatment	Code	Page
St	Zipl	17120	5-34
St	W.Epoxy	17119	5-34

17120 Square hook article 7 F11B

Material: Steel
Surface treatment: Zinc plated



d ₁ x L	Art.number	d ₁ x L	Art.number	d ₁ x L	Art.number
2,2X20MM	100 17120.000.020	4,0X60MM	100 17120.000.060	4,0X50MM	100 17120.040.050
2,5X25MM	100 17120.000.025	4,4X80MM	100 17120.000.080	4,4X60MM	100 17120.045.060
2,65X30MM	100 17120.000.030	5,25X100MM	100 17120.000.100	5,0X50MM	100 17120.050.050
3,3X40MM	100 17120.000.040	3,45X40MM	100 17120.035.040	5,0X60MM	100 17120.050.060
3,45X50MM	100 17120.000.050	4,0X40MM	100 17120.040.040	5,0X70MM	100 17120.050.070

17119 Square hook article 7W F11B

Material: Steel
Surface treatment: White epoxy



d ₁ x L	Art.number	d ₁ x L	Art.number	d ₁ x L	Art.number
2,5X25MM	100 17119.000.025	3,3X40MM	100 17119.000.040	4,0X60MM	100 17119.000.060
2,65X30MM	100 17119.000.030	3,45X50MM	100 17119.000.050		

- Steel zinc plated, white epoxy coating (60-80 µm), for extra surface protection and decoration.

Cross recessed heavy square hook

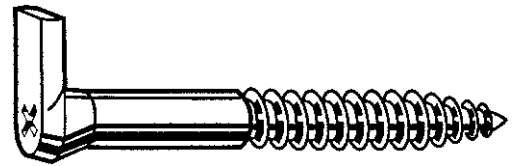
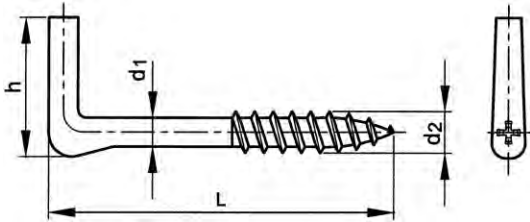

Technical Data

d_1	d_2	h
5.25	5.3	16
5.8	5.8	18

17140 Cross recessed heavy square hook article 9G

F11B

Material Steel
Surface treatment Zinc plated

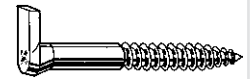

5

$d_1 \times L$	☒	Art.number	$d_1 \times L$	☒	Art.number	$d_1 \times L$	☒	Art.number
5,25X40MM	100	17140.052.040	5,8X65MM	100	17140.060.065	5,8X80MM	100	17140.060.080
5,25X50MM	100	17140.052.050						

Square hook pin

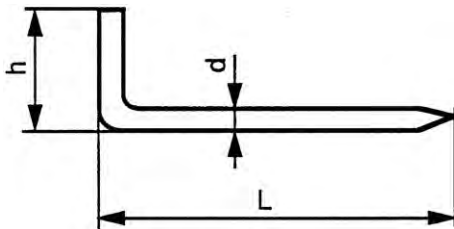

Technical Data

$d \times L$	h	$d \times L$	h
2.5x20	10	4.0x50	19
2.5x25	12	4.0x60	20
3.0x30	13	5.0x80	21
3.5x40	16		

17080 Square hook pin article 4

F11B

Material Steel
Surface treatment Zinc plated



$d \times L$	☒	Art.number	$d \times L$	☒	Art.number	$d \times L$	☒	Art.number
2,5X20MM	100	17080.000.020	3,5X40MM	100	17080.000.040	4,0X60MM	100	17080.000.060
2,5X25MM	100	17080.000.025	4,0X50MM	100	17080.000.050	5,0X80MM	100	17080.000.080
3,0X30MM	100	17080.000.030						

Dowel screw

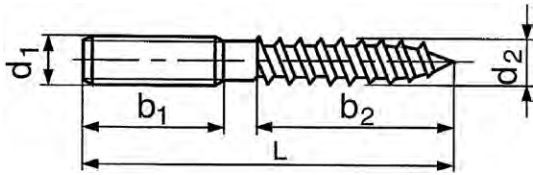

Technical Data

d ₁ x L	b ₁	b ₂	d ₂	P	Socket
M4x20	10	10	4.2	0.7	-
M4x25	10	10	4.2	0.7	-
M4x30	10	15	4.2	0.7	-
M4x35	15	15	4.2	0.7	-
M4x40	17	20	4.2	0.7	-
M5x25	10	15	5.35	0.8	-
M5x40	15	20	5.35	0.8	-
M5x50	20	20	5.35	0.8	-
M6x40	17	23	6	1	T15
M6x50	20	25	6	1	T15
M6x60	20	30	6	1	T15
M6x70	30	30	6	1	T15
M6x80	20	30	6	1	T15
M6x90	30	30	6	1	T15
M6x120	30	30	6	1	T15
M6x150	30	30	6	1	T15

5

17320 Dowel screw without flat surface for wrench article 73 F11B

Thread Metric thread
Material Steel
Surface treatment Zinc plated



d ₁ x L	☒	Art.number	d ₁ x L	☒	Art.number	d ₁ x L	☒	Art.number
M4X20	100	17320.040.020	M5X25	100	17320.050.025	M6X60	100	17320.060.060
M4X25	100	17320.040.025	M5X40	100	17320.050.040	M6X70	100	17320.060.070
M4X30	100	17320.040.030	M5X50	100	17320.050.050	M6X80	100	17320.060.080
M4X35	100	17320.040.035	M6X40	100	17320.060.040	M6X90	100	17320.060.090
M4X40	100	17320.040.040	M6X50	100	17320.060.050	M6X120	100	17320.060.120
						M6X150	100	17320.060.150

- Only M6 with T15 Hexalobular.

Dowel screw Stainless steel A2

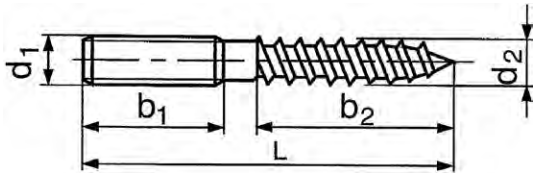

Technical Data

d ₁	b ₁	b ₂	d ₂	P
M6	50	47	6.3	1
M8	50	62	7.3	1.25
M12	205	100	10.7	1.75

51287 Dowel screw without flat surface

F11A

Thread Metric thread
Material Stainless steel A2
Class 50



5

d ₁ x L	☒	Art.number	d ₁ x L	☒	Art.number	d ₁ x L	☒	Art.number
6X50MM*	100	51287.060.050	6X140MM*	100	51287.060.140	8X150MM*	100	51287.080.150
6X60MM*	100	51287.060.060	6X150MM*	100	51287.060.150	8X160MM*	100	51287.080.160
6X70MM*	100	51287.060.070	6X160MM*	100	51287.060.160	8X180MM*	50	51287.080.180
6X80MM*	100	51287.060.080	6X180MM*	100	51287.060.180	8X200MM*	50	51287.080.200
6X90MM*	100	51287.060.090				8X220MM*	50	51287.080.220
6X100MM*	100	51287.060.100	8X50MM*	100	51287.080.050			
6X120MM*	100	51287.060.120	8X60MM*	100	51287.080.060	12X80MM*	50	51287.120.080
6X130MM*	100	51287.060.130	8X70MM*	100	51287.080.070	12X300MM*	50	51287.120.300

Dowel screw Stainless steel A2 with hexagon

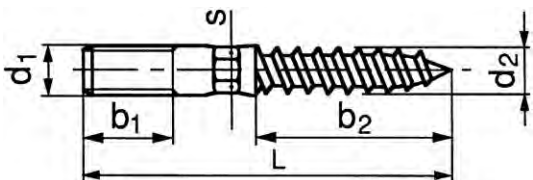

Technical Data

d ₁ x L	b ₁	b ₂	d ₂	P	s
M6x60	20	30	6	1	6
M8x60	20	30	7.3	1.25	6
M8x80	30	40	7.3	1.25	6
M8x90	30	40	7.3	1.25	6
M8x100	40	40	7.3	1.25	6
M8x120	50	50	7.3	1.25	6
M8x110	40	47	7.3	1.25	6
M8x130	50	47	7.3	1.25	6
M8x140	50	47	7.3	1.25	6
M8x150	50	50	7.3	1.25	6
M10x60	20	37	9.0	1.50	-
M10x80	30	40	9.0	1.50	8
M10x90	30	50	9.0	1.50	8
M10x100	30	60	9.0	1.50	8
M10x120	50	60	9.0	1.50	8
M10x140	50	60	9.0	1.50	8
M10x150	50	57	9.0	1.50	8
M10x160	80	57	9.0	1.50	8
M10x180	100	57	9.0	1.50	8
M10x200	100	57	9.0	1.50	8
M10x220	100	57	9.0	1.50	8
M10x250	100	57	9.0	1.50	8

17576	Dowel screw with hexagon for jaw	F11C
Thread	Metric thread	
Material	Stainless steel A2	
		
		

$d_1 \times L$	☒	Art.number	$d_1 \times L$	☒	Art.number	$d_1 \times L$	☒	Art.number
M6X60	100	17576.060.060	M8X130*	100	17576.080.130	M10X140	50	17576.100.140
M8X60	100	17576.080.060	M8X140*	100	17576.080.140	M10X150*	50	17576.100.150
M8X80	100	17576.080.080				M10X160*	50	17576.100.160
M8X100	50	17576.080.100	M10X60*	100	17576.100.060	M10X180*	50	17576.100.180
M8X110*	100	17576.080.110	M10X80	100	17576.100.080	M10X200*	50	17576.100.200
M8X120	50	17576.080.120	M10X100	50	17576.100.100	M10X220*	50	17576.100.220
			M10X120	50	17576.100.120	M10X250*	50	17576.100.250

Dowel screw with width across flats

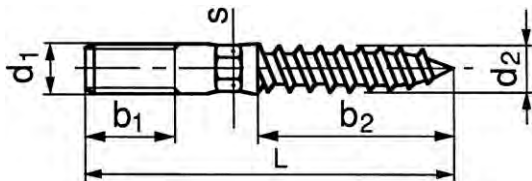

Technical Data

d_1	b_1	b_2	d_2	P	s
M8	50	47	7.3	1.25	6
M10	50	57	9	1.5	8
M12	150	100	10.7	1.75	10

Article groups

Thread	Driving features	Material	Class	Code	Page
M	Hexagon	St.St. A2	50	51281	5-38
M	Hexagon	St.St. A4	50	55282	5-38

51281	Dowel screw with width across flat	F11A
Thread	Metric thread	
Material	Stainless steel A2	
Class	50	
		
		

$d_1 \times L$	☒	Art.number	$d_1 \times L$	☒	Art.number	$d_1 \times L$	☒	Art.number
M12X100*	50	51281.120.100	M12X160*	50	51281.120.160	M12X250*	50	51281.120.250
M12X120*	50	51281.120.120	M12X180*	50	51281.120.180	M12X300*	50	51281.120.300
M12X140*	50	51281.120.140	M12X200*	50	51281.120.200			

55282	Dowel screw with width across flat	R43A
Thread	Metric thread	
Material	Stainless steel A4	
Class	50	
		
		

$d_1 \times L$	☒	Art.number	$d_1 \times L$	☒	Art.number	$d_1 \times L$	☒	Art.number
M8X50*	100	55282.080.050	M8X120*	100	55282.080.120	M10X90*	100	55282.100.090
M8X60*	100	55282.080.060				M10X100*	100	55282.100.100
M8X80*	100	55282.080.080	M10X60*	100	55282.100.060	M10X120*	100	55282.100.120
M8X90*	100	55282.080.090	M10X80*	100	55282.100.080	M10X140*	50	55282.100.140
M8X100*	100	55282.080.100						

Dowel screw with width across flats and hexalobular

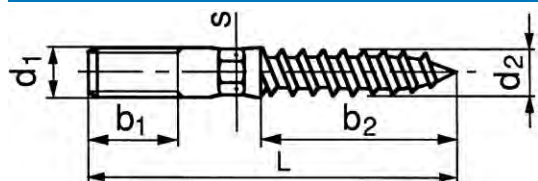

Technical Data

d ₁ x L	b ₁	b ₂	d ₂	P	s	Socket
M8x50	15	30	7.3	1.25	6	T25
M8x60	20	30	7.3	1.25	6	T25
M8x70	25	30	7.3	1.25	6	T25
M8x80	30	40	7.3	1.25	6	T25
M8x90	30	40	7.3	1.25	6	T25
M8x100	40	40	7.3	1.25	6	T25
M8x120	50	50	7.3	1.25	6	T25
M8x140	50	50	7.3	1.25	6	T25
M8x150	50	50	7.3	1.25	6	T25
M8x160	50	50	7.3	1.25	6	T25
M10x60	20	40	9	1.5	8	T25
M10x70	30	30	9	1.5	8	T25
M10x80	30	40	9	1.5	8	T25
M10x90	30	50	9	1.5	8	T25
M10x100	30	60	9	1.5	8	T25
M10x110	40	60	9	1.5	8	T25
M10x120	50	60	9	1.5	8	T25
M10x130	50	60	9	1.5	8	T25
M10x140	50	60	9	1.5	8	T25
M12x100	30	55	10.7	1.75	10	T30
M12x120	30	55	10.7	1.75	10	T30
M12x145	40	55	10.7	1.75	10	T30
M12x165	40	55	10.7	1.75	10	T30

5

Article groups

Thread	Material	Surface treatment		Code	Page
M	St	Zipl	69G	17310	5-39
M	St	Zipl	69	17315	5-39

17310 Dowel screw with hexagon for jaw, hexalobular, article 69G F11B

Thread Metric thread
Material Steel
Surface treatment Zinc plated



d ₁ x L	☒	Art.number	d ₁ x L	☒	Art.number	d ₁ x L	☒	Art.number
M8X50	100	17310.080.050	M8X140	100	17310.080.140	M10X90	50	17310.100.090
M8X60	100	17310.080.060	M8X150	100	17310.080.150	M10X100	50	17310.100.100
M8X70	100	17310.080.070	M8X160	100	17310.080.160	M10X110	50	17310.100.110
M8X80	100	17310.080.080				M10X120	50	17310.100.120
M8X90	100	17310.080.090	M10X60	100	17310.100.060	M10X130	50	17310.100.130
M8X100	100	17310.080.100	M10X70	100	17310.100.070	M10X140	50	17310.100.140
M8X120	100	17310.080.120	M10X80	100	17310.100.080			

17315 Dowel screw with hexagon for jaw, hexalobular, article 69 F11B

Thread Metric thread
Material Steel
Surface treatment Zinc plated



d ₁ x L	☒	Art.number	d ₁ x L	☒	Art.number	d ₁ x L	☒	Art.number
M12X100	50	17315.120.100	M12X140	50	17315.120.145	M12X160	50	17315.120.165
M12X120	50	17315.120.120						

Safety swing hook

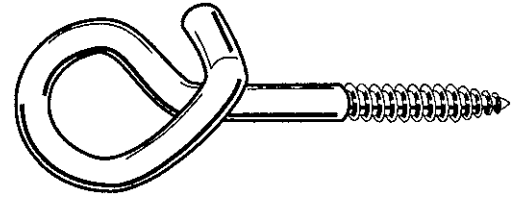
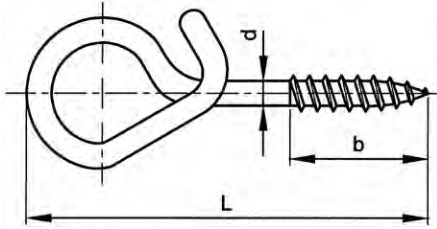

Technical Data

d	b	d ₂
10	45	9.5
11.8	55	11.5

Assembly data

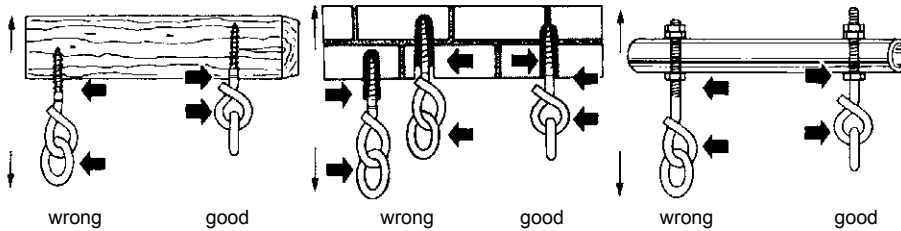

- safety swing hook must be turned in sufficiently so that the threaded shank is completely **invisible**
- safety swing hook must be **transversely** assembled to the swingdirection (this causes the ring to roll and not to slide, consequently reducing wear to minimum)
- safety swing hook and ring must be greased regularly!
- extensive assembly data in each packaging of these safety swing hooks

5

17443 Safety swing hook article 117G F11B

Material Steel
Surface treatment Zinc plated

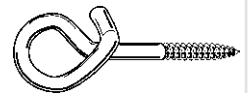

d x L	⊠	Art.number	d x L	⊠	Art.number	d x L	⊠	Art.number
10X125MM	10	17443.100.125	10X160MM	10	17443.100.160	11,8X140MM	10	17443.120.140
10X140MM	10	17443.100.140				11,8X160MM	10	17443.120.160

Safety swing hook Metric

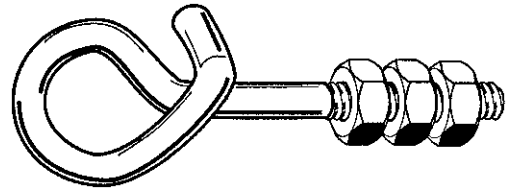
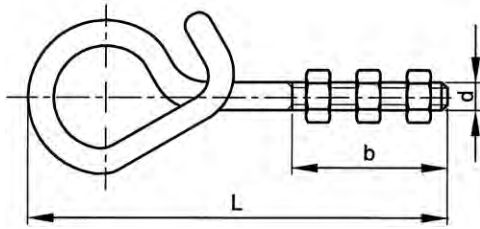

Technical Data

d	P
M12	1.75

17445	Safety swing hook article 118G	F11B
Thread	Metric thread	
Material	Steel	
Surface treatment	Zinc plated	
		
		

d x L/b	☒	Art.number	d x L/b	☒	Art.number	d x L/b	☒	Art.number
M12X140X65	10	17445.120.140	M12X180X80	10	17445.120.180	M12X250X160	10	17445.120.250
M12X160X80	10	17445.120.160						

Ring for safety swing hooks welded

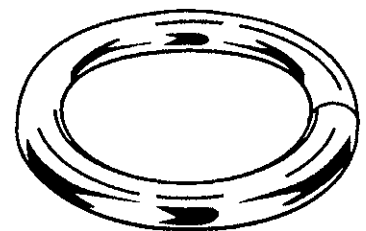
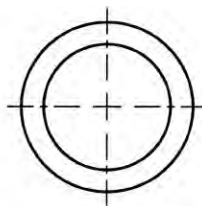
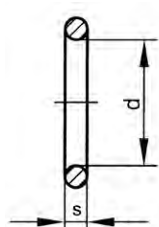

17447	Ring for safety swing hooks welded article 119G	F11B
Material	Steel	
Surface treatment	Zinc plated	
		
		

s x d	☒	Art.number
9X45MM	10	17447.090.045

Gate hook with 2 screw eyes

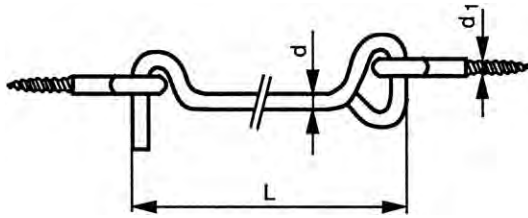

Technical Data

L	d	d ₁	L	d	d ₁
100	4.4	4.0	200	5.25	4.75
160	5.25	4.75	250	6.0	5.25

17571 Gate hook with 2 screw eyes article 63R F11C

Material Stainless steel A2



5

L	☒	Art.number	L	☒	Art.number	L	☒	Art.number
100MM	50	17571.040.100	200MM	25	17571.052.200	250MM	25	17571.060.250
160MM	25	17571.052.160						

S-Hook

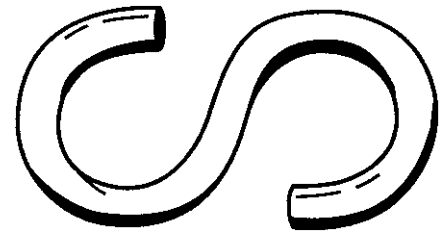
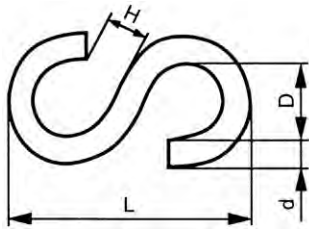

Technical Data

No.	d	D	H	No.	d	D	H
30	3	7	3.5	55	6	15	6
35	3.45	9	4	60	6	16	7
40	4	11	5	70	7	20	7.5
45	4	12	5	80	8.4	23	8.5
50	5	14	5.5				

17380 S-Hook article 105G F11B

Material Steel
Surface treatment Zinc plated



No.(L)	☒	Art.number	No.(L)	☒	Art.number	No.(L)	☒	Art.number
NO.30 (25MM)	100	17380.000.030	NO.45 (40MM)	100	17380.000.045	NO.60 (55MM)	100	17380.000.060
NO.35 (30MM)	100	17380.000.035	NO.50 (45MM)	100	17380.000.050	NO.70 (65MM)	50	17380.000.070
NO.40 (35MM)	100	17380.000.040	NO.55 (50MM)	100	17380.000.055	NO.80 (75MM)	50	17380.000.080

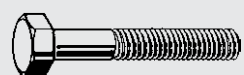

1 Bolts



2 Hexagon socket products



3 Nuts, rivet nuts & inserts



4 Threaded rods & studbolts



5 Hook & eye products



6 Screws

I Index



7 Washers & O-rings



8 Anchoring products

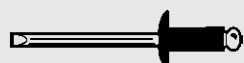

9 Rivets, pins & keys



10 Systems, furniture & security fasteners



11 Assortments & storage systems

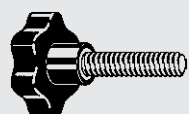

12 Engineering parts & machine parts

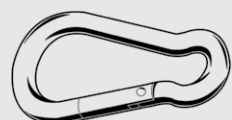

13 Maritime products











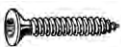







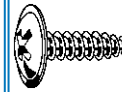





















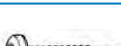









T Fastening technology

Screws 6



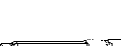















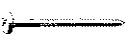





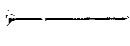
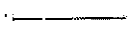









 Page 6-4 DIN 551 Flat point Metric	 Page 6-6 DIN 553 Cone point Metric	 Page 6-7 DIN 438 Cup point Metric	 Page 6-8 DIN 427 Flat point	 Page 6-9 DIN 417 Long dog point Metric
 Page 6-10 DIN 84 Metric	 Page 6-16 DIN 85 Metric	 Page 6-19 DIN 920 Slotted small head Metric	 Page 6-20 DIN 921 Slotted large head Metric	 Page 6-21 DIN 963 Metric
 Page 6-27 BS ≈450 (1958) BSW	 Page 6-28 DIN 964 Metric	 Page 6-31 BS ≈450 (1958) BSW	 Page 6-32 NF ≈E25-129 Metric	 Page 6-33 DIN 404 Slotted Metric
 Page 6-34 DIN 923 With shoulder Metric	 Page 6-35 DIN ≈6900 With captive washer Metric	 Page 6-35 DIN 7985 Metric	 Page 6-41 ISO 14583 Hexalobular Metric	 Page 6-43 ISO 14580 Hexalobular Metric
 Page 6-44 DIN 965 Metric	 Page 6-49 DIN ≈965 Hexalobular Metric	 Page 6-51 DIN 966 Metric	 Page 6-54 DIN ≈966 Hexalobular Metric	 Page 6-55 NF ≈E25-129 Cross slot Metric
 Page 6-56 NF E25-129 Cross slot Metric	 Page 6-57 DIN 7516 AE-H Metric	 Page 6-58 DIN 7516 EE-H Metric	 Page 6-59 DIN 7516 DE-H Metric	 Page 6-60 DIN 7513 A Metric
 Page 6-61 UNC	 Page 6-63 DIN ≈7500 TAPTITE 2000® Metric	 Page 6-64 DIN ≈7500-1 TAPTITE 2000® Metric	 Page 6-65 DIN ≈7500-1 TAPTITE 2000® Metric	 Page 6-66 Thread rolling Metric
 Page 6-67 Thread rolling Hexalobular Metric	 Page 6-68 Thread rolling Metric	 Page 6-68 Thread rolling Hexalobular Metric	 Page 6-70 REMFORM®	 Page 6-71 REMFORM® Torx®
 Page 6-71 REMFORM®	 Page 6-72 For plastics	 Page 6-72 For plastics	 Page 6-73 DIN 7971 Slotted	 Page 6-75 DIN 7972 C Slotted
 Page 6-76 DIN 7973 C Slotted	 Page 6-78 DIN 7981 Cross recessed	 Page 6-84 ISO 14585 C Hexalobular	 Page 6-86 DIN ≈7981 C Pan head square	 Page 6-87 DIN 7982 Cross recessed

Screws 6

6

 <p>Page 6-91 ISO 14586 C</p> <p>Hexalobular</p>	 <p>Page 6-93 DIN ≈7982 C</p> <p>Square recessed</p>	 <p>Page 6-94 DIN 7983</p> <p>Cross recessed</p>	 <p>Page 6-98 DIN 7976</p> <p>Hexagon</p>	 <p>Page 6-100 DIN ≈6928 C</p> <p>Hexagon washer faced</p>
 <p>Page 6-100</p> <p>With cone end and captive washer</p>	 <p>Page 6-101</p> <p>Socket head</p>	 <p>Page 6-102 ISO 14587 C</p> <p>Hexalobular</p>	 <p>Page 6-103</p> <p>Cross recessed and flanged</p>	 <p>Page 6-104</p> <p>Window screw caphead washer</p>
 <p>Page 6-105</p> <p>Window screw hexalobular</p>	 <p>Page 6-106</p> <p>Window screw hexalobular</p>	 <p>Page 6-107</p> <p>Cross recessed</p>	 <p>Page 6-107</p> <p>For license plates</p>	 <p>Page 6-108</p> <p>For cover caps Phillips</p>
 <p>Page 6-109</p> <p>For cover caps hexalobular</p>	 <p>Page 6-109</p> <p>For license plates</p>	 <p>Page 6-110</p> <p>For license plate screw</p>	 <p>Page 6-111</p> <p>With washer</p>	 <p>Page 6-112</p> <p>With sealing washer 16mm</p>
 <p>Page 6-113</p> <p>With sealing washer 19mm</p>	 <p>Page 6-114</p> <p>With sealing washer 22mm</p>	 <p>Page 6-115</p> <p>Hi-Lo thread</p>	 <p>Page 6-115</p> <p>With washer</p>	 <p>Page 6-116</p> <p>Elastomer</p>
 <p>Page 6-117</p> <p>Sealing washers/grey EPDM</p>	 <p>Page 6-119 DIN ≈7504 M-H</p> <p>MAXXFAST Cross recessed pan head</p>	 <p>Page 6-120 DIN ≈7504 M-H</p> <p>Cross recessed pan head</p>	 <p>Page 6-122 DIN 7504 M-H</p> <p>Pan head with cross recess</p>	 <p>Page 6-126 DIN ≈7504 M</p> <p>MAXXFAST Pan head ttap®</p>
 <p>Page 6-127 DIN ≈7504 M</p> <p>MAXXFAST Pan head ttap® bi-metal</p>	 <p>Page 6-128 DIN ≈7504 M</p> <p>MAXXFAST pan head square socket</p>	 <p>Page 6-129 DIN ≈7504 M</p> <p>Pan head SR-recessed</p>	 <p>Page 6-130 DIN ≈7504 M</p> <p>Pan head with square socket drive</p>	 <p>Page 6-130 DIN ≈7504 O-H</p> <p>MAXXFAST Cross recessed countersunk head</p>
 <p>Page 6-132 DIN 7504 O-H</p> <p>Countersunk cross recessed</p>	 <p>Page 6-134 DIN ≈7504 O</p> <p>MAXXFAST countersunk head ttap®</p>	 <p>Page 6-135 DIN ≈7504 K</p> <p>MAXXFAST Hexagon head</p>	 <p>Page 6-137 DIN 7504 K</p> <p>Hexagon head washer faced</p>	 <p>Page 6-139</p> <p>Cross recessed</p>
 <p>Page 6-140</p> <p>Mushroom head SR-recessed</p>	 <p>Page 6-141</p> <p>MAXXFAST countersunk head with wings and ttap®</p>	 <p>Page 6-142</p> <p>With wings and Torx®</p>	 <p>Page 6-143</p> <p>With wings and Torx®</p>	 <p>Page 6-144</p> <p>With wings and Torx® UNC</p>
 <p>Page 6-145</p> <p>With wings and cross recess</p>	 <p>Page 6-146</p> <p>Tools</p>	 <p>Page 6-149</p> <p>MAXXFAST cross recessed countersunk head</p>	 <p>Page 6-151</p> <p>MAXXFAST countersunk head with ttap®</p>	 <p>Page 6-154</p> <p>Cross recessed</p>

Screws 6

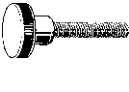
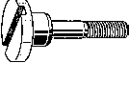
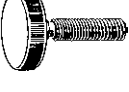
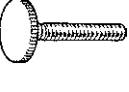
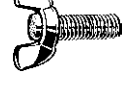
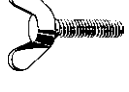
 Page 6-158 Cross recessed with hole	 Page 6-159 Cross recessed small head	 Page 6-159 Hexalobular	 Page 6-162 Hexalobular A2	 Page 6-163 Double countersunk ribs cut point
 Page 6-164 MAXXFAST countersunk head with ttap®	 Page 6-164 Hexalobular	 Page 6-165 Cylindrical head	 Page 6-165 MAXXFAST cross recessed raised cheese head	 Page 6-167 MAXXFAST raised cheese head with ttap®
 Page 6-168 Raised cheese head cross recessed	 Page 6-170 Hexalobular Steel	 Page 6-171 Hexalobular Stainless steel	 Page 6-171 Cross recessed	 Page 6-173 DIN 571 Hex wood screw
 Page 6-176 MAXXFAST countersunk head with ttap®	 Page 6-177 MAXXFAST flange head with ttap®	 Page 6-178 Hexalobular	 Page 6-179 DIN 97 Slotted	 Page 6-182 DIN 96 Slotted
 Page 6-185 DIN 95 Slotted	 Page 6-187 DIN 7997-Z Cross recessed	 Page 6-188 Countersunk head timber screw/ribs PZ	 Page 6-189 DIN 7996 Cross recessed	 Page 6-190 DIN 7995-Z Cross recessed
 Page 6-191 Woodscrew with washers PZ	 Page 6-193 Woodscrew with washer PZ	 Page 6-195 Woodscrew with washers hexalobular	 Page 6-196 Woodscrew with washer hexalobular	 Page 6-198 Dry wall screw
 Page 6-199 Dry wall screw	 Page 6-200 Plastic	 Page 6-201 Plastic	 Page 6-202 Plastic	 Page 6-202 Plastic
 Page 6-203 Metric	 Page 6-204 DIN 464 High Metric	 Page 6-205 DIN 464 Sz High slotted Metric	 Page 6-206 DIN 653 Low Metric	 Page 6-207 Low Metric, plastic
 Page 6-208 American model Metric	 Page 6-209 DIN 316 Round wings Metric			

Slotted set screw with flat point

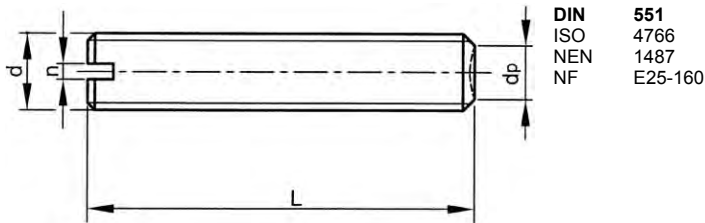

DIN 551
ISO 4766
NEN 1487
NF E25-160

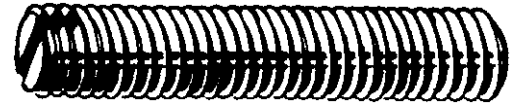

Technical Data



d	d _p	n	P	d	d _p	n	P
M1.6	0.8	0.25	0.35	M6	4	1	1
M2	1	0.25	0.4	M8	5.5	1.2	1.25
M2.5	1.5	0.4	0.45	M10	7	1.6	1.5
M3	2	0.4	0.5	M12	8.5	2	1.75
M4	2.5	0.6	0.7	M16	11.5	2.5	2
M5	3.5	0.8	0.8				

Article groups

Thread	Driving features	Material	Class	Code	Page
M	Slotted	St	14H	20010	6-4
M	Slotted	St.St. A1/A2		51292	6-4
M	Slotted	St.St. A4		55292	6-5

6

20010	Slotted set screw with flat point	G07A
Thread	Metric thread	
Material	Steel	
Class	14H	

d x L	Art.number	d x L	Art.number	d x L	Art.number
M3X4	500 20010.030.004	M4X25	250 20010.040.025	M6X10	500 20010.060.010
M3X5	500 20010.030.005	M4X30	250 20010.040.030	M6X12	250 20010.060.012
M3X6	500 20010.030.006	M4X35	250 20010.040.035	M6X16	250 20010.060.016
M3X8	500 20010.030.008			M6X20	250 20010.060.020
M3X10	500 20010.030.010	M5X5	500 20010.050.005	M6X25	250 20010.060.025
M3X16	500 20010.030.016	M5X6	500 20010.050.006		
M3X20	500 20010.030.020	M5X8	500 20010.050.008	M8X10	250 20010.080.010
		M5X10	500 20010.050.010	M8X20	250 20010.080.020
M4X4	500 20010.040.004	M5X12	500 20010.050.012	M8X30	100 20010.080.030
M4X5	500 20010.040.005	M5X16	250 20010.050.016		
M4X6	500 20010.040.006	M5X20	250 20010.050.020	M10X10	250 20010.100.010
M4X8	500 20010.040.008	M5X25	250 20010.050.025	M10X20	100 20010.100.020
M4X10	500 20010.040.010			M10X30	100 20010.100.030
M4X12	500 20010.040.012	M6X6	500 20010.060.006	M10X40	100 20010.100.040
M4X16	500 20010.040.016	M6X8	500 20010.060.008	M10X50	100 20010.100.050
M4X20	250 20010.040.020				

51292	Slotted set screw with flat point	R03A
Thread	Metric thread	
Material	Stainless steel A1/A2	

d x L	Art.number	d x L	Art.number	d x L	Art.number
M1,6X2*	200 51292.016.002	M2,5X3*	200 51292.025.003	M3X10	200 51292.030.010
M1,6X3*	200 51292.016.003	M2,5X4*	200 51292.025.004	M3X12*	200 51292.030.012
M1,6X4*	200 51292.016.004	M2,5X5*	200 51292.025.005	M3X16	200 51292.030.016
M1,6X5*	200 51292.016.005	M2,5X6*	200 51292.025.006	M3X20	200 51292.030.020
		M2,5X8*	200 51292.025.008		
M2X2*	200 51292.020.002	M2,5X10*	200 51292.025.010	M4X4	200 51292.040.004
M2X3*	200 51292.020.003			M4X5	200 51292.040.005
M2X4*	200 51292.020.004	M3X3*	200 51292.030.003	M4X6	200 51292.040.006
M2X5*	200 51292.020.005	M3X4*	200 51292.030.004	M4X8	200 51292.040.008
M2X6*	200 51292.020.006	M3X5*	200 51292.030.005	M4X10	200 51292.040.010
M2X8*	200 51292.020.008	M3X6	200 51292.030.006	M4X12	200 51292.040.012
M2X10*	200 51292.020.010	M3X8	200 51292.030.008	M4X16	200 51292.040.016
M2X12*	200 51292.020.012			M4X18*	200 51292.040.018

51292 Slotted set screw with flat point								
d x L	☒	Art.number	d x L	☒	Art.number	d x L	☒	Art.number
M4X20	200	51292.040.020	M6X12*	200	51292.060.012	M8X40*	100	51292.080.040
M4X25*	200	51292.040.025	M6X16	200	51292.060.016	M8X45*	100	51292.080.045
M4X30	200	51292.040.030	M6X20	200	51292.060.020	M8X50*	100	51292.080.050
			M6X25	200	51292.060.025	M8X60*	100	51292.080.060
M5X5*	200	51292.050.005	M6X30*	200	51292.060.030			
M5X6	200	51292.050.006	M6X35*	200	51292.060.035	M10X10	100	51292.100.010
M5X8	200	51292.050.008	M6X40*	200	51292.060.040	M10X12*	50	51292.100.012
M5X10	200	51292.050.010	M6X45*	200	51292.060.045	M10X16*	50	51292.100.016
M5X12	200	51292.050.012	M6X60*	200	51292.060.060	M10X20	100	51292.100.020
M5X16	200	51292.050.016				M10X25*	50	51292.100.025
M5X20	200	51292.050.020	M8X8*	100	51292.080.008	M10X30	100	51292.100.030
M5X25*	200	51292.050.025	M8X10	200	51292.080.010	M10X35*	50	51292.100.035
M5X30*	200	51292.050.030	M8X12*	100	51292.080.012	M10X40	100	51292.100.040
M5X40*	200	51292.050.040	M8X16*	100	51292.080.016	M10X45*	50	51292.100.045
			M8X20	200	51292.080.020	M10X50*	50	51292.100.050
M6X6*	200	51292.060.006	M8X25*	100	51292.080.025	M10X55*	50	51292.100.055
M6X8	200	51292.060.008	M8X30	100	51292.080.030	M10X60*	50	51292.100.060
M6X10	200	51292.060.010	M8X35*	100	51292.080.035			

• Depending on availability A1 can be supplied as well as A2.

55292 Slotted set screw with flat point		R43A
Thread	Metric thread	
Material	Stainless steel A4	
		
		

d x L	☒	Art.number	d x L	☒	Art.number	d x L	☒	Art.number
M3X6*	200	55292.030.006	M6X6*	200	55292.060.006	M8X50*	100	55292.080.050
M3X10	200	55292.030.010	M6X8	200	55292.060.008	M8X60*	100	55292.080.060
			M6X10	200	55292.060.010			
M4X4*	200	55292.040.004	M6X12	200	55292.060.012	M10X10	100	55292.100.010
M4X5*	200	55292.040.005	M6X16	200	55292.060.016	M10X12*	50	55292.100.012
M4X6*	200	55292.040.006	M6X20	200	55292.060.020	M10X16*	50	55292.100.016
M4X8	200	55292.040.008	M6X25	200	55292.060.025	M10X20	100	55292.100.020
M4X10	200	55292.040.010	M6X30*	200	55292.060.030	M10X25*	50	55292.100.025
M4X12	200	55292.040.012	M6X35*	200	55292.060.035	M10X30	100	55292.100.030
			M6X40*	200	55292.060.040	M10X35*	50	55292.100.035
M5X5*	200	55292.050.005				M10X40	100	55292.100.040
M5X6	200	55292.050.006	M8X10	200	55292.080.010	M10X45*	50	55292.100.045
M5X8	200	55292.050.008	M8X12*	100	55292.080.012	M10X50*	50	55292.100.050
M5X10	200	55292.050.010	M8X16*	100	55292.080.016	M10X60*	50	55292.100.060
M5X12	200	55292.050.012	M8X20	200	55292.080.020			
M5X16	200	55292.050.016	M8X25*	100	55292.080.025	M12X20*	50	55292.120.020
M5X18*	200	55292.050.018	M8X30	100	55292.080.030	M12X25*	50	55292.120.025
M5X20	200	55292.050.020	M8X35*	100	55292.080.035	M12X30*	50	55292.120.030
M5X25*	200	55292.050.025	M8X40*	100	55292.080.040			
M5X30*	200	55292.050.030	M8X45*	100	55292.080.045	M16X35*	50	55292.160.035

Slotted set screw with cone point

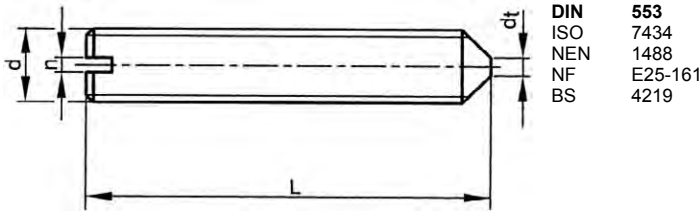

DIN 553
ISO 7434
NEN 1488
NF E25-161
BS 4219



Technical Data

d	d _t (max.)	n	P	d	d _t (max.)	n	P
M1.6	0.16	0.25	0.35	M5	0.5	0.8	0.8
M2	0.2	0.25	0.4	M6	1.5	1	1
M2.5	0.25	0.4	0.45	M8	2	1.2	1.25
M3	0.3	0.4	0.5	M10	2.5	1.6	1.5
M4	0.4	0.6	0.7	M12	3	2	1.75

Article groups

Thread	Driving features	Material	Class	Code	Page
M	Slotted	St	14H	20030	6-6
M	Slotted	St.St. A1/A2		51293	6-6
M	Slotted	St.St. A4		55293	6-7

6

20030		Slotted set screw with cone point		G07A	
Thread	Metric thread	Material	Steel	Class	14H

d x L	☒	Art.number	d x L	☒	Art.number	d x L	☒	Art.number
M3X4	500	20030.030.004	M4X30	250	20030.040.030	M6X16	250	20030.060.016
M3X5	500	20030.030.005	M4X35	250	20030.040.035	M6X20	250	20030.060.020
M3X6	500	20030.030.006				M6X25	250	20030.060.025
M3X10	500	20030.030.010	M5X6	500	20030.050.006			
M3X12	500	20030.030.012	M5X8	500	20030.050.008	M8X10	250	20030.080.010
			M5X10	500	20030.050.010	M8X20	250	20030.080.020
M4X5	500	20030.040.005	M5X12	500	20030.050.012	M8X30	100	20030.080.030
M4X6	500	20030.040.006	M5X16	250	20030.050.016			
M4X8	500	20030.040.008	M5X20	250	20030.050.020	M10X10	250	20030.100.010
M4X10	500	20030.040.010	M5X25	250	20030.050.025	M10X16	100	20030.100.016
M4X12	500	20030.040.012				M10X20	100	20030.100.020
M4X16	500	20030.040.016	M6X8	500	20030.060.008	M10X30	100	20030.100.030
M4X20	250	20030.040.020	M6X10	500	20030.060.010	M10X40	100	20030.100.040
M4X25	250	20030.040.025	M6X12	250	20030.060.012	M10X50	100	20030.100.050

51293		Slotted set screw with cone point		R03A	
Thread	Metric thread	Material	Stainless steel A1/A2		

d x L	☒	Art.number	d x L	☒	Art.number	d x L	☒	Art.number
M1,6X2*	200	51293.016.002	M2,5X8*	200	51293.025.008	M4X12	200	51293.040.012
M1,6X3*	200	51293.016.003				M4X16	200	51293.040.016
M1,6X4*	200	51293.016.004	M3X3*	200	51293.030.003	M4X20*	200	51293.040.020
			M3X4	200	51293.030.004	M4X25	200	51293.040.025
M2X2*	200	51293.020.002	M3X5	200	51293.030.005	M4X30	200	51293.040.030
M2X3*	200	51293.020.003	M3X6	200	51293.030.006	M4X35	200	51293.040.035
M2X4*	200	51293.020.004	M3X8	200	51293.030.008			
M2X5*	200	51293.020.005	M3X10	200	51293.030.010	M5X5*	200	51293.050.005
M2X6*	200	51293.020.006	M3X16*	200	51293.030.016	M5X6	200	51293.050.006
M2X8*	200	51293.020.008	M3X20*	200	51293.030.020	M5X8	200	51293.050.008
M2X10*	200	51293.020.010				M5X10	200	51293.050.010
M2X12*	200	51293.020.012	M4X4*	200	51293.040.004	M5X12	200	51293.050.012
			M4X5	200	51293.040.005	M5X16	200	51293.050.016
M2,5X3*	200	51293.025.003	M4X6	200	51293.040.006	M5X20	200	51293.050.020
M2,5X5*	200	51293.025.005	M4X8	200	51293.040.008	M5X25	200	51293.050.025
M2,5X6*	200	51293.025.006	M4X10	200	51293.040.010	M5X30*	200	51293.050.030

51293 Slotted set screw with cone point								
d x L	☒	Art.number	d x L	☒	Art.number	d x L	☒	Art.number
M6X6*	200	51293.060.006	M8X8*	100	51293.080.008	M8X50*	100	51293.080.050
M6X8	200	51293.060.008	M8X10	200	51293.080.010	M10X12*	50	51293.100.012
M6X10	200	51293.060.010	M8X12*	100	51293.080.012	M10X16*	50	51293.100.016
M6X12*	200	51293.060.012	M8X16*	100	51293.080.016	M10X20	100	51293.100.020
M6X16	200	51293.060.016	M8X20	200	51293.080.020	M10X25*	50	51293.100.025
M6X20*	200	51293.060.020	M8X25*	100	51293.080.025	M10X30	100	51293.100.030
M6X25	200	51293.060.025	M8X30	200	51293.080.030	M10X35*	50	51293.100.035
M6X30*	200	51293.060.030	M8X35*	100	51293.080.035	M10X50	100	51293.100.050
M6X35*	200	51293.060.035	M8X40*	100	51293.080.040			
M6X40*	200	51293.060.040	M8X45*	100	51293.080.045			

• Depending on availability A1 can be supplied as well as A2.

55293 Slotted set screw with cone point								R43A
Thread	Metric thread							
Material	Stainless steel A4							
d x L	☒	Art.number	d x L	☒	Art.number	d x L	☒	Art.number
M3X5	200	55293.030.005	M5X12	200	55293.050.012	M8X12*	100	55293.080.012
M3X8	200	55293.030.008	M5X16	200	55293.050.016	M8X16*	100	55293.080.016
M3X10	200	55293.030.010	M5X25	200	55293.050.025			
M4X5	200	55293.040.005	M6X6*	200	55293.060.006	M10X12*	50	55293.100.012
M4X8	200	55293.040.008	M6X10	200	55293.060.010	M10X16*	50	55293.100.016
M4X10	200	55293.040.010	M6X12	200	55293.060.012	M10X20	100	55293.100.020
M4X12	200	55293.040.012	M6X16	200	55293.060.016	M10X30	100	55293.100.030
M4X16	200	55293.040.016	M6X20	200	55293.060.020	M10X35*	50	55293.100.035
			M6X25	200	55293.060.025	M10X50	100	55293.100.050
M5X6	200	55293.050.006				M12X25*	50	55293.120.025
M5X8	200	55293.050.008	M8X10	200	55293.080.010	M12X30*	50	55293.120.030
M5X10	200	55293.050.010						

6

Slotted set screw with cup point

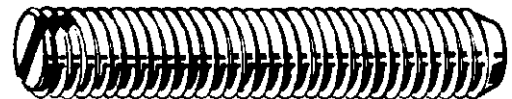
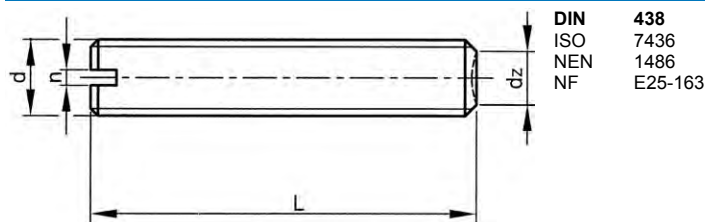

Technical Data

d	d _z	n	P	d	d _z	n	P
M3	1.4	0.4	0.5	M6	3	1	1
M4	2	0.6	0.7	M8	5	1.2	1.25
M5	2.5	0.8	0.8	M10	6	1.6	1.5

Article groups

Thread	Driving features	Material	Class	Code	Page
M	Slotted	St	14H	20000	6-7
M	Slotted	St.St. A1/A2		51291	6-8

20000 Slotted set screw with cup point								G07A
Thread	Metric thread							
Material	Steel							
Class	14H							
d x L	☒	Art.number	d x L	☒	Art.number	d x L	☒	Art.number
M3X4	500	20000.030.004	M4X5	500	20000.040.005	M4X10	500	20000.040.010
M3X6	500	20000.030.006	M4X6	500	20000.040.006	M4X12	500	20000.040.012
M3X8	500	20000.030.008	M4X8	500	20000.040.008	M4X16	500	20000.040.016
M3X10	500	20000.030.010				M4X25	250	20000.040.025

20000 Slotted set screw with cup point								
d x L	☒	Art.number	d x L	☒	Art.number	d x L	☒	Art.number
M4X30	250	20000.040.030	M5X10	500	20000.050.010	M6X10	500	20000.060.010
M4X35	250	20000.040.035	M5X16	250	20000.050.016	M6X12	250	20000.060.012
M5X6	500	20000.050.006	M5X20	250	20000.050.020	M6X16	250	20000.060.016
M5X8	500	20000.050.008	M6X8	500	20000.060.008	M6X20	250	20000.060.020

51291 Slotted set screw with cup point		R03A
Thread	Metric thread	
Material	Stainless steel A1/A2	





d x L	☒	Art.number	d x L	☒	Art.number	d x L	☒	Art.number
M3X4	200	51291.030.004	M4X25	200	51291.040.025	M6X16	200	51291.060.016
M3X5	200	51291.030.005	M5X10	200	51291.050.010	M6X20	200	51291.060.020
M3X6	200	51291.030.006	M5X12	200	51291.050.012	M8X10*	100	51291.080.010
M3X8	200	51291.030.008	M5X16	200	51291.050.016	M8X12*	100	51291.080.012
M4X5*	200	51291.040.005	M5X20	200	51291.050.020	M8X16*	100	51291.080.016
M4X6	200	51291.040.006	M5X25*	200	51291.050.025	M8X20*	100	51291.080.020
M4X8	200	51291.040.008	M6X6*	100	51291.060.006	M8X25*	100	51291.080.025
M4X10	200	51291.040.010	M6X8	200	51291.060.008	M8X35*	100	51291.080.035
M4X12	200	51291.040.012	M6X12	200	51291.060.012	M10X35*	100	51291.100.035
M4X16	200	51291.040.016						
M4X20	200	51291.040.020						

• Depending on availability A1 can be supplied as well as A2.

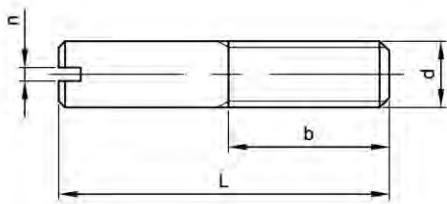
Slotted set screw



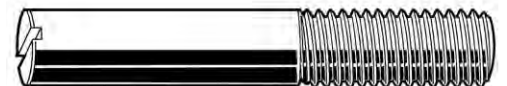

DIN 427
ISO 2342



Technical Data

d	b	n	P
M3	3.6	0.4	0.5
M4	4.8	0.6	0.7
M5	6.0	0.8	0.8
M6	7.2	1.0	1
M8	9.6	1.2	1.25
M10	12.0	1.6	1.5

51296 Slotted set screw		R03A
Thread	Metric thread	
Material	Stainless steel A2	

d x L	☒	Art.number	d x L	☒	Art.number	d x L	☒	Art.number
M3X6*	200	51296.030.006	M5X10*	200	51296.050.010	M6X30*	100	51296.060.030
M3X8*	200	51296.030.008	M5X12*	200	51296.050.012	M6X35*	100	51296.060.035
M3X10*	200	51296.030.010	M5X16*	200	51296.050.016	M6X40*	100	51296.060.040
M3X12*	200	51296.030.012	M5X20*	200	51296.050.020	M8X16*	100	51296.080.016
M3X16*	200	51296.030.016	M5X25*	200	51296.050.025	M8X20*	100	51296.080.020
M4X8*	200	51296.040.008	M5X30*	200	51296.050.030	M8X25*	100	51296.080.025
M4X10*	200	51296.040.010	M5X35*	200	51296.050.035	M8X30*	100	51296.080.030
M4X12*	200	51296.040.012	M5X40*	200	51296.050.040	M8X35*	100	51296.080.035
M4X16*	200	51296.040.016	M6X12*	100	51296.060.012	M8X40*	100	51296.080.040
M4X20*	200	51296.040.020	M6X16*	100	51296.060.016	M10X20*	50	51296.100.020
M4X25*	200	51296.040.025	M6X20*	100	51296.060.020	M10X25*	50	51296.100.025
M4X30*	200	51296.040.030	M6X25*	100	51296.060.025	M10X30*	50	51296.100.030
M4X35*	200	51296.040.035						

51296 Slotted set screw ←

d x L	☒	Art.number	d x L	☒	Art.number
M10X35*	50	51296.100.035	M10X40*	50	51296.100.040

Slotted set screw with long dog point

DIN 417

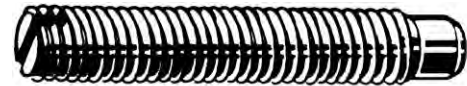
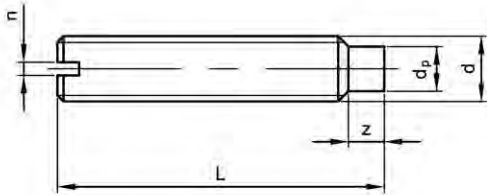
Technical Data

d	d _p (max.)	n	P	z (min.)
M3	2	0.4	0.5	1.5
M4	2.5	0.6	0.7	2
M5	3.5	0.8	0.8	2.5
M6	4	1	1	3
M8	5.5	1.2	1.25	4
M10	7	1.6	1.5	5
M12	8.5	2	1.75	6

51290 Slotted set screw with long dog point R09A

Thread	Metric thread
Material	Stainless steel A2

d x L	☒	Art.number	d x L	☒	Art.number	d x L	☒	Art.number
M3X4*	200	51290.030.004	M5X8*	200	51290.050.008	M8X10*	100	51290.080.010
M3X5*	200	51290.030.005	M5X10*	200	51290.050.010	M8X12*	100	51290.080.012
M3X6*	200	51290.030.006	M5X12*	200	51290.050.012	M8X16*	100	51290.080.016
M3X8*	200	51290.030.008	M5X16*	200	51290.050.016	M8X20*	100	51290.080.020
M3X10*	200	51290.030.010	M5X20*	200	51290.050.020	M8X25*	100	51290.080.025
M3X12*	200	51290.030.012	M5X25*	200	51290.050.025	M8X30*	100	51290.080.030
M3X16*	200	51290.030.016				M8X40*	100	51290.080.040
M3X20*	200	51290.030.020	M6X6*	100	51290.060.006			
			M6X8*	100	51290.060.008	M10X12*	100	51290.100.012
M4X8*	200	51290.040.008	M6X10*	100	51290.060.010	M10X16*	100	51290.100.016
M4X10*	200	51290.040.010	M6X12*	100	51290.060.012	M10X20*	100	51290.100.020
M4X12*	200	51290.040.012	M6X16*	100	51290.060.016	M10X25*	100	51290.100.025
M4X16*	200	51290.040.016	M6X20*	100	51290.060.020	M10X30*	100	51290.100.030
M4X20*	200	51290.040.020	M8X8*	100	51290.080.008	M12X20*	50	51290.120.020

Slotted cheese head screw

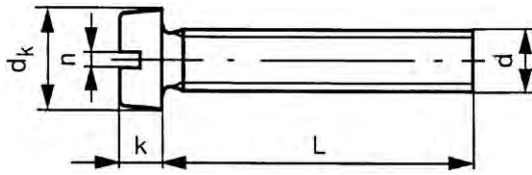

DIN 84
ISO 1207
NEN 1602
ASME B18.6.7M
NF E25-127
BS 4183

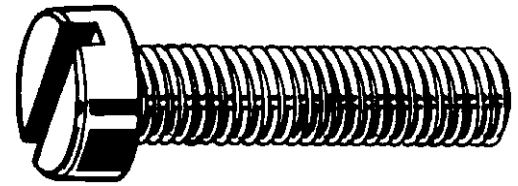

Technical Data

d	dk	Full thread L ≤	k	n	P
M1	2	30	0.7	0.25	0.25
M1.2	2.3	30	0.8	0.3	0.25
M1.4	2.6	30	0.9	0.3	0.3
M1.6	3	30	1	0.4	0.35
M1.7 (#DIN)	3.4	30	1.2	0.4	0.35
M2	3.8	30	1.3	0.5	0.4
M2.3 (#DIN)	4.4	30	1.5	0.6	0.45
M2.5	4.5	30	1.6	0.6	0.45
M2.6 (#DIN)	5	30	1.7	0.6	0.45
M3	5.5	30	2	0.8	0.5
M3.5	6	40	2.4	1	0.6
M4	7	40	2.6	1.2	0.7
M5	8.5	40	3.3	1.2	0.8
M6	10	40	3.9	1.6	1
M8	13	40	5	2	1.25
M10	16	40	6	2.5	1.5
M12 (#DIN)	18	40	7	3	1.75

Article groups

Thread	Driving features	Material	Class	Surface treatment	Color	Code	Page
M	Slotted	St	4.8	Zipl		24520	6-10
M	Slotted	St	4.8	Zipl yell.p.		24510	6-11
M	Slotted	St	4.8	Zipl blk p.		24515	6-11
M	Slotted	St	8.8	Zipl		24402	6-12
M	Slotted	St.St. A2				51121	6-12
M	Slotted	St.St. A2			large pack	51120	6-12
M	Slotted	St.St. A4				55120	6-13
M	Slotted	Br Cu2/Cu3				48020	6-14
M	Slotted	Br Cu2/Cu3		Ni.pl.		48520	6-15
M	Slotted	Plastic PA	PA 6.6		White	56410	6-15

24520 Slotted cheese head screw

H01A

Thread Metric thread
Material Steel
Class 4.8
Surface treatment Zinc plated



d x L	☒	Art.number	d x L	☒	Art.number	d x L	☒	Art.number
M2X4	200	24520.020.004				M3,5X10	200	24520.035.010
M2X5	200	24520.020.005				M3,5X12	200	24520.035.012
M2X6	200	24520.020.006	M3X4	200	24520.030.004	M3,5X16	200	24520.035.016
M2X8	200	24520.020.008	M3X5	200	24520.030.005	M3,5X20	200	24520.035.020
M2X10	200	24520.020.010	M3X6	200	24520.030.006	M3,5X25	200	24520.035.025
M2X12	200	24520.020.012	M3X8	200	24520.030.008	M3,5X30	200	24520.035.030
M2X16	200	24520.020.016	M3X10	200	24520.030.010	M3,5X35	200	24520.035.035
M2X20	200	24520.020.020	M3X12	200	24520.030.012	M3,5X40	200	24520.035.040
M2X30	200	24520.020.030	M3X16	200	24520.030.016	M3,5X50	200	24520.035.050
			M3X20	200	24520.030.020			
			M3X25	200	24520.030.025			
M2,5X4	200	24520.025.004	M3X30	200	24520.030.030	M4X5	200	24520.040.005
M2,5X5	200	24520.025.005	M3X35	200	24520.030.035	M4X6	200	24520.040.006
M2,5X6	200	24520.025.006	M3X40	200	24520.030.040	M4X8	200	24520.040.008
M2,5X8	200	24520.025.008	M3X45	200	24520.030.045	M4X10	200	24520.040.010
M2,5X10	200	24520.025.010	M3X50	200	24520.030.050	M4X12	200	24520.040.012
M2,5X12	200	24520.025.012	M3X60	200	24520.030.060	M4X14	200	24520.040.014
M2,5X16	200	24520.025.016	M3X70	200	24520.030.070	M4X16	200	24520.040.016
M2,5X20	200	24520.025.020				M4X18	200	24520.040.018
M2,5X25	200	24520.025.025	M3,5X6	200	24520.035.006	M4X20	200	24520.040.020
M2,5X30	200	24520.025.030	M3,5X8	200	24520.035.008	M4X25	200	24520.040.025

24520 Slotted cheese head screw								
d x L	☒	Art.number	d x L	☒	Art.number	d x L	☒	Art.number
M4X30	200	24520.040.030	M5X100	100	24520.050.100	M8X60	100	24520.080.060
M4X35	200	24520.040.035				M8X70	100	24520.080.070
M4X40	200	24520.040.040	M6X8	200	24520.060.008	M8X80	100	24520.080.080
M4X45	200	24520.040.045	M6X10	200	24520.060.010	M8X100	100	24520.080.100
M4X50	200	24520.040.050	M6X12	200	24520.060.012			
M4X55	200	24520.040.055	M6X16	200	24520.060.016	M10X16	100	24520.100.016
M4X60	200	24520.040.060	M6X20	200	24520.060.020	M10X20	100	24520.100.020
M4X65	200	24520.040.065	M6X25	200	24520.060.025	M10X25	100	24520.100.025
M4X70	200	24520.040.070	M6X30	200	24520.060.030	M10X30	100	24520.100.030
M4X80	200	24520.040.080	M6X35	200	24520.060.035	M10X35	100	24520.100.035
			M6X40	200	24520.060.040	M10X40	100	24520.100.040
M5X6	200	24520.050.006	M6X45	200	24520.060.045	M10X45	100	24520.100.045
M5X8	200	24520.050.008	M6X50	200	24520.060.050	M10X50	100	24520.100.050
M5X10	200	24520.050.010	M6X60	200	24520.060.060	M10X60	100	24520.100.060
M5X12	200	24520.050.012	M6X70	200	24520.060.070	M10X70	100	24520.100.070
M5X16	200	24520.050.016	M6X80	100	24520.060.080	M10X80	100	24520.100.080
M5X18	200	24520.050.018	M6X90	100	24520.060.090	M10X100	100	24520.100.100
M5X20	200	24520.050.020	M6X100	100	24520.060.100			
M5X25	200	24520.050.025				M12X20	100	24520.120.020
M5X30	200	24520.050.030	M8X10	200	24520.080.010	M12X25	100	24520.120.025
M5X35	200	24520.050.035	M8X12	200	24520.080.012	M12X30	100	24520.120.030
M5X40	200	24520.050.040	M8X16	200	24520.080.016	M12X35	100	24520.120.035
M5X45	200	24520.050.045	M8X20	200	24520.080.020	M12X40	100	24520.120.040
M5X50	200	24520.050.050	M8X25	200	24520.080.025	M12X50	100	24520.120.050
M5X55	100	24520.050.055	M8X30	200	24520.080.030	M12X60	50	24520.120.060
M5X60	200	24520.050.060	M8X35	200	24520.080.035	M12X70	50	24520.120.070
M5X70	200	24520.050.070	M8X40	200	24520.080.040	M12X80	50	24520.120.080
M5X80	100	24520.050.080	M8X45	200	24520.080.045			
M5X90	100	24520.050.090	M8X50	200	24520.080.050			

24510 Slotted cheese head screw		H01A
Thread	Metric thread	
Material	Steel	
Class	4.8	
Surface treatment	Zinc plated yellow passivated	

d x L	☒	Art.number	d x L	☒	Art.number	d x L	☒	Art.number
M2X6	500	24510.020.006	M4X6	500	24510.040.006	M5X60	200	24510.050.060
M2X8	500	24510.020.008	M4X8	500	24510.040.008	M5X70	200	24510.050.070
M2X10	500	24510.020.010	M4X10	500	24510.040.010	M5X80	200	24510.050.080
M2X12	500	24510.020.012	M4X12	500	24510.040.012			
M2X16	500	24510.020.016	M4X16	500	24510.040.016	M6X8	200	24510.060.008
			M4X20	500	24510.040.020	M6X10	200	24510.060.010
M2,5X6	500	24510.025.006	M4X25	500	24510.040.025	M6X12	200	24510.060.012
M2,5X8	500	24510.025.008	M4X30	500	24510.040.030	M6X16	200	24510.060.016
M2,5X10	500	24510.025.010	M4X35	500	24510.040.035	M6X20	200	24510.060.020
M2,5X12	500	24510.025.012	M4X40	500	24510.040.040	M6X25	200	24510.060.025
M2,5X16	500	24510.025.016	M4X45	500	24510.040.045	M6X30	200	24510.060.030
M2,5X20	500	24510.025.020	M4X50	500	24510.040.050	M6X35	200	24510.060.035
M2,5X25	500	24510.025.025	M4X60	200	24510.040.060	M6X40	200	24510.060.040
			M4X70	200	24510.040.070	M6X45	200	24510.060.045
M3X6	500	24510.030.006	M4X80	200	24510.040.080	M6X50	200	24510.060.050
M3X8	500	24510.030.008				M6X60	200	24510.060.060
M3X10	500	24510.030.010	M5X8	500	24510.050.008	M6X70	200	24510.060.070
M3X12	500	24510.030.012	M5X10	500	24510.050.010	M6X80	200	24510.060.080
M3X16	500	24510.030.016	M5X12	500	24510.050.012			
M3X20	500	24510.030.020	M5X16	500	24510.050.016	M8X16	200	24510.080.016
M3X25	500	24510.030.025	M5X20	500	24510.050.020	M8X20	200	24510.080.020
M3X30	500	24510.030.030	M5X25	500	24510.050.025	M8X25	200	24510.080.025
M3X35	500	24510.030.035	M5X30	500	24510.050.030	M8X30	200	24510.080.030
M3X40	500	24510.030.040	M5X35	500	24510.050.035	M8X35	200	24510.080.035
M3X50	500	24510.030.050	M5X40	500	24510.050.040	M8X40	200	24510.080.040
M3X60	500	24510.030.060	M5X45	200	24510.050.045	M8X50	200	24510.080.050
			M5X50	200	24510.050.050	M8X80	200	24510.080.080

24515 Slotted cheese head screw		H01A
Thread	Metric thread	
Material	Steel	
Class	4.8	
Surface treatment	Zinc plated black passivated	

d x L	☒	Art.number	d x L	☒	Art.number	d x L	☒	Art.number
M2X6	200	24515.020.006	M3X20	200	24515.030.020	M5X6	200	24515.050.006
M2X8	200	24515.020.008	M3X25	200	24515.030.025	M5X8	200	24515.050.008
M2X10	200	24515.020.010	M3X30	200	24515.030.030	M5X10	200	24515.050.010
M2X12	200	24515.020.012				M5X12	200	24515.050.012
M2X16	200	24515.020.016	M4X6	200	24515.040.006	M5X16	200	24515.050.016
M2X20	200	24515.020.020	M4X8	200	24515.040.008	M5X20	200	24515.050.020
			M4X10	200	24515.040.010			
M3X4	200	24515.030.004	M4X12	200	24515.040.012	M6X8	200	24515.060.008
M3X6	200	24515.030.006	M4X16	200	24515.040.016	M6X10	200	24515.060.010
M3X8	200	24515.030.008	M4X20	200	24515.040.020	M6X16	200	24515.060.016
M3X10	200	24515.030.010	M4X25	200	24515.040.025	M6X20	200	24515.060.020
M3X12	200	24515.030.012	M4X30	200	24515.040.030			
M3X16	200	24515.030.016						

24402 **Slotted cheese head screw** **H07A**

Thread Metric thread
Material Steel
Class 8.8
Surface treatment Zinc plated



d x L	☒	Art.number	d x L	☒	Art.number	d x L	☒	Art.number
M2X5	200	24402.020.005	M3X16	200	24402.030.016	M5X10	200	24402.050.010
M2X6	200	24402.020.006	M3X20	200	24402.030.020	M5X12	200	24402.050.012
M2X8	200	24402.020.008	M3X25	200	24402.030.025	M5X16	200	24402.050.016
M2X10	200	24402.020.010	M3X30	200	24402.030.030	M5X20	200	24402.050.020
M2X12	200	24402.020.012	M3X40	200	24402.030.040	M5X25	200	24402.050.025
M2X16	200	24402.020.016				M5X30	200	24402.050.030
M2X20	200	24402.020.020	M4X6	200	24402.040.006	M5X40	200	24402.050.040
			M4X8	200	24402.040.008	M5X50	200	24402.050.050
M2,5X5	200	24402.025.005	M4X10	200	24402.040.010			
M2,5X6	200	24402.025.006	M4X12	200	24402.040.012	M6X8	200	24402.060.008
M2,5X8	200	24402.025.008	M4X16	200	24402.040.016	M6X10	200	24402.060.010
M2,5X10	200	24402.025.010	M4X20	200	24402.040.020	M6X12	200	24402.060.012
			M4X25	200	24402.040.025	M6X16	200	24402.060.016
M3X5	200	24402.030.005	M4X30	200	24402.040.030	M6X20	200	24402.060.020
M3X6	200	24402.030.006	M4X40	200	24402.040.040	M6X25	200	24402.060.025
M3X8	200	24402.030.008	M4X50	200	24402.040.050	M6X30	200	24402.060.030
M3X10	200	24402.030.010				M6X40	200	24402.060.040
M3X12	200	24402.030.012	M5X8	200	24402.050.008			

51121 **Slotted cheese head screw** **R02A**

Thread Metric thread
Material Stainless steel A2

d x L	☒	Art.number	d x L	☒	Art.number	d x L	☒	Art.number
M2X4	200	51121.020.004	M3X4	200	51121.030.004	M3X50	200	51121.030.050
M2X10	200	51121.020.010	M3X5	200	51121.030.005			
M2X20	200	51121.020.020	M3X6	200	51121.030.006	M4X6	200	51121.040.006
			M3X10	200	51121.030.010	M4X8	200	51121.040.008
M2,5X4	200	51121.025.004	M3X16	200	51121.030.016	M4X10	200	51121.040.010
M2,5X8	200	51121.025.008	M3X20	200	51121.030.020	M4X12	200	51121.040.012
M2,5X10	200	51121.025.010	M3X25	200	51121.030.025	M4X16	200	51121.040.016
M2,5X12	200	51121.025.012	M3X30	200	51121.030.030	M4X20	200	51121.040.020
			M3X40	200	51121.030.040			

51120 **Slotted cheese head screw** **R02A**

Thread Metric thread
Material Stainless steel A2



d x L	☒	Art.number	d x L	☒	Art.number	d x L	☒	Art.number
M1X2*	1000	51120.010.002	M1X10	100	51120.010.010	M1,2X6	100	51120.012.006
M1X3	100	51120.010.003				M1,2X8	100	51120.012.008
M1X4	100	51120.010.004	M1,2X2*	1000	51120.012.002	M1,2X10	100	51120.012.010
M1X5	100	51120.010.005	M1,2X3	100	51120.012.003			
M1X6	100	51120.010.006	M1,2X4	100	51120.012.004	M1,4X3*	1000	51120.014.003
M1X8	100	51120.010.008	M1,2X5	100	51120.012.005	M1,4X4*	1000	51120.014.004

51120 Slotted cheese head screw								
d x L	☒	Art.number	d x L	☒	Art.number	d x L	☒	Art.number
M1,4X5*	1000	51120.014.005	M3X6	500	51120.030.006	M5X30	200	51120.050.030
M1,4X6*	1000	51120.014.006	M3X8	500	51120.030.008	M5X35	200	51120.050.035
M1,4X8*	1000	51120.014.008	M3X10	500	51120.030.010	M5X40	200	51120.050.040
M1,4X10*	1000	51120.014.010	M3X12	500	51120.030.012	M5X45	200	51120.050.045
M1,4X12*	1000	51120.014.012	M3X14	500	51120.030.014	M5X50	200	51120.050.050
			M3X16	500	51120.030.016	M5X55*	200	51120.050.055
M1,6X2*	1000	51120.016.002	M3X18*	500	51120.030.018	M5X60	200	51120.050.060
M1,6X3	100	51120.016.003	M3X20	500	51120.030.020	M5X65*	200	51120.050.065
M1,6X4	100	51120.016.004	M3X22*	500	51120.030.022	M5X70	200	51120.050.070
M1,6X5	100	51120.016.005	M3X25	500	51120.030.025	M5X80	200	51120.050.080
M1,6X6	100	51120.016.006	M3X28*	500	51120.030.028	M5X90	200	51120.050.090
M1,6X8	100	51120.016.008	M3X30	500	51120.030.030	M5X100	200	51120.050.100
M1,6X10	100	51120.016.010	M3X35	500	51120.030.035			
M1,6X12	100	51120.016.012	M3X40	500	51120.030.040	M6X6*	500	51120.060.006
M1,6X14*	1000	51120.016.014	M3X45*	200	51120.030.045	M6X8	200	51120.060.008
M1,6X16*	1000	51120.016.016	M3X50	500	51120.030.050	M6X10	200	51120.060.010
M1,6X18*	1000	51120.016.018	M3X55*	200	51120.030.055	M6X12	200	51120.060.012
M1,6X20*	1000	51120.016.020	M3X60	500	51120.030.060	M6X14*	500	51120.060.014
						M6X16	200	51120.060.016
M1,7X3*	1000	51120.017.003	M3,5X5*	500	51120.035.005	M6X18*	500	51120.060.018
M1,7X5*	1000	51120.017.005	M3,5X6*	500	51120.035.006	M6X20	200	51120.060.020
M1,7X10*	1000	51120.017.010	M3,5X8*	500	51120.035.008	M6X22*	200	51120.060.022
			M3,5X10	500	51120.035.010	M6X25	200	51120.060.025
M2X3	500	51120.020.003	M3,5X12*	500	51120.035.012	M6X30	200	51120.060.030
M2X4	500	51120.020.004	M3,5X16*	500	51120.035.016	M6X35	100	51120.060.035
M2X5	500	51120.020.005	M3,5X20	500	51120.035.020	M6X40	100	51120.060.040
M2X6	500	51120.020.006	M3,5X25	500	51120.035.025	M6X45	100	51120.060.045
M2X8	500	51120.020.008	M3,5X30	500	51120.035.030	M6X50	100	51120.060.050
M2X10	500	51120.020.010	M3,5X35*	500	51120.035.035	M6X55*	200	51120.060.055
M2X12	500	51120.020.012	M3,5X40*	500	51120.035.040	M6X60	100	51120.060.060
M2X14*	1000	51120.020.014	M3,5X50*	200	51120.035.050	M6X65*	200	51120.060.065
M2X16	500	51120.020.016				M6X70	100	51120.060.070
M2X18*	1000	51120.020.018	M4X4*	500	51120.040.004	M6X75*	200	51120.060.075
M2X20	500	51120.020.020	M4X5*	500	51120.040.005	M6X80	100	51120.060.080
M2X22*	500	51120.020.022	M4X6	500	51120.040.006	M6X90	100	51120.060.090
M2X25	500	51120.020.025	M4X8	500	51120.040.008	M6X100	100	51120.060.100
M2X30*	500	51120.020.030	M4X10	500	51120.040.010			
M2X40*	500	51120.020.040	M4X12	500	51120.040.012	M8X10*	200	51120.080.010
			M4X14*	500	51120.040.014	M8X12	100	51120.080.012
M2,3X3*	1000	51120.023.003	M4X16	500	51120.040.016	M8X16	100	51120.080.016
M2,3X4*	1000	51120.023.004	M4X18	500	51120.040.018	M8X20	100	51120.080.020
M2,3X10*	1000	51120.023.010	M4X20	500	51120.040.020	M8X25	100	51120.080.025
M2,3X20*	1000	51120.023.020	M4X22	200	51120.040.022	M8X30	100	51120.080.030
			M4X25	200	51120.040.025	M8X35	100	51120.080.035
M2,5X3*	1000	51120.025.003	M4X30	200	51120.040.030	M8X40	100	51120.080.040
M2,5X4	500	51120.025.004	M4X35	200	51120.040.035	M8X45	100	51120.080.045
M2,5X5	500	51120.025.005	M4X40	200	51120.040.040	M8X50	100	51120.080.050
M2,5X6	500	51120.025.006	M4X45	200	51120.040.045	M8X60	100	51120.080.060
M2,5X8	500	51120.025.008	M4X50	200	51120.040.050	M8X70	50	51120.080.070
M2,5X10	500	51120.025.010	M4X55*	500	51120.040.055	M8X80	50	51120.080.080
M2,5X12	500	51120.025.012	M4X60	200	51120.040.060	M8X90	50	51120.080.090
M2,5X14*	1000	51120.025.014	M4X70	200	51120.040.070	M8X100	50	51120.080.100
M2,5X16	500	51120.025.016	M4X75*	200	51120.040.075			
M2,5X18*	1000	51120.025.018	M4X80	200	51120.040.080	M10X16*	100	51120.100.016
M2,5X20	500	51120.025.020	M4X90	200	51120.040.090	M10X20	50	51120.100.020
M2,5X22*	500	51120.025.022	M4X100	200	51120.040.100	M10X25	50	51120.100.025
M2,5X25	500	51120.025.025				M10X30	50	51120.100.030
M2,5X30*	500	51120.025.030	M5X6	200	51120.050.006	M10X35*	100	51120.100.035
M2,5X35*	500	51120.025.035	M5X8	200	51120.050.008	M10X40	50	51120.100.040
			M5X10	200	51120.050.010	M10X45	50	51120.100.045
M2,6X5*	1000	51120.026.005	M5X12	200	51120.050.012	M10X50	50	51120.100.050
M2,6X6*	1000	51120.026.006	M5X14*	500	51120.050.014	M10X60	50	51120.100.060
M2,6X8*	1000	51120.026.008	M5X16	200	51120.050.016	M10X70	50	51120.100.070
M2,6X10*	1000	51120.026.010	M5X18*	500	51120.050.018	M10X80	50	51120.100.080
			M5X20	200	51120.050.020	M10X90	50	51120.100.090
M3X3*	500	51120.030.003	M5X22*	500	51120.050.022	M10X100	50	51120.100.100
M3X4	500	51120.030.004	M5X25	200	51120.050.025			
M3X5	500	51120.030.005	M5X28*	500	51120.050.028			

6

55120 Slotted cheese head screw R42A

Thread	Metric thread
Material	Stainless steel A4





d x L	☒	Art.number	d x L	☒	Art.number	d x L	☒	Art.number
M1X3*	1000	55120.010.003	M1X5*	1000	55120.010.005	M1,6X4*	1000	55120.016.004
M1X4*	1000	55120.010.004				M1,6X5*	1000	55120.016.005

55120 Slotted cheese head screw

d x L	☒	Art.number	d x L	☒	Art.number	d x L	☒	Art.number
M1,6X6*	1000	55120.016.006	M3,5X5*	500	55120.035.005	M5X90	200	55120.050.090
M1,6X8*	1000	55120.016.008	M3,5X6*	500	55120.035.006	M5X100	200	55120.050.100
M1,6X10*	1000	55120.016.010	M3,5X8*	500	55120.035.008	M6X8	200	55120.060.008
M2X3*	1000	55120.020.003	M3,5X10*	500	55120.035.010	M6X10	200	55120.060.010
M2X4*	1000	55120.020.004	M3,5X12*	500	55120.035.012	M6X12	200	55120.060.012
M2X5	500	55120.020.005	M3,5X20*	500	55120.035.020	M6X14*	500	55120.060.014
M2X6	500	55120.020.006	M3,5X30*	500	55120.035.030	M6X16	200	55120.060.016
M2X8	500	55120.020.008	M3,5X35*	500	55120.035.035	M6X18*	500	55120.060.018
M2X10	500	55120.020.010	M3,5X40*	500	55120.035.040	M6X20	200	55120.060.020
M2X12	500	55120.020.012	M4X4*	500	55120.040.004	M6X22*	200	55120.060.022
M2X14*	1000	55120.020.014	M4X5*	500	55120.040.005	M6X25	200	55120.060.025
M2X16	500	55120.020.016	M4X6	500	55120.040.006	M6X30	200	55120.060.030
M2X20	500	55120.020.020	M4X8	500	55120.040.008	M6X35	100	55120.060.035
M2X25	500	55120.020.025	M4X10	500	55120.040.010	M6X40	100	55120.060.040
M2,3X6*	1000	55120.023.006	M4X12	500	55120.040.012	M6X45	100	55120.060.045
M2,3X10*	1000	55120.023.010	M4X14*	500	55120.040.014	M6X50	100	55120.060.050
M2,5X3*	1000	55120.025.003	M4X16	500	55120.040.016	M6X55*	200	55120.060.055
M2,5X4*	1000	55120.025.004	M4X18*	500	55120.040.018	M6X60	100	55120.060.060
M2,5X5	500	55120.025.005	M4X20	500	55120.040.020	M6X70	100	55120.060.070
M2,5X6	500	55120.025.006	M4X22*	500	55120.040.022	M6X80	100	55120.060.080
M2,5X8	500	55120.025.008	M4X25	200	55120.040.025	M6X90	100	55120.060.090
M2,5X10	500	55120.025.010	M4X28*	500	55120.040.028	M6X100	100	55120.060.100
M2,5X12	500	55120.025.012	M4X30	200	55120.040.030	M8X10*	200	55120.080.010
M2,5X14*	1000	55120.025.014	M4X35	200	55120.040.035	M8X12*	200	55120.080.012
M2,5X16	500	55120.025.016	M4X40	200	55120.040.040	M8X16	100	55120.080.016
M2,5X18*	1000	55120.025.018	M4X45	200	55120.040.045	M8X20	100	55120.080.020
M2,5X20	500	55120.025.020	M4X50	200	55120.040.050	M8X25	100	55120.080.025
M2,5X25	500	55120.025.025	M4X60	200	55120.040.060	M8X30	100	55120.080.030
M2,5X30*	500	55120.025.030	M4X70	200	55120.040.070	M8X35	100	55120.080.035
M3X3*	500	55120.030.003	M4X90	200	55120.040.090	M8X40	100	55120.080.040
M3X4	500	55120.030.004	M4X100	200	55120.040.100	M8X45	100	55120.080.045
M3X5	500	55120.030.005	M5X6*	500	55120.050.006	M8X50	100	55120.080.050
M3X6	500	55120.030.006	M5X8	200	55120.050.008	M8X60	100	55120.080.060
M3X8	500	55120.030.008	M5X10	200	55120.050.010	M8X70	50	55120.080.070
M3X10	500	55120.030.010	M5X12	200	55120.050.012	M8X80	50	55120.080.080
M3X12	500	55120.030.012	M5X14*	500	55120.050.014	M8X90	50	55120.080.090
M3X14	500	55120.030.014	M5X16	200	55120.050.016	M8X100	50	55120.080.100
M3X16	500	55120.030.016	M5X18	200	55120.050.018	M10X16*	100	55120.100.016
M3X18	500	55120.030.018	M5X20	200	55120.050.020	M10X20	50	55120.100.020
M3X20	500	55120.030.020	M5X22*	500	55120.050.022	M10X25	50	55120.100.025
M3X22*	500	55120.030.022	M5X25	200	55120.050.025	M10X30	50	55120.100.030
M3X25	500	55120.030.025	M5X30	200	55120.050.030	M10X35	50	55120.100.035
M3X30	500	55120.030.030	M5X35	200	55120.050.035	M10X40	50	55120.100.040
M3X35	500	55120.030.035	M5X40	200	55120.050.040	M10X45	50	55120.100.045
M3X40	500	55120.030.040	M5X45	200	55120.050.045	M10X50	50	55120.100.050
M3X45*	200	55120.030.045	M5X50	200	55120.050.050	M10X60	50	55120.100.060
M3X50	500	55120.030.050	M5X55*	200	55120.050.055	M10X70	50	55120.100.070
M3X60	500	55120.030.060	M5X60	200	55120.050.060	M10X80	50	55120.100.080
			M5X70	200	55120.050.070	M10X90	50	55120.100.090
			M5X80	200	55120.050.080	M10X100	50	55120.100.100



48020 Slotted cheese head screw

Thread Metric thread
Material Brass Cu2/Cu3





d x L	☒	Art.number	d x L	☒	Art.number	d x L	☒	Art.number
M2X4	200	48020.020.004	M3X4	200	48020.030.004	M4X8	200	48020.040.008
M2X5	200	48020.020.005	M3X5	200	48020.030.005	M4X10	200	48020.040.010
M2X6	200	48020.020.006	M3X6	200	48020.030.006	M4X12	200	48020.040.012
M2X8	200	48020.020.008	M3X8	200	48020.030.008	M4X16	200	48020.040.016
M2X10	200	48020.020.010	M3X10	200	48020.030.010	M4X18	200	48020.040.018
M2X12	200	48020.020.012	M3X12	200	48020.030.012	M4X20	200	48020.040.020
M2X16	200	48020.020.016	M3X16	200	48020.030.016	M4X25	200	48020.040.025
M2X20	200	48020.020.020	M3X20	200	48020.030.020	M4X30	200	48020.040.030
M2,5X5	200	48020.025.005	M3X25	200	48020.030.025	M4X35	200	48020.040.035
M2,5X6	200	48020.025.006	M3X30	200	48020.030.030	M4X40	200	48020.040.040
M2,5X8	200	48020.025.008	M3X35	200	48020.030.035	M4X50	200	48020.040.050
M2,5X10	200	48020.025.010	M3X40	200	48020.030.040	M4X60	200	48020.040.060
M2,5X12	200	48020.025.012	M3X50	200	48020.030.050	M5X6	200	48020.050.006
M2,5X16	200	48020.025.016	M4X5	200	48020.040.005	M5X8	200	48020.050.008
M2,5X20	200	48020.025.020	M4X6	200	48020.040.006	M5X10	200	48020.050.010
M2,5X25	200	48020.025.025				M5X12	200	48020.050.012

48020 Slotted cheese head screw								
d x L	☒	Art.number	d x L	☒	Art.number	d x L	☒	Art.number
M5X16	200	48020.050.016	M6X16	200	48020.060.016	M8X25	100	48020.080.025
M5X20	200	48020.050.020	M6X20	200	48020.060.020	M8X30	100	48020.080.030
M5X25	200	48020.050.025	M6X25	200	48020.060.025	M8X40	100	48020.080.040
M5X30	200	48020.050.030	M6X30	200	48020.060.030	M8X50	100	48020.080.050
M5X35	200	48020.050.035	M6X35	200	48020.060.035	M8X60	100	48020.080.060
M5X40	200	48020.050.040	M6X40	200	48020.060.040			
M5X45	200	48020.050.045	M6X45	200	48020.060.045	M10X20	100	48020.100.020
M5X50	200	48020.050.050	M6X50	200	48020.060.050	M10X25	100	48020.100.025
M5X60	200	48020.050.060	M6X60	100	48020.060.060	M10X30	100	48020.100.030
			M6X70	100	48020.060.070	M10X40	100	48020.100.040
M6X8	200	48020.060.008				M10X50	100	48020.100.050
M6X10	200	48020.060.010	M8X16	100	48020.080.016			
M6X12	200	48020.060.012	M8X20	100	48020.080.020			

48520 Slotted cheese head screw		M05A
Thread	Metric thread	
Material	Brass Cu2/Cu3	
Surface treatment	Nickel plated	
		
		

d x L	☒	Art.number	d x L	☒	Art.number	d x L	☒	Art.number
M2,5X5	200	48520.025.005	M4X5	200	48520.040.005	M5X30	200	48520.050.030
M2,5X6	200	48520.025.006	M4X6	200	48520.040.006	M5X35	200	48520.050.035
M2,5X8	200	48520.025.008	M4X8	200	48520.040.008	M5X40	200	48520.050.040
M2,5X10	200	48520.025.010	M4X10	200	48520.040.010	M5X50	200	48520.050.050
M2,5X16	200	48520.025.016	M4X12	200	48520.040.012	M5X60	200	48520.050.060
M2,5X20	200	48520.025.020	M4X16	200	48520.040.016			
M2,5X25	200	48520.025.025	M4X20	200	48520.040.020	M6X8	200	48520.060.008
			M4X25	200	48520.040.025	M6X10	200	48520.060.010
M3X4	200	48520.030.004	M4X30	200	48520.040.030	M6X12	200	48520.060.012
M3X5	200	48520.030.005	M4X35	200	48520.040.035	M6X16	200	48520.060.016
M3X6	200	48520.030.006	M4X40	200	48520.040.040	M6X20	200	48520.060.020
M3X8	200	48520.030.008	M4X50	200	48520.040.050	M6X25	200	48520.060.025
M3X10	200	48520.030.010	M4X60	200	48520.040.060	M6X30	200	48520.060.030
M3X12	200	48520.030.012				M6X35	200	48520.060.035
M3X16	200	48520.030.016	M5X8	200	48520.050.008	M6X50	200	48520.060.050
M3X20	200	48520.030.020	M5X10	200	48520.050.010	M6X60	100	48520.060.060
M3X25	200	48520.030.025	M5X12	200	48520.050.012			
M3X30	200	48520.030.030	M5X16	200	48520.050.016	M8X20	100	48520.080.020
M3X35	200	48520.030.035	M5X20	200	48520.050.020	M8X35	100	48520.080.035
M3X50	200	48520.030.050	M5X25	200	48520.050.025	M8X60	100	48520.080.060

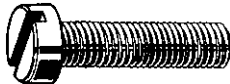
6

56410 Slotted cheese head screw		W02A
Thread	Metric thread	DIN ≈84
Material	Plastic Polyamide (nylon)	ISO ≈1207
Class	PA 6.6	NEN ≈1602
Color	White	ASME ≈B18.6.7M
		NF ≈E25-127
		BS ≈4183
		

d x L	☒	Art.number	d x L	☒	Art.number	d x L	☒	Art.number
M3X4	200	56410.030.004				M6X40	50	56410.060.040
M3X6	200	56410.030.006	M5X6	100	56410.050.006	M6X50	50	56410.060.050
M3X8	200	56410.030.008	M5X8	100	56410.050.008	M6X60	50	56410.060.060
M3X10	200	56410.030.010	M5X10	100	56410.050.010	M6X80	50	56410.060.080
M3X12	200	56410.030.012	M5X12	100	56410.050.012			
M3X16	200	56410.030.016	M5X16	100	56410.050.016	M8X10	25	56410.080.010
M3X20	200	56410.030.020	M5X20	100	56410.050.020	M8X16	25	56410.080.016
M3X25	200	56410.030.025	M5X25	100	56410.050.025	M8X20	25	56410.080.020
M3X30	200	56410.030.030	M5X30	100	56410.050.030	M8X25	25	56410.080.025
			M5X40	100	56410.050.040	M8X30	25	56410.080.030
M4X6	200	56410.040.006	M5X50	100	56410.050.050	M8X40	25	56410.080.040
M4X8	200	56410.040.008				M8X50	25	56410.080.050
M4X10	200	56410.040.010	M6X10	50	56410.060.010	M8X60	25	56410.080.060
M4X12	200	56410.040.012	M6X12	50	56410.060.012	M8X80	25	56410.080.080
M4X16	200	56410.040.016	M6X16	50	56410.060.016			
M4X20	200	56410.040.020	M6X20	50	56410.060.020	M10X20	25	56410.100.020
M4X25	200	56410.040.025	M6X25	50	56410.060.025	M10X30	25	56410.100.030
M4X30	200	56410.040.030	M6X30	50	56410.060.030	M10X40	25	56410.100.040
M4X40	200	56410.040.040						

Slotted pan head screw

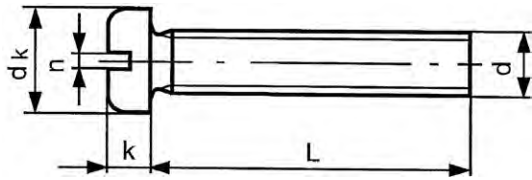

DIN	85
ISO	1580
NEN	1603
ASME	B18.6.7M
NF	E25-128
BS	4183

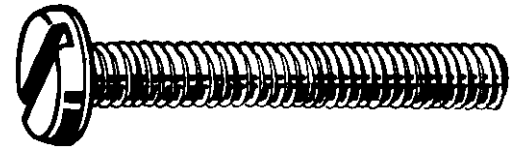

Technical Data

d	d _k	Full thread L ≤	k	n	P
M1.6	3.2	16	1	0.5	0.35
M2 (#DIN)	4	16	1.3	0.5	0.4
M2.5 (#DIN)	5	16	1.5	0.6	0.45
M3	6	30	1.8	0.8	0.5
M3.5	7	38	2.1	1	0.6
M4	8	40	2.4	1.2	0.7
M5	10	40	3	1.2	0.8
M6	12	40	3.6	1.6	1
M8	16	40	4.8	2	1.25
M10	20	40	6	2.5	1.5

Article groups

Thread	Driving features	Material	Class	Surface treatment	Color	Code	Page
M	Slotted	St	4.8	Zipl		24640	6-16
M	Slotted	St.St. A2				51140	6-16
M	Slotted	St.St. A4				55140	6-17
M	Slotted	Br Cu2/Cu3				48040	6-18
M	Slotted	Br Cu2/Cu3		Ni.pl.		48530	6-18
M	Slotted	Plastic PA	PA 6.6		White	56420	6-18

24640 Slotted pan head screw

H01A

Thread	Metric thread
Material	Steel
Class	4.8
Surface treatment	Zinc plated



d x L	Art.number	d x L	Art.number	d x L	Art.number
M3X6	500 24640.030.006	M4X20	500 24640.040.020	M5X60	200 24640.050.060
M3X8	500 24640.030.008	M4X25	500 24640.040.025	M6X8	200 24640.060.008
M3X10	500 24640.030.010	M4X30	500 24640.040.030	M6X10	200 24640.060.010
M3X12	500 24640.030.012	M4X40	500 24640.040.040	M6X12	200 24640.060.012
M3X16	500 24640.030.016	M5X6	500 24640.050.006	M6X16	200 24640.060.016
M3X20	500 24640.030.020	M5X8	500 24640.050.008	M6X20	200 24640.060.020
M3X25	500 24640.030.025	M5X10	500 24640.050.010	M6X25	200 24640.060.025
M3X30	500 24640.030.030	M5X12	500 24640.050.012	M6X30	200 24640.060.030
M3X40	500 24640.030.040	M5X16	500 24640.050.016	M6X40	200 24640.060.040
M4X5	500 24640.040.005	M5X20	500 24640.050.020	M6X50	200 24640.060.050
M4X6	500 24640.040.006	M5X25	500 24640.050.025	M8X16	200 24640.080.016
M4X8	500 24640.040.008	M5X30	500 24640.050.030	M8X20	200 24640.080.020
M4X10	500 24640.040.010	M5X40	500 24640.050.040	M8X25	200 24640.080.025
M4X12	500 24640.040.012	M5X50	200 24640.050.050		
M4X16	500 24640.040.016				

51140 Slotted pan head screw

R02A

Thread	Metric thread
Material	Stainless steel A2



d x L	Art.number	d x L	Art.number	d x L	Art.number
M1.6X5*	1000 51140.016.005	M2X4*	1000 51140.020.004	M2X12*	1000 51140.020.012
M1.6X6*	1000 51140.016.006	M2X5*	1000 51140.020.005	M2X14*	1000 51140.020.014
M1.6X8*	1000 51140.016.008	M2X6	500 51140.020.006	M2X16*	1000 51140.020.016
		M2X8*	1000 51140.020.008	M2X18*	1000 51140.020.018
M2X3*	1000 51140.020.003	M2X10*	1000 51140.020.010	M2X20*	1000 51140.020.020

51140 Slotted pan head screw								
d x L	☒	Art.number	d x L	☒	Art.number	d x L	☒	Art.number
M2,5X3*	1000	51140.025.003	M4X5*	500	51140.040.005	M5X100	200	51140.050.100
M2,5X4*	1000	51140.025.004	M4X6	500	51140.040.006	M6X8*	500	51140.060.008
M2,5X5	500	51140.025.005	M4X8	500	51140.040.008	M6X10	200	51140.060.010
M2,5X6*	1000	51140.025.006	M4X10	500	51140.040.010	M6X12	200	51140.060.012
M2,5X8	500	51140.025.008	M4X12	500	51140.040.012	M6X16	200	51140.060.016
M2,5X10*	1000	51140.025.010	M4X14*	500	51140.040.014	M6X20	200	51140.060.020
M2,5X12*	1000	51140.025.012	M4X16	500	51140.040.016	M6X25	200	51140.060.025
M2,5X14*	1000	51140.025.014	M4X20	500	51140.040.020	M6X30	200	51140.060.030
M2,5X16*	1000	51140.025.016	M4X22*	500	51140.040.022	M6X35	200	51140.060.035
M2,5X20*	1000	51140.025.020	M4X25	200	51140.040.025	M6X40	100	51140.060.040
M2,5X25*	1000	51140.025.025	M4X30	200	51140.040.030	M6X45	100	51140.060.045
M3X4*	500	51140.030.004	M4X35	200	51140.040.035	M6X50	100	51140.060.050
M3X5	500	51140.030.005	M4X40	200	51140.040.040	M6X60	100	51140.060.060
M3X6	500	51140.030.006	M4X45*	500	51140.040.045	M6X70	100	51140.060.070
M3X8	500	51140.030.008	M4X50	200	51140.040.050	M6X80	100	51140.060.080
M3X10	500	51140.030.010	M4X60	200	51140.040.060	M6X90	100	51140.060.090
M3X12	500	51140.030.012	M5X6*	500	51140.050.006	M8X10	100	51140.080.010
M3X14*	500	51140.030.014	M5X8	200	51140.050.008	M8X12	100	51140.080.012
M3X16	500	51140.030.016	M5X10	200	51140.050.010	M8X16*	200	51140.080.016
M3X20	500	51140.030.020	M5X12	200	51140.050.012	M8X20	100	51140.080.020
M3X25	500	51140.030.025	M5X16	200	51140.050.016	M8X25	100	51140.080.025
M3X30	500	51140.030.030	M5X18*	500	51140.050.018	M8X25	200	51140.080.025
M3X35*	500	51140.030.035	M5X20	200	51140.050.020	M8X30*	100	51140.080.030
M3X40	500	51140.030.040	M5X25	200	51140.050.025	M8X35	100	51140.080.035
M3X45*	500	51140.030.045	M5X30	200	51140.050.030	M8X40	100	51140.080.040
M3X50*	500	51140.030.050	M5X35	200	51140.050.035	M8X50	100	51140.080.050
M3,5X6*	500	51140.035.006	M5X40	200	51140.050.040	M8X55*	100	51140.080.055
M3,5X8*	500	51140.035.008	M5X45	200	51140.050.045	M8X60	50	51140.080.060
M3,5X16*	500	51140.035.016	M5X50	200	51140.050.050	M8X90	50	51140.080.090
			M5X60	200	51140.050.060	M8X100	50	51140.080.100
			M5X70	200	51140.050.070			
			M5X80	200	51140.050.080			

51140 Slotted pan head screw		R42A
Thread	Metric thread	
Material	Stainless steel A4	
		

d x L	☒	Art.number	d x L	☒	Art.number	d x L	☒	Art.number
M2X3*	1000	55140.020.003	M4X8	500	55140.040.008	M5X80*	200	55140.050.080
M2X4*	1000	55140.020.004	M4X10	500	55140.040.010	M5X90*	200	55140.050.090
M2X5*	1000	55140.020.005	M4X12*	500	55140.040.012	M6X8*	500	55140.060.008
M2X6*	1000	55140.020.006	M4X16	500	55140.040.016	M6X10	200	55140.060.010
M2X8*	1000	55140.020.008	M4X20	500	55140.040.020	M6X12	200	55140.060.012
M2X10*	1000	55140.020.010	M4X25	200	55140.040.025	M6X16	200	55140.060.016
M2X20*	1000	55140.020.020	M4X30	200	55140.040.030	M6X20	200	55140.060.020
M2,5X6*	1000	55140.025.006	M4X35	200	55140.040.035	M6X25	200	55140.060.025
M2,5X8*	1000	55140.025.008	M4X40	200	55140.040.040	M6X30	200	55140.060.030
M2,5X10*	1000	55140.025.010	M4X45*	500	55140.040.045	M6X35	200	55140.060.035
M2,5X12*	1000	55140.025.012	M4X50*	500	55140.040.050	M6X40	100	55140.060.040
M3X4*	500	55140.030.004	M5X6*	500	55140.050.006	M6X45*	200	55140.060.045
M3X5	500	55140.030.005	M5X8	200	55140.050.008	M6X50	100	55140.060.050
M3X6	500	55140.030.006	M5X10	200	55140.050.010	M6X60	100	55140.060.060
M3X8	500	55140.030.008	M5X12	200	55140.050.012	M6X70*	200	55140.060.070
M3X10	500	55140.030.010	M5X16	200	55140.050.016	M8X10*	200	55140.080.010
M3X12	500	55140.030.012	M5X20	200	55140.050.020	M8X12	100	55140.080.012
M3X16	500	55140.030.016	M5X25	200	55140.050.025	M8X16	100	55140.080.016
M3X20	500	55140.030.020	M5X30	200	55140.050.030	M8X20	100	55140.080.020
M3X25	500	55140.030.025	M5X35*	500	55140.050.035	M8X25	100	55140.080.025
M3X30	500	55140.030.030	M5X40	200	55140.050.040	M8X25	100	55140.080.025
M3X30	500	55140.030.030	M5X45*	200	55140.050.045	M8X30*	200	55140.080.030
M3X40*	500	55140.030.040	M5X50	200	55140.050.050	M8X35	100	55140.080.035
M3X50*	500	55140.030.050	M5X60	200	55140.050.060	M8X40*	200	55140.080.040
M4X6	500	55140.040.006	M5X70*	200	55140.050.070	M8X50	100	55140.080.050

48040		Slotted pan head screw				M05A	
Thread	Metric thread						
Material	Brass Cu2/Cu3						

d x L	☒	Art.number	d x L	☒	Art.number	d x L	☒	Art.number
M3X5	200	48040.030.005	M4X8	200	48040.040.008	M5X12	200	48040.050.012
M3X6	200	48040.030.006	M4X10	200	48040.040.010	M5X16	200	48040.050.016
M3X8	200	48040.030.008	M4X12	200	48040.040.012	M5X20	200	48040.050.020
M3X10	200	48040.030.010	M4X16	200	48040.040.016	M5X25	200	48040.050.025
M3X12	200	48040.030.012	M4X20	200	48040.040.020	M5X40	200	48040.050.040
M3X16	200	48040.030.016	M4X25	200	48040.040.025	M6X10	200	48040.060.010
M3X20	200	48040.030.020	M4X40	200	48040.040.040	M6X12	200	48040.060.012
M3X25	200	48040.030.025	M5X6	200	48040.050.006	M6X16	200	48040.060.016
M4X5	200	48040.040.005	M5X8	200	48040.050.008	M6X20	200	48040.060.020
M4X6	200	48040.040.006	M5X10	200	48040.050.010	M6X25	200	48040.060.025

48530		Slotted pan head screw				M05A	
Thread	Metric thread						
Material	Brass Cu2/Cu3						
Surface treatment	Nickel plated						

d x L	☒	Art.number	d x L	☒	Art.number	d x L	☒	Art.number
M2.5X10	200	48530.025.010	M3X25	200	48530.030.025	M5X8	200	48530.050.008
M2.5X20	200	48530.025.020	M3X30	200	48530.030.030	M5X10	200	48530.050.010
M2.5X25	200	48530.025.025	M4X6	200	48530.040.006	M5X12	200	48530.050.012
M3X5	200	48530.030.005	M4X8	200	48530.040.008	M5X25	200	48530.050.025
M3X6	200	48530.030.006	M4X10	200	48530.040.010	M6X10	200	48530.060.010
M3X8	200	48530.030.008	M4X12	200	48530.040.012	M6X12	200	48530.060.012
M3X10	200	48530.030.010	M4X16	200	48530.040.016	M6X16	200	48530.060.016
M3X12	200	48530.030.012	M4X20	200	48530.040.020	M6X20	200	48530.060.020
M3X16	200	48530.030.016	M4X25	200	48530.040.025			

56420		Slotted pan head screw				W02A	
Thread	Metric thread	DIN	≈85				
Material	Plastic Polyamide (nylon)	ISO	≈1580				
Class	PA 6.6	NEN	≈1603				
Color	White	ASME	≈B18.6.7M				
				NF	≈E25-128		
				BS	≈4183		

d x L	☒	Art.number	d x L	☒	Art.number	d x L	☒	Art.number
M3X4	200	56420.030.004	M4X10	200	56420.040.010	M6X10	50	56420.060.010
M3X6	200	56420.030.006	M4X12	200	56420.040.012	M6X12	50	56420.060.012
M3X8	200	56420.030.008	M4X16	200	56420.040.016	M6X16	50	56420.060.016
M3X10	200	56420.030.010	M4X20	200	56420.040.020	M6X20	50	56420.060.020
M3X12	200	56420.030.012	M5X10	100	56420.050.010	M6X25	50	56420.060.025
M3X16	200	56420.030.016	M5X12	100	56420.050.012	M6X30	50	56420.060.030
M3X20	200	56420.030.020	M5X16	100	56420.050.016	M8X10	25	56420.080.010
M3X25	200	56420.030.025	M5X20	100	56420.050.020	M8X16	25	56420.080.016
M4X6	200	56420.040.006				M8X20	25	56420.080.020
M4X8	200	56420.040.008						

6

Slotted pan head screw small head

DIN 920

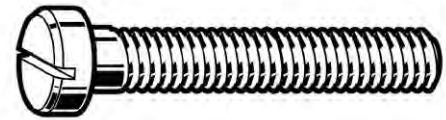
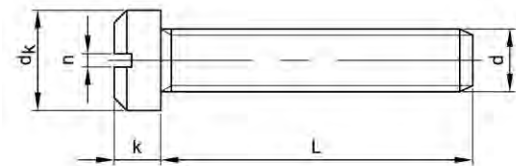

Technical Data

d	d _k (max.)	k (max.)	n	P
M2	2.8	1.2	0.3	0.4
M3	4	1.8	0.5	0.5
M4	5.5	2.4	0.6	0.7
M5	6.5	2.7	0.8	0.8
M6	8	3.1	1	1

51207 Slotted pan head screw small head

R09A

Thread Metric thread
Material Stainless steel A2



d x L	☒	Art.number	d x L	☒	Art.number	d x L	☒	Art.number
M2X4*	500	51207.020.004	M3X12*	500	51207.030.012	M5X5*	200	51207.050.005
M2X6*	500	51207.020.006	M3X16*	500	51207.030.016	M5X6*	200	51207.050.006
M2X8*	500	51207.020.008				M5X8*	200	51207.050.008
M2X10*	500	51207.020.010	M4X4*	500	51207.040.004	M5X10*	200	51207.050.010
			M4X6*	500	51207.040.006	M5X12*	200	51207.050.012
M3X4*	500	51207.030.004	M4X8*	500	51207.040.008	M5X16*	200	51207.050.016
M3X5*	500	51207.030.005	M4X10*	500	51207.040.010	M5X20*	200	51207.050.020
M3X6*	500	51207.030.006	M4X12*	500	51207.040.012			
M3X8*	500	51207.030.008	M4X16*	500	51207.040.016	M6X8*	200	51207.060.008
M3X10*	500	51207.030.010				M6X10*	200	51207.060.010

Slotted pan head screw large head

DIN 921

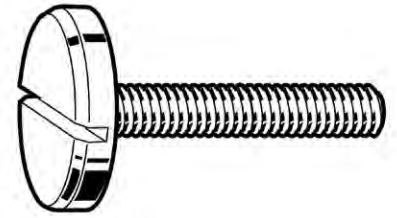
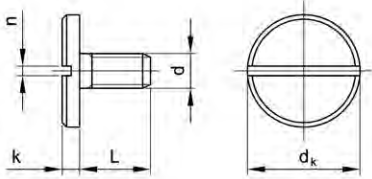

Technical Data

d	d _k (max.)	k (max.)	n	P
M2	6	1.2	0.5	0.4
M3	8	1.8	0.8	0.5
M4	12	2.4	1	0.7
M5	16	2.7	1.2	0.8
M6	20	3.1	1.6	1

51208 Slotted pan head screw large head

R09A

Thread Metric thread
Material Stainless steel A2

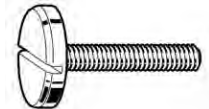

6

d x L	☒	Art.number	d x L	☒	Art.number	d x L	☒	Art.number
M2X2*	100	51208.020.002	M4X5*	100	51208.040.005	M5X12*	100	51208.050.012
M2X3*	100	51208.020.003	M4X6*	100	51208.040.006	M5X16*	100	51208.050.016
M2X4*	100	51208.020.004	M4X8*	100	51208.040.008	M5X20*	100	51208.050.020
M2X5*	100	51208.020.005	M4X10*	100	51208.040.010	M6X8*	50	51208.060.008
M3X4*	100	51208.030.004	M4X12*	100	51208.040.012	M6X10*	50	51208.060.010
M3X5*	100	51208.030.005	M4X16*	100	51208.040.016	M6X12*	50	51208.060.012
M3X6*	100	51208.030.006	M5X6*	100	51208.050.006	M6X16*	50	51208.060.016
M3X8*	100	51208.030.008	M5X8*	100	51208.050.008	M6X20*	50	51208.060.020
M3X10*	100	51208.030.010	M5X10*	100	51208.050.010	M6X25*	50	51208.060.025
M3X12*	100	51208.030.012						

Slotted countersunk head screw

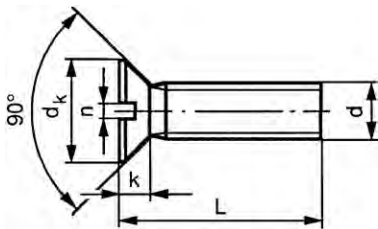

DIN 963
ISO 2009
NEN 2370
ASME B18.6.7M
NF E25-123
BS 4183

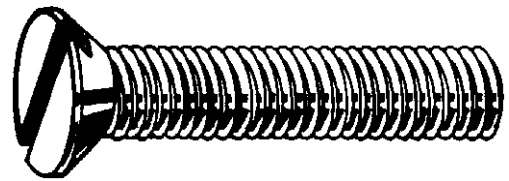

Technical Data

d	dk	Full thread L ≤	k (max.)	n	P
M1	1.9	5	0.6	0.25	0.25
M1.2	2.4	5	0.72	0.3	0.25
M1.4	2.6	16	0.84	0.3	0.3
M1.6	3	16	0.96	0.4	0.35
M2	3.8	18	1.2	0.5	0.4
M2.5	4.7	20	1.5	0.6	0.45
M3	5.6	22	1.65	0.8	0.5
M3.5	6.5	25	1.93	0.8	0.6
M4	7.5	25	2.2	1	0.7
M5	9.2	30	2.5	1.2	0.8
M6	11	35	3	1.6	1
M8	14.5	40	4	2	1.25
M10	18	50	5	2.5	1.5
M12	22	60	6	3	1.75
M14	25	60	7	3	2
M16	29	70	8	4	2
M18	33	80	9	4	2.5
M20	36	80	10	5	2.5

Article groups

Thread	Driving features	Material	Class	Surface treatment	Color	Code	Page
M	Slotted	St	4.8	Zipl		24540	6-21
M	Slotted	St	4.8	Zipl yell.p.		24560	6-22
M	Slotted	St	4.8	Zipl blk p.		24565	6-22
M	Slotted	St	8.8	Zipl		24412	6-23
M	Slotted	St.St. A2				51111	6-23
M	Slotted	St.St. A2			large pack	51110	6-23
M	Slotted	St.St. A4				55110	6-25
M	Slotted	Br Cu2/Cu3				48170	6-25
M	Slotted	Br Cu2/Cu3		Ni.pl.		48550	6-26
M	Slotted	Plastic PA	PA 6.6		White	56440	6-26

24540 Slotted countersunk head screw

H01A

Thread Metric thread
Material Steel
Class 4.8
Surface treatment Zinc plated



d x L	☒	Art.number	d x L	☒	Art.number	d x L	☒	Art.number
M2X4	200	24540.020.004	M2,5X16	200	24540.025.016	M3X50	200	24540.030.050
M2X5	200	24540.020.005	M2,5X20	200	24540.025.020	M3X60	200	24540.030.060
M2X6	200	24540.020.006	M2,5X25	200	24540.025.025	M3X70	200	24540.030.070
M2X8	200	24540.020.008	M2,5X30	200	24540.025.030	M3X100	200	24540.030.100
M2X10	200	24540.020.010						
M2X12	200	24540.020.012	M3X4	200	24540.030.004	M3,5X6	200	24540.035.006
M2X16	200	24540.020.016	M3X5	200	24540.030.005	M3,5X8	200	24540.035.008
M2X20	200	24540.020.020	M3X6	200	24540.030.006	M3,5X10	200	24540.035.010
M2X25	200	24540.020.025	M3X8	200	24540.030.008	M3,5X12	200	24540.035.012
M2X30	200	24540.020.030	M3X10	200	24540.030.010	M3,5X16	200	24540.035.016
			M3X12	200	24540.030.012	M3,5X20	200	24540.035.020
M2,5X4	200	24540.025.004	M3X16	200	24540.030.016	M3,5X25	200	24540.035.025
M2,5X5	200	24540.025.005	M3X20	200	24540.030.020	M3,5X30	200	24540.035.030
M2,5X6	200	24540.025.006	M3X25	200	24540.030.025	M3,5X40	200	24540.035.040
M2,5X8	200	24540.025.008	M3X30	200	24540.030.030			
M2,5X10	200	24540.025.010	M3X35	200	24540.030.035	M4X6	200	24540.040.006
M2,5X12	200	24540.025.012	M3X40	200	24540.030.040	M4X8	200	24540.040.008
M2,5X14	200	24540.025.014	M3X45	200	24540.030.045	M4X10	200	24540.040.010

24540 Slotted countersunk head screw								
d x L	☒	Art.number	d x L	☒	Art.number	d x L	☒	Art.number
M4X12	200	24540.040.012	M6X16	200	24540.060.016	M10X35	100	24540.100.035
M4X16	200	24540.040.016	M6X18	200	24540.060.018	M10X40	100	24540.100.040
M4X20	200	24540.040.020	M6X20	200	24540.060.020	M10X45	100	24540.100.045
M4X25	200	24540.040.025	M6X25	200	24540.060.025	M10X50	100	24540.100.050
M4X30	200	24540.040.030	M6X30	200	24540.060.030	M10X60	100	24540.100.060
M4X35	200	24540.040.035	M6X35	200	24540.060.035	M10X70	100	24540.100.070
M4X40	200	24540.040.040	M6X40	200	24540.060.040	M10X80	100	24540.100.080
M4X45	200	24540.040.045	M6X45	200	24540.060.045	M10X100	100	24540.100.100
M4X50	200	24540.040.050	M6X50	200	24540.060.050			
M4X55	500	24540.040.055	M6X55	200	24540.060.055	M12X20	100	24540.120.020
M4X60	200	24540.040.060	M6X60	200	24540.060.060	M12X25	100	24540.120.025
M4X70	200	24540.040.070	M6X70	200	24540.060.070	M12X30	100	24540.120.030
M4X80	200	24540.040.080	M6X75	100	24540.060.075	M12X35	100	24540.120.035
M4X100	200	24540.040.100	M6X80	100	24540.060.080	M12X40	100	24540.120.040
			M6X90	100	24540.060.090	M12X50	100	24540.120.050
M5X6	200	24540.050.006	M6X100	100	24540.060.100	M12X60	100	24540.120.060
M5X8	200	24540.050.008				M12X70	100	24540.120.070
M5X10	200	24540.050.010	M8X10	200	24540.080.010	M12X80	100	24540.120.080
M5X12	200	24540.050.012	M8X12	200	24540.080.012	M12X100	100	24540.120.100
M5X16	200	24540.050.016	M8X16	200	24540.080.016			
M5X20	200	24540.050.020	M8X20	200	24540.080.020	M16X30	50	24540.160.030
M5X25	200	24540.050.025	M8X25	200	24540.080.025	M16X35	50	24540.160.035
M5X30	200	24540.050.030	M8X30	200	24540.080.030	M16X40	50	24540.160.040
M5X35	200	24540.050.035	M8X35	200	24540.080.035	M16X45	50	24540.160.045
M5X40	200	24540.050.040	M8X40	200	24540.080.040	M16X50	50	24540.160.050
M5X45	200	24540.050.045	M8X45	200	24540.080.045	M16X60	50	24540.160.060
M5X50	200	24540.050.050	M8X50	200	24540.080.050	M16X70	50	24540.160.070
M5X55	200	24540.050.055	M8X60	100	24540.080.060	M16X80	50	24540.160.080
M5X60	200	24540.050.060	M8X70	100	24540.080.070	M16X90	50	24540.160.090
M5X70	200	24540.050.070	M8X80	100	24540.080.080	M16X100	50	24540.160.100
M5X80	100	24540.050.080	M8X90	100	24540.080.090			
M5X90	100	24540.050.090	M8X100	100	24540.080.100	M20X40	50	24540.200.040
M5X100	100	24540.050.100	M10X16	200	24540.100.016	M20X50	50	24540.200.050
			M10X20	200	24540.100.020	M20X60	25	24540.200.060
M6X8	200	24540.060.008	M10X25	200	24540.100.025	M20X70	25	24540.200.070
M6X10	200	24540.060.010	M10X30	200	24540.100.030			
M6X12	200	24540.060.012						

24560 Slotted countersunk head screw			H01A	
Thread	Metric thread			
Material	Steel			
Class	4.8			
Surface treatment	Zinc plated yellow passivated			

d x L	☒	Art.number	d x L	☒	Art.number	d x L	☒	Art.number
M3X5	500	24560.030.005	M4X20	500	24560.040.020	M6X10	200	24560.060.010
M3X6	500	24560.030.006	M4X25	500	24560.040.025	M6X12	200	24560.060.012
M3X8	500	24560.030.008	M4X30	500	24560.040.030	M6X16	200	24560.060.016
M3X10	500	24560.030.010	M4X40	500	24560.040.040	M6X20	200	24560.060.020
M3X12	500	24560.030.012	M4X50	500	24560.040.050	M6X25	200	24560.060.025
M3X16	500	24560.030.016	M4X60	500	24560.040.060	M6X30	200	24560.060.030
M3X20	500	24560.030.020				M6X40	200	24560.060.040
M3X25	500	24560.030.025	M5X8	500	24560.050.008	M6X50	200	24560.060.050
M3X30	500	24560.030.030	M5X10	500	24560.050.010	M6X60	200	24560.060.060
M3X40	500	24560.030.040	M5X12	500	24560.050.012	M6X70	200	24560.060.070
M3X50	500	24560.030.050	M5X16	500	24560.050.016	M6X80	200	24560.060.080
M3X60	500	24560.030.060	M5X20	500	24560.050.020			
			M5X25	500	24560.050.025	M8X16	200	24560.080.016
M4X6	500	24560.040.006	M5X30	500	24560.050.030	M8X20	200	24560.080.020
M4X8	500	24560.040.008	M5X40	500	24560.050.040	M8X25	200	24560.080.025
M4X10	500	24560.040.010	M5X50	500	24560.050.050	M8X30	200	24560.080.030
M4X12	500	24560.040.012	M5X60	500	24560.050.060	M8X40	200	24560.080.040
M4X16	500	24560.040.016				M8X50	200	24560.080.050

24565 Slotted countersunk head screw			H01A	
Thread	Metric thread			
Material	Steel			
Class	4.8			
Surface treatment	Zinc plated black passivated			

d x L	☒	Art.number	d x L	☒	Art.number	d x L	☒	Art.number
M2X6	200	24565.020.006	M3X8	200	24565.030.008	M3X16	200	24565.030.016
			M3X10	200	24565.030.010	M3X20	200	24565.030.020
M3X6	200	24565.030.006	M3X12	200	24565.030.012			

24565 Slotted countersunk head screw								
d x L	☒	Art.number	d x L	☒	Art.number	d x L	☒	Art.number
M4X6	200	24565.040.006	M5X20	200	24565.050.020	M8X20	200	24565.080.020
M4X8	200	24565.040.008	M5X25	200	24565.050.025	M8X25	200	24565.080.025
M4X10	200	24565.040.010	M5X35	200	24565.050.035	M8X30	200	24565.080.030
M4X12	200	24565.040.012				M8X35	200	24565.080.035
M4X16	200	24565.040.016	M6X20	200	24565.060.020	M8X40	200	24565.080.040
M4X20	200	24565.040.020	M6X25	200	24565.060.025	M8X50	200	24565.080.050
M4X25	200	24565.040.025	M6X30	200	24565.060.030			
M4X30	200	24565.040.030	M6X40	200	24565.060.040	M10X20	200	24565.100.020
			M6X50	200	24565.060.050	M10X30	200	24565.100.030
M5X10	200	24565.050.010				M10X40	100	24565.100.040
M5X12	200	24565.050.012	M8X12	200	24565.080.012	M10X50	100	24565.100.050
M5X16	200	24565.050.016	M8X16	200	24565.080.016			

24412 Slotted countersunk head screw								H07A
Thread	Metric thread							
Material	Steel							
Class	8.8							
Surface treatment	Zinc plated							

d x L	☒	Art.number	d x L	☒	Art.number	d x L	☒	Art.number
M2,5X6	200	24412.025.006	M3X30	200	24412.030.030	M5X20	200	24412.050.020
M2,5X8	200	24412.025.008				M5X25	200	24412.050.025
M2,5X10	200	24412.025.010	M4X6	200	24412.040.006	M5X30	200	24412.050.030
M2,5X12	200	24412.025.012	M4X8	200	24412.040.008	M5X40	200	24412.050.040
M2,5X16	200	24412.025.016	M4X10	200	24412.040.010			
			M4X12	200	24412.040.012	M6X10	200	24412.060.010
M3X5	200	24412.030.005	M4X16	200	24412.040.016	M6X12	200	24412.060.012
M3X6	200	24412.030.006	M4X20	200	24412.040.020	M6X16	200	24412.060.016
M3X8	200	24412.030.008	M4X30	200	24412.040.030	M6X20	200	24412.060.020
M3X10	200	24412.030.010				M6X25	200	24412.060.025
M3X12	200	24412.030.012	M5X8	200	24412.050.008	M6X30	200	24412.060.030
M3X16	200	24412.030.016	M5X10	200	24412.050.010	M6X40	200	24412.060.040
M3X20	200	24412.030.020	M5X12	200	24412.050.012			
M3X25	200	24412.030.025	M5X16	200	24412.050.016			

6

51111 Slotted countersunk head screw								R02A	
Thread	Metric thread								
Material	Stainless steel A2								

d x L	☒	Art.number	d x L	☒	Art.number	d x L	☒	Art.number
M2X10	200	51111.020.010	M3X6	200	51111.030.006			
M2X16	200	51111.020.016	M3X8	200	51111.030.008	M4X6	200	51111.040.006
			M3X10	200	51111.030.010	M4X8	200	51111.040.008
M2,5X4	200	51111.025.004	M3X12	200	51111.030.012	M4X10	200	51111.040.010
M2,5X5	200	51111.025.005	M3X16	200	51111.030.016	M4X12	200	51111.040.012
M2,5X16	200	51111.025.016	M3X20	200	51111.030.020	M4X16	200	51111.040.016
M2,5X20	200	51111.025.020	M3X25	200	51111.030.025	M4X20	200	51111.040.020
			M3X30	200	51111.030.030			
M3X4	200	51111.030.004	M3X40	200	51111.030.040			

51110 Slotted countersunk head screw								R02A	
Thread	Metric thread								
Material	Stainless steel A2								

d x L	☒	Art.number	d x L	☒	Art.number	d x L	☒	Art.number
M1X2*	1000	51110.010.002	M1,2X5*	1000	51110.012.005			
M1X3*	1000	51110.010.003	M1,2X6*	1000	51110.012.006	M1,6X2*	1000	51110.016.002
M1X4*	1000	51110.010.004	M1,2X8*	1000	51110.012.008	M1,6X3*	1000	51110.016.003
M1X5*	1000	51110.010.005				M1,6X4	100	51110.016.004
M1X6*	1000	51110.010.006	M1,4X3*	1000	51110.014.003	M1,6X5	100	51110.016.005
M1X8*	1000	51110.010.008	M1,4X4*	1000	51110.014.004	M1,6X6	100	51110.016.006
M1X10*	1000	51110.010.010	M1,4X5*	1000	51110.014.005	M1,6X8	100	51110.016.008
			M1,4X6*	1000	51110.014.006	M1,6X10	100	51110.016.010
M1,2X2*	1000	51110.012.002	M1,4X8*	1000	51110.014.008	M1,6X12	100	51110.016.012
M1,2X3*	1000	51110.012.003	M1,4X10*	1000	51110.014.010	M1,6X14*	1000	51110.016.014
M1,2X4*	1000	51110.012.004	M1,4X12*	1000	51110.014.012	M1,6X16*	1000	51110.016.016

51110 Slotted countersunk head screw

d x L	☒	Art.number	d x L	☒	Art.number	d x L	☒	Art.number
M2X3*	1000	51110.020.003	M4X30	200	51110.040.030	M8X25	100	51110.080.025
M2X4	500	51110.020.004	M4X35	200	51110.040.035	M8X30	100	51110.080.030
M2X5	500	51110.020.005	M4X40	200	51110.040.040	M8X35	100	51110.080.035
M2X6	500	51110.020.006	M4X45	200	51110.040.045	M8X40	100	51110.080.040
M2X8	500	51110.020.008	M4X50	200	51110.040.050	M8X45	100	51110.080.045
M2X10	500	51110.020.010	M4X55*	500	51110.040.055	M8X50	100	51110.080.050
M2X12	500	51110.020.012	M4X60	200	51110.040.060	M8X55*	100	51110.080.055
M2X14*	1000	51110.020.014	M4X70	200	51110.040.070	M8X60	100	51110.080.060
M2X16	500	51110.020.016	M4X80	200	51110.040.080	M8X70	100	51110.080.070
M2X18*	1000	51110.020.018	M4X100*	200	51110.040.100	M8X80	100	51110.080.080
M2X20	500	51110.020.020	M5X6*	500	51110.050.006	M8X90	100	51110.080.090
M2X22*	500	51110.020.022	M5X8	200	51110.050.008	M8X100	100	51110.080.100
M2X25	500	51110.020.025	M5X10	200	51110.050.010	M8X110*	100	51110.080.110
M2X28*	500	51110.020.028	M5X12	200	51110.050.012	M8X120*	100	51110.080.120
M2X30*	500	51110.020.030	M5X14*	500	51110.050.014	M8X130*	100	51110.080.130
M2X35*	500	51110.020.035	M5X16	200	51110.050.016	M8X140*	100	51110.080.140
M2X40*	500	51110.020.040	M5X18*	500	51110.050.018	M10X16*	100	51110.100.016
M2,5X4	500	51110.025.004	M5X20	200	51110.050.020	M10X20	50	51110.100.020
M2,5X5	500	51110.025.005	M5X22*	500	51110.050.022	M10X25	50	51110.100.025
M2,5X6	500	51110.025.006	M5X25	200	51110.050.025	M10X30	50	51110.100.030
M2,5X8	500	51110.025.008	M5X28*	500	51110.050.028	M10X35	50	51110.100.035
M2,5X10	500	51110.025.010	M5X30	200	51110.050.030	M10X40	50	51110.100.040
M2,5X12	500	51110.025.012	M5X35	200	51110.050.035	M10X45	50	51110.100.045
M2,5X14*	1000	51110.025.014	M5X40	200	51110.050.040	M10X50	50	51110.100.050
M2,5X16	500	51110.025.016	M5X45	200	51110.050.045	M10X55*	100	51110.100.055
M2,5X20	500	51110.025.020	M5X50	200	51110.050.050	M10X60	50	51110.100.060
M2,5X25*	500	51110.025.025	M5X55	200	51110.050.055	M10X70	50	51110.100.070
M2,5X30*	500	51110.025.030	M5X60	200	51110.050.060	M10X80	50	51110.100.080
M3X3*	500	51110.030.003	M5X65*	200	51110.050.065	M10X90	50	51110.100.090
M3X4	500	51110.030.004	M5X70	200	51110.050.070	M10X100	50	51110.100.100
M3X5*	500	51110.030.005	M5X80	200	51110.050.080	M10X110*	50	51110.100.110
M3X6	500	51110.030.006	M5X90*	200	51110.050.090	M10X120*	50	51110.100.120
M3X8	500	51110.030.008	M5X100	200	51110.050.100	M10X130*	50	51110.100.130
M3X10	500	51110.030.010	M5X120*	200	51110.050.120	M12X20*	50	51110.120.020
M3X12	500	51110.030.012	M6X8	200	51110.060.008	M12X25	100	51110.120.025
M3X14*	500	51110.030.014	M6X10	200	51110.060.010	M12X30*	50	51110.120.030
M3X16	500	51110.030.016	M6X12	200	51110.060.012	M12X35*	50	51110.120.035
M3X18*	500	51110.030.018	M6X14	200	51110.060.014	M12X40*	50	51110.120.040
M3X20	500	51110.030.020	M6X16	200	51110.060.016	M12X45*	50	51110.120.045
M3X22*	500	51110.030.022	M6X18	200	51110.060.018	M12X50*	50	51110.120.050
M3X25	500	51110.030.025	M6X20	200	51110.060.020	M12X55*	50	51110.120.055
M3X30	500	51110.030.030	M6X22*	200	51110.060.022	M12X60*	50	51110.120.060
M3X35	500	51110.030.035	M6X25	200	51110.060.025	M12X70*	50	51110.120.070
M3X40	500	51110.030.040	M6X28*	200	51110.060.028	M12X80*	50	51110.120.080
M3X45*	200	51110.030.045	M6X30	200	51110.060.030	M12X90*	50	51110.120.090
M3X50*	200	51110.030.050	M6X35	100	51110.060.035	M12X100*	50	51110.120.100
M3X60*	200	51110.030.060	M6X40	100	51110.060.040	M12X120*	50	51110.120.120
M3,5X6*	500	51110.035.006	M6X45	100	51110.060.045	M14X110*	25	51110.140.110
M3,5X8*	500	51110.035.008	M6X50	100	51110.060.050	M14X120*	25	51110.140.120
M3,5X10	500	51110.035.010	M6X55*	200	51110.060.055	M16X30*	25	51110.160.030
M3,5X12*	500	51110.035.012	M6X60	100	51110.060.060	M16X35*	25	51110.160.035
M3,5X16*	500	51110.035.016	M6X65	100	51110.060.065	M16X50*	25	51110.160.050
M3,5X20*	500	51110.035.020	M6X70	100	51110.060.070	M16X55*	25	51110.160.055
M3,5X30*	500	51110.035.030	M6X75	100	51110.060.075	M16X60*	25	51110.160.060
M4X5*	500	51110.040.005	M6X80	100	51110.060.080	M16X70*	25	51110.160.070
M4X6	500	51110.040.006	M6X85	100	51110.060.085	M16X120*	10	51110.160.120
M4X8	500	51110.040.008	M6X90	100	51110.060.090	M16X150*	10	51110.160.150
M4X10	500	51110.040.010	M6X100	100	51110.060.100	M18X60*	25	51110.180.060
M4X12	500	51110.040.012	M6X110*	200	51110.060.110	M18X80*	25	51110.180.080
M4X14*	500	51110.040.014	M6X120*	200	51110.060.120	M20X110*	10	51110.200.110
M4X16	500	51110.040.016	M8X10	200	51110.080.010	M20X120*	10	51110.200.120
M4X18*	500	51110.040.018	M8X12	100	51110.080.012	M20X130*	10	51110.200.130
M4X20	500	51110.040.020	M8X14*	200	51110.080.014			
M4X22*	500	51110.040.022	M8X16	100	51110.080.016			
M4X25	200	51110.040.025	M8X18*	200	51110.080.018			
			M8X20	100	51110.080.020			
			M8X22*	200	51110.080.022			

55110		Slotted countersunk head screw		R42A	
Thread	Metric thread				
Material	Stainless steel A4				
				 	

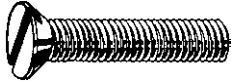

d x L	☒	Art.number	d x L	☒	Art.number	d x L	☒	Art.number
M1X3*	1000	55110.010.003	M4X30	200	55110.040.030	M8X20	100	55110.080.020
M1X4*	1000	55110.010.004	M4X35	200	55110.040.035	M8X25	100	55110.080.025
M1X5*	1000	55110.010.005	M4X40	200	55110.040.040	M8X30	100	55110.080.030
			M4X45	200	55110.040.045	M8X35	100	55110.080.035
M1,6X4*	1000	55110.016.004	M4X50	200	55110.040.050	M8X40	100	55110.080.040
M1,6X5*	1000	55110.016.005	M4X55*	500	55110.040.055	M8X45	100	55110.080.045
M1,6X6*	1000	55110.016.006	M4X60	200	55110.040.060	M8X50	100	55110.080.050
M1,6X8*	1000	55110.016.008	M4X70*	200	55110.040.070	M8X55*	100	55110.080.055
M1,6X10*	1000	55110.016.010				M8X60	100	55110.080.060
			M5X6	200	55110.050.006	M8X70	100	55110.080.070
M2X4*	1000	55110.020.004	M5X8	200	55110.050.008	M8X80	100	55110.080.080
M2X5	500	55110.020.005	M5X10	200	55110.050.010	M8X90	100	55110.080.090
M2X6	500	55110.020.006	M5X12	200	55110.050.012	M8X100	100	55110.080.100
M2X8	500	55110.020.008	M5X14*	500	55110.050.014	M8X110*	100	55110.080.110
M2X10	500	55110.020.010	M5X16	200	55110.050.016	M8X120*	100	55110.080.120
M2X12	500	55110.020.012	M5X18*	500	55110.050.018	M8X140*	100	55110.080.140
M2X16	500	55110.020.016	M5X20	200	55110.050.020			
M2X20	500	55110.020.020	M5X22*	500	55110.050.022	M10X16*	100	55110.100.016
			M5X25	200	55110.050.025	M10X20	50	55110.100.020
M2,5X4*	1000	55110.025.004	M5X30	200	55110.050.030	M10X25	50	55110.100.025
M2,5X5	500	55110.025.005	M5X35	200	55110.050.035	M10X30	50	55110.100.030
M2,5X6	500	55110.025.006	M5X40	200	55110.050.040	M10X35	50	55110.100.035
M2,5X8	500	55110.025.008	M5X45	200	55110.050.045	M10X40	50	55110.100.040
M2,5X10	500	55110.025.010	M5X50	200	55110.050.050	M10X45*	100	55110.100.045
M2,5X12	500	55110.025.012	M5X55*	200	55110.050.055	M10X50	50	55110.100.050
M2,5X14*	1000	55110.025.014	M5X60	200	55110.050.060	M10X55*	100	55110.100.055
M2,5X16	500	55110.025.016	M5X70	200	55110.050.070	M10X60	50	55110.100.060
M2,5X20	500	55110.025.020	M5X75*	200	55110.050.075	M10X70	50	55110.100.070
M2,5X25*	500	55110.025.025	M5X80	200	55110.050.080	M10X80	50	55110.100.080
			M5X90*	200	55110.050.090	M10X90	50	55110.100.090
M3X4*	500	55110.030.004	M5X100*	200	55110.050.100	M10X100	50	55110.100.100
M3X5*	500	55110.030.005				M10X120*	50	55110.100.120
M3X6	500	55110.030.006	M6X8*	500	55110.060.008	M10X140*	50	55110.100.140
M3X8	500	55110.030.008	M6X10	200	55110.060.010			
M3X10	500	55110.030.010	M6X12	200	55110.060.012	M12X20	50	55110.120.020
M3X12	500	55110.030.012	M6X14*	500	55110.060.014	M12X25	50	55110.120.025
M3X14*	500	55110.030.014	M6X16	200	55110.060.016	M12X30	25	55110.120.030
M3X16	500	55110.030.016	M6X18*	500	55110.060.018	M12X35*	50	55110.120.035
M3X18*	500	55110.030.018	M6X20	200	55110.060.020	M12X40	25	55110.120.040
M3X20	500	55110.030.020	M6X22*	200	55110.060.022	M12X45*	50	55110.120.045
M3X25	500	55110.030.025	M6X25	200	55110.060.025	M12X50	25	55110.120.050
M3X30	500	55110.030.030	M6X30	200	55110.060.030	M12X60	25	55110.120.060
M3X35	500	55110.030.035	M6X35	100	55110.060.035	M12X70	25	55110.120.070
M3X40	500	55110.030.040	M6X40	100	55110.060.040	M12X80	25	55110.120.080
M3X45*	200	55110.030.045	M6X45	100	55110.060.045	M12X90	25	55110.120.090
M3X50*	200	55110.030.050	M6X50	100	55110.060.050	M12X100*	50	55110.120.100
M3X60*	200	55110.030.060	M6X55*	200	55110.060.055	M12X120*	50	55110.120.120
			M6X60	100	55110.060.060			
M3,5X8*	500	55110.035.008	M6X65*	200	55110.060.065	M16X25*	25	55110.160.025
			M6X70	100	55110.060.070	M16X35*	25	55110.160.035
M4X5*	500	55110.040.005	M6X80	100	55110.060.080	M16X40*	25	55110.160.040
M4X8	500	55110.040.008	M6X90	100	55110.060.090	M16X45*	25	55110.160.045
M4X10	500	55110.040.010	M6X100	100	55110.060.100	M16X50*	25	55110.160.050
M4X12	500	55110.040.012	M6X110*	200	55110.060.110	M16X60*	25	55110.160.060
M4X14*	500	55110.040.014	M6X120*	200	55110.060.120	M16X70*	25	55110.160.070
M4X16	500	55110.040.016				M16X80*	25	55110.160.080
M4X18*	500	55110.040.018	M8X10*	200	55110.080.010	M16X90*	25	55110.160.090
M4X20	500	55110.040.020	M8X12*	200	55110.080.012	M16X100*	10	55110.160.100
M4X25	200	55110.040.025	M8X16	100	55110.080.016			

48170		Slotted countersunk head screw		M05A	
Thread	Metric thread				
Material	Brass Cu2/Cu3				
				 	

d x L	☒	Art.number	d x L	☒	Art.number	d x L	☒	Art.number
M2X5	200	48170.020.005	M2X12	200	48170.020.012	M2,5X6	200	48170.025.006
M2X6	200	48170.020.006	M2X16	200	48170.020.016	M2,5X8	200	48170.025.008
M2X8	200	48170.020.008	M2X20	200	48170.020.020	M2,5X10	200	48170.025.010
M2X10	200	48170.020.010				M2,5X12	200	48170.025.012

48170 Slotted countersunk head screw								
d x L	☒	Art.number	d x L	☒	Art.number	d x L	☒	Art.number
M2,5X16	200	48170.025.016	M5X12	200	48170.050.012	M8X40	100	48170.080.040
M2,5X20	200	48170.025.020	M5X16	200	48170.050.016	M8X50	100	48170.080.050
			M5X20	200	48170.050.020	M8X60	100	48170.080.060
M3X5	200	48170.030.005	M5X25	200	48170.050.025			
M3X6	200	48170.030.006	M5X30	200	48170.050.030	M10X16	100	48170.100.016
M3X8	200	48170.030.008	M5X35	200	48170.050.035	M10X20	100	48170.100.020
M3X10	200	48170.030.010	M5X40	200	48170.050.040	M10X25	100	48170.100.025
M3X12	200	48170.030.012	M5X50	200	48170.050.050	M10X30	100	48170.100.030
M3X16	200	48170.030.016				M10X35	100	48170.100.035
M3X20	200	48170.030.020	M6X8	200	48170.060.008	M10X40	100	48170.100.040
M3X25	200	48170.030.025	M6X10	200	48170.060.010	M10X45	100	48170.100.045
M3X30	200	48170.030.030	M6X12	200	48170.060.012	M10X50	100	48170.100.050
			M6X16	200	48170.060.016	M10X60	100	48170.100.060
M4X6	200	48170.040.006	M6X20	200	48170.060.020	M10X70	100	48170.100.070
M4X8	200	48170.040.008	M6X25	200	48170.060.025	M10X80	100	48170.100.080
M4X10	200	48170.040.010	M6X30	200	48170.060.030			
M4X12	200	48170.040.012	M6X35	200	48170.060.035	M12X20	100	48170.120.020
M4X16	200	48170.040.016	M6X40	200	48170.060.040	M12X25	100	48170.120.025
M4X20	200	48170.040.020	M6X50	200	48170.060.050	M12X30	100	48170.120.030
M4X25	200	48170.040.025	M6X60	100	48170.060.060	M12X35	100	48170.120.035
M4X30	200	48170.040.030	M6X70	100	48170.060.070	M12X40	100	48170.120.040
M4X35	200	48170.040.035				M12X50	100	48170.120.050
M4X40	200	48170.040.040	M8X16	100	48170.080.016	M12X60	100	48170.120.060
M4X50	200	48170.040.050	M8X20	100	48170.080.020	M12X70	100	48170.120.070
			M8X25	100	48170.080.025	M12X80	100	48170.120.080
M5X8	200	48170.050.008	M8X30	100	48170.080.030			
M5X10	200	48170.050.010	M8X35	100	48170.080.035			

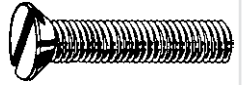
6

48550 Slotted countersunk head screw				M05A
Thread	Metric thread			
Material	Brass Cu2/Cu3			
Surface treatment	Nickel plated			
				

d x L	☒	Art.number	d x L	☒	Art.number	d x L	☒	Art.number
M2,5X10	200	48550.025.010	M4X20	200	48550.040.020	M6X10	200	48550.060.010
M2,5X20	200	48550.025.020	M4X25	200	48550.040.025	M6X16	200	48550.060.016
			M4X30	200	48550.040.030	M6X20	200	48550.060.020
M3X6	200	48550.030.006	M4X35	200	48550.040.035	M6X30	200	48550.060.030
M3X8	200	48550.030.008	M4X50	200	48550.040.050	M6X40	200	48550.060.040
M3X10	200	48550.030.010				M6X50	200	48550.060.050
M3X12	200	48550.030.012	M5X8	200	48550.050.008	M6X60	100	48550.060.060
M3X16	200	48550.030.016	M5X10	200	48550.050.010	M6X80	100	48550.060.080
M3X20	200	48550.030.020	M5X12	200	48550.050.012			
M3X25	200	48550.030.025	M5X16	200	48550.050.016	M8X16	100	48550.080.016
M3X35	200	48550.030.035	M5X20	200	48550.050.020	M8X20	100	48550.080.020
M3X50	200	48550.030.050	M5X25	200	48550.050.025	M8X25	100	48550.080.025
			M5X30	200	48550.050.030	M8X50	100	48550.080.050
M4X8	200	48550.040.008	M5X35	200	48550.050.035	M8X70	100	48550.080.070
M4X10	200	48550.040.010	M5X40	200	48550.050.040	M8X80	100	48550.080.080
M4X12	200	48550.040.012	M5X60	200	48550.050.060			
M4X16	200	48550.040.016	M5X70	200	48550.050.070			

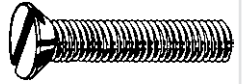
56440 Slotted countersunk head screw				W02A
Thread	Metric thread			
Material	Plastic Polyamide (nylon)			
Class	PA 6.6			
Color	White			

d x L	☒	Art.number	d x L	☒	Art.number	d x L	☒	Art.number
M3X4	200	56440.030.004	M4X16	200	56440.040.016	M5X35	100	56440.050.035
M3X6	200	56440.030.006	M4X18	200	56440.040.018	M5X40	100	56440.050.040
M3X8	200	56440.030.008	M4X20	200	56440.040.020			
M3X10	200	56440.030.010	M4X25	200	56440.040.025	M6X8	100	56440.060.008
M3X12	200	56440.030.012	M4X30	200	56440.040.030	M6X10	50	56440.060.010
M3X16	200	56440.030.016	M4X35	200	56440.040.035	M6X16	50	56440.060.016
M3X20	200	56440.030.020				M6X20	50	56440.060.020
M3X25	200	56440.030.025	M5X8	100	56440.050.008	M6X25	50	56440.060.025
M3X30	200	56440.030.030	M5X10	100	56440.050.010	M6X30	50	56440.060.030
			M5X12	100	56440.050.012	M6X40	50	56440.060.040
M4X6	200	56440.040.006	M5X16	100	56440.050.016	M6X50	50	56440.060.050
M4X8	200	56440.040.008	M5X20	100	56440.050.020			
M4X10	200	56440.040.010	M5X25	100	56440.050.025	M8X20	25	56440.080.020
M4X12	200	56440.040.012	M5X30	100	56440.050.030	M8X25	25	56440.080.025

56440 Slotted countersunk head screw								
d x L	☒	Art.number	d x L	☒	Art.number	d x L	☒	Art.number
M8X30	25	56440.080.030	M8X40	25	56440.080.040	M8X50	25	56440.080.050

Slotted countersunk head screw BSW

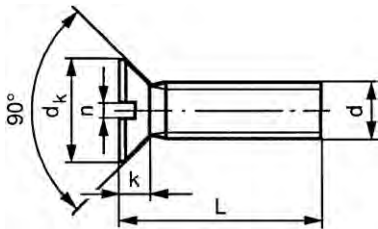

BS ≈450 (1958)
NEN ≈1780 (1960)

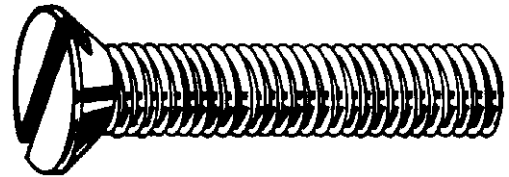

Technical Data				
d	dk	k	n	Threads per inch
1/8	5.5	1.4	0.8	40
5/32	7	1.8	0.9	32
3/16	8.3	2.2	1.1	24
1/4	11	2.8	1.3	20
5/16	13.5	3.4	1.5	18
3/8	16.5	4.2	1.8	16

- Whitworth thread (BSW) is not internationally recommended.
- It is advised to use metric (M).

Article groups					
Thread	Driving features	Material	Class	Code	Page
BSW	Slotted	St	4.8	24220	6-27
BSW	Slotted	Br Cu2		48220	6-27

24220 Slotted countersunk head screw BSW				X07A
Thread	British Standard Whitworth			
Material	Steel			
Class	4.8			

d x L	☒	Art.number	d x L	☒	Art.number	d x L	☒	Art.number
5/32X1/2	100	24220.039.012	3/16X1.1/2	100	24220.047.038	1/4X3 Inch	100	24220.063.076
5/32X5/8	100	24220.039.015	3/16X2 Inch	100	24220.047.050			
5/32X3/4	100	24220.039.019				5/16X5/8	100	24220.079.015
5/32X1 Inch	100	24220.039.025	1/4X3/8	100	24220.063.009	5/16X1 Inch	100	24220.079.025
5/32X1.1/4	100	24220.039.031	1/4X1/2	100	24220.063.012	5/16X1.3/4	50	24220.079.044
5/32X1.1/2	100	24220.039.038	1/4X5/8	100	24220.063.015	5/16X2 Inch	50	24220.079.050
			1/4X3/4	100	24220.063.019	5/16X2.1/2	50	24220.079.063
3/16X3/8	100	24220.047.009	1/4X1 Inch	100	24220.063.025			
3/16X1/2	100	24220.047.012	1/4X1.1/4	100	24220.063.031	3/8X1 Inch	100	24220.096.025
3/16X5/8	100	24220.047.015	1/4X1.1/2	100	24220.063.038	3/8X2 Inch	50	24220.096.050
3/16X3/4	100	24220.047.019	1/4X2 Inch	100	24220.063.050	3/8X2.1/2	50	24220.096.063
3/16X1 Inch	100	24220.047.025	1/4X2.1/2	100	24220.063.063	3/8X3 Inch	50	24220.096.076
3/16X1.1/4	100	24220.047.031						

48220 Slotted countersunk head screw BSW				X07A
Thread	British Standard Whitworth			
Material	Brass Cu2			

d x L	☒	Art.number	d x L	☒	Art.number	d x L	☒	Art.number
1/8X3/8	100	48220.031.009	5/32X3/4	100	48220.039.019	3/16X1 Inch	100	48220.047.025
1/8X1/2	100	48220.031.012	5/32X1 Inch	100	48220.039.025	3/16X1.1/4	100	48220.047.031
1/8X5/8	100	48220.031.015	5/32X1.1/4	100	48220.039.031	3/16X1.1/2	100	48220.047.038
1/8X3/4	100	48220.031.019				3/16X2 Inch	100	48220.047.050
1/8X1 Inch	100	48220.031.025	3/16X3/8	100	48220.047.009			
1/8X1.1/4	100	48220.031.031	3/16X1/2	100	48220.047.012	1/4X3/8	100	48220.063.009
			3/16X5/8	100	48220.047.015	1/4X1/2	100	48220.063.012
5/32X3/8	100	48220.039.009	3/16X3/4	100	48220.047.019	1/4X5/8	100	48220.063.015
5/32X1/2	100	48220.039.012						

48220 Slotted countersunk head screw BSW								
d x L	☒	Art.number	d x L	☒	Art.number	d x L	☒	Art.number
1/4X3/4	100	48220.063.019	5/16X5/8	100	48220.079.015	3/8X3/4	50	48220.096.019
1/4X1 Inch	100	48220.063.025	5/16X3/4	100	48220.079.019	3/8X1 Inch	50	48220.096.025
1/4X1.1/4	100	48220.063.031	5/16X1 Inch	100	48220.079.025	3/8X1.1/2	50	48220.096.038
1/4X1.1/2	100	48220.063.038	5/16X1.1/2	50	48220.079.038	3/8X2 Inch	50	48220.096.050
1/4X2 Inch	100	48220.063.050	5/16X2 Inch	50	48220.079.050	3/8X2.1/2	50	48220.096.063
1/4X2.1/2	50	48220.063.063	5/16X2.1/2	50	48220.079.063	3/8X3 Inch	50	48220.096.076
1/4X3 Inch	50	48220.063.076	5/16X3 Inch	50	48220.079.076			

Slotted raised countersunk head screw

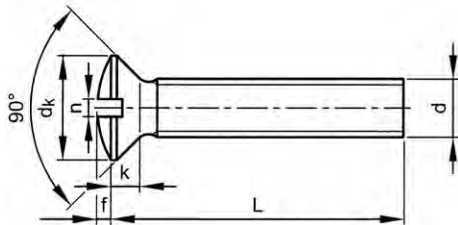

DIN 964
 ISO 2010
 NEN 2371
 ASME B18.6.7M
 NF E25-124
 BS 4183

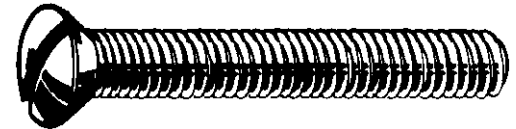

Technical Data

d	dk	f ≈	Full thread L ≤	k (max.)	n	P
M2	3.8	0.5	16	1.2	0.5	0.4
M2.5	4.7	0.6	16	1.5	0.6	0.45
M3	5.6	0.75	20	1.65	0.8	0.5
M4	7.5	1	25	2.2	1	0.7
M5	9.2	1.25	30	2.5	1.2	0.8
M6	11	1.5	35	3	1.6	1
M8	14.5	2	40	4	2	1.25
M10	18	2.5	50	5	2.5	1.5

Article groups

Thread	Driving features	Material	Class	Surface treatment	Code	Page
M	Slotted	St	4.8	Zipl	24570	6-28
M	Slotted	St.St. A2			51210	6-29
M	Slotted	St.St. A4			55210	6-29
M	Slotted	Br Cu2/Cu3			48180	6-30
M	Slotted	Br Cu2/Cu3		Ni.pl.	48570	6-30

24570 Slotted raised countersunk head screw				H01A
Thread	Metric thread			
Material	Steel			
Class	4.8			
Surface treatment	Zinc plated			

d x L	☒	Art.number	d x L	☒	Art.number	d x L	☒	Art.number
M3X6	500	24570.030.006	M4X40	500	24570.040.040	M6X12	200	24570.060.012
M3X8	500	24570.030.008	M4X50	500	24570.040.050	M6X16	200	24570.060.016
M3X10	500	24570.030.010	M4X60	200	24570.040.060	M6X20	200	24570.060.020
M3X12	500	24570.030.012				M6X25	200	24570.060.025
M3X16	500	24570.030.016	M5X8	500	24570.050.008	M6X30	200	24570.060.030
M3X20	500	24570.030.020	M5X10	500	24570.050.010	M6X35	200	24570.060.035
M3X25	500	24570.030.025	M5X12	500	24570.050.012	M6X40	200	24570.060.040
M3X30	500	24570.030.030	M5X16	500	24570.050.016	M6X50	200	24570.060.050
M3X40	500	24570.030.040	M5X20	500	24570.050.020	M6X60	200	24570.060.060
			M5X25	500	24570.050.025			
M4X6	500	24570.040.006	M5X30	500	24570.050.030	M8X16	200	24570.080.016
M4X8	500	24570.040.008	M5X35	500	24570.050.035	M8X20	200	24570.080.020
M4X10	500	24570.040.010	M5X40	500	24570.050.040	M8X25	200	24570.080.025
M4X12	500	24570.040.012	M5X45	200	24570.050.045	M8X30	200	24570.080.030
M4X16	500	24570.040.016	M5X50	200	24570.050.050	M8X40	200	24570.080.040
M4X20	500	24570.040.020	M5X60	200	24570.050.060	M8X50	200	24570.080.050
M4X25	500	24570.040.025				M8X60	100	24570.080.060
M4X30	500	24570.040.030	M6X10	200	24570.060.010			

51210		Slotted raised countersunk head screw		R02A	
Thread	Metric thread				
Material	Stainless steel A2				
				 	

d x L	☒	Art.number	d x L	☒	Art.number	d x L	☒	Art.number
M2X3*	1000	51210.020.003	M4X14	500	51210.040.014	M6X20	200	51210.060.020
M2X4*	1000	51210.020.004	M4X16	500	51210.040.016	M6X25	200	51210.060.025
M2X5	100	51210.020.005	M4X18*	500	51210.040.018	M6X30	200	51210.060.030
M2X6	100	51210.020.006	M4X20	500	51210.040.020	M6X35	100	51210.060.035
M2X8*	1000	51210.020.008	M4X25	200	51210.040.025	M6X40	100	51210.060.040
M2X10*	1000	51210.020.010	M4X30	200	51210.040.030	M6X45	100	51210.060.045
M2X12	100	51210.020.012	M4X35	200	51210.040.035	M6X50	100	51210.060.050
M2X16*	1000	51210.020.016	M4X40	200	51210.040.040	M6X55*	200	51210.060.055
M2X20*	1000	51210.020.020	M4X45	200	51210.040.045	M6X60	100	51210.060.060
M2X30*	500	51210.020.030	M4X50	200	51210.040.050	M6X70	100	51210.060.070
			M4X60	200	51210.040.060	M6X80	100	51210.060.080
M2,5X5*	1000	51210.025.005	M4X70*	200	51210.040.070	M6X90	100	51210.060.090
M2,5X6	100	51210.025.006	M4X80*	200	51210.040.080	M6X100	100	51210.060.100
M2,5X8	100	51210.025.008						
M2,5X10	100	51210.025.010	M5X6	200	51210.050.006	M8X12*	200	51210.080.012
M2,5X12	100	51210.025.012	M5X8	200	51210.050.008	M8X16	100	51210.080.016
M2,5X16	100	51210.025.016	M5X10	200	51210.050.010	M8X20	100	51210.080.020
M2,5X20*	1000	51210.025.020	M5X12	200	51210.050.012	M8X25	100	51210.080.025
M2,5X25*	500	51210.025.025	M5X14*	500	51210.050.014	M8X30	100	51210.080.030
M2,5X30*	500	51210.025.030	M5X16	200	51210.050.016	M8X35	100	51210.080.035
			M5X18*	500	51210.050.018	M8X40	100	51210.080.040
M3X5*	500	51210.030.005	M5X20	200	51210.050.020	M8X45	100	51210.080.045
M3X6	500	51210.030.006	M5X22*	500	51210.050.022	M8X50	100	51210.080.050
M3X8	500	51210.030.008	M5X25	200	51210.050.025	M8X60	100	51210.080.060
M3X10	500	51210.030.010	M5X30	200	51210.050.030	M8X70	100	51210.080.070
M3X12	500	51210.030.012	M5X35	200	51210.050.035	M8X80	100	51210.080.080
M3X14	500	51210.030.014	M5X40	200	51210.050.040	M8X90	100	51210.080.090
M3X16	500	51210.030.016	M5X45	200	51210.050.045	M8X100	100	51210.080.100
M3X18*	500	51210.030.018	M5X50	200	51210.050.050			
M3X20	500	51210.030.020	M5X55*	200	51210.050.055	M10X16*	100	51210.100.016
M3X25	500	51210.030.025	M5X60	100	51210.050.060	M10X20*	100	51210.100.020
M3X30	500	51210.030.030	M5X70	100	51210.050.070	M10X25*	100	51210.100.025
M3X35	500	51210.030.035	M5X80	100	51210.050.080	M10X30	100	51210.100.030
M3X40	500	51210.030.040	M5X90	100	51210.050.090	M10X35	100	51210.100.035
M3X45*	200	51210.030.045	M5X100*	200	51210.050.100	M10X40	100	51210.100.040
M3X50	500	51210.030.050				M10X45*	100	51210.100.045
			M6X8*	500	51210.060.008	M10X50	100	51210.100.050
M4X5*	500	51210.040.005	M6X10	200	51210.060.010	M10X55*	100	51210.100.055
M4X6	500	51210.040.006	M6X12	200	51210.060.012	M10X60	100	51210.100.060
M4X8	500	51210.040.008	M6X14*	500	51210.060.014	M10X70	50	51210.100.070
M4X10	500	51210.040.010	M6X16	200	51210.060.016	M10X100*	50	51210.100.100
M4X12	500	51210.040.012						

6



55210		Slotted raised countersunk head screw		R42A	
Thread	Metric thread				
Material	Stainless steel A4				
				 	

d x L	☒	Art.number	d x L	☒	Art.number	d x L	☒	Art.number
M2X6	100	55210.020.006	M3X30	500	55210.030.030	M4X80*	200	55210.040.080
M2X8	100	55210.020.008	M3X35	500	55210.030.035			
M2X10*	1000	55210.020.010	M3X40	500	55210.030.040	M5X6	200	55210.050.006
M2X16	100	55210.020.016	M3X50	500	55210.030.050	M5X8	200	55210.050.008
M2X20	100	55210.020.020				M5X10	200	55210.050.010
			M4X6	500	55210.040.006	M5X12	200	55210.050.012
M2,5X6	100	55210.025.006	M4X8	500	55210.040.008	M5X14	200	55210.050.014
M2,5X8	100	55210.025.008	M4X10	500	55210.040.010	M5X16	200	55210.050.016
M2,5X10	100	55210.025.010	M4X12	500	55210.040.012	M5X18	200	55210.050.018
M2,5X12	100	55210.025.012	M4X14	500	55210.040.014	M5X20	200	55210.050.020
M2,5X16	100	55210.025.016	M4X16	500	55210.040.016	M5X25	200	55210.050.025
M2,5X25	100	55210.025.025	M4X18	500	55210.040.018	M5X30	200	55210.050.030
			M4X20	500	55210.040.020	M5X35	200	55210.050.035
M3X6	500	55210.030.006	M4X25	200	55210.040.025	M5X40	200	55210.050.040
M3X8	500	55210.030.008	M4X30	200	55210.040.030	M5X45	200	55210.050.045
M3X10	500	55210.030.010	M4X35	200	55210.040.035	M5X50	200	55210.050.050
M3X12	500	55210.030.012	M4X40	200	55210.040.040	M5X60	100	55210.050.060
M3X14	500	55210.030.014	M4X45	200	55210.040.045	M5X70	100	55210.050.070
M3X16	500	55210.030.016	M4X50	200	55210.040.050	M5X80	100	55210.050.080
M3X20	500	55210.030.020	M4X60	200	55210.040.060	M5X90*	200	55210.050.090
M3X25	500	55210.030.025	M4X70*	200	55210.040.070	M5X100	100	55210.050.100

55210 Slotted raised countersunk head screw								
d x L	☒	Art.number	d x L	☒	Art.number	d x L	☒	Art.number
M6X10	200	55210.060.010	M6X80	100	55210.060.080	M8X80*	100	55210.080.080
M6X12	200	55210.060.012	M6X90	100	55210.060.090	M8X90*	100	55210.080.090
M6X14*	500	55210.060.014	M6X100	100	55210.060.100	M8X100*	100	55210.080.100
M6X16	200	55210.060.016	M8X16	100	55210.080.016	M10X20*	100	55210.100.020
M6X20	200	55210.060.020	M8X20	100	55210.080.020	M10X25*	100	55210.100.025
M6X25	200	55210.060.025	M8X25	100	55210.080.025	M10X30*	100	55210.100.030
M6X30	200	55210.060.030	M8X30	100	55210.080.030	M10X35*	100	55210.100.035
M6X35	100	55210.060.035	M8X35	100	55210.080.035	M10X40*	100	55210.100.040
M6X40	100	55210.060.040	M8X40	100	55210.080.040	M10X45*	100	55210.100.045
M6X45	100	55210.060.045	M8X45*	200	55210.080.045	M10X50*	100	55210.100.050
M6X50	100	55210.060.050	M8X50	100	55210.080.050	M10X60*	100	55210.100.060
M6X60	100	55210.060.060	M8X60	100	55210.080.060			
M6X70	100	55210.060.070	M8X70*	100	55210.080.070			

48180 Slotted raised countersunk head screw		M05A
Thread	Metric thread	
Material	Brass Cu2/Cu3	
		
		

d x L	☒	Art.number	d x L	☒	Art.number	d x L	☒	Art.number
M2,5X8	200	48180.025.008	M4X20	200	48180.040.020	M6X12	200	48180.060.012
M2,5X10	200	48180.025.010	M4X25	200	48180.040.025	M6X16	200	48180.060.016
M2,5X12	200	48180.025.012	M4X30	200	48180.040.030	M6X20	200	48180.060.020
M3X6	200	48180.030.006	M5X8	200	48180.050.008	M6X25	200	48180.060.025
M3X8	200	48180.030.008	M5X10	200	48180.050.010	M6X30	200	48180.060.030
M3X10	200	48180.030.010	M5X12	200	48180.050.012	M6X40	200	48180.060.040
M3X12	200	48180.030.012	M5X16	200	48180.050.016	M6X50	200	48180.060.050
M3X16	200	48180.030.016	M5X20	200	48180.050.020	M6X60	100	48180.060.060
M3X20	200	48180.030.020	M5X25	200	48180.050.025	M8X16	100	48180.080.016
M4X6	200	48180.040.006	M5X30	200	48180.050.030	M8X20	100	48180.080.020
M4X8	200	48180.040.008	M5X35	200	48180.050.035	M8X25	100	48180.080.025
M4X10	200	48180.040.010	M5X40	200	48180.050.040	M8X30	100	48180.080.030
M4X12	200	48180.040.012	M5X50	200	48180.050.050	M8X35	100	48180.080.035
M4X16	200	48180.040.016	M6X10	200	48180.060.010	M8X40	100	48180.080.040

48570 Slotted raised countersunk head screw		M05A
Thread	Metric thread	
Material	Brass Cu2/Cu3	
Surface treatment	Nickel plated	
		
		

d x L	☒	Art.number	d x L	☒	Art.number	d x L	☒	Art.number
M3X6	200	48570.030.006	M4X25	200	48570.040.025	M5X40	200	48570.050.040
M3X8	200	48570.030.008	M4X30	200	48570.040.030	M5X50	200	48570.050.050
M3X10	200	48570.030.010	M4X35	200	48570.040.035	M6X10	200	48570.060.010
M3X12	200	48570.030.012	M4X40	200	48570.040.040	M6X12	200	48570.060.012
M3X16	200	48570.030.016	M5X8	200	48570.050.008	M6X16	200	48570.060.016
M3X20	200	48570.030.020	M5X10	200	48570.050.010	M6X20	200	48570.060.020
M4X6	200	48570.040.006	M5X12	200	48570.050.012	M6X25	200	48570.060.025
M4X8	200	48570.040.008	M5X16	200	48570.050.016	M6X30	200	48570.060.030
M4X10	200	48570.040.010	M5X20	200	48570.050.020	M6X40	200	48570.060.040
M4X12	200	48570.040.012	M5X25	200	48570.050.025	M6X50	200	48570.060.050
M4X16	200	48570.040.016	M5X30	200	48570.050.030	M6X60	100	48570.060.060
M4X20	200	48570.040.020	M5X35	200	48570.050.035			

6

Slotted round head screw BSW

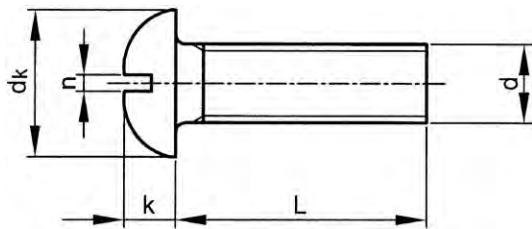

BS ≈450 (1958)
NEN ≈1779 (1960)



Technical Data

d	dk	k	n	Threads per inch
1/8	5.5	2.1	0.8	40
5/32	7	2.7	0.9	32
3/16	8.3	3.2	1.1	24
1/4	11	4.3	1.3	20
5/16	13.5	5.4	1.5	18
3/8	16.5	6.5	1.8	16

- Whitworth thread (BSW) is not internationally recommended.
- It is advised to use metric (M).
- Lengths over 2 inch are partly threaded, min. thread length is 1.3/4 inch.

Article groups

Thread	Driving features	Material	Class	Code	Page
BSW	Slotted	St	4.8	24210	6-31
BSW	Slotted	Br Cu2		48210	6-31

6

24210 Slotted round head screw BSW				X07A
Thread	British Standard Whitworth			
Material	Steel			
Class	4.8			



d x L	☒	Art.number	d x L	☒	Art.number	d x L	☒	Art.number
1/8X3/8	100	24210.031.009	3/16X3/8	100	24210.047.009	1/4X1.1/4	100	24210.063.031
1/8X1/2	100	24210.031.012	3/16X1/2	100	24210.047.012	1/4X1.1/2	100	24210.063.038
1/8X5/8	100	24210.031.015	3/16X5/8	100	24210.047.015	1/4X2 Inch	100	24210.063.050
1/8X3/4	100	24210.031.019	3/16X3/4	100	24210.047.019	1/4X2.1/2	100	24210.063.063
1/8X1 Inch	100	24210.031.025	3/16X1 Inch	100	24210.047.025	1/4X3 Inch	100	24210.063.076
1/8X1.1/4	100	24210.031.031	3/16X1.1/4	100	24210.047.031			
1/8X1.1/2	100	24210.031.038	3/16X1.1/2	100	24210.047.038	5/16X5/8	100	24210.079.015
			3/16X2 Inch	100	24210.047.050	5/16X3/4	100	24210.079.019
5/32X1/2	100	24210.039.012				5/16X1 Inch	100	24210.079.025
5/32X5/8	100	24210.039.015	1/4X3/8	100	24210.063.009	5/16X1.1/4	100	24210.079.031
5/32X3/4	100	24210.039.019	1/4X1/2	100	24210.063.012	5/16X1.1/2	100	24210.079.038
5/32X1 Inch	100	24210.039.025	1/4X5/8	100	24210.063.015	5/16X2 Inch	50	24210.079.050
5/32X1.1/2	100	24210.039.038	1/4X3/4	100	24210.063.019	5/16X2.1/2	50	24210.079.063
			1/4X1 Inch	100	24210.063.025	5/16X3 Inch	50	24210.079.076
3/16X1/4	100	24210.047.006						

48210 Slotted round head screw BSW				X07A
Thread	British Standard Whitworth			
Material	Brass Cu2			
Class				



d x L	☒	Art.number	d x L	☒	Art.number	d x L	☒	Art.number
1/8X3/8	100	48210.031.009	3/16X3/8	100	48210.047.009	1/4X1 Inch	100	48210.063.025
1/8X1/2	100	48210.031.012	3/16X1/2	100	48210.047.012	1/4X1.1/4	100	48210.063.031
1/8X5/8	100	48210.031.015	3/16X5/8	100	48210.047.015	1/4X1.1/2	100	48210.063.038
1/8X3/4	100	48210.031.019	3/16X3/4	100	48210.047.019	1/4X2 Inch	100	48210.063.050
1/8X1 Inch	100	48210.031.025	3/16X1 Inch	100	48210.047.025	1/4X2.1/2	100	48210.063.063
1/8X1.1/4	144	48210.031.031	3/16X1.1/4	100	48210.047.031	1/4X3 Inch	100	48210.063.076
			3/16X1.1/2	100	48210.047.038			
5/32X1/2	100	48210.039.012	3/16X2 Inch	100	48210.047.050	5/16X5/8	100	48210.079.015
5/32X5/8	100	48210.039.015				5/16X3/4	100	48210.079.019
5/32X3/4	100	48210.039.019	1/4X3/8	100	48210.063.009	5/16X1 Inch	100	48210.079.025
5/32X1 Inch	100	48210.039.025	1/4X1/2	100	48210.063.012	5/16X1.1/4	50	48210.079.031
5/32X1.1/4	100	48210.039.031	1/4X5/8	100	48210.063.015	5/16X1.1/2	50	48210.079.038
			1/4X3/4	100	48210.063.019	5/16X2 Inch	50	48210.079.050

48210		Slotted round head screw BSW							
d x L	☒	Art.number	d x L	☒	Art.number	d x L	☒	Art.number	
5/16X2.1/2	50	48210.079.063	3/8X1 Inch	50	48210.096.025	3/8X2.1/2	50	48210.096.063	
5/16X3 Inch	50	48210.079.076	3/8X1.1/4	50	48210.096.031	3/8X3 Inch	50	48210.096.076	
3/8X3/4	50	48210.096.019	3/8X1.1/2	50	48210.096.038				
			3/8X2 Inch	50	48210.096.050				

Slotted mushroom head screw

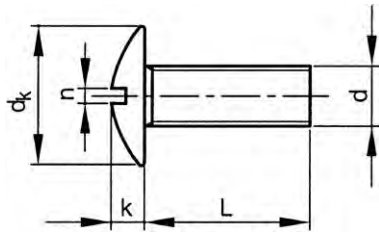

NF ≈E25-129

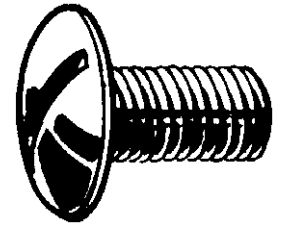

Technical Data

d	dk (max.)	k (max.)	n	P
M3	7	2	0.8	0.5
M4	10	2.2	1.2	0.7
M5	12.5	2.7	1.2	0.8
M6	15	3.3	1.6	1
M8	20	4.4	2.0	1.25

Article groups

Thread	Driving features	Material	Class	Color	Code	Page
M	Slotted	St.St. A2			51215	6-32
M	Slotted	Plastic PA	PA 6.6	White	56460	6-33

51215		Slotted mushroom head screw				R02A	
Thread	Material	Metric thread		Stainless steel A2			

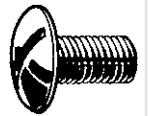

d x L	☒	Art.number	d x L	☒	Art.number	d x L	☒	Art.number
M3X5*	1000	51215.030.005				M6X45*	200	51215.060.045
M3X6*	1000	51215.030.006	M5X8	200	51215.050.008	M6X50*	200	51215.060.050
M3X8*	1000	51215.030.008	M5X10	200	51215.050.010	M6X60*	200	51215.060.060
M3X10*	1000	51215.030.010	M5X12	200	51215.050.012	M6X70*	200	51215.060.070
M3X12*	1000	51215.030.012	M5X16	200	51215.050.016	M6X80*	200	51215.060.080
M3X16*	1000	51215.030.016	M5X20	200	51215.050.020	M6X90*	200	51215.060.090
M3X20*	1000	51215.030.020	M5X25	200	51215.050.025	M6X100*	200	51215.060.100
M3X25*	1000	51215.030.025	M5X30	200	51215.050.030			
M3X35*	1000	51215.030.035	M5X40*	500	51215.050.040	M8X12*	200	51215.080.012
M3X40*	1000	51215.030.040	M5X45*	500	51215.050.045	M8X16*	200	51215.080.016
			M5X50*	500	51215.050.050	M8X20	200	51215.080.020
M4X6*	500	51215.040.006	M5X60*	500	51215.050.060	M8X25*	200	51215.080.025
M4X8	200	51215.040.008	M5X70*	500	51215.050.070	M8X30*	200	51215.080.030
M4X10	200	51215.040.010	M5X80*	500	51215.050.080	M8X35*	200	51215.080.035
M4X12	200	51215.040.012	M5X100*	500	51215.050.100	M8X40*	200	51215.080.040
M4X16	200	51215.040.016				M8X45*	200	51215.080.045
M4X20	200	51215.040.020	M6X8*	500	51215.060.008	M8X50*	200	51215.080.050
M4X25	200	51215.040.025	M6X10	200	51215.060.010	M8X60*	100	51215.080.060
M4X30*	500	51215.040.030	M6X12	200	51215.060.012	M8X70*	100	51215.080.070
M4X35*	500	51215.040.035	M6X16	200	51215.060.016	M8X80*	100	51215.080.080
M4X40*	500	51215.040.040	M6X20	100	51215.060.020	M8X90*	100	51215.080.090
M4X45*	500	51215.040.045	M6X25	100	51215.060.025	M8X100*	100	51215.080.100
M4X50*	500	51215.040.050	M6X30	100	51215.060.030	M8X120*	100	51215.080.120
M4X60*	500	51215.040.060	M6X35*	200	51215.060.035			
M4X70*	500	51215.040.070	M6X40*	200	51215.060.040			

56460 Slotted mushroom head screw		W02A	
Thread	Metric thread		
Material	Plastic Polyamide (nylon)		
Class	PA 6.6		
Color	White		

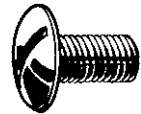

d x L	☒	Art.number	d x L	☒	Art.number	d x L	☒	Art.number
M6X12	50	56460.060.012	M6X25	50	56460.060.025	M6X40	50	56460.060.040
M6X16	50	56460.060.016	M6X30	50	56460.060.030	M6X50	50	56460.060.050
M6X20	50	56460.060.020						

Slotted capstan screw

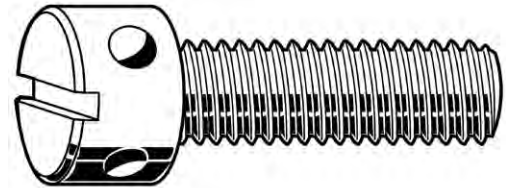
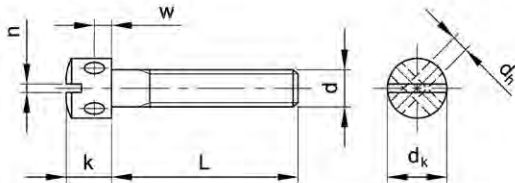

DIN 404



Technical Data						
d	dh (min.)	dk (max.)	k (max.)	n	P	w
M3	1.5	5.5	4	0.8	0.5	1.5
M4	2	7	5	1	0.7	2
M5	2.5	8.5	6.5	1.2	0.8	2.5
M6	3	10	8	1.6	1	3

6

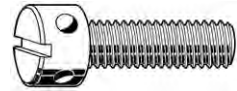
51289 Slotted capstan screw		R09A	
Thread	Metric thread		
Material	Stainless steel A2		
Class	50		

d x L	☒	Art.number	d x L	☒	Art.number	d x L	☒	Art.number
M3X4*	200	51289.030.004	M4X8*	100	51289.040.008	M5X16*	50	51289.050.016
M3X5*	200	51289.030.005	M4X10*	100	51289.040.010	M5X20*	50	51289.050.020
M3X6*	200	51289.030.006	M4X12*	100	51289.040.012	M5X25*	50	51289.050.025
M3X8*	200	51289.030.008	M4X16*	100	51289.040.016	M5X30*	50	51289.050.030
M3X10*	200	51289.030.010	M4X20*	100	51289.040.020			
M3X12*	200	51289.030.012	M4X25*	100	51289.040.025	M6X10*	50	51289.060.010
M3X16*	200	51289.030.016	M4X30*	100	51289.040.030	M6X12*	50	51289.060.012
M3X20*	200	51289.030.020				M6X16*	50	51289.060.016
			M5X8*	50	51289.050.008	M6X20*	50	51289.060.020
M4X5*	100	51289.040.005	M5X10*	50	51289.050.010	M6X25*	50	51289.060.025
M4X6*	100	51289.040.006	M5X12*	50	51289.050.012	M6X30*	50	51289.060.030

Slotted pan head screw with shoulder

DIN 923

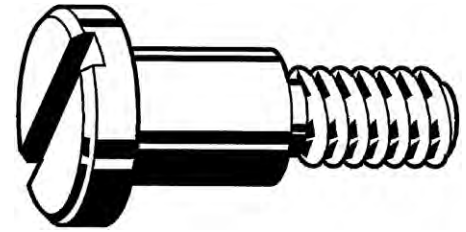
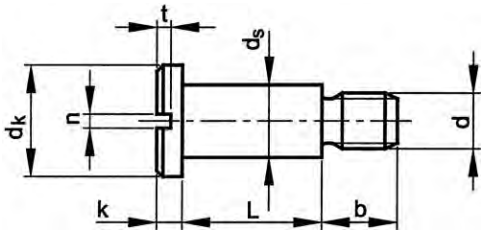

Technical Data

d	b	dk (max.)	ds (h9)	k	n	P	t (min.)
M2	3	4.5	2.8	1.2	0.5	0.4	0.6
M3	4.5	7	4	1.8	0.8	0.5	0.9
M4	6	8.5	5.5	2.4	1	0.7	1.2
M5	7	11	7	2.7	1.2	0.8	1.3
M6	9	13	8	3.1	1.6	1	1.5
M8	11	16	10	3.8	2	1.25	1.9

Article groups

Thread	Driving features	Material	Class	Surface treatment	Code	Page
M	Slotted	St	5.8	Zipl	24992	6-34
M	Slotted	St.St. A1			51209	6-34

6

24992 Slotted pan head screw with shoulder H07A

Thread Metric thread
Material Steel
Class 5.8
Surface treatment Zinc plated



d x L	☒	Art.number	d x L	☒	Art.number	d x L	☒	Art.number
M3X8	100	24992.030.008	M5X6	100	24992.050.006	M6X16	100	24992.060.016
M3X10	100	24992.030.010	M5X8	100	24992.050.008	M6X20	100	24992.060.020
M3X12	100	24992.030.012	M5X12	100	24992.050.012	M6X25	100	24992.060.025
M4X6	100	24992.040.006	M5X16	100	24992.050.016	M8X8	100	24992.080.008
M4X8	100	24992.040.008	M5X20	100	24992.050.020	M8X10	100	24992.080.010
M4X10	100	24992.040.010	M5X25	100	24992.050.025	M8X12	100	24992.080.012
M4X12	100	24992.040.012	M6X8	100	24992.060.008	M8X16	100	24992.080.016
M4X16	100	24992.040.016	M6X10	100	24992.060.010	M8X20	50	24992.080.020
			M6X12	100	24992.060.012	M8X25	50	24992.080.025

51209 Slotted pan head screw with shoulder R09A

Thread Metric thread
Material Stainless steel A1



d x L	☒	Art.number	d x L	☒	Art.number	d x L	☒	Art.number
M2X6*	100	51209.020.006	M4X12*	100	51209.040.012	M6X5*	50	51209.060.005
M3X2*	100	51209.030.002	M4X16*	100	51209.040.016	M6X6*	50	51209.060.006
M3X3*	100	51209.030.003	M4X20*	100	51209.040.020	M6X8*	50	51209.060.008
M3X4*	100	51209.030.004	M5X2*	100	51209.050.002	M6X10*	50	51209.060.010
M3X5*	100	51209.030.005	M5X3*	100	51209.050.003	M6X12*	50	51209.060.012
M3X6*	100	51209.030.006	M5X4*	100	51209.050.004	M6X16*	50	51209.060.016
M3X8*	100	51209.030.008	M5X5*	100	51209.050.005	M6X20*	50	51209.060.020
M3X10*	100	51209.030.010	M5X6*	100	51209.050.006	M6X25*	50	51209.060.025
M4X2*	100	51209.040.002	M5X8*	100	51209.050.008	M8X5*	50	51209.080.005
M4X3*	100	51209.040.003	M5X10*	100	51209.050.010	M8X6*	50	51209.080.006
M4X4*	100	51209.040.004	M5X12*	100	51209.050.012	M8X8*	50	51209.080.008
M4X5*	100	51209.040.005	M5X16*	100	51209.050.016	M8X10*	50	51209.080.010
M4X6*	100	51209.040.006	M6X3*	50	51209.060.003	M8X12*	50	51209.080.012
M4X8*	100	51209.040.008	M6X4*	50	51209.060.004	M8X16*	50	51209.080.016
M4X10*	100	51209.040.010				M8X20*	50	51209.080.020

Slotted screw and washer assembly with plain washer

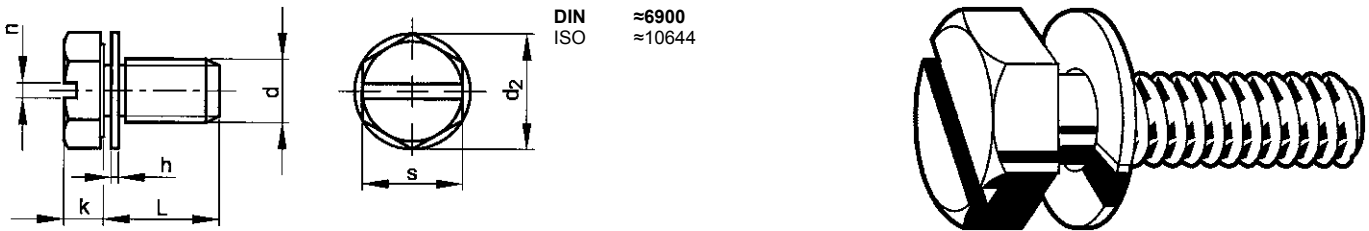

DIN ≈6900
ISO ≈10644

Technical Data

d	d ₂	h	k	n	P	s
M4	8	0.8	2.8	1.2	0.7	7
M5	10	1	3.5	1.2	0.8	8
M6	12	1.2	4	1.6	1	10

24904 Slotted screw and washer assembly with plain washer

H05A

Thread Metric thread
Material Steel
Class 5.8
Surface treatment Zinc plated yellow passivated

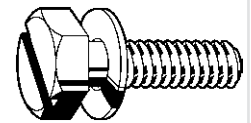

d x L	☒	Art.number	d x L	☒	Art.number	d x L	☒	Art.number
M4X10	1000	24904.040.010	M5X12	1000	24904.050.012	M6X12	500	24904.060.012
M4X16	1000	24904.040.016	M5X18	500	24904.050.018	M6X18	500	24904.060.018

6

Cross recessed raised cheese head screw

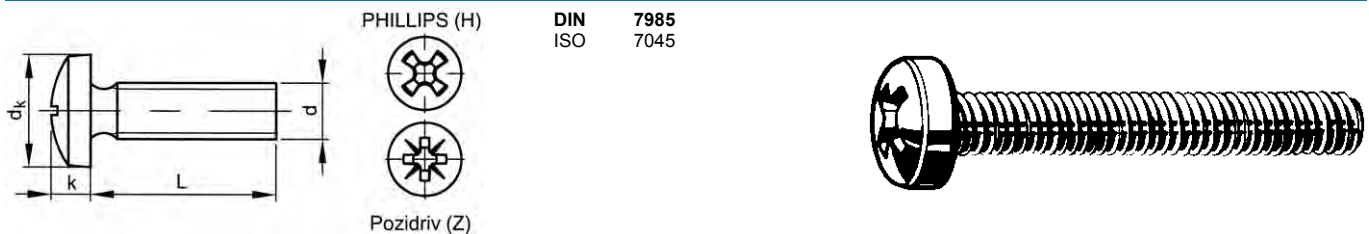

PHILLIPS (H)

DIN 7985
ISO 7045

Pozidriv (Z)

Technical Data

d	d _k	Full thread L ≤	k	No. cross recess	P
M1.6	3.2	16	1.3	0	0.35
M2	4	16	1.6	1	0.4
M2.5	5	20	2	1	0.45
M3	6	20	2.4	1	0.5
M4	8	25	3.1	2	0.7
M5	10	25	3.8	2	0.8
M6	12	35	4.6	3	1
M8	16	40	6	4	1.25
M10	20	40	7.5	4	1.5

Article groups

Thread	Driving features	Material	Class	Surface treatment	Code	Page
M	Phillips	St	4.8	Zipl	24665	6-36
M	Phillips	St	4.8	Zipl large pack	24660	6-36
M	Pozidriv	St	4.8	Zipl	24662	6-37
M	Phillips	St	4.8	Zipl yell.p.	24800	6-37
M	Phillips	St	4.8	Zipl blk p.	24810	6-37
M	Phillips	St.St. A2			51340	6-38
M	Pozidriv	St.St. A2			51342	6-38
M	Phillips	St.St. A4			55340	6-39
M	Pozidriv	St.St. A4			55342	6-40
M	Pozidriv	Al P65		Anod.	45445	6-40

24665 Cross recessed raised cheese head screw Phillips				H05A
Thread	Metric thread	DIN	7985-H	
Material	Steel	ISO	7045-H	
Class	4.8			
Surface treatment	Zinc plated			



d x L	☒	Art.number	d x L	☒	Art.number	d x L	☒	Art.number
M2X4	200	24665.020.004	M4X5	200	24665.040.005	M5X45	100	24665.050.045
M2X5	200	24665.020.005	M4X6	200	24665.040.006	M5X50	100	24665.050.050
M2X6	200	24665.020.006	M4X8	200	24665.040.008	M5X60	100	24665.050.060
M2X8	200	24665.020.008	M4X10	200	24665.040.010	M5X70	100	24665.050.070
M2X10	200	24665.020.010	M4X12	200	24665.040.012	M5X80	100	24665.050.080
			M4X16	200	24665.040.016			
M2,5X4	200	24665.025.004	M4X20	200	24665.040.020	M6X8	200	24665.060.008
M2,5X5	200	24665.025.005	M4X25	200	24665.040.025	M6X10	200	24665.060.010
M2,5X6	200	24665.025.006	M4X30	200	24665.040.030	M6X12	200	24665.060.012
M2,5X8	200	24665.025.008	M4X35	200	24665.040.035	M6X16	200	24665.060.016
M2,5X10	200	24665.025.010	M4X40	200	24665.040.040	M6X20	100	24665.060.020
M2,5X12	200	24665.025.012	M4X45	200	24665.040.045	M6X25	100	24665.060.025
			M4X50	200	24665.040.050	M6X30	100	24665.060.030
M3X4	200	24665.030.004	M4X60	200	24665.040.060	M6X35	100	24665.060.035
M3X5	200	24665.030.005	M4X80	200	24665.040.080	M6X40	100	24665.060.040
M3X6	200	24665.030.006				M6X45	100	24665.060.045
M3X8	200	24665.030.008	M5X6	200	24665.050.006	M6X50	100	24665.060.050
M3X10	200	24665.030.010	M5X8	200	24665.050.008	M6X60	100	24665.060.060
M3X12	200	24665.030.012	M5X10	200	24665.050.010	M6X70	100	24665.060.070
M3X16	200	24665.030.016	M5X12	200	24665.050.012			
M3X20	200	24665.030.020	M5X16	200	24665.050.016	M8X12	100	24665.080.012
M3X25	200	24665.030.025	M5X20	200	24665.050.020	M8X16	100	24665.080.016
M3X30	200	24665.030.030	M5X25	200	24665.050.025	M8X20	100	24665.080.020
M3X40	200	24665.030.040	M5X30	100	24665.050.030	M8X25	100	24665.080.025
M3X50	200	24665.030.050	M5X35	100	24665.050.035	M8X30	100	24665.080.030
			M5X40	100	24665.050.040	M8X35	100	24665.080.035

6

24660 Cross recessed raised cheese head screw Phillips				H05A
Thread	Metric thread	DIN	7985-H	
Material	Steel	ISO	7045-H	
Class	4.8			
Surface treatment	Zinc plated			



d x L	☒	Art.number	d x L	☒	Art.number	d x L	☒	Art.number
M2X4	2000	24660.020.004	M4X6	1000	24660.040.006	M6X12	1000	24660.060.012
M2X5	2000	24660.020.005	M4X8	1000	24660.040.008	M6X16	500	24660.060.016
M2X6	2000	24660.020.006	M4X10	1000	24660.040.010	M6X20	250	24660.060.020
M2X8	2000	24660.020.008	M4X12	1000	24660.040.012	M6X25	250	24660.060.025
M2X10	2000	24660.020.010	M4X16	1000	24660.040.016	M6X30	250	24660.060.030
M2X20	2000	24660.020.020	M4X20	1000	24660.040.020	M6X35	250	24660.060.035
			M4X25	1000	24660.040.025	M6X40	250	24660.060.040
M2,5X4	2000	24660.025.004	M4X30	1000	24660.040.030	M6X45	250	24660.060.045
M2,5X5	2000	24660.025.005	M4X35	500	24660.040.035	M6X50	250	24660.060.050
M2,5X6	2000	24660.025.006	M4X40	500	24660.040.040	M6X60	250	24660.060.060
M2,5X8	2000	24660.025.008	M4X45	500	24660.040.045			
M2,5X10	2000	24660.025.010	M4X50	500	24660.040.050	M8X12	250	24660.080.012
M2,5X12	2000	24660.025.012				M8X16	250	24660.080.016
			M5X8	1000	24660.050.008	M8X20	250	24660.080.020
M3X4	2000	24660.030.004	M5X10	1000	24660.050.010	M8X25	250	24660.080.025
M3X5	2000	24660.030.005	M5X12	1000	24660.050.012	M8X30	250	24660.080.030
M3X6	2000	24660.030.006	M5X16	1000	24660.050.016	M8X35	250	24660.080.035
M3X8	2000	24660.030.008	M5X20	500	24660.050.020	M8X40	100	24660.080.040
M3X10	2000	24660.030.010	M5X25	500	24660.050.025	M8X45	100	24660.080.045
M3X12	2000	24660.030.012	M5X30	250	24660.050.030	M8X50	100	24660.080.050
M3X14	2000	24660.030.014	M5X35	250	24660.050.035	M8X60	100	24660.080.060
M3X16	2000	24660.030.016	M5X40	250	24660.050.040			
M3X20	2000	24660.030.020	M5X45	250	24660.050.045	M10X25	100	24660.100.025
M3X25	1000	24660.030.025	M5X50	250	24660.050.050	M10X30	100	24660.100.030
M3X30	1000	24660.030.030	M5X60	250	24660.050.060	M10X40	100	24660.100.040
M3X40	1000	24660.030.040				M10X50	100	24660.100.050
			M6X8	1000	24660.060.008	M10X60	100	24660.100.060
M4X5	1000	24660.040.005	M6X10	1000	24660.060.010			

24662 Cross recessed raised cheese head screw Pozidriv				H05A	
Thread	Metric thread	DIN	7985-Z		
Material	Steel	ISO	7045-Z		
Class	4.8				
Surface treatment	Zinc plated				





d x L	☒	Art.number	d x L	☒	Art.number	d x L	☒	Art.number
M3X6	2000	24662.030.006	M4X30	1000	24662.040.030	M6X12	1000	24662.060.012
M3X8	2000	24662.030.008	M4X35	500	24662.040.035	M6X16	500	24662.060.016
M3X10	2000	24662.030.010	M4X40	500	24662.040.040	M6X20	250	24662.060.020
M3X12	2000	24662.030.012				M6X25	250	24662.060.025
M3X16	2000	24662.030.016	M5X8	1000	24662.050.008	M6X30	250	24662.060.030
M3X20	2000	24662.030.020	M5X10	1000	24662.050.010	M6X35	250	24662.060.035
M3X25	1000	24662.030.025	M5X12	1000	24662.050.012	M6X40	250	24662.060.040
M3X30	1000	24662.030.030	M5X16	1000	24662.050.016	M6X50	250	24662.060.050
			M5X20	500	24662.050.020	M6X60	250	24662.060.060
M4X5	1000	24662.040.005	M5X25	500	24662.050.025			
M4X6	1000	24662.040.006	M5X30	250	24662.050.030	M8X16	250	24662.080.016
M4X8	1000	24662.040.008	M5X35	250	24662.050.035	M8X20	250	24662.080.020
M4X10	1000	24662.040.010	M5X40	250	24662.050.040	M8X25	250	24662.080.025
M4X12	1000	24662.040.012	M5X45	250	24662.050.045	M8X30	250	24662.080.030
M4X16	1000	24662.040.016	M5X50	250	24662.050.050	M8X40	100	24662.080.040
M4X20	1000	24662.040.020				M8X50	100	24662.080.050
M4X25	1000	24662.040.025	M6X10	1000	24662.060.010			

24800 Cross recessed raised cheese head screw Phillips				H07A	
Thread	Metric thread	DIN	7985-H		
Material	Steel	ISO	7045-H		
Class	4.8				
Surface treatment	Zinc plated yellow passivated				



d x L	☒	Art.number	d x L	☒	Art.number	d x L	☒	Art.number
M3X6	500	24800.030.006	M4X12	200	24800.040.012	M5X40	200	24800.050.040
M3X8	500	24800.030.008	M4X16	200	24800.040.016			
M3X10	500	24800.030.010	M4X20	200	24800.040.020	M6X10	200	24800.060.010
M3X12	500	24800.030.012	M4X25	200	24800.040.025	M6X12	200	24800.060.012
M3X16	500	24800.030.016	M4X30	200	24800.040.030	M6X16	200	24800.060.016
M3X20	500	24800.030.020				M6X20	200	24800.060.020
M3X25	200	24800.030.025	M5X10	200	24800.050.010	M6X25	200	24800.060.025
M3X30	200	24800.030.030	M5X12	200	24800.050.012	M6X30	100	24800.060.030
			M5X16	200	24800.050.016	M6X40	100	24800.060.040
M4X6	200	24800.040.006	M5X20	200	24800.050.020	M6X50	100	24800.060.050
M4X8	200	24800.040.008	M5X25	200	24800.050.025	M6X60	100	24800.060.060
M4X10	200	24800.040.010	M5X30	200	24800.050.030			

24810 Cross recessed raised cheese head screw Phillips				H07A	
Thread	Metric thread	DIN	7985-H		
Material	Steel	ISO	7045-H		
Class	4.8				
Surface treatment	Zinc plated black passivated				

d x L	☒	Art.number	d x L	☒	Art.number	d x L	☒	Art.number
M3X6	200	24810.030.006	M4X50	200	24810.040.050	M6X20	100	24810.060.020
M3X8	200	24810.030.008				M6X25	100	24810.060.025
M3X10	200	24810.030.010	M5X6	200	24810.050.006	M6X30	100	24810.060.030
M3X12	200	24810.030.012	M5X8	200	24810.050.008	M6X35	100	24810.060.035
M3X16	200	24810.030.016	M5X10	200	24810.050.010	M6X40	100	24810.060.040
M3X20	200	24810.030.020	M5X12	200	24810.050.012	M6X45	100	24810.060.045
M3X25	200	24810.030.025	M5X16	200	24810.050.016	M6X50	100	24810.060.050
M3X30	200	24810.030.030	M5X20	200	24810.050.020	M6X55	100	24810.060.055
			M5X25	200	24810.050.025	M6X60	100	24810.060.060
M4X6	200	24810.040.006	M5X30	100	24810.050.030			
M4X8	200	24810.040.008	M5X35	100	24810.050.035	M8X12	100	24810.080.012
M4X10	200	24810.040.010	M5X40	100	24810.050.040	M8X16	100	24810.080.016
M4X12	200	24810.040.012	M5X45	100	24810.050.045	M8X20	100	24810.080.020
M4X16	200	24810.040.016	M5X50	100	24810.050.050	M8X25	100	24810.080.025
M4X20	200	24810.040.020	M5X60	100	24810.050.060	M8X30	100	24810.080.030
M4X25	200	24810.040.025				M8X35	100	24810.080.035
M4X30	200	24810.040.030	M6X10	200	24810.060.010	M8X40	100	24810.080.040
M4X35	200	24810.040.035	M6X12	200	24810.060.012	M8X50	100	24810.080.050
M4X40	200	24810.040.040	M6X16	200	24810.060.016	M8X60	100	24810.080.060

51340	Cross recessed raised cheese head screw Phillips			R01A
Thread Material	Metric thread Stainless steel A2	DIN ISO	7985-H 7045-H	
				

d x L	☒	Art.number	d x L	☒	Art.number	d x L	☒	Art.number
M1,6X2*	1000	51340.016.002	M3X22*	500	51340.030.022	M5X40	100	51340.050.040
M1,6X3*	1000	51340.016.003	M3X25	200	51340.030.025	M5X45	100	51340.050.045
M1,6X4*	1000	51340.016.004	M3X28*	500	51340.030.028	M5X50	100	51340.050.050
M1,6X5*	1000	51340.016.005	M3X30	200	51340.030.030	M5X55*	200	51340.050.055
M1,6X6*	1000	51340.016.006	M3X35	200	51340.030.035	M5X60	100	51340.050.060
M1,6X8*	1000	51340.016.008	M3X40	200	51340.030.040	M5X65*	200	51340.050.065
M1,6X10*	1000	51340.016.010	M3X45*	200	51340.030.045	M5X70*	200	51340.050.070
M1,6X12*	1000	51340.016.012	M3X48*	200	51340.030.048	M5X75*	200	51340.050.075
M1,6X14*	1000	51340.016.014	M3X50	200	51340.030.050	M5X80	200	51340.050.080
M1,6X16*	1000	51340.016.016	M3X55*	200	51340.030.055	M5X90*	200	51340.050.090
M1,6X18*	1000	51340.016.018	M3X60*	200	51340.030.060	M5X100*	200	51340.050.100
M1,6X20*	1000	51340.016.020						
M2X3*	1000	51340.020.003	M4X4*	500	51340.040.004	M6X8	100	51340.060.008
M2X4	100	51340.020.004	M4X5*	500	51340.040.005	M6X10	100	51340.060.010
M2X5	100	51340.020.005	M4X6	200	51340.040.006	M6X12	100	51340.060.012
M2X6	100	51340.020.006	M4X8	200	51340.040.008	M6X14*	500	51340.060.014
M2X8	100	51340.020.008	M4X10	200	51340.040.010	M6X16	100	51340.060.016
M2X10	100	51340.020.010	M4X12	200	51340.040.012	M6X18*	500	51340.060.018
M2X12	100	51340.020.012	M4X14*	500	51340.040.014	M6X20	100	51340.060.020
M2X14*	1000	51340.020.014	M4X16	200	51340.040.016	M6X22*	500	51340.060.022
M2X16	100	51340.020.016	M4X18*	500	51340.040.018	M6X25	100	51340.060.025
M2X18*	1000	51340.020.018	M4X20	200	51340.040.020	M6X28*	200	51340.060.028
M2X20*	1000	51340.020.020	M4X22*	500	51340.040.022	M6X30	100	51340.060.030
			M4X25	200	51340.040.025	M6X35	100	51340.060.035
			M4X28*	500	51340.040.028	M6X40	100	51340.060.040
M2,5X3*	1000	51340.025.003	M4X30	200	51340.040.030	M6X45	100	51340.060.045
M2,5X4*	1000	51340.025.004	M4X35	200	51340.040.035	M6X50	100	51340.060.050
M2,5X5	100	51340.025.005	M4X40	200	51340.040.040	M6X55	200	51340.060.055
M2,5X6	100	51340.025.006	M4X45	200	51340.040.045	M6X60	100	51340.060.060
M2,5X8	100	51340.025.008	M4X50	200	51340.040.050	M6X65*	200	51340.060.065
M2,5X10	100	51340.025.010	M4X55*	500	51340.040.055	M6X70*	100	51340.060.070
M2,5X12	100	51340.025.012	M4X60	100	51340.040.060	M6X80*	100	51340.060.080
M2,5X14*	1000	51340.025.014	M4X65*	500	51340.040.065	M6X90*	100	51340.060.090
M2,5X16	100	51340.025.016	M4X70*	500	51340.040.070	M6X100*	100	51340.060.100
M2,5X18*	1000	51340.025.018	M4X80*	500	51340.040.080			
M2,5X20	100	51340.025.020	M4X90*	500	51340.040.090	M8X10*	200	51340.080.010
M2,5X22*	500	51340.025.022	M4X100*	500	51340.040.100	M8X12	100	51340.080.012
M2,5X25*	500	51340.025.025				M8X16	100	51340.080.016
M2,5X28*	500	51340.025.028	M5X6	100	51340.050.006	M8X20	100	51340.080.020
M2,5X30*	500	51340.025.030	M5X7*	500	51340.050.007	M8X25	100	51340.080.025
			M5X8	100	51340.050.008	M8X30	100	51340.080.030
M3X3*	500	51340.030.003	M5X10	100	51340.050.010	M8X35	100	51340.080.035
M3X4*	500	51340.030.004	M5X12	100	51340.050.012	M8X40	100	51340.080.040
M3X5	200	51340.030.005	M5X14*	500	51340.050.014	M8X45	100	51340.080.045
M3X6	200	51340.030.006	M5X16	100	51340.050.016	M8X50	100	51340.080.050
M3X8	200	51340.030.008	M5X18*	500	51340.050.018	M8X60	100	51340.080.060
M3X10	200	51340.030.010	M5X20	100	51340.050.020	M8X70*	100	51340.080.070
M3X12	200	51340.030.012	M5X22*	500	51340.050.022	M8X80*	100	51340.080.080
M3X14*	500	51340.030.014	M5X25	100	51340.050.025	M8X90*	100	51340.080.090
M3X16	200	51340.030.016	M5X28*	500	51340.050.028			
M3X18*	500	51340.030.018	M5X30	100	51340.050.030	M10X25*	100	51340.100.025
M3X20	200	51340.030.020	M5X35	100	51340.050.035			

51342	Cross recessed raised cheese head screw Pozidriv			R01A
Thread Material	Metric thread Stainless steel A2	DIN ISO	7985-Z 7045-Z	
				

d x L	☒	Art.number	d x L	☒	Art.number	d x L	☒	Art.number
M1,6X2*	1000	51342.016.002	M2X3	100	51342.020.003	M2,5X3	100	51342.025.003
M1,6X3*	1000	51342.016.003	M2X4	100	51342.020.004	M2,5X4	100	51342.025.004
M1,6X4*	1000	51342.016.004	M2X5	100	51342.020.005	M2,5X5	100	51342.025.005
M1,6X5*	1000	51342.016.005	M2X6	100	51342.020.006	M2,5X6	100	51342.025.006
M1,6X6*	1000	51342.016.006	M2X8	100	51342.020.008	M2,5X8	100	51342.025.008
M1,6X8*	1000	51342.016.008	M2X10	100	51342.020.010	M2,5X10	100	51342.025.010
M1,6X10*	1000	51342.016.010	M2X12	100	51342.020.012	M2,5X12	100	51342.025.012
M1,6X14*	1000	51342.016.014	M2X14*	1000	51342.020.014	M2,5X14	100	51342.025.014
M1,6X16*	1000	51342.016.016	M2X16	100	51342.020.016	M2,5X16	100	51342.025.016
M1,6X20*	1000	51342.016.020	M2X18*	1000	51342.020.018	M2,5X18	100	51342.025.018
			M2X20*	1000	51342.020.020			

51342 Cross recessed raised cheese head screw Pozidriv								
d x L	☒	Art.number	d x L	☒	Art.number	d x L	☒	Art.number
M2,5X20	100	51342.025.020	M4X12	200	51342.040.012	M5X40	100	51342.050.040
M2,5X25*	500	51342.025.025	M4X14	200	51342.040.014	M5X45	100	51342.050.045
M2,5X28*	500	51342.025.028	M4X16	200	51342.040.016	M5X50	100	51342.050.050
M2,5X30*	500	51342.025.030	M4X18*	500	51342.040.018	M5X55*	200	51342.050.055
			M4X20	200	51342.040.020	M5X60*	200	51342.050.060
M3X3*	500	51342.030.003	M4X22*	500	51342.040.022	M5X70*	200	51342.050.070
M3X4	200	51342.030.004	M4X25	200	51342.040.025	M5X80*	200	51342.050.080
M3X5	200	51342.030.005	M4X28*	500	51342.040.028	M5X90*	200	51342.050.090
M3X6	200	51342.030.006	M4X30	200	51342.040.030	M5X100*	200	51342.050.100
M3X8	200	51342.030.008	M4X35	200	51342.040.035			
M3X10	200	51342.030.010	M4X40	200	51342.040.040	M6X8	100	51342.060.008
M3X12	200	51342.030.012	M4X45*	500	51342.040.045	M6X10	100	51342.060.010
M3X14	200	51342.030.014	M4X50	200	51342.040.050	M6X12	100	51342.060.012
M3X16	200	51342.030.016	M4X55*	200	51342.040.055	M6X14*	500	51342.060.014
M3X18*	500	51342.030.018	M4X60*	200	51342.040.060	M6X16	100	51342.060.016
M3X20	200	51342.030.020	M4X70*	200	51342.040.070	M6X18*	500	51342.060.018
M3X22*	500	51342.030.022	M4X80*	200	51342.040.080	M6X20	100	51342.060.020
M3X25	200	51342.030.025				M6X25	100	51342.060.025
M3X30	200	51342.030.030	M5X6	100	51342.050.006	M6X30	100	51342.060.030
M3X35	200	51342.030.035	M5X8	100	51342.050.008	M6X35	100	51342.060.035
M3X40	200	51342.030.040	M5X10	100	51342.050.010	M6X40	100	51342.060.040
M3X45*	200	51342.030.045	M5X12	100	51342.050.012	M6X45	100	51342.060.045
M3X50	200	51342.030.050	M5X14*	500	51342.050.014	M6X50	100	51342.060.050
M3X55*	200	51342.030.055	M5X16	100	51342.050.016	M6X55*	200	51342.060.055
M3X60*	200	51342.030.060	M5X18*	500	51342.050.018	M6X60*	200	51342.060.060
			M5X20	100	51342.050.020	M6X70*	100	51342.060.070
M4X4	200	51342.040.004	M5X22*	500	51342.050.022	M6X75*	100	51342.060.075
M4X5	200	51342.040.005	M5X25	100	51342.050.025	M6X80*	100	51342.060.080
M4X6	200	51342.040.006	M5X28*	500	51342.050.028	M6X90*	100	51342.060.090
M4X8	200	51342.040.008	M5X30	100	51342.050.030	M6X100*	100	51342.060.100
M4X10	200	51342.040.010	M5X35	100	51342.050.035			

55340 Cross recessed raised cheese head screw Phillips					R41A
Thread	Metric thread	DIN	7985-H		
Material	Stainless steel A4	ISO	7045-H		

d x L	☒	Art.number	d x L	☒	Art.number	d x L	☒	Art.number
M1,6X2*	1000	55340.016.002	M3X8	200	55340.030.008	M5X8	100	55340.050.008
M1,6X3*	1000	55340.016.003	M3X10	200	55340.030.010	M5X10	100	55340.050.010
M1,6X4*	1000	55340.016.004	M3X12	200	55340.030.012	M5X12	100	55340.050.012
M1,6X5*	1000	55340.016.005	M3X14*	500	55340.030.014	M5X14*	500	55340.050.014
M1,6X6*	1000	55340.016.006	M3X16	200	55340.030.016	M5X16	100	55340.050.016
M1,6X8*	1000	55340.016.008	M3X18*	500	55340.030.018	M5X18*	500	55340.050.018
M1,6X10*	1000	55340.016.010	M3X20	200	55340.030.020	M5X20	100	55340.050.020
M1,6X12*	1000	55340.016.012	M3X25	200	55340.030.025	M5X22*	500	55340.050.022
M1,6X16*	1000	55340.016.016	M3X30	200	55340.030.030	M5X25	100	55340.050.025
			M3X35*	500	55340.030.035	M5X30	100	55340.050.030
M2X3*	1000	55340.020.003	M3X40*	500	55340.030.040	M5X35	100	55340.050.035
M2X4	100	55340.020.004	M3X45*	200	55340.030.045	M5X40	100	55340.050.040
M2X5	100	55340.020.005	M3X50*	200	55340.030.050	M5X45	100	55340.050.045
M2X6	100	55340.020.006	M3X60*	500	55340.030.060	M5X50	100	55340.050.050
M2X8	100	55340.020.008				M5X55*	200	55340.050.055
M2X10	100	55340.020.010	M4X4*	500	55340.040.004	M5X60*	200	55340.050.060
M2X12	100	55340.020.012	M4X5	200	55340.040.005	M5X70*	200	55340.050.070
M2X14*	1000	55340.020.014	M4X6	200	55340.040.006	M5X80*	200	55340.050.080
M2X16	100	55340.020.016	M4X8	200	55340.040.008	M5X90*	200	55340.050.090
M2X18*	1000	55340.020.018	M4X10	200	55340.040.010	M5X100*	200	55340.050.100
M2X20*	1000	55340.020.020	M4X12	200	55340.040.012			
			M4X14*	500	55340.040.014	M6X8	100	55340.060.008
M2,5X4	100	55340.025.004	M4X16	200	55340.040.016	M6X10	100	55340.060.010
M2,5X5	100	55340.025.005	M4X18*	500	55340.040.018	M6X12	100	55340.060.012
M2,5X6	100	55340.025.006	M4X20	200	55340.040.020	M6X14*	500	55340.060.014
M2,5X8	100	55340.025.008	M4X22*	500	55340.040.022	M6X16	100	55340.060.016
M2,5X10	100	55340.025.010	M4X25	200	55340.040.025	M6X18*	500	55340.060.018
M2,5X12	100	55340.025.012	M4X30	200	55340.040.030	M6X20	100	55340.060.020
M2,5X14*	1000	55340.025.014	M4X35	200	55340.040.035	M6X22*	500	55340.060.022
M2,5X16	100	55340.025.016	M4X40	200	55340.040.040	M6X25	100	55340.060.025
M2,5X18*	1000	55340.025.018	M4X45*	500	55340.040.045	M6X28*	200	55340.060.028
M2,5X20	100	55340.025.020	M4X50	200	55340.040.050	M6X30	100	55340.060.030
M2,5X25*	500	55340.025.025	M4X55*	500	55340.040.055	M6X35	100	55340.060.035
M2,5X30*	500	55340.025.030	M4X60*	500	55340.040.060	M6X40	100	55340.060.040
			M4X70*	500	55340.040.070	M6X45	100	55340.060.045
M3X3*	500	55340.030.003	M4X80*	500	55340.040.080	M6X50	100	55340.060.050
M3X4	200	55340.030.004	M4X90*	500	55340.040.090	M6X60	200	55340.060.060
M3X5*	500	55340.030.005				M6X65*	200	55340.060.065
M3X6	200	55340.030.006	M5X6*	500	55340.050.006	M6X70	200	55340.060.070

55340 Cross recessed raised cheese head screw Phillips								
d x L	☒	Art.number	d x L	☒	Art.number	d x L	☒	Art.number
M6X80	200	55340.060.080	M8X16	100	55340.080.016	M8X40	100	55340.080.040
M6X90*	200	55340.060.090	M8X20	100	55340.080.020	M8X45*	200	55340.080.045
M6X100*	200	55340.060.100	M8X25	100	55340.080.025	M8X50	100	55340.080.050
			M8X30	100	55340.080.030	M8X60*	100	55340.080.060
M8X12*	200	55340.080.012	M8X35*	200	55340.080.035			

55342 Cross recessed raised cheese head screw Pozidriv				R41A
Thread	Metric thread	DIN	7985-Z	
Material	Stainless steel A4	ISO	7045-Z	
				

d x L	☒	Art.number	d x L	☒	Art.number	d x L	☒	Art.number
M1,6X3*	1000	55342.016.003	M3X8*	500	55342.030.008	M5X10	500	55342.050.010
M1,6X4*	1000	55342.016.004	M3X10*	500	55342.030.010	M5X12*	500	55342.050.012
M1,6X5*	1000	55342.016.005	M3X12*	500	55342.030.012	M5X14*	500	55342.050.014
M1,6X6*	1000	55342.016.006	M3X14*	500	55342.030.014	M5X16*	500	55342.050.016
M1,6X10*	1000	55342.016.010	M3X16*	500	55342.030.016	M5X18*	500	55342.050.018
M1,6X12*	1000	55342.016.012	M3X18*	500	55342.030.018	M5X20*	500	55342.050.020
M1,6X14*	1000	55342.016.014	M3X20*	500	55342.030.020	M5X25*	500	55342.050.025
			M3X22*	500	55342.030.022	M5X30*	500	55342.050.030
M2X3*	1000	55342.020.003	M3X25*	500	55342.030.025	M5X35*	500	55342.050.035
M2X4*	1000	55342.020.004	M3X30*	500	55342.030.030	M5X40*	500	55342.050.040
M2X5*	1000	55342.020.005	M3X35*	500	55342.030.035	M5X45*	200	55342.050.045
M2X6*	1000	55342.020.006	M3X40*	500	55342.030.040	M5X50*	200	55342.050.050
M2X8*	1000	55342.020.008	M3X45*	200	55342.030.045	M5X60*	200	55342.050.060
M2X10*	1000	55342.020.010	M3X50*	200	55342.030.050	M5X70*	200	55342.050.070
M2X12*	1000	55342.020.012	M3X55*	200	55342.030.055	M5X80*	200	55342.050.080
M2X14*	1000	55342.020.014	M3X60*	200	55342.030.060	M5X90*	200	55342.050.090
M2X16*	1000	55342.020.016				M5X100*	200	55342.050.100
M2X18*	1000	55342.020.018	M4X4*	500	55342.040.004			
M2X20*	1000	55342.020.020	M4X5*	500	55342.040.005	M6X8*	500	55342.060.008
			M4X6	500	55342.040.006	M6X10*	500	55342.060.010
M2,5X3*	1000	55342.025.003	M4X8*	500	55342.040.008	M6X12*	500	55342.060.012
M2,5X4*	1000	55342.025.004	M4X10	500	55342.040.010	M6X16*	500	55342.060.016
M2,5X5*	1000	55342.025.005	M4X12	500	55342.040.012	M6X20*	500	55342.060.020
M2,5X6*	1000	55342.025.006	M4X14*	500	55342.040.014	M6X25*	200	55342.060.025
M2,5X8*	1000	55342.025.008	M4X16	500	55342.040.016	M6X30*	200	55342.060.030
M2,5X10*	1000	55342.025.010	M4X18*	500	55342.040.018	M6X35*	200	55342.060.035
M2,5X12*	1000	55342.025.012	M4X20*	500	55342.040.020	M6X40*	200	55342.060.040
M2,5X14*	1000	55342.025.014	M4X25*	500	55342.040.025	M6X45*	200	55342.060.045
M2,5X16*	1000	55342.025.016	M4X30*	500	55342.040.030	M6X50*	200	55342.060.050
M2,5X18*	1000	55342.025.018	M4X35*	500	55342.040.035	M6X55*	200	55342.060.055
M2,5X20*	1000	55342.025.020	M4X40*	500	55342.040.040	M6X60*	200	55342.060.060
M2,5X25*	500	55342.025.025	M4X45*	500	55342.040.045	M6X65*	100	55342.060.065
M2,5X30*	500	55342.025.030	M4X50*	500	55342.040.050	M6X70*	100	55342.060.070
			M4X55*	200	55342.040.055	M6X75*	100	55342.060.075
M3X3*	500	55342.030.003	M4X60*	200	55342.040.060	M6X80*	100	55342.060.080
M3X4*	500	55342.030.004				M6X90*	100	55342.060.090
M3X5*	500	55342.030.005	M5X6*	500	55342.050.006	M6X100*	100	55342.060.100
M3X6*	500	55342.030.006	M5X8*	500	55342.050.008			

45445 Cross recessed raised cheese head screw Pozidriv				W010
Thread	Metric thread	DIN	≈7985-Z	
Material	Aluminium P65	ISO	≈7045-Z	
Surface treatment	Anodized			

d x L	☒	Art.number	d x L	☒	Art.number	d x L	☒	Art.number
M3X10	200	45445.030.010	M4X30	200	45445.040.030			
M3X12	200	45445.030.012				M6X12	200	45445.060.012
M3X16	200	45445.030.016	M5X10	200	45445.050.010	M6X16	200	45445.060.016
M3X20	200	45445.030.020	M5X12	200	45445.050.012	M6X20	200	45445.060.020
			M5X16	200	45445.050.016	M6X30	200	45445.060.030
M4X12	200	45445.040.012	M5X20	200	45445.050.020	M6X35	200	45445.060.035
M4X16	200	45445.040.016	M5X25	200	45445.050.025	M6X40	200	45445.060.040
M4X20	200	45445.040.020	M5X30	200	45445.050.030			
M4X25	200	45445.040.025	M5X40	200	45445.050.040			

Hexalobular socket raised cheese head screw

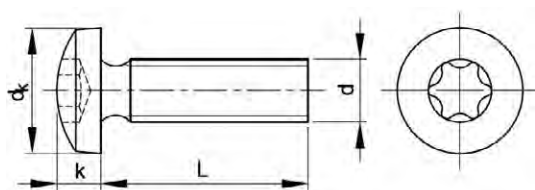

ISO 14583



Technical Data

d	d _k	k	P	Socket
M1.6	3.2	1.3	0.35	T5
M2	4	1.6	0.4	T6
M2.5	5	2.1	0.45	T8
M3	5.6	2.4	0.5	T10
M3.5	7	2.6	0.6	T15
M4	8	3.1	0.7	T20
M5	9.5	3.7	0.8	T25
M6	12	4.6	1	T30
M8	16	6	1.25	T45
M10	20	7.5	1.5	T50

Article groups

Thread	Driving features	Material	Class	Surface treatment	Code	Page
M	Hexalobular	St	8.8	Zipl	24422	6-41
M	Hexalobular	St.St. A2			51345	6-41
M	Hexalobular	St.St. A4			55345	6-42

6

24422 Hexalobular socket raised cheese head screw

H07A

Thread	Metric thread
Material	Steel
Class	8.8
Surface treatment	Zinc plated



d x L	Art.number	d x L	Art.number	d x L	Art.number
M4X8	200 24422.040.008	M5X8	200 24422.050.008	M6X10	200 24422.060.010
M4X10	200 24422.040.010	M5X10	200 24422.050.010	M6X12	200 24422.060.012
M4X12	200 24422.040.012	M5X12	200 24422.050.012	M6X16	200 24422.060.016
M4X16	200 24422.040.016	M5X16	200 24422.050.016	M6X20	200 24422.060.020
M4X20	200 24422.040.020	M5X20	200 24422.050.020		

51345 Hexalobular socket raised cheese head screw

R01A

Thread	Metric thread
Material	Stainless steel A2



d x L	Art.number	d x L	Art.number	d x L	Art.number
M1,6X2*	1000 51345.016.002	M2X16*	1000 51345.020.016	M2,5X30*	500 51345.025.030
M1,6X3*	1000 51345.016.003	M2X18*	1000 51345.020.018	M3X3*	500 51345.030.003
M1,6X4*	1000 51345.016.004	M2X20*	1000 51345.020.020	M3X4*	500 51345.030.004
M1,6X5*	1000 51345.016.005			M3X5	500 51345.030.005
M1,6X6*	1000 51345.016.006	M2,5X3*	1000 51345.025.003	M3X6	200 51345.030.006
M1,6X8*	1000 51345.016.008	M2,5X4	1000 51345.025.004	M3X8	200 51345.030.008
M1,6X10*	1000 51345.016.010	M2,5X5*	1000 51345.025.005	M3X10	200 51345.030.010
M1,6X12*	1000 51345.016.012	M2,5X6	1000 51345.025.006	M3X12	200 51345.030.012
M1,6X16*	1000 51345.016.016	M2,5X8*	1000 51345.025.008	M3X14*	500 51345.030.014
		M2,5X10	1000 51345.025.010	M3X16	200 51345.030.016
M2X3*	1000 51345.020.003	M2,5X12*	1000 51345.025.012	M3X18*	500 51345.030.018
M2X4*	1000 51345.020.004	M2,5X14*	1000 51345.025.014	M3X20	200 51345.030.020
M2X5*	1000 51345.020.005	M2,5X16*	1000 51345.025.016	M3X22*	500 51345.030.022
M2X6	1000 51345.020.006	M2,5X18*	1000 51345.025.018	M3X25*	500 51345.030.025
M2X8*	1000 51345.020.008	M2,5X20*	1000 51345.025.020	M3X28*	500 51345.030.028
M2X10*	1000 51345.020.010	M2,5X22*	1000 51345.025.022	M3X30	500 51345.030.030
M2X12*	1000 51345.020.012	M2,5X25*	500 51345.025.025	M3X35*	500 51345.030.035
M2X14*	1000 51345.020.014	M2,5X28*	500 51345.025.028		

51345 Hexalobular socket raised cheese head screw ←								
d x L	☒	Art.number	d x L	☒	Art.number	d x L	☒	Art.number
M3X40*	500	51345.030.040	M5X6*	500	51345.050.006	M6X22*	500	51345.060.022
M3X45*	200	51345.030.045	M5X8	200	51345.050.008	M6X25	100	51345.060.025
M3X50*	200	51345.030.050	M5X10	200	51345.050.010	M6X28*	200	51345.060.028
M3X55*	200	51345.030.055	M5X12	200	51345.050.012	M6X30	100	51345.060.030
M3X60*	200	51345.030.060	M5X14*	200	51345.050.014	M6X35	50	51345.060.035
M4X4*	500	51345.040.004	M5X16	500	51345.050.016	M6X40	50	51345.060.040
M4X5*	500	51345.040.005	M5X18*	200	51345.050.018	M6X45*	200	51345.060.045
M4X6	500	51345.040.006	M5X20	500	51345.050.020	M6X50*	200	51345.060.050
M4X8	200	51345.040.008	M5X22*	200	51345.050.022	M6X55*	200	51345.060.055
M4X10	200	51345.040.010	M5X25*	500	51345.050.025	M6X60*	200	51345.060.060
M4X12	200	51345.040.012	M5X28*	500	51345.050.028	M6X65*	200	51345.060.065
M4X14	500	51345.040.014	M5X30	100	51345.050.030	M6X70*	100	51345.060.070
M4X16	200	51345.040.016	M5X35	100	51345.050.035	M6X75*	100	51345.060.075
M4X18*	500	51345.040.018	M5X40	100	51345.050.040	M6X80*	100	51345.060.080
M4X20	200	51345.040.020	M5X45*	100	51345.050.045	M6X90*	100	51345.060.090
M4X22*	500	51345.040.022	M5X50*	200	51345.050.050	M6X100*	100	51345.060.100
M4X25	200	51345.040.025	M5X55*	200	51345.050.055	M8X10*	200	51345.080.010
M4X28*	500	51345.040.028	M5X60*	200	51345.050.060	M8X12*	200	51345.080.012
M4X30	200	51345.040.030	M5X70*	200	51345.050.070	M8X16*	200	51345.080.016
M4X35	200	51345.040.035	M5X80*	200	51345.050.080	M8X20	200	51345.080.020
M4X40	200	51345.040.040	M5X90*	200	51345.050.090	M8X25*	200	51345.080.025
M4X45*	500	51345.040.045	M5X100*	200	51345.050.100	M8X30	200	51345.080.030
M4X50*	500	51345.040.050	M6X8*	500	51345.060.008	M8X35*	200	51345.080.035
M4X55*	500	51345.040.055	M6X10	100	51345.060.010	M8X40*	200	51345.080.040
M4X60*	500	51345.040.060	M6X12	100	51345.060.012	M8X45*	200	51345.080.045
M4X65*	500	51345.040.065	M6X14*	500	51345.060.014	M8X50*	200	51345.080.050
M4X70*	500	51345.040.070	M6X16	100	51345.060.016	M8X60*	200	51345.080.060
M4X80*	500	51345.040.080	M6X18*	500	51345.060.018	M8X70*	200	51345.080.070
M4X90*	500	51345.040.090	M6X20	100	51345.060.020	M8X80*	200	51345.080.080
M4X100*	500	51345.040.100						

55345 Hexalobular socket raised cheese head screw		R41A
Thread	Metric thread	
Material	Stainless steel A4	
		

d x L	☒	Art.number	d x L	☒	Art.number	d x L	☒	Art.number
M1.6X3*	1000	55345.016.003	M3X12*	500	55345.030.012	M5X22*	500	55345.050.022
M1.6X4*	1000	55345.016.004	M3X14*	500	55345.030.014	M5X25*	500	55345.050.025
M1.6X5*	1000	55345.016.005	M3X16*	500	55345.030.016	M5X30*	500	55345.050.030
M1.6X6*	1000	55345.016.006	M3X18*	500	55345.030.018	M5X35*	500	55345.050.035
M1.6X8*	1000	55345.016.008	M3X20*	500	55345.030.020	M5X40*	500	55345.050.040
M1.6X10*	1000	55345.016.010	M3X25*	500	55345.030.025	M5X45*	200	55345.050.045
M1.6X12*	1000	55345.016.012	M3X30*	500	55345.030.030	M5X50*	200	55345.050.050
M1.6X16*	1000	55345.016.016	M3X35*	500	55345.030.035	M5X55*	200	55345.050.055
M2X3*	1000	55345.020.003	M3X40*	500	55345.030.040	M5X60*	200	55345.050.060
M2X4*	1000	55345.020.004	M3X45*	500	55345.030.045	M5X70*	200	55345.050.070
M2X6*	1000	55345.020.006	M3X50*	500	55345.030.050	M5X80*	200	55345.050.080
M2X8*	1000	55345.020.008	M4X5*	500	55345.040.005	M5X90*	200	55345.050.090
M2X10*	1000	55345.020.010	M4X6*	500	55345.040.006	M5X100*	200	55345.050.100
M2X12*	1000	55345.020.012	M4X8*	500	55345.040.008	M6X8*	500	55345.060.008
M2X14*	1000	55345.020.014	M4X10*	500	55345.040.010	M6X10*	500	55345.060.010
M2X16*	1000	55345.020.016	M4X12*	500	55345.040.012	M6X12*	500	55345.060.012
M2X18*	1000	55345.020.018	M4X14*	500	55345.040.014	M6X14*	500	55345.060.014
M2X20*	1000	55345.020.020	M4X16*	500	55345.040.016	M6X16*	500	55345.060.016
M2.5X3*	1000	55345.025.003	M4X18*	500	55345.040.018	M6X20*	200	55345.060.020
M2.5X4*	1000	55345.025.004	M4X20*	500	55345.040.020	M6X22*	200	55345.060.022
M2.5X5*	1000	55345.025.005	M4X22*	500	55345.040.022	M6X25*	200	55345.060.025
M2.5X6*	1000	55345.025.006	M4X25*	500	55345.040.025	M6X30*	200	55345.060.030
M2.5X8*	1000	55345.025.008	M4X30*	500	55345.040.030	M6X35*	200	55345.060.035
M2.5X10*	1000	55345.025.010	M4X35*	500	55345.040.035	M6X40*	200	55345.060.040
M2.5X12*	1000	55345.025.012	M4X40*	500	55345.040.040	M6X45*	200	55345.060.045
M2.5X14*	1000	55345.025.014	M4X45*	500	55345.040.045	M6X50*	200	55345.060.050
M2.5X16*	1000	55345.025.016	M4X50*	500	55345.040.050	M6X55*	200	55345.060.055
M2.5X20*	1000	55345.025.020	M4X55*	500	55345.040.055	M6X60*	200	55345.060.060
M2.5X25*	500	55345.025.025	M4X60*	500	55345.040.060	M6X70*	100	55345.060.070
M2.5X30*	500	55345.025.030	M5X6*	500	55345.050.006	M6X80*	100	55345.060.080
M3X3*	500	55345.030.003	M5X8*	500	55345.050.008	M6X90*	100	55345.060.090
M3X4*	500	55345.030.004	M5X10*	500	55345.050.010	M6X100*	100	55345.060.100
M3X5*	500	55345.030.005	M5X12*	500	55345.050.012	M8X10*	200	55345.080.010
M3X6*	500	55345.030.006	M5X14*	500	55345.050.014	M8X12*	200	55345.080.012
M3X8*	500	55345.030.008	M5X16*	500	55345.050.016	M8X16*	200	55345.080.016
M3X10*	500	55345.030.010	M5X18*	500	55345.050.018	M8X20*	200	55345.080.020
			M5X20*	500	55345.050.020	M8X25*	200	55345.080.025

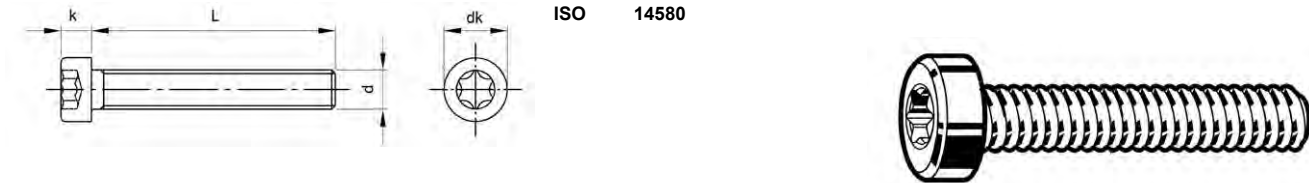

55345 Hexalobular socket raised cheese head screw								
d x L	☒	Art.number	d x L	☒	Art.number	d x L	☒	Art.number
M8X30*	200	55345.080.030	M8X45*	200	55345.080.045	M8X70*	200	55345.080.070
M8X35*	200	55345.080.035	M8X50*	200	55345.080.050	M8X80*	200	55345.080.080
M8X40*	200	55345.080.040	M8X60*	200	55345.080.060			

Hexalobular cap screw low head



Technical Data				
d	d _k (max.)	k (max.)	P	Socket
M2	3.8	1.55	0.4	T6
M2.5	4.5	1.85	0.45	T8
M3	5.5	2.4	0.5	T10
M4	7	3.1	0.7	T20
M5	8.5	3.65	0.8	T25
M6	10	4.4	1	T30
M8	13	5.8	1.25	T45

6

51122 Hexalobular cap screw low head		Q05A
Thread	Metric thread	 
Material	Stainless steel A2	
Class	50	

d x L	☒	Art.number	d x L	☒	Art.number	d x L	☒	Art.number
M2X3*	1000	51122.020.003	M3X12*	1000	51122.030.012	M6X12*	500	51122.060.012
M2X4*	1000	51122.020.004	M3X16*	1000	51122.030.016	M6X16*	200	51122.060.016
M2X5*	1000	51122.020.005	M3X20*	1000	51122.030.020	M6X20*	200	51122.060.020
M2X6*	1000	51122.020.006				M6X25*	200	51122.060.025
M2X8*	1000	51122.020.008	M4X6*	1000	51122.040.006	M6X30*	200	51122.060.030
M2X10*	1000	51122.020.010	M4X8*	1000	51122.040.008	M6X35*	200	51122.060.035
M2X12*	1000	51122.020.012	M4X10*	1000	51122.040.010	M6X40*	200	51122.060.040
			M4X12*	1000	51122.040.012			
M2,5X3*	1000	51122.025.003	M4X16*	1000	51122.040.016	M8X10*	500	51122.080.010
M2,5X4*	1000	51122.025.004	M4X20*	500	51122.040.020	M8X12*	500	51122.080.012
M2,5X5*	1000	51122.025.005	M4X25*	500	51122.040.025	M8X16*	200	51122.080.016
M2,5X6*	1000	51122.025.006				M8X20*	200	51122.080.020
M2,5X8*	1000	51122.025.008	M5X8*	500	51122.050.008	M8X25*	200	51122.080.025
M2,5X10*	1000	51122.025.010	M5X10*	500	51122.050.010	M8X30*	100	51122.080.030
M2,5X12*	1000	51122.025.012	M5X12*	500	51122.050.012	M8X35*	100	51122.080.035
M2,5X16*	1000	51122.025.016	M5X16*	500	51122.050.016	M8X40*	100	51122.080.040
			M5X20*	500	51122.050.020	M8X45*	100	51122.080.045
M3X4*	1000	51122.030.004	M5X25*	200	51122.050.025	M8X50*	100	51122.080.050
M3X5*	1000	51122.030.005	M5X30*	200	51122.050.030	M8X55*	100	51122.080.055
M3X6*	1000	51122.030.006				M8X60*	100	51122.080.060
M3X8*	1000	51122.030.008	M6X8*	500	51122.060.008			
M3X10*	1000	51122.030.010	M6X10*	500	51122.060.010			

Cross recessed countersunk head screw

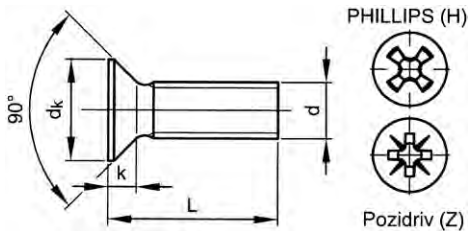

DIN 965
ISO 7046-1
NF E25-119-1

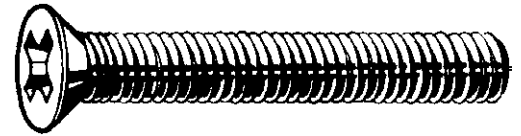

Technical Data

d	d _k	Full thread L ≤	k (max.)	No. cross recess	P
M1.6	3	12	0.96	0	0.35
M2	3.8	16	1.2	1	0.4
M2.5	4.7	16	1.5	1	0.45
M3	5.6	20	1.65	1	0.5
M4	7.5	25	2.2	2	0.7
M5	9.2	30	2.5	2	0.8
M6	11	35	3	3	1
M8	14.5	40	4	4	1.25
M10	18	50	5	4	1.5

Article groups

Thread	Driving features	Material	Class	Surface treatment	Code	Page
M	Phillips	St	4.8	Zipl	24671	6-44
M	Phillips	St	4.8	Zipl large pack	24670	6-45
M	Pozidriv	St	4.8	Zipl	24672	6-45
M	Phillips	St	4.8	Zipl blk p.	24840	6-45
M	Phillips	St.St. A2			51300	6-46
M	Pozidriv	St.St. A2			51302	6-46
M	Phillips	St.St. A4			55300	6-47
M	Pozidriv	St.St. A4			55302	6-48
M	Pozidriv	Al P65			45425	6-48

24671 Cross recessed countersunk head screw Phillips

H05A

Thread Metric thread
Material Steel
Class 4.8
Surface treatment Zinc plated

DIN ISO 965-H
7046-1-H



d x L	☒	Art.number	d x L	☒	Art.number	d x L	☒	Art.number
M3X5	200	24671.030.005	M4X45	200	24671.040.045	M6X12	200	24671.060.012
M3X6	200	24671.030.006	M4X60	200	24671.040.060	M6X16	200	24671.060.016
M3X8	200	24671.030.008	M4X70	200	24671.040.070	M6X20	100	24671.060.020
M3X10	200	24671.030.010				M6X25	100	24671.060.025
M3X12	200	24671.030.012	M5X8	200	24671.050.008	M6X30	100	24671.060.030
M3X16	200	24671.030.016	M5X10	200	24671.050.010	M6X35	100	24671.060.035
M3X20	200	24671.030.020	M5X12	200	24671.050.012	M6X40	100	24671.060.040
M3X25	200	24671.030.025	M5X16	200	24671.050.016	M6X50	100	24671.060.050
M3X30	200	24671.030.030	M5X20	200	24671.050.020	M6X60	100	24671.060.060
M3X40	200	24671.030.040	M5X25	200	24671.050.025	M6X70	100	24671.060.070
M3X50	200	24671.030.050	M5X30	100	24671.050.030	M6X80	100	24671.060.080
			M5X35	100	24671.050.035	M6X100	100	24671.060.100
M4X6	200	24671.040.006	M5X40	100	24671.050.040			
M4X8	200	24671.040.008	M5X50	200	24671.050.050	M8X16	100	24671.080.016
M4X10	200	24671.040.010	M5X60	100	24671.050.060	M8X20	100	24671.080.020
M4X12	200	24671.040.012	M5X70	100	24671.050.070	M8X25	100	24671.080.025
M4X16	200	24671.040.016	M5X80	100	24671.050.080	M8X30	100	24671.080.030
M4X20	200	24671.040.020	M5X100	100	24671.050.100	M8X35	100	24671.080.035
M4X25	200	24671.040.025				M8X60	100	24671.080.060
M4X30	200	24671.040.030	M6X10	200	24671.060.010	M8X80	100	24671.080.080

24670 Cross recessed countersunk head screw Phillips				H05A	
Thread	Metric thread	DIN	965-H		
Material	Steel	ISO	7046-1-H		
Class	4.8				
Surface treatment	Zinc plated				



d x L	☒	Art.number	d x L	☒	Art.number	d x L	☒	Art.number
M2,5X8	2000	24670.025.008	M4X30	1000	24670.040.030	M6X12	1000	24670.060.012
M3X5	2000	24670.030.005	M4X35	1000	24670.040.035	M6X16	500	24670.060.016
M3X6	2000	24670.030.006	M4X40	1000	24670.040.040	M6X20	250	24670.060.020
M3X8	2000	24670.030.008	M4X50	1000	24670.040.050	M6X25	250	24670.060.025
M3X10	2000	24670.030.010	M5X8	1000	24670.050.008	M6X30	250	24670.060.030
M3X12	2000	24670.030.012	M5X10	1000	24670.050.010	M6X35	250	24670.060.035
M3X16	2000	24670.030.016	M5X12	1000	24670.050.012	M6X40	250	24670.060.040
M3X20	2000	24670.030.020	M5X16	1000	24670.050.016	M6X50	250	24670.060.050
M3X35	2000	24670.030.035	M5X20	500	24670.050.020	M8X16	250	24670.080.016
M4X6	1000	24670.040.006	M5X25	500	24670.050.025	M8X20	250	24670.080.020
M4X8	1000	24670.040.008	M5X30	250	24670.050.030	M8X25	250	24670.080.025
M4X10	1000	24670.040.010	M5X35	250	24670.050.035	M8X30	250	24670.080.030
M4X12	1000	24670.040.012	M5X40	250	24670.050.040	M8X35	250	24670.080.035
M4X16	1000	24670.040.016	M5X45	250	24670.050.045	M8X40	100	24670.080.040
M4X20	1000	24670.040.020	M5X50	250	24670.050.050	M8X50	100	24670.080.050
M4X25	1000	24670.040.025	M6X10	1000	24670.060.010			



24672 Cross recessed countersunk head screw Pozidriv				H05A	
Thread	Metric thread	DIN	965-Z		
Material	Steel	ISO	7046-1-Z		
Class	4.8				
Surface treatment	Zinc plated				





d x L	☒	Art.number	d x L	☒	Art.number	d x L	☒	Art.number
M3X6	2000	24672.030.006	M5X8	1000	24672.050.008	M6X20	250	24672.060.020
M3X8	2000	24672.030.008	M5X10	1000	24672.050.010	M6X25	250	24672.060.025
M3X10	2000	24672.030.010	M5X12	1000	24672.050.012	M6X30	250	24672.060.030
M3X12	2000	24672.030.012	M5X16	1000	24672.050.016	M6X35	250	24672.060.035
M3X16	2000	24672.030.016	M5X20	500	24672.050.020	M6X40	250	24672.060.040
M3X20	2000	24672.030.020	M5X25	500	24672.050.025	M6X50	250	24672.060.050
M4X6	1000	24672.040.006	M5X30	250	24672.050.030	M6X60	250	24672.060.060
M4X8	1000	24672.040.008	M5X35	250	24672.050.035	M8X16	250	24672.080.016
M4X10	1000	24672.040.010	M5X40	250	24672.050.040	M8X20	250	24672.080.020
M4X12	1000	24672.040.012	M5X50	250	24672.050.050	M8X25	250	24672.080.025
M4X16	1000	24672.040.016	M5X60	250	24672.050.060	M8X30	250	24672.080.030
M4X20	1000	24672.040.020	M6X10	1000	24672.060.010	M8X35	250	24672.080.035
M4X25	1000	24672.040.025	M6X12	1000	24672.060.012	M8X40	100	24672.080.040
M4X30	1000	24672.040.030	M6X16	500	24672.060.016	M8X50	100	24672.080.050

24840 Cross recessed countersunk head screw Phillips				H07A	
Thread	Metric thread	DIN	965-H		
Material	Steel	ISO	7046-1-H		
Class	4.8				
Surface treatment	Zinc plated black passivated				

d x L	☒	Art.number	d x L	☒	Art.number	d x L	☒	Art.number
M2X4	200	24840.020.004	M4X25	200	24840.040.025	M6X10	200	24840.060.010
M3X6	200	24840.030.006	M4X30	200	24840.040.030	M6X12	200	24840.060.012
M3X8	200	24840.030.008	M4X35	200	24840.040.035	M6X16	200	24840.060.016
M3X10	200	24840.030.010	M4X40	200	24840.040.040	M6X20	100	24840.060.020
M3X12	200	24840.030.012	M4X50	200	24840.040.050	M6X25	100	24840.060.025
M3X16	200	24840.030.016	M5X8	200	24840.050.008	M6X30	100	24840.060.030
M3X20	200	24840.030.020	M5X10	200	24840.050.010	M6X35	100	24840.060.035
M3X25	200	24840.030.025	M5X12	200	24840.050.012	M6X40	100	24840.060.040
M3X30	200	24840.030.030	M5X16	200	24840.050.016	M6X50	100	24840.060.050
M4X6	200	24840.040.006	M5X20	200	24840.050.020	M8X16	100	24840.080.016
M4X8	200	24840.040.008	M5X25	200	24840.050.025	M8X20	100	24840.080.020
M4X10	200	24840.040.010	M5X30	100	24840.050.030	M8X25	100	24840.080.025
M4X12	200	24840.040.012	M5X35	100	24840.050.035	M8X30	100	24840.080.030
M4X16	200	24840.040.016	M5X40	100	24840.050.040	M8X35	100	24840.080.035
M4X20	200	24840.040.020	M5X50	100	24840.050.050	M8X40	100	24840.080.040
						M8X50	100	24840.080.050

51300	Cross recessed countersunk head screw Phillips			R01A
Thread Material	Metric thread Stainless steel A2	DIN ISO NF	965-H 7046-2-H E25-119-2	
				

d x L	☒	Art.number	d x L	☒	Art.number	d x L	☒	Art.number
M1,6X2*	1000	51300.016.002	M3X45*	500	51300.030.045	M6X12	100	51300.060.012
M1,6X3*	1000	51300.016.003	M3X50*	500	51300.030.050	M6X14*	500	51300.060.014
M1,6X4*	1000	51300.016.004	M3X55*	500	51300.030.055	M6X16	100	51300.060.016
M1,6X5*	1000	51300.016.005	M3X60*	500	51300.030.060	M6X18*	500	51300.060.018
M1,6X6*	1000	51300.016.006				M6X20	100	51300.060.020
M1,6X8*	1000	51300.016.008	M4X5	500	51300.040.005	M6X22*	200	51300.060.022
M1,6X10*	1000	51300.016.010	M4X6	500	51300.040.006	M6X25	100	51300.060.025
M1,6X12*	1000	51300.016.012	M4X8	200	51300.040.008	M6X30	100	51300.060.030
M1,6X14*	1000	51300.016.014	M4X10	200	51300.040.010	M6X35	100	51300.060.035
M1,6X16*	1000	51300.016.016	M4X12	200	51300.040.012	M6X40	100	51300.060.040
M1,6X18*	1000	51300.016.018	M4X14*	500	51300.040.014	M6X45	100	51300.060.045
M1,6X20*	1000	51300.016.020	M4X16	200	51300.040.016	M6X50	100	51300.060.050
			M4X18*	500	51300.040.018	M6X55*	200	51300.060.055
M2X3*	1000	51300.020.003	M4X20	200	51300.040.020	M6X60	100	51300.060.060
M2X4	100	51300.020.004	M4X22*	500	51300.040.022	M6X65	100	51300.060.065
M2X5	100	51300.020.005	M4X25	200	51300.040.025	M6X70	100	51300.060.070
M2X6	100	51300.020.006	M4X30	200	51300.040.030	M6X75*	200	51300.060.075
M2X8	100	51300.020.008	M4X35	200	51300.040.035	M6X80	100	51300.060.080
M2X10	100	51300.020.010	M4X40	200	51300.040.040	M6X90*	200	51300.060.090
M2X12	100	51300.020.012	M4X45	200	51300.040.045	M6X100	200	51300.060.100
M2X16	100	51300.020.016	M4X50	200	51300.040.050			
M2X18*	1000	51300.020.018	M4X55*	500	51300.040.055	M8X12*	200	51300.080.012
M2X20*	1000	51300.020.020	M4X60	200	51300.040.060	M8X16*	200	51300.080.016
			M4X70*	200	51300.040.070	M8X20	100	51300.080.020
M2,5X3*	1000	51300.025.003	M4X80*	200	51300.040.080	M8X25	100	51300.080.025
M2,5X4*	1000	51300.025.004	M4X100*	200	51300.040.100	M8X30	100	51300.080.030
M2,5X5	100	51300.025.005				M8X35	100	51300.080.035
M2,5X6	100	51300.025.006	M5X6	500	51300.050.006	M8X40	100	51300.080.040
M2,5X8	100	51300.025.008	M5X8	100	51300.050.008	M8X45*	200	51300.080.045
M2,5X10	100	51300.025.010	M5X10	100	51300.050.010	M8X50	100	51300.080.050
M2,5X12	100	51300.025.012	M5X12	100	51300.050.012	M8X60	100	51300.080.060
M2,5X14*	1000	51300.025.014	M5X14*	500	51300.050.014	M8X70	100	51300.080.070
M2,5X16	100	51300.025.016	M5X16	100	51300.050.016	M8X80	100	51300.080.080
M2,5X18*	1000	51300.025.018	M5X18*	500	51300.050.018	M8X90*	200	51300.080.090
M2,5X20	100	51300.025.020	M5X20	100	51300.050.020	M8X100*	100	51300.080.100
M2,5X22*	1000	51300.025.022	M5X22*	500	51300.050.022	M8X110*	100	51300.080.110
M2,5X25*	1000	51300.025.025	M5X25	100	51300.050.025	M8X120*	100	51300.080.120
			M5X28*	500	51300.050.028	M8X130*	100	51300.080.130
M3X4	500	51300.030.004	M5X30	100	51300.050.030	M8X150*	100	51300.080.150
M3X5*	500	51300.030.005	M5X35	100	51300.050.035			
M3X6	200	51300.030.006	M5X40	100	51300.050.040	M10X16*	100	51300.100.016
M3X8	200	51300.030.008	M5X45	100	51300.050.045	M10X20*	100	51300.100.020
M3X10	200	51300.030.010	M5X50	100	51300.050.050	M10X25*	100	51300.100.025
M3X12	200	51300.030.012	M5X55*	200	51300.050.055	M10X30*	100	51300.100.030
M3X14*	500	51300.030.014	M5X60	100	51300.050.060	M10X35*	100	51300.100.035
M3X16	200	51300.030.016	M5X65*	200	51300.050.065	M10X40	100	51300.100.040
M3X18*	500	51300.030.018	M5X70	100	51300.050.070	M10X45*	100	51300.100.045
M3X20	200	51300.030.020	M5X80	100	51300.050.080	M10X50*	100	51300.100.050
M3X22*	500	51300.030.022	M5X90*	200	51300.050.090	M10X60*	100	51300.100.060
M3X25	200	51300.030.025	M5X100	200	51300.050.100	M10X70*	50	51300.100.070
M3X30	200	51300.030.030				M10X80*	50	51300.100.080
M3X35	200	51300.030.035	M6X8*	500	51300.060.008	M10X100*	50	51300.100.100
M3X40	200	51300.030.040	M6X10	100	51300.060.010			

51302	Cross recessed countersunk head screw Pozidriv			R01A
Thread Material	Metric thread Stainless steel A2	DIN ISO NF	965-Z 7046-2-Z E25-119-2	
				



d x L	☒	Art.number	d x L	☒	Art.number	d x L	☒	Art.number
M1,6X2*	1000	51302.016.002	M1,6X18*	1000	51302.016.018	M2X14*	1000	51302.020.014
M1,6X3*	1000	51302.016.003	M1,6X20*	1000	51302.016.020	M2X16	100	51302.020.016
M1,6X4	100	51302.016.004				M2X18*	1000	51302.020.018
M1,6X5	100	51302.016.005	M2X3	100	51302.020.003	M2X20	100	51302.020.020
M1,6X6	100	51302.016.006	M2X4	100	51302.020.004			
M1,6X8	100	51302.016.008	M2X5	100	51302.020.005	M2,5X3*	1000	51302.025.003
M1,6X10	100	51302.016.010	M2X6	100	51302.020.006	M2,5X4	100	51302.025.004
M1,6X12*	1000	51302.016.012	M2X8	100	51302.020.008	M2,5X5	100	51302.025.005
M1,6X14*	1000	51302.016.014	M2X10	100	51302.020.010	M2,5X6	100	51302.025.006
M1,6X16*	1000	51302.016.016	M2X12	100	51302.020.012	M2,5X8	100	51302.025.008

51302 Cross recessed countersunk head screw Pozidriv								
d x L	☒	Art.number	d x L	☒	Art.number	d x L	☒	Art.number
M2,5X10	100	51302.025.010	M4X14*	500	51302.040.014	M5X70*	200	51302.050.070
M2,5X12	100	51302.025.012	M4X16	200	51302.040.016	M5X80*	200	51302.050.080
M2,5X14	100	51302.025.014	M4X18*	500	51302.040.018	M5X90*	200	51302.050.090
M2,5X16	100	51302.025.016	M4X20	200	51302.040.020	M5X100*	200	51302.050.100
M2,5X18*	1000	51302.025.018	M4X22*	500	51302.040.022			
M2,5X20	100	51302.025.020	M4X25	200	51302.040.025	M6X8	100	51302.060.008
M2,5X25*	1000	51302.025.025	M4X30	200	51302.040.030	M6X10	100	51302.060.010
			M4X35	200	51302.040.035	M6X12	100	51302.060.012
M3X4	200	51302.030.004	M4X40	200	51302.040.040	M6X14*	500	51302.060.014
M3X5	200	51302.030.005	M4X45*	500	51302.040.045	M6X16	100	51302.060.016
M3X6	200	51302.030.006	M4X50	200	51302.040.050	M6X20	100	51302.060.020
M3X8	200	51302.030.008	M4X55*	500	51302.040.055	M6X22*	500	51302.060.022
M3X10	200	51302.030.010	M4X60*	500	51302.040.060	M6X25	100	51302.060.025
M3X12	200	51302.030.012	M4X70*	500	51302.040.070	M6X30	100	51302.060.030
M3X14*	500	51302.030.014	M4X80*	200	51302.040.080	M6X35	100	51302.060.035
M3X16	200	51302.030.016				M6X40	100	51302.060.040
M3X18*	500	51302.030.018	M5X6	100	51302.050.006	M6X45*	200	51302.060.045
M3X20	200	51302.030.020	M5X8	100	51302.050.008	M6X50	100	51302.060.050
M3X22*	500	51302.030.022	M5X10	100	51302.050.010	M6X55*	200	51302.060.055
M3X25	200	51302.030.025	M5X12	100	51302.050.012	M6X60	100	51302.060.060
M3X30	200	51302.030.030	M5X14*	500	51302.050.014	M6X65*	200	51302.060.065
M3X35*	500	51302.030.035	M5X16	100	51302.050.016	M6X70*	200	51302.060.070
M3X40	200	51302.030.040	M5X18*	500	51302.050.018	M6X75*	200	51302.060.075
M3X45*	500	51302.030.045	M5X20	100	51302.050.020	M6X80*	200	51302.060.080
M3X50*	500	51302.030.050	M5X22*	500	51302.050.022	M6X90*	100	51302.060.090
M3X55*	500	51302.030.055	M5X25	100	51302.050.025	M6X100*	100	51302.060.100
M3X60*	500	51302.030.060	M5X30	100	51302.050.030			
			M5X35	100	51302.050.035	M8X16*	200	51302.080.016
M4X5	200	51302.040.005	M5X40	100	51302.050.040	M8X20*	200	51302.080.020
M4X6	200	51302.040.006	M5X45*	200	51302.050.045	M8X25*	200	51302.080.025
M4X8	200	51302.040.008	M5X50	100	51302.050.050	M8X30*	200	51302.080.030
M4X10	200	51302.040.010	M5X55*	200	51302.050.055	M8X35*	200	51302.080.035
M4X12	200	51302.040.012	M5X60	100	51302.050.060			

55300 Cross recessed countersunk head screw Phillips					R41A
Thread	Metric thread	DIN	965-H		
Material	Stainless steel A4	ISO	7046-2-H		
		NF	E25-119-2		

d x L	☒	Art.number	d x L	☒	Art.number	d x L	☒	Art.number
M1,6X3*	1000	55300.016.003	M3X10	200	55300.030.010	M5X14*	500	55300.050.014
M1,6X4*	1000	55300.016.004	M3X12	200	55300.030.012	M5X16	100	55300.050.016
M1,6X5*	1000	55300.016.005	M3X14*	500	55300.030.014	M5X18*	500	55300.050.018
M1,6X6*	1000	55300.016.006	M3X16	200	55300.030.016	M5X20	100	55300.050.020
M1,6X8*	1000	55300.016.008	M3X18*	500	55300.030.018	M5X22*	500	55300.050.022
M1,6X10*	1000	55300.016.010	M3X20	200	55300.030.020	M5X25	100	55300.050.025
M1,6X12*	1000	55300.016.012	M3X22*	500	55300.030.022	M5X30	100	55300.050.030
M1,6X14*	1000	55300.016.014	M3X25	200	55300.030.025	M5X35	100	55300.050.035
M1,6X16*	1000	55300.016.016	M3X30	200	55300.030.030	M5X40	100	55300.050.040
			M3X35*	500	55300.030.035	M5X45*	200	55300.050.045
M2X4	100	55300.020.004	M3X45*	500	55300.030.045	M5X50	100	55300.050.050
M2X5	100	55300.020.005	M3X50*	500	55300.030.050	M5X55*	200	55300.050.055
M2X6	100	55300.020.006	M3X60*	500	55300.030.060	M5X60	100	55300.050.060
M2X8	100	55300.020.008				M5X70*	200	55300.050.070
M2X10	100	55300.020.010	M4X5*	500	55300.040.005	M5X80*	200	55300.050.080
M2X12	100	55300.020.012	M4X6	200	55300.040.006	M5X90*	200	55300.050.090
M2X16	100	55300.020.016	M4X8	200	55300.040.008	M5X100*	200	55300.050.100
M2X18*	1000	55300.020.018	M4X10	200	55300.040.010			
M2X20*	1000	55300.020.020	M4X12	200	55300.040.012	M6X8	100	55300.060.008
			M4X14*	500	55300.040.014	M6X10	100	55300.060.010
M2,5X3*	1000	55300.025.003	M4X16	200	55300.040.016	M6X12	100	55300.060.012
M2,5X5	100	55300.025.005	M4X18*	500	55300.040.018	M6X14*	500	55300.060.014
M2,5X6	100	55300.025.006	M4X20	200	55300.040.020	M6X16	100	55300.060.016
M2,5X8	100	55300.025.008	M4X22*	500	55300.040.022	M6X18*	500	55300.060.018
M2,5X10	100	55300.025.010	M4X25	200	55300.040.025	M6X20	100	55300.060.020
M2,5X12	100	55300.025.012	M4X30	200	55300.040.030	M6X22*	200	55300.060.022
M2,5X14*	1000	55300.025.014	M4X35	200	55300.040.035	M6X25	100	55300.060.025
M2,5X16	100	55300.025.016	M4X40	200	55300.040.040	M6X30	100	55300.060.030
M2,5X18*	1000	55300.025.018	M4X45*	500	55300.040.045	M6X35	100	55300.060.035
M2,5X20	100	55300.025.020	M4X55*	500	55300.040.055	M6X40	100	55300.060.040
M2,5X22*	1000	55300.025.022	M4X60*	500	55300.040.060	M6X45*	200	55300.060.045
M2,5X25*	1000	55300.025.025	M4X70*	200	55300.040.070	M6X50	100	55300.060.050
						M6X55*	200	55300.060.055
M3X4*	500	55300.030.004	M5X6*	500	55300.050.006	M6X60	100	55300.060.060
M3X5	500	55300.030.005	M5X8	100	55300.050.008	M6X70	100	55300.060.070
M3X6	200	55300.030.006	M5X10	100	55300.050.010	M6X75*	200	55300.060.075
M3X8	200	55300.030.008	M5X12	100	55300.050.012	M6X80*	200	55300.060.080

55300 Cross recessed countersunk head screw Phillips								
d x L	☒	Art.number	d x L	☒	Art.number	d x L	☒	Art.number
M6X90*	200	55300.060.090	M8X40	100	55300.080.040	M10X30*	100	55300.100.030
M6X100	200	55300.060.100	M8X45*	200	55300.080.045	M10X35*	100	55300.100.035
M8X12*	200	55300.080.012	M8X50	100	55300.080.050	M10X40	100	55300.100.040
M8X16	100	55300.080.016	M8X60	100	55300.080.060	M10X45*	100	55300.100.045
M8X20	100	55300.080.020	M8X80*	100	55300.080.080	M10X50*	100	55300.100.050
M8X25	100	55300.080.025	M10X16*	100	55300.100.016	M10X60*	100	55300.100.060
M8X30	100	55300.080.030	M10X20*	100	55300.100.020	M10X70*	50	55300.100.070
M8X35	100	55300.080.035	M10X25*	100	55300.100.025	M10X80*	50	55300.100.080

55302 Cross recessed countersunk head screw Pozidriv				R41A
Thread	Metric thread	DIN	965-Z	
Material	Stainless steel A4	ISO	7046-2-Z	
		NF	E25-119-2	
				

d x L	☒	Art.number	d x L	☒	Art.number	d x L	☒	Art.number
M1,6X3	100	55302.016.003	M3X10	200	55302.030.010	M5X14*	500	55302.050.014
M1,6X4	100	55302.016.004	M3X12	200	55302.030.012	M5X16	100	55302.050.016
M1,6X5	100	55302.016.005	M3X14*	500	55302.030.014	M5X20	100	55302.050.020
M1,6X6	100	55302.016.006	M3X16	200	55302.030.016	M5X22*	500	55302.050.022
M1,6X8	100	55302.016.008	M3X18*	500	55302.030.018	M5X25	100	55302.050.025
M1,6X10	100	55302.016.010	M3X20	200	55302.030.020	M5X30	100	55302.050.030
M1,6X12	100	55302.016.012	M3X22*	500	55302.030.022	M5X35	100	55302.050.035
M2X3	100	55302.020.003	M3X25	200	55302.030.025	M5X40	100	55302.050.040
M2X4	100	55302.020.004	M3X30	200	55302.030.030	M5X45*	200	55302.050.045
M2X5	100	55302.020.005	M3X35*	500	55302.030.035	M5X50	100	55302.050.050
M2X6	100	55302.020.006	M3X40	200	55302.030.040	M5X55*	200	55302.050.055
M2X8	100	55302.020.008	M3X45*	500	55302.030.045	M5X60	100	55302.050.060
M2X10*	1000	55302.020.010	M4X5	200	55302.040.005	M5X70*	200	55302.050.070
M2X12	100	55302.020.012	M4X6	200	55302.040.006	M5X80*	200	55302.050.080
M2X14	100	55302.020.014	M4X8	200	55302.040.008	M6X8	100	55302.060.008
M2X16	100	55302.020.016	M4X10	200	55302.040.010	M6X10	100	55302.060.010
M2X20	100	55302.020.020	M4X12	200	55302.040.012	M6X12	100	55302.060.012
M2,5X3*	1000	55302.025.003	M4X14*	500	55302.040.014	M6X14*	500	55302.060.014
M2,5X4	100	55302.025.004	M4X16	200	55302.040.016	M6X16	100	55302.060.016
M2,5X5	100	55302.025.005	M4X18*	500	55302.040.018	M6X18*	500	55302.060.018
M2,5X6	100	55302.025.006	M4X20	200	55302.040.020	M6X20	100	55302.060.020
M2,5X8	100	55302.025.008	M4X25	200	55302.040.025	M6X22*	500	55302.060.022
M2,5X10	100	55302.025.010	M4X30	200	55302.040.030	M6X25	100	55302.060.025
M2,5X12*	1000	55302.025.012	M4X35	200	55302.040.035	M6X30	100	55302.060.030
M2,5X14	100	55302.025.014	M4X40	200	55302.040.040	M6X35	100	55302.060.035
M2,5X16	100	55302.025.016	M4X45*	500	55302.040.045	M6X40	100	55302.060.040
M2,5X18*	1000	55302.025.018	M4X50	200	55302.040.050	M6X45*	200	55302.060.045
M2,5X20	100	55302.025.020	M4X60*	500	55302.040.060	M6X50	100	55302.060.050
M2,5X25*	1000	55302.025.025	M4X70*	500	55302.040.070	M6X60	100	55302.060.060
M3X4	200	55302.030.004	M5X6	100	55302.050.006	M6X70*	200	55302.060.070
M3X5	200	55302.030.005	M5X8	100	55302.050.008	M6X75*	200	55302.060.075
M3X6	200	55302.030.006	M5X10	100	55302.050.010	M6X80*	200	55302.060.080
M3X8	200	55302.030.008	M5X12	100	55302.050.012	M6X90*	100	55302.060.090
						M6X100*	100	55302.060.100

45425 Cross recessed countersunk head screw Pozidriv				W010
Thread	Metric thread	DIN	≈965	
Material	Aluminium P65	ISO	≈7046-1	
		NF	≈E25-119-1	

d x L	☒	Art.number	d x L	☒	Art.number	d x L	☒	Art.number
M3X8	500	45425.030.008	M4X20	500	45425.040.020	M6X20	200	45425.060.020
M3X10	500	45425.030.010	M4X25	200	45425.040.025	M6X25	200	45425.060.025
M3X16	500	45425.030.016	M5X10	200	45425.050.010	M6X30	200	45425.060.030
M3X20	500	45425.030.020	M5X12	200	45425.050.012	M6X35	200	45425.060.035
M3X25	500	45425.030.025	M5X16	200	45425.050.016	M6X40	100	45425.060.040
M4X10	500	45425.040.010	M5X20	200	45425.050.020	M6X50	100	45425.060.050
M4X12	500	45425.040.012	M6X16	200	45425.060.016	M8X20	100	45425.080.020
M4X16	500	45425.040.016				M8X30	100	45425.080.030

Hexalobular countersunk head screw

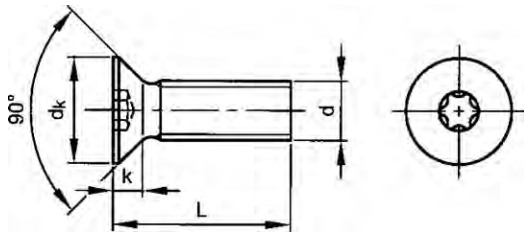

DIN ≈965
ISO ≈14581
NF ≈E25-119-1

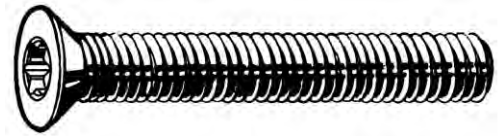

Technical Data

d	d _k	k (max.)	P	Socket
M1.6	3	0.96	0.35	T5
M2	3.8	1.2	0.4	T6
M2.5	4.7	1.5	0.45	T8
M3	5.6	1.65	0.5	T10
M4	7.5	2.2	0.7	T20
M5	9.2	2.5	0.8	T25
M6	11	3	1	T30
M8	14.5	4	1.25	T45
M10	18	5	1.5	T50

Article groups

Thread	Driving features	Material	Class	Surface treatment	Code	Page
M	Hexalobular	St	4.8	Zipl	24677	6-49
M	Hexalobular	St.St. A2			51305	6-49
M	Hexalobular	St.St. A4			55303	6-50

24677 Hexalobular countersunk head screw

H05A

Thread Metric thread
Material Steel
Class 4.8
Surface treatment Zinc plated



d x L	⊗	Art.number	d x L	⊗	Art.number	d x L	⊗	Art.number
M3X5	200	24677.030.005	M4X16	200	24677.040.016	M6X10	200	24677.060.010
M3X6	200	24677.030.006	M4X20	200	24677.040.020	M6X12	200	24677.060.012
M3X8	200	24677.030.008	M4X25	200	24677.040.025	M6X16	200	24677.060.016
M3X10	200	24677.030.010				M6X20	100	24677.060.020
M3X12	200	24677.030.012	M5X8	200	24677.050.008	M6X25	100	24677.060.025
M3X16	200	24677.030.016	M5X10	200	24677.050.010	M6X30	100	24677.060.030
M3X20	200	24677.030.020	M5X12	200	24677.050.012	M6X35	100	24677.060.035
			M5X16	200	24677.050.016	M6X40	100	24677.060.040
M4X6	200	24677.040.006	M5X20	200	24677.050.020			
M4X8	200	24677.040.008	M5X25	100	24677.050.025			
M4X10	200	24677.040.010	M5X30	100	24677.050.030	M8X16	50	24677.080.016
M4X12	200	24677.040.012	M5X35	100	24677.050.035	M8X20	50	24677.080.020

51305 Hexalobular countersunk head screw

R01A

Thread Metric thread
Material Stainless steel A2



d x L	⊗	Art.number	d x L	⊗	Art.number	d x L	⊗	Art.number
M1,6X2*	1000	51305.016.002	M2X4*	1000	51305.020.004	M2,5X5*	1000	51305.025.005
M1,6X3*	1000	51305.016.003	M2X5*	1000	51305.020.005	M2,5X6	1000	51305.025.006
M1,6X4*	1000	51305.016.004	M2X6	1000	51305.020.006	M2,5X8*	1000	51305.025.008
M1,6X5*	1000	51305.016.005	M2X8*	1000	51305.020.008	M2,5X10*	1000	51305.025.010
M1,6X6*	1000	51305.016.006	M2X10*	1000	51305.020.010	M2,5X12*	1000	51305.025.012
M1,6X8*	1000	51305.016.008	M2X12*	1000	51305.020.012	M2,5X14*	1000	51305.025.014
M1,6X10*	1000	51305.016.010	M2X14*	1000	51305.020.014	M2,5X16*	1000	51305.025.016
M1,6X12*	1000	51305.016.012	M2X16*	1000	51305.020.016	M2,5X18*	1000	51305.025.018
M1,6X14*	1000	51305.016.014	M2X18*	1000	51305.020.018	M2,5X20*	1000	51305.025.020
M1,6X16*	1000	51305.016.016	M2X20*	1000	51305.020.020	M2,5X22*	1000	51305.025.022
M1,6X20*	1000	51305.016.020				M2,5X25*	1000	51305.025.025
M2X3*	1000	51305.020.003	M2,5X3*	1000	51305.025.003			
			M2,5X4	1000	51305.025.004	M3X4	500	51305.030.004

51305 Hexalobular countersunk head screw

d x L	☒	Art.number	d x L	☒	Art.number	d x L	☒	Art.number
M3X5	500	51305.030.005	M4X55*	500	51305.040.055	M6X16	100	51305.060.016
M3X6	200	51305.030.006	M4X60*	500	51305.040.060	M6X18*	500	51305.060.018
M3X8	200	51305.030.008	M4X65*	200	51305.040.065	M6X20	100	51305.060.020
M3X10	200	51305.030.010	M4X70*	200	51305.040.070	M6X22*	500	51305.060.022
M3X12	200	51305.030.012	M4X80*	200	51305.040.080	M6X25	100	51305.060.025
M3X14*	500	51305.030.014	M4X90*	200	51305.040.090	M6X30	100	51305.060.030
M3X16	200	51305.030.016	M4X100*	200	51305.040.100	M6X35	100	51305.060.035
M3X18*	500	51305.030.018				M6X40	100	51305.060.040
M3X20	200	51305.030.020	M5X6*	500	51305.050.006	M6X45*	200	51305.060.045
M3X22*	500	51305.030.022	M5X8	500	51305.050.008	M6X50*	200	51305.060.050
M3X25*	500	51305.030.025	M5X10	200	51305.050.010	M6X55*	200	51305.060.055
M3X30*	500	51305.030.030	M5X12	200	51305.050.012	M6X60*	200	51305.060.060
M3X35*	500	51305.030.035	M5X14*	500	51305.050.014	M6X65*	200	51305.060.065
M3X40*	500	51305.030.040	M5X16	200	51305.050.016	M6X70*	200	51305.060.070
M3X45*	500	51305.030.045	M5X18*	500	51305.050.018	M6X75*	200	51305.060.075
M3X50*	500	51305.030.050	M5X20	200	51305.050.020	M6X80*	200	51305.060.080
M3X55*	500	51305.030.055	M5X22*	500	51305.050.022	M6X90*	200	51305.060.090
M3X60*	500	51305.030.060	M5X25	100	51305.050.025	M6X100*	200	51305.060.100
			M5X28*	500	51305.050.028	M6X120*	200	51305.060.120
M4X5	500	51305.040.005	M5X30	100	51305.050.030	M6X130*	200	51305.060.130
M4X6*	500	51305.040.006	M5X35	100	51305.050.035	M6X140*	200	51305.060.140
M4X8	200	51305.040.008	M5X40	100	51305.050.040			
M4X10	200	51305.040.010	M5X45*	200	51305.050.045	M8X10*	200	51305.080.010
M4X12	200	51305.040.012	M5X50*	200	51305.050.050	M8X12*	200	51305.080.012
M4X14*	500	51305.040.014	M5X55*	200	51305.050.055	M8X16*	200	51305.080.016
M4X16	200	51305.040.016	M5X60*	200	51305.050.060	M8X20	200	51305.080.020
M4X18*	500	51305.040.018	M5X70*	200	51305.050.070	M8X25*	200	51305.080.025
M4X20	200	51305.040.020	M5X80*	200	51305.050.080	M8X30	200	51305.080.030
M4X22*	500	51305.040.022	M5X90*	200	51305.050.090	M8X35*	200	51305.080.035
M4X25	200	51305.040.025	M5X100*	200	51305.050.100	M8X40*	200	51305.080.040
M4X30	200	51305.040.030				M8X45*	200	51305.080.045
M4X35	100	51305.040.035	M6X8*	500	51305.060.008	M8X50*	200	51305.080.050
M4X40	100	51305.040.040	M6X10	100	51305.060.010	M8X60*	200	51305.080.060
M4X45*	500	51305.040.045	M6X12	100	51305.060.012	M8X70*	200	51305.080.070
M4X50	500	51305.040.050	M6X14*	500	51305.060.014	M8X80*	200	51305.080.080

6

55303 Hexalobular countersunk head screw

Thread	Metric thread	R41A
Material	Stainless steel A4	



d x L	☒	Art.number	d x L	☒	Art.number	d x L	☒	Art.number
M1,6X3*	1000	55303.016.003	M3X14*	500	55303.030.014	M5X8*	500	55303.050.008
M1,6X4*	1000	55303.016.004	M3X16*	500	55303.030.016	M5X10*	500	55303.050.010
M1,6X5*	1000	55303.016.005	M3X18*	500	55303.030.018	M5X12*	500	55303.050.012
M1,6X6*	1000	55303.016.006	M3X20*	500	55303.030.020	M5X14*	500	55303.050.014
M1,6X8*	1000	55303.016.008	M3X25*	500	55303.030.025	M5X16*	500	55303.050.016
M1,6X10*	1000	55303.016.010	M3X30*	500	55303.030.030	M5X18*	500	55303.050.018
M1,6X14*	1000	55303.016.014	M3X35*	500	55303.030.035	M5X20*	500	55303.050.020
M1,6X16*	1000	55303.016.016	M3X40*	500	55303.030.040	M5X22*	500	55303.050.022
M1,6X20*	1000	55303.016.020	M3X45*	500	55303.030.045	M5X25*	500	55303.050.025
			M3X50*	500	55303.030.050	M5X28*	500	55303.050.028
M2X3*	1000	55303.020.003	M3X60*	500	55303.030.060	M5X30*	500	55303.050.030
M2X4*	1000	55303.020.004				M5X35*	500	55303.050.035
M2X6*	1000	55303.020.006	M4X5*	500	55303.040.005	M5X40*	500	55303.050.040
M2X8*	1000	55303.020.008	M4X6*	500	55303.040.006	M5X45*	200	55303.050.045
M2X12*	1000	55303.020.012	M4X8*	500	55303.040.008	M5X50*	200	55303.050.050
M2X14*	1000	55303.020.014	M4X10*	500	55303.040.010	M5X55*	200	55303.050.055
M2X16*	1000	55303.020.016	M4X12*	500	55303.040.012	M5X60*	200	55303.050.060
M2X20*	1000	55303.020.020	M4X14*	500	55303.040.014	M5X70*	200	55303.050.070
			M4X16*	500	55303.040.016	M5X80*	200	55303.050.080
M2,5X3*	1000	55303.025.003	M4X18*	500	55303.040.018	M5X90*	200	55303.050.090
M2,5X4*	1000	55303.025.004	M4X20*	500	55303.040.020	M5X100*	200	55303.050.100
M2,5X5*	1000	55303.025.005	M4X22*	500	55303.040.022			
M2,5X6*	1000	55303.025.006	M4X25*	500	55303.040.025	M6X8*	500	55303.060.008
M2,5X8*	1000	55303.025.008	M4X30*	500	55303.040.030	M6X10*	500	55303.060.010
M2,5X10*	1000	55303.025.010	M4X35*	500	55303.040.035	M6X12*	500	55303.060.012
M2,5X12	1000	55303.025.012	M4X40*	500	55303.040.040	M6X14*	500	55303.060.014
M2,5X14*	1000	55303.025.014	M4X45*	500	55303.040.045	M6X16*	500	55303.060.016
M2,5X16*	1000	55303.025.016	M4X50*	500	55303.040.050	M6X18*	500	55303.060.018
M2,5X20*	1000	55303.025.020	M4X55*	500	55303.040.055	M6X20*	500	55303.060.020
M2,5X25*	1000	55303.025.025	M4X60*	500	55303.040.060	M6X22*	500	55303.060.022
			M4X70*	200	55303.040.070	M6X25*	200	55303.060.025
M3X4*	500	55303.030.004	M4X80*	200	55303.040.080	M6X30*	200	55303.060.030
M3X5*	500	55303.030.005	M4X90*	200	55303.040.090	M6X35*	200	55303.060.035
M3X6*	500	55303.030.006				M6X40*	200	55303.060.040
M3X10*	500	55303.030.010	M5X6*	500	55303.050.006	M6X45*	200	55303.060.045

55303 Hexalobular countersunk head screw								
d x L	☒	Art.number	d x L	☒	Art.number	d x L	☒	Art.number
M6X50*	200	55303.060.050				M8X35*	200	55303.080.035
M6X55*	200	55303.060.055	M8X10*	200	55303.080.010	M8X40*	200	55303.080.040
M6X60*	200	55303.060.060	M8X12*	200	55303.080.012	M8X45*	200	55303.080.045
M6X70*	200	55303.060.070	M8X16*	200	55303.080.016	M8X50*	200	55303.080.050
M6X80*	200	55303.060.080	M8X20*	200	55303.080.020	M8X60*	200	55303.080.060
M6X90*	200	55303.060.090	M8X25*	200	55303.080.025	M8X70*	200	55303.080.070
M6X100*	200	55303.060.100	M8X30*	200	55303.080.030	M8X80*	200	55303.080.080

Cross recessed raised countersunk head screw

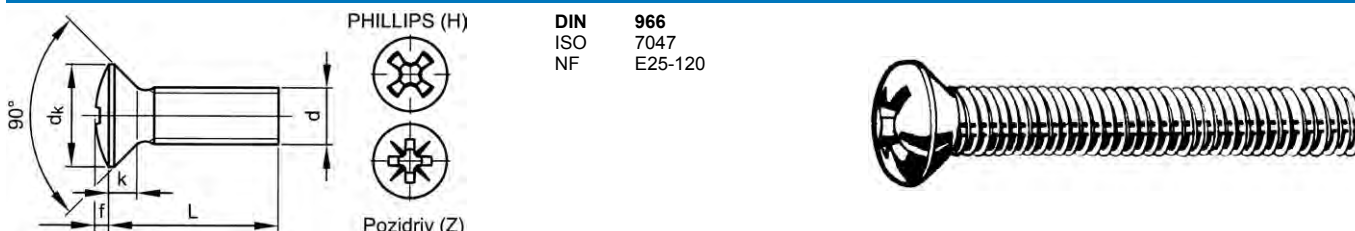

Technical Data

d	d _k	f ≈	Full thread L ≤	k (max.)	No. cross recess	P
M2	3.8	0.5	16	1.2	1	0.4
M2.5	4.7	0.6	18	1.5	1	0.45
M3	5.6	0.75	20	1.65	1	0.5
M4	7.5	1	25	2.2	2	0.7
M5	9.2	1.25	30	2.5	2	0.8
M6	11	1.5	35	3	3	1
M8	14.5	2	40	4	4	1.25



Article groups

Thread	Driving features	Material	Class	Surface treatment	Code	Page
M	Phillips	St	4.8	Zipl	24691	6-51
M	Phillips	St	4.8	Zipl	24690	6-52
M	Pozidriv	St	4.8	Zipl	24692	6-52
M	Phillips	St.St. A2			51320	6-52
M	Pozidriv	St.St. A2			51322	6-53
M	Phillips	St.St. A4			55320	6-53
M	Pozidriv	St.St. A4			55322	6-53



24691 Cross recessed raised countersunk head screw Phillips					H05A
Thread	Metric thread		DIN	966-H	
Material	Steel		ISO	7047-H	
Class	4.8				
Surface treatment	Zinc plated				





d x L	☒	Art.number	d x L	☒	Art.number	d x L	☒	Art.number
M3X6	200	24691.030.006	M4X25	200	24691.040.025	M6X12	200	24691.060.012
M3X8	200	24691.030.008	M4X30	200	24691.040.030	M6X16	200	24691.060.016
M3X10	200	24691.030.010	M4X40	100	24691.040.040	M6X20	100	24691.060.020
M3X12	200	24691.030.012				M6X25	100	24691.060.025
M3X16	200	24691.030.016	M5X8	200	24691.050.008	M6X30	100	24691.060.030
M3X20	200	24691.030.020	M5X10	200	24691.050.010	M6X35	100	24691.060.035
			M5X12	200	24691.050.012	M6X40	100	24691.060.040
M4X6	200	24691.040.006	M5X16	200	24691.050.016	M6X50	100	24691.060.050
M4X8	200	24691.040.008	M5X20	200	24691.050.020			
M4X10	200	24691.040.010	M5X25	200	24691.050.025			
M4X12	200	24691.040.012	M5X30	100	24691.050.030	M8X16	100	24691.080.016
M4X16	200	24691.040.016	M5X35	100	24691.050.035	M8X20	100	24691.080.020
M4X20	200	24691.040.020	M5X40	100	24691.050.040	M8X25	100	24691.080.025

24690				Cross recessed raised countersunk head screw Phillips				H05A	
Thread	Metric thread			DIN	966-H				
Material	Steel			ISO	7047-H				
Class	4.8								
Surface treatment	Zinc plated								
									
									

d x L	✉	Art.number	d x L	✉	Art.number	d x L	✉	Art.number
M3X10	2000	24690.030.010	M5X8	1000	24690.050.008	M6X20	250	24690.060.020
M3X12	2000	24690.030.012	M5X10	1000	24690.050.010	M6X25	250	24690.060.025
M3X16	2000	24690.030.016	M5X12	1000	24690.050.012	M6X30	250	24690.060.030
M3X20	2000	24690.030.020	M5X16	1000	24690.050.016	M6X35	250	24690.060.035
			M5X20	500	24690.050.020	M6X40	250	24690.060.040
M4X6	1000	24690.040.006	M5X25	500	24690.050.025	M6X50	250	24690.060.050
M4X8	1000	24690.040.008	M5X30	250	24690.050.030			
M4X10	1000	24690.040.010	M5X35	250	24690.050.035	M8X16	250	24690.080.016
M4X12	1000	24690.040.012	M5X40	250	24690.050.040	M8X20	250	24690.080.020
M4X16	1000	24690.040.016	M5X50	250	24690.050.050	M8X25	250	24690.080.025
M4X20	1000	24690.040.020				M8X30	250	24690.080.030
M4X25	1000	24690.040.025	M6X10	1000	24690.060.010	M8X35	250	24690.080.035
M4X30	1000	24690.040.030	M6X12	1000	24690.060.012	M8X40	100	24690.080.040
M4X40	500	24690.040.040	M6X16	500	24690.060.016	M8X50	100	24690.080.050

24692				Cross recessed raised countersunk head screw Pozidriv				H05A	
Thread	Metric thread			DIN	966-Z				
Material	Steel			ISO	7047-Z				
Class	4.8								
Surface treatment	Zinc plated								
									
									



d x L	✉	Art.number	d x L	✉	Art.number	d x L	✉	Art.number
M3X6	2000	24692.030.006	M4X20	1000	24692.040.020			
M3X8	2000	24692.030.008	M4X25	1000	24692.040.025	M6X16	500	24692.060.016
M3X10	2000	24692.030.010	M4X30	1000	24692.040.030	M6X20	250	24692.060.020
M3X12	2000	24692.030.012				M6X25	250	24692.060.025
M3X16	2000	24692.030.016	M5X10	1000	24692.050.010	M8X16	250	24692.080.016
M3X20	2000	24692.030.020	M5X12	1000	24692.050.012	M8X20	250	24692.080.020
			M5X16	1000	24692.050.016	M8X25	250	24692.080.025
M4X10	1000	24692.040.010	M5X20	500	24692.050.020	M8X35	250	24692.080.035
M4X12	1000	24692.040.012	M5X25	500	24692.050.025			
M4X16	1000	24692.040.016	M5X30	250	24692.050.030			

51320				Cross recessed raised countersunk head screw Phillips				R01A	
Thread	Metric thread			DIN	966-H				
Material	Stainless steel A2			ISO	7047-H				
									
									

d x L	✉	Art.number	d x L	✉	Art.number	d x L	✉	Art.number
M2X3*	1000	51320.020.003	M3X16	200	51320.030.016	M5X10	100	51320.050.010
M2X4*	1000	51320.020.004	M3X18*	500	51320.030.018	M5X12	100	51320.050.012
M2X5*	1000	51320.020.005	M3X20	200	51320.030.020	M5X14*	500	51320.050.014
M2X6*	1000	51320.020.006	M3X22*	500	51320.030.022	M5X16	100	51320.050.016
M2X8*	1000	51320.020.008	M3X25*	200	51320.030.025	M5X18*	500	51320.050.018
M2X10*	1000	51320.020.010	M3X30	200	51320.030.030	M5X20	100	51320.050.020
M2X12*	1000	51320.020.012				M5X22*	500	51320.050.022
M2X14*	1000	51320.020.014	M4X6*	500	51320.040.006	M5X25	100	51320.050.025
M2X16*	1000	51320.020.016	M4X8	200	51320.040.008	M5X30	100	51320.050.030
M2X18*	1000	51320.020.018	M4X10	200	51320.040.010	M5X35	100	51320.050.035
M2X20*	1000	51320.020.020	M4X12	200	51320.040.012	M5X40	100	51320.050.040
M2X25*	1000	51320.020.025	M4X14*	500	51320.040.014	M5X45*	200	51320.050.045
M2X30*	1000	51320.020.030	M4X16	200	51320.040.016	M5X50	100	51320.050.050
			M4X18*	500	51320.040.018	M5X60	100	51320.050.060
M2.5X5*	1000	51320.025.005	M4X20	200	51320.040.020	M5X70	100	51320.050.070
M2.5X6	100	51320.025.006	M4X22*	500	51320.040.022	M5X75*	200	51320.050.075
M2.5X8*	1000	51320.025.008	M4X25	200	51320.040.025	M5X80*	200	51320.050.080
M2.5X10	100	51320.025.010	M4X30	200	51320.040.030	M5X90*	200	51320.050.090
M2.5X12*	1000	51320.025.012	M4X35*	500	51320.040.035	M5X100*	200	51320.050.100
			M4X40	200	51320.040.040			
M3X5*	500	51320.030.005	M4X45*	500	51320.040.045	M6X8*	500	51320.060.008
M3X6	200	51320.030.006	M4X50	200	51320.040.050	M6X10	100	51320.060.010
M3X8	200	51320.030.008	M4X60	200	51320.040.060	M6X12	100	51320.060.012
M3X10	200	51320.030.010				M6X14*	500	51320.060.014
M3X12	200	51320.030.012	M5X6*	500	51320.050.006	M6X16	100	51320.060.016
M3X14*	500	51320.030.014	M5X8	100	51320.050.008	M6X18*	500	51320.060.018

51320 Cross recessed raised countersunk head screw Phillips								
d x L	☒	Art.number	d x L	☒	Art.number	d x L	☒	Art.number
M6X20	100	51320.060.020	M6X70*	200	51320.060.070	M8X25	100	51320.080.025
M6X25	100	51320.060.025	M6X75*	200	51320.060.075	M8X30	100	51320.080.030
M6X30	100	51320.060.030	M6X80	200	51320.060.080	M8X35	100	51320.080.035
M6X35	100	51320.060.035	M6X95*	200	51320.060.095	M8X40	100	51320.080.040
M6X40	100	51320.060.040	M6X100*	200	51320.060.100	M8X45*	200	51320.080.045
M6X45	100	51320.060.045				M8X50	100	51320.080.050
M6X50	100	51320.060.050	M8X12*	200	51320.080.012	M8X60	100	51320.080.060
M6X55*	200	51320.060.055	M8X16*	200	51320.080.016	M8X70*	100	51320.080.070
M6X60	100	51320.060.060	M8X20	100	51320.080.020	M8X80*	100	51320.080.080



51322 Cross recessed raised countersunk head screw Pozidriv					R01A
Thread	Metric thread	DIN	966-Z		
Material	Stainless steel A2	ISO	7047-Z		

d x L	☒	Art.number	d x L	☒	Art.number	d x L	☒	Art.number
M2X3*	1000	51322.020.003				M5X20	100	51322.050.020
M2X4*	1000	51322.020.004	M4X6*	500	51322.040.006	M5X25	100	51322.050.025
M2X5*	1000	51322.020.005	M4X8	200	51322.040.008	M5X30	100	51322.050.030
M2X6*	1000	51322.020.006	M4X10	200	51322.040.010	M5X35	100	51322.050.035
M2X12*	1000	51322.020.012	M4X12	200	51322.040.012	M5X40	100	51322.050.040
M2X16*	1000	51322.020.016	M4X14*	500	51322.040.014	M5X45*	200	51322.050.045
			M4X16	200	51322.040.016	M5X50*	200	51322.050.050
M2,5X5*	1000	51322.025.005	M4X20	200	51322.040.020			
M2,5X6*	1000	51322.025.006	M4X25	200	51322.040.025	M6X10	100	51322.060.010
M2,5X8*	1000	51322.025.008	M4X30	200	51322.040.030	M6X12	100	51322.060.012
M2,5X10*	1000	51322.025.010	M4X35*	500	51322.040.035	M6X16	100	51322.060.016
			M4X40*	500	51322.040.040	M6X20	100	51322.060.020
M3X5*	500	51322.030.005				M6X25	100	51322.060.025
M3X6*	500	51322.030.006	M5X6*	500	51322.050.006	M6X30	100	51322.060.030
M3X8	200	51322.030.008	M5X8	100	51322.050.008	M6X35	100	51322.060.035
M3X10	200	51322.030.010	M5X10	100	51322.050.010	M6X40	100	51322.060.040
M3X12	200	51322.030.012	M5X12	100	51322.050.012	M6X50*	200	51322.060.050
M3X16	200	51322.030.016	M5X14*	500	51322.050.014			
M3X25*	500	51322.030.025	M5X16	100	51322.050.016	M8X30*	200	51322.080.030
M3X30*	500	51322.030.030	M5X18*	500	51322.050.018	M8X50*	200	51322.080.050



6

55320 Cross recessed raised countersunk head screw Phillips					R41A
Thread	Metric thread	DIN	966-H		
Material	Stainless steel A4	ISO	7047-H		

d x L	☒	Art.number	d x L	☒	Art.number	d x L	☒	Art.number
M3X6*	500	55320.030.006	M3X30*	500	55320.030.030	M4X40*	500	55320.040.040
M3X8*	500	55320.030.008				M4X50*	500	55320.040.050
M3X10*	500	55320.030.010	M4X8*	500	55320.040.008			
M3X12*	500	55320.030.012	M4X12*	500	55320.040.012	M5X8*	500	55320.050.008
M3X16*	500	55320.030.016	M4X25*	500	55320.040.025			
M3X20*	500	55320.030.020	M4X30*	500	55320.040.030	M6X40*	200	55320.060.040
M3X25*	500	55320.030.025	M4X35*	500	55320.040.035			

55322 Cross recessed raised countersunk head screw Pozidriv					R41A
Thread	Metric thread	DIN	966-Z		
Material	Stainless steel A4	ISO	7047-Z		

d x L	☒	Art.number	d x L	☒	Art.number	d x L	☒	Art.number
M2X6	100	55322.020.006	M3X5*	500	55322.030.005			
M2X8	100	55322.020.008	M3X6	200	55322.030.006	M4X5*	500	55322.040.005
M2X10	100	55322.020.010	M3X8	200	55322.030.008	M4X6*	500	55322.040.006
			M3X10	200	55322.030.010	M4X8	200	55322.040.008
M2,5X6	100	55322.025.006	M3X12	200	55322.030.012	M4X10	200	55322.040.010
M2,5X8	100	55322.025.008	M3X16	200	55322.030.016	M4X12	200	55322.040.012
M2,5X10	100	55322.025.010	M3X18*	500	55322.030.018	M4X14*	500	55322.040.014
M2,5X12	100	55322.025.012	M3X20*	500	55322.030.020	M4X16	200	55322.040.016
			M3X25*	500	55322.030.025	M4X18*	500	55322.040.018
M3X4*	500	55322.030.004	M3X30*	500	55322.030.030	M4X20	200	55322.040.020

55322 Cross recessed raised countersunk head screw Pozidriv								
d x L	☒	Art.number	d x L	☒	Art.number	d x L	☒	Art.number
M4X25	200	55322.040.025	M5X20	100	55322.050.020	M6X16	100	55322.060.016
M4X30	200	55322.040.030	M5X25	100	55322.050.025	M6X20	100	55322.060.020
M4X35*	500	55322.040.035	M5X30	100	55322.050.030	M6X25	100	55322.060.025
M4X40*	500	55322.040.040	M5X35*	500	55322.050.035	M6X30	100	55322.060.030
M4X50*	500	55322.040.050	M5X40	100	55322.050.040	M6X35	100	55322.060.035
M5X8	100	55322.050.008	M5X50*	200	55322.050.050	M6X40	100	55322.060.040
M5X10	100	55322.050.010	M5X70*	200	55322.050.070	M6X50*	200	55322.060.050
M5X12	100	55322.050.012	M6X10	100	55322.060.010	M6X60*	200	55322.060.060
M5X16	100	55322.050.016	M6X12	100	55322.060.012			

Hexalobular raised countersunk head screw

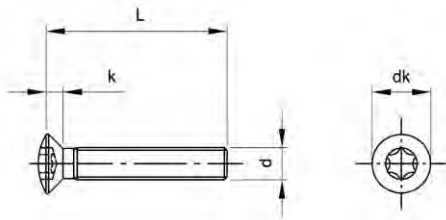

DIN ≈966
ISO ≈14584



Technical Data

d	d _k	k (max.)	P	Socket
M3	5,6	1,65	0,5	T10
M4	7,5	2,2	0,7	T20
M5	9,2	2,5	0,8	T25
M6	11	3	1	T30

Article groups

Thread	Driving features	Material	Code	Page
M	Hexalobular	St.St. A2	51325	6-54
M	Hexalobular	St.St. A4	55325	6-55

51325 Hexalobular raised countersunk head screw		R01A
Thread	Metric thread	
Material	Stainless steel A2	

d x L	☒	Art.number	d x L	☒	Art.number	d x L	☒	Art.number
M3X4*	500	51325.030.004	M4X25*	500	51325.040.025	M5X45*	200	51325.050.045
M3X5*	500	51325.030.005	M4X30*	500	51325.040.030	M5X50*	200	51325.050.050
M3X6*	500	51325.030.006	M4X35*	500	51325.040.035	M5X55*	200	51325.050.055
M3X8*	500	51325.030.008	M4X40*	500	51325.040.040	M5X60*	200	51325.050.060
M3X10*	500	51325.030.010	M4X45*	500	51325.040.045	M5X70*	200	51325.050.070
M3X12*	500	51325.030.012	M4X50*	500	51325.040.050	M6X10*	500	51325.060.010
M3X16*	500	51325.030.016	M4X60*	500	51325.040.060	M6X12*	500	51325.060.012
M3X20*	500	51325.030.020	M5X6*	500	51325.050.006	M6X16*	500	51325.060.016
M3X25*	500	51325.030.025	M5X8*	500	51325.050.008	M6X20*	500	51325.060.020
M3X30*	500	51325.030.030	M5X10*	500	51325.050.010	M6X25*	200	51325.060.025
M3X35*	500	51325.030.035	M5X12*	500	51325.050.012	M6X30*	200	51325.060.030
M3X40*	500	51325.030.040	M5X16*	500	51325.050.016	M6X35*	200	51325.060.035
M4X8*	500	51325.040.008	M5X20*	500	51325.050.020	M6X40*	200	51325.060.040
M4X10*	500	51325.040.010	M5X25*	500	51325.050.025	M6X45*	200	51325.060.045
M4X12*	500	51325.040.012	M5X30*	500	51325.050.030	M6X50*	200	51325.060.050
M4X16*	500	51325.040.016	M5X35*	500	51325.050.035	M6X60*	200	51325.060.060
M4X20*	500	51325.040.020	M5X40*	500	51325.050.040			

55325	Hexalobular raised countersunk head screw		R41A
Thread	Metric thread		
Material	Stainless steel A4		
			
			

d x L	☒	Art.number	d x L	☒	Art.number	d x L	☒	Art.number
M4X5*	500	55325.040.005	M5X10*	500	55325.050.010	M6X12*	500	55325.060.012
M4X6*	500	55325.040.006	M5X12*	500	55325.050.012	M6X16*	500	55325.060.016
M4X8*	500	55325.040.008	M5X16*	500	55325.050.016	M6X20*	500	55325.060.020
M4X10*	500	55325.040.010	M5X20*	500	55325.050.020	M6X25*	200	55325.060.025
M4X12*	500	55325.040.012	M5X25*	500	55325.050.025	M6X30*	200	55325.060.030
M4X16*	500	55325.040.016	M5X30*	500	55325.050.030	M6X35*	200	55325.060.035
M4X20*	500	55325.040.020	M5X35*	500	55325.050.035	M6X40*	200	55325.060.040
M4X25*	500	55325.040.025	M5X40*	500	55325.050.040	M6X50*	200	55325.060.050
M4X30*	500	55325.040.030	M5X50*	200	55325.050.050	M6X60*	200	55325.060.060
M4X40*	500	55325.040.040	M5X60*	200	55325.050.060			

Double slotted mushroom head screw

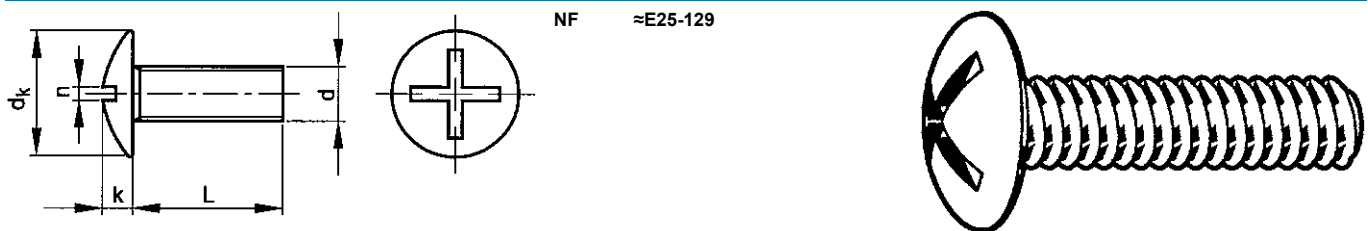

Technical Data				
d	d _k (max.)	k (max.)	n (max.)	P
M5	12	4	1.3	0.8
M6	14	4.2	1.7	1
M8	20	4.4	2.31	1.25
M10	25	5.5	2.81	1.5

- M6 Application in combination with pointed nuts in boxes and cabinets.

24650	Double slotted mushroom head screw		H01X
Thread	Metric thread		
Material	Steel		
Class	4.8		
Surface treatment	Zinc plated		
			
			

d x L	☒	Art.number	d x L	☒	Art.number	d x L	☒	Art.number
M5X8	1000	24650.050.008	M6X30	200	24650.060.030	M8X40	100	24650.080.040
M5X10	1000	24650.050.010	M6X40	100	24650.060.040	M8X50	100	24650.080.050
M5X12	1000	24650.050.012	M6X50	100	24650.060.050	M8X60	100	24650.080.060
M5X16	1000	24650.050.016	M6X60	100	24650.060.060	M8X80	100	24650.080.080
			M6X80	100	24650.060.080	M8X100	100	24650.080.100
M6X10	1000	24650.060.010				M10X40	100	24650.100.040
M6X12	1000	24650.060.013	M8X15	200	24650.080.016			
M6X16	200	24650.060.016	M8X20	100	24650.080.020			
M6X20	200	24650.060.020	M8X30	100	24650.080.030			

Double slotted mushroom head screw

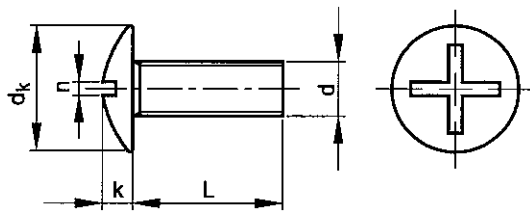

NF E25-129

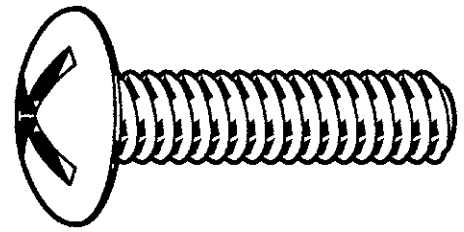

Technical Data

d	d _k (max.)	k (max.)	n	P
M4	10.0	2.2	1.2	0.7
M5	12.5	2.7	1.2	0.8
M6	15.0	3.3	1.6	1
M8	20.0	4.4	2.0	1.25
M10	25.0	5.5	2.5	1.5

Article groups

Thread	Driving features	Material	Class	Surface treatment	Code	Page
M	Slotted	St	4.8	Zipl	24862	6-56
M	Slotted	St	4.8	Zipl with nut	24874	6-56

6

24862 Double slotted mushroom head screw H01X

Thread	Metric thread
Material	Steel
Class	4.8
Surface treatment	Zinc plated

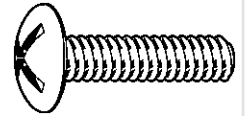

d x L	☒	Art.number	d x L	☒	Art.number	d x L	☒	Art.number
M4X10	500	24862.040.010	M6X10	200	24862.060.010	M8X16	200	24862.080.016
M4X16	500	24862.040.016	M6X12	200	24862.060.012	M8X20	100	24862.080.020
M4X20	500	24862.040.020	M6X16	200	24862.060.016	M8X25	100	24862.080.025
M4X25	500	24862.040.025	M6X20	200	24862.060.020	M8X30	100	24862.080.030
M4X30	500	24862.040.030	M6X25	200	24862.060.025	M8X35	200	24862.080.035
			M6X30	200	24862.060.030	M8X40	100	24862.080.040
M5X10	500	24862.050.010	M6X35	200	24862.060.035	M8X50	100	24862.080.050
M5X16	500	24862.050.016	M6X40	100	24862.060.040			
M5X20	500	24862.050.020	M6X45	100	24862.060.045			
M5X25	200	24862.050.025	M6X50	100	24862.060.050			
M5X30	200	24862.050.030	M6X60	100	24862.060.060			
			M6X70	100	24862.060.070	M10X50	100	24862.100.050
			M6X100	100	24862.060.100	M10X60	50	24862.100.060

24874 Double slotted mushroom head screw with hexagon nut H01X

Thread	Metric thread
Material	Steel
Class	4.8
Surface treatment	Zinc plated

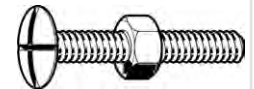

d x L	☒	Art.number	d x L	☒	Art.number	d x L	☒	Art.number
M4X16	500	24874.040.016	M6X10	200	24874.060.010	M8X20	200	24874.080.020
M4X20	500	24874.040.020	M6X12	200	24874.060.012	M8X25	200	24874.080.025
M4X25	500	24874.040.025	M6X16	200	24874.060.016	M8X30	200	24874.080.030
M4X30	500	24874.040.030	M6X20	200	24874.060.020	M8X35	100	24874.080.035
M4X35	200	24874.040.035	M6X25	200	24874.060.025	M8X40	100	24874.080.040
M4X40	200	24874.040.040	M6X30	200	24874.060.030	M8X45	100	24874.080.045
M4X50	200	24874.040.050	M6X35	200	24874.060.035	M8X50	100	24874.080.050
			M6X40	200	24874.060.040	M8X60	100	24874.080.060
M5X16	200	24874.050.016	M6X45	100	24874.060.045	M8X70	100	24874.080.070
M5X20	200	24874.050.020	M6X50	100	24874.060.050	M8X80	100	24874.080.080
M5X25	200	24874.050.025	M6X60	100	24874.060.060	M8X100	100	24874.080.100
M5X30	200	24874.050.030	M6X70	100	24874.060.070			
M5X35	200	24874.050.035	M6X80	100	24874.060.080	M10X30	100	24874.100.030
M5X40	200	24874.050.040	M6X100	100	24874.060.100	M10X40	100	24874.100.040
M5X50	200	24874.050.050				M10X50	100	24874.100.050
M5X60	200	24874.050.060	M8X16	200	24874.080.016	M10X60	50	24874.100.060

Cross recessed raised cheese head thread cutting screw

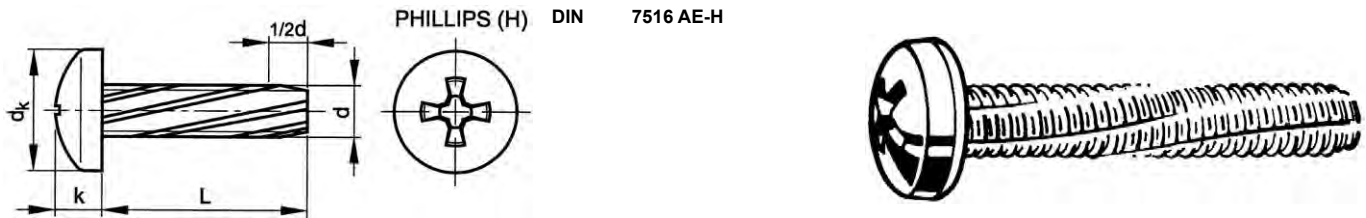

Technical Data

d	dk	Drill ø (H11)	k	No. cross recess	P
M3	6	2.7	2.4	1	0.5
M4	8	3.6	3.1	2	0.7
M5	10	4.5	3.8	2	0.8
M6	12	5.5	4.6	3	1

- Drill ø (H11) = The given boring diameters are guide lines for materials of medium strength.
- For thin-walled workpieces or workpieces made from soft materials, a smaller core hole diameter, for thick walled workpieces or workpieces made from hard materials a larger core hole diameter may be chosen.
- It is recommended that the exact diameter selection is made on basis of tests.
- The depth of engagement should not exceed 2 d.

27100 Cross recessed raised cheese head thread cutting screw Phillips

J04A

Thread Metric thread
Material Steel
Surface treatment Zinc plated

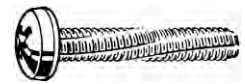

6

d x L	☒	Art.number	d x L	☒	Art.number	d x L	☒	Art.number
M3X6	2000	27100.030.006	M4X16	2000	27100.040.016	M5X30	500	27100.050.030
M3X8	2000	27100.030.008	M4X20	1000	27100.040.020	M6X12	1000	27100.060.012
M3X10	2000	27100.030.010	M4X25	1000	27100.040.025	M6X16	500	27100.060.016
M3X12	2000	27100.030.012	M5X10	2000	27100.050.010	M6X20	500	27100.060.020
M3X16	2000	27100.030.016	M5X12	1000	27100.050.012	M6X25	500	27100.060.025
M4X8	2000	27100.040.008	M5X16	1000	27100.050.016	M6X30	500	27100.060.030
M4X10	2000	27100.040.010	M5X20	500	27100.050.020	M6X35	250	27100.060.035
M4X12	2000	27100.040.012	M5X25	500	27100.050.025			

- Warning: electro-galvanizing of these products may cause hydrogen embrittlement.

Cross recessed raised countersunk head thread cutting screw

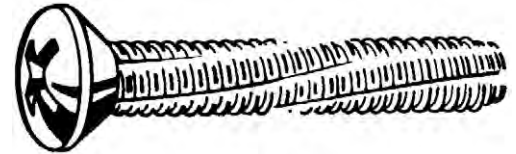
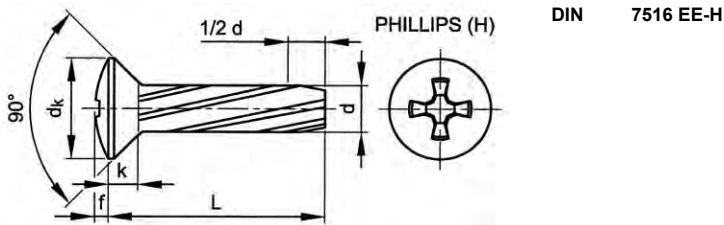



Technical Data

d	d _k	Drill ø (H11)	f ≈	k (max.)	No. cross recess	P
M4	7.5	3.6	1	2.2	2	0.7
M5	9.2	4.5	1.25	2.5	2	0.8
M6	11	5.5	1.5	3	3	1

- Drill ø (H11) = The given boring diameters are guide lines for materials of medium strength.
- For thin-walled workpieces or workpieces made from soft materials, a smaller core hole diameter, for thick walled workpieces or workpieces made from hard materials a larger core hole diameter may be chosen.
- It is recommended that the exact diameter selection is made on basis of tests.
- The depth of engagement should not exceed 2 d.

27180 Cross recessed raised countersunk head thread cutting screw Phillips J04A

Thread	Metric thread
Material	Steel
Surface treatment	Zinc plated





6

d x L	☒	Art.number	d x L	☒	Art.number	d x L	☒	Art.number
M4X10	2000	27180.040.010						
M4X12	2000	27180.040.012	M5X16	1000	27180.050.016	M6X25	500	27180.060.025
M4X16	2000	27180.040.016	M5X20	500	27180.050.020	M6X30	500	27180.060.030
M4X20	1000	27180.040.020	M5X25	500	27180.050.025	M6X35	250	27180.060.035
M4X25	1000	27180.040.025	M5X30	500	27180.050.030			

- Warning: electro-galvanizing of these products may cause hydrogen embrittlement.

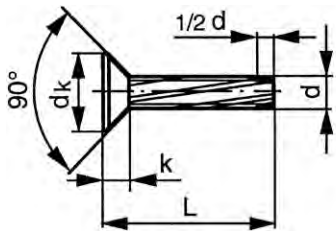
Cross recessed countersunk head thread cutting screw



PHILLIPS(H) DIN 7516 DE-H

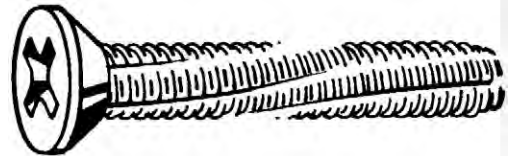

Technical Data

d	d _k	Drill ø (H11)	k (max.)	No. cross recess	P
M3	5.5	2.7	1.65	1	0.5
M4	8.4	3.6	2.7	2	0.7
M5	9.3	4.5	2.7	2	0.8
M6	11.3	5.5	3.3	3	1

- Drill ø (H11) = The given boring diameters are guide lines for materials of medium strength.
- For thin-walled workpieces or workpieces made from soft materials, a smaller core hole diameter, for thick walled workpieces or workpieces made from hard materials a larger core hole diameter may be chosen.
- It is recommended that the exact diameter selection is made on basis of tests.
- The depth of engagement should not exceed 2 d.

27160 Cross recessed countersunk head thread cutting screw Phillips

J04A

Thread Metric thread
Material Steel
Surface treatment Zinc plated



6

d x L	☒	Art.number	d x L	☒	Art.number	d x L	☒	Art.number
M3X10	2000	27160.030.010	M4X25	1000	27160.040.025	M6X16	500	27160.060.016
M3X12	2000	27160.030.012	M4X30	1000	27160.040.030	M6X20	500	27160.060.020
M3X16	2000	27160.030.016				M6X25	500	27160.060.025
M3X20	2000	27160.030.020	M5X10	1000	27160.050.010	M6X30	500	27160.060.030
			M5X12	1000	27160.050.012	M6X35	250	27160.060.035
M4X10	2000	27160.040.010	M5X16	1000	27160.050.016	M6X40	250	27160.060.040
M4X12	2000	27160.040.012	M5X20	500	27160.050.020			
M4X16	2000	27160.040.016	M5X25	500	27160.050.025			
M4X20	1000	27160.040.020	M5X30	500	27160.050.030			

- Warning: electro-galvanizing of these products may cause hydrogen embrittlement.

Hexagon head thread cutting screw

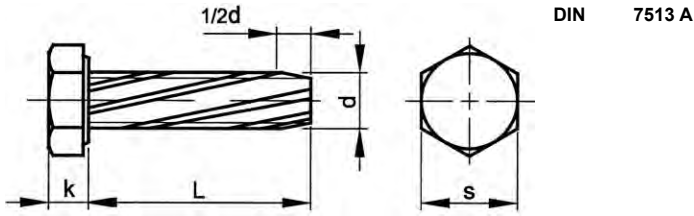

DIN 7513 A



Technical Data

d	Drill ø (H11)	k	P	s
M5	4.5	3.5	0.8	8
M6	5.5	4	1	10
M8	7.4	5.3	1.25	13

- Drill ø (H11) = The given boring diameters are guide lines for materials of medium strength.
- For thin-walled workpieces or workpieces made from soft materials, a smaller core hole diameter, for thick walled workpieces or workpieces made from hard materials a larger core hole diameter may be chosen.
- It is recommended that the exact diameter selection is made on basis of tests.
- The depth of engagement should not exceed 2 d.

6

27010 Hexagon head thread cutting screw		J04A
Thread	Metric thread	 
Material	Steel	
Surface treatment	Zinc plated	

d x L	☒	Art.number	d x L	☒	Art.number	d x L	☒	Art.number
M5X10	2000	27010.050.010	M6X16	500	27010.060.016	M8X16	500	27010.080.016
M5X12	1000	27010.050.012	M6X20	500	27010.060.020	M8X20	250	27010.080.020
M5X16	1000	27010.050.016	M6X25	500	27010.060.025	M8X25	250	27010.080.025
M5X20	500	27010.050.020	M6X30	500	27010.060.030	M8X30	250	27010.080.030
M5X25	500	27010.050.025	M6X35	250	27010.060.035	M8X35	250	27010.080.035
M6X12	1000	27010.060.012				M8X40	200	27010.080.040

- Warning: electro-galvanizing of these products may cause hydrogen embrittlement.

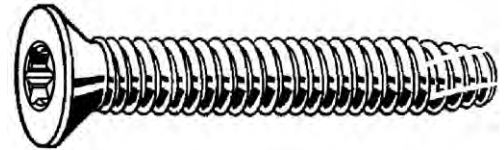
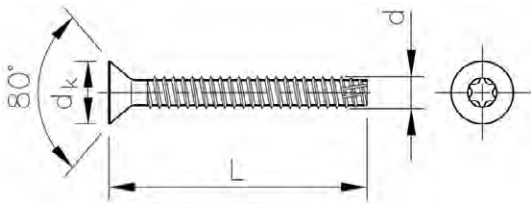

Hexalobular socket countersunk head thread cutting screw



Technical Data

d	d _k	Drill ø	Socket	Threads per inch
U6.3 (1/4)	12	5.6	T30	20

- The given boring diameters are guide lines for materials of medium strength.
- For thin-walled workpieces or workpieces made from soft materials, a smaller core hole diameter, for thick walled workpieces or workpieces made from hard materials a larger core hole diameter may be chosen.
- It is recommended that the exact diameter selection is made on basis of tests.

31290 Hexalobular socket countersunk head thread cutting screw		J10A
Thread	Unified National Coarse	
Material	Steel	
Surface treatment	Zinc plated	
		 

d x L	☒	Art.number	d x L	☒	Art.number	d x L	☒	Art.number
6,3X38MM	1000	31290.063.038	6,3X65MM	500	31290.063.065	6,3X80MM	500	31290.063.080
6,3X50MM	1000	31290.063.050						

TAPTITE 2000® Thread-rolling bolts and screws

General

Due to their specific triangular (trilobular) cross section and flowing transitions, TAPTITE 2000® thread-rolling bolts and screws form the internal screw thread in the side of a predrilled or punched hole without creating swarf; tapping is dispensed with and no annoying and sometimes unallowable swarf is created. TAPTITE 2000® bolts and screws now, in addition to the proven advantages of their standard predecessor, have an innovative thread design: the Radius Profile™. This results in a new generation of fasteners with excellent mechanical, assembly and ergonomic characteristics; as yet unsurpassed by any other technology.

Applications

TAPTITE 2000® thread-rolling bolts and screws can be used in all ductile metals up to 500 N/mm² or 150 HB.

Load

Due to the cold hardening of the material, the uninterrupted fibre structure and the full flank overlapping, the connection can accommodate considerably higher forces, usually a smaller size can be used than for a tapped thread; therefore a lighter design. Moreover, the special Radius Profile™ ensures a low insertion torque, while the preloading force and pull-out force have increased; thus a higher safety margin.

Locking

Due to the clamping action of the material on the thread flanks, the connection is self-locking; no additional locking agents are required.

Formed thread

The TAPTITE 2000® thread rolling bolts and screws form a normal ISO metric thread, into which other metric fasteners with the usual 6h tolerance (according to ISO 965) can be screwed.

Drive, head style and point length

All usual drive options and head styles are possible. Serrations under the head, a colour, an attached washer or pre-coated adhesive or seals are also possible. The conical screw thread point length of this new generation of TAPTITE 2000® thread-rolling bolts and screws has been reduced to approximately 2 – 2.5 P (was at the maximum 4P).

Material and surface coating

TAPTITE 2000® thread-rolling bolts and screws are made of case hardening steel and are case hardened (min. 450 HV0.3), while the core has retained its ductility (300-350 HV10). As standard, the bolts/screws are Cr6+ free electro-galvanized. Other surface coatings or materials are possible.

6

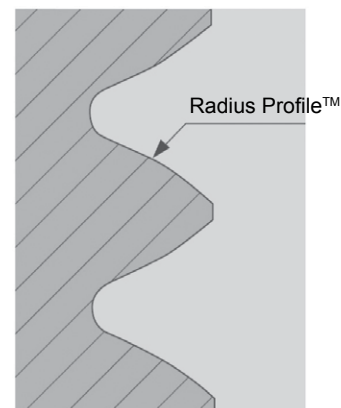
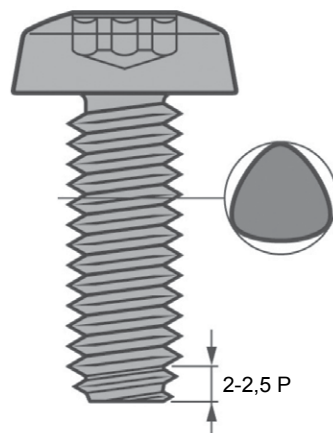

Design values for TAPTITE 2000® thread-rolling bolts and screws (1)

d	M2,5	M3	M3,5	M4	M5	M6	M8
Insertion torque (Nm)	0,4	0,8	1,3	2,0	3,2	6,4	16,0
Tightening torque maximum (Nm)	0,8	1,5	2,5	3,7	7,0	12,0	30,0
Failure torque min. (Nm) (inserted)	1,2	2,0	3,3	4,8	10,0	16,0	41,0
Preloading force during assembly (kN)	---	1,9	2,6	3,4	5,6	7,8	15,0

(1) The specified values apply to St 37 steel for an insertion length 1 x screw thread diameter

TAPTITE 2000® is a registered trademark of Conti Fasteners AG

Hexagon head thread rolling screw with flange

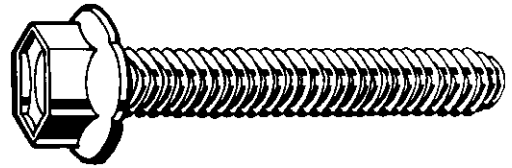
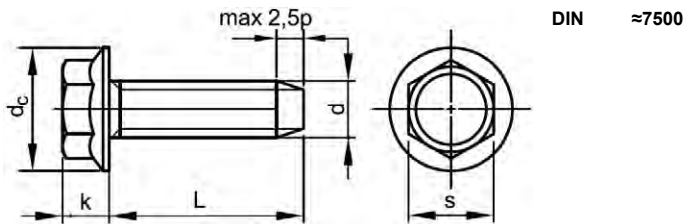

Technical Data

d	d _c (max.)	k (max.)	P	s
M3	6.9	2.58	0.5	5.5
M4	8.9	3.58	0.7	7
M5	10.4	4.45	0.8	8
M6	13	5.2	1	10
M8	17	7	1.25	13

- The nominal length (L) is with tolerance js15.

67020 TAPTITE 2000® Hexagon head thread rolling screw with flange

J05A

Thread Metric thread
Material Steel
Surface treatment Zinc plated



6

d x L	☒	Art.number	d x L	☒	Art.number	d x L	☒	Art.number
M3X10	1000	67020.030.010	M5X8	500	67020.050.008	M6X16	500	67020.060.016
M4X6	1000	67020.040.006	M5X10	500	67020.050.010	M6X20	500	67020.060.020
M4X8	1000	67020.040.008	M5X12	500	67020.050.012	M6X25	500	67020.060.025
M4X10	1000	67020.040.010	M5X16	500	67020.050.016	M6X30	500	67020.060.030
M4X12	1000	67020.040.012	M5X20	500	67020.050.020	M8X15	500	67020.080.015
M4X16	1000	67020.040.016	M6X10	500	67020.060.010	M8X20	500	67020.080.020
			M6X12	500	67020.060.012	M8X25	500	67020.080.025

- Warning: electro-galvanizing of these products may cause hydrogen embrittlement.

Countersunk head thread rolling screw with Torx®recess

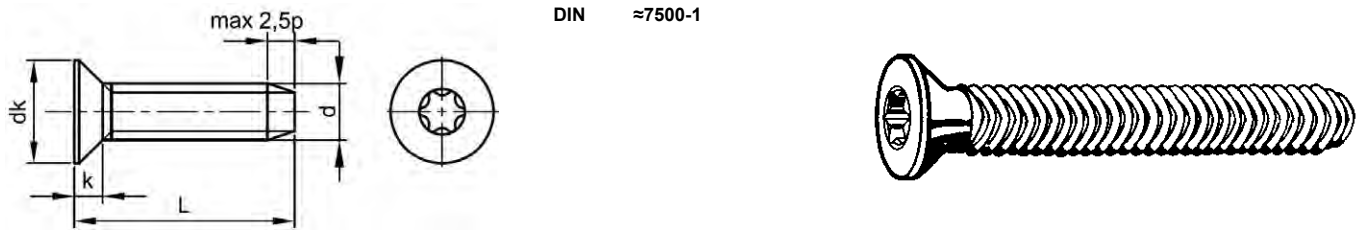

DIN ≈7500-1



Technical Data

d	d _k	k (max.)	No. Torx®	P
M3	5.6	1.65	10	0.5
M4	7.5	2.2	20	0.7
M5	9.2	2.5	25	0.8
M6	11	3	30	1
M8	14.5	4	40	1.25

- The nominal length (L) is with tolerance js15.

67080 TAPTITE 2000® Countersunk head thread rolling screw with Torx®recess J05A

Thread Metric thread
Material Steel
Surface treatment Zinc plated

d x L	☒	Art.number	d x L	☒	Art.number	d x L	☒	Art.number
M3X8	1000	67080.030.008	M4X25	1000	67080.040.025	M6X16	500	67080.060.016
M3X10	1000	67080.030.010				M6X20	500	67080.060.020
M3X12	1000	67080.030.012	M5X10	500	67080.050.010	M6X25	500	67080.060.025
M3X16	1000	67080.030.016	M5X12	500	67080.050.012	M6X30	500	67080.060.030
			M5X16	500	67080.050.016	M6X40	500	67080.060.040
M4X10	1000	67080.040.010	M5X20	500	67080.050.020			
M4X12	1000	67080.040.012	M5X25	500	67080.050.025	M8X40	500	67080.080.040
M4X16	1000	67080.040.016	M5X30	500	67080.050.030			
M4X20	1000	67080.040.020						

- Warning: electro-galvanizing of these products may cause hydrogen embrittlement.

Raised cheese head thread rolling screw with Torx®recess

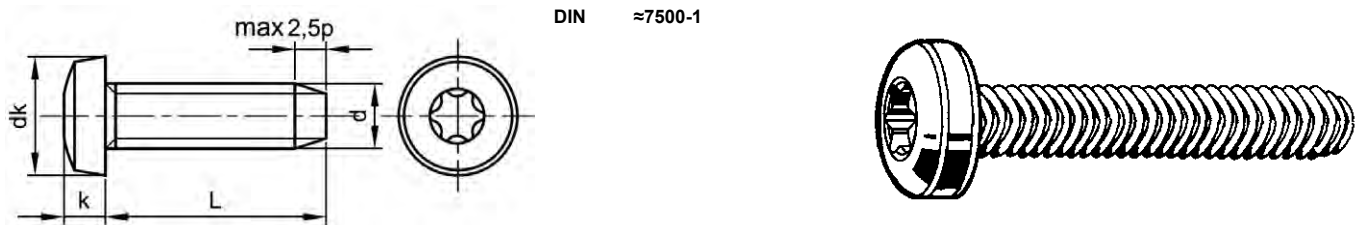

DIN ≈7500-1

Technical Data

d	d _k	k (max.)	No. Torx®	P
M2.5	5	2.12	8	0.45
M3	6	2.52	10	0.5
M3.5	7	2.82	15	0.6
M4	8	3.25	20	0.7
M5	10	3.95	25	0.8
M6	12	4.75	30	1

- The nominal length (L) is with tolerance js15.

67155 TAPTITE 2000® Raised cheese head thread rolling screw with Torx®recess

J05A

Thread Metric thread
Material Steel
Surface treatment Zinc plated

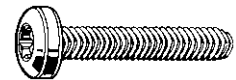

6

d x L	⊠	Art.number	d x L	⊠	Art.number	d x L	⊠	Art.number
M2,5X16	1000	67155.025.016	M4X6	1000	67155.040.006	M5X12	500	67155.050.012
M3X6	1000	67155.030.006	M4X8	1000	67155.040.008	M5X16	500	67155.050.016
M3X8	1000	67155.030.008	M4X10	1000	67155.040.010	M5X20	500	67155.050.020
M3X10	1000	67155.030.010	M4X12	1000	67155.040.012	M5X25	500	67155.050.025
M3X12	1000	67155.030.012	M4X16	1000	67155.040.016	M5X30	500	67155.050.030
M3X16	1000	67155.030.016	M4X20	1000	67155.040.020	M6X10	500	67155.060.010
M3X20	1000	67155.030.020	M4X25	1000	67155.040.025	M6X12	500	67155.060.012
M3X25	1000	67155.030.025	M4X30	1000	67155.040.030	M6X16	500	67155.060.016
M3,5X8	1000	67155.035.008	M5X8	500	67155.050.008	M6X20	500	67155.060.020
M3,5X12	1000	67155.035.012	M5X10	500	67155.050.010	M6X30	500	67155.060.030

- Warning: electro-galvanizing of these products may cause hydrogen embrittlement.

Cross recessed raised cheese head thread rolling screw

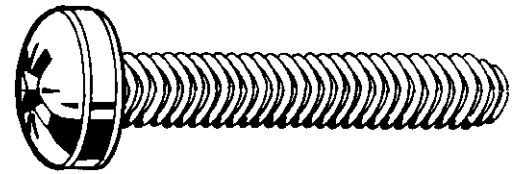
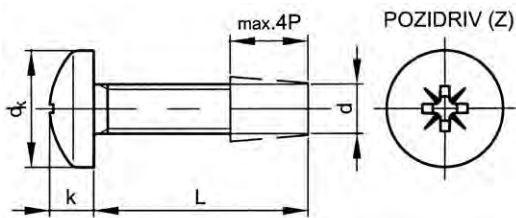

Technical Data

d	dk (max.)	k (max.)	No. cross recess	P
M2.5	4.6	1.96	1	0.45
M3	4.7	1.96	1	0.5
M4	7.64	2.92	2	0.7
M5	9.14	3.52	3	0.8
M6	11.57	4.3	3	1

51330 Cross recessed raised cheese head thread rolling screw Pozidriv

R01A

Thread Metric thread
Material Stainless steel A2



6

d x L	✉	Art.number	d x L	✉	Art.number	d x L	✉	Art.number
M2,5X5*	1000	51330.025.005	M3X20*	1000	51330.030.020	M5X10*	500	51330.050.010
M2,5X6*	1000	51330.025.006	M4X6*	1000	51330.040.006	M5X12*	500	51330.050.012
M2,5X8*	1000	51330.025.008	M4X8*	1000	51330.040.008	M5X16*	500	51330.050.016
M2,5X10*	1000	51330.025.010	M4X10*	1000	51330.040.010	M5X20*	500	51330.050.020
M3X5*	1000	51330.030.005	M4X12*	1000	51330.040.012	M6X10*	500	51330.060.010
M3X6*	1000	51330.030.006	M4X16*	1000	51330.040.016	M6X12*	500	51330.060.012
M3X8*	1000	51330.030.008	M4X20*	1000	51330.040.020	M6X16*	500	51330.060.016
M3X10*	1000	51330.030.010	M5X8*	500	51330.050.008	M6X20*	500	51330.060.020
M3X12*	1000	51330.030.012				M6X25*	500	51330.060.025
M3X16*	1000	51330.030.016						

Thread rolling raised cheese head screw hexalobular

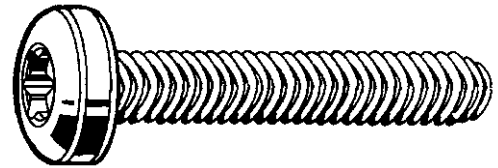
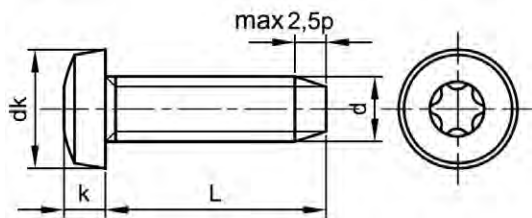

Technical Data

d	d _k (max.)	k (max.)	P	Socket
M2.5	5	2.1	0.45	T8
M3	5.6	2.4	0.5	T10
M4	8	3.1	0.7	T20
M5	9.5	3.7	0.8	T25
M6	12	4.6	1	T30

51327 Thread rolling raised cheese head screw hexalobular

R01A

Thread Metric thread
Material Stainless steel A2

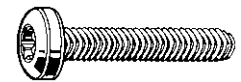

d x L	☒	Art.number	d x L	☒	Art.number	d x L	☒	Art.number
M2,5X4*	1000	51327.025.004	M3X20*	1000	51327.030.020	M5X12*	500	51327.050.012
M2,5X5*	1000	51327.025.005	M4X6*	1000	51327.040.006	M5X16*	500	51327.050.016
M2,5X6*	1000	51327.025.006	M4X8	1000	51327.040.008	M5X20*	500	51327.050.020
M2,5X8*	1000	51327.025.008	M4X10*	1000	51327.040.010	M5X25*	500	51327.050.025
M2,5X10*	1000	51327.025.010	M4X12*	1000	51327.040.012	M6X8*	500	51327.060.008
M3X5*	1000	51327.030.005	M4X16*	1000	51327.040.016	M6X10*	500	51327.060.010
M3X6*	1000	51327.030.006	M4X20*	1000	51327.040.020	M6X12*	500	51327.060.012
M3X8*	1000	51327.030.008	M4X25*	1000	51327.040.025	M6X16*	500	51327.060.016
M3X10*	1000	51327.030.010	M5X8*	500	51327.050.008	M6X20*	500	51327.060.020
M3X12*	1000	51327.030.012	M5X10*	500	51327.050.010	M6X25*	500	51327.060.025
M3X16*	1000	51327.030.016						

Thread rolling countersunk head screw

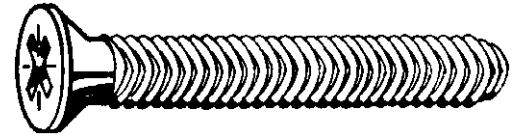
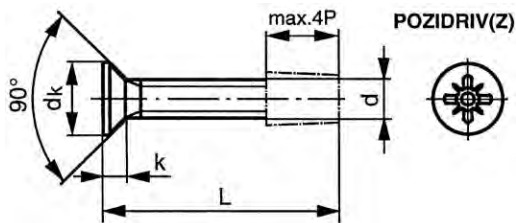

Technical Data

d	d _k (max.)	k (max.)	No. cross recess	P
M2.5	4.4	1.5	1	0.45
M3	5.2	1.65	1	0.5
M4	8	2.7	2	0.7
M5	8.9	2.7	2	0.8

51331 Thread rolling countersunk head screw Pozidriv

R01A

Thread Material Metric thread
Stainless steel A2



6

d x L	Art.number	d x L	Art.number	d x L	Art.number
M2.5X5*	1000 51331.025.005	M3X12*	1000 51331.030.012	M5X10*	500 51331.050.010
M2.5X6*	1000 51331.025.006			M5X12	500 51331.050.012
M2.5X8*	1000 51331.025.008	M4X8*	1000 51331.040.008	M5X16*	500 51331.050.016
M2.5X10*	1000 51331.025.010	M4X10*	1000 51331.040.010	M5X20*	500 51331.050.020
		M4X12*	1000 51331.040.012	M5X25*	500 51331.050.025
M3X6*	1000 51331.030.006	M4X16*	1000 51331.040.016	M5X30*	500 51331.050.030
M3X8*	1000 51331.030.008	M4X20*	1000 51331.040.020		
M3X10*	1000 51331.030.010				

Thread rolling countersunk head screw hexalobular

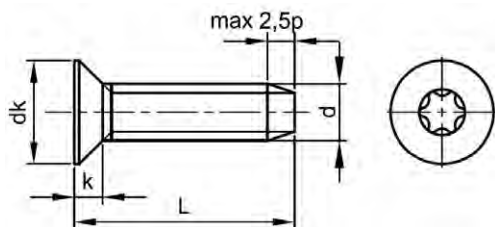

Technical Data

d	d _k (max.)	k (max.)	P	Socket
M2.5	5	2.1	0.45	T8
M3	5	2.1	0.45	T8
M4	5	2.1	0.45	T8
M5	5	2.1	0.45	T8

51329 Thread rolling countersunk head screw hexalobular

R01A

Thread Material Metric thread
Stainless steel A2



d x L	Art.number	d x L	Art.number	d x L	Art.number
M2.5X5*	1000 51329.025.005	M3X10*	1000 51329.030.010	M5X10*	500 51329.050.010
M2.5X6*	1000 51329.025.006	M3X12*	1000 51329.030.012	M5X12*	500 51329.050.012
M2.5X8*	1000 51329.025.008			M5X16*	500 51329.050.016
M2.5X10*	1000 51329.025.010	M4X8*	1000 51329.040.008	M5X20*	500 51329.050.020
M2.5X12*	1000 51329.025.012	M4X10*	1000 51329.040.010	M5X25*	500 51329.050.025
		M4X12*	1000 51329.040.012	M5X30*	500 51329.050.030
M3X6*	1000 51329.030.006	M4X16*	1000 51329.040.016		
M3X8*	1000 51329.030.008	M4X20*	1000 51329.040.020		

REMFORM® Thread-forming screws for use in plastics

Specific characteristics of REMFORM® thread-forming screws for use in plastics

- The ideal solution for fastening of/ in all types of plastic (thermoplastic or elastomer)
- Angle of thread of just 8°
- Asymmetric thread geometry which allows the plastic during assembly to flow along the load-bearing flank resulting in
 - less plastic being displaced
 - lower insertion torque
 - deeper profile depth
 - large flank cover, therefore high loadability
 - less chance of the plastic cracking
 - useable in thin-walled castings
- Made as standard
 - in strength class 9.8
 - Cr⁶⁺-free electro-galvanized
 - other materials and surface coatings are possible
- Due to the clamping action of the material on the thread flanks, the connection is self-locking

6

REMFORM® detail of thread

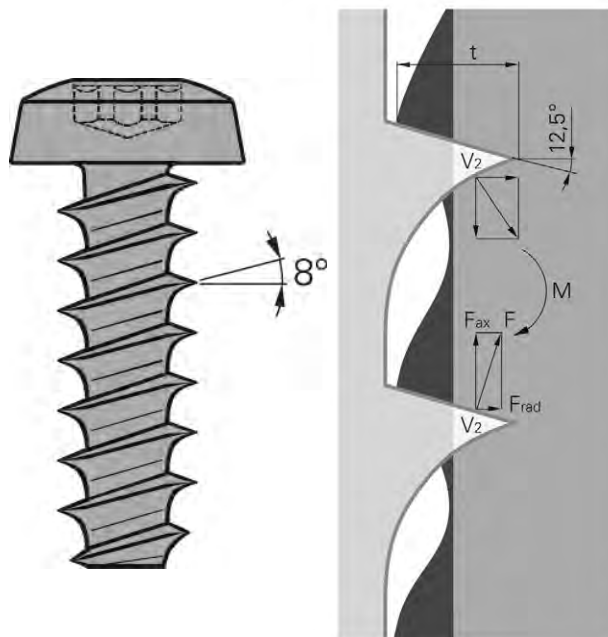

Cross recessed raised cheese head thread forming screw

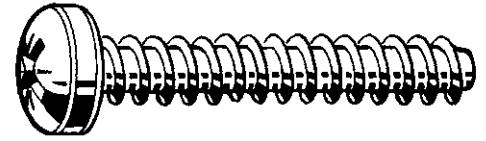
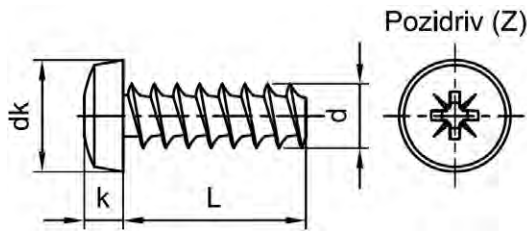

Technical Data

d (nom.)	d _k (max.)	k (max.)	No. cross recess
2.2	4.0	1.6	1
2.5	4.4	1.7	1
3.0	5.3	2.0	1
3.5	6.1	2.5	2
4.0	7.0	2.7	2
5.0	8.8	3.4	2
6.0	10.5	4.0	3

67551 REMFORM® Cross recessed raised cheese head thread forming screw Pozidriv

J05A

Thread REMFORM®
Material Steel
Surface treatment Zinc plated



6

d (nom.) x L	☒	Art.number	d (nom.) x L	☒	Art.number	d (nom.) x L	☒	Art.number
2,2X6MM	200	67551.022.006	3X10MM	200	67551.030.010	4X14MM	200	67551.040.014
2,2X8MM	200	67551.022.008	3X12MM	200	67551.030.012	4X16MM	200	67551.040.016
2,2X10MM	200	67551.022.010	3X16MM	200	67551.030.016	4X20MM	200	67551.040.020
			3X20MM	200	67551.030.020	4X40MM	200	67551.040.040
2,5X6MM	200	67551.025.006						
2,5X8MM	200	67551.025.008	3,5X10MM	200	67551.035.010	5X16MM	200	67551.050.016
2,5X10MM	200	67551.025.010	3,5X12MM	200	67551.035.012	5X20MM	200	67551.050.020
2,5X12MM	200	67551.025.012	3,5X16MM	200	67551.035.016	5X25MM	200	67551.050.025
2,5X16MM	200	67551.025.016	3,5X25MM	200	67551.035.025	5X30MM	200	67551.050.030
						5X40MM	200	67551.050.040
3X6MM	200	67551.030.006	4X10MM	200	67551.040.010			
3X8MM	200	67551.030.008	4X12MM	200	67551.040.012	6X20MM	200	67551.060.020

- Warning: electro-galvanizing of these products may cause hydrogen embrittlement.

Raised cheese head thread forming screw with Torx®recess

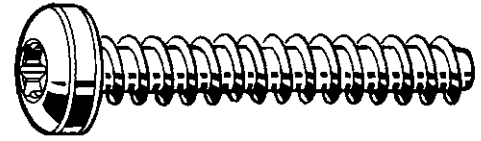
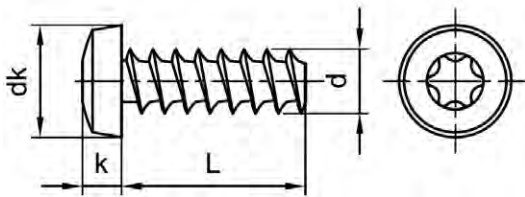

Technical Data

d (nom.)	d _k (max.)	k (max.)	No. Torx®
3.0	5.3	2.0	T10
4.0	7.0	2.7	T20

67552 REMFORM® Raised cheese head thread forming screw with Torx®recess

J05A

Thread REMFORM®
Material Steel
Surface treatment Zinc plated



d (nom.) x L	☒	Art.number	d (nom.) x L	☒	Art.number	d (nom.) x L	☒	Art.number
3X8MM	200	67552.030.008	4X12MM	200	67552.040.012	4X16MM	200	67552.040.016
3X10MM	200	67552.030.010	4X14MM	200	67552.040.014	4X20MM	200	67552.040.020

- Warning: electro-galvanizing of these products may cause hydrogen embrittlement.

6

Cross recessed mushroom head thread forming screw

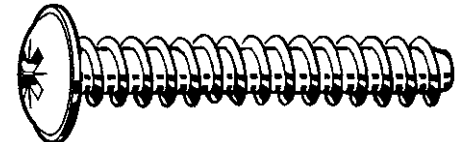
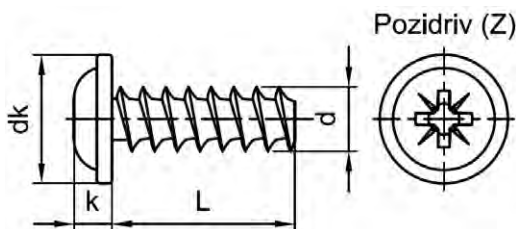

Technical Data

d (nom.)	d _k (max.)	k (max.)	No. cross recess
2.5	5	1.7	1
3.0	6	2	1
3.5	7	2.4	2
4.0	8	2.5	2

67553 REMFORM® Cross recessed mushroom head thread forming screw Pozidriv

J05A

Thread REMFORM®
Material Steel
Surface treatment Zinc plated



d (nom.) x L	☒	Art.number	d (nom.) x L	☒	Art.number	d (nom.) x L	☒	Art.number
2,5X8MM	200	67553.025.008	3,5X12MM	200	67553.035.012	4X10MM	200	67553.040.010
3X8MM	200	67553.030.008	3,5X16MM	200	67553.035.016	4X12MM	200	67553.040.012
3X10MM	200	67553.030.010	3,5X20MM	200	67553.035.020	4X16MM	200	67553.040.016

- Warning: electro-galvanizing of these products may cause hydrogen embrittlement.

Pan head screw for thermo plastics

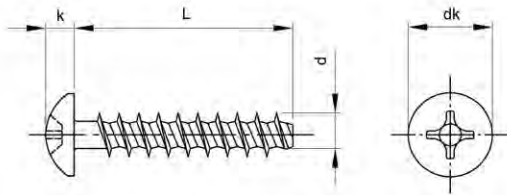

Technical Data

d	d _k	k	No. cross recess
3	5.6	2.2	1
3.5	6.5	2.55	2
4	7.5	2.7	2

51798 Pan head screw for thermo plastics R03A

Thread Material Forming thread for plastics
Stainless steel A2

d x L	☒	Art.number	d x L	☒	Art.number	d x L	☒	Art.number
3,0X8MM*	500	51798.030.008	3,5X8MM*	500	51798.035.008	4,0X8MM*	500	51798.040.008
3,0X10MM*	500	51798.030.010	3,5X10MM*	500	51798.035.010	4,0X10MM*	500	51798.040.010
3,0X12MM*	500	51798.030.012	3,5X12MM*	500	51798.035.012	4,0X12MM*	500	51798.040.012
3,0X14MM*	500	51798.030.014	3,5X14MM*	500	51798.035.014	4,0X14MM*	500	51798.040.014
3,0X16MM*	500	51798.030.016	3,5X16MM*	500	51798.035.016	4,0X16MM*	500	51798.040.016
3,0X20MM*	500	51798.030.020	3,5X20MM*	500	51798.035.020	4,0X20MM*	500	51798.040.020
3,0X25MM*	500	51798.030.025	3,5X25MM*	500	51798.035.025	4,0X25MM*	500	51798.040.025

6

Countersunk head screw for thermo plastics



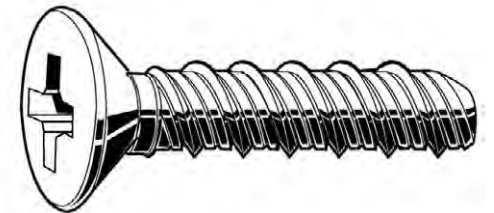
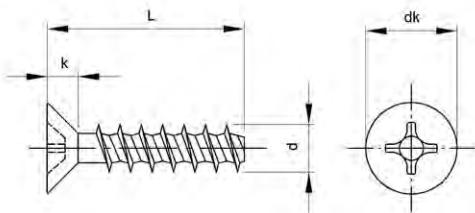

Technical Data

d	d _k	k	No. cross recess
3	5.5	2.2	1
3.5	7.3	2.55	2
4	8.4	2.7	2

51801 Countersunk head screw for thermo plastics R03A

Thread Material Forming thread for plastics
Stainless steel A2

 

d x L	☒	Art.number	d x L	☒	Art.number	d x L	☒	Art.number
3,0X8MM*	500	51801.030.008	3,5X8MM*	500	51801.035.008	4,0X8MM*	500	51801.040.008
3,0X10MM*	500	51801.030.010	3,5X10MM*	500	51801.035.010	4,0X10MM*	500	51801.040.010
3,0X12MM*	500	51801.030.012	3,5X12MM*	500	51801.035.012	4,0X12MM*	500	51801.040.012
3,0X14MM*	500	51801.030.014	3,5X14MM*	500	51801.035.014	4,0X14MM*	500	51801.040.014
3,0X16MM*	500	51801.030.016	3,5X16MM*	500	51801.035.016	4,0X16MM*	500	51801.040.016

Slotted pan head tapping screw

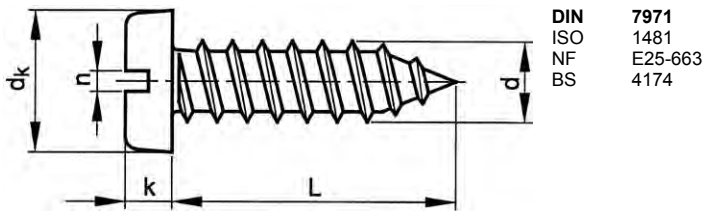

DIN 7971
ISO 1481
NF E25-663
BS 4174

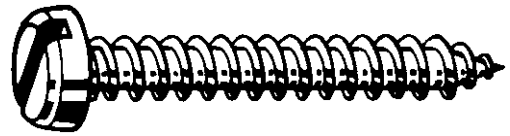

Technical Data

d	dk	k	n	P	d	dk	k	n	P
ST2.2	4.2	1.35	0.6	0.8	ST4.2	8.2	2.45	1.2	1.4
ST2.9	5.6	1.75	0.8	1.1	ST4.8	9.5	2.8	1.2	1.6
ST3.5	6.9	2.1	1	1.3	ST5.5	10.8	3.2	1.6	1.8
ST3.9	7.5	2.25	1	1.4	ST6.3	12.5	3.65	1.6	1.8

Article groups

Thread	Driving features	Material	Surface treatment	Code	Page
ST	Slotted	St	Zipl	26600	6-73
ST	Slotted	St	Ni.pl.	26000	6-73
ST	Slotted	St.St. A2		51600	6-74
ST	Slotted	St	Ni.pl. without point	26100	6-74

26600 Slotted pan head tapping screw

J02A

Thread	Self tapping thread	DIN	7971 C
Material	Steel	ISO	1481 C
Surface treatment	Zinc plated	NF	E25-663 C



d x L	Art.number	d x L	Art.number	d x L	Art.number
ST2,9X6,5MM	200 26600.029.006	ST3,9X22MM	200 26600.039.022	ST4,8X32MM	100 26600.048.032
ST2,9X9,5MM	200 26600.029.009	ST3,9X25MM	200 26600.039.025	ST4,8X38MM	100 26600.048.038
ST2,9X13MM	200 26600.029.013	ST3,9X32MM	200 26600.039.032	ST4,8X45MM	100 26600.048.045
ST2,9X16MM	200 26600.029.016	ST3,9X38MM	200 26600.039.038		
ST2,9X19MM	200 26600.029.019			ST5,5X13MM	200 26600.055.013
ST2,9X22MM	200 26600.029.022	ST4,2X9,5MM	200 26600.042.009	ST5,5X16MM	200 26600.055.016
ST2,9X25MM	200 26600.029.025	ST4,2X13MM	200 26600.042.013	ST5,5X19MM	200 26600.055.019
		ST4,2X16MM	200 26600.042.016	ST5,5X22MM	200 26600.055.022
ST3,5X6,5MM	200 26600.035.006	ST4,2X19MM	200 26600.042.019	ST5,5X25MM	100 26600.055.025
ST3,5X9,5MM	200 26600.035.009	ST4,2X22MM	200 26600.042.022	ST5,5X32MM	100 26600.055.032
ST3,5X13MM	200 26600.035.013	ST4,2X25MM	200 26600.042.025	ST5,5X38MM	100 26600.055.038
ST3,5X16MM	200 26600.035.016	ST4,2X32MM	200 26600.042.032	ST5,5X45MM	100 26600.055.045
ST3,5X19MM	200 26600.035.019	ST4,2X38MM	200 26600.042.038	ST5,5X50MM	100 26600.055.050
ST3,5X22MM	200 26600.035.022	ST4,2X45MM	200 26600.042.045		
ST3,5X25MM	200 26600.035.025	ST4,2X50MM	200 26600.042.050	ST6,3X13MM	100 26600.063.013
ST3,5X32MM	200 26600.035.032			ST6,3X16MM	100 26600.063.016
ST3,5X38MM	200 26600.035.038	ST4,8X9,5MM	200 26600.048.009	ST6,3X19MM	100 26600.063.019
		ST4,8X13MM	200 26600.048.013	ST6,3X25MM	100 26600.063.025
ST3,9X9,5MM	200 26600.039.009	ST4,8X16MM	200 26600.048.016	ST6,3X32MM	100 26600.063.032
ST3,9X13MM	200 26600.039.013	ST4,8X19MM	200 26600.048.019	ST6,3X38MM	100 26600.063.038
ST3,9X16MM	200 26600.039.016	ST4,8X22MM	200 26600.048.022	ST6,3X45MM	100 26600.063.045
ST3,9X19MM	200 26600.039.019	ST4,8X25MM	200 26600.048.025	ST6,3X50MM	100 26600.063.050

• Warning: electro-galvanizing of these products may cause hydrogen embrittlement.

26000 Slotted pan head tapping screw

J03A

Thread	Self tapping thread	DIN	7971 C
Material	Steel	ISO	1481 C
Surface treatment	Nickel plated	NF	E25-663 C



d x L	Art.number	d x L	Art.number	d x L	Art.number
ST2,9X6,5MM	200 26000.029.006	ST3,5X16MM	200 26000.035.016	ST3,9X19MM	200 26000.039.019
ST2,9X9,5MM	200 26000.029.009	ST3,5X19MM	200 26000.035.019	ST3,9X25MM	200 26000.039.025
ST2,9X13MM	200 26000.029.013	ST3,5X25MM	200 26000.035.025	ST3,9X32MM	200 26000.039.032
		ST3,5X32MM	200 26000.035.032	ST3,9X38MM	200 26000.039.038
ST3,5X9,5MM	200 26000.035.009				
ST3,5X13MM	200 26000.035.013	ST3,9X9,5MM	200 26000.039.009	ST4,2X9,5MM	200 26000.042.009

26000 Slotted pan head tapping screw								
d x L	☒	Art.number	d x L	☒	Art.number	d x L	☒	Art.number
ST4,2X13MM	200	26000.042.013	ST4,8X25MM	200	26000.048.025	ST5,5X25MM	100	26000.055.025
ST4,2X16MM	200	26000.042.016	ST4,8X32MM	100	26000.048.032	ST6,3X13MM	100	26000.063.013
ST4,2X19MM	200	26000.042.019	ST4,8X38MM	100	26000.048.038	ST6,3X16MM	100	26000.063.016
ST4,2X25MM	200	26000.042.025	ST4,8X45MM	100	26000.048.045	ST6,3X19MM	100	26000.063.019
ST4,8X9,5MM	200	26000.048.009	ST4,8X50MM	100	26000.048.050	ST6,3X25MM	100	26000.063.025
ST4,8X13MM	200	26000.048.013	ST5,5X13MM	200	26000.055.013	ST6,3X38MM	100	26000.063.038
ST4,8X16MM	200	26000.048.016	ST5,5X16MM	200	26000.055.016			
ST4,8X19MM	200	26000.048.019	ST5,5X19MM	200	26000.055.019			

• Warning: electro-galvanizing of these products may cause hydrogen embrittlement.

51600 Slotted pan head tapping screw					R02A
Thread	Self tapping thread	DIN	7971 C		
Material	Stainless steel A2	ISO	1481 C		
		NF	E25-663 C		

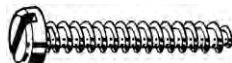

d x L	☒	Art.number	d x L	☒	Art.number	d x L	☒	Art.number
ST2,2X6,5MM*	1000	51600.022.006	ST3,9X13MM	200	51600.039.013	ST4,8X38MM	200	51600.048.038
ST2,2X9,5MM*	1000	51600.022.009	ST3,9X16MM	200	51600.039.016	ST4,8X45MM	200	51600.048.045
ST2,2X13MM*	1000	51600.022.013	ST3,9X19MM	200	51600.039.019	ST4,8X50MM	200	51600.048.050
ST2,2X16MM*	1000	51600.022.016	ST3,9X22MM	200	51600.039.022	ST4,8X60MM	200	51600.048.060
ST2,2X22MM*	1000	51600.022.022	ST3,9X25MM	200	51600.039.025	ST4,8X70MM	200	51600.048.070
ST2,2X25MM*	1000	51600.022.025	ST3,9X32MM	200	51600.039.032			
ST2,2X4,5MM*	1000	51600.022.045	ST3,9X38MM	200	51600.039.038	ST5,5X13MM	200	51600.055.013
ST2,9X6,5MM	200	51600.029.006	ST4,2X6,5MM*	1000	51600.042.006	ST5,5X16MM	200	51600.055.016
ST2,9X9,5MM	200	51600.029.009	ST4,2X9,5MM	200	51600.042.009	ST5,5X19MM	200	51600.055.019
ST2,9X13MM	200	51600.029.013	ST4,2X13MM	200	51600.042.013	ST5,5X22MM	200	51600.055.022
ST2,9X16MM	200	51600.029.016	ST4,2X16MM	200	51600.042.016	ST5,5X25MM	200	51600.055.025
ST2,9X19MM	200	51600.029.019	ST4,2X19MM	200	51600.042.019	ST5,5X32MM	100	51600.055.032
ST2,9X22MM	200	51600.029.022	ST4,2X22MM*	1000	51600.042.022	ST5,5X38MM	100	51600.055.038
ST2,9X25MM	200	51600.029.025	ST4,2X25MM	200	51600.042.025	ST5,5X45MM	100	51600.055.045
ST3,5X6,5MM	200	51600.035.006	ST4,2X32MM	200	51600.042.032	ST5,5X50MM	100	51600.055.050
ST3,5X9,5MM	200	51600.035.009	ST4,2X38MM	200	51600.042.038	ST5,5X70MM*	200	51600.055.070
ST3,5X13MM	200	51600.035.013	ST4,2X45MM	200	51600.042.045	ST6,3X13MM	100	51600.063.013
ST3,5X16MM	200	51600.035.016	ST4,2X50MM	200	51600.042.050	ST6,3X16MM	100	51600.063.016
ST3,5X19MM	200	51600.035.019	ST4,2X60MM*	200	51600.042.060	ST6,3X19MM	100	51600.063.019
ST3,5X22MM	200	51600.035.022	ST4,8X9,5MM	200	51600.048.009	ST6,3X22MM	100	51600.063.022
ST3,5X25MM	200	51600.035.025	ST4,8X13MM	200	51600.048.013	ST6,3X25MM	100	51600.063.025
ST3,5X32MM	200	51600.035.032	ST4,8X16MM	200	51600.048.016	ST6,3X32MM	100	51600.063.032
ST3,5X38MM	200	51600.035.038	ST4,8X19MM	200	51600.048.019	ST6,3X38MM	100	51600.063.038
ST3,9X6,5MM	200	51600.039.006	ST4,8X22MM	200	51600.048.022	ST6,3X45MM	100	51600.063.045
ST3,9X9,5MM	200	51600.039.009	ST4,8X25MM	200	51600.048.025	ST6,3X50MM	100	51600.063.050
			ST4,8X32MM	200	51600.048.032	ST6,3X60MM*	200	51600.063.060
						ST6,3X70MM*	200	51600.063.070

26100 Slotted pan head tapping screw without point					J03A
Thread	Self tapping thread	DIN	7971 F		
Material	Steel	ISO	1481 F		
Surface treatment	Nickel plated	NF	E25-663 F		



d x L	☒	Art.number	d x L	☒	Art.number	d x L	☒	Art.number
ST2,2X4,5MM	500	26100.022.004	ST2,2X8MM	500	26100.022.008	ST2,9X6,5MM	500	26100.029.006
ST2,2X6,5MM	500	26100.022.006	ST2,2X9,5MM	500	26100.022.009			

• Warning: electro-galvanizing of these products may cause hydrogen embrittlement.

Slotted countersunk head tapping screw

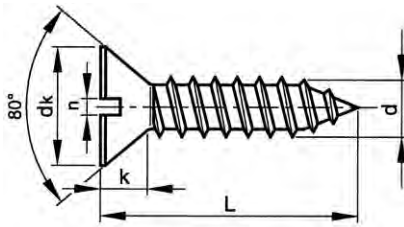

DIN 7972 C
ISO 1482 C
NF E25-660 C
BS 4174

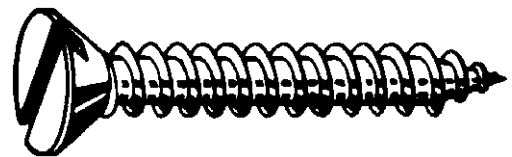

Technical Data

d	d _k	k ≈	n	P	d	d _k	k ≈	n	P
ST2.2	4.3	1.3	0.6	0.8	ST4.2	8.1	2.5	1.2	1.4
ST2.9	5.5	1.7	0.8	1.1	ST4.8	9.5	3	1.2	1.6
ST3.5	6.8	2.1	1	1.3	ST5.5	10.8	3.4	1.6	1.8
ST3.9	7.5	2.3	1	1.4	ST6.3	12.4	3.8	1.6	1.8

Article groups

Thread	Driving features	Material	Surface treatment	Code	Page
ST	Slotted	St	Zipl	26620	6-75
ST	Slotted	St.St. A2		51620	6-75

26620 Slotted countersunk head tapping screw

J02A

Thread Self tapping thread
Material Steel
Surface treatment Zinc plated



d x L	Art.number	d x L	Art.number	d x L	Art.number
ST2,9X6,5MM	200 26620.029.006	ST3,9X22MM	200 26620.039.022	ST4,8X32MM	100 26620.048.032
ST2,9X9,5MM	200 26620.029.009	ST3,9X25MM	200 26620.039.025	ST4,8X38MM	100 26620.048.038
ST2,9X13MM	200 26620.029.013	ST3,9X32MM	200 26620.039.032	ST4,8X45MM	100 26620.048.045
ST2,9X16MM	200 26620.029.016	ST3,9X38MM	200 26620.039.038	ST4,8X50MM	100 26620.048.050
ST2,9X19MM	200 26620.029.019				
ST2,9X25MM	200 26620.029.025	ST4,2X9,5MM	200 26620.042.009	ST5,5X13MM	200 26620.055.013
		ST4,2X13MM	200 26620.042.013	ST5,5X16MM	200 26620.055.016
ST3,5X9,5MM	200 26620.035.009	ST4,2X16MM	200 26620.042.016	ST5,5X19MM	200 26620.055.019
ST3,5X13MM	200 26620.035.013	ST4,2X19MM	200 26620.042.019	ST5,5X25MM	100 26620.055.025
ST3,5X16MM	200 26620.035.016	ST4,2X22MM	200 26620.042.022	ST5,5X32MM	100 26620.055.032
ST3,5X19MM	200 26620.035.019	ST4,2X25MM	200 26620.042.025	ST5,5X38MM	100 26620.055.038
ST3,5X22MM	200 26620.035.022	ST4,2X32MM	200 26620.042.032	ST5,5X45MM	100 26620.055.045
ST3,5X25MM	200 26620.035.025	ST4,2X38MM	200 26620.042.038	ST5,5X50MM	100 26620.055.050
ST3,5X32MM	200 26620.035.032	ST4,2X45MM	200 26620.042.045		
				ST6,3X25MM	100 26620.063.025
ST3,9X9,5MM	200 26620.039.009	ST4,8X13MM	200 26620.048.013	ST6,3X32MM	100 26620.063.032
ST3,9X13MM	200 26620.039.013	ST4,8X16MM	200 26620.048.016	ST6,3X38MM	100 26620.063.038
ST3,9X16MM	200 26620.039.016	ST4,8X19MM	200 26620.048.019	ST6,3X45MM	100 26620.063.045
ST3,9X19MM	200 26620.039.019	ST4,8X25MM	200 26620.048.025	ST6,3X50MM	100 26620.063.050

Warning: electro-galvanizing of these products may cause hydrogen embrittlement.

51620 Slotted countersunk head tapping screw

R02A

Thread Self tapping thread
Material Stainless steel A2



d x L	Art.number	d x L	Art.number	d x L	Art.number
ST2,2X6,5MM*	1000 51620.022.006	ST2,9X25MM	200 51620.029.025	ST3,9X9,5MM	200 51620.039.009
ST2,2X9,5MM*	1000 51620.022.009			ST3,9X13MM	200 51620.039.013
ST2,2X13MM*	1000 51620.022.013	ST3,5X6,5MM	200 51620.035.006	ST3,9X16MM	200 51620.039.016
ST2,2X16MM*	1000 51620.022.016	ST3,5X9,5MM	200 51620.035.009	ST3,9X19MM	200 51620.039.019
		ST3,5X13MM	200 51620.035.013	ST3,9X22MM	200 51620.039.022
ST2,9X6,5MM	200 51620.029.006	ST3,5X16MM	200 51620.035.016	ST3,9X25MM	200 51620.039.025
ST2,9X9,5MM	200 51620.029.009	ST3,5X19MM	200 51620.035.019	ST3,9X32MM	200 51620.039.032
ST2,9X13MM	200 51620.029.013	ST3,5X22MM	200 51620.035.022	ST3,9X38MM	200 51620.039.038
ST2,9X16MM	200 51620.029.016	ST3,5X25MM	200 51620.035.025		
ST2,9X19MM	200 51620.029.019	ST3,5X32MM	200 51620.035.032		
ST2,9X22MM*	1000 51620.029.022	ST3,5X38MM	200 51620.035.038	ST4,2X9,5MM*	1000 51620.042.009

51620 Slotted countersunk head tapping screw								
d x L	☒	Art.number	d x L	☒	Art.number	d x L	☒	Art.number
ST4,2X13MM	200	51620.042.013	ST4,8X32MM	200	51620.048.032	ST5,5X60MM*	200	51620.055.060
ST4,2X16MM	200	51620.042.016	ST4,8X38MM	200	51620.048.038	ST5,5X70MM*	200	51620.055.070
ST4,2X19MM	200	51620.042.019	ST4,8X45MM	200	51620.048.045			
ST4,2X22MM	200	51620.042.022	ST4,8X50MM	200	51620.048.050	ST6,3X13MM	100	51620.063.013
ST4,2X25MM	200	51620.042.025	ST4,8X70MM*	200	51620.048.070	ST6,3X16MM	100	51620.063.016
ST4,2X32MM	200	51620.042.032	ST4,8X80MM*	200	51620.048.080	ST6,3X19MM	100	51620.063.019
ST4,2X38MM	200	51620.042.038				ST6,3X22MM	100	51620.063.022
ST4,2X45MM	200	51620.042.045	ST5,5X13MM	200	51620.055.013	ST6,3X25MM	100	51620.063.025
ST4,2X50MM*	200	51620.042.050	ST5,5X16MM	200	51620.055.016	ST6,3X32MM	100	51620.063.032
			ST5,5X19MM	200	51620.055.019	ST6,3X38MM	100	51620.063.038
ST4,8X9,5MM	200	51620.048.009	ST5,5X22MM	200	51620.055.022	ST6,3X45MM	100	51620.063.045
ST4,8X13MM	200	51620.048.013	ST5,5X25MM	200	51620.055.025	ST6,3X50MM	100	51620.063.050
ST4,8X16MM	200	51620.048.016	ST5,5X32MM	100	51620.055.032	ST6,3X70MM*	200	51620.063.070
ST4,8X19MM	200	51620.048.019	ST5,5X38MM	100	51620.055.038	ST6,3X80MM*	200	51620.063.080
ST4,8X22MM	200	51620.048.022	ST5,5X45MM	100	51620.055.045			
ST4,8X25MM	200	51620.048.025	ST5,5X50MM	100	51620.055.050			

Slotted raised countersunk head tapping screw

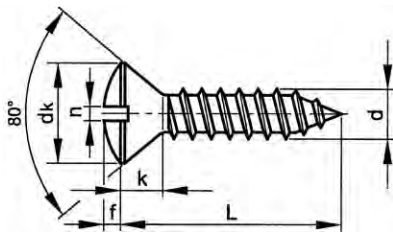

DIN 7973 C
 ISO 1483 C
 NF E25-661 C
 BS 4174

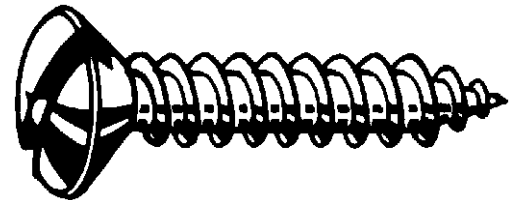

Technical Data

d	dk	f ≈	k ≈	n	P
ST2.2	4.2	0.7	1.3	0.6	0.8
ST2.9	5.5	0.9	1.7	0.8	1.5
ST3.5	6.8	1.2	2.1	1	1.3
ST3.9	7.5	1.3	2.3	1	1.4
ST4.2	8.1	1.4	2.5	1.2	1.4
ST4.8	9.5	1.5	3	1.2	1.6
ST5.5	10.8	1.7	3.4	1.6	1.8
ST6.3	12.4	2	3.8	1.6	1.8

Article groups

Thread	Driving features	Material	Surface treatment	Code	Page
ST	Slotted	St	Zipl	26640	6-76
ST	Slotted	St	Ni.pl.	26040	6-77
ST	Slotted	St.St. A2		51640	6-77

26640 Slotted raised countersunk head tapping screw			J02A
Thread	Self tapping thread		
Material	Steel		
Surface treatment	Zinc plated		

d x L	☒	Art.number	d x L	☒	Art.number	d x L	☒	Art.number
ST2,9X9,5MM	200	26640.029.009	ST3,9X25MM	200	26640.039.025	ST4,8X32MM	100	26640.048.032
ST2,9X13MM	200	26640.029.013	ST3,9X32MM	200	26640.039.032	ST4,8X38MM	100	26640.048.038
ST2,9X16MM	200	26640.029.016				ST4,8X45MM	100	26640.048.045
ST2,9X19MM	200	26640.029.019	ST4,2X9,5MM	200	26640.042.009	ST4,8X50MM	100	26640.048.050
ST2,9X25MM	200	26640.029.025	ST4,2X13MM	200	26640.042.013			
			ST4,2X16MM	200	26640.042.016	ST5,5X13MM	200	26640.055.013
ST3,5X9,5MM	200	26640.035.009	ST4,2X19MM	200	26640.042.019	ST5,5X16MM	200	26640.055.016
ST3,5X13MM	200	26640.035.013	ST4,2X25MM	200	26640.042.025	ST5,5X19MM	200	26640.055.019
ST3,5X16MM	200	26640.035.016	ST4,2X32MM	200	26640.042.032	ST5,5X25MM	100	26640.055.025
ST3,5X19MM	200	26640.035.019	ST4,2X38MM	200	26640.042.038	ST5,5X32MM	100	26640.055.032
ST3,5X25MM	200	26640.035.025	ST4,2X45MM	200	26640.042.045	ST5,5X38MM	100	26640.055.038
ST3,5X32MM	200	26640.035.032	ST4,2X50MM	200	26640.042.050	ST5,5X45MM	100	26640.055.045
ST3,5X38MM	200	26640.035.038						
			ST4,8X9,5MM	200	26640.048.009	ST6,3X16MM	100	26640.063.016
ST3,9X9,5MM	200	26640.039.009	ST4,8X13MM	200	26640.048.013	ST6,3X19MM	100	26640.063.019
ST3,9X13MM	200	26640.039.013	ST4,8X16MM	200	26640.048.016	ST6,3X25MM	100	26640.063.025
ST3,9X16MM	200	26640.039.016	ST4,8X19MM	200	26640.048.019	ST6,3X32MM	100	26640.063.032
ST3,9X19MM	200	26640.039.019	ST4,8X25MM	200	26640.048.025	ST6,3X38MM	100	26640.063.038

26640 Slotted raised countersunk head tapping screw

d x L	Art.number	d x L	Art.number
ST6,3X45MM	100 26640.063.045	ST6,3X50MM	100 26640.063.050

• Warning: electro-galvanizing of these products may cause hydrogen embrittlement.

26040 Slotted raised countersunk head tapping screw
J03A

Thread Self tapping thread
Material Steel
Surface treatment Nickel plated



d x L	Art.number	d x L	Art.number	d x L	Art.number
ST2,9X13MM	200 26040.029.013	ST3,9X25MM	200 26040.039.025	ST4,8X25MM	200 26040.048.025
ST2,9X19MM	200 26040.029.019	ST3,9X32MM	200 26040.039.032	ST5,5X13MM	200 26040.055.013
ST3,5X13MM	200 26040.035.013	ST3,9X38MM	200 26040.039.038	ST5,5X16MM	200 26040.055.016
ST3,5X16MM	200 26040.035.016	ST4,2X16MM	200 26040.042.016	ST5,5X19MM	200 26040.055.019
ST3,5X19MM	200 26040.035.019	ST4,2X19MM	200 26040.042.019	ST5,5X25MM	100 26040.055.025
ST3,5X25MM	200 26040.035.025	ST4,2X25MM	200 26040.042.025	ST5,5X32MM	100 26040.055.032
ST3,9X9,5MM	200 26040.039.009	ST4,2X38MM	200 26040.042.038	ST5,5X50MM	100 26040.055.050
ST3,9X13MM	200 26040.039.013	ST4,8X13MM	200 26040.048.013	ST6,3X25MM	100 26040.063.025
ST3,9X16MM	200 26040.039.016	ST4,8X16MM	200 26040.048.016	ST6,3X32MM	100 26040.063.032
ST3,9X19MM	200 26040.039.019	ST4,8X19MM	200 26040.048.019	ST6,3X38MM	100 26040.063.038

• Warning: electro-galvanizing of these products may cause hydrogen embrittlement.

6

51640 Slotted raised countersunk head tapping screw
R02A

Thread Self tapping thread
Material Stainless steel A2



d x L	Art.number	d x L	Art.number	d x L	Art.number
ST2,2X9,5MM*	1000 51640.022.009	ST3,9X22MM	200 51640.039.022	ST4,8X45MM	200 51640.048.045
ST2,2X13MM*	1000 51640.022.013	ST3,9X25MM	200 51640.039.025	ST4,8X50MM	200 51640.048.050
ST2,9X6,5MM	200 51640.029.006	ST3,9X32MM	200 51640.039.032	ST4,8X60MM*	200 51640.048.060
ST2,9X9,5MM	200 51640.029.009	ST3,9X38MM	200 51640.039.038	ST4,8X70MM*	200 51640.048.070
ST2,9X13MM	200 51640.029.013	ST4,2X9,5MM	200 51640.042.009	ST5,5X13MM	200 51640.055.013
ST2,9X16MM	200 51640.029.016	ST4,2X13MM	200 51640.042.013	ST5,5X16MM*	1000 51640.055.016
ST2,9X19MM	200 51640.029.019	ST4,2X16MM	200 51640.042.016	ST5,5X19MM	200 51640.055.019
ST2,9X22MM	200 51640.029.022	ST4,2X19MM	200 51640.042.019	ST5,5X22MM	200 51640.055.022
ST2,9X25MM	200 51640.029.025	ST4,2X22MM	200 51640.042.022	ST5,5X25MM	200 51640.055.025
ST3,5X6,5MM	200 51640.035.006	ST4,2X25MM	200 51640.042.025	ST5,5X32MM	100 51640.055.032
ST3,5X9,5MM	200 51640.035.009	ST4,2X32MM	200 51640.042.032	ST5,5X38MM	100 51640.055.038
ST3,5X13MM	200 51640.035.013	ST4,2X38MM	200 51640.042.038	ST5,5X45MM	100 51640.055.045
ST3,5X16MM	200 51640.035.016	ST4,2X45MM	200 51640.042.045	ST5,5X50MM	100 51640.055.050
ST3,5X19MM	200 51640.035.019	ST4,2X50MM	200 51640.042.050	ST6,3X13MM	100 51640.063.013
ST3,5X22MM	200 51640.035.022	ST4,8X9,5MM	200 51640.048.009	ST6,3X16MM	100 51640.063.016
ST3,5X25MM	200 51640.035.025	ST4,8X13MM	200 51640.048.013	ST6,3X19MM	100 51640.063.019
ST3,5X32MM	200 51640.035.032	ST4,8X16MM	200 51640.048.016	ST6,3X22MM*	500 51640.063.022
ST3,5X38MM	200 51640.035.038	ST4,8X19MM	200 51640.048.019	ST6,3X25MM	100 51640.063.025
ST3,9X9,5MM	200 51640.039.009	ST4,8X22MM	200 51640.048.022	ST6,3X32MM	100 51640.063.032
ST3,9X13MM	200 51640.039.013	ST4,8X25MM	200 51640.048.025	ST6,3X38MM	100 51640.063.038
ST3,9X16MM	200 51640.039.016	ST4,8X32MM	200 51640.048.032	ST6,3X45MM	100 51640.063.045
ST3,9X19MM	200 51640.039.019	ST4,8X38MM	200 51640.048.038	ST6,3X50MM	100 51640.063.050

Cross recessed pan head tapping screw

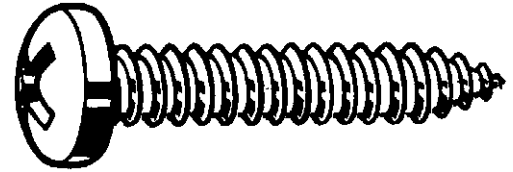
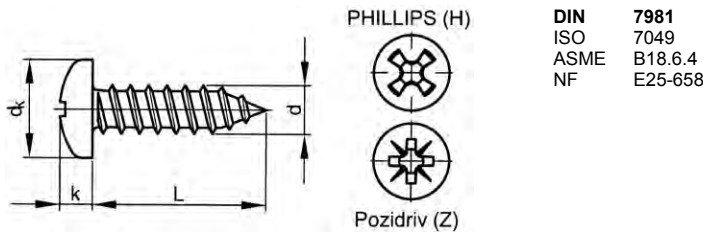

Technical Data

d	d _k	k	No. cross recess	P
ST2.2	4.2	1.8	1	0.8
ST2.9	5.6	2.2	1	1.1
ST3.5	6.9	2.6	2	1.3
ST3.9	7.5	2.8	2	1.4
ST4.2	8.2	3.05	2	1.4
ST4.8	9.5	3.55	2	1.6
ST5.5	10.8	3.95	3	1.8
ST6.3	12.5	4.55	3	1.8

Article groups

Thread	Driving features	Material	Surface treatment	Code	Page
ST	Phillips	St	Zipl	26660	6-78
ST	Phillips	St	Zipl	26670	6-79
ST	Pozidriv	St	Zipl	26760	6-79
ST	Phillips	St	Ni.pl.	26200	6-79
ST	Phillips	St	Ni.pl.	26210	6-80
ST	Phillips	St	Zipl blk p.	26400	6-80
ST	Pozidriv	St	Zipl blk p.	26402	6-80
ST	Phillips	St.St. A2		51660	6-81
ST	Phillips	St.St. A2		51670	6-81
ST	Pozidriv	St.St. A2		51661	6-82
ST	Pozidriv	St.St. A4		55661	6-82
ST	Phillips	St.St. A4		55660	6-83
ST	Phillips	St	Ni.pl. without point	26300	6-83

6

26660 Cross recessed pan head tapping screw Phillips

J01B

Thread	Self tapping thread	DIN	7981 C-H
Material	Steel	ISO	7049 C-H
Surface treatment	Zinc plated		



d x L	Art.number	d x L	Art.number	d x L	Art.number
ST2,2X6,5MM	200 26660.022.006	ST3,9X19MM	200 26660.039.019	ST4,8X45MM	100 26660.048.045
ST2,2X9,5MM	200 26660.022.009	ST3,9X22MM	200 26660.039.022	ST4,8X50MM	100 26660.048.050
ST2,2X16MM	200 26660.022.016	ST3,9X25MM	200 26660.039.025	ST4,8X70MM	100 26660.048.070
ST2,9X6,5MM	200 26660.029.006	ST3,9X32MM	200 26660.039.032	ST5,5X13MM	200 26660.055.013
ST2,9X9,5MM	200 26660.029.009	ST3,9X38MM	200 26660.039.038	ST5,5X16MM	200 26660.055.016
ST2,9X13MM	200 26660.029.013	ST4,2X9,5MM	200 26660.042.009	ST5,5X19MM	200 26660.055.019
ST2,9X16MM	200 26660.029.016	ST4,2X13MM	200 26660.042.013	ST5,5X22MM	100 26660.055.022
ST2,9X19MM	200 26660.029.019	ST4,2X16MM	200 26660.042.016	ST5,5X25MM	100 26660.055.025
ST2,9X22MM	200 26660.029.022	ST4,2X19MM	200 26660.042.019	ST5,5X32MM	100 26660.055.032
ST2,9X25MM	200 26660.029.025	ST4,2X22MM	200 26660.042.022	ST5,5X38MM	100 26660.055.038
ST3,5X6,5MM	200 26660.035.006	ST4,2X25MM	200 26660.042.025	ST5,5X45MM	100 26660.055.045
ST3,5X9,5MM	200 26660.035.009	ST4,2X32MM	200 26660.042.032	ST5,5X50MM	100 26660.055.050
ST3,5X13MM	200 26660.035.013	ST4,2X38MM	200 26660.042.038	ST6,3X13MM	100 26660.063.013
ST3,5X16MM	200 26660.035.016	ST4,2X45MM	200 26660.042.045	ST6,3X16MM	100 26660.063.016
ST3,5X19MM	200 26660.035.019	ST4,2X50MM	200 26660.042.050	ST6,3X19MM	100 26660.063.019
ST3,5X22MM	200 26660.035.022	ST4,2X60MM	200 26660.042.060	ST6,3X22MM	100 26660.063.022
ST3,5X25MM	200 26660.035.025	ST4,8X9,5MM	200 26660.048.009	ST6,3X25MM	100 26660.063.025
ST3,5X32MM	200 26660.035.032	ST4,8X13MM	200 26660.048.013	ST6,3X32MM	100 26660.063.032
ST3,5X38MM	200 26660.035.038	ST4,8X16MM	200 26660.048.016	ST6,3X38MM	100 26660.063.038
ST3,9X6,5MM	200 26660.039.006	ST4,8X19MM	200 26660.048.019	ST6,3X45MM	100 26660.063.045
ST3,9X9,5MM	200 26660.039.009	ST4,8X22MM	200 26660.048.022	ST6,3X50MM	100 26660.063.050
ST3,9X13MM	200 26660.039.013	ST4,8X25MM	200 26660.048.025	ST6,3X60MM	100 26660.063.060
ST3,9X16MM	200 26660.039.016	ST4,8X32MM	100 26660.048.032	ST6,3X70MM	100 26660.063.070
		ST4,8X38MM	100 26660.048.038		

26660 Cross recessed pan head tapping screw Phillips ←

• Warning: electro-galvanizing of these products may cause hydrogen embrittlement.

26670 Cross recessed pan head tapping screw Phillips J01B

Thread	Self tapping thread	DIN	7981 C-H		
Material	Steel	ISO	7049 C-H		
Surface treatment	Zinc plated				

d x L	☒	Art.number	d x L	☒	Art.number	d x L	☒	Art.number
ST2,9X6,5MM	2000	26670.029.006	ST3,5X22MM	2000	26670.035.022	ST4,2X25MM	1000	26670.042.025
ST2,9X9,5MM	2000	26670.029.009	ST3,5X25MM	2000	26670.035.025	ST4,2X32MM	500	26670.042.032
ST2,9X13MM	2000	26670.029.013				ST4,2X50MM	500	26670.042.050
ST2,9X16MM	2000	26670.029.016	ST3,9X9,5MM	1000	26670.039.009			
ST2,9X19MM	2000	26670.029.019	ST3,9X16MM	1000	26670.039.016	ST4,8X13MM	1000	26670.048.013
						ST4,8X16MM	1000	26670.048.016
ST3,5X6,5MM	2000	26670.035.006	ST4,2X9,5MM	1000	26670.042.009	ST4,8X19MM	1000	26670.048.019
ST3,5X9,5MM	2000	26670.035.009	ST4,2X13MM	1000	26670.042.013	ST4,8X25MM	1000	26670.048.025
ST3,5X13MM	2000	26670.035.013	ST4,2X16MM	1000	26670.042.016	ST4,8X32MM	500	26670.048.032
ST3,5X16MM	2000	26670.035.016	ST4,2X19MM	1000	26670.042.019	ST4,8X38MM	500	26670.048.038
ST3,5X19MM	2000	26670.035.019						

• Warning: electro-galvanizing of these products may cause hydrogen embrittlement.

26760 Cross recessed pan head tapping screw Pozidriv J01A

Thread	Self tapping thread	DIN	7981 C-Z		
Material	Steel	ISO	7049 C-Z		
Surface treatment	Zinc plated	NF	E25-658 C		

d x L	☒	Art.number	d x L	☒	Art.number	d x L	☒	Art.number
ST2,2X6,5MM	200	26760.022.006	ST3,9X19MM	200	26760.039.019	ST4,8X50MM	100	26760.048.050
			ST3,9X25MM	200	26760.039.025			
ST2,9X6,5MM	200	26760.029.006				ST5,5X13MM	200	26760.055.013
ST2,9X9,5MM	200	26760.029.009	ST4,2X9,5MM	200	26760.042.009	ST5,5X16MM	200	26760.055.016
ST2,9X13MM	200	26760.029.013	ST4,2X13MM	200	26760.042.013	ST5,5X19MM	200	26760.055.019
ST2,9X16MM	200	26760.029.016	ST4,2X16MM	200	26760.042.016	ST5,5X25MM	100	26760.055.025
ST2,9X19MM	200	26760.029.019	ST4,2X19MM	200	26760.042.019	ST5,5X32MM	100	26760.055.032
ST2,9X25MM	200	26760.029.025	ST4,2X25MM	200	26760.042.025	ST5,5X38MM	100	26760.055.038
			ST4,2X32MM	200	26760.042.032	ST5,5X45MM	100	26760.055.045
ST3,5X6,5MM	200	26760.035.006	ST4,2X38MM	200	26760.042.038	ST5,5X50MM	100	26760.055.050
ST3,5X9,5MM	200	26760.035.009	ST4,2X45MM	200	26760.042.045			
ST3,5X13MM	200	26760.035.013	ST4,2X50MM	200	26760.042.050	ST6,3X13MM	100	26760.063.013
ST3,5X16MM	200	26760.035.016				ST6,3X16MM	100	26760.063.016
ST3,5X19MM	200	26760.035.019	ST4,8X9,5MM	200	26760.048.009	ST6,3X19MM	100	26760.063.019
ST3,5X25MM	200	26760.035.025	ST4,8X13MM	200	26760.048.013	ST6,3X25MM	100	26760.063.025
ST3,5X32MM	200	26760.035.032	ST4,8X16MM	200	26760.048.016	ST6,3X32MM	100	26760.063.032
ST3,5X38MM	200	26760.035.038	ST4,8X19MM	200	26760.048.019	ST6,3X38MM	100	26760.063.038
			ST4,8X25MM	200	26760.048.025	ST6,3X45MM	100	26760.063.045
ST3,9X9,5MM	200	26760.039.009	ST4,8X32MM	100	26760.048.032	ST6,3X50MM	100	26760.063.050
ST3,9X13MM	200	26760.039.013	ST4,8X38MM	100	26760.048.038			
ST3,9X16MM	200	26760.039.016	ST4,8X45MM	100	26760.048.045			

• Warning: electro-galvanizing of these products may cause hydrogen embrittlement.

26200 Cross recessed pan head tapping screw Phillips J03B

Thread	Self tapping thread	DIN	7981 C-H		
Material	Steel	ISO	7049 C-H		
Surface treatment	Nickel plated				

d x L	☒	Art.number	d x L	☒	Art.number	d x L	☒	Art.number
ST2,9X6,5MM	200	26200.029.006	ST3,5X19MM	200	26200.035.019	ST3,9X25MM	200	26200.039.025
ST2,9X9,5MM	200	26200.029.009	ST3,5X25MM	200	26200.035.025			
ST2,9X13MM	200	26200.029.013	ST3,5X32MM	200	26200.035.032	ST4,2X9,5MM	200	26200.042.009
ST2,9X16MM	200	26200.029.016	ST3,5X38MM	200	26200.035.038	ST4,2X13MM	200	26200.042.013
ST2,9X19MM	200	26200.029.019				ST4,2X16MM	200	26200.042.016
			ST3,9X9,5MM	200	26200.039.009	ST4,2X19MM	200	26200.042.019
ST3,5X6,5MM	200	26200.035.006	ST3,9X13MM	200	26200.039.013	ST4,2X25MM	200	26200.042.025
ST3,5X9,5MM	200	26200.035.009	ST3,9X16MM	200	26200.039.016	ST4,2X32MM	200	26200.042.032
ST3,5X13MM	200	26200.035.013	ST3,9X19MM	200	26200.039.019	ST4,2X38MM	200	26200.042.038
ST3,5X16MM	200	26200.035.016						

26200 Cross recessed pan head tapping screw Phillips								
d x L	☒	Art.number	d x L	☒	Art.number	d x L	☒	Art.number
ST4,8X13MM	200	26200.048.013	ST5,5X13MM	200	26200.055.013	ST6,3X13MM	100	26200.063.013
ST4,8X16MM	200	26200.048.016	ST5,5X16MM	200	26200.055.016	ST6,3X16MM	100	26200.063.016
ST4,8X19MM	200	26200.048.019	ST5,5X19MM	200	26200.055.019	ST6,3X19MM	100	26200.063.019
ST4,8X25MM	200	26200.048.025	ST5,5X25MM	100	26200.055.025	ST6,3X25MM	100	26200.063.025
ST4,8X32MM	100	26200.048.032	ST5,5X32MM	100	26200.055.032	ST6,3X32MM	100	26200.063.032
ST4,8X38MM	100	26200.048.038	ST5,5X38MM	100	26200.055.038	ST6,3X38MM	100	26200.063.038

• Warning: electro-galvanizing of these products may cause hydrogen embrittlement.

26210 Cross recessed pan head tapping screw Phillips				J03B
Thread	Self tapping thread	DIN	7981 C-H	
Material	Steel	ISO	7049 C-H	
Surface treatment	Nickel plated			



d x L	☒	Art.number	d x L	☒	Art.number	d x L	☒	Art.number
ST3,5X6,5MM	2000	26210.035.006	ST4,2X9,5MM	1000	26210.042.009	ST4,2X45MM	500	26210.042.045
ST3,5X9,5MM	2000	26210.035.009	ST4,2X13MM	1000	26210.042.013	ST4,8X13MM	1000	26210.048.013
ST3,5X13MM	2000	26210.035.013	ST4,2X16MM	1000	26210.042.016	ST4,8X16MM	1000	26210.048.016
ST3,5X16MM	2000	26210.035.016	ST4,2X19MM	1000	26210.042.019			
ST3,5X19MM	2000	26210.035.019						

• Warning: electro-galvanizing of these products may cause hydrogen embrittlement.

6

26400 Cross recessed pan head tapping screw Phillips				J03B
Thread	Self tapping thread	DIN	7981 C-H	
Material	Steel	ISO	7049 C-H	
Surface treatment	Zinc plated black passivated			

d x L	☒	Art.number	d x L	☒	Art.number	d x L	☒	Art.number
ST2,9X6,5MM	200	26400.029.006	ST3,9X9,5MM	200	26400.039.009	ST4,8X16MM	200	26400.048.016
ST2,9X9,5MM	200	26400.029.009	ST3,9X13MM	200	26400.039.013	ST4,8X19MM	200	26400.048.019
ST2,9X13MM	200	26400.029.013	ST3,9X16MM	200	26400.039.016	ST4,8X25MM	200	26400.048.025
ST2,9X16MM	200	26400.029.016	ST3,9X19MM	200	26400.039.019	ST4,8X32MM	100	26400.048.032
ST2,9X19MM	200	26400.029.019	ST3,9X25MM	200	26400.039.025	ST4,8X38MM	100	26400.048.038
ST2,9X25MM	200	26400.029.025				ST4,8X50MM	100	26400.048.050
			ST4,2X9,5MM	200	26400.042.009	ST5,5X13MM	200	26400.055.013
ST3,5X6,5MM	200	26400.035.006	ST4,2X13MM	200	26400.042.013	ST5,5X16MM	200	26400.055.016
ST3,5X9,5MM	200	26400.035.009	ST4,2X16MM	200	26400.042.016	ST5,5X19MM	200	26400.055.019
ST3,5X13MM	200	26400.035.013	ST4,2X19MM	200	26400.042.019	ST5,5X25MM	100	26400.055.025
ST3,5X16MM	200	26400.035.016	ST4,2X25MM	200	26400.042.025	ST5,5X32MM	100	26400.055.032
ST3,5X19MM	200	26400.035.019	ST4,2X32MM	200	26400.042.032	ST5,5X38MM	100	26400.055.038
ST3,5X25MM	200	26400.035.025	ST4,2X38MM	200	26400.042.038	ST5,5X45MM	100	26400.055.045
ST3,5X32MM	200	26400.035.032	ST4,2X50MM	200	26400.042.050	ST5,5X50MM	100	26400.055.050
ST3,5X38MM	200	26400.035.038						
			ST4,8X13MM	200	26400.048.013			

• Warning: electro-galvanizing of these products may cause hydrogen embrittlement.

26402 Cross recessed pan head tapping screw Pozidriv				J03B
Thread	Self tapping thread	DIN	7981 C-Z	
Material	Steel	ISO	7049 C-Z	
Surface treatment	Zinc plated black passivated	NF	E25-658 C	

d x L	☒	Art.number	d x L	☒	Art.number	d x L	☒	Art.number
ST2,9X6,5MM	200	26402.029.006	ST3,5X25MM	200	26402.035.025	ST4,2X32MM	200	26402.042.032
ST2,9X9,5MM	200	26402.029.009				ST4,2X38MM	200	26402.042.038
ST2,9X13MM	200	26402.029.013	ST3,9X13MM	200	26402.039.013	ST4,2X50MM	200	26402.042.050
ST2,9X16MM	200	26402.029.016	ST3,9X16MM	200	26402.039.016			
ST2,9X19MM	200	26402.029.019	ST3,9X19MM	200	26402.039.019	ST4,8X13MM	200	26402.048.013
ST2,9X25MM	200	26402.029.025	ST3,9X25MM	200	26402.039.025	ST4,8X16MM	200	26402.048.016
						ST4,8X19MM	200	26402.048.019
ST3,5X6,5MM	200	26402.035.006	ST4,2X9,5MM	200	26402.042.009	ST4,8X25MM	200	26402.048.025
ST3,5X9,5MM	200	26402.035.009	ST4,2X13MM	200	26402.042.013	ST4,8X32MM	100	26402.048.032
ST3,5X13MM	200	26402.035.013	ST4,2X16MM	200	26402.042.016	ST4,8X38MM	100	26402.048.038
ST3,5X16MM	200	26402.035.016	ST4,2X19MM	200	26402.042.019	ST4,8X50MM	100	26402.048.050
ST3,5X19MM	200	26402.035.019	ST4,2X25MM	200	26402.042.025			

26402 Cross recessed pan head tapping screw Pozidriv								
d x L	☒	Art.number	d x L	☒	Art.number	d x L	☒	Art.number
ST5,5X13MM	200	26402.055.013	ST5,5X19MM	200	26402.055.019			
ST5,5X16MM	200	26402.055.016	ST5,5X25MM	100	26402.055.025	ST6,3X19MM	100	26402.063.019

• Warning: electro-galvanizing of these products may cause hydrogen embrittlement.



51660 Cross recessed pan head tapping screw Phillips					R01A
Thread	Self tapping thread	DIN	7981 C-H		
Material	Stainless steel A2	ISO	7049 C-H		

d x L	☒	Art.number	d x L	☒	Art.number	d x L	☒	Art.number
ST2,2X4,5MM	1000	51660.022.004	ST3,9X25MM	200	51660.039.025	ST4,8X90MM	200	51660.048.090
ST2,2X6,5MM*	1000	51660.022.006	ST3,9X28MM*	1000	51660.039.028	ST4,8X100MM	100	51660.048.100
ST2,2X9,5MM	1000	51660.022.009	ST3,9X32MM	200	51660.039.032	ST4,8X120MM*	200	51660.048.120
ST2,2X13MM*	1000	51660.022.013	ST3,9X38MM	200	51660.039.038			
ST2,2X16MM*	1000	51660.022.016	ST3,9X45MM*	500	51660.039.045	ST5,5X13MM	200	51660.055.013
ST2,2X19MM*	1000	51660.022.019	ST3,9X50MM*	500	51660.039.050	ST5,5X16MM	200	51660.055.016
ST2,2X22MM*	1000	51660.022.022	ST3,9X60MM*	500	51660.039.060	ST5,5X19MM	200	51660.055.019
ST2,2X25MM*	1000	51660.022.025	ST3,9X70MM*	500	51660.039.070	ST5,5X22MM	200	51660.055.022
						ST5,5X25MM	200	51660.055.025
ST2,9X6,5MM	200	51660.029.006	ST4,2X6,5MM	200	51660.042.006	ST5,5X32MM	100	51660.055.032
ST2,9X9,5MM	200	51660.029.009	ST4,2X9,5MM	200	51660.042.009	ST5,5X38MM	100	51660.055.038
ST2,9X13MM	200	51660.029.013	ST4,2X13MM	200	51660.042.013	ST5,5X42MM*	500	51660.055.042
ST2,9X16MM	200	51660.029.016	ST4,2X16MM	200	51660.042.016	ST5,5X45MM	100	51660.055.045
ST2,9X19MM	200	51660.029.019	ST4,2X19MM	200	51660.042.019	ST5,5X50MM	100	51660.055.050
ST2,9X22MM	200	51660.029.022	ST4,2X22MM	200	51660.042.022	ST5,5X55MM*	200	51660.055.055
ST2,9X25MM	200	51660.029.025	ST4,2X25MM	200	51660.042.025	ST5,5X60MM	200	51660.055.060
ST2,9X32MM*	1000	51660.029.032	ST4,2X32MM	200	51660.042.032	ST5,5X70MM*	200	51660.055.070
ST2,9X38MM	500	51660.029.038	ST4,2X38MM	200	51660.042.038	ST5,5X80MM*	200	51660.055.080
			ST4,2X45MM	200	51660.042.045	ST5,5X90MM*	200	51660.055.090
ST3,5X6,5MM	200	51660.035.006	ST4,2X50MM	200	51660.042.050	ST5,5X100MM*	200	51660.055.100
ST3,5X9,5MM	200	51660.035.009	ST4,2X60MM	200	51660.042.060	ST5,5X120MM*	200	51660.055.120
ST3,5X13MM	200	51660.035.013	ST4,2X70MM*	200	51660.042.070			
ST3,5X16MM	200	51660.035.016	ST4,2X80MM*	200	51660.042.080	ST6,3X13MM	100	51660.063.013
ST3,5X19MM	200	51660.035.019				ST6,3X16MM	100	51660.063.016
ST3,5X22MM	200	51660.035.022	ST4,8X9,5MM	200	51660.048.009	ST6,3X19MM	100	51660.063.019
ST3,5X25MM	200	51660.035.025	ST4,8X13MM	200	51660.048.013	ST6,3X22MM	100	51660.063.022
ST3,5X32MM	200	51660.035.032	ST4,8X16MM	200	51660.048.016	ST6,3X25MM	100	51660.063.025
ST3,5X38MM	200	51660.035.038	ST4,8X19MM	200	51660.048.019	ST6,3X32MM	100	51660.063.032
ST3,5X45MM*	500	51660.035.045	ST4,8X22MM	200	51660.048.022	ST6,3X38MM	100	51660.063.038
ST3,5X50MM*	500	51660.035.050	ST4,8X25MM	200	51660.048.025	ST6,3X45MM	100	51660.063.045
ST3,5X60MM*	500	51660.035.060	ST4,8X32MM	200	51660.048.032	ST6,3X50MM	100	51660.063.050
ST3,5X70MM*	500	51660.035.070	ST4,8X35MM*	500	51660.048.035	ST6,3X60MM*	200	51660.063.060
			ST4,8X38MM	200	51660.048.038	ST6,3X70MM*	200	51660.063.070
ST3,9X6,5MM	1000	51660.039.006	ST4,8X45MM	200	51660.048.045	ST6,3X80MM*	200	51660.063.080
ST3,9X9,5MM	200	51660.039.009	ST4,8X50MM	200	51660.048.050	ST6,3X90MM*	200	51660.063.090
ST3,9X13MM	200	51660.039.013	ST4,8X55MM*	200	51660.048.055	ST6,3X100MM*	200	51660.063.100
ST3,9X16MM	200	51660.039.016	ST4,8X60MM	200	51660.048.060	ST6,3X120MM*	200	51660.063.120
ST3,9X19MM	200	51660.039.019	ST4,8X70MM	200	51660.048.070			
ST3,9X22MM	200	51660.039.022	ST4,8X80MM	200	51660.048.080			

6



51670 Cross recessed pan head tapping screw Phillips					R01A
Thread	Self tapping thread	DIN	7981 C-H		
Material	Stainless steel A2	ISO	7049 C-H		

d x L	☒	Art.number	d x L	☒	Art.number	d x L	☒	Art.number
ST3,5X9,5MM	1000	51670.035.009	ST4,2X32MM	1000	51670.042.032	ST4,8X16MM	1000	51670.048.016
			ST4,2X38MM	500	51670.042.038	ST4,8X19MM	1000	51670.048.019
ST4,2X13MM	1000	51670.042.013	ST4,2X50MM	1000	51670.042.050	ST4,8X25MM	1000	51670.048.025
ST4,2X16MM	1000	51670.042.016				ST4,8X38MM	500	51670.048.038
ST4,2X19MM	1000	51670.042.019	ST4,8X9,5MM	1000	51670.048.009	ST4,8X50MM	500	51670.048.050
ST4,2X25MM	1000	51670.042.025	ST4,8X13MM	1000	51670.048.013			



51661 Cross recessed pan head tapping screw Pozidriv				R01A
Thread Material	Self tapping thread Stainless steel A2	DIN ISO NF	7981 C-Z 7049 C-Z E25-658 C	 

d x L	☒	Art.number	d x L	☒	Art.number	d x L	☒	Art.number
ST2,2X6,5MM*	1000	51661.022.006	ST3,9X32MM	200	51661.039.032	ST4,8X80MM*	200	51661.048.080
ST2,2X9,5MM*	1000	51661.022.009	ST3,9X38MM	200	51661.039.038	ST4,8X90MM*	200	51661.048.090
ST2,2X13MM*	1000	51661.022.013	ST3,9X45MM*	500	51661.039.045	ST4,8X100MM*	200	51661.048.100
ST2,2X16MM*	1000	51661.022.016	ST3,9X50MM*	500	51661.039.050			
			ST4,2X9,5MM	200	51661.042.009	ST5,5X13MM	200	51661.055.013
ST2,9X6,5MM	200	51661.029.006	ST4,2X13MM	200	51661.042.013	ST5,5X16MM	200	51661.055.016
ST2,9X9,5MM	200	51661.029.009	ST4,2X16MM	200	51661.042.016	ST5,5X19MM	200	51661.055.019
ST2,9X13MM	200	51661.029.013	ST4,2X19MM	200	51661.042.019	ST5,5X22MM*	1000	51661.055.022
ST2,9X16MM	200	51661.029.016	ST4,2X22MM*	1000	51661.042.022	ST5,5X25MM	200	51661.055.025
ST2,9X19MM	200	51661.029.019	ST4,2X25MM	200	51661.042.025	ST5,5X32MM	100	51661.055.032
ST2,9X22MM*	1000	51661.029.022	ST4,2X32MM	200	51661.042.032	ST5,5X38MM	100	51661.055.038
ST2,9X25MM	200	51661.029.025	ST4,2X38MM	200	51661.042.038	ST5,5X45MM	100	51661.055.045
ST2,9X32MM*	1000	51661.029.032	ST4,2X45MM	200	51661.042.045	ST5,5X50MM	100	51661.055.050
			ST4,2X50MM	200	51661.042.050	ST5,5X60MM*	200	51661.055.060
ST3,5X6,5MM	200	51661.035.006	ST4,2X55MM	200	51661.042.055	ST5,5X70MM*	200	51661.055.070
ST3,5X9,5MM	200	51661.035.009	ST4,2X60MM*	200	51661.042.060	ST5,5X80MM*	200	51661.055.080
ST3,5X13MM	200	51661.035.013	ST4,2X70MM*	200	51661.042.070	ST5,5X100MM*	200	51661.055.100
ST3,5X16MM	200	51661.035.016						
ST3,5X19MM	200	51661.035.019	ST4,8X9,5MM	200	51661.048.009	ST6,3X13MM*	500	51661.063.013
ST3,5X22MM*	1000	51661.035.022	ST4,8X13MM	200	51661.048.013	ST6,3X16MM	100	51661.063.016
ST3,5X25MM	200	51661.035.025	ST4,8X16MM	200	51661.048.016	ST6,3X19MM	100	51661.063.019
ST3,5X32MM	200	51661.035.032	ST4,8X19MM	200	51661.048.019	ST6,3X22MM*	500	51661.063.022
ST3,5X38MM	200	51661.035.038	ST4,8X22MM*	1000	51661.048.022	ST6,3X25MM	100	51661.063.025
			ST4,8X25MM	200	51661.048.025	ST6,3X32MM	100	51661.063.032
ST3,9X6,5MM*	1000	51661.039.006	ST4,8X32MM	200	51661.048.032	ST6,3X38MM	100	51661.063.038
ST3,9X9,5MM	200	51661.039.009	ST4,8X38MM	200	51661.048.038	ST6,3X45MM*	200	51661.063.045
ST3,9X13MM	200	51661.039.013	ST4,8X45MM	200	51661.048.045	ST6,3X50MM	100	51661.063.050
ST3,9X16MM	200	51661.039.016	ST4,8X50MM	200	51661.048.050	ST6,3X60MM*	200	51661.063.060
ST3,9X19MM	200	51661.039.019	ST4,8X60MM	200	51661.048.060	ST6,3X70MM*	200	51661.063.070
ST3,9X22MM*	1000	51661.039.022	ST4,8X70MM*	200	51661.048.070	ST6,3X80MM*	200	51661.063.080
ST3,9X25MM	200	51661.039.025						

6

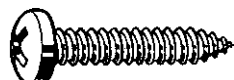

55661 Cross recessed pan head tapping screw Pozidriv				R41A
Thread Material	Self tapping thread Stainless steel A4	DIN ISO NF	7981 C-Z 7049 C-Z E25-658 C	 

d x L	☒	Art.number	d x L	☒	Art.number	d x L	☒	Art.number
ST2,2X6,5MM*	1000	55661.022.006	ST3,9X32MM*	1000	55661.039.032	ST4,8X100MM*	200	55661.048.100
ST2,2X9,5MM*	1000	55661.022.009	ST3,9X38MM*	500	55661.039.038	ST5,5X13MM*	1000	55661.055.013
ST2,2X13MM*	1000	55661.022.013	ST3,9X45MM*	500	55661.039.045	ST5,5X16MM*	1000	55661.055.016
ST2,2X16MM*	1000	55661.022.016	ST3,9X50MM*	500	55661.039.050	ST5,5X19MM*	1000	55661.055.019
ST2,2X19MM*	1000	55661.022.019				ST5,5X22MM*	1000	55661.055.022
			ST4,2X9,5MM*	1000	55661.042.009	ST5,5X25MM*	500	55661.055.025
ST2,9X6,5MM*	1000	55661.029.006	ST4,2X13MM*	1000	55661.042.013	ST5,5X32MM*	500	55661.055.032
ST2,9X9,5MM*	1000	55661.029.009	ST4,2X16MM*	1000	55661.042.016	ST5,5X38MM*	500	55661.055.038
ST2,9X13MM*	1000	55661.029.013	ST4,2X19MM*	1000	55661.042.019	ST5,5X45MM*	200	55661.055.045
ST2,9X16MM*	1000	55661.029.016	ST4,2X22MM*	1000	55661.042.022	ST5,5X50MM*	200	55661.055.050
ST2,9X19MM*	1000	55661.029.019	ST4,2X25MM*	1000	55661.042.025	ST5,5X60MM*	200	55661.055.060
ST2,9X22MM*	1000	55661.029.022	ST4,2X32MM*	500	55661.042.032	ST5,5X70MM*	200	55661.055.070
ST2,9X25MM*	1000	55661.029.025	ST4,2X38MM*	500	55661.042.038	ST5,5X80MM*	200	55661.055.080
			ST4,2X45MM*	500	55661.042.045	ST5,5X100MM*	200	55661.055.100
ST3,5X6,5MM*	1000	55661.035.006	ST4,2X50MM*	200	55661.042.050			
ST3,5X9,5MM*	1000	55661.035.009	ST4,2X60MM*	200	55661.042.060	ST6,3X13MM*	500	55661.063.013
ST3,5X13MM*	1000	55661.035.013	ST4,2X70MM*	200	55661.042.070	ST6,3X16MM*	500	55661.063.016
ST3,5X16MM*	1000	55661.035.016				ST6,3X19MM*	500	55661.063.019
ST3,5X19MM*	1000	55661.035.019	ST4,8X9MM*	1000	55661.048.009	ST6,3X22MM*	500	55661.063.022
ST3,5X22MM*	1000	55661.035.022	ST4,8X13MM*	1000	55661.048.013	ST6,3X25MM*	200	55661.063.025
ST3,5X25MM*	1000	55661.035.025	ST4,8X16MM*	1000	55661.048.016	ST6,3X32MM*	200	55661.063.032
ST3,5X32MM*	1000	55661.035.032	ST4,8X19MM*	1000	55661.048.019	ST6,3X38MM*	200	55661.063.038
ST3,5X38MM*	1000	55661.035.038	ST4,8X22MM*	1000	55661.048.022	ST6,3X45MM*	200	55661.063.045
			ST4,8X25MM*	500	55661.048.025	ST6,3X50MM*	200	55661.063.050
ST3,9X9,5MM*	1000	55661.039.009	ST4,8X32MM*	500	55661.048.032	ST6,3X60MM*	200	55661.063.060
ST3,9X13MM*	1000	55661.039.013	ST4,8X38MM*	500	55661.048.038	ST6,3X70MM*	200	55661.063.070
ST3,9X16MM*	1000	55661.039.016	ST4,8X45MM*	200	55661.048.045	ST6,3X80MM*	200	55661.063.080
ST3,9X19MM*	1000	55661.039.019	ST4,8X50MM*	200	55661.048.050	ST6,3X100MM*	200	55661.063.100
ST3,9X22MM*	1000	55661.039.022	ST4,8X70MM*	200	55661.048.070			
ST3,9X25MM*	1000	55661.039.025	ST4,8X80MM*	200	55661.048.080			

55660 Cross recessed pan head tapping screw Phillips				R41A
Thread	Self tapping thread	DIN	7981 C-H	
Material	Stainless steel A4	ISO	7049 C-H	
				

d x L	☒	Art.number	d x L	☒	Art.number	d x L	☒	Art.number
ST2,2X6,5MM*	1000	55660.022.006	ST3,9X32MM*	1000	55660.039.032	ST5,5X13MM	200	55660.055.013
ST2,2X9,5MM*	1000	55660.022.009	ST3,9X38MM*	500	55660.039.038	ST5,5X16MM	200	55660.055.016
ST2,2X13MM*	1000	55660.022.013	ST3,9X45MM*	500	55660.039.045	ST5,5X19MM	200	55660.055.019
ST2,2X22MM*	1000	55660.022.022	ST3,9X50MM*	500	55660.039.050	ST5,5X22MM	200	55660.055.022
ST2,9X6,5MM	200	55660.029.006	ST4,2X9,5MM	200	55660.042.009	ST5,5X25MM	200	55660.055.025
ST2,9X9,5MM	200	55660.029.009	ST4,2X13MM	200	55660.042.013	ST5,5X32MM	100	55660.055.032
ST2,9X13MM	200	55660.029.013	ST4,2X16MM	200	55660.042.016	ST5,5X38MM	100	55660.055.038
ST2,9X16MM	200	55660.029.016	ST4,2X19MM	200	55660.042.019	ST5,5X45MM	100	55660.055.045
ST2,9X19MM	200	55660.029.019	ST4,2X22MM	200	55660.042.022	ST5,5X50MM	100	55660.055.050
ST2,9X22MM*	1000	55660.029.022	ST4,2X25MM	200	55660.042.025	ST5,5X60MM*	200	55660.055.060
ST2,9X25MM	1000	55660.029.025	ST4,2X32MM	200	55660.042.032	ST5,5X70MM*	200	55660.055.070
ST2,9X32MM*	1000	55660.029.032	ST4,2X38MM	200	55660.042.038	ST5,5X80MM*	200	55660.055.080
ST3,5X6,5MM*	1000	55660.035.006	ST4,2X45MM*	500	55660.042.045	ST5,5X90MM*	200	55660.055.090
ST3,5X9,5MM	200	55660.035.009	ST4,2X50MM	200	55660.042.050	ST5,5X100MM*	200	55660.055.100
ST3,5X13MM	200	55660.035.013	ST4,2X60MM*	200	55660.042.060	ST6,3X13MM	100	55660.063.013
ST3,5X16MM	200	55660.035.016	ST4,2X70MM*	200	55660.042.070	ST6,3X16MM	100	55660.063.016
ST3,5X19MM	200	55660.035.019	ST4,8X9,5MM*	1000	55660.048.009	ST6,3X19MM	100	55660.063.019
ST3,5X22MM	200	55660.035.022	ST4,8X13MM	200	55660.048.013	ST6,3X22MM	100	55660.063.022
ST3,5X25MM	200	55660.035.025	ST4,8X16MM	200	55660.048.016	ST6,3X25MM	100	55660.063.025
ST3,5X32MM	200	55660.035.032	ST4,8X19MM	200	55660.048.019	ST6,3X32MM	100	55660.063.032
ST3,5X38MM*	1000	55660.035.038	ST4,8X22MM	200	55660.048.022	ST6,3X38MM	100	55660.063.038
ST3,9X6,5MM*	1000	55660.039.006	ST4,8X25MM	200	55660.048.025	ST6,3X45MM	100	55660.063.045
ST3,9X9,5MM	200	55660.039.009	ST4,8X32MM	200	55660.048.032	ST6,3X50MM	100	55660.063.050
ST3,9X13MM	200	55660.039.013	ST4,8X38MM	200	55660.048.038	ST6,3X60MM*	200	55660.063.060
ST3,9X16MM	200	55660.039.016	ST4,8X45MM*	200	55660.048.045	ST6,3X70MM*	200	55660.063.070
ST3,9X19MM	200	55660.039.019	ST4,8X50MM	200	55660.048.050	ST6,3X80MM*	200	55660.063.080
ST3,9X22MM	200	55660.039.022	ST4,8X60MM*	200	55660.048.060	ST6,3X90MM*	200	55660.063.090
ST3,9X25MM	200	55660.039.025	ST4,8X70MM*	200	55660.048.070	ST6,3X100MM*	200	55660.063.100
			ST4,8X80MM*	200	55660.048.080			

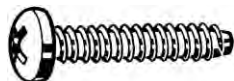
6

26300 Cross recessed pan head tapping screw Phillips without point				J03B
Thread	Self tapping thread	DIN	7981 F-H	
Material	Steel	ISO	7049 F-H	
Surface treatment	Nickel plated			

d x L	☒	Art.number	d x L	☒	Art.number	d x L	☒	Art.number
ST2,2X4,5MM	2000	26300.022.004	ST2,9X19MM	2000	26300.029.019	ST4,2X9,5MM	1000	26300.042.009
ST2,2X6,5MM	2000	26300.022.006	ST3,5X6,5MM	2000	26300.035.006	ST4,2X13MM	1000	26300.042.013
ST2,9X4,5MM	2000	26300.029.004	ST3,5X8MM	2000	26300.035.008	ST4,2X16MM	1000	26300.042.016
ST2,9X6,5MM	2000	26300.029.006	ST3,5X9,5MM	2000	26300.035.009	ST4,2X19MM	500	26300.042.019
ST2,9X8MM	2000	26300.029.008	ST3,5X13MM	2000	26300.035.013	ST4,2X32MM	500	26300.042.032
ST2,9X9,5MM	2000	26300.029.009	ST3,5X16MM	1000	26300.035.016	ST4,8X13MM	1000	26300.048.013
ST2,9X13MM	2000	26300.029.013	ST3,5X19MM	1000	26300.035.019	ST4,8X19MM	500	26300.048.019
ST2,9X16MM	2000	26300.029.016						

- Warning: electro-galvanizing of these products may cause hydrogen embrittlement.

Hexalobular socket pan head tapping screw

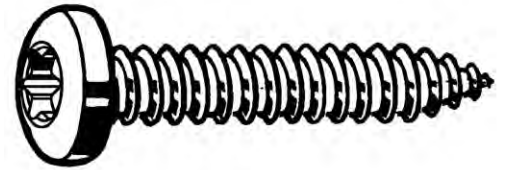
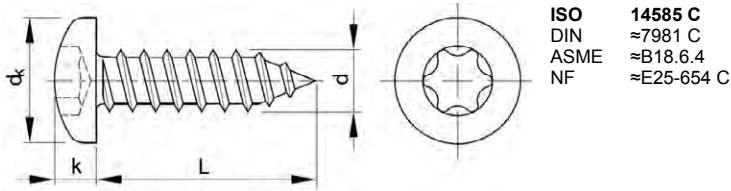

Technical Data

d	dk	k	P	Socket
ST2.2	4.2	1.8	0.8	T6
ST2.9	5.6	2.2	1.1	T8/T10
ST3.5	6.9	2.6	1.3	T10
ST3.9 (#ISO)	7.5	2.8	1.4	T15
ST4.2	8.2	3.05	1.4	T20
ST4.8	9.5	3.55	1.6	T25
ST5.5	10.8	3.95	1.8	T25
ST6.3	12.5	4.55	1.8	T30

Article groups

Thread	Driving features	Material	Surface treatment	Code	Page
ST	Hexalobular	St	Zipl	26501	6-84
ST	Hexalobular	St.St. A2		51664	6-84
ST	Hexalobular	St.St. A4		55664	6-85

6

26501 Hexalobular socket pan head tapping screw

J03A

Thread Self tapping thread
Material Steel
Surface treatment Zinc plated

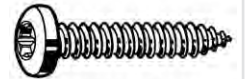

d x L	Art.number	d x L	Art.number	d x L	Art.number
ST2,9X9,5MM	200 26501.029.009	ST3,9X13MM	200 26501.039.013	ST4,8X19MM	200 26501.048.019
ST2,9X13MM	200 26501.029.013			ST5,5X19MM	200 26501.055.019
ST3,5X9,5MM	200 26501.035.009	ST4,2X13MM	200 26501.042.013	ST5,5X25MM	100 26501.055.025
ST3,5X13MM	200 26501.035.013	ST4,2X16MM	200 26501.042.016		
ST3,5X16MM	200 26501.035.016	ST4,2X19MM	200 26501.042.019	ST6,3X19MM	100 26501.063.019
ST3,5X19MM	200 26501.035.019	ST4,2X25MM	200 26501.042.025	ST6,3X25MM	100 26501.063.025
				ST6,3X32MM	100 26501.063.032
ST3,9X9,5MM	200 26501.039.009	ST4,8X13MM	200 26501.048.013	ST6,3X45MM	100 26501.063.045
		ST4,8X16MM	200 26501.048.016		

• Warning: electro-galvanizing of these products may cause hydrogen embrittlement.

51664 Hexalobular socket pan head tapping screw

R03A

Thread Self tapping thread
Material Stainless steel A2

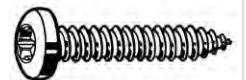

d x L	Art.number	d x L	Art.number	d x L	Art.number
ST2,2X6,5MM*	1000 51664.022.006	ST3,5X6,5MM*	1000 51664.035.006	ST3,9X16MM*	1000 51664.039.016
ST2,2X9,5MM*	1000 51664.022.009	ST3,5X9,5MM*	1000 51664.035.009	ST3,9X19MM*	1000 51664.039.019
ST2,2X13MM*	1000 51664.022.013	ST3,5X13MM*	1000 51664.035.013	ST3,9X22MM*	1000 51664.039.022
ST2,2X16MM*	1000 51664.022.016	ST3,5X16MM	1000 51664.035.016	ST3,9X25MM*	1000 51664.039.025
ST2,2X19MM*	1000 51664.022.019	ST3,5X19MM*	1000 51664.035.019	ST3,9X32MM*	1000 51664.039.032
ST2,2X22MM*	1000 51664.022.022	ST3,5X22MM*	1000 51664.035.022	ST3,9X38MM*	500 51664.039.038
ST2,2X25MM*	1000 51664.022.025	ST3,5X25MM*	1000 51664.035.025	ST3,9X45MM*	500 51664.039.045
		ST3,5X32MM*	1000 51664.035.032	ST3,9X50MM*	500 51664.039.050
ST2,9X6,5MM*	1000 51664.029.006	ST3,5X38MM*	1000 51664.035.038	ST3,9X60MM*	500 51664.039.060
ST2,9X9,5MM*	1000 51664.029.009	ST3,5X45MM*	500 51664.035.045		
ST2,9X13MM*	1000 51664.029.013	ST3,5X50MM*	500 51664.035.050	ST4,2X9,5MM*	1000 51664.042.009
ST2,9X16MM*	1000 51664.029.016			ST4,2X13MM	1000 51664.042.013
ST2,9X19MM*	1000 51664.029.019	ST3,9X6,5MM*	1000 51664.039.006	ST4,2X16MM*	1000 51664.042.016
ST2,9X22MM*	1000 51664.029.022	ST3,9X9,5MM*	1000 51664.039.009	ST4,2X19MM	1000 51664.042.019
ST2,9X25MM*	1000 51664.029.025	ST3,9X13MM*	1000 51664.039.013	ST4,2X22MM*	1000 51664.042.022
ST2,9X32MM*	1000 51664.029.032			ST4,2X25MM*	1000 51664.042.025

51664 Hexalobular socket pan head tapping screw								
d x L	☒	Art.number	d x L	☒	Art.number	d x L	☒	Art.number
ST4,2X32MM	500	51664.042.032	ST4,8X50MM*	200	51664.048.050	ST5,5X80MM*	200	51664.055.080
ST4,2X38MM	500	51664.042.038	ST4,8X60MM*	200	51664.048.060	ST6,3X13MM*	500	51664.063.013
ST4,2X45MM*	500	51664.042.045	ST4,8X70MM*	200	51664.048.070	ST6,3X16MM*	500	51664.063.016
ST4,2X50MM*	200	51664.042.050	ST5,5X13MM*	1000	51664.055.013	ST6,3X19MM*	500	51664.063.019
ST4,2X60MM*	200	51664.042.060	ST5,5X16MM*	1000	51664.055.016	ST6,3X22MM*	500	51664.063.022
ST4,8X9,5MM*	1000	51664.048.009	ST5,5X19MM*	1000	51664.055.019	ST6,3X25MM*	200	51664.063.025
ST4,8X13MM*	1000	51664.048.013	ST5,5X22MM*	1000	51664.055.022	ST6,3X32MM*	200	51664.063.032
ST4,8X16MM*	1000	51664.048.016	ST5,5X25MM*	500	51664.055.025	ST6,3X38MM*	200	51664.063.038
ST4,8X19MM*	1000	51664.048.019	ST5,5X32MM*	500	51664.055.032	ST6,3X45MM*	200	51664.063.045
ST4,8X22MM*	1000	51664.048.022	ST5,5X38MM*	500	51664.055.038	ST6,3X50MM*	200	51664.063.050
ST4,8X25MM*	500	51664.048.025	ST5,5X45MM*	200	51664.055.045	ST6,3X60MM*	200	51664.063.060
ST4,8X32MM*	500	51664.048.032	ST5,5X50MM	200	51664.055.050	ST6,3X70MM*	200	51664.063.070
ST4,8X38MM	500	51664.048.038	ST5,5X60MM	200	51664.055.060	ST6,3X80MM*	200	51664.063.080
ST4,8X45MM*	200	51664.048.045	ST5,5X70MM*	200	51664.055.070			

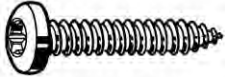
55664 Hexalobular socket pan head tapping screw		R43A
Thread	Self tapping thread	
Material	Stainless steel A4	
		
		

d x L	☒	Art.number	d x L	☒	Art.number	d x L	☒	Art.number
ST2,2X6,5MM*	1000	55664.022.006	ST3,9X16MM*	1000	55664.039.016	ST4,8X45MM*	200	55664.048.045
ST2,2X9,5MM*	1000	55664.022.009	ST3,9X19MM*	1000	55664.039.019	ST4,8X50MM*	200	55664.048.050
ST2,2X13MM*	1000	55664.022.013	ST3,9X22MM*	1000	55664.039.022	ST4,8X60MM*	200	55664.048.060
ST2,2X16MM*	1000	55664.022.016	ST3,9X25MM*	1000	55664.039.025	ST4,8X70MM*	200	55664.048.070
ST2,2X19MM*	1000	55664.022.019	ST3,9X32MM*	1000	55664.039.032	ST5,5X13MM*	1000	55664.055.013
ST2,2X22MM*	1000	55664.022.022	ST3,9X38MM*	500	55664.039.038	ST5,5X16MM*	1000	55664.055.016
ST2,2X25MM*	1000	55664.022.025	ST3,9X45MM*	500	55664.039.045	ST5,5X19MM*	1000	55664.055.019
ST2,9X6,5MM*	1000	55664.029.006	ST3,9X50MM*	500	55664.039.050	ST5,5X22MM*	1000	55664.055.022
ST2,9X9,5MM*	1000	55664.029.009	ST3,9X60MM*	500	55664.039.060	ST5,5X25MM*	500	55664.055.025
ST2,9X13MM*	1000	55664.029.013	ST4,2X9,5MM*	1000	55664.042.009	ST5,5X32MM*	500	55664.055.032
ST2,9X16MM*	1000	55664.029.016	ST4,2X13MM*	1000	55664.042.013	ST5,5X38MM*	500	55664.055.038
ST2,9X19MM*	1000	55664.029.019	ST4,2X16MM*	1000	55664.042.016	ST5,5X45MM*	200	55664.055.045
ST2,9X22MM*	1000	55664.029.022	ST4,2X19MM*	1000	55664.042.019	ST5,5X50MM*	200	55664.055.050
ST2,9X25MM*	1000	55664.029.025	ST4,2X22MM*	1000	55664.042.022	ST5,5X60MM*	200	55664.055.060
ST2,9X32MM*	1000	55664.029.032	ST4,2X25MM*	1000	55664.042.025	ST5,5X70MM*	200	55664.055.070
ST3,5X6,5MM*	1000	55664.035.006	ST4,2X32MM*	500	55664.042.032	ST5,5X80MM*	200	55664.055.080
ST3,5X9,5MM*	1000	55664.035.009	ST4,2X38MM*	500	55664.042.038	ST6,3X13MM*	500	55664.063.013
ST3,5X13MM*	1000	55664.035.013	ST4,2X45MM*	500	55664.042.045	ST6,3X16MM*	500	55664.063.016
ST3,5X16MM*	1000	55664.035.016	ST4,2X50MM*	200	55664.042.050	ST6,3X19MM*	500	55664.063.019
ST3,5X19MM*	1000	55664.035.019	ST4,2X60MM*	200	55664.042.060	ST6,3X22MM*	500	55664.063.022
ST3,5X22MM*	1000	55664.035.022	ST4,8X9,5MM*	1000	55664.048.009	ST6,3X25MM*	200	55664.063.025
ST3,5X25MM*	1000	55664.035.025	ST4,8X13MM*	1000	55664.048.013	ST6,3X32MM*	200	55664.063.032
ST3,5X32MM*	1000	55664.035.032	ST4,8X16MM*	1000	55664.048.016	ST6,3X38MM*	200	55664.063.038
ST3,5X38MM*	1000	55664.035.038	ST4,8X19MM*	1000	55664.048.019	ST6,3X45MM*	200	55664.063.045
ST3,5X50MM*	500	55664.035.050	ST4,8X22MM*	1000	55664.048.022	ST6,3X50MM*	200	55664.063.050
ST3,9X6,5MM*	1000	55664.039.006	ST4,8X25MM*	500	55664.048.025	ST6,3X60MM*	200	55664.063.060
ST3,9X9,5MM*	1000	55664.039.009	ST4,8X32MM*	500	55664.048.032	ST6,3X70MM*	200	55664.063.070
ST3,9X13MM*	1000	55664.039.013	ST4,8X38MM*	500	55664.048.038	ST6,3X80MM*	200	55664.063.080

Square recessed pan head tapping screw

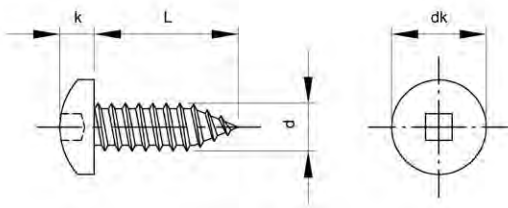

DIN ≈7981 C
 ISO ≈7049 C
 ASME ≈B18.6.4
 NF ≈E25-654 C



Technical Data

d	d _k	k	No. square	P
ST3.5	6.9	2.6	1	1.3
ST3.9	7.5	2.8	1	1.4
ST4.2	8.2	3.05	2	1.4
ST4.8	9.5	3.55	2	1.6

51663 Square recessed pan head tapping screw

R03A

Thread Self tapping thread
 Material Stainless steel A2



6

d x L	☒	Art.number	d x L	☒	Art.number	d x L	☒	Art.number
ST3,5X9,5MM*	200	51663.035.009	ST4,2X9,5MM*	200	51663.042.009	ST4,8X22MM*	200	51663.048.022
ST3,5X13MM*	200	51663.035.013	ST4,2X13MM*	200	51663.042.013	ST4,8X25MM*	200	51663.048.025
ST3,5X19MM*	200	51663.035.019	ST4,2X16MM*	200	51663.042.016	ST4,8X32MM*	200	51663.048.032
ST3,5X22MM*	200	51663.035.022	ST4,2X19MM*	200	51663.042.019	ST4,8X38MM*	200	51663.048.038
ST3,5X25MM*	200	51663.035.025	ST4,2X25MM*	200	51663.042.025	ST4,8X45MM*	200	51663.048.045
ST3,9X9,5MM*	200	51663.039.009	ST4,2X32MM*	200	51663.042.032	ST4,8X50MM*	200	51663.048.050
ST3,9X13MM*	200	51663.039.013	ST4,2X38MM*	200	51663.042.038	ST4,8X60MM*	200	51663.048.060
ST3,9X16MM*	200	51663.039.016	ST4,2X45MM*	200	51663.042.045	ST4,8X70MM*	200	51663.048.070
ST3,9X19MM*	200	51663.039.019	ST4,2X50MM*	200	51663.042.050	ST4,8X80MM*	200	51663.048.080
ST3,9X22MM*	200	51663.039.022				ST4,8X100MM*	200	51663.048.100
ST3,9X25MM*	200	51663.039.025	ST4,8X13MM*	200	51663.048.013	ST4,8X120MM*	200	51663.048.120
ST3,9X32MM*	200	51663.039.032	ST4,8X16MM*	200	51663.048.016	ST4,8X150MM*	200	51663.048.150
ST3,9X38MM*	200	51663.039.038	ST4,8X19MM*	200	51663.048.019			

Cross recessed countersunk head tapping screw

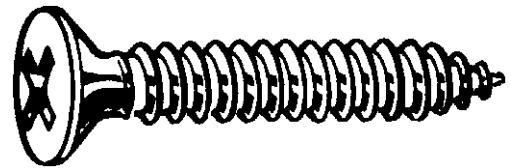
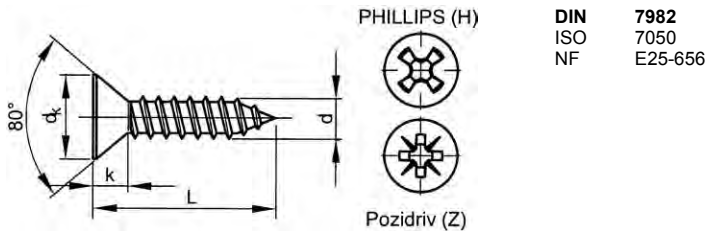

Technical Data

d	dk	k ≈	No. cross recess	P
ST2.2	4.3	1.3	1	0.8
ST2.9	5.5	1.7	1	1.1
ST3.5	6.8	2.1	2	1.3
ST3.9	7.5	2.3	2	1.4
ST4.2	8.1	2.5	2	1.4
ST4.8	9.5	3	2	1.6
ST5.5	10.8	3.4	3	1.8
ST6.3	12.4	3.8	3	1.8

Article groups

Thread	Driving features	Material	Surface treatment	Code	Page
ST	Phillips	St	Zipl	26680	6-87
ST	Phillips	St	Zipl large pack	26690	6-88
ST	Pozidriv	St	Zipl	26770	6-88
ST	Phillips	St	Ni.pl.	26220	6-88
ST	Pozidriv	St	Zipl blk p.	26432	6-89
ST	Phillips	St.St. A2		51680	6-89
ST	Pozidriv	St.St. A2		51681	6-89
ST	Phillips	St.St. A4		55680	6-90
ST	Pozidriv	St.St. A4		55681	6-90

26680 Cross recessed countersunk head tapping screw Phillips



J01B

Thread	Self tapping thread	DIN	7982 C-H
Material	Steel	ISO	7050 C-H
Surface treatment	Zinc plated		





d x L	Art.number	d x L	Art.number	d x L	Art.number
ST2,9X6,5MM	200 26680.029.006	ST3,9X25MM	200 26680.039.025	ST4,8X50MM	100 26680.048.050
ST2,9X9,5MM	200 26680.029.009	ST3,9X32MM	200 26680.039.032	ST5,5X13MM	200 26680.055.013
ST2,9X13MM	200 26680.029.013	ST4,2X9,5MM	200 26680.042.009	ST5,5X16MM	200 26680.055.016
ST2,9X16MM	200 26680.029.016	ST4,2X13MM	200 26680.042.013	ST5,5X19MM	200 26680.055.019
ST2,9X19MM	200 26680.029.019	ST4,2X16MM	200 26680.042.016	ST5,5X22MM	100 26680.055.022
ST2,9X22MM	200 26680.029.022	ST4,2X19MM	200 26680.042.019	ST5,5X25MM	100 26680.055.025
ST2,9X25MM	200 26680.029.025	ST4,2X22MM	200 26680.042.022	ST5,5X32MM	100 26680.055.032
ST3,5X9,5MM	200 26680.035.009	ST4,2X25MM	200 26680.042.025	ST5,5X38MM	100 26680.055.038
ST3,5X13MM	200 26680.035.013	ST4,2X32MM	200 26680.042.032	ST5,5X45MM	100 26680.055.045
ST3,5X16MM	200 26680.035.016	ST4,2X38MM	200 26680.042.038	ST5,5X50MM	100 26680.055.050
ST3,5X19MM	200 26680.035.019	ST4,2X45MM	200 26680.042.045	ST6,3X16MM	100 26680.063.016
ST3,5X22MM	200 26680.035.022	ST4,2X50MM	200 26680.042.050	ST6,3X19MM	100 26680.063.019
ST3,5X25MM	200 26680.035.025	ST4,8X13MM	200 26680.048.013	ST6,3X22MM	100 26680.063.022
ST3,5X32MM	200 26680.035.032	ST4,8X16MM	200 26680.048.016	ST6,3X25MM	100 26680.063.025
ST3,5X38MM	200 26680.035.038	ST4,8X19MM	200 26680.048.019	ST6,3X32MM	100 26680.063.032
ST3,9X9,5MM	200 26680.039.009	ST4,8X22MM	200 26680.048.022	ST6,3X38MM	100 26680.063.038
ST3,9X13MM	200 26680.039.013	ST4,8X25MM	200 26680.048.025	ST6,3X45MM	100 26680.063.045
ST3,9X16MM	200 26680.039.016	ST4,8X32MM	100 26680.048.032	ST6,3X50MM	100 26680.063.050
ST3,9X19MM	200 26680.039.019	ST4,8X38MM	100 26680.048.038	ST6,3X60MM	100 26680.063.060
ST3,9X22MM	200 26680.039.022	ST4,8X45MM	100 26680.048.045		

• Warning: electro-galvanizing of these products may cause hydrogen embrittlement.

26690 Cross recessed countersunk head tapping screw Phillips				J01B
Thread	Self tapping thread	DIN	7982 C-H	
Material	Steel	ISO	7050 C-H	
Surface treatment	Zinc plated			
				



d x L	☒	Art.number	d x L	☒	Art.number	d x L	☒	Art.number
ST2,9X9,5MM	2000	26690.029.009	ST3,5X25MM	2000	26690.035.025	ST4,2X25MM	1000	26690.042.025
ST2,9X13MM	2000	26690.029.013						
ST3,5X9,5MM	2000	26690.035.009	ST3,9X32MM	500	26690.039.032	ST4,8X16MM	1000	26690.048.016
ST3,5X13MM	2000	26690.035.013				ST4,8X19MM	1000	26690.048.019
ST3,5X16MM	2000	26690.035.016	ST4,2X13MM	1000	26690.042.013	ST4,8X25MM	1000	26690.048.025
ST3,5X19MM	2000	26690.035.019	ST4,2X16MM	1000	26690.042.016	ST4,8X32MM	500	26690.048.032
			ST4,2X19MM	1000	26690.042.019	ST4,8X38MM	500	26690.048.038

• Warning: electro-galvanizing of these products may cause hydrogen embrittlement.

26770 Cross recessed countersunk head tapping screw Pozidriv				J01A
Thread	Self tapping thread	DIN	7982 C-Z	
Material	Steel	ISO	7050 C-Z	
Surface treatment	Zinc plated	NF	E25-656 C	
				

d x L	☒	Art.number	d x L	☒	Art.number	d x L	☒	Art.number
ST2,9X9,5MM	200	26770.029.009	ST3,9X32MM	200	26770.039.032	ST5,5X13MM	200	26770.055.013
ST2,9X13MM	200	26770.029.013				ST5,5X16MM	200	26770.055.016
ST2,9X16MM	200	26770.029.016	ST4,2X9,5MM	200	26770.042.009	ST5,5X19MM	200	26770.055.019
ST2,9X19MM	200	26770.029.019	ST4,2X13MM	200	26770.042.013	ST5,5X25MM	100	26770.055.025
ST2,9X25MM	200	26770.029.025	ST4,2X16MM	200	26770.042.016	ST5,5X32MM	100	26770.055.032
			ST4,2X19MM	200	26770.042.019	ST5,5X38MM	100	26770.055.038
ST3,5X9,5MM	200	26770.035.009	ST4,2X25MM	200	26770.042.025	ST5,5X45MM	100	26770.055.045
ST3,5X13MM	200	26770.035.013	ST4,2X32MM	200	26770.042.032	ST5,5X50MM	100	26770.055.050
ST3,5X16MM	200	26770.035.016	ST4,2X38MM	200	26770.042.038			
ST3,5X19MM	200	26770.035.019	ST4,2X45MM	200	26770.042.045	ST6,3X16MM	100	26770.063.016
ST3,5X25MM	200	26770.035.025				ST6,3X19MM	100	26770.063.019
ST3,5X32MM	200	26770.035.032	ST4,8X13MM	200	26770.048.013	ST6,3X25MM	100	26770.063.025
ST3,5X38MM	200	26770.035.038	ST4,8X16MM	200	26770.048.016	ST6,3X32MM	100	26770.063.032
			ST4,8X19MM	200	26770.048.019	ST6,3X38MM	100	26770.063.038
ST3,9X9,5MM	200	26770.039.009	ST4,8X25MM	200	26770.048.025	ST6,3X45MM	100	26770.063.045
ST3,9X13MM	200	26770.039.013	ST4,8X32MM	100	26770.048.032	ST6,3X50MM	100	26770.063.050
ST3,9X16MM	200	26770.039.016	ST4,8X38MM	100	26770.048.038	ST6,3X60MM	100	26770.063.060
ST3,9X19MM	200	26770.039.019	ST4,8X45MM	100	26770.048.045			
ST3,9X25MM	200	26770.039.025	ST4,8X50MM	100	26770.048.050			

• Warning: electro-galvanizing of these products may cause hydrogen embrittlement.

26220 Cross recessed countersunk head tapping screw Phillips				J03B
Thread	Self tapping thread	DIN	7982 C-H	
Material	Steel	ISO	7050 C-H	
Surface treatment	Nickel plated			
				

d x L	☒	Art.number	d x L	☒	Art.number	d x L	☒	Art.number
ST3,5X13MM	200	26220.035.013	ST4,2X25MM	200	26220.042.025	ST5,5X25MM	100	26220.055.025
ST3,5X16MM	200	26220.035.016	ST4,2X32MM	200	26220.042.032	ST5,5X32MM	100	26220.055.032
ST3,5X19MM	200	26220.035.019	ST4,2X38MM	200	26220.042.038			
ST3,5X25MM	200	26220.035.025				ST6,3X25MM	100	26220.063.025
			ST4,8X16MM	200	26220.048.016	ST6,3X45MM	100	26220.063.045
ST4,2X9,5MM	200	26220.042.009	ST4,8X19MM	200	26220.048.019	ST6,3X50MM	100	26220.063.050
ST4,2X13MM	200	26220.042.013	ST4,8X25MM	200	26220.048.025	ST6,3X55MM	100	26220.063.055
ST4,2X16MM	200	26220.042.016	ST4,8X32MM	100	26220.048.032	ST6,3X60MM	100	26220.063.060
ST4,2X19MM	200	26220.042.019						

• Warning: electro-galvanizing of these products may cause hydrogen embrittlement.

6

26432 Cross recessed countersunk head tapping screw Pozidriv				J03B
Thread	Self tapping thread	DIN	7982 C-Z	
Material	Steel	ISO	7050 C-Z	
Surface treatment	Zinc plated black passivated	NF	E25-656 C	

d x L	☒	Art.number	d x L	☒	Art.number	d x L	☒	Art.number
ST2,9X13MM	200	26432.029.013	ST3,5X16MM	200	26432.035.016	ST4,2X16MM	200	26432.042.016
ST3,5X9,5MM	200	26432.035.009	ST3,5X19MM	200	26432.035.019	ST4,2X19MM	200	26432.042.019

• Warning: electro-galvanizing of these products may cause hydrogen embrittlement.

51680 Cross recessed countersunk head tapping screw Phillips				R01A
Thread	Self tapping thread	DIN	7982 C-H	
Material	Stainless steel A2	ISO	7050 C-H	



d x L	☒	Art.number	d x L	☒	Art.number	d x L	☒	Art.number
ST2,2X6,5MM	1000	51680.022.006	ST3,9X22MM	200	51680.039.022	ST4,8X80MM	200	51680.048.080
ST2,2X9,5MM*	1000	51680.022.009	ST3,9X25MM	200	51680.039.025	ST4,8X90MM	200	51680.048.090
ST2,2X13MM*	1000	51680.022.013	ST3,9X32MM	200	51680.039.032	ST4,8X100MM	100	51680.048.100
ST2,2X16MM	1000	51680.022.016	ST3,9X38MM	200	51680.039.038	ST4,8X120MM*	200	51680.048.120
ST2,2X19MM*	1000	51680.022.019	ST3,9X45MM*	500	51680.039.045			
ST2,2X22MM*	1000	51680.022.022	ST3,9X50MM	500	51680.039.050	ST5,5X13MM	200	51680.055.013
ST2,2X25MM*	1000	51680.022.025	ST3,9X60MM*	500	51680.039.060	ST5,5X16MM	200	51680.055.016
			ST3,9X70MM*	500	51680.039.070	ST5,5X19MM	200	51680.055.019
ST2,9X6,5MM	200	51680.029.006				ST5,5X22MM	200	51680.055.022
ST2,9X9,5MM	200	51680.029.009	ST4,2X9,5MM	200	51680.042.009	ST5,5X25MM	200	51680.055.025
ST2,9X13MM	200	51680.029.013	ST4,2X13MM	200	51680.042.013	ST5,5X32MM	100	51680.055.032
ST2,9X16MM	200	51680.029.016	ST4,2X16MM	200	51680.042.016	ST5,5X38MM	100	51680.055.038
ST2,9X19MM	200	51680.029.019	ST4,2X19MM	200	51680.042.019	ST5,5X45MM	100	51680.055.045
ST2,9X22MM	200	51680.029.022	ST4,2X22MM	200	51680.042.022	ST5,5X50MM	100	51680.055.050
ST2,9X25MM	200	51680.029.025	ST4,2X25MM	200	51680.042.025	ST5,5X60MM	200	51680.055.060
ST2,9X32MM*	1000	51680.029.032	ST4,2X32MM	200	51680.042.032	ST5,5X70MM*	200	51680.055.070
			ST4,2X38MM	200	51680.042.038	ST5,5X80MM*	200	51680.055.080
ST3,5X6,5MM*	1000	51680.035.006	ST4,2X45MM	200	51680.042.045	ST5,5X90MM*	200	51680.055.090
ST3,5X9,5MM	200	51680.035.009	ST4,2X50MM	200	51680.042.050	ST5,5X100MM*	200	51680.055.100
ST3,5X13MM	200	51680.035.013	ST4,2X60MM	200	51680.042.060	ST5,5X120MM*	200	51680.055.120
ST3,5X16MM	200	51680.035.016	ST4,2X70MM*	200	51680.042.070			
ST3,5X19MM	200	51680.035.019	ST4,2X80MM*	200	51680.042.080	ST6,3X13MM*	500	51680.063.013
ST3,5X22MM	200	51680.035.022				ST6,3X16MM	100	51680.063.016
ST3,5X25MM	200	51680.035.025	ST4,8X9,5MM	200	51680.048.009	ST6,3X19MM	100	51680.063.019
ST3,5X32MM	200	51680.035.032	ST4,8X13MM	200	51680.048.013	ST6,3X22MM	100	51680.063.022
ST3,5X38MM	200	51680.035.038	ST4,8X16MM	200	51680.048.016	ST6,3X25MM	100	51680.063.025
ST3,5X45MM*	500	51680.035.045	ST4,8X19MM	200	51680.048.019	ST6,3X32MM	100	51680.063.032
ST3,5X50MM*	500	51680.035.050	ST4,8X22MM	200	51680.048.022	ST6,3X38MM	100	51680.063.038
ST3,5X60MM*	500	51680.035.060	ST4,8X25MM	200	51680.048.025	ST6,3X45MM	100	51680.063.045
ST3,5X70MM*	500	51680.035.070	ST4,8X32MM	200	51680.048.032	ST6,3X50MM	100	51680.063.050
			ST4,8X38MM	200	51680.048.038	ST6,3X60MM*	200	51680.063.060
ST3,9X6,5MM*	1000	51680.039.006	ST4,8X45MM	200	51680.048.045	ST6,3X70MM*	200	51680.063.070
ST3,9X9,5MM	200	51680.039.009	ST4,8X50MM	200	51680.048.050	ST6,3X80MM*	200	51680.063.080
ST3,9X13MM	200	51680.039.013	ST4,8X55MM*	200	51680.048.055	ST6,3X90MM*	200	51680.063.090
ST3,9X16MM	200	51680.039.016	ST4,8X60MM	200	51680.048.060	ST6,3X100MM*	200	51680.063.100
ST3,9X19MM	200	51680.039.019	ST4,8X70MM	200	51680.048.070			

6

51681 Cross recessed countersunk head tapping screw Pozidriv				R01A
Thread	Self tapping thread	DIN	7982 C-Z	
Material	Stainless steel A2	ISO	7050 C-Z	
		NF	E25-656 C	



d x L	☒	Art.number	d x L	☒	Art.number	d x L	☒	Art.number
ST2,2X6,5MM*	1000	51681.022.006	ST2,9X16MM	200	51681.029.016	ST3,5X19MM	200	51681.035.019
ST2,2X9,5MM*	1000	51681.022.009	ST2,9X19MM	200	51681.029.019	ST3,5X22MM*	1000	51681.035.022
ST2,2X13MM*	1000	51681.022.013	ST2,9X22MM*	1000	51681.029.022	ST3,5X25MM	200	51681.035.025
ST2,2X16MM*	1000	51681.022.016	ST2,9X25MM	200	51681.029.025	ST3,5X32MM	200	51681.035.032
ST2,2X19MM*	1000	51681.022.019	ST2,9X32MM*	1000	51681.029.032	ST3,5X38MM	200	51681.035.038
ST2,2X25MM*	1000	51681.022.025						
ST2,9X6,5MM*	1000	51681.029.006	ST3,5X6,5MM*	1000	51681.035.006	ST3,9X6,5MM*	1000	51681.039.006
ST2,9X9,5MM	200	51681.029.009	ST3,5X9,5MM	200	51681.035.009	ST3,9X9,5MM*	1000	51681.039.009
ST2,9X13MM	200	51681.029.013	ST3,5X13MM	200	51681.035.013	ST3,9X13MM	200	51681.039.013
			ST3,5X16MM	200	51681.035.016	ST3,9X16MM	200	51681.039.016

51681 Cross recessed countersunk head tapping screw Pozidriv								
d x L	☒	Art.number	d x L	☒	Art.number	d x L	☒	Art.number
ST3,9X19MM	200	51681.039.019	ST4,8X9,5MM*	1000	51681.048.009	ST5,5X32MM	100	51681.055.032
ST3,9X22MM*	1000	51681.039.022	ST4,8X13MM*	1000	51681.048.013	ST5,5X38MM	100	51681.055.038
ST3,9X25MM	200	51681.039.025	ST4,8X16MM	200	51681.048.016	ST5,5X45MM	100	51681.055.045
ST3,9X32MM	200	51681.039.032	ST4,8X19MM	200	51681.048.019	ST5,5X50MM	100	51681.055.050
ST3,9X38MM*	500	51681.039.038	ST4,8X22MM*	1000	51681.048.022	ST5,5X60MM*	200	51681.055.060
ST3,9X45MM*	500	51681.039.045	ST4,8X25MM	200	51681.048.025	ST5,5X70MM*	200	51681.055.070
ST3,9X50MM*	500	51681.039.050	ST4,8X32MM	200	51681.048.032	ST5,5X80MM*	200	51681.055.080
			ST4,8X38MM	200	51681.048.038	ST5,5X100MM*	200	51681.055.100
ST4,2X9,5MM*	1000	51681.042.009	ST4,8X45MM	200	51681.048.045			
ST4,2X13MM	200	51681.042.013	ST4,8X50MM	200	51681.048.050	ST6,3X16MM*	500	51681.063.016
ST4,2X16MM	200	51681.042.016	ST4,8X60MM	200	51681.048.060	ST6,3X19MM*	500	51681.063.019
ST4,2X19MM	200	51681.042.019	ST4,8X70MM	200	51681.048.070	ST6,3X22MM*	500	51681.063.022
ST4,2X22MM*	1000	51681.042.022	ST4,8X80MM*	200	51681.048.080	ST6,3X25MM	100	51681.063.025
ST4,2X25MM	200	51681.042.025	ST4,8X90MM*	200	51681.048.090	ST6,3X32MM	100	51681.063.032
ST4,2X32MM	200	51681.042.032	ST4,8X100MM*	200	51681.048.100	ST6,3X38MM	100	51681.063.038
ST4,2X38MM	200	51681.042.038				ST6,3X45MM	100	51681.063.045
ST4,2X45MM	200	51681.042.045	ST5,5X13MM*	1000	51681.055.013	ST6,3X50MM	100	51681.063.050
ST4,2X50MM	200	51681.042.050	ST5,5X16MM*	1000	51681.055.016	ST6,3X60MM*	200	51681.063.060
ST4,2X60MM*	200	51681.042.060	ST5,5X19MM	200	51681.055.019	ST6,3X70MM*	200	51681.063.070
ST4,2X70MM*	200	51681.042.070	ST5,5X22MM*	1000	51681.055.022	ST6,3X80MM*	200	51681.063.080
			ST5,5X25MM*	500	51681.055.025			

55680 Cross recessed countersunk head tapping screw Phillips					R41A
Thread	Self tapping thread	DIN	7982 C-H		
Material	Stainless steel A4	ISO	7050 C-H		

d x L	☒	Art.number	d x L	☒	Art.number	d x L	☒	Art.number
ST2,2X6,5MM*	1000	55680.022.006	ST3,9X38MM*	500	55680.039.038	ST4,8X90MM*	200	55680.048.090
ST2,2X9,5MM*	1000	55680.022.009	ST3,9X45MM*	500	55680.039.045	ST4,8X100MM*	200	55680.048.100
ST2,2X19MM*	1000	55680.022.019	ST3,9X50MM*	500	55680.039.050			
						ST5,5X13MM*	1000	55680.055.013
ST2,9X6,5MM*	1000	55680.029.006	ST4,2X9,5MM*	1000	55680.042.009	ST5,5X16MM	200	55680.055.016
ST2,9X9,5MM	200	55680.029.009	ST4,2X13MM	200	55680.042.013	ST5,5X19MM	200	55680.055.019
ST2,9X13MM	200	55680.029.013	ST4,2X16MM	200	55680.042.016	ST5,5X22MM	200	55680.055.022
ST2,9X16MM	200	55680.029.016	ST4,2X19MM	200	55680.042.019	ST5,5X25MM	200	55680.055.025
ST2,9X19MM	200	55680.029.019	ST4,2X22MM	200	55680.042.022	ST5,5X32MM	100	55680.055.032
ST2,9X22MM*	1000	55680.029.022	ST4,2X25MM	200	55680.042.025	ST5,5X38MM	100	55680.055.038
ST2,9X25MM	200	55680.029.025	ST4,2X32MM	200	55680.042.032	ST5,5X45MM	100	55680.055.045
ST2,9X32MM*	1000	55680.029.032	ST4,2X38MM	200	55680.042.038	ST5,5X50MM	100	55680.055.050
			ST4,2X45MM*	500	55680.042.045	ST5,5X60MM*	200	55680.055.060
ST3,5X6,5MM*	1000	55680.035.006	ST4,2X50MM*	200	55680.042.050	ST5,5X70MM*	200	55680.055.070
ST3,5X9,5MM	200	55680.035.009	ST4,2X60MM*	200	55680.042.060	ST5,5X80MM*	200	55680.055.080
ST3,5X13MM	200	55680.035.013	ST4,2X70MM*	200	55680.042.070	ST5,5X100MM*	200	55680.055.100
ST3,5X16MM	200	55680.035.016						
ST3,5X19MM	200	55680.035.019	ST4,8X9,5MM*	1000	55680.048.009	ST6,3X13MM*	500	55680.063.013
ST3,5X22MM	200	55680.035.022	ST4,8X13MM*	1000	55680.048.013	ST6,3X16MM	100	55680.063.016
ST3,5X25MM	200	55680.035.025	ST4,8X16MM	200	55680.048.016	ST6,3X19MM	100	55680.063.019
ST3,5X32MM	200	55680.035.032	ST4,8X19MM	200	55680.048.019	ST6,3X22MM	100	55680.063.022
ST3,5X38MM*	1000	55680.035.038	ST4,8X22MM	200	55680.048.022	ST6,3X25MM	100	55680.063.025
			ST4,8X25MM	200	55680.048.025	ST6,3X32MM	100	55680.063.032
ST3,9X9,5MM*	1000	55680.039.009	ST4,8X32MM	200	55680.048.032	ST6,3X38MM	100	55680.063.038
ST3,9X13MM	200	55680.039.013	ST4,8X38MM	200	55680.048.038	ST6,3X45MM	100	55680.063.045
ST3,9X16MM	200	55680.039.016	ST4,8X45MM*	200	55680.048.045	ST6,3X50MM	100	55680.063.050
ST3,9X19MM	200	55680.039.019	ST4,8X50MM*	200	55680.048.050	ST6,3X60MM*	200	55680.063.060
ST3,9X22MM	200	55680.039.022	ST4,8X60MM*	200	55680.048.060	ST6,3X70MM*	200	55680.063.070
ST3,9X25MM	200	55680.039.025	ST4,8X70MM*	200	55680.048.070	ST6,3X80MM*	200	55680.063.080
ST3,9X32MM*	1000	55680.039.032	ST4,8X80MM*	200	55680.048.080	ST6,3X90MM*	200	55680.063.090

55681 Cross recessed countersunk head tapping screw Pozidriv					R41A
Thread	Self tapping thread	DIN	7982 C-Z		
Material	Stainless steel A4	ISO	7050 C-Z		
		NF	E25-656 C		

d x L	☒	Art.number	d x L	☒	Art.number	d x L	☒	Art.number
ST2,2X6,5MM*	1000	55681.022.006	ST2,9X9,5MM*	1000	55681.029.009	ST3,5X6,5MM*	1000	55681.035.006
ST2,2X9,5MM*	1000	55681.022.009	ST2,9X13MM*	1000	55681.029.013	ST3,5X9,5MM*	1000	55681.035.009
ST2,2X13MM*	1000	55681.022.013	ST2,9X16MM*	1000	55681.029.016	ST3,5X13MM*	1000	55681.035.013
ST2,2X16MM*	1000	55681.022.016	ST2,9X19MM*	1000	55681.029.019	ST3,5X16MM*	1000	55681.035.016
ST2,2X19MM*	1000	55681.022.019	ST2,9X22MM*	1000	55681.029.022	ST3,5X19MM*	1000	55681.035.019
			ST2,9X25MM*	1000	55681.029.025	ST3,5X22MM*	1000	55681.035.022
ST2,9X6,5MM*	1000	55681.029.006	ST2,9X32MM*	1000	55681.029.032			

55681 Cross recessed countersunk head tapping screw Pozidriv								
d x L	☒	Art.number	d x L	☒	Art.number	d x L	☒	Art.number
ST3,5X25MM*	1000	55681.035.025	ST4,2X50MM*	200	55681.042.050	ST5,5X38MM*	500	55681.055.038
ST3,5X32MM*	1000	55681.035.032	ST4,2X60MM*	200	55681.042.060	ST5,5X45MM*	200	55681.055.045
ST3,5X38MM*	1000	55681.035.038				ST5,5X50MM*	200	55681.055.050
			ST4,8X9MM*	1000	55681.048.009	ST5,5X60MM*	200	55681.055.060
ST3,9X9,5MM*	1000	55681.039.009	ST4,8X13MM*	1000	55681.048.013	ST5,5X70MM*	200	55681.055.070
ST3,9X13MM*	1000	55681.039.013	ST4,8X16MM*	1000	55681.048.016	ST5,5X80MM*	200	55681.055.080
ST3,9X16MM*	1000	55681.039.016	ST4,8X19MM*	1000	55681.048.019	ST5,5X90MM*	200	55681.055.090
ST3,9X19MM*	1000	55681.039.019	ST4,8X22MM*	1000	55681.048.022	ST5,5X100MM*	200	55681.055.100
ST3,9X22MM*	1000	55681.039.022	ST4,8X25MM*	500	55681.048.025			
ST3,9X25MM*	1000	55681.039.025	ST4,8X32MM*	500	55681.048.032	ST6,3X13MM*	500	55681.063.013
ST3,9X32MM*	1000	55681.039.032	ST4,8X38MM*	500	55681.048.038	ST6,3X16MM*	500	55681.063.016
ST3,9X38MM*	500	55681.039.038	ST4,8X45MM*	200	55681.048.045	ST6,3X19MM*	500	55681.063.019
ST3,9X50MM*	500	55681.039.050	ST4,8X50MM*	200	55681.048.050	ST6,3X22MM*	500	55681.063.022
			ST4,8X60MM*	200	55681.048.060	ST6,3X25MM*	200	55681.063.025
ST4,2X9,5MM*	1000	55681.042.009	ST4,8X70MM*	200	55681.048.070	ST6,3X32MM*	200	55681.063.032
ST4,2X13MM*	1000	55681.042.013	ST4,8X80MM*	200	55681.048.080	ST6,3X38MM*	200	55681.063.038
ST4,2X16MM*	1000	55681.042.016				ST6,3X45MM*	200	55681.063.045
ST4,2X19MM*	1000	55681.042.019	ST5,5X13MM*	1000	55681.055.013	ST6,3X50MM*	200	55681.063.050
ST4,2X22MM*	1000	55681.042.022	ST5,5X16MM*	1000	55681.055.016	ST6,3X60MM*	200	55681.063.060
ST4,2X25MM*	1000	55681.042.025	ST5,5X19MM*	1000	55681.055.019	ST6,3X70MM*	200	55681.063.070
ST4,2X32MM*	500	55681.042.032	ST5,5X22MM*	1000	55681.055.022	ST6,3X80MM*	200	55681.063.080
ST4,2X38MM*	500	55681.042.038	ST5,5X25MM*	500	55681.055.025	ST6,3X90MM*	200	55681.063.090
ST4,2X45MM*	500	55681.042.045	ST5,5X32MM*	500	55681.055.032	ST6,3X100MM*	200	55681.063.100

Hexalobular socket countersunk head tapping screw

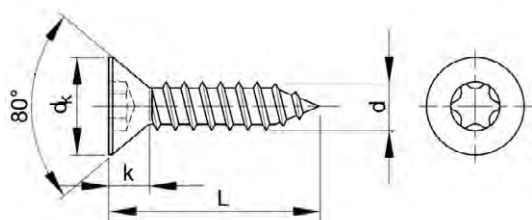

ISO 14586 C
DIN ≈7982 C

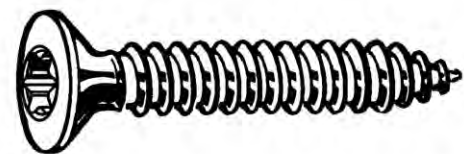

6

Technical Data				
d	dk	k ≈	P	Socket
ST2.2	4.3	1.3	0.8	T6
ST2.9	5.5	1.7	1.1	T10
ST3.5	7.3	2.35	1.3	T15
ST3.9 (#ISO)	7.5	2.3	1.3	T20
ST4.2	8.4	2.6	1.4	T20
ST4.8	9.3	2.8	1.6	T25
ST5.5	10.3	3	1.8	T25
ST6.3	11.3	3.15	1.8	T30

Article groups					
Thread	Driving features	Material	Surface treatment	Code	Page
ST	Hexalobular	St	Zipl	26521	6-91
ST	Hexalobular	St.St. A2		51683	6-92
ST	Hexalobular	St.St. A4		55683	6-92

26521 Hexalobular socket countersunk head tapping screw			J03A
Thread	Self tapping thread		
Material	Steel		
Surface treatment	Zinc plated		

d x L	☒	Art.number	d x L	☒	Art.number	d x L	☒	Art.number
ST2,9X9,5MM	200	26521.029.009	ST3,5X32MM	200	26521.035.032	ST4,2X9,5MM	500	26521.042.009
ST2,9X13MM	200	26521.029.013	ST3,5X38MM	200	26521.035.038	ST4,2X13MM	500	26521.042.013
ST2,9X16MM	500	26521.029.016				ST4,2X16MM	500	26521.042.016
ST2,9X19MM	500	26521.029.019	ST3,9X9,5MM	200	26521.039.009	ST4,2X19MM	200	26521.042.019
			ST3,9X16MM	500	26521.039.016	ST4,2X22MM	500	26521.042.022
ST3,5X9,5MM	1000	26521.035.009	ST3,9X19MM	500	26521.039.019	ST4,2X25MM	500	26521.042.025
ST3,5X13MM	1000	26521.035.013	ST3,9X22MM	500	26521.039.022	ST4,2X32MM	200	26521.042.032
ST3,5X16MM	200	26521.035.016	ST3,9X25MM	500	26521.039.025	ST4,2X38MM	200	26521.042.038
ST3,5X19MM	200	26521.035.019	ST3,9X32MM	500	26521.039.032	ST4,2X45MM	200	26521.042.045
ST3,5X22MM	500	26521.035.022	ST3,9X38MM	200	26521.039.038	ST4,2X50MM	200	26521.042.050
ST3,5X25MM	500	26521.035.025						

26521 Hexalobular socket countersunk head tapping screw ←

d x L	☒	Art.number	d x L	☒	Art.number	d x L	☒	Art.number
ST4,8X16MM	500	26521.048.016	ST4,8X38MM	200	26521.048.038	ST6,3X45MM	100	26521.063.045
ST4,8X19MM	200	26521.048.019	ST4,8X45MM	200	26521.048.045	ST6,3X50MM	100	26521.063.050
ST4,8X22MM	500	26521.048.022	ST4,8X50MM	100	26521.048.050			
ST4,8X25MM	200	26521.048.025						
ST4,8X32MM	200	26521.048.032	ST5,5X45MM	100	26521.055.045			

• Warning: electro-galvanizing of these products may cause hydrogen embrittlement.

51683 Hexalobular socket countersunk head tapping screw R03A

Thread Self tapping thread
Material Stainless steel A2

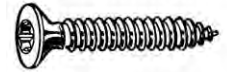

d x L	☒	Art.number	d x L	☒	Art.number	d x L	☒	Art.number
ST2,2X6,5MM*	1000	51683.022.006	ST3,9X9,5MM*	1000	51683.039.009	ST4,8X45MM*	200	51683.048.045
ST2,2X9,5MM*	1000	51683.022.009	ST3,9X13MM*	1000	51683.039.013	ST4,8X50MM*	200	51683.048.050
ST2,2X13MM*	1000	51683.022.013	ST3,9X16MM*	1000	51683.039.016	ST4,8X60MM*	200	51683.048.060
ST2,2X16MM*	1000	51683.022.016	ST3,9X19MM*	1000	51683.039.019			
ST2,2X19MM*	1000	51683.022.019	ST3,9X22MM*	1000	51683.039.022	ST5,5X13MM*	1000	51683.055.013
ST2,2X22MM*	1000	51683.022.022	ST3,9X25MM*	1000	51683.039.025	ST5,5X16MM*	1000	51683.055.016
ST2,2X25MM*	1000	51683.022.025	ST3,9X32MM*	1000	51683.039.032	ST5,5X19MM*	1000	51683.055.019
			ST3,9X38MM*	500	51683.039.038	ST5,5X22MM*	1000	51683.055.022
ST2,9X6,5MM*	1000	51683.029.006	ST3,9X45MM*	500	51683.039.045	ST5,5X25MM*	500	51683.055.025
ST2,9X9,5MM*	1000	51683.029.009	ST3,9X50MM*	500	51683.039.050	ST5,5X32MM*	500	51683.055.032
ST2,9X13MM*	1000	51683.029.013				ST5,5X38MM*	500	51683.055.038
ST2,9X16MM*	1000	51683.029.016	ST4,2X9,5MM*	1000	51683.042.009	ST5,5X45MM*	200	51683.055.045
ST2,9X19MM*	1000	51683.029.019	ST4,2X13MM*	1000	51683.042.013	ST5,5X50MM*	200	51683.055.050
ST2,9X22MM*	1000	51683.029.022	ST4,2X16MM*	1000	51683.042.016	ST5,5X60MM*	200	51683.055.060
ST2,9X25MM*	1000	51683.029.025	ST4,2X19MM*	1000	51683.042.019	ST5,5X70MM*	200	51683.055.070
ST2,9X32MM*	1000	51683.029.032	ST4,2X22MM*	1000	51683.042.022	ST5,5X80MM*	200	51683.055.080
			ST4,2X25MM*	1000	51683.042.025			
ST3,5X6,5MM*	1000	51683.035.006	ST4,2X32MM*	500	51683.042.032	ST6,3X13MM*	500	51683.063.013
ST3,5X9,5MM*	1000	51683.035.009	ST4,2X38MM*	500	51683.042.038	ST6,3X16MM*	500	51683.063.016
ST3,5X13MM*	1000	51683.035.013	ST4,2X45MM*	500	51683.042.045	ST6,3X19MM*	500	51683.063.019
ST3,5X16MM*	1000	51683.035.016	ST4,2X50MM*	200	51683.042.050	ST6,3X22MM*	500	51683.063.022
ST3,5X19MM*	1000	51683.035.019				ST6,3X25MM*	200	51683.063.025
ST3,5X22MM*	1000	51683.035.022	ST4,8X9,5MM*	1000	51683.048.009	ST6,3X32MM*	200	51683.063.032
ST3,5X25MM*	1000	51683.035.025	ST4,8X13MM*	1000	51683.048.013	ST6,3X38MM*	200	51683.063.038
ST3,5X32MM*	1000	51683.035.032	ST4,8X16MM*	1000	51683.048.016	ST6,3X45MM*	200	51683.063.045
ST3,5X38MM*	1000	51683.035.038	ST4,8X19MM*	1000	51683.048.019	ST6,3X50MM*	200	51683.063.050
ST3,5X45MM*	500	51683.035.045	ST4,8X22MM*	1000	51683.048.022	ST6,3X60MM*	200	51683.063.060
ST3,5X50MM*	500	51683.035.050	ST4,8X25MM*	500	51683.048.025	ST6,3X70MM*	200	51683.063.070
			ST4,8X32MM*	500	51683.048.032	ST6,3X80MM*	200	51683.063.080
ST3,9X6,5MM*	1000	51683.039.006	ST4,8X38MM*	500	51683.048.038			

55683 Hexalobular socket countersunk head tapping screw R43A

Thread Self tapping thread
Material Stainless steel A4

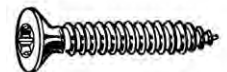

d x L	☒	Art.number	d x L	☒	Art.number	d x L	☒	Art.number
ST2,2X6,5MM*	1000	55683.022.006	ST3,5X22MM*	1000	55683.035.022	ST4,2X16MM*	1000	55683.042.016
ST2,2X9,5MM*	1000	55683.022.009	ST3,5X25MM*	1000	55683.035.025	ST4,2X19MM*	1000	55683.042.019
ST2,2X13MM*	1000	55683.022.013	ST3,5X32MM*	1000	55683.035.032	ST4,2X22MM*	1000	55683.042.022
ST2,2X16MM*	1000	55683.022.016	ST3,5X38MM*	1000	55683.035.038	ST4,2X25MM*	1000	55683.042.025
ST2,2X19MM*	1000	55683.022.019	ST3,5X45MM*	500	55683.035.045	ST4,2X32MM*	500	55683.042.032
ST2,2X25MM*	1000	55683.022.025	ST3,5X50MM*	500	55683.035.050	ST4,2X38MM*	500	55683.042.038
						ST4,2X45MM*	500	55683.042.045
ST2,9X6,5MM*	1000	55683.029.006	ST3,9X6,5MM*	1000	55683.039.006	ST4,2X50MM*	200	55683.042.050
ST2,9X9,5MM*	1000	55683.029.009	ST3,9X9,5MM*	1000	55683.039.009	ST4,2X60MM*	200	55683.042.060
ST2,9X13MM*	1000	55683.029.013	ST3,9X13MM*	1000	55683.039.013			
ST2,9X16MM*	1000	55683.029.016	ST3,9X16MM*	1000	55683.039.016	ST4,8X9,5MM*	1000	55683.048.009
ST2,9X19MM*	1000	55683.029.019	ST3,9X19MM*	1000	55683.039.019	ST4,8X13MM*	1000	55683.048.013
ST2,9X22MM*	1000	55683.029.022	ST3,9X22MM*	1000	55683.039.022	ST4,8X16MM*	1000	55683.048.016
ST2,9X25MM*	1000	55683.029.025	ST3,9X25MM*	1000	55683.039.025	ST4,8X19MM*	1000	55683.048.019
ST2,9X32MM*	1000	55683.029.032	ST3,9X32MM*	1000	55683.039.032	ST4,8X22MM*	1000	55683.048.022
			ST3,9X38MM*	500	55683.039.038	ST4,8X25MM*	500	55683.048.025
ST3,5X6,5MM*	1000	55683.035.006	ST3,9X45MM*	500	55683.039.045	ST4,8X32MM*	500	55683.048.032
ST3,5X9,5MM*	1000	55683.035.009	ST3,9X50MM*	500	55683.039.050	ST4,8X38MM*	500	55683.048.038
ST3,5X13MM*	1000	55683.035.013				ST4,8X45MM*	200	55683.048.045
ST3,5X16MM*	1000	55683.035.016	ST4,2X9,5MM*	1000	55683.042.009	ST4,8X50MM*	200	55683.048.050
ST3,5X19MM*	1000	55683.035.019	ST4,2X13MM*	1000	55683.042.013	ST4,8X60MM*	200	55683.048.060

55683 Hexalobular socket countersunk head tapping screw								
d x L	☒	Art.number	d x L	☒	Art.number	d x L	☒	Art.number
ST5,5X13MM*	1000	55683.055.013	ST5,5X50MM*	200	55683.055.050	ST6,3X25MM*	200	55683.063.025
ST5,5X16MM*	1000	55683.055.016	ST5,5X60MM*	200	55683.055.060	ST6,3X32MM*	200	55683.063.032
ST5,5X19MM*	1000	55683.055.019	ST5,5X70MM*	200	55683.055.070	ST6,3X38MM*	200	55683.063.038
ST5,5X22MM*	1000	55683.055.022	ST5,5X80MM*	200	55683.055.080	ST6,3X45MM*	200	55683.063.045
ST5,5X25MM*	500	55683.055.025	ST6,3X13MM*	500	55683.063.013	ST6,3X50MM*	200	55683.063.050
ST5,5X32MM*	500	55683.055.032	ST6,3X16MM*	500	55683.063.016	ST6,3X60MM*	200	55683.063.060
ST5,5X38MM*	500	55683.055.038	ST6,3X19MM*	500	55683.063.019	ST6,3X70MM*	200	55683.063.070
ST5,5X45MM*	200	55683.055.045	ST6,3X22MM*	500	55683.063.022	ST6,3X80MM*	200	55683.063.080

Square recessed countersunk head tapping screw

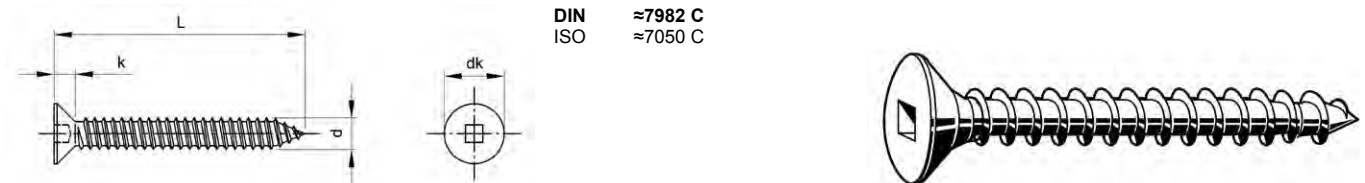

Technical Data				
d	d _k	k ≈	No. square	P
ST3.9	7.5	2.3	1	1.4
ST4.2	8.1	2.5	2	1.4
ST4.8	9.5	3	2	1.6

6

51864 Square recessed countersunk head tapping screw		R03A
Thread	Self tapping thread	
Material	Stainless steel A2	

d x L	☒	Art.number	d x L	☒	Art.number	d x L	☒	Art.number
ST3,9X16MM*	200	51864.039.016	ST4,2X19MM*	200	51864.042.019	ST4,8X32MM*	200	51864.048.032
ST3,9X19MM*	200	51864.039.019	ST4,2X32MM*	200	51864.042.032	ST4,8X38MM*	200	51864.048.038
ST3,9X25MM*	200	51864.039.025	ST4,2X38MM*	200	51864.042.038	ST4,8X45MM*	200	51864.048.045
ST3,9X32MM*	200	51864.039.032	ST4,2X45MM*	200	51864.042.045	ST4,8X50MM*	200	51864.048.050
ST3,9X50MM*	200	51864.039.050	ST4,2X50MM*	200	51864.042.050	ST4,8X60MM*	200	51864.048.060
ST4,2X13MM*	200	51864.042.013	ST4,8X16MM*	200	51864.048.016	ST4,8X70MM*	200	51864.048.070
ST4,2X25MM*	200	51864.042.015	ST4,8X19MM*	200	51864.048.019	ST4,8X80MM*	200	51864.048.080
ST4,2X16MM*	200	51864.042.016	ST4,8X25MM*	200	51864.048.025	ST4,8X95MM*	200	51864.048.095

Cross recessed raised countersunk head tapping screw

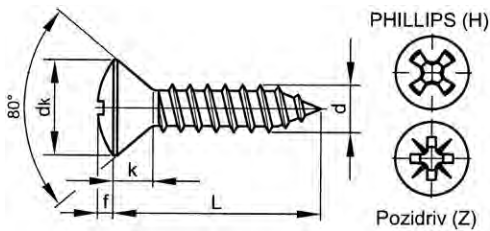

DIN 7983
ISO 7051
NF E25-657

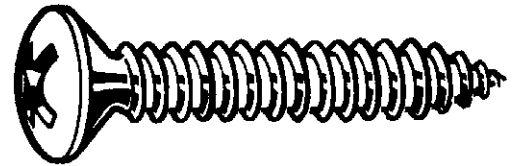

Technical Data

d	d _k	f ≈	k ≈	No. cross recess	P
ST2.2	4.3	0.7	1.3	1	0.8
ST2.9	5.5	0.9	1.7	1	1.1
ST3.5	6.8	1.2	2.1	2	1.3
ST3.9	7.5	1.3	2.3	2	1.4
ST4.2	8.1	1.4	2.5	2	1.4
ST4.8	9.5	1.5	3	2	1.6
ST5.5	10.8	1.7	3.4	3	1.8
ST6.3	12.4	2	3.8	3	1.8

Article groups

Thread	Driving features	Material	Surface treatment	Code	Page
ST	Phillips	St	Zipl	26700	6-94
ST	Pozidriv	St	Zipl	26780	6-95
ST	Phillips	St	Zipl blk p.	26450	6-95
ST	Pozidriv	St	Zipl blk p.	26452	6-95
ST	Phillips	St	Ni.pl.	26240	6-96
ST	Phillips	St.St. A2		51690	6-96
ST	Pozidriv	St.St. A2		51689	6-96
ST	Phillips	St.St. A4		55690	6-97
ST	Pozidriv	St.St. A4		55689	6-97

6

26700 Cross recessed raised countersunk head tapping screw Phillips				J01B
Thread	Self tapping thread	DIN	7983 C-H	
Material	Steel	ISO	7051 C-H	
Surface treatment	Zinc plated			



d x L	☒	Art.number	d x L	☒	Art.number	d x L	☒	Art.number
ST2,9X9,5MM	200	26700.029.009	ST3,9X22MM	200	26700.039.022	ST4,8X45MM	100	26700.048.045
ST2,9X13MM	200	26700.029.013	ST3,9X25MM	200	26700.039.025	ST4,8X50MM	100	26700.048.050
ST2,9X16MM	200	26700.029.016						
ST2,9X19MM	200	26700.029.019	ST4,2X13MM	200	26700.042.013	ST5,5X13MM	200	26700.055.013
ST2,9X22MM	200	26700.029.022	ST4,2X16MM	200	26700.042.016	ST5,5X16MM	200	26700.055.016
ST2,9X25MM	200	26700.029.025	ST4,2X19MM	200	26700.042.019	ST5,5X19MM	200	26700.055.019
			ST4,2X22MM	200	26700.042.022	ST5,5X25MM	100	26700.055.025
ST3,5X9,5MM	200	26700.035.009	ST4,2X25MM	200	26700.042.025	ST5,5X32MM	100	26700.055.032
ST3,5X13MM	200	26700.035.013	ST4,2X32MM	200	26700.042.032	ST5,5X38MM	100	26700.055.038
ST3,5X16MM	200	26700.035.016	ST4,2X38MM	200	26700.042.038	ST5,5X45MM	100	26700.055.045
ST3,5X19MM	200	26700.035.019	ST4,2X45MM	200	26700.042.045	ST5,5X50MM	100	26700.055.050
ST3,5X22MM	200	26700.035.022	ST4,2X50MM	200	26700.042.050			
ST3,5X25MM	200	26700.035.025				ST6,3X16MM	100	26700.063.016
ST3,5X32MM	200	26700.035.032	ST4,8X13MM	200	26700.048.013	ST6,3X19MM	100	26700.063.019
ST3,5X38MM	200	26700.035.038	ST4,8X16MM	200	26700.048.016	ST6,3X22MM	100	26700.063.022
			ST4,8X19MM	200	26700.048.019	ST6,3X25MM	100	26700.063.025
ST3,9X9,5MM	200	26700.039.009	ST4,8X22MM	200	26700.048.022	ST6,3X32MM	100	26700.063.032
ST3,9X13MM	200	26700.039.013	ST4,8X25MM	200	26700.048.025	ST6,3X38MM	100	26700.063.038
ST3,9X16MM	200	26700.039.016	ST4,8X32MM	100	26700.048.032	ST6,3X45MM	100	26700.063.045
ST3,9X19MM	200	26700.039.019	ST4,8X38MM	100	26700.048.038	ST6,3X50MM	100	26700.063.050

- Warning: electro-galvanizing of these products may cause hydrogen embrittlement.

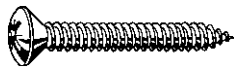
26780 Cross recessed raised countersunk head tapping screw Pozidriv				J01A
Thread	Self tapping thread	DIN	7983 C-Z	
Material	Steel	ISO	7051 C-Z	
Surface treatment	Zinc plated	NF	E25-657 C	

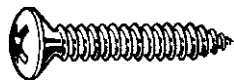

d x L	☒	Art.number	d x L	☒	Art.number	d x L	☒	Art.number
ST2,9X9,5MM	200	26780.029.009	ST3,9X32MM	200	26780.039.032	ST5,5X13MM	200	26780.055.013
ST2,9X13MM	200	26780.029.013	ST4,2X13MM	200	26780.042.013	ST5,5X16MM	200	26780.055.016
ST2,9X16MM	200	26780.029.016	ST4,2X16MM	200	26780.042.016	ST5,5X19MM	200	26780.055.019
ST2,9X19MM	200	26780.029.019	ST4,2X19MM	200	26780.042.019	ST5,5X25MM	100	26780.055.025
ST2,9X25MM	200	26780.029.025	ST4,2X25MM	200	26780.042.025	ST5,5X32MM	100	26780.055.032
ST3,5X9,5MM	200	26780.035.009	ST4,2X32MM	200	26780.042.032	ST5,5X38MM	100	26780.055.038
ST3,5X13MM	200	26780.035.013	ST4,2X38MM	200	26780.042.038	ST5,5X45MM	100	26780.055.045
ST3,5X16MM	200	26780.035.016	ST4,2X45MM	200	26780.042.045	ST5,5X50MM	100	26780.055.050
ST3,5X19MM	200	26780.035.019	ST4,8X13MM	200	26780.048.013	ST6,3X16MM	100	26780.063.016
ST3,5X25MM	200	26780.035.025	ST4,8X16MM	200	26780.048.016	ST6,3X19MM	100	26780.063.019
ST3,5X32MM	200	26780.035.032	ST4,8X19MM	200	26780.048.019	ST6,3X22MM	100	26780.063.022
ST3,5X38MM	200	26780.035.038	ST4,8X25MM	200	26780.048.025	ST6,3X25MM	100	26780.063.025
ST3,9X9,5MM	200	26780.039.009	ST4,8X32MM	100	26780.048.032	ST6,3X32MM	100	26780.063.032
ST3,9X13MM	200	26780.039.013	ST4,8X38MM	100	26780.048.038	ST6,3X38MM	100	26780.063.038
ST3,9X16MM	200	26780.039.016	ST4,8X45MM	100	26780.048.045	ST6,3X45MM	100	26780.063.045
ST3,9X19MM	200	26780.039.019	ST4,8X50MM	100	26780.048.050	ST6,3X50MM	100	26780.063.050
ST3,9X25MM	200	26780.039.025						

26450 Cross recessed raised countersunk head tapping screw Phillips				J03B
Thread	Self tapping thread	DIN	7983 C-H	
Material	Steel	ISO	7051 C-H	
Surface treatment	Zinc plated black passivated			

d x L	☒	Art.number	d x L	☒	Art.number	d x L	☒	Art.number
ST2,9X9,5MM	200	26450.029.009	ST3,9X9,5MM	200	26450.039.009	ST4,8X16MM	200	26450.048.016
ST2,9X13MM	200	26450.029.013	ST3,9X13MM	200	26450.039.013	ST4,8X19MM	200	26450.048.019
ST2,9X16MM	200	26450.029.016	ST3,9X16MM	200	26450.039.016	ST4,8X25MM	200	26450.048.025
ST2,9X19MM	200	26450.029.019	ST3,9X19MM	200	26450.039.019	ST4,8X32MM	100	26450.048.032
ST2,9X25MM	200	26450.029.025	ST3,9X25MM	200	26450.039.025	ST4,8X38MM	100	26450.048.038
ST3,5X9,5MM	200	26450.035.009	ST4,2X13MM	200	26450.042.013	ST4,8X45MM	100	26450.048.045
ST3,5X13MM	200	26450.035.013	ST4,2X16MM	200	26450.042.016	ST4,8X50MM	100	26450.048.050
ST3,5X16MM	200	26450.035.016	ST4,2X19MM	200	26450.042.019	ST5,5X16MM	200	26450.055.016
ST3,5X19MM	200	26450.035.019	ST4,2X25MM	200	26450.042.025	ST5,5X19MM	200	26450.055.019
ST3,5X25MM	200	26450.035.025	ST4,2X32MM	200	26450.042.032	ST5,5X25MM	100	26450.055.025
ST3,5X32MM	200	26450.035.032	ST4,2X38MM	200	26450.042.038	ST5,5X32MM	100	26450.055.032
ST3,5X38MM	200	26450.035.038	ST4,8X13MM	200	26450.048.013	ST5,5X38MM	100	26450.055.038
						ST5,5X50MM	100	26450.055.050

• Warning: electro-galvanizing of these products may cause hydrogen embrittlement.

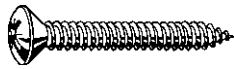
26452 Cross recessed raised countersunk head tapping screw Pozidriv				J03B
Thread	Self tapping thread	DIN	7983 C-Z	
Material	Steel	ISO	7051 C-Z	
Surface treatment	Zinc plated black passivated	NF	E25-657 C	

d x L	☒	Art.number	d x L	☒	Art.number	d x L	☒	Art.number
ST2,9X13MM	200	26452.029.013	ST3,9X19MM	200	26452.039.019	ST4,2X38MM	200	26452.042.038
ST2,9X19MM	200	26452.029.019	ST4,2X13MM	200	26452.042.013	ST4,8X16MM	200	26452.048.016
ST3,5X13MM	200	26452.035.013	ST4,2X16MM	200	26452.042.016	ST4,8X19MM	200	26452.048.019
ST3,5X16MM	200	26452.035.016	ST4,2X19MM	200	26452.042.019	ST4,8X25MM	200	26452.048.025
ST3,5X19MM	200	26452.035.019	ST4,2X25MM	200	26452.042.025	ST4,8X32MM	100	26452.048.032
ST3,5X25MM	200	26452.035.025	ST4,2X32MM	200	26452.042.032	ST4,8X38MM	100	26452.048.038

• Warning: electro-galvanizing of these products may cause hydrogen embrittlement.

26240 Cross recessed raised countersunk head tapping screw Phillips				J03B
Thread	Self tapping thread	DIN	7983 C-H	
Material	Steel	ISO	7051 C-H	
Surface treatment	Nickel plated			



d x L	☒	Art.number	d x L	☒	Art.number	d x L	☒	Art.number
ST2,9X13MM	200	26240.029.013	ST4,2X19MM	200	26240.042.019	ST4,8X38MM	100	26240.048.038
ST2,9X19MM	200	26240.029.019	ST4,2X25MM	200	26240.042.025	ST4,8X50MM	100	26240.048.050
			ST4,2X32MM	200	26240.042.032			
ST3,5X13MM	200	26240.035.013	ST4,2X38MM	200	26240.042.038	ST5,5X19MM	200	26240.055.019
ST3,5X16MM	200	26240.035.016	ST4,2X45MM	200	26240.042.045	ST5,5X25MM	100	26240.055.025
ST3,5X19MM	200	26240.035.019				ST5,5X32MM	100	26240.055.032
ST3,5X25MM	200	26240.035.025	ST4,8X13MM	200	26240.048.013	ST5,5X38MM	100	26240.055.038
ST3,5X32MM	200	26240.035.032	ST4,8X16MM	200	26240.048.016			
			ST4,8X19MM	200	26240.048.019	ST6,3X25MM	100	26240.063.025
ST4,2X13MM	200	26240.042.013	ST4,8X25MM	200	26240.048.025	ST6,3X38MM	100	26240.063.038
ST4,2X16MM	200	26240.042.016	ST4,8X32MM	100	26240.048.032			

• Warning: electro-galvanizing of these products may cause hydrogen embrittlement.

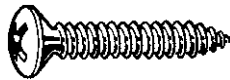
51690 Cross recessed raised countersunk head tapping screw Phillips				R01A
Thread	Self tapping thread	DIN	7983 C-H	
Material	Stainless steel A2	ISO	7051 C-H	
		NF	E25-657 C	



d x L	☒	Art.number	d x L	☒	Art.number	d x L	☒	Art.number
ST2,2X6,5MM*	1000	51690.022.006	ST3,9X22MM	200	51690.039.022	ST4,8X80MM	200	51690.048.080
ST2,2X9,5MM*	1000	51690.022.009	ST3,9X25MM	200	51690.039.025	ST4,8X90MM*	200	51690.048.090
ST2,2X13MM*	1000	51690.022.013	ST3,9X32MM	200	51690.039.032	ST4,8X100MM	100	51690.048.100
ST2,2X16MM*	1000	51690.022.016	ST3,9X38MM	200	51690.039.038	ST4,8X110MM*	200	51690.048.110
ST2,2X19MM*	1000	51690.022.019	ST3,9X45MM*	500	51690.039.045			
ST2,2X25MM*	1000	51690.022.025	ST3,9X50MM*	500	51690.039.050	ST5,5X13MM	200	51690.055.013
			ST3,9X60MM*	500	51690.039.060	ST5,5X16MM	200	51690.055.016
ST2,9X6,5MM	200	51690.029.006	ST3,9X70MM*	500	51690.039.070	ST5,5X19MM	200	51690.055.019
ST2,9X9,5MM	200	51690.029.009				ST5,5X22MM	200	51690.055.022
ST2,9X13MM	200	51690.029.013	ST4,2X9,5MM	200	51690.042.009	ST5,5X25MM	200	51690.055.025
ST2,9X16MM	200	51690.029.016	ST4,2X13MM	200	51690.042.013	ST5,5X32MM	100	51690.055.032
ST2,9X19MM	200	51690.029.019	ST4,2X16MM	200	51690.042.016	ST5,5X38MM	100	51690.055.038
ST2,9X22MM	200	51690.029.022	ST4,2X19MM	200	51690.042.019	ST5,5X45MM	100	51690.055.045
ST2,9X25MM	200	51690.029.025	ST4,2X22MM	200	51690.042.022	ST5,5X50MM	100	51690.055.050
ST2,9X32MM*	1000	51690.029.032	ST4,2X25MM	200	51690.042.025	ST5,5X60MM*	200	51690.055.060
			ST4,2X32MM	200	51690.042.032	ST5,5X70MM*	200	51690.055.070
ST3,5X6,5MM*	1000	51690.035.006	ST4,2X38MM	200	51690.042.038	ST5,5X80MM*	200	51690.055.080
ST3,5X9,5MM	200	51690.035.009	ST4,2X45MM	200	51690.042.045	ST5,5X90MM*	200	51690.055.090
ST3,5X13MM	200	51690.035.013	ST4,2X50MM	200	51690.042.050	ST5,5X100MM*	200	51690.055.100
ST3,5X16MM	200	51690.035.016	ST4,2X60MM	200	51690.042.060			
ST3,5X19MM	200	51690.035.019	ST4,2X70MM*	200	51690.042.070	ST6,3X13MM*	500	51690.063.013
ST3,5X22MM	200	51690.035.022				ST6,3X16MM	100	51690.063.016
ST3,5X25MM	200	51690.035.025	ST4,8X9,5MM	200	51690.048.009	ST6,3X19MM	100	51690.063.019
ST3,5X32MM	200	51690.035.032	ST4,8X13MM	200	51690.048.013	ST6,3X22MM	100	51690.063.022
ST3,5X38MM	200	51690.035.038	ST4,8X16MM	200	51690.048.016	ST6,3X25MM	100	51690.063.025
ST3,5X45MM*	500	51690.035.045	ST4,8X19MM	200	51690.048.019	ST6,3X32MM	100	51690.063.032
ST3,5X50MM*	500	51690.035.050	ST4,8X22MM	200	51690.048.022	ST6,3X38MM	100	51690.063.038
ST3,5X60MM*	500	51690.035.060	ST4,8X25MM	200	51690.048.025	ST6,3X45MM	100	51690.063.045
ST3,5X70MM*	500	51690.035.070	ST4,8X32MM	200	51690.048.032	ST6,3X50MM	100	51690.063.050
			ST4,8X38MM	200	51690.048.038	ST6,3X60MM*	200	51690.063.060
ST3,9X6,5MM*	1000	51690.039.006	ST4,8X45MM	200	51690.048.045	ST6,3X70MM*	200	51690.063.070
ST3,9X9,5MM	200	51690.039.009	ST4,8X50MM	200	51690.048.050	ST6,3X80MM*	200	51690.063.080
ST3,9X13MM	200	51690.039.013	ST4,8X60MM	200	51690.048.060	ST6,3X90MM*	200	51690.063.090
ST3,9X16MM	200	51690.039.016	ST4,8X70MM	200	51690.048.070	ST6,3X100MM*	200	51690.063.100
ST3,9X19MM	200	51690.039.019						

51689 Cross recessed raised countersunk head tapping screw Pozidriv				R01A
Thread	Self tapping thread	DIN	7983 C-Z	
Material	Stainless steel A2	ISO	7051 C-Z	
		NF	E25-657 C	



d x L	☒	Art.number	d x L	☒	Art.number	d x L	☒	Art.number
ST2,2X9,5MM*	1000	51689.022.009	ST2,9X9,5MM	200	51689.029.009	ST2,9X19MM	200	51689.029.019
			ST2,9X13MM	200	51689.029.013	ST2,9X22MM*	1000	51689.029.022
ST2,9X6,5MM*	1000	51689.029.006	ST2,9X16MM	200	51689.029.016	ST2,9X25MM	200	51689.029.025

51689 Cross recessed raised countersunk head tapping screw Pozidriv								
d x L	☒	Art.number	d x L	☒	Art.number	d x L	☒	Art.number
ST2,9X32MM*	1000	51689.029.032	ST4,2X16MM	200	51689.042.016	ST4,8X100MM*	200	51689.048.100
ST3,5X6,5MM*	1000	51689.035.006	ST4,2X19MM	200	51689.042.019	ST5,5X13MM*	1000	51689.055.013
ST3,5X9,5MM*	1000	51689.035.009	ST4,2X22MM*	1000	51689.042.022	ST5,5X16MM*	1000	51689.055.016
ST3,5X13MM	200	51689.035.013	ST4,2X25MM	200	51689.042.025	ST5,5X19MM*	1000	51689.055.019
ST3,5X16MM	200	51689.035.016	ST4,2X32MM	200	51689.042.032	ST5,5X22MM*	1000	51689.055.022
ST3,5X19MM	200	51689.035.019	ST4,2X38MM	200	51689.042.038	ST5,5X25MM	200	51689.055.025
ST3,5X22MM*	1000	51689.035.022	ST4,2X45MM	200	51689.042.045	ST5,5X32MM	100	51689.055.032
ST3,5X25MM	200	51689.035.025	ST4,2X50MM	200	51689.042.050	ST5,5X38MM	100	51689.055.038
ST3,5X32MM	200	51689.035.032	ST4,2X70MM*	200	51689.042.070	ST5,5X45MM	100	51689.055.045
ST3,5X38MM*	1000	51689.035.038	ST4,8X9,5MM*	1000	51689.048.009	ST5,5X50MM	100	51689.055.050
ST3,9X13MM	200	51689.039.013	ST4,8X13MM*	1000	51689.048.013	ST5,5X60MM*	200	51689.055.060
ST3,9X16MM	200	51689.039.016	ST4,8X16MM	200	51689.048.016	ST6,3X16MM	100	51689.063.016
ST3,9X19MM	200	51689.039.019	ST4,8X19MM	200	51689.048.019	ST6,3X19MM*	500	51689.063.019
ST3,9X22MM*	1000	51689.039.022	ST4,8X22MM*	1000	51689.048.022	ST6,3X22MM*	500	51689.063.022
ST3,9X25MM	200	51689.039.025	ST4,8X25MM	200	51689.048.025	ST6,3X25MM	100	51689.063.025
ST3,9X32MM	200	51689.039.032	ST4,8X32MM	200	51689.048.032	ST6,3X32MM	100	51689.063.032
ST3,9X38MM	200	51689.039.038	ST4,8X38MM	200	51689.048.038	ST6,3X38MM	100	51689.063.038
ST3,9X45MM*	500	51689.039.045	ST4,8X45MM	200	51689.048.045	ST6,3X45MM*	200	51689.063.045
ST4,2X9,5MM*	1000	51689.042.009	ST4,8X50MM	200	51689.048.050	ST6,3X50MM	100	51689.063.050
ST4,2X13MM	200	51689.042.013	ST4,8X60MM*	200	51689.048.060	ST6,3X90MM*	200	51689.063.090
			ST4,8X70MM*	200	51689.048.070			
			ST4,8X80MM*	200	51689.048.080			

55690 Cross recessed raised countersunk head tapping screw Phillips					R41A
Thread	Self tapping thread	DIN	7983 C-H		
Material	Stainless steel A4	ISO	7051 C-H		

d x L	☒	Art.number	d x L	☒	Art.number	d x L	☒	Art.number
ST2,2X9,5MM*	1000	55690.022.009	ST3,9X45MM*	500	55690.039.045	ST4,8X70MM*	200	55690.048.070
ST2,9X9,5MM	200	55690.029.009	ST3,9X50MM*	500	55690.039.050	ST5,5X13MM*	1000	55690.055.013
ST2,9X13MM	200	55690.029.013	ST4,2X9,5MM*	1000	55690.042.009	ST5,5X16MM*	1000	55690.055.016
ST2,9X16MM	200	55690.029.016	ST4,2X13MM	200	55690.042.013	ST5,5X19MM	200	55690.055.019
ST2,9X19MM	200	55690.029.019	ST4,2X16MM	200	55690.042.016	ST5,5X22MM*	1000	55690.055.022
ST2,9X22MM*	1000	55690.029.022	ST4,2X19MM	200	55690.042.019	ST5,5X25MM	200	55690.055.025
ST2,9X25MM*	1000	55690.029.025	ST4,2X22MM	200	55690.042.022	ST5,5X32MM*	500	55690.055.032
ST2,9X32MM*	1000	55690.029.032	ST4,2X25MM	200	55690.042.025	ST5,5X38MM	100	55690.055.038
ST3,5X9,5MM	200	55690.035.009	ST4,2X32MM	200	55690.042.032	ST5,5X45MM	100	55690.055.045
ST3,5X13MM	200	55690.035.013	ST4,2X38MM	200	55690.042.038	ST5,5X50MM	100	55690.055.050
ST3,5X16MM	200	55690.035.016	ST4,2X45MM*	500	55690.042.045	ST5,5X70MM*	200	55690.055.070
ST3,5X19MM	200	55690.035.019	ST4,2X50MM*	200	55690.042.050	ST5,5X80MM*	200	55690.055.080
ST3,5X22MM*	1000	55690.035.022	ST4,2X60MM*	200	55690.042.060	ST5,5X90MM*	200	55690.055.090
ST3,5X25MM*	1000	55690.035.025	ST4,2X70MM*	200	55690.042.070	ST6,3X16MM*	500	55690.063.016
ST3,5X32MM*	1000	55690.035.032	ST4,8X13MM*	1000	55690.048.013	ST6,3X19MM*	500	55690.063.019
ST3,5X38MM*	1000	55690.035.038	ST4,8X16MM	200	55690.048.016	ST6,3X22MM*	500	55690.063.022
ST3,9X9,5MM*	1000	55690.039.009	ST4,8X19MM	200	55690.048.019	ST6,3X25MM*	200	55690.063.025
ST3,9X13MM	200	55690.039.013	ST4,8X22MM	200	55690.048.022	ST6,3X32MM*	200	55690.063.032
ST3,9X16MM	200	55690.039.016	ST4,8X25MM	200	55690.048.025	ST6,3X38MM*	200	55690.063.038
ST3,9X19MM	200	55690.039.019	ST4,8X32MM	200	55690.048.032	ST6,3X45MM*	200	55690.063.045
ST3,9X22MM	200	55690.039.022	ST4,8X38MM	200	55690.048.038	ST6,3X50MM*	200	55690.063.050
ST3,9X25MM	200	55690.039.025	ST4,8X45MM*	200	55690.048.045	ST6,3X60MM*	200	55690.063.060
ST3,9X32MM*	1000	55690.039.032	ST4,8X50MM*	200	55690.048.050	ST6,3X70MM*	200	55690.063.070
ST3,9X38MM*	500	55690.039.038	ST4,8X60MM*	200	55690.048.060	ST6,3X80MM*	200	55690.063.080

55689 Cross recessed raised countersunk head tapping screw Pozidriv					R41A
Thread	Self tapping thread	DIN	7983 C-Z		
Material	Stainless steel A4	ISO	7051 C-Z		
		NF	E25-657 C		

d x L	☒	Art.number	d x L	☒	Art.number	d x L	☒	Art.number
ST2,2X9,5MM*	1000	55689.022.009	ST2,9X25MM*	1000	55689.029.025	ST3,5X22MM*	1000	55689.035.022
ST2,2X13MM*	1000	55689.022.013	ST2,9X32MM*	1000	55689.029.032	ST3,5X25MM*	1000	55689.035.025
ST2,9X6,5MM*	1000	55689.029.006	ST3,5X6,5MM*	1000	55689.035.006	ST3,5X32MM*	1000	55689.035.032
ST2,9X9,5MM*	1000	55689.029.009	ST3,5X9,5MM*	1000	55689.035.009	ST3,5X38MM*	1000	55689.035.038
ST2,9X13MM*	1000	55689.029.013	ST3,5X13MM*	1000	55689.035.013	ST3,9X9,5MM*	1000	55689.039.000
ST2,9X16MM*	1000	55689.029.016	ST3,5X16MM*	1000	55689.035.016	ST3,9X13MM*	1000	55689.039.013
ST2,9X19MM*	1000	55689.029.019	ST3,5X19MM*	1000	55689.035.019	ST3,9X16MM*	1000	55689.039.016

55689 Cross recessed raised countersunk head tapping screw Pozidriv

d x L	☒	Art.number	d x L	☒	Art.number	d x L	☒	Art.number
ST3,9X19MM*	1000	55689.039.019	ST4,8X13MM*	1000	55689.048.013	ST5,5X45MM*	200	55689.055.045
ST3,9X22MM*	1000	55689.039.022	ST4,8X16MM*	1000	55689.048.016	ST5,5X50MM*	200	55689.055.050
ST3,9X25MM*	1000	55689.039.025	ST4,8X19MM*	1000	55689.048.019	ST5,5X60MM*	200	55689.055.060
ST3,9X32MM*	1000	55689.039.032	ST4,8X22MM*	1000	55689.048.022	ST5,5X70MM*	200	55689.055.070
ST3,9X38MM*	500	55689.039.038	ST4,8X25MM*	500	55689.048.025	ST5,5X80MM*	200	55689.055.080
ST4,2X9,5MM*	1000	55689.042.009	ST4,8X32MM*	500	55689.048.032	ST6,3X16MM*	500	55689.063.016
ST4,2X13MM*	1000	55689.042.013	ST4,8X38MM*	500	55689.048.038	ST6,3X19MM*	500	55689.063.019
ST4,2X16MM*	1000	55689.042.016	ST4,8X45MM*	200	55689.048.045	ST6,3X25MM*	200	55689.063.025
ST4,2X19MM*	1000	55689.042.019	ST4,8X50MM*	200	55689.048.050	ST6,3X32MM*	200	55689.063.032
ST4,2X22MM*	1000	55689.042.022	ST4,8X60MM*	200	55689.048.060	ST6,3X38MM*	200	55689.063.038
ST4,2X25MM*	1000	55689.042.025	ST4,8X70MM*	200	55689.048.070	ST6,3X45MM*	200	55689.063.045
ST4,2X32MM*	500	55689.042.032	ST5,5X13MM*	1000	55689.055.013	ST6,3X50MM*	200	55689.063.050
ST4,2X38MM*	500	55689.042.038	ST5,5X16MM*	1000	55689.055.016	ST6,3X60MM*	200	55689.063.060
ST4,2X45MM*	500	55689.042.045	ST5,5X19MM*	1000	55689.055.019	ST6,3X70MM*	200	55689.063.070
ST4,2X50MM*	200	55689.042.050	ST5,5X22MM*	1000	55689.055.022	ST6,3X80MM*	200	55689.063.080
ST4,2X60MM*	200	55689.042.060	ST5,5X25MM*	500	55689.055.025	ST6,3X100MM*	200	55689.063.100
ST4,8X9MM*	1000	55689.048.009	ST5,5X32MM*	500	55689.055.032			
			ST5,5X38MM*	500	55689.055.038			

Hexagon head tapping screw

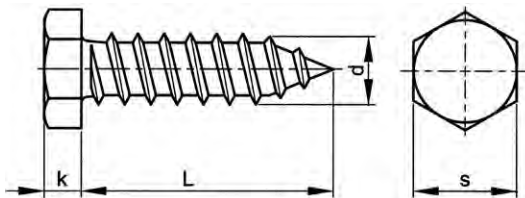

DIN 7976
 ISO 1479
 ASME B18.6.5M
 NF E25-662
 BS 4174

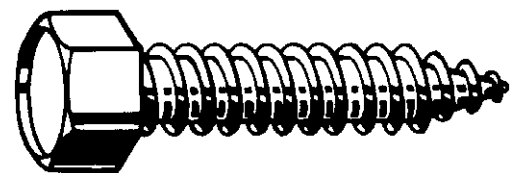

6

Technical Data

d	k	P	s	d	k	P	s
ST2.9	1.5	1.1	5	ST4.8	3	1.6	8
ST3.5	2.3	1.3	5.5	ST5.5	4	1.8	8
ST3.9	2.3	1.3	7	ST6.3	4.8	1.8	10
ST4.2	2.8	1.4	7	ST8	5.8	2.1	13

Article groups

Thread	Driving features	Material	Surface treatment	Code	Page	
ST	Hexagon	St	Zipl	26080	6-98	
ST	Hexagon	St	Zipl	without point	26180	6-99
ST	Hexagon	St.St. A2		51650	6-99	

26080 Hexagon head tapping screw

Thread	Self tapping thread	DIN 7976 C
Material	Steel	ISO 1479 C
Surface treatment	Zinc plated	NF E25-662 C



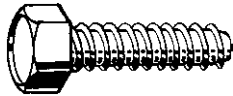

d x L	☒	Art.number	d x L	☒	Art.number	d x L	☒	Art.number
ST4,2X25MM	1000	26080.042.025	ST4,8X50MM	200	26080.048.050	ST6,3X19MM	100	26080.063.019
ST4,8X9,5MM	200	26080.048.009	ST5,5X16MM	250	26080.055.016	ST6,3X25MM	100	26080.063.025
ST4,8X13MM	250	26080.048.013	ST6,3X13MM	100	26080.063.013	ST6,3X32MM	100	26080.063.032
ST4,8X16MM	1000	26080.048.016	ST6,3X16MM	100	26080.063.016	ST6,3X38MM	100	26080.063.038
ST4,8X25MM	100	26080.048.025				ST6,3X45MM	100	26080.063.045
ST4,8X38MM	200	26080.048.038				ST6,3X50MM	100	26080.063.050

• Warning: electro-galvanizing of these products may cause hydrogen embrittlement.

26180 Hexagon head tapping screw without point				J04A	
Thread	Self tapping thread	DIN	7976 F	 	
Material	Steel	ISO	1479 F		
Surface treatment	Zinc plated	NF	E25-662 F		

d x L	☒	Art.number	d x L	☒	Art.number	d x L	☒	Art.number
ST4,8X9,5MM	200	26180.048.009						
ST4,8X13MM	200	26180.048.013	ST6,3X13MM	100	26180.063.013	ST8(7,9)X16MM	100	26180.079.016
ST4,8X16MM	200	26180.048.016	ST6,3X16MM	100	26180.063.016	ST8(7,9)X19MM	100	26180.079.019
ST4,8X19MM	200	26180.048.019	ST6,3X19MM	100	26180.063.019	ST8(7,9)X25MM	100	26180.079.025
ST4,8X25MM	200	26180.048.025	ST6,3X25MM	100	26180.063.025			

• Warning: electro-galvanizing of these products may cause hydrogen embrittlement.

51650 Hexagon head tapping screw				R01A	
Thread	Self tapping thread	DIN	7976 C	 	
Material	Stainless steel A2	ISO	1479 C		
		NF	E25-662 C		

d x L	☒	Art.number	d x L	☒	Art.number	d x L	☒	Art.number
ST2,9X9,5MM*	1000	51650.029.009	ST4,2X38MM*	500	51650.042.038	ST5,5X80MM*	200	51650.055.080
ST2,9X13MM*	1000	51650.029.013	ST4,2X45MM*	500	51650.042.045	ST5,5X90MM*	200	51650.055.090
ST2,9X16MM*	1000	51650.029.016	ST4,2X50MM*	200	51650.042.050			
ST2,9X19MM*	1000	51650.029.019	ST4,2X70MM*	200	51650.042.070	ST6,3X13MM	100	51650.063.013
						ST6,3X16MM	100	51650.063.016
ST3,5X13MM*	1000	51650.035.013	ST4,8X9,5MM*	1000	51650.048.009	ST6,3X19MM	100	51650.063.019
ST3,5X16MM*	1000	51650.035.016	ST4,8X13MM	100	51650.048.013	ST6,3X22MM	100	51650.063.022
ST3,5X19MM*	1000	51650.035.019	ST4,8X16MM	100	51650.048.016	ST6,3X25MM	100	51650.063.025
ST3,5X22MM*	1000	51650.035.022	ST4,8X19MM	100	51650.048.019	ST6,3X32MM*	500	51650.063.032
ST3,5X25MM*	1000	51650.035.025	ST4,8X22MM*	1000	51650.048.022	ST6,3X38MM*	200	51650.063.038
ST3,5X32MM*	1000	51650.035.032	ST4,8X25MM	100	51650.048.025	ST6,3X45MM*	200	51650.063.045
			ST4,8X32MM	500	51650.048.032	ST6,3X50MM	200	51650.063.050
ST3,9X9,5MM*	1000	51650.039.009	ST4,8X38MM*	500	51650.048.038	ST6,3X60MM*	200	51650.063.060
ST3,9X13MM*	1000	51650.039.013	ST4,8X45MM*	200	51650.048.045	ST6,3X70MM*	200	51650.063.070
ST3,9X16MM*	1000	51650.039.016	ST4,8X50MM*	200	51650.048.050	ST6,3X80MM*	200	51650.063.080
ST3,9X19MM*	1000	51650.039.019	ST4,8X60MM*	200	51650.048.060	ST6,3X90MM*	200	51650.063.090
ST3,9X22MM*	1000	51650.039.022	ST4,8X70MM*	200	51650.048.070	ST6,3X100MM*	200	51650.063.100
ST3,9X25MM*	1000	51650.039.025	ST4,8X80MM*	200	51650.048.080	ST6,3X120MM*	200	51650.063.120
ST3,9X32MM*	1000	51650.039.032						
ST3,9X38MM*	500	51650.039.038	ST5,5X13MM*	1000	51650.055.013	ST8,0X16MM*	200	51650.080.016
ST3,9X45MM*	500	51650.039.045	ST5,5X16MM*	1000	51650.055.016	ST8,0X19MM*	200	51650.080.019
ST3,9X50MM*	500	51650.039.050	ST5,5X19MM*	1000	51650.055.019	ST8,0X22MM*	200	51650.080.022
			ST5,5X22MM*	1000	51650.055.022	ST8,0X25MM*	200	51650.080.025
ST4,2X9,5MM*	1000	51650.042.009	ST5,5X25MM*	500	51650.055.025	ST8,0X32MM*	200	51650.080.032
ST4,2X13MM	100	51650.042.013	ST5,5X32MM*	500	51650.055.032	ST8,0X38MM	200	51650.080.038
ST4,2X16MM	100	51650.042.016	ST5,5X38MM*	500	51650.055.038	ST8,0X45MM*	200	51650.080.045
ST4,2X19MM*	1000	51650.042.019	ST5,5X45MM*	200	51650.055.045	ST8,0X50MM*	200	51650.080.050
ST4,2X22MM	100	51650.042.022	ST5,5X50MM*	200	51650.055.050	ST8,0X60MM*	200	51650.080.060
ST4,2X25MM*	1000	51650.042.025	ST5,5X60MM*	200	51650.055.060	ST8,0X70MM*	200	51650.080.070
ST4,2X32MM*	500	51650.042.032	ST5,5X70MM*	200	51650.055.070			

Hexagon washer faced head tapping screw

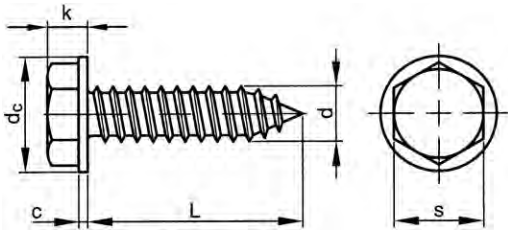

DIN ≈6928 C
 ISO ≈7053 C
 BS ≈7599

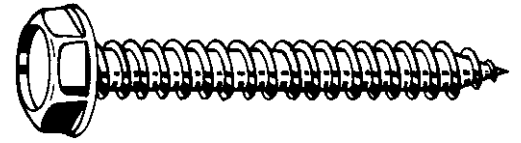

Technical Data

d	c	d _c	k	P	s
ST3.5	0.5	7.2	2.5	1.3	5.5
ST4.2	0.6	9	2.8	1.4	7
ST4.8	0.7	10	3.1	1.6	8

28100 Hexagon washer faced head tapping screw J04A

Thread Self tapping thread
Material Steel
Surface treatment Zinc plated



6

d x L	☒	Art.number	d x L	☒	Art.number	d x L	☒	Art.number
ST3,5X9,5MM	200	28100.035.009	ST4,2X13MM	200	28100.042.013	ST4,8X16MM	200	28100.048.016
ST3,5X13MM	200	28100.035.013	ST4,2X16MM	200	28100.042.016	ST4,8X19MM	200	28100.048.019
ST3,5X16MM	200	28100.035.016	ST4,2X19MM	200	28100.042.019	ST4,8X25MM	200	28100.048.025
ST3,5X19MM	200	28100.035.019	ST4,2X25MM	200	28100.042.025	ST4,8X32MM	200	28100.048.032
ST4,2X9,5MM	200	28100.042.009	ST4,8X13MM	200	28100.048.013			

• Warning: electro-galvanizing of these products may cause hydrogen embrittlement.

Hexagon tapping screw with cone end and captive washer

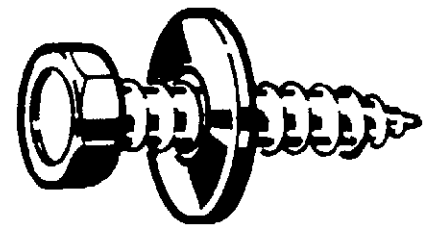
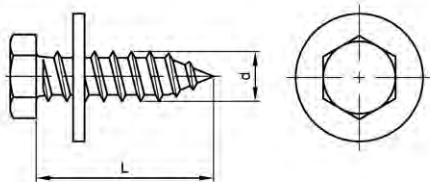

Technical Data

d	Ring ø
ST4.8	12x1.6
ST5.6	14.8x1.6
ST6.5	18x1.6

72045 Hexagon tapping screw with cone end and captive washer Y92D

Thread Self tapping thread
Material Steel
Surface treatment Zinc plated



d x L	☒	Art.number	d x L	☒	Art.number	d x L	☒	Art.number
ST4,8X16MM	200	72045.048.016	ST5,6X13MM	200	72045.056.013	ST6,5X20MM	200	72045.065.020
ST4,8X19MM	200	72045.048.019	ST5,6X16MM	200	72045.056.016	ST6,5X25MM	200	72045.065.025
			ST5,6X19MM	200	72045.056.019			

Tapping screw socket head

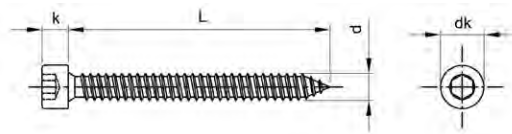

Technical Data

d	d _k	k	s
4.8	8.5	5	4
5.5	10	6	5
6.3	10	6	5

Article groups

Thread	Driving features	Material	Code	Page
ST	Hexagon	St.St. A2	51651	6-101
ST	Hexagon	St.St. A4	55651	6-101

51651 Tapping screw socket head

Q05A

Thread Self tapping thread
Material Stainless steel A2



d x L	☒	Art.number	d x L	☒	Art.number	d x L	☒	Art.number
4,8X9,5MM*	500	51651.048.009	5,5X13MM*	500	51651.055.013	6,3X13MM*	200	51651.063.013
4,8X13MM*	500	51651.048.013	5,5X16MM*	500	51651.055.016	6,3X16MM*	500	51651.063.016
4,8X16MM*	500	51651.048.016	5,5X19MM*	500	51651.055.019	6,3X19MM*	500	51651.063.019
4,8X19MM*	500	51651.048.019	5,5X22MM*	500	51651.055.022	6,3X22MM*	500	51651.063.022
4,8X22MM*	500	51651.048.022	5,5X25MM*	500	51651.055.025	6,3X25MM*	500	51651.063.025
4,8X25MM*	500	51651.048.025	5,5X30MM*	500	51651.055.030	6,3X30MM*	500	51651.063.030
4,8X30MM*	500	51651.048.030	5,5X32MM*	500	51651.055.032	6,3X32MM*	500	51651.063.032
4,8X32MM*	500	51651.048.032	5,5X35MM*	500	51651.055.035	6,3X38MM*	500	51651.063.038
4,8X35MM*	500	51651.048.035	5,5X38MM*	500	51651.055.038	6,3X42MM*	500	51651.063.042
4,8X38MM*	500	51651.048.038	5,5X40MM*	500	51651.055.040	6,3X45MM*	500	51651.063.045
4,8X40MM*	500	51651.048.040	5,5X42MM*	500	51651.055.042	6,3X50MM*	200	51651.063.050
4,8X42MM*	500	51651.048.042	5,5X45MM*	500	51651.055.045	6,3X55MM*	200	51651.063.055
4,8X45MM*	500	51651.048.045	5,5X50MM*	200	51651.055.050	6,3X60MM*	200	51651.063.060
4,8X50MM*	200	51651.048.050	5,5X55MM*	200	51651.055.055	6,3X65MM*	200	51651.063.065
4,8X55MM*	200	51651.048.055	5,5X60MM*	200	51651.055.060	6,3X70MM*	200	51651.063.070
4,8X60MM*	200	51651.048.060	5,5X65MM*	200	51651.055.065	6,3X75MM*	200	51651.063.075
4,8X70MM*	200	51651.048.070	5,5X70MM*	200	51651.055.070	6,3X80MM*	200	51651.063.080
4,8X80MM*	200	51651.048.080	5,5X75MM*	200	51651.055.075	6,3X90MM*	200	51651.063.090
4,8X90MM*	200	51651.048.090	5,5X80MM*	200	51651.055.080	6,3X100MM*	200	51651.063.100
4,8X100MM*	200	51651.048.100	5,5X90MM*	200	51651.055.090			
			5,5X100MM*	200	51651.055.100			

55651 Tapping screw socket head

Q45A

Thread Self tapping thread
Material Stainless steel A4



d x L	☒	Art.number	d x L	☒	Art.number	d x L	☒	Art.number
4,8X13MM*	500	55651.048.013	5,5X19MM*	500	55651.055.019	5,5X75MM*	200	55651.055.075
4,8X16MM*	500	55651.048.016	5,5X22MM*	500	55651.055.022	5,5X90MM*	200	55651.055.090
4,8X19MM*	500	55651.048.019	5,5X25MM*	500	55651.055.025	6,3X13MM*	500	55651.063.013
4,8X22MM*	500	55651.048.022	5,5X30MM*	500	55651.055.030	6,3X16MM*	500	55651.063.016
4,8X25MM*	500	55651.048.025	5,5X32MM*	500	55651.055.032	6,3X19MM*	500	55651.063.019
4,8X32MM*	500	55651.048.032	5,5X38MM*	500	55651.055.038	6,3X25MM*	500	55651.063.025
4,8X38MM*	500	55651.048.038	5,5X42MM*	500	55651.055.042	6,3X32MM*	500	55651.063.032
4,8X45MM*	500	55651.048.045	5,5X45MM*	500	55651.055.045	6,3X45MM*	500	55651.063.045
4,8X70MM*	200	55651.048.070	5,5X50MM*	200	55651.055.050	6,3X50MM*	200	55651.063.050
4,8X100MM*	200	55651.048.100	5,5X55MM*	200	55651.055.055	6,3X55MM*	200	55651.063.055
			5,5X60MM*	200	55651.055.060			
5,5X16MM*	500	55651.055.016	5,5X70MM*	200	55651.055.070	6,3X60MM*	200	55651.063.060

Hexalobular raised countersunk head

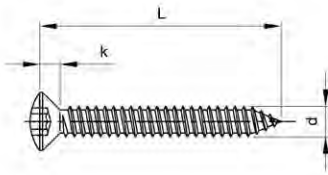

ISO 14587 C
DIN ≈7983 C



Technical Data

d	d _k	k	Socket
2.2 (#ISO)	4.3	1.3	T6
2.9	5.5	1.7	T8
3.5	6.8	2.1	T10
3.9 (#ISO)	7.5	2.3	T15
4.2	8.1	2.5	T20
4.8	9.5	3	T25
5.5	10.8	3.4	T25
6.3	12.4	3.8	T30

Article groups

Thread	Driving features	Material	Code	Page
ST	Hexalobular	St.St. A2	51693	6-102
ST	Hexalobular	St.St. A4	55693	6-103

6

51693 Hexalobular raised countersunk head R03A

Thread Self tapping thread
Material Stainless steel A2





d x L	Art.number	d x L	Art.number	d x L	Art.number
2,2X6,5MM*	1000 51693.022.006	3,9X13MM*	1000 51693.039.013	4,8X60MM*	200 51693.048.060
2,2X9,5MM*	1000 51693.022.009	3,9X16MM*	1000 51693.039.016	4,8X70MM*	200 51693.048.070
2,2X13MM*	1000 51693.022.013	3,9X19MM*	1000 51693.039.019	4,8X80MM*	200 51693.048.080
2,2X16MM*	1000 51693.022.016	3,9X22MM*	1000 51693.039.022		
2,2X19MM*	1000 51693.022.019	3,9X25MM*	1000 51693.039.025	5,5X13MM*	1000 51693.055.013
2,2X22MM*	1000 51693.022.022	3,9X32MM*	1000 51693.039.032	5,5X16MM*	1000 51693.055.016
2,2X25MM*	1000 51693.022.025	3,9X38MM*	500 51693.039.038	5,5X19MM*	1000 51693.055.019
		3,9X45MM*	500 51693.039.045	5,5X22MM*	1000 51693.055.022
2,9X6,5MM*	1000 51693.029.006	3,9X50MM*	500 51693.039.050	5,5X25MM*	500 51693.055.025
2,9X9,5MM*	1000 51693.029.009			5,5X32MM*	500 51693.055.032
2,9X13MM*	1000 51693.029.013	4,2X9,5MM*	1000 51693.042.009	5,5X38MM*	500 51693.055.038
2,9X16MM*	1000 51693.029.016	4,2X13MM*	1000 51693.042.013	5,5X45MM*	200 51693.055.045
2,9X19MM*	1000 51693.029.019	4,2X16MM*	1000 51693.042.016	5,5X60MM*	200 51693.055.060
2,9X22MM*	1000 51693.029.022	4,2X19MM*	1000 51693.042.019	5,5X70MM*	200 51693.055.070
2,9X25MM*	1000 51693.029.025	4,2X22MM*	1000 51693.042.022	5,5X80MM*	200 51693.055.080
2,9X32MM*	1000 51693.029.032	4,2X25MM*	1000 51693.042.025	5,5X50MM*	200 51693.055.950
		4,2X32MM*	500 51693.042.032		
3,5X6,5MM*	1000 51693.035.006	4,2X38MM*	500 51693.042.038	6,3X13MM*	500 51693.063.013
3,5X9,5MM*	1000 51693.035.009	4,2X45MM*	500 51693.042.045	6,3X16MM*	500 51693.063.016
3,5X13MM*	1000 51693.035.013	4,2X50MM*	200 51693.042.050	6,3X19MM*	500 51693.063.019
3,5X16MM*	1000 51693.035.016			6,3X22MM*	500 51693.063.022
3,5X19MM*	1000 51693.035.019	4,8X9MM*	1000 51693.048.009	6,3X25MM*	200 51693.063.025
3,5X22MM*	1000 51693.035.022	4,8X13MM*	1000 51693.048.013	6,3X32MM*	200 51693.063.032
3,5X25MM*	1000 51693.035.025	4,8X16MM*	1000 51693.048.016	6,3X38MM*	200 51693.063.038
3,5X32MM*	1000 51693.035.032	4,8X19MM*	1000 51693.048.019	6,3X45MM*	200 51693.063.045
3,5X38MM*	1000 51693.035.038	4,8X22MM*	1000 51693.048.022	6,3X50MM*	200 51693.063.050
3,5X45MM*	500 51693.035.045	4,8X25MM*	500 51693.048.025	6,3X60MM*	200 51693.063.060
3,5X50MM*	500 51693.035.050	4,8X32MM*	500 51693.048.032	6,3X70MM*	200 51693.063.070
		4,8X38MM*	500 51693.048.038	6,3X80MM*	200 51693.063.080
3,9X6,5MM*	1000 51693.039.006	4,8X45MM*	200 51693.048.045		
3,9X9,5MM*	1000 51693.039.009	4,8X50MM*	200 51693.048.050		

55693 Hexalobular raised countersunk head		R43A
Thread	Self tapping thread	
Material	Stainless steel A4	
		 

d x L	☒	Art.number	d x L	☒	Art.number	d x L	☒	Art.number
2,2X16MM*	1000	55693.022.016	4,2X9,5MM*	1000	55693.042.009	4,8X80MM*	200	55693.048.080
2,9X13MM*	1000	55693.029.013	4,2X13MM*	1000	55693.042.013	5,5X13MM*	1000	55693.055.013
2,9X16MM*	1000	55693.029.016	4,2X16MM*	1000	55693.042.016	5,5X16MM*	1000	55693.055.016
2,9X19MM*	1000	55693.029.019	4,2X19MM*	1000	55693.042.019	5,5X19MM*	1000	55693.055.019
2,9X25MM*	1000	55693.029.025	4,2X22MM*	1000	55693.042.022	5,5X22MM*	1000	55693.055.022
2,9X32MM*	1000	55693.029.032	4,2X25MM*	1000	55693.042.025	5,5X25MM*	500	55693.055.025
3,5X6,5MM*	1000	55693.035.006	4,2X32MM*	500	55693.042.032	5,5X32MM*	500	55693.055.032
3,5X13MM*	1000	55693.035.013	4,2X38MM*	500	55693.042.038	5,5X38MM*	500	55693.055.038
3,5X16MM*	1000	55693.035.016	4,2X45MM*	500	55693.042.045	5,5X45MM*	200	55693.055.045
3,5X19MM*	1000	55693.035.019	4,2X50MM*	200	55693.042.050	5,5X50MM*	200	55693.055.050
3,5X22MM*	1000	55693.035.022	4,2X60MM*	200	55693.042.060	5,5X60MM*	200	55693.055.060
3,5X25MM*	1000	55693.035.025	4,8X13MM*	1000	55693.048.013	5,5X70MM*	200	55693.055.070
3,5X32MM*	1000	55693.035.032	4,8X16MM*	1000	55693.048.016	5,5X80MM*	200	55693.055.080
3,5X38MM*	1000	55693.035.038	4,8X19MM*	1000	55693.048.019	6,3X19MM*	500	55693.063.019
3,5X45MM*	500	55693.035.045	4,8X22MM*	1000	55693.048.022	6,3X25MM*	200	55693.063.025
3,9X16MM*	1000	55693.039.016	4,8X25MM*	500	55693.048.025	6,3X32MM*	200	55693.063.032
3,9X19MM*	1000	55693.039.019	4,8X32MM*	500	55693.048.032	6,3X38MM*	200	55693.063.038
3,9X22MM*	1000	55693.039.022	4,8X38MM*	500	55693.048.038	6,3X50MM*	200	55693.063.050
3,9X32MM*	1000	55693.039.032	4,8X45MM*	200	55693.048.045	6,3X60MM*	200	55693.063.060
3,9X38MM*	500	55693.039.038	4,8X50MM*	200	55693.048.050	6,3X70MM*	200	55693.063.070
3,9X50MM*	500	55693.039.050	4,8X60MM*	200	55693.048.060	6,3X80MM*	200	55693.063.080
			4,8X70MM*	200	55693.048.070			

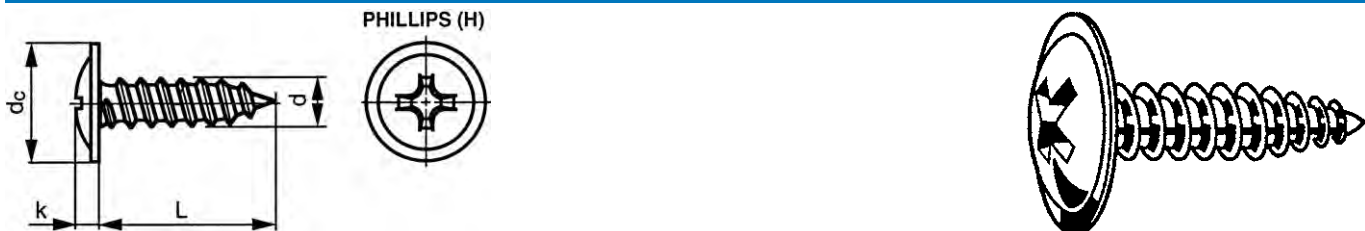
Cross recessed mushroom head tapping screw with flange

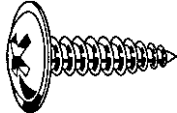

Technical Data				
d	d _c (max.)	k	No. cross recess	P
ST3.5	9	2.3	2	1.3
ST3.9	10	2.5	2	1.4
ST4.2	10	2.6	2	1.4
ST4.8	11.5	2.7	2	1.6

26456 Cross recessed mushroom head tapping screw with flange Phillips		J03A
Thread	Self tapping thread	
Material	Steel	
Surface treatment	Zinc plated black passivated	
		

d x L	☒	Art.number	d x L	☒	Art.number	d x L	☒	Art.number
ST3,5X16MM	100	26456.035.016	ST3,9X25MM	100	26456.039.025	ST4,2X25MM	100	26456.042.025
ST3,9X9,5MM	100	26456.039.009	ST4,2X13MM	100	26456.042.013	ST4,8X13MM	100	26456.048.013
ST3,9X13MM	100	26456.039.013	ST4,2X16MM	100	26456.042.016	ST4,8X16MM	100	26456.048.016
ST3,9X16MM	100	26456.039.016	ST4,2X19MM	100	26456.042.019	ST4,8X19MM	100	26456.048.019
ST3,9X19MM	100	26456.039.019	ST4,2X22MM	100	26456.042.022	ST4,8X25MM	100	26456.048.025

Window screw caphead washer

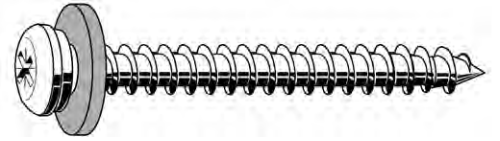
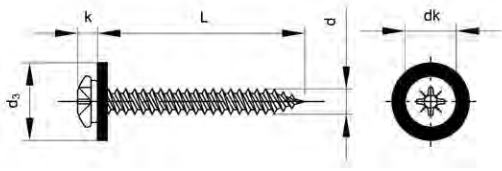

Technical Data

d	d ₃	d _k	k	No. cross recess
3.9	12	7.9	3.1	2

Article groups

Thread	Driving features	Material	Color	Code	Page
ST	Pozidriv	St.St. A2	Natural	51760	6-104
ST	Pozidriv	St.St. A2	White	51764	6-104
ST	Pozidriv	St.St. A2	Brown	51767	6-104

6

51760 Window screw caphead washer natural R03A

Thread	Self tapping thread
Material	Stainless steel A2
Color	Natural



d x L	Art.number	d x L	Art.number	d x L	Art.number
ST3,9X16MM*	1000 51760.039.016	ST3,9X22MM*	1000 51760.039.022	ST3,9X32MM*	1000 51760.039.032
ST3,9X19MM*	1000 51760.039.019	ST3,9X25MM*	1000 51760.039.025		

51764 Window screw caphead washer white R03A

Thread	Self tapping thread
Material	Stainless steel A2
Color	White



d x L	Art.number	d x L	Art.number	d x L	Art.number
ST3,9X16MM*	1000 51764.039.016	ST3,9X22MM*	1000 51764.039.022	ST3,9X32MM*	1000 51764.039.032
ST3,9X19MM*	1000 51764.039.019	ST3,9X25MM*	1000 51764.039.025		

51767 Window screw caphead washer brown R03A

Thread	Self tapping thread
Material	Stainless steel A2
Color	Brown



d x L	Art.number	d x L	Art.number	d x L	Art.number
ST3,9X16MM*	1000 51767.039.016	ST3,9X22MM*	1000 51767.039.022	ST3,9X32MM*	1000 51767.039.032
ST3,9X19MM*	1000 51767.039.019	ST3,9X25MM*	1000 51767.039.025		

Window screw caphead washer

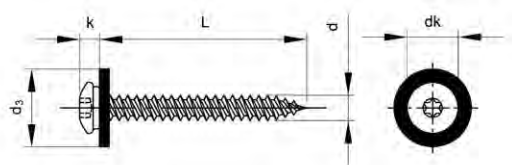

Technical Data

d	d₃	d_k	k	Socket
3.9	12	7.9	3.1	T15

Article groups

Thread	Driving features	Material	Color	Code	Page
ST	Hexalobular	St.St. A2	Natural	51761	6-105
ST	Hexalobular	St.St. A2	White	51765	6-105
ST	Hexalobular	St.St. A2	Brown	51768	6-105

51761	Window screw caphead washer natural	R03A
Thread	Self tapping thread	
Material	Stainless steel A2	
Color	Natural	
		

d x L	Art.number	d x L	Art.number	d x L	Art.number
ST3,9X16MM*	200 51761.039.016	ST3,9X22MM*	200 51761.039.022	ST3,9X32MM*	200 51761.039.032
ST3,9X19MM*	200 51761.039.019	ST3,9X25MM*	200 51761.039.025		

51765	Window screw caphead washer white	R03A
Thread	Self tapping thread	
Material	Stainless steel A2	
Color	White	
		

d x L	Art.number	d x L	Art.number	d x L	Art.number
ST3,9X16MM*	200 51765.039.016	ST3,9X22MM*	200 51765.039.022	ST3,9X32MM*	200 51765.039.032
ST3,9X19MM*	200 51765.039.019	ST3,9X25MM*	200 51765.039.025		

51768	Window screw caphead washer brown	R03A
Thread	Self tapping thread	
Material	Stainless steel A2	
Color	Brown	
		

d x L	Art.number	d x L	Art.number	d x L	Art.number
ST3,9X16MM*	200 51768.039.016	ST3,9X22MM*	200 51768.039.022	ST3,9X32MM*	200 51768.039.032
ST3,9X19MM*	200 51768.039.019	ST3,9X25MM*	200 51768.039.025		

Window sills screw

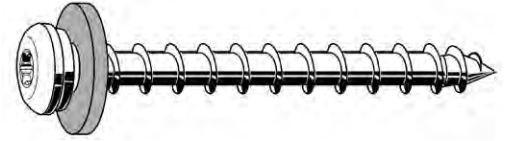
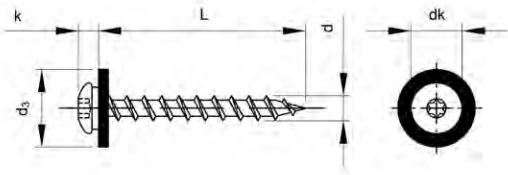

Technical Data

d	d₃	d_k	k	Socket
3.9	12	7.9	3.1	T15

Article groups

Thread	Driving features	Material	Color	Code	Page
CT	Hexalobular	St.St. A2	Natural	51762	6-106
CT	Hexalobular	St.St. A2	White	51766	6-106
CT	Hexalobular	St.St. A2	Brown	51769	6-106

6

51762 Window sills screw natural R03A

Thread	Coarse thread
Material	Stainless steel A2
Color	Natural

d x L	Art.number	d x L	Art.number	d x L	Art.number
ST3,9X16MM*	200 51762.039.016	ST3,9X22MM*	200 51762.039.022	ST3,9X32MM*	200 51762.039.032
ST3,9X19MM*	200 51762.039.019	ST3,9X25MM*	200 51762.039.025		

51766 Window sills screw white R03A

Thread	Coarse thread
Material	Stainless steel A2
Color	White



d x L	Art.number	d x L	Art.number	d x L	Art.number
ST3,9X16MM*	200 51766.039.016	ST3,9X22MM*	200 51766.039.022	ST3,9X32MM*	200 51766.039.032
ST3,9X19MM*	200 51766.039.019	ST3,9X25MM*	200 51766.039.025		

51769 Window sills screw brown R03A

Thread	Coarse thread
Material	Stainless steel A2
Color	Brown



d x L	Art.number	d x L	Art.number	d x L	Art.number
ST3,9X16MM*	200 51769.039.016	ST3,9X22MM*	200 51769.039.022	ST3,9X32MM*	200 51769.039.032
ST3,9X19MM*	200 51769.039.019	ST3,9X25MM*	200 51769.039.025		

Cross recessed screw for back panels

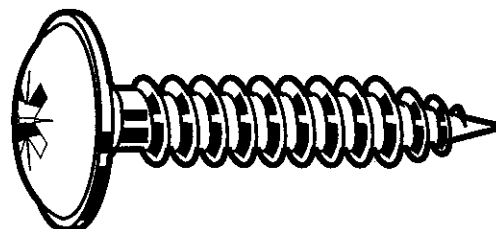
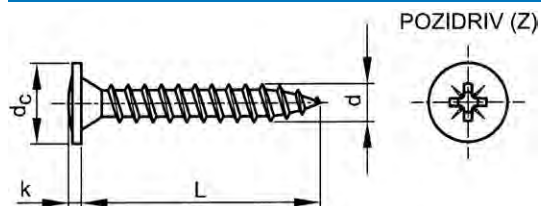

Technical Data

d	d _c	k	No. cross recess
3.5	8	1.4	2
4	9	1.7	2
4.5	10	1.9	2
5	11.5	2.1	2

29570 Cross recessed screw for back panels Pozidriv

K04A

Material Steel
Surface treatment Zinc plated

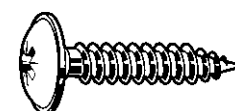

d x L	Art.number	d x L	Art.number	d x L	Art.number
3,5X17MM	200 29570.035.017	4X30MM	200 29570.040.030	4,5X40MM	200 29570.045.040
3,5X20MM	200 29570.035.020	4X35MM	200 29570.040.035	4,5X45MM	200 29570.045.045
3,5X25MM	200 29570.035.025	4X40MM	200 29570.040.040	5X40MM	100 29570.050.040
3,5X30MM	200 29570.035.030			5X60MM	100 29570.050.060
3,5X35MM	200 29570.035.035				

- Heco-fix plus chip board screw thread.
- Depending on availability the dimensions may deviate.

6

Cross recessed tapping screw for license plates



Article groups

Thread	Driving features	Material	Surface treatment	Code	Page	
ST	Phillips	St	Zipl	72008	6-107	
ST	Phillips	St	Zipl	with snap cap	72005	6-108
ST	Pozidriv	St	FLZNNC-NC6	self-drilling	72022	6-108



72008 Cross recessed Phillips (H) tapping screw

Y92D

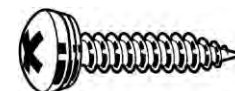
Thread Self tapping thread
Material Steel
Surface treatment Zinc plated



d x L	Art.number	d x L	Art.number	d x L	Art.number
ST4,8X16MM	100 72008.048.016	ST4,8X25MM	100 72008.048.025	ST4,8X32MM	100 72008.048.032
ST4,8X19MM	100 72008.048.020				

72005	Cross recessed Phillips (H) pan head tapping screw with snap cap	Y92D
Thread	Self tapping thread	 
Material	Steel	
Surface treatment	Zinc plated	

d x L	☒	Art.number	d x L	☒	Art.number
4,8X13 WHITE	100	72005.048.013	4,8X19 YELLOW	100	72005.048.019

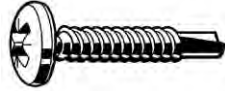
72022	Cross recessed Pozidriv (Z) caphead self-drilling screw Delta-Magni	Y92A
Thread	Self tapping thread	 
Material	Steel	
Surface treatment	Zinc flake Cr ⁶⁺ free - ISO 10683 flZnnc	

d x L	☒	Art.number	d x L	☒	Art.number	d x L	☒	Art.number
5,0X16MM	100	72022.050.016	5,0X19MM	100	72022.050.019	5,0X25MM	100	72022.050.025

Cross recessed caphead tapping screw

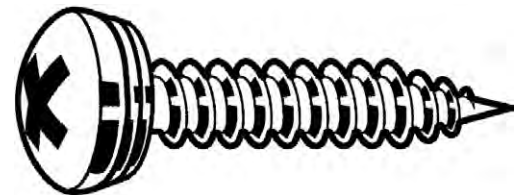
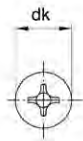
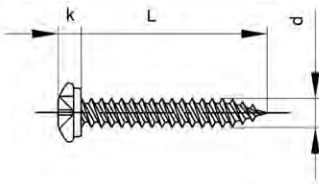

6

Technical Data			
d	d _k	k	No. cross recess
3.9	7.8	1.9	2

51652	Cross recessed tapping screw for license plates Phillips	R03A
Thread	Self tapping thread	 
Material	Stainless steel A2	

d x L	☒	Art.number	d x L	☒	Art.number	d x L	☒	Art.number
ST3,9X9,5MM*	1000	51652.039.009	ST3,9X19MM*	1000	51652.039.019	ST3,9X32MM*	1000	51652.039.032
ST3,9X13MM*	1000	51652.039.013	ST3,9X22MM*	1000	51652.039.022	ST3,9X38MM*	1000	51652.039.038
ST3,9X16MM*	1000	51652.039.016	ST3,9X25MM*	1000	51652.039.025			

Tapping screw caphead hexalobular

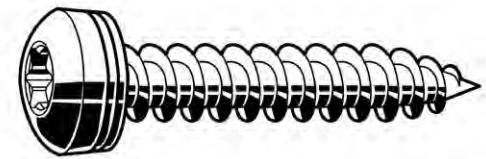
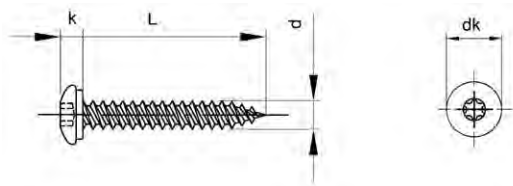

Technical Data

d	d_k	k	Socket
3.9	7.8	1.9	T15

51653	Cross recessed tapping screw for license plates Torx®recess	R03A
Thread	Self tapping thread	
Material	Stainless steel A2	
		
		

d x L	☒	Art.number	d x L	☒	Art.number	d x L	☒	Art.number
ST3,9X13MM*	1000	51653.039.013	ST3,9X22MM*	1000	51653.039.022	ST3,9X32MM*	1000	51653.039.032
ST3,9X16MM*	1000	51653.039.016	ST3,9X25MM*	1000	51653.039.025	ST3,9X38MM*	1000	51653.039.038
ST3,9X19MM*	1000	51653.039.019						

6

Slotted screw for license plates

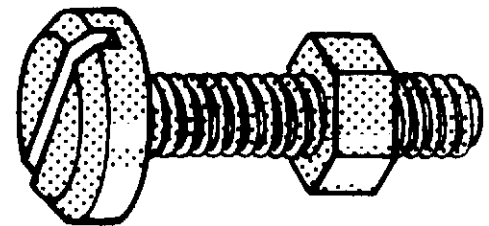

Article groups

Thread	Driving features	Material	Color	Code	Page
M	Slotted	Plastic Nylon	Yellow	72000	6-109
M	Slotted	Plastic Nylon	Black	72002	6-109

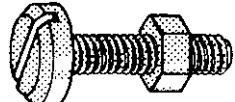
72000	Slotted screw for license plates	Y92D
Thread	Metric thread	
Material	Plastic Nylon (polyamide)	
Color	Yellow	
		

d x L	☒	Art.number	d x L	☒	Art.number
M6X16	100	72000.060.016	M6X25	100	72000.060.025

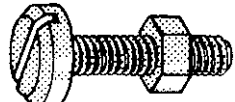
72002	Slotted screw for license plates	Y92D
Thread	Metric thread	
Material	Plastic Nylon (polyamide)	
Color	Black	
		

d x L	☒	Art.number
M6X16	100	72002.060.016

Cap (Snap)

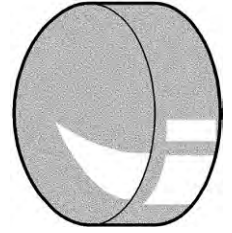

Article groups

Material	Code	Page
Plastic Nylon	72011	6-110
Plastic Nylon for Phillips	72018	6-110

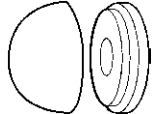
72011	Cap (Snap)	Y92D
Material	Plastic Nylon (polyamide)	

Type	⊗	Art.number	Type	⊗	Art.number
CAP YELLOW M5	100	72011.050.001	CAP BLACK M5	100	72011.050.002

- For screws.

72018	Cap (Snap)	Y92D
Material	Plastic Nylon (polyamide)	

Type	⊗	Art.number	Type	⊗	Art.number	Type	⊗	Art.number
BLUE	100	72018.000.002	WHITE	100	72018.000.011	BLACK	100	72018.000.012
YELLOW	100	72018.000.004						

- For screws (groups 72008/72022/51652/51653).

6

Roofing and front bolt with elastomer sealing ring



- The stainless steel roofing and front bolts are zinc plated.

Assembly data

Material thickness	0,63-1,1	1,25-1,5	2,0-3,0	3,0-3,9	4,0-4,9	5,0-5,9	6,1-10,0	>10,0	
Recommended roof- front bolt	Type A			Type B					
MATERIAL		HOLE SIZE							
Roof- front bolt	Construction								
Stainless steel	Steel and Alum.	4,0	4,5	5,0	5,05	5,35	5,65	5,8	5,85
Aluminium	Aluminium	4,0-4,5			--				
Aluminium	Wood	4,0			--				
Grip length KL in steel and Alum.		L-12			L-10				
Bolt length L in wood		Min. 30 mm			--				

Article groups

Thread	Driving features	Material	Surface treatment	Code	Page
ST	Hexagon	St.St. A2	Zipl	A/Large pack	31710 6-111
ST	Hexagon	St.St. A2	Zipl	A	31711 6-111
ST	Hexagon	St.St. A2	Zipl	B	31720 6-112
ST	Hexagon	St	Zipl	A	31705 6-112

6

31710 SFS-TOPFORM Roofing and front bolt with elastomer sealing ring type A		J07A
Thread	Self tapping thread	
Material	Stainless steel A2	
Surface treatment	Zinc plated	



d x L	⊗	Art.number	d x L	⊗	Art.number	d x L	⊗	Art.number
6,5X19MM	500	31710.065.019	6,5X51MM	100	31710.065.050	6,5X115MM	100	31710.065.115
6,5X25MM	500	31710.065.025	6,5X64MM	100	31710.065.064	6,5X127MM	100	31710.065.130
6,5X32MM	500	31710.065.032	6,5X76MM	100	31710.065.075	6,5X152MM	50	31710.065.150
6,5X38MM	250	31710.065.038	6,5X90MM	100	31710.065.090	6,5X178MM	50	31710.065.175
6,5X45MM	100	31710.065.045	6,5X100MM	100	31710.065.100			

- Applicable for fastening f.i. thin purlins of steel up to 3 mm thickness (tensile strength about 370 N/mm²), in aluminium or in wood.

31711 SFS-TOPFORM Roofing and front bolt with elastomer sealing ring type A		J07A
Thread	Self tapping thread	
Material	Stainless steel A2	
Surface treatment	Zinc plated	



d x L	⊗	Art.number	d x L	⊗	Art.number	d x L	⊗	Art.number
6,5X19MM	100	31711.065.019	6,5X32MM	100	31711.065.032	6,5X38MM	100	31711.065.038
6,5X25MM	100	31711.065.025						

- Applicable for fastening f.i. thin purlins of steel up to 3 mm thickness (tensile strength about 370 N/mm²), in aluminium or in wood.

31720	SFS-TOPFORM Roofing and front bolt with elastomer sealing ring without point type B	J07A
Thread	Self tapping thread	  
Material	Stainless steel A2	
Surface treatment	Zinc plated	

d x L	☒	Art.number	d x L	☒	Art.number
6,3X19MM	500	31720.063.019	6,3X25MM	500	31720.063.025

• The stainless steel roofing and front bolts are zinc plated.

31705	Roofing and front bolt with elastomer sealing ring type A	J07A
Thread	Self tapping thread	 
Material	Steel	
Surface treatment	Zinc plated	

d x L	☒	Art.number	d x L	☒	Art.number	d x L	☒	Art.number
6,5X19MM	100	31705.065.019	6,5X50MM	100	31705.065.050	6,5X115MM	100	31705.065.115
6,5X25MM	100	31705.065.025	6,5X64MM	100	31705.065.064	6,5X130MM	100	31705.065.130
6,5X32MM	100	31705.065.032	6,5X75MM	100	31705.065.075	6,5X150MM	50	31705.065.150
6,5X38MM	100	31705.065.038	6,5X90MM	100	31705.065.090			

• Applicable for fastening f.i. thin purlins of steel up to 3 mm thickness (tensile strength about 370 N/mm²), in aluminium or in wood.

6

Cladding screw with sealing washer 16mm cone point & flat point

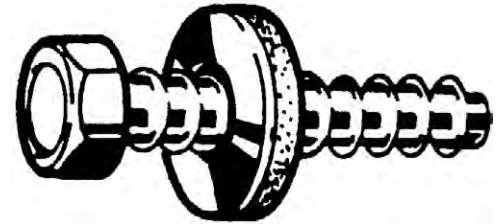
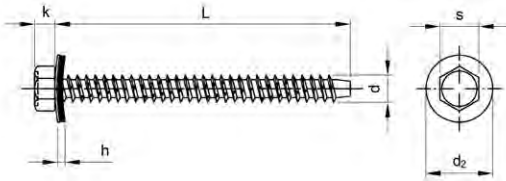

Technical Data



d	d ₂	h	k	s
6.3	16	3	4.6	3/8
6.5	16	3	4.6	3/8

Article groups

Thread	Driving features	Material	Code	Page
ST	Hexagon	St.St. A2	flat point	51891
ST	Hexagon	St.St. A2	cone point	51892

51891	Cladding screw with sealing washer 16mm flat point	R03A
Thread	Self tapping thread	 
Material	Stainless steel A2	

d x L	☒	Art.number	d x L	☒	Art.number	d x L	☒	Art.number
6,3X16MM*	500	51891.063.016	6,3X64MM*	100	51891.063.064	6,3X150MM*	100	51891.063.150
6,3X19MM*	500	51891.063.019	6,3X75MM*	100	51891.063.075	6,3X175MM*	100	51891.063.175
6,3X25MM*	200	51891.063.025	6,3X90MM*	100	51891.063.090	6,3X200MM*	100	51891.063.200
6,3X32MM*	200	51891.063.032	6,3X100MM*	100	51891.063.100	6,3X220MM*	100	51891.063.220
6,3X38MM*	200	51891.063.038	6,3X115MM*	100	51891.063.115	6,3X240MM*	100	51891.063.240
6,3X45MM*	200	51891.063.045	6,3X130MM*	100	51891.063.130	6,3X260MM*	100	51891.063.260
6,3X50MM*	200	51891.063.050						

51892 Cladding screw with sealing washer 16mm cone point		R03A
Thread	Self tapping thread	
Material	Stainless steel A2	
		 

d x L	☒	Art.number	d x L	☒	Art.number	d x L	☒	Art.number
6,5X13MM*	500	51892.065.013	6,5X50MM*	200	51892.065.050	6,5X130MM*	100	51892.065.130
6,5X16MM*	500	51892.065.016	6,5X55MM*	200	51892.065.055	6,5X150MM*	100	51892.065.150
6,5X19MM*	500	51892.065.019	6,5X60MM*	200	51892.065.060	6,5X175MM*	100	51892.065.175
6,5X25MM*	200	51892.065.025	6,5X64MM*	100	51892.065.064	6,5X200MM*	100	51892.065.200
6,5X32MM*	200	51892.065.032	6,5X75MM*	100	51892.065.075	6,5X220MM*	100	51892.065.220
6,5X38MM*	200	51892.065.038	6,5X90MM*	100	51892.065.090	6,5X240MM*	100	51892.065.240
6,5X40MM*	200	51892.065.040	6,5X100MM*	100	51892.065.100	6,5X260MM*	100	51892.065.260
6,5X45MM*	200	51892.065.045	6,5X115MM*	100	51892.065.115			

Cladding screw with sealing washer 19mm cone point & flat point

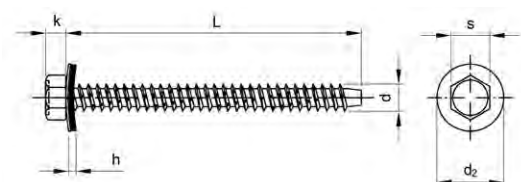

Technical Data



d	d ₂	h	k	s
6.3	19	3	4.6	3/8
6.5	19	3	4.6	3/8

Article groups

Thread	Driving features	Material	Code	Page	
ST	Hexagon	St.St. A2	flat point	51893	6-113
ST	Hexagon	St.St. A2	cone point	51894	6-113

51893 Cladding screw with sealing washer 19mm flat point		R03A
Thread	Self tapping thread	
Material	Stainless steel A2	
		 

d x L	☒	Art.number	d x L	☒	Art.number	d x L	☒	Art.number
6,3X16MM*	500	51893.063.016	6,3X64MM*	100	51893.063.064	6,3X150MM*	100	51893.063.150
6,3X19MM*	500	51893.063.019	6,3X75MM*	100	51893.063.075	6,3X175MM*	100	51893.063.175
6,3X25MM*	200	51893.063.025	6,3X90MM*	100	51893.063.090	6,3X200MM*	100	51893.063.200
6,3X32MM*	200	51893.063.032	6,3X100MM*	100	51893.063.100	6,3X220MM*	100	51893.063.220
6,3X38MM*	200	51893.063.038	6,3X115MM*	100	51893.063.115	6,3X240MM*	100	51893.063.240
6,3X45MM*	200	51893.063.045	6,3X130MM*	100	51893.063.130	6,3X260MM*	100	51893.063.260
6,3X50MM*	200	51893.063.050						

51894 Cladding screw with sealing washer 19mm cone point		R03A
Thread	Self tapping thread	
Material	Stainless steel A2	
		 

d x L	☒	Art.number	d x L	☒	Art.number	d x L	☒	Art.number
6,5X16MM*	500	51894.065.016	6,5X64MM*	100	51894.065.064	6,5X165MM*	100	51894.065.165
6,5X19MM*	500	51894.065.019	6,5X75MM*	100	51894.065.075	6,5X175MM*	100	51894.065.175
6,5X25MM*	200	51894.065.025	6,5X90MM*	100	51894.065.090	6,5X200MM*	100	51894.065.200
6,5X32MM*	200	51894.065.032	6,5X100MM*	100	51894.065.100	6,5X220MM*	100	51894.065.220
6,5X38MM*	200	51894.065.038	6,5X115MM*	100	51894.065.115	6,5X240MM*	100	51894.065.240
6,5X45MM*	200	51894.065.045	6,5X130MM*	100	51894.065.130	6,5X260MM*	100	51894.065.260
6,5X50MM*	200	51894.065.050	6,5X150MM*	100	51894.065.150			

Cladding screw with sealing washer 22mm cone point & flat point

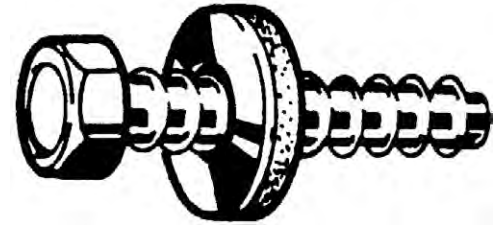
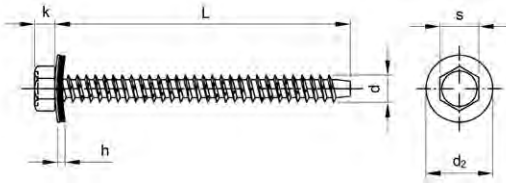

Technical Data

d	d ₂	h	k	s
6.3	22	3	4.6	3/8
6.5	22	3	4.6	3/8

Article groups

Thread	Driving features	Material	Code	Page
ST	Hexagon	St.St. A2	flat point	51777 6-114
ST	Hexagon	St.St. A2	cone point	51771 6-114

6

51777 Cladding screw with sealing washer 22mm flat point R03A

Thread Self tapping thread
Material Stainless steel A2



d x L	☒	Art.number	d x L	☒	Art.number	d x L	☒	Art.number
6,3X16MM*	500	51777.063.016	6,3X64MM*	100	51777.063.064	6,3X150MM*	100	51777.063.150
6,3X19MM*	500	51777.063.019	6,3X75MM*	100	51777.063.075	6,3X175MM*	100	51777.063.175
6,3X25MM*	200	51777.063.025	6,3X90MM*	100	51777.063.090	6,3X200MM*	100	51777.063.200
6,3X32MM*	200	51777.063.032	6,3X100MM*	100	51777.063.100	6,3X220MM*	100	51777.063.220
6,3X38MM*	200	51777.063.038	6,3X115MM*	100	51777.063.115	6,3X240MM*	100	51777.063.240
6,3X45MM*	200	51777.063.045	6,3X130MM*	100	51777.063.130	6,3X260MM*	100	51777.063.260
6,3X50MM*	200	51777.063.050						

51771 Cladding screw with sealing washer 22mm cone point R03A

Thread Self tapping thread
Material Stainless steel A2



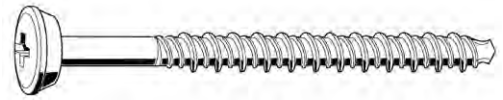
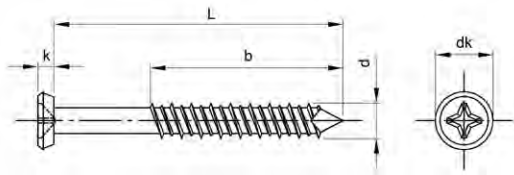

d x L	☒	Art.number	d x L	☒	Art.number	d x L	☒	Art.number
6,5X16MM*	500	51771.065.016	6,5X64MM*	100	51771.065.064	6,5X150MM*	100	51771.065.150
6,5X19MM*	500	51771.065.019	6,5X75MM*	100	51771.065.075	6,5X175MM*	100	51771.065.175
6,5X25MM*	200	51771.065.025	6,5X90MM*	100	51771.065.090	6,5X200MM*	100	51771.065.200
6,5X32MM*	200	51771.065.032	6,5X100MM*	100	51771.065.100	6,5X220MM*	100	51771.065.220
6,5X38MM*	200	51771.065.038	6,5X115MM*	100	51771.065.115	6,5X240MM*	100	51771.065.240
6,5X45MM*	200	51771.065.045	6,5X130MM*	100	51771.065.130	6,5X260MM*	100	51771.065.260
6,5X50MM*	200	51771.065.050						

Cladding screw/Hi-Lo thread/center point

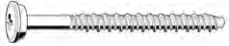

Technical Data

d	d_k	k
5.5	9.2	3

51799	Cladding screw/Hi-Lo thread/center point	R03A
Thread	Self tapping thread	
Material	Stainless steel A2	
Class	50	
		
		

d x L x b	☒	Art.number	d x L x b	☒	Art.number	d x L x b	☒	Art.number
ST5,5X25MM*	100	51799.055.025	ST5,5X45MM*	100	51799.055.045	ST5,5X55MM*	100	51799.055.055
ST5,5X35MM*	100	51799.055.035						

6

Roofing and front bolt with elastomer sealing ring and drilling point

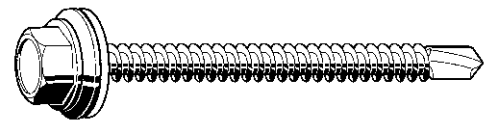
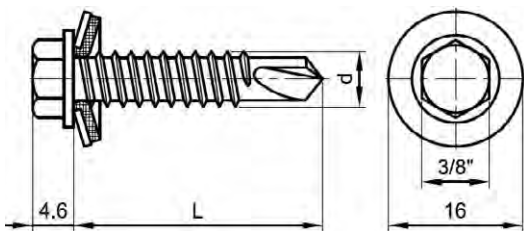

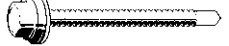
31702	Roofing and front bolt with elastomer sealing ring and drilling point	J07A
Thread	Self tapping thread	
Material	Steel	
Surface treatment	Zinc plated	
		
		

d x L	☒	Art.number	d x L	☒	Art.number	d x L	☒	Art.number
6,3X19MM	250	31702.063.019	6,3X38MM	250	31702.063.038	6,3X60MM	100	31702.063.060
6,3X25MM	250	31702.063.025	6,3X50MM	100	31702.063.050	6,3X75MM	100	31702.063.075
6,3X32MM	200	31702.063.032						

- Warning: electro-galvanizing of these products may cause hydrogen embrittlement.

Elastomer sealing ring

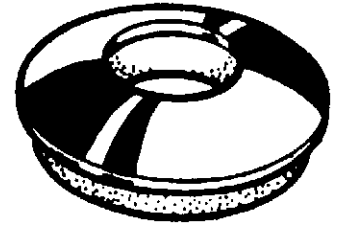
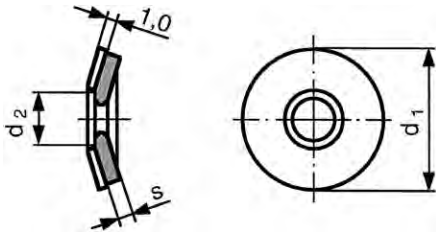

Technical Data

d₁	d₂	s	d₁	d₂	s
16	6.7	2	22	6.7	3
19	6.7	3	29	6.7	3

Assembly data

Material thickness	0,63-1,1	1,25-1,5	2,0-3,0	3,0-3,9	4,0-4,9	5,0-5,9	6,1-10,0	>10,0	
Recommended roof- front bolt	Type A			Type B					
MATERIAL		HOLE SIZE							
Roof- front bolt	Construction								
Stainless steel	Steel and Alum.	4,0	4,5	5,0	5,05	5,35	5,65	5,8	5,85
Aluminium	Aluminium	4,0-4,5			--				
Aluminium	Wood	4,0			--				
Grip length KL in steel and Alum.		L-12			L-10				
Bolt length L in wood		Min. 30 mm			--				



6

Article groups

Material	Code	Page
St.St. A2	31781	6-116
St.St. A2	large pack 31780	6-116

31781 Elastomer sealing ring J07A

Material: Stainless steel A2

d₁	☒	Art.number	d₁	☒	Art.number	d₁	☒	Art.number
16MM	100	31781.160.001	19MM	100	31781.190.001	22MM	100	31781.220.001

31780 Elastomer sealing ring J07A

Material: Stainless steel A2



d₁	☒	Art.number	d₁	☒	Art.number	d₁	☒	Art.number
16MM	500	31780.160.001	22MM	500	31780.220.001	29MM	100	31780.290.001
19MM	500	31780.190.001						

Bonded sealing washer grey EPDM arched

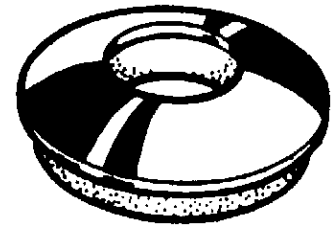
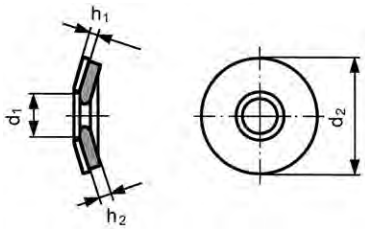

Technical Data

d_1	h_1	h_2
4.8	1	2
5.3	1	2
6.2	1	2
6.7	1	2
8.4	1	2
10.5	1	2
13	1	2

51422 Bonded sealing washer grey EPDM arched

R05A

Material Stainless steel A2



6

$d_1 \times d_2$	☒	Art.number	$d_1 \times d_2$	☒	Art.number	$d_1 \times d_2$	☒	Art.number
4,8X12MM*	1000	51422.048.012	6,7X16MM*	1000	51422.067.016	8,4X22MM*	1000	51422.084.022
4,8X14MM*	1000	51422.048.014		1000	51422.067.019	8,4X25MM*	1000	51422.084.025
5,3X12MM*	1000	51422.053.012	6,7X19MM*	1000	51422.067.022	8,4X29MM*	500	51422.084.029
5,3X14MM*	1000	51422.053.014	6,7X22MM*	1000	51422.067.025	10,5X25MM*	1000	51422.105.025
5,3X16MM*	1000	51422.053.016	6,7X25MM*	1000	51422.067.029	10,5X29MM*	500	51422.105.029
5,3X19MM*	1000	51422.053.019	6,7X29MM*	500		13,0X29MM*	500	51422.130.029
6,2X16MM*	1000	51422.062.016	8,4X16MM*	1000	51422.084.016			
			8,4X19MM*	1000	51422.084.019			

MaxxFast Self Drilling Screws

High Performance

The self-drilling MaxxFast program consists of high quality self-drilling fastening products. Thanks to the use of MaxxFast Self drilling screws, it is possible to create a reliable connection in one single operation. With a single step, the correct core hole is drilled, the thread is formed and the structural parts reliably connected. No hole drilling or punching needed, no more thread tapping.

High quality fastening products!

The integrated drill tip provides a significant reduction of the general cost of a joint. It also greatly prevents making mistakes regarding positioning of the work-pieces. The design of the connection, allows to choose a simpler joint-construction.

During the connection process, the time-consuming preparation and handling of the workpiece, as well as the exchange of tools, is eliminated. Specifically when working on large workpieces this time consuming positioning can be avoided. Each screw uses its own "new" drillpoint and prevents wasting time in comparison with using separate drills. Use of the correct drill diameter in relation to the size of the screw is guaranteed, eliminating this particular room for errors. Using self-drilling screws prevents failures of a screw connection and in general reduces the cost of extra inspections.

Saving time and equipment!

Faster and easier assembly and no time-consuming alignment and positioning of the components. Assembly case studies have shown that in some cases product assembly time will be reduced by maybe more than 50%. No additional costs regarding investment for dedicated installation equipment.

The MaxxFast Self drilling screws are available in 3 different materials:

- Steel-zinc-plated
- Stainless Steel
- Bi-Metal with Ruspert 500 coating

The MaxxFast self drilling screws are produced in the in most common recess types like Phillips, Square, Hexagon, thus equipped for mechanized mass assembly with electrical setting tools. In addition to these standard drives, the MaxxFast self drilling screws are also available with the innovative ttap® drive.

6



Self drilling screw pan head cross recessed

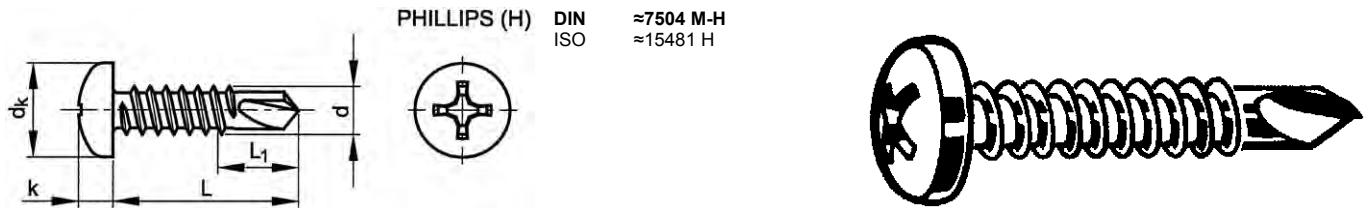

PHILLIPS (H) DIN ≈7504 M-H
ISO ≈15481 H

Technical Data

d	d _k	k	L ₁	No. cross recess
ST2.9	5.30 - 5.60	1.95 - 2.20	4	1
ST3.5	6.54 - 6.90	2.35 - 2.60	4	2
ST3.9	7.14 - 7.50	2.55 - 2.80	4.5	2
ST4.2	7.84 - 8.20	2.75 - 3.05	5	2
ST4.8	9.14 - 9.50	3.25 - 3.55	6.5	2
ST5.5	10.37 - 10.80	3.65 - 3.95	8	3

30320 MAXXFAST Self-drilling pan head screw Phillips recess

MF1A

Thread Self tapping thread
Material Steel
Surface treatment Zinc plated

MAXXFAST
PROFESSIONAL HARDWARE



d x L	☒	Art.number	d x L	☒	Art.number	d x L	☒	Art.number
ST2,9X9,5MM	200	30320.029.009	ST3,9X25MM	200	30320.039.025	ST4,8X25MM	200	30320.048.025
ST2,9X13MM	200	30320.029.013	ST3,9X32MM	200	30320.039.032	ST4,8X32MM	200	30320.048.032
ST3,5X9,5MM	200	30320.035.009	ST4,2X13MM	200	30320.042.013	ST4,8X38MM	200	30320.048.038
ST3,5X13MM	200	30320.035.013	ST4,2X16MM	200	30320.042.016	ST4,8X45MM	200	30320.048.045
ST3,5X16MM	200	30320.035.016	ST4,2X19MM	200	30320.042.019	ST4,8X50MM	200	30320.048.050
ST3,5X19MM	200	30320.035.019	ST4,2X22MM	200	30320.042.022	ST5,5X19MM	200	30320.055.019
ST3,5X22MM	200	30320.035.022	ST4,2X25MM	200	30320.042.025	ST5,5X22MM	200	30320.055.022
ST3,5X25MM	200	30320.035.025	ST4,2X32MM	200	30320.042.032	ST5,5X25MM	200	30320.055.025
ST3,9X13MM	200	30320.039.013	ST4,8X13MM	200	30320.048.013	ST5,5X32MM	200	30320.055.032
ST3,9X16MM	200	30320.039.016	ST4,8X16MM	200	30320.048.016	ST5,5X38MM	200	30320.055.038
ST3,9X19MM	200	30320.039.019	ST4,8X19MM	200	30320.048.019	ST5,5X45MM	200	30320.055.045
ST3,9X22MM	200	30320.039.022	ST4,8X22MM	200	30320.048.022	ST5,5X50MM	200	30320.055.050

• Full boxes only.

Self drilling screw pan head cross recessed

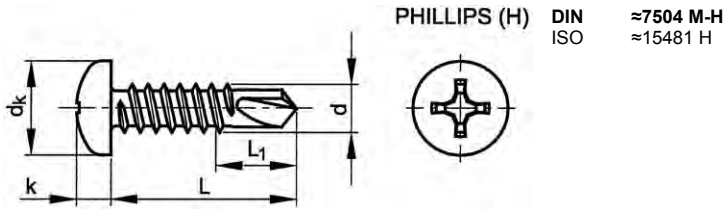

PHILLIPS (H) DIN ≈7504 M-H
ISO ≈15481 H

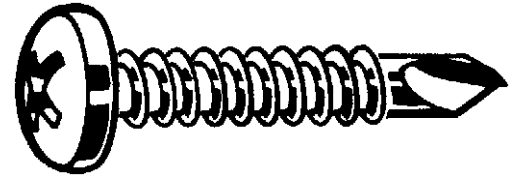

Technical Data

d	d _k	k	L ₁	No. cross recess
ST2.9	5.30 - 5.60	2.15 - 2.40	4	1
ST3.5	6.64 - 7.00	2.35 - 2.60	4	2
ST3.9	7.14 - 7.50	2.55 - 2.80	4.5	2
ST4.2	7.64 - 8.00	2.80 - 3.10	4.5	2
ST4.8	9.14 - 9.50	3.40 - 3.70	6.5	2
ST5.5	10.57 - 11.00	3.70 - 4.00	8	3

Article groups

Thread	Driving features	Material	Code	Page
ST	Phillips	St.St. A2	30325	6-120
ST	Phillips	Bi-Metal	30330	6-120

6

30325 MAXXFAST Self-drilling pan head screw Phillips recess MF1A

Thread	Self tapping thread	  
Material	Stainless steel A2	

d x L	☒	Art.number	d x L	☒	Art.number	d x L	☒	Art.number
ST2,9X9,5MM	200	30325.029.009	ST3,9X25MM	200	30325.039.025	ST4,8X25MM	200	30325.048.025
ST2,9X13MM	200	30325.029.013	ST3,9X32MM	200	30325.039.032	ST4,8X32MM	200	30325.048.032
ST3,5X9,5MM	200	30325.035.009	ST4,2X13MM	200	30325.042.013	ST4,8X38MM	200	30325.048.038
ST3,5X13MM	200	30325.035.013	ST4,2X16MM	200	30325.042.016	ST4,8X45MM	200	30325.048.045
ST3,5X16MM	200	30325.035.016	ST4,2X19MM	200	30325.042.019	ST4,8X50MM	200	30325.048.050
ST3,5X19MM	200	30325.035.019	ST4,2X22MM	200	30325.042.022	ST5,5X19MM	200	30325.055.019
ST3,5X22MM	200	30325.035.022	ST4,2X25MM	200	30325.042.025	ST5,5X22MM	200	30325.055.022
ST3,5X25MM	200	30325.035.025	ST4,2X32MM	200	30325.042.032	ST5,5X25MM	200	30325.055.025
ST3,9X13MM	200	30325.039.013	ST4,8X13MM	200	30325.048.013	ST5,5X32MM	200	30325.055.032
ST3,9X16MM	200	30325.039.016	ST4,8X16MM	200	30325.048.016	ST5,5X38MM	200	30325.055.038
ST3,9X19MM	200	30325.039.019	ST4,8X19MM	200	30325.048.019	ST5,5X45MM	200	30325.055.045
ST3,9X22MM	200	30325.039.022	ST4,8X22MM	200	30325.048.022	ST5,5X50MM	200	30325.055.050

• Full boxes only.

30330 MAXXFAST Self-drilling pan head screw Phillips recess MF1A

Thread	Self tapping thread	  
Material	Bi-Metal	

d x L	☒	Art.number	d x L	☒	Art.number	d x L	☒	Art.number
ST3,5X16MM	200	30330.035.016	ST4,2X16MM	200	30330.042.016	ST4,8X38MM	200	30330.048.038
ST3,5X19MM	200	30330.035.019	ST4,2X19MM	200	30330.042.019	ST4,8X45MM	200	30330.048.045
ST3,5X22MM	200	30330.035.022	ST4,2X22MM	200	30330.042.022	ST4,8X50MM	200	30330.048.050
ST3,5X25MM	200	30330.035.025	ST4,2X25MM	200	30330.042.025	ST5,5X19MM	200	30330.055.019
ST3,9X16MM	200	30330.039.016	ST4,2X32MM	200	30330.042.032	ST5,5X22MM	200	30330.055.022
ST3,9X19MM	200	30330.039.019	ST4,8X16MM	200	30330.048.016	ST5,5X25MM	200	30330.055.025
ST3,9X22MM	200	30330.039.022	ST4,8X19MM	200	30330.048.019	ST5,5X32MM	200	30330.055.032
ST3,9X25MM	200	30330.039.025	ST4,8X22MM	200	30330.048.022	ST5,5X38MM	200	30330.055.038
ST3,9X32MM	200	30330.039.032	ST4,8X25MM	200	30330.048.025	ST5,5X45MM	200	30330.055.045
			ST4,8X32MM	200	30330.048.032	ST5,5X50MM	200	30330.055.050

• Full boxes only.

Fabory-Spedec self-drilling screws

General

With the Fabory-Spedec fastening system of DIRECT ASSEMBLY the correct core hole is drilled, the thread is tapped, and the construction parts are connected reliably in one single operation. Thus no drilling or punching of the hole and no thread tapping.

Standards

Fabory-Spedec self-drilling screw head forms and dimensions are according to DIN standards of normal screws

Material

The Fabory-Spedec self-drilling screws are made of case-hardened steel (min. 560 HV 0.3), with the core remains tough (270-425 HV 0.3). Fabory-Spedec self-drilling screws meet the sizes, requirements and tests acc. to DIN 7504.

Recess

Fabory-Spedec self-drilling screws are provided with a Phillips recess, hexalobular recess or SR recess, thus equipped for mechanized mass-assembly with electrical setting tools

Threads

Fabory-Spedec self-drilling screws with self-tapping threads (designation ST) according to DIN 7970. Full thread to achieve good clamping in the joint.

System

Every Fabory-Spedec self-drilling screw drills the hole with its own integrated self-drilling point. Thus quicker and lighter assembly and no time consuming alignment and positioning of construction parts.

Application

Stainless steel A2 Fabory-Spedec self-drilling screws are only to be used in aluminium alloys with a Brinell hardness up to 75 HB, aluminium self-drilling screws are only to be used in plastics and aluminium alloys.

Guide values for steel Fabory-Spedec self-drilling screws type SN

d		ST2,9	ST3,5	ST3,9	ST4,2	ST4,8	ST5,5	ST6,3
Tensile force min. in N		4400	6300	8000	8300	12000	14000	21000
Shear strength min. in N		2100	3700	3600	4100	6800	9000	13300
Breaking torque in Nm		2	3,7	4,5	5,1	9,2	14,5	23
Drillcapacity in steel cross members (St 37/52) incl. intervening space	(min.)	0,5	1	1	1,75	2,75	2,75	2,75
	(max.)	2	2	2,5	3,5/3	5/4	6	6
Drilling machine (unloaded)	r.p.m.	3500	3500	3500	3500	3500	2900	2900
	output watt	340-400	340-400	340-400	340-400	340-400	400-700	400-700
Av. drilling time in St 37	approx. sec.	3,5	4	5,7	4,1	3,6	6,9	13

Recess types

Screws have various types of recess, i.e.: slotted recess, Phillips-cross recess, Pozidriv-cross recess, hexalobular recess and SR-recess. The first five types have one general disadvantage, dimensional deviation of the recess and tool result in excessive clearance between recess and tool, resulting in instability when starting the screw, (vibration and wobble). This excessive clearance can also be a problem when disassembling screws in a difficult location.

SR-recess

The SR-recess has been developed to eliminate the problem of excessive clearance. The SR-recess is

in principle a combination of a square-recess and cross-recess. The conical square-recess enables the SR-screw to be attached directly to the SR-tool. The screw, despite its own mass, remains firmly attached to the tool. The excellent connection ensures that wear between the recess and tool (bit) is kept to a minimum. The life expectancy of a SR-tool (bit) is double the life of a conventional tool.

And even more... In this section an extensive assortment of MaxxFast self-drilling screws in steel, stainless steel and also Bi-Metal. Mainly ttap®, but also hexagonal, pozidriv and square recess.

Self-drilling cross recessed pan head screw

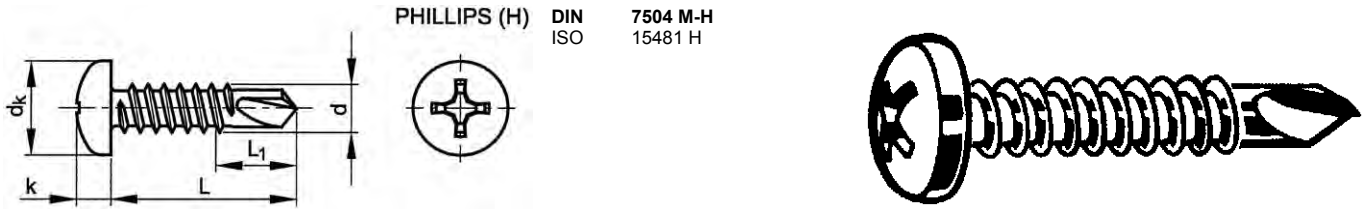

Technical Data

d	d _k	k	L ₁ ≈	No. cross recess	P
ST2.9	5.6	2.2	4.5	1	1.1
ST3.5	6.9	2.6	5	2	1.3
ST3.9	7.5	2.8	6	2	1.4
ST4.2	8.2	3.05	7	2	1.4
ST4.8	9.5	3.55	8	2	1.6

- Max. grip length KL = L - L₁.

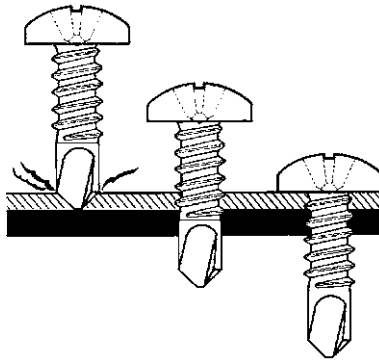

6

Article groups

Thread	Driving features	Material	Surface treatment	Code	Page
ST	Phillips	St	Zipl	31255	6-122
ST	Phillips	St	Zipl	31250	6-123
ST	Phillips	St.St. A2		31120	6-123
ST	Phillips	St	Zipl	31825	6-123
ST	Phillips	St	Zipl	31820	6-123
ST	Phillips	St.St. A2		31870	6-124

31255 SPEDEC SN Self-drilling cross recessed pan head screw Phillips

J09A

Thread Self tapping thread
Material Steel
Surface treatment Zinc plated





d x L	⊠	Art.number	d x L	⊠	Art.number	d x L	⊠	Art.number
ST3,5X9,5MM	200	31255.035.009	ST3,9X16MM	200	31255.039.016	ST4,2X25MM	200	31255.042.025
ST3,5X13MM	200	31255.035.013	ST3,9X19MM	200	31255.039.019	ST4,2X32MM	200	31255.042.032
ST3,5X16MM	200	31255.035.016						
ST3,5X19MM	200	31255.035.019	ST4,2X13MM	200	31255.042.013	ST4,8X13MM	200	31255.048.013
ST3,5X25MM	200	31255.035.025	ST4,2X16MM	200	31255.042.016	ST4,8X16MM	200	31255.048.016
			ST4,2X19MM	200	31255.042.019	ST4,8X19MM	200	31255.048.019

- Warning: electro-galvanizing of these products may cause hydrogen embrittlement.

31250 Self-drilling cross recessed pan head screw Phillips		J09A
Thread	Self tapping thread	 
Material	Steel	
Surface treatment	Zinc plated	

d x L	☒	Art.number	d x L	☒	Art.number	d x L	☒	Art.number
ST2,9X9,5MM	1000	31250.029.009	ST3,9X19MM	1000	31250.039.019	<div style="background-color: #e0e0e0; padding: 5px;"> ST4,8X13MM 1000 31250.048.013 ST4,8X16MM 1000 31250.048.016 ST4,8X19MM 1000 31250.048.019 ST4,8X22MM 1000 31250.048.022 ST4,8X25MM 1000 31250.048.025 ST4,8X32MM 1000 31250.048.032 ST4,8X38MM 500 31250.048.038 ST4,8X50MM 500 31250.048.050 </div>		
ST3,5X9,5MM	1000	31250.035.009	ST3,9X25MM	1000	31250.039.025			
ST3,5X13MM	1000	31250.035.013	ST3,9X32MM	1000	31250.039.032			
ST3,5X16MM	1000	31250.035.016	ST4,2X13MM	1000	31250.042.013			
ST3,5X19MM	1000	31250.035.019	ST4,2X16MM	1000	31250.042.016			
ST3,5X25MM	1000	31250.035.025	ST4,2X19MM	1000	31250.042.019			
ST3,9X13MM	1000	31250.039.013	ST4,2X22MM	1000	31250.042.022			
ST3,9X16MM	1000	31250.039.016	ST4,2X25MM	1000	31250.042.025			
			ST4,2X32MM	1000	31250.042.032			

• Warning: electro-galvanizing of these products may cause hydrogen embrittlement.

31120 SPEDEC SN Self-drilling cross recessed pan head screw Phillips		J09A
Thread	Self tapping thread	 
Material	Stainless steel A2	

d x L	☒	Art.number	d x L	☒	Art.number	d x L	☒	Art.number
ST2,9X13MM	1000	31120.029.013	ST3,9X16MM	1000	31120.039.016	ST4,2X25MM	1000	31120.042.025
ST3,5X9,5MM	1000	31120.035.009	ST3,9X25MM	1000	31120.039.025	<div style="background-color: #e0e0e0; padding: 5px;"> ST4,8X16MM 1000 31120.048.016 ST4,8X22MM 1000 31120.048.022 </div>		
ST3,5X13MM	1000	31120.035.013	ST4,2X13MM	1000	31120.042.013			
ST3,5X19MM	1000	31120.035.019	ST4,2X16MM	1000	31120.042.016			
			ST4,2X19MM	1000	31120.042.019			

31825 Self-drilling cross recessed pan head screw Phillips		J09B
Thread	Self tapping thread	 
Material	Steel	
Surface treatment	Zinc plated	

d x L	☒	Art.number	d x L	☒	Art.number	d x L	☒	Art.number
ST3,5X9,5MM	1000	31825.035.009	ST4,2X13MM	1000	31825.042.013	ST4,8X13MM	1000	31825.048.013
ST3,5X13MM	1000	31825.035.013	ST4,2X16MM	1000	31825.042.016	ST4,8X16MM	1000	31825.048.016
ST3,5X16MM	1000	31825.035.016	ST4,2X19MM	1000	31825.042.019	ST4,8X19MM	1000	31825.048.019
ST3,5X19MM	1000	31825.035.019	ST4,2X25MM	1000	31825.042.025	ST4,8X22MM	1000	31825.048.022
						ST4,8X25MM	1000	31825.048.025

• Warning: electro-galvanizing of these products may cause hydrogen embrittlement.

31820 Self-drilling cross recessed pan head screw Phillips		J09B
Thread	Self tapping thread	 
Material	Steel	
Surface treatment	Zinc plated	

d x L	☒	Art.number	d x L	☒	Art.number	d x L	☒	Art.number
ST3,5X9,5MM	2000	31820.035.009	ST3,9X25MM	2000	31820.039.025	ST4,2X38MM	2000	31820.042.038
ST3,5X13MM	2000	31820.035.013	<div style="background-color: #e0e0e0; padding: 5px;"> ST4,8X13MM 2000 31820.048.013 ST4,8X16MM 2000 31820.048.016 ST4,8X19MM 2000 31820.048.019 ST4,8X25MM 2000 31820.048.025 ST4,8X32MM 1000 31820.048.032 ST4,8X50MM 1000 31820.048.050 </div>					
ST3,5X16MM	2000	31820.035.016						
ST3,5X19MM	2000	31820.035.019						
ST3,5X25MM	2000	31820.035.025						
ST3,9X16MM	2000	31820.039.016						
ST3,9X19MM	2000	31820.039.019						

• Warning: electro-galvanizing of these products may cause hydrogen embrittlement.

31870	Self-drilling cross recessed pan head screw Phillips	J09B
Thread	Self tapping thread	 
Material	Stainless steel A2	

d x L	☒	Art.number	d x L	☒	Art.number	d x L	☒	Art.number
ST3,5X9,5MM	2000	31870.035.009	ST3,9X25MM	2000	31870.039.025	ST4,2X25MM	2000	31870.042.025
ST3,5X13MM	2000	31870.035.013				ST4,8X16MM	2000	31870.048.016
ST3,5X19MM	2000	31870.035.019	ST4,2X13MM	2000	31870.042.013	ST4,8X22MM	2000	31870.048.022
			ST4,2X16MM	2000	31870.042.016			
ST3,9X16MM	2000	31870.039.016	ST4,2X19MM	2000	31870.042.019			

ttap® Drive

ttap® is an innovative new hex-lob drive system with distinctive advantages compared to the generic hex-lob (Torx®). ttap® is a drive system designed to work excellently with all types of assembling, including demanding professional applications. The stick-fit, no wobbling feature enables one handed operations without the use of a magnetic bitholder. ttap® makes screw assembling easier and at lower costs.

Easier

- Stick-fit; screwdriver sticks-fit in the recess
- No wobbling; screwdriver does not wobble out of the recess, does not cam out
- No need to push; no end load on screwdriver needed
- One-handed operation is possible
- No magnetic bit holder needed and thus there are no steel splinters to clog the bit
- Screwdriver enters the screw recess more easily

Cost efficient

- Reduce tool usage
- Improved productivity
- Reduced risk to damage rust protection plating
- Better profits and job moral

Hex-Lob (Torx®) Compatible

- ttap® is 100 % a hexalobular recess, backward convertible - but without the disadvantages
- You can use Torx® bits on ttap® screws, hence, strategically easy to change to ttap®

Benefits your health

- No need to push - no end load on screwdriver needed
- If you compare ttap® with Phillips or Pozidriv recess, a major advantage is that you don't need to apply as much pressure to drive the screw, hence ttap® reduces worker fatigue

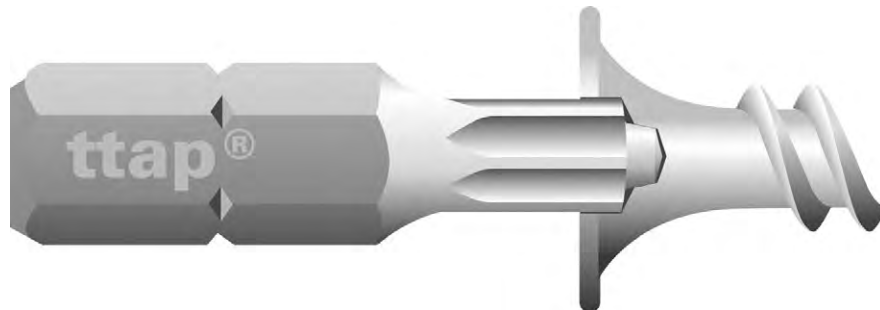

Self drilling screw pan head ttap®

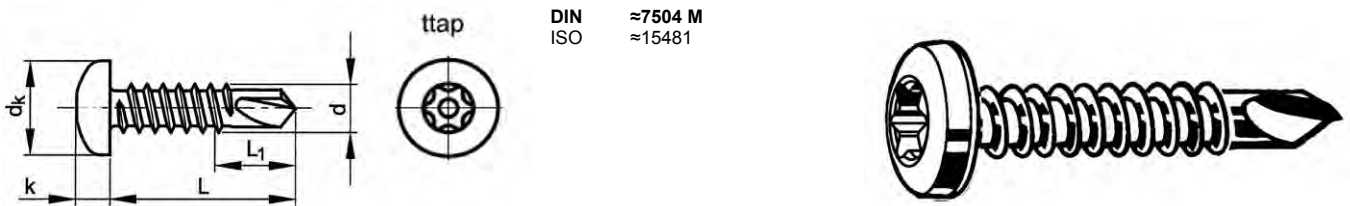

DIN ≈7504 M
ISO ≈15481

Technical Data

d	dk	k	L ₁	No. ttap
ST2.9	5.30 - 5.60	2.15 - 2.40	4	10
ST3.5	6.64 - 7.00	2.35 - 2.60	4	15
ST3.9	7.14 - 7.50	2.55 - 2.80	4.5	15
ST4.2	7.64 - 8.00	2.80 - 3.10	4.5	20
ST4.8	9.14 - 9.50	3.40 - 3.70	6.5	25
ST5.5	10.57 - 11.00	3.70 - 4.00	8	25

Article groups

Thread	Driving features	Material	Surface treatment	Code	Page
ST	ttap®	St	Zipl	30380	6-126
ST	ttap®	St.St. A2		30385	6-126

6

30380 MAXXFAST Self-drilling pan head screw with ttap® MF1A

Thread: Self tapping thread
Material: Steel
Surface treatment: Zinc plated

MAXXFAST
PROFESSIONAL HARDWARE

d x L	☒	Art.number	d x L	☒	Art.number	d x L	☒	Art.number
ST2,9X9,5MM	200	30380.029.009	ST3,9X25MM	200	30380.039.025	ST4,8X25MM	200	30380.048.025
ST2,9X13MM	200	30380.029.013	ST3,9X32MM	200	30380.039.032	ST4,8X32MM	200	30380.048.032
ST3,5X9,5MM	200	30380.035.009	ST4,2X13MM	200	30380.042.013	ST4,8X38MM	200	30380.048.038
ST3,5X13MM	200	30380.035.013	ST4,2X16MM	200	30380.042.016	ST4,8X45MM	200	30380.048.045
ST3,5X16MM	200	30380.035.016	ST4,2X19MM	200	30380.042.019	ST4,8X50MM	200	30380.048.050
ST3,5X19MM	200	30380.035.019	ST4,2X22MM	200	30380.042.022	ST5,5X19MM	200	30380.055.019
ST3,5X22MM	200	30380.035.022	ST4,2X25MM	200	30380.042.025	ST5,5X22MM	200	30380.055.022
ST3,5X25MM	200	30380.035.025	ST4,2X32MM	200	30380.042.032	ST5,5X25MM	200	30380.055.025
ST3,9X13MM	200	30380.039.013	ST4,8X13MM	200	30380.048.013	ST5,5X32MM	200	30380.055.032
ST3,9X16MM	200	30380.039.016	ST4,8X16MM	200	30380.048.016	ST5,5X38MM	200	30380.055.038
ST3,9X19MM	200	30380.039.019	ST4,8X19MM	200	30380.048.019	ST5,5X45MM	200	30380.055.045
ST3,9X22MM	200	30380.039.022	ST4,8X22MM	200	30380.048.022	ST5,5X50MM	200	30380.055.050

• Full boxes only.

30385 MAXXFAST Self-drilling pan head screw with ttap® MF1A

Thread: Self tapping thread
Material: Stainless steel A2

MAXXFAST
PROFESSIONAL HARDWARE

d x L	☒	Art.number	d x L	☒	Art.number	d x L	☒	Art.number
ST2,9X9,5MM	200	30385.029.009	ST3,9X25MM	200	30385.039.025	ST4,8X25MM	200	30385.048.025
ST2,9X13MM	200	30385.029.013	ST3,9X32MM	200	30385.039.032	ST4,8X32MM	200	30385.048.032
ST3,5X9,5MM	200	30385.035.009	ST4,2X13MM	200	30385.042.013	ST4,8X38MM	200	30385.048.038
ST3,5X13MM	200	30385.035.013	ST4,2X16MM	200	30385.042.016	ST4,8X45MM	200	30385.048.045
ST3,5X16MM	200	30385.035.016	ST4,2X19MM	200	30385.042.019	ST4,8X50MM	200	30385.048.050
ST3,5X19MM	200	30385.035.019	ST4,2X22MM	200	30385.042.022	ST5,5X19MM	200	30385.055.019
ST3,5X22MM	200	30385.035.022	ST4,2X25MM	200	30385.042.025	ST5,5X22MM	200	30385.055.022
ST3,5X25MM	200	30385.035.025	ST4,2X32MM	200	30385.042.032	ST5,5X25MM	200	30385.055.025
ST3,9X13MM	200	30385.039.013	ST4,8X13MM	200	30385.048.013	ST5,5X32MM	200	30385.055.032
ST3,9X16MM	200	30385.039.016	ST4,8X16MM	200	30385.048.016	ST5,5X38MM	200	30385.055.038
ST3,9X19MM	200	30385.039.019	ST4,8X19MM	200	30385.048.019	ST5,5X45MM	200	30385.055.045
ST3,9X22MM	200	30385.039.022	ST4,8X22MM	200	30385.048.022	ST5,5X50MM	200	30385.055.050

30385 MAXXFAST Self-drilling pan head screw with ttap®

- Full boxes only.

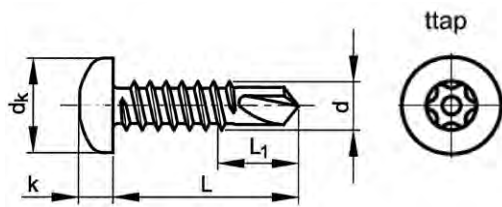
Self drilling screw pan head ttap®

ttap

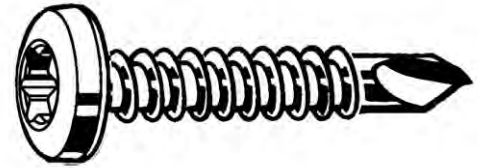
 DIN ≈7504 M
 ISO ≈15481

Technical Data

d	dk	k	L ₁	No. ttap
ST3.5	6.90 - 7.30	2.35	4	15
ST3.9	7.14 - 7.50	2.30	4.5	15
ST4.2	8.00 - 8.40	2.60	4.5	20
ST4.8	8.90 - 9.30	2.80	6.5	25
ST5.5	9.90 - 10.30	4.25	8	25

30390 MAXXFAST Self-drilling pan head screw with ttap®

MF1A

 Thread: Self tapping thread
 Material: Bi-Metal

MAXXFAST
 PROFESSIONAL HARDWARE

6

d x L	☒	Art.number	d x L	☒	Art.number	d x L	☒	Art.number
ST3,5X16MM	200	30390.035.016	ST4,2X16MM	200	30390.042.016	ST4,8X38MM	200	30390.048.038
ST3,5X19MM	200	30390.035.019	ST4,2X19MM	200	30390.042.019	ST4,8X45MM	200	30390.048.045
ST3,5X22MM	200	30390.035.022	ST4,2X22MM	200	30390.042.022	ST4,8X50MM	200	30390.048.050
ST3,5X25MM	200	30390.035.025	ST4,2X25MM	200	30390.042.025			
			ST4,2X32MM	200	30390.042.032	ST5,5X19MM	200	30390.055.019
ST3,9X16MM	200	30390.039.016				ST5,5X22MM	200	30390.055.022
ST3,9X19MM	200	30390.039.019	ST4,8X16MM	200	30390.048.016	ST5,5X25MM	200	30390.055.025
ST3,9X22MM	200	30390.039.022	ST4,8X19MM	200	30390.048.019	ST5,5X32MM	200	30390.055.032
ST3,9X25MM	200	30390.039.025	ST4,8X22MM	200	30390.048.022	ST5,5X38MM	200	30390.055.038
ST3,9X32MM	200	30390.039.032	ST4,8X25MM	200	30390.048.025	ST5,5X45MM	200	30390.055.045
			ST4,8X32MM	200	30390.048.032	ST5,5X50MM	200	30390.055.050

- Full boxes only.

Selfdrilling pan head screw square recess

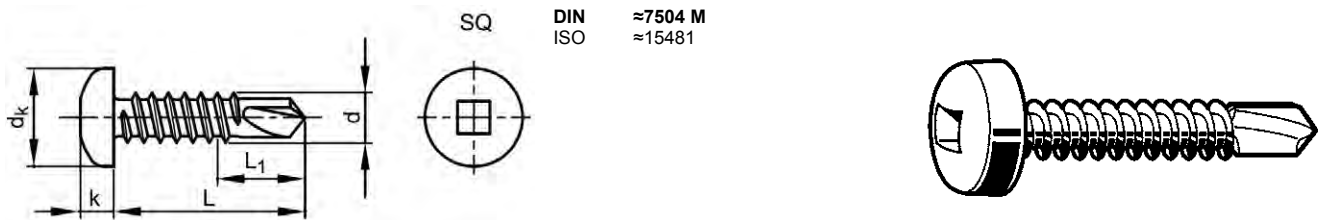

Technical Data

d	d _k	k	L ₁	No. square
ST3.5	6.64 - 7.00	2.35 - 2.60	4	1
ST3.9	7.14 - 7.50	2.55 - 2.80	4.5	2
ST4.2	7.64 - 8.00	2.80 - 3.10	5	2
ST4.8	9.14 - 9.50	3.40 - 3.70	6.5	2

30400 MAXXFAST Self-drilling screw pan head with square recess MF1A

Thread: Self tapping thread
 Material: Steel
 Surface treatment: Zinc plated

MAXXFAST
PROFESSIONAL HARDWARE

RoHS

6

d x L	☒	Art.number	d x L	☒	Art.number	d x L	☒	Art.number
ST3.5X9,5MM	200	30400.035.009	ST3.9X25MM	200	30400.039.025	ST4.8X13MM	200	30400.048.013
ST3.5X13MM	200	30400.035.013	ST3.9X32MM	200	30400.039.032	ST4.8X16MM	200	30400.048.016
ST3.5X16MM	200	30400.035.016				ST4.8X19MM	200	30400.048.019
ST3.5X19MM	200	30400.035.019	ST4.2X13MM	200	30400.042.013	ST4.8X22MM	200	30400.048.022
ST3.5X22MM	200	30400.035.022	ST4.2X16MM	200	30400.042.016	ST4.8X25MM	200	30400.048.025
ST3.5X25MM	200	30400.035.025	ST4.2X19MM	200	30400.042.019	ST4.8X32MM	200	30400.048.032
			ST4.2X22MM	200	30400.042.022	ST4.8X35MM	200	30400.048.035
ST3.9X13MM	200	30400.039.013	ST4.2X25MM	200	30400.042.025	ST4.8X38MM	200	30400.048.038
ST3.9X16MM	200	30400.039.016	ST4.2X30MM	200	30400.042.030	ST4.8X45MM	200	30400.048.045
ST3.9X19MM	200	30400.039.019	ST4.2X32MM	200	30400.042.032	ST4.8X50MM	200	30400.048.050
ST3.9X22MM	200	30400.039.022	ST4.2X40MM	200	30400.042.040			

• Full boxes only.

Self-drilling pan head screw with SR-recess

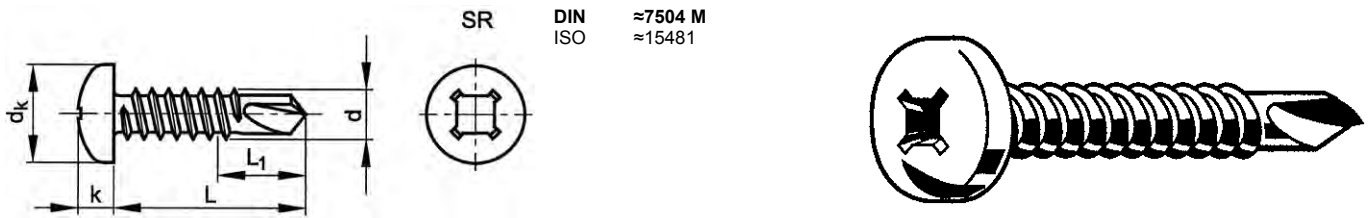



SR DIN ≈7504 M
ISO ≈15481

Technical Data

d	d _k	k	L ₁ ≈	No. SR	P
ST3.5	7	2.6	5	1	1.3
ST3.9	7.5	2.95	6	2	1.4
ST4.2	8	3.25	7	2	1.4
ST4.8	9.5	3.7	8	2	1.6

- SR-recess is a cross recess/square recess combination. Assembly with SR screwdriver bits, see group codes 31535 and 31640.
- Max. grip length KL = L - L₁.
- Warning: electro-galvanizing of these products may cause hydrogen embrittlement.



31480 SPEDEC SN Self-drilling pan head screw with SR-recess		J08A
Thread	Self tapping thread	 
Material	Steel	
Surface treatment	Zinc plated	

d x L	☒	Art.number	d x L	☒	Art.number	d x L	☒	Art.number
ST3,5X13MM	1000	31480.035.013	ST3,9X25MM	1000	31480.039.025	ST4,8X13MM	1000	31480.048.013
ST3,5X16MM	1000	31480.035.016	ST4,2X13MM	1000	31480.042.013	ST4,8X16MM	1000	31480.048.016
ST3,5X19MM	1000	31480.035.019	ST4,2X16MM	1000	31480.042.016	ST4,8X19MM	1000	31480.048.019
ST3,5X25MM	1000	31480.035.025	ST4,2X19MM	1000	31480.042.019	ST4,8X25MM	1000	31480.048.025
ST3,9X13MM	1000	31480.039.013	ST4,2X25MM	1000	31480.042.025	ST4,8X32MM	1000	31480.048.032
ST3,9X16MM	1000	31480.039.016	ST4,2X32MM	1000	31480.042.032	ST4,8X38MM	1000	31480.048.038
ST3,9X19MM	1000	31480.039.019						

Self-drilling pan head screw with square socket

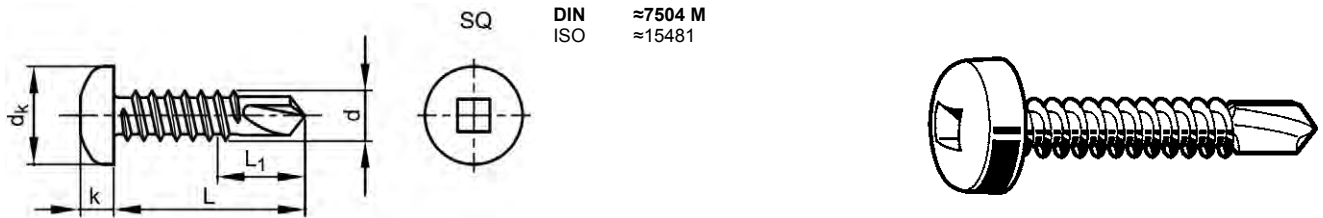

Technical Data

d	d _k	k	L ₁ ≈	No. square	P
ST3.5	6.7	2.6	2	1	1.3
ST4.2	7.9	3.25	3	2	1.4
ST4.8	9.3	3.7	4	2	1.6

26820 Self-drilling pan head screw with square socket J61A

Thread Self tapping thread
Material Steel
Surface treatment Zinc plated



d x L	Art.number	d x L	Art.number	d x L	Art.number
3,5X9,5MM	200 26820.035.009	4,2X16MM	200 26820.042.016	4,2X32MM	200 26820.042.032
3,5X13MM	200 26820.035.013	4,2X19MM	200 26820.042.019	4,8X16MM	200 26820.048.016
4,2X13MM	200 26820.042.013	4,2X25MM	200 26820.042.025		

6

Self drilling screw countersunk head cross recessed

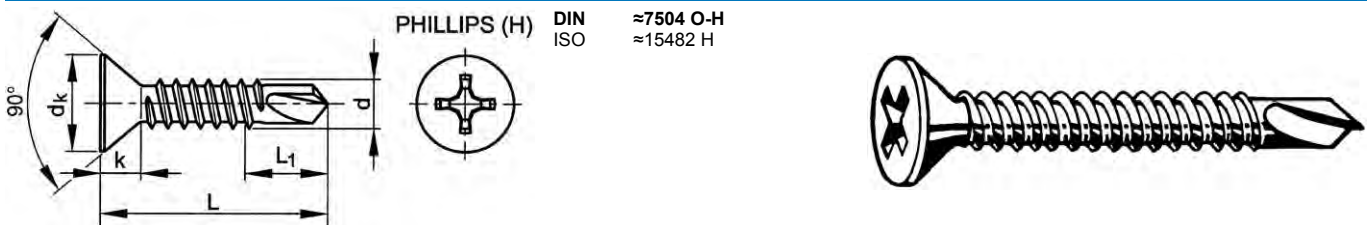

Technical Data

d	d _k	k	L ₁	No. cross recess
ST3.5	6.90 - 7.30	2.35	4	2
ST3.9	8.00 - 8.40	2.60	4.5	2
ST4.2	8.00 - 8.40	2.60	4.5	2
ST4.8	8.90 - 9.30	2.80	6.5	2
ST5.5	9.90 - 10.30	3.00	8	3

Article groups

Thread	Driving features	Material	Surface treatment	Code	Page
ST	Phillips	St	Zipl	30300	6-130
ST	Phillips	St.St. A2		30305	6-131
ST	Phillips	Bi-Metal		30310	6-131

30300 MAXXFAST Self-drilling screw countersunk head Phillips recess MF1A

Thread Self tapping thread
Material Steel
Surface treatment Zinc plated



d x L	Art.number	d x L	Art.number	d x L	Art.number
ST3,5X13MM	200 30300.035.013	ST3,5X25MM	200 30300.035.025	ST3,9X19MM	200 30300.039.019
ST3,5X16MM	200 30300.035.016			ST3,9X22MM	200 30300.039.022
ST3,5X19MM	200 30300.035.019	ST3,9X13MM	200 30300.039.013	ST3,9X25MM	200 30300.039.025
ST3,5X22MM	200 30300.035.022	ST3,9X16MM	200 30300.039.016	ST3,9X32MM	200 30300.039.032

30300 MAXXFAST Self-drilling screw countersunk head Phillips recess

d x L	Art.number	d x L	Art.number	d x L	Art.number
ST4,2X16MM	200 30300.042.016	ST4,8X16MM	200 30300.048.016	ST4,8X50MM	200 30300.048.050
ST4,2X19MM	200 30300.042.019	ST4,8X19MM	200 30300.048.019		
ST4,2X22MM	200 30300.042.022	ST4,8X22MM	200 30300.048.022	ST5,5X22MM	200 30300.055.022
ST4,2X25MM	200 30300.042.025	ST4,8X25MM	200 30300.048.025	ST5,5X25MM	200 30300.055.025
ST4,2X32MM	200 30300.042.032	ST4,8X32MM	200 30300.048.032	ST5,5X32MM	200 30300.055.032
		ST4,8X38MM	200 30300.048.038		
		ST4,8X45MM	200 30300.048.045		

• Full boxes only.

30305 MAXXFAST Self-drilling screw countersunk head Phillips recess
MF1A

Thread Self tapping thread
Material Stainless steel A2

MAXXFAST
PROFESSIONAL HARDWARE

d x L	Art.number	d x L	Art.number	d x L	Art.number
ST3,5X13MM	200 30305.035.013	ST3,9X32MM	200 30305.039.032	ST4,8X22MM	200 30305.048.022
ST3,5X16MM	200 30305.035.016			ST4,8X25MM	200 30305.048.025
ST3,5X19MM	200 30305.035.019	ST4,2X16MM	200 30305.042.016	ST4,8X32MM	200 30305.048.032
ST3,5X22MM	200 30305.035.022	ST4,2X19MM	200 30305.042.019	ST4,8X38MM	200 30305.048.038
ST3,5X25MM	200 30305.035.025	ST4,2X22MM	200 30305.042.022	ST4,8X45MM	200 30305.048.045
		ST4,2X25MM	200 30305.042.025	ST4,8X50MM	200 30305.048.050
ST3,9X13MM	200 30305.039.013	ST4,2X32MM	200 30305.042.032		
ST3,9X16MM	200 30305.039.016			ST5,5X22MM	200 30305.055.022
ST3,9X19MM	200 30305.039.019	ST4,8X16MM	200 30305.048.016	ST5,5X25MM	200 30305.055.025
ST3,9X22MM	200 30305.039.022	ST4,8X19MM	200 30305.048.019	ST5,5X32MM	200 30305.055.032
ST3,9X25MM	200 30305.039.025				

• Full boxes only.

6
30310 MAXXFAST Self-drilling screw countersunk head Phillips recess
MF1A

Thread Self tapping thread
Material Bi-Metal

MAXXFAST
PROFESSIONAL HARDWARE

d x L	Art.number	d x L	Art.number	d x L	Art.number
ST3,5X16MM	200 30310.035.016	ST4,2X16MM	200 30310.042.016	ST4,8X25MM	200 30310.048.025
ST3,5X19MM	200 30310.035.019	ST4,2X19MM	200 30310.042.019	ST4,8X32MM	200 30310.048.032
ST3,5X22MM	200 30310.035.022	ST4,2X22MM	200 30310.042.022	ST4,8X38MM	200 30310.048.038
ST3,5X25MM	200 30310.035.025	ST4,2X25MM	200 30310.042.025	ST4,8X45MM	200 30310.048.045
		ST4,2X32MM	200 30310.042.032	ST4,8X50MM	200 30310.048.050
ST3,9X19MM	200 30310.039.019				
ST3,9X22MM	200 30310.039.022	ST4,8X16MM	200 30310.048.016	ST5,5X22MM	200 30310.055.022
ST3,9X25MM	200 30310.039.025	ST4,8X19MM	200 30310.048.019	ST5,5X25MM	200 30310.055.025
ST3,9X32MM	200 30310.039.032	ST4,8X22MM	200 30310.048.022	ST5,5X32MM	200 30310.055.032

• Full boxes only.

Self-drilling cross recessed countersunk head screw

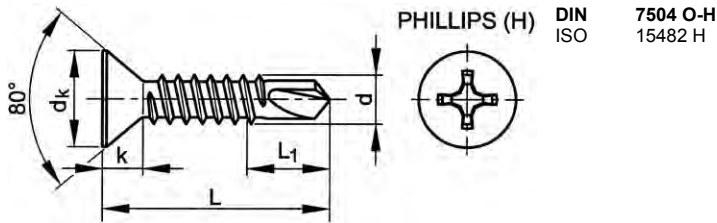

Technical Data

d	d _k	L ₁ ≈	No. cross recess	P
ST3.5	6.8	5	2	1.3
ST3.9	7.5	6	2	1.4
ST4.2	8.1	7	2	1.4
ST4.8	9.5	8	2	1.6
ST5.5	10.8	10	3	1.8
ST6.3	12.4	11	3	1.8

- Max. grip length KL = L - L₁.



Article groups

Thread	Driving features	Material	Surface treatment	Code	Page
ST	Phillips	St	Zipl	31256	6-132
ST	Phillips	St	Zipl	31260	6-132
ST	Phillips	St	Zipl	31830	6-133
ST	Phillips	St.St. A2		31140	6-133
ST	Phillips	St.St. A2		31880	6-133

6

31256 SPEDEC SN Self-drilling cross recessed countersunk head screw Phillips J09A

Thread Self tapping thread
Material Steel
Surface treatment Zinc plated





d x L	Art.number	d x L	Art.number	d x L	Art.number
ST3,5X13MM	200 31256.035.013	ST4,2X32MM	200 31256.042.032	ST4,8X32MM	200 31256.048.032
ST4,2X19MM	200 31256.042.019			ST4,8X38MM	200 31256.048.038

- Warning: electro-galvanizing of these products may cause hydrogen embrittlement.



31260 SPEDEC SN Self-drilling cross recessed countersunk head screw Phillips J09A

Thread Self tapping thread
Material Steel
Surface treatment Zinc plated



d x L	Art.number	d x L	Art.number	d x L	Art.number
ST3,5X13MM	1000 31260.035.013	ST3,9X32MM	1000 31260.039.032	ST4,8X38MM	500 31260.048.038
ST3,5X16MM	1000 31260.035.016			ST4,8X45MM	500 31260.048.045
ST3,5X19MM	1000 31260.035.019	ST4,2X16MM	1000 31260.042.016	ST4,8X50MM	500 31260.048.050
ST3,5X25MM	1000 31260.035.025	ST4,2X19MM	1000 31260.042.019		
		ST4,2X22MM	1000 31260.042.022	ST5,5X32MM	500 31260.055.032
ST3,9X13MM	1000 31260.039.013	ST4,2X25MM	1000 31260.042.025		
ST3,9X16MM	1000 31260.039.016	ST4,2X32MM	1000 31260.042.032	ST6,3X45MM	500 31260.063.045
ST3,9X19MM	1000 31260.039.019			ST6,3X50MM	500 31260.063.050
ST3,9X22MM	1000 31260.039.022	ST4,8X25MM	1000 31260.048.025	ST6,3X55MM	500 31260.063.055
ST3,9X25MM	1000 31260.039.025	ST4,8X32MM	1000 31260.048.032		

- Warning: electro-galvanizing of these products may cause hydrogen embrittlement.

31830 Self-drilling cross recessed countersunk head screw Phillips		J09B
Thread	Self tapping thread	 
Material	Steel	
Surface treatment	Zinc plated	



d x L	☒	Art.number	d x L	☒	Art.number	d x L	☒	Art.number
ST3,5X13MM	2000	31830.035.013	ST3,9X32MM	2000	31830.039.032	ST4,8X25MM	2000	31830.048.025
ST3,5X16MM	2000	31830.035.016				ST4,8X32MM	2000	31830.048.032
ST3,5X19MM	2000	31830.035.019	ST4,2X13MM	2000	31830.042.013	ST4,8X38MM	2000	31830.048.038
ST3,5X25MM	2000	31830.035.025	ST4,2X16MM	2000	31830.042.016	ST4,8X45MM	2000	31830.048.045
			ST4,2X19MM	2000	31830.042.019	ST4,8X50MM	2000	31830.048.050
ST3,9X13MM	2000	31830.039.013	ST4,2X25MM	2000	31830.042.025			
ST3,9X16MM	2000	31830.039.016	ST4,2X32MM	2000	31830.042.032	ST5,5X38MM	250	31830.055.038
ST3,9X19MM	2000	31830.039.019	ST4,2X38MM	2000	31830.042.038			
ST3,9X25MM	2000	31830.039.025						

• Warning: electro-galvanizing of these products may cause hydrogen embrittlement.

31140 SPEDEC SN Self-drilling cross recessed countersunk head screw Phillips		J09A
Thread	Self tapping thread	 
Material	Stainless steel A2	

d x L	☒	Art.number	d x L	☒	Art.number	d x L	☒	Art.number
ST3,5X16MM	1000	31140.035.016	ST4,2X25MM	1000	31140.042.025	ST4,8X25MM	1000	31140.048.025
ST3,9X19MM	1000	31140.039.019						

6

31880 Self-drilling cross recessed countersunk head screw Phillips		J09B
Thread	Self tapping thread	 
Material	Stainless steel A2	

d x L	☒	Art.number	d x L	☒	Art.number	d x L	☒	Art.number
ST3,5X16MM	1000	31880.035.016	ST3,9X19MM	1000	31880.039.019	ST4,2X25MM	1000	31880.042.025

Self-drilling screw countersunk head ttap®

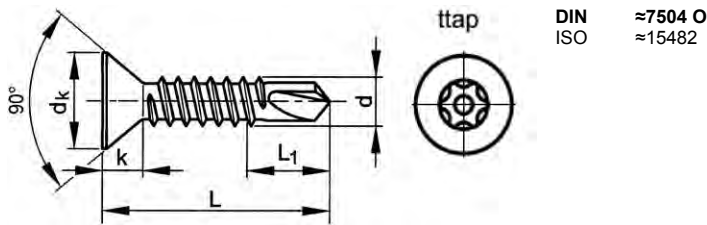

DIN ≈7504 O
ISO ≈15482



Technical Data

d	dk	k	L ₁	No. ttap
ST3.5	6.90 - 7.30	2.35	4	15
ST3.9	7.14 - 7.50	2.60	4.5	20
ST4.2	8.00 - 8.40	2.60	4.5	20
ST4.8	8.90 - 9.30	2.80	6.5	25
ST5.5	9.90 - 10.30	3.00	8	25

Article groups

Thread	Driving features	Material	Surface treatment	Code	Page
ST	ttap®	St	Zipl	30350	6-134
ST	ttap®	St.St. A2		30355	6-134
ST	ttap®	Bi-Metal		30360	6-135

6

30350 MAXXFAST Self-drilling screw countersunk head with ttap® MF1A

Thread: Self tapping thread
Material: Steel
Surface treatment: Zinc plated

MAXXFAST
PROFESSIONAL HARDWARE

d x L	Art.number	d x L	Art.number	d x L	Art.number
ST3,5X13MM	200 30350.035.013	ST3,9X32MM	200 30350.039.032	ST4,8X22MM	200 30350.048.022
ST3,5X16MM	200 30350.035.016	ST4,2X16MM	200 30350.042.016	ST4,8X25MM	200 30350.048.025
ST3,5X19MM	200 30350.035.019	ST4,2X19MM	200 30350.042.019	ST4,8X32MM	200 30350.048.032
ST3,5X22MM	200 30350.035.022	ST4,2X22MM	200 30350.042.022	ST4,8X38MM	200 30350.048.038
ST3,5X25MM	200 30350.035.025	ST4,2X25MM	200 30350.042.025	ST4,8X45MM	200 30350.048.045
ST3,9X13MM	200 30350.039.013	ST4,2X32MM	200 30350.042.032	ST4,8X50MM	200 30350.048.050
ST3,9X16MM	200 30350.039.016			ST5,5X22MM	200 30350.055.022
ST3,9X19MM	200 30350.039.019	ST4,8X16MM	200 30350.048.016	ST5,5X25MM	200 30350.055.025
ST3,9X22MM	200 30350.039.022	ST4,8X19MM	200 30350.048.019	ST5,5X32MM	200 30350.055.032
ST3,9X25MM	200 30350.039.025				

• Full boxes only.

30355 MAXXFAST Self-drilling screw countersunk head with ttap® MF1A

Thread: Self tapping thread
Material: Stainless steel A2

MAXXFAST
PROFESSIONAL HARDWARE

d x L	Art.number	d x L	Art.number	d x L	Art.number
ST3,5X13MM	200 30355.035.013	ST3,9X32MM	200 30355.039.032	ST4,8X25MM	200 30355.048.025
ST3,5X16MM	200 30355.035.016	ST4,2X16MM	200 30355.042.016	ST4,8X32MM	200 30355.048.032
ST3,5X19MM	200 30355.035.019	ST4,2X19MM	200 30355.042.019	ST4,8X38MM	200 30355.048.038
ST3,5X22MM	200 30355.035.022	ST4,2X22MM	200 30355.042.022	ST4,8X45MM	200 30355.048.045
ST3,5X25MM	200 30355.035.025	ST4,2X25MM	200 30355.042.025	ST4,8X50MM	200 30355.048.050
ST3,9X13MM	200 30355.039.013	ST4,2X32MM	200 30355.042.032	ST5,5X22MM	200 30355.055.022
ST3,9X16MM	200 30355.039.016			ST5,5X25MM	200 30355.055.025
ST3,9X19MM	200 30355.039.019	ST4,8X16MM	200 30355.048.016	ST5,5X32MM	200 30355.055.032
ST3,9X22MM	200 30355.039.022	ST4,8X19MM	200 30355.048.019		
ST3,9X25MM	200 30355.039.025	ST4,8X22MM	200 30355.048.022		

• Full boxes only.

30360	MAXXFAST Self-drilling screw countersunk head with ttap®		MF1A
Thread	Self tapping thread		
Material	Bi-Metal		

d x L	☒	Art.number	d x L	☒	Art.number	d x L	☒	Art.number
ST3,5X16MM	200	30360.035.016	ST4,2X16MM	200	30360.042.016	ST4,8X25MM	200	30360.048.025
ST3,5X19MM	200	30360.035.019	ST4,2X19MM	200	30360.042.019	ST4,8X32MM	200	30360.048.032
ST3,5X22MM	200	30360.035.022	ST4,2X22MM	200	30360.042.022	ST4,8X38MM	200	30360.048.038
ST3,5X25MM	200	30360.035.025	ST4,2X25MM	200	30360.042.025	ST4,8X45MM	200	30360.048.045
ST3,9X19MM	200	30360.039.019	ST4,2X32MM	200	30360.042.032	ST4,8X50MM	200	30360.048.050
ST3,9X22MM	200	30360.039.022	ST4,8X16MM	200	30360.048.016	ST5,5X22MM	200	30360.055.022
ST3,9X25MM	200	30360.039.025	ST4,8X19MM	200	30360.048.019	ST5,5X25MM	200	30360.055.025
ST3,9X32MM	200	30360.039.032	ST4,8X22MM	200	30360.048.022	ST5,5X32MM	200	30360.055.032

• Full boxes only.

Self drilling screw hexagon head

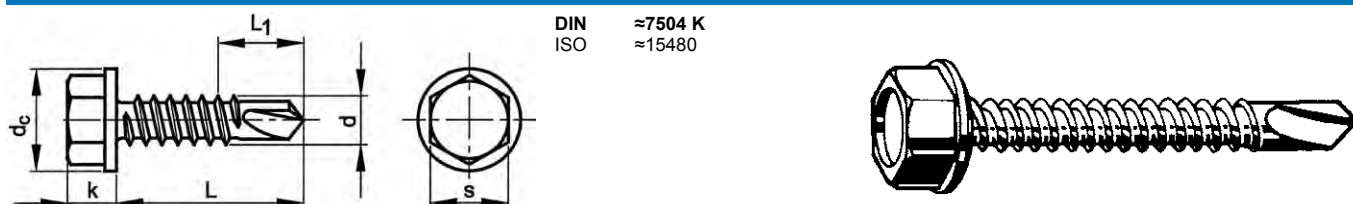

6

Technical Data

d	d _c (max.)	k (max.) - 30410	k (max.) - 30415	k (max.) - 30420	L ₁	s
ST3.9	8.30	3.45	3.45	3.45	4.5	5.5
ST4.2	8.80	4.10	4.10	4.25	4.5	7.0
ST4.8	10.50	4.30	4.30	4.45	5.5	8.0
ST5.5	11	5.40	5.40	5.45	6.5	8.0
ST6.3	13.50	5.90	5.90	6.45	7.5	10.0

Article groups

Thread	Driving features	Material	Surface treatment	Code	Page
ST	Hexagon	St	Zipl	30410	6-135
ST	Hexagon	St.St. A2		30415	6-136
ST	Hexagon	Bi-Metal		30420	6-136

30410	MAXXFAST Self-drilling screw hexagon head		MF1A
Thread	Self tapping thread		
Material	Steel		
Surface treatment	Zinc plated		

d x L	☒	Art.number	d x L	☒	Art.number	d x L	☒	Art.number
ST3,9X19MM	200	30410.039.019	ST4,8X22MM	200	30410.048.022	ST6,3X19MM	200	30410.063.019
ST3,9X25MM	200	30410.039.025	ST4,8X25MM	200	30410.048.025	ST6,3X22MM	200	30410.063.022
ST3,9X32MM	200	30410.039.032	ST4,8X32MM	200	30410.048.032	ST6,3X25MM	200	30410.063.025
ST4,2X13MM	200	30410.042.013	ST4,8X38MM	200	30410.048.038	ST6,3X32MM	200	30410.063.032
ST4,2X16MM	200	30410.042.016	ST4,8X45MM	200	30410.048.045	ST6,3X38MM	200	30410.063.038
ST4,2X19MM	200	30410.042.019	ST4,8X50MM	200	30410.048.050	ST6,3X45MM	200	30410.063.045
ST4,2X22MM	200	30410.042.022	ST5,5X19MM	200	30410.055.019	ST6,3X50MM	200	30410.063.050
ST4,2X25MM	200	30410.042.025	ST5,5X22MM	200	30410.055.022	ST6,3X60MM	200	30410.063.060
ST4,2X32MM	200	30410.042.032	ST5,5X25MM	200	30410.055.025	ST6,3X70MM	200	30410.063.070
ST4,8X13MM	200	30410.048.013	ST5,5X32MM	200	30410.055.032	ST6,3X80MM	100	30410.063.080
ST4,8X16MM	200	30410.048.016	ST5,5X38MM	200	30410.055.038	ST6,3X85MM	100	30410.063.085
ST4,8X19MM	200	30410.048.019	ST5,5X45MM	200	30410.055.045			
			ST5,5X50MM	200	30410.055.050			

• Full boxes only.

30415 MAXXFAST Self-drilling screw hexagon head MF1A

Thread Material: Self tapping thread, Stainless steel A2

MAXXFAST
PROFESSIONAL HARDWARE



d x L	☒	Art.number	d x L	☒	Art.number	d x L	☒	Art.number
ST3,9X19MM	200	30415.039.019	ST4,8X22MM	200	30415.048.022	ST6,3X19MM	200	30415.063.019
ST3,9X25MM	200	30415.039.025	ST4,8X25MM	200	30415.048.025	ST6,3X22MM	200	30415.063.022
ST3,9X32MM	200	30415.039.032	ST4,8X32MM	200	30415.048.032	ST6,3X25MM	200	30415.063.025
ST4,2X13MM	200	30415.042.013	ST4,8X38MM	200	30415.048.038	ST6,3X32MM	200	30415.063.032
ST4,2X16MM	200	30415.042.016	ST4,8X45MM	200	30415.048.045	ST6,3X38MM	200	30415.063.038
ST4,2X19MM	200	30415.042.019	ST4,8X50MM	200	30415.048.050	ST6,3X45MM	200	30415.063.045
ST4,2X22MM	200	30415.042.022	ST5,5X19MM	200	30415.055.019	ST6,3X50MM	200	30415.063.050
ST4,2X25MM	200	30415.042.025	ST5,5X22MM	200	30415.055.022	ST6,3X60MM	200	30415.063.060
ST4,2X32MM	200	30415.042.032	ST5,5X25MM	200	30415.055.025	ST6,3X70MM	200	30415.063.070
ST4,8X13MM	200	30415.048.013	ST5,5X32MM	200	30415.055.032	ST6,3X80MM	100	30415.063.080
ST4,8X16MM	200	30415.048.016	ST5,5X38MM	200	30415.055.038	ST6,3X85MM	100	30415.063.085
ST4,8X19MM	200	30415.048.019	ST5,5X45MM	200	30415.055.045			
			ST5,5X50MM	200	30415.055.050			



• Full boxes only.

6

30420 MAXXFAST Self-drilling screw hexagon head MF1A

Thread Material: Self tapping thread, Bi-Metal

MAXXFAST
PROFESSIONAL HARDWARE

d x L	☒	Art.number	d x L	☒	Art.number	d x L	☒	Art.number
ST3,9X19MM	200	30420.039.019	ST4,8X25MM	200	30420.048.025	ST6,3X19MM	200	30420.063.019
ST3,9X25MM	200	30420.039.025	ST4,8X32MM	200	30420.048.032	ST6,3X22MM	200	30420.063.022
ST3,9X32MM	200	30420.039.032	ST4,8X38MM	200	30420.048.038	ST6,3X25MM	200	30420.063.025
ST4,2X16MM	200	30420.042.016	ST4,8X45MM	200	30420.048.045	ST6,3X32MM	200	30420.063.032
ST4,2X19MM	200	30420.042.019	ST4,8X50MM	200	30420.048.050	ST6,3X38MM	200	30420.063.038
ST4,2X22MM	200	30420.042.022	ST5,5X19MM	200	30420.055.019	ST6,3X45MM	200	30420.063.045
ST4,2X25MM	200	30420.042.025	ST5,5X22MM	200	30420.055.022	ST6,3X50MM	200	30420.063.050
ST4,2X32MM	200	30420.042.032	ST5,5X25MM	200	30420.055.025	ST6,3X60MM	200	30420.063.060
ST4,8X16MM	200	30420.048.016	ST5,5X32MM	200	30420.055.032	ST6,3X70MM	200	30420.063.070
ST4,8X19MM	200	30420.048.019	ST5,5X38MM	200	30420.055.038	ST6,3X80MM	100	30420.063.080
ST4,8X22MM	200	30420.048.022	ST5,5X45MM	200	30420.055.045	ST6,3X85MM	100	30420.063.085
			ST5,5X50MM	200	30420.055.050			

• Full boxes only.

Self-drilling hexagon head screw washer faced

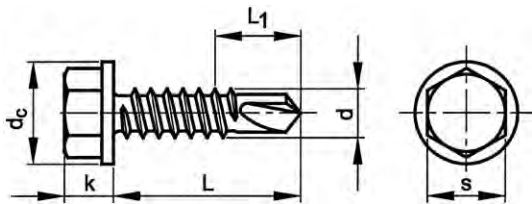

DIN 7504 K
ISO 15480



Technical Data

d	d _c	k (max.)	L ₁ ≈	P	s
ST3.5	8.3	3.4	6.8	1.3	5.5
ST4.2	8.8	4.25	7	1.4	7
ST4.8	10.5	4.45	8	1.6	8
ST5.5	11	5.45	10	1.8	8
ST6.3	13.2	6.45	11	1.8	10

- Max. grip length KL = L - L₁.

Article groups

Thread	Driving features	Material	Surface treatment	Code	Page	
ST	Hexagon	St	Zipl	31235	6-137	
ST	Hexagon	St	Zipl	large pack	31230	6-137
ST	Hexagon	St	Zipl	31815	6-138	
ST	Hexagon	St	Zipl	large pack	31810	6-138
ST	Hexagon	St.St. A2		31100	6-138	
ST	Hexagon	St.St. A2		31860	6-138	

6

31235 SPEDEC SN Self-drilling hexagon head screw washer faced

J09A

Thread Self tapping thread
Material Steel
Surface treatment Zinc plated



d x L	☒	Art.number	d x L	☒	Art.number	d x L	☒	Art.number
ST4,2X13MM	200	31235.042.013	ST4,8X25MM	200	31235.048.025	ST5,5X32MM	100	31235.055.032
ST4,2X16MM	200	31235.042.016	ST4,8X32MM	200	31235.048.032			
ST4,2X19MM	200	31235.042.019	ST4,8X38MM	100	31235.048.038	ST6,3X19MM	200	31235.063.019
ST4,2X25MM	200	31235.042.025	ST4,8X45MM	100	31235.048.045	ST6,3X22MM	200	31235.063.022
ST4,2X32MM	200	31235.042.032	ST4,8X50MM	100	31235.048.050	ST6,3X25MM	200	31235.063.025
						ST6,3X32MM	100	31235.063.032
ST4,8X13MM	200	31235.048.013	ST5,5X19MM	200	31235.055.019	ST6,3X38MM	100	31235.063.038
ST4,8X16MM	200	31235.048.016	ST5,5X22MM	200	31235.055.022	ST6,3X45MM	100	31235.063.045
ST4,8X19MM	200	31235.048.019	ST5,5X25MM	200	31235.055.025	ST6,3X50MM	100	31235.063.050
ST4,8X22MM	200	31235.048.022						

- Warning: electro-galvanizing of these products may cause hydrogen embrittlement.

31230 SPEDEC SN Self-drilling hexagon head screw washer faced

J09A

Thread Self tapping thread
Material Steel
Surface treatment Zinc plated

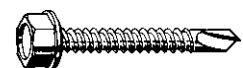

d x L	☒	Art.number	d x L	☒	Art.number	d x L	☒	Art.number
ST4,2X13MM	1000	31230.042.013	ST4,8X25MM	1000	31230.048.025	ST5,5X38MM	500	31230.055.038
ST4,2X16MM	1000	31230.042.016	ST4,8X32MM	1000	31230.048.032			
ST4,2X19MM	1000	31230.042.019	ST4,8X38MM	500	31230.048.038	ST6,3X19MM	500	31230.063.019
ST4,2X25MM	1000	31230.042.025	ST4,8X45MM	500	31230.048.045	ST6,3X22MM	500	31230.063.022
ST4,2X32MM	1000	31230.042.032	ST4,8X50MM	500	31230.048.050	ST6,3X25MM	500	31230.063.025
						ST6,3X32MM	500	31230.063.032
ST4,8X13MM	1000	31230.048.013	ST5,5X19MM	1000	31230.055.019	ST6,3X38MM	500	31230.063.038
ST4,8X16MM	1000	31230.048.016	ST5,5X22MM	1000	31230.055.022	ST6,3X45MM	500	31230.063.045
ST4,8X19MM	1000	31230.048.019	ST5,5X25MM	500	31230.055.025	ST6,3X50MM	500	31230.063.050
ST4,8X22MM	1000	31230.048.022	ST5,5X32MM	500	31230.055.032			

- Warning: electro-galvanizing of these products may cause hydrogen embrittlement.

31815 Self-drilling hexagon head screw washer faced J09B

Thread: Self tapping thread
 Material: Steel
 Surface treatment: Zinc plated





d x L	☒	Art.number	d x L	☒	Art.number	d x L	☒	Art.number
ST3,5X9,5MM	1000	31815.035.009	ST4,2X38MM	1000	31815.042.038	ST5,5X32MM	500	31815.055.032
ST3,5X13MM	1000	31815.035.013				ST5,5X50MM	500	31815.055.050
ST3,5X16MM	1000	31815.035.016	ST4,8X13MM	1000	31815.048.013			
ST3,5X19MM	1000	31815.035.019	ST4,8X16MM	1000	31815.048.016	ST6,3X16MM	500	31815.063.016
ST3,5X25MM	1000	31815.035.025	ST4,8X19MM	1000	31815.048.019	ST6,3X19MM	500	31815.063.019
			ST4,8X25MM	1000	31815.048.025	ST6,3X25MM	500	31815.063.025
ST4,2X13MM	1000	31815.042.013	ST4,8X32MM	1000	31815.048.032	ST6,3X32MM	500	31815.063.032
ST4,2X16MM	1000	31815.042.016	ST4,8X38MM	1000	31815.048.038	ST6,3X38MM	500	31815.063.038
ST4,2X19MM	1000	31815.042.019				ST6,3X50MM	500	31815.063.050
ST4,2X25MM	1000	31815.042.025	ST5,5X19MM	1000	31815.055.019	ST6,3X60MM	500	31815.063.060
ST4,2X32MM	1000	31815.042.032	ST5,5X25MM	500	31815.055.025			

• Warning: electro-galvanizing of these products may cause hydrogen embrittlement.

31810 Self-drilling hexagon head screw washer faced J09B

Thread: Self tapping thread
 Material: Steel
 Surface treatment: Zinc plated





d x L	☒	Art.number	d x L	☒	Art.number	d x L	☒	Art.number
ST4,2X13MM	2000	31810.042.013	ST4,8X16MM	2000	31810.048.016	ST5,5X25MM	1000	31810.055.025
ST4,2X16MM	2000	31810.042.016	ST4,8X19MM	2000	31810.048.019			
ST4,2X19MM	2000	31810.042.019	ST4,8X25MM	2000	31810.048.025	ST6,3X19MM	1000	31810.063.019
ST4,2X25MM	2000	31810.042.025	ST4,8X32MM	2000	31810.048.032	ST6,3X25MM	1000	31810.063.025
ST4,2X32MM	2000	31810.042.032	ST4,8X38MM	2000	31810.048.038	ST6,3X32MM	1000	31810.063.032
						ST6,3X38MM	1000	31810.063.038
ST4,8X13MM	2000	31810.048.013	ST5,5X19MM	2000	31810.055.019	ST6,3X50MM	1000	31810.063.050

• Warning: electro-galvanizing of these products may cause hydrogen embrittlement.

31100 SPEDEC SN Self-drilling hexagon head screw washer faced J09A

Thread: Self tapping thread
 Material: Stainless steel A2

d x L	☒	Art.number	d x L	☒	Art.number	d x L	☒	Art.number
ST4,2X25MM	1000	31100.042.025	ST4,8X32MM	1000	31100.048.032	ST6,3X22MM	1000	31100.063.022
ST4,8X19MM	1000	31100.048.019						

31860 Self-drilling hexagon head screw washer faced J09B

Thread: Self tapping thread
 Material: Stainless steel A2

d x L	☒	Art.number	d x L	☒	Art.number	d x L	☒	Art.number
ST4,2X25MM	2000	31860.042.025	ST4,8X32MM	1000	31860.048.032	ST5,5X22MM	1000	31860.055.022
ST4,8X19MM	1000	31860.048.019						

Self drilling cross recessed screw for back panels



Technical Data

d	dk	k	No. cross recess
4.2	11	2.5	2

Article groups

Thread	Driving features	Material	Surface treatment	Code	Page
ST	Phillips	St	Zipl	29580	6-139
ST	Phillips	St	Zipl blk p.	29581	6-139

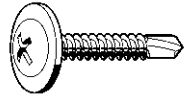
29580	Self drilling cross recessed screw for back panels	K04A
Thread	Self tapping thread	 
Material	Steel	
Surface treatment	Zinc plated	

d x L	⊠	Art.number	d x L	⊠	Art.number	d x L	⊠	Art.number
4,2X13MM	200	29580.042.013	4,2X19MM	200	29580.042.019	4,2X25MM	200	29580.042.025
4,2X16MM	200	29580.042.016						

• Warning: electro-galvanizing of these products may cause hydrogen embrittlement.

29581	Self drilling cross recessed screw for back panels	K04A
Thread	Self tapping thread	
Material	Steel	
Surface treatment	Zinc plated black passivated	

d x L	⊠	Art.number	d x L	⊠	Art.number	d x L	⊠	Art.number
4,2X13MM	200	29581.042.013	4,2X19MM	200	29581.042.019	4,2X25MM	200	29581.042.025
4,2X16MM	200	29581.042.016						

• Warning: electro-galvanizing of these products may cause hydrogen embrittlement.

Self-drilling mushroom head screw with SR recess



Technical Data

d x L	A	B	C	D	d _k	E	F	G	L ₁ ≈	No. SR	P
ST4.8x16	9000	6000	6.5	1	13	3	1.5	4	9	2	1.6
ST4.8x19	9000	6000	6.5	1	15	3	1.5	4	9	2	1.6
ST4.8x25	9000	6000	6.5	1	15	3	1.5	4	9	2	1.6
ST4.8x32	9000	6000	6.5	1	15	3	1.5	4	9	2	1.6

- A = Breaking load min. in N.
- B = Shear strength min. in N.
- C = Ultimate moment in Nm.
- D = Drillcap. in steel cross cross members (min.).
- E = Drillcap. in steel cross cross members (max.).
- F = Drillcap. in aluminium cross cross members (min.).
- G = Drillcap. in aluminium cross cross members (max.).
- Applicable for direct-assembly of plywood and particleboard liners on aluminium and steel cross members.
- Max. grip length KL = L - L₁
- SR-recess is a cross recess/square recess combination. Assembly with SR screwdriver bits, see group code 31630 and 31640.
- Steel with pull-out force max. 540 N/mm².

6

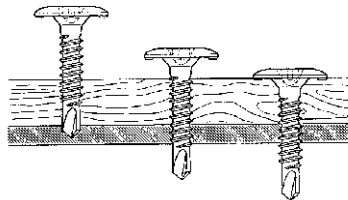

31445 SPEDEC SCI Self-drilling mushroom head screw with SR recess J12A

Thread Self tapping thread
Material Steel
Surface treatment Zinc plated

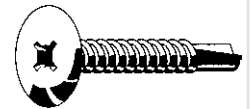

d x L	Art.number	d x L	Art.number	d x L	Art.number
ST4,8X16MM	1000 31445.048.016	ST4,8X25MM	1000 31445.048.025	ST4,8X32MM	1000 31445.048.032
ST4,8X19MM	1000 31445.048.019				

- Warning: electro-galvanizing of these products may cause hydrogen embrittlement.

Self drilling screw countersunk head with wings and ttap®



Technical Data

d	dk	k	L ₁	No. ttap
ST3.9	7.14 - 7.50	2.30	4.5	20
ST4.2	8.00 - 8.40	2.60	4.5	20
ST4.8	8.90 - 9.30	2.80	6.5	25
ST5.5	9.90 - 10.30	3.00	8	25
ST6.3	10.90 - 11.30	3.15	9	25



Article groups

Thread	Driving features	Material	Surface treatment	Code	Page
ST	ttap®	St	Zipl	30365	6-141
ST	ttap®	Bi-Metal		30375	6-141

30365 MAXXFAST Self-drilling screw countersunk head with wings and ttap® MF1A

Thread: Self tapping thread
Material: Steel
Surface treatment: Zinc plated

MAXXFAST
PROFESSIONAL HARDWARE

d x L	Art.number	d x L	Art.number	d x L	Art.number
ST3.9X25MM	200 30365.039.025	ST4.8X45MM	200 30365.048.045	ST6.3X38MM	200 30365.063.038
ST4.2X32MM	200 30365.042.032	ST4.8X50MM	200 30365.048.050	ST6.3X50MM	200 30365.063.050
ST4.8X32MM	200 30365.048.032	ST5.5X38MM	200 30365.055.038	ST6.3X60MM	200 30365.063.060
ST4.8X38MM	200 30365.048.038	ST5.5X45MM	200 30365.055.045		
		ST5.5X50MM	200 30365.055.050		

• Full boxes only.

30375 MAXXFAST Self-drilling screw countersunk head with wings and ttap® MF1A

Thread: Self tapping thread
Material: Bi-Metal

MAXXFAST
PROFESSIONAL HARDWARE

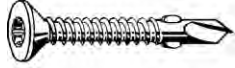
d x L	Art.number	d x L	Art.number	d x L	Art.number
ST3.9X25MM	200 30375.039.025	ST4.8X45MM	200 30375.048.045	ST6.3X38MM	200 30375.063.038
ST4.2X32MM	200 30375.042.032	ST4.8X50MM	200 30375.048.050	ST6.3X50MM	200 30375.063.050
ST4.8X32MM	200 30375.048.032	ST5.5X38MM	200 30375.055.038	ST6.3X60MM	200 30375.063.060
ST4.8X38MM	200 30375.048.038	ST5.5X45MM	200 30375.055.045		
		ST5.5X50MM	200 30375.055.050		

• Full boxes only.

Self-drilling counter screw with wings and Torx® Metric

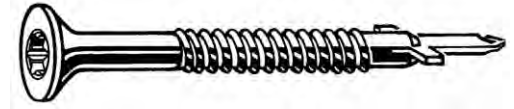
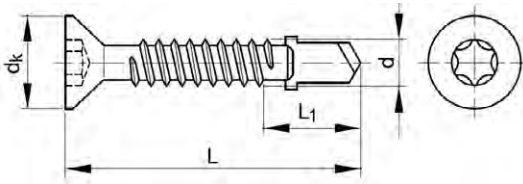

Technical Data

d	A	B	C	D	d _k	E	F	G	L ₁ ≈	P	Socket
ST6.3	17000	10000	16	3	12	6	3	6	25	1.8	T30



- A = Breaking load min. in N.
- B = Shear strength min. in N.
- C = Ultimate moment in Nm.
- D = Drillcap. in steel cross cross members St37 (min.).
- E = Drillcap. in steel cross cross members St37 (max.).
- F = Drillcap. in steel cross cross members St52 (min.).
- G = Drillcap. in steel cross cross members St52 (max.).
- Applicable for direct-assembly of soft wooden beams on steel cross members.
- Max. grip length KL = L – L₁
- St52: With higher steelqualities the max. drilling thickness is reduced.

Special features of FABORY-SPEDEC self-drilling screws type **SCT**:

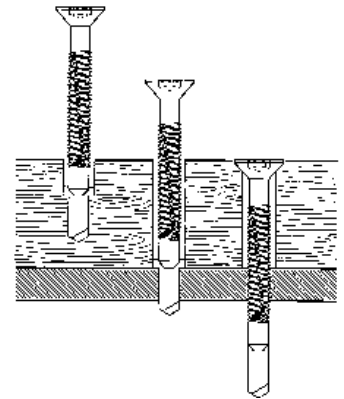
- the normal drilling point has been replaced by a drilling plate of special hardened steel. This type ensures, when the SC self-drilling screws cause problems, that the area of application can be extended considerably
- in one single operation: start of assembly, drilling through wood, drilling through steel, wings breaking off, forming thread, tightening screw, assembly finished (see assembly sequence)
- assembly with electric setting tool type type CF 250(P), see group codes 31570 (31572).



6

31460 SPEDEC SCT Self-drilling countersunk screw with wings and Torx®		J10A
Thread	Self tapping thread	
Material	Steel	
Surface treatment	Zinc plated	
		 

d x L	☒	Art.number	d x L	☒	Art.number	d x L	☒	Art.number
ST6,3X50MM	500	31460.063.050	ST6,3X70MM	500	31460.063.070	ST6,3X90MM	250	31460.063.090
ST6,3X60MM	500	31460.063.060	ST6,3X80MM	500	31460.063.080			

- Warning: electro-galvanizing of these products may cause hydrogen embrittlement.

Self-drilling countersunk screw with wings Torx®

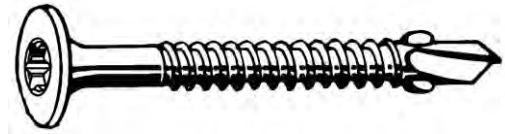
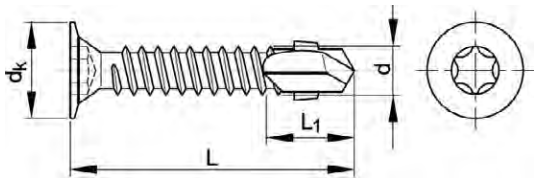

Technical Data

d	A	B	C	D	d _k	E	L ₁ ≈	No. Torx®	P
ST5.5	10000	8000	10	2	12	5	15	T30	1.8

- A = Breaking load min. in N.
- B = Shear strength min. in N.
- C = Ultimate moment in Nm.
- D = Drillcap. in steel cross cross members St37 (min.).
- E = Drillcap. in steel cross cross members St37 (max.).
- Applicable for direct-assembly of soft wooden beams on steel cross members.
- Max. grip length KL = L - L₁
- St37 With higher steelqualities the max. drilling thickness is reduced.

Special features of FABORY-SPEDEC self-drilling screws type **SC**:

- with **pressed** drilling point
- with a **double countersunk head** (31411) for a better bearing surface in soft wood
- with **underhead ribs** (31416) for countersinking in wood
- assembly with electric setting tool type type CF 250(P), see group codes 31570 (31572)

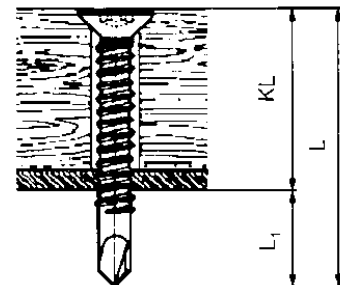



Article groups

Thread	Driving features	Material	Surface treatment	Code	Page	
ST	Torx®	St	Zipl	31416	6-143	
ST	Torx®	St	Zipl	double countersunk	31411	6-143

31416	SPEDEC SC Self-drilling countersunk screw with wings and Torx® recessed					J10A
Thread	Self tapping thread					
Material	Steel					
Surface treatment	Zinc plated					
						

d x L	☒	Art.number	d x L	☒	Art.number	d x L	☒	Art.number
ST5,5X38MM	1000	31416.055.038	ST5,5X50MM	1000	31416.055.050	ST5,5X55MM	1000	31416.055.055
ST5,5X45MM	1000	31416.055.045						

- Warning: electro-galvanizing of these products may cause hydrogen embrittlement.

31411	SPEDEC SC Self-drilling countersunk screw with wings and Torx® recessed					J10A
Thread	Self tapping thread					
Material	Steel					
Surface treatment	Zinc plated					
						

d x L	☒	Art.number	d x L	☒	Art.number	d x L	☒	Art.number
ST5,5X38MM	1000	31411.055.038	ST5,5X50MM	1000	31411.055.050	ST5,5X60MM	1000	31411.055.060
ST5,5X45MM	1000	31411.055.045	ST5,5X55MM	1000	31411.055.055			

- Warning: electro-galvanizing of these products may cause hydrogen embrittlement.

Self-drilling countersunk screw with wings Torx® UNC

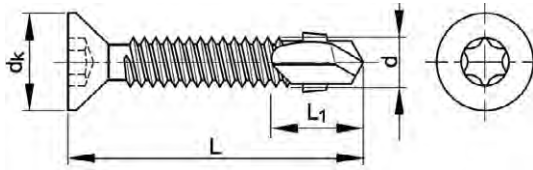

Technical Data

d	A	B	C	D	d _k	E	L ₁ ≈	No. Torx®	Threads per inch
U6.3 (1/4)	17000	10000	16	2.5	12	6	16	T30	20

- A = Breaking load min. in N.
- B = Shear strength min. in N.
- C = Ultimate moment in Nm.
- D = Drillcap. in steel cross cross members St37 (min.).
- E = Drillcap. in steel cross cross members St37 (max.).
- Applicable for direct-assembly of soft wooden beams on steel cross members.
- Max. grip length KL = L - L₁
- St37 With higher steelqualities the max. drilling thickness is reduced.

Special features of FABORY-SPEDEC self-drilling screws type **SC**:

- with **pressed** drilling point
- with **under head ribs** for countersinking in wood
- assembly with electric setting tool type type CF 250(P), see group codes 31570 (31572)

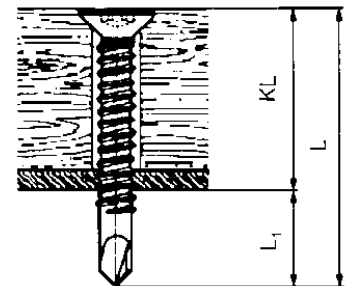

6

31426 SPEDEC SC Self-drilling countersunk screw with wings and Torx®		J10A
Thread	Unified National Coarse	
Material	Steel	
Surface treatment	Zinc plated	



d x L	⊠	Art.number	d x L	⊠	Art.number	d x L	⊠	Art.number
U6,3X45MM	1000	31426.063.045	U6,3X60MM	1000	31426.063.060	U6,3X80MM	500	31426.063.080
U6,3X50MM	1000	31426.063.050	U6,3X65MM	1000	31426.063.065	U6,3X85MM	500	31426.063.085
U6,3X55MM	1000	31426.063.055	U6,3X70MM	500	31426.063.070			

- Warning: electro-galvanizing of these products may cause hydrogen embrittlement.

Self-drilling cross recessed countersunk screw with wings



Technical Data

d	A	B	C	D	d _k	E	L _z	No. cross recess	P
ST4.2	7500	3500	5	0.7	8.1	2	9	2	1.4
ST4.8	11000	6000	8.5	2	9.5	3	10	2	1.6

- A = Breaking load min. in N.
- B = Shear strength min. in N.
- C = Ultimate moment in Nm.
- D = Drillcap. in steel cross cross members St37 (min.).
- E = Drillcap. in steel cross cross members St37 (max.).
- Applicable for direct-assembly of soft wooden beams on steel cross members.
- Max. grip length KL = L - L₁
- St37: With higher steel qualities the max. drilling thickness is reduced.

Special features of FABORY-SPEDEC self-drilling screws type SC:

- with **underhead ribs** for countersinking in wood

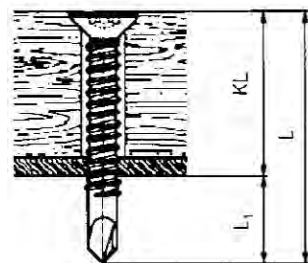

31282 SPEDEC SC Self-drilling cross recessed countersunk screw with wings Phillips		J10A
Thread	Self tapping thread	
Material	Steel	
Surface treatment	Zinc plated	

d x L	☒	Art.number	d x L	☒	Art.number	d x L	☒	Art.number
ST4,2X30MM	500	31282.042.030				ST4,8X45MM	500	31282.048.045
ST4,2X40MM	500	31282.042.040	ST4,8X35MM	500	31282.048.035	ST4,8X65MM	500	31282.048.065

- Warning: electro-galvanizing of these products may cause hydrogen embrittlement.

Self-drilling screws installation tool

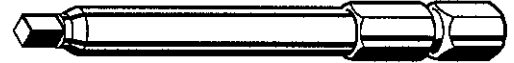

Article groups

Driving features		Code	Page
SR		31535	6-146
	CF 250	31570	6-146
	CF 250P	31572	6-146
Hexagon		31536	6-147

31535 SPEDEC Screwdriver bit type SR J90A



6

Type	☒	Art.number	Type	☒	Art.number
SR2-49	2	31535.001.770	SR1-49	2	31535.001.771

- With 1/4 inch hexagon drive
- Suitable for self-drilling screws with SR recess (cross recess/square recess combination)
- Length 49 mm
- More bits available on www.fabory.com

31570 SPEDEC Setting tool type CF 250 J91A

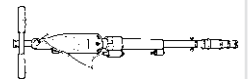

Type	☒	Art.number
COMPLETE TOOL	1	31570.001.770

- Suitable for self-drilling screws type SC (with Torx® TX30) and type SCT (with Torx® TX30)
- Manufacturer screwdriver: Fein ASze 648 d
- Input 740 W
- Voltage 220 V/50 Hz
- Revolutions 0 - 1560 r.p.m. (loaded) and 1250-2600 r.p.m. (unloaded)
- Total length 1080 mm
- Weight 9,8 kg
- Right hand turning
- Adjustable depth-stop
- Upright working position
- Ergonomical
- Theoretical production 250 self-drilling screws by the hour!!

31572 SPEDEC Pneumatic unit type CF 250 P J91A

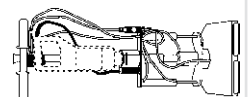

Type	☒	Art.number
CF250	1	31572.001.770

- To rebuild type CF 250.
- No human power necessary!!
- Weight 16,3 kg.

31536 SPEDEC Fix socket type E480

J90A



Type	Art.number
E480	31536.001.770

- With 1/4 inch hexagon drive
- Self-clamping
- Suitable for self drilling hexagon head screws with collar type SN with a width across flats of 8 mm
- Length 73 mm

Maxxfast Wood Screws

Universal screw

The MaxxFast Universal Woodscrew is a unique multi-purpose woodscrew for all kinds of wood applications. These screws have the latest revolutionary technical properties which makes them applicable for all purposes in soft and hard wood, MDF, Plywood, Laminated wood (Melamine) and even in all kinds of hard exotic or tropical wood. However pre-drilling is recommended for hardwood applications.

Technical features:

- Sharp point with Mooncut
- Milling ribs (screws longer > 40mm)
- Wax coating
- Self-countersinking head in two stages
- Cutting ribs
- ttap®

The MaxxFast Universal Woodscrew is available in a wide range of dimensions in Steel, zinc and yellow plated and in Stainless steel. Also available in different head shapes, countersunk and pan head and with ttap®-drive and Pozidriv.

Construction screw

The MaxxFast Wood Construction screw is a unique multi-purpose screw for a wide range of applications in the professional timber construction like timber frame and home construction, staircase construction, carports, fastening and connection of rafters. These screws are exceptionally strong and do not require pre-drilling.

Technical features:

- Sharp point with Mooncut
- Milling ribs
- Wax coating
- Self-countersinking head in two stages or a flange head
- Cutting ribs
- ttap®

The MaxxFast Wood Construction screw is available in a wide range of dimensions in steel yellow passivated, with a self countersinking head or a flange head.

Decking screw

The MaxxFast Decking screw is a unique screw and suitable for outdoor terrace decking in all kinds of hard exotic or tropical wood. However pre-drilling is recommended for hardwood applications. This screw has a very sharp point and two cutting notches which ensures a quick insertion and prevents splitting of the wood.

Technical features:

- Sharp point with 2 cutting notches
- Milling ribs
- Wax coating
- Reduced Self-countersinking head
- Cutting ribs
- ttap®

The MaxxFast Decking screw is available in a wide range of dimensions in Stainless steel A2.

6

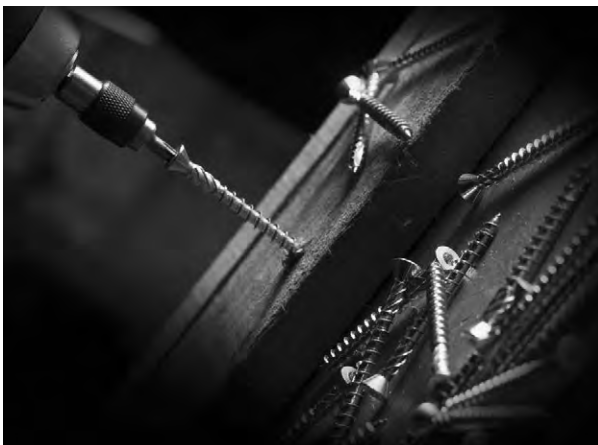

Universal woodscrew cross recessed countersunk head

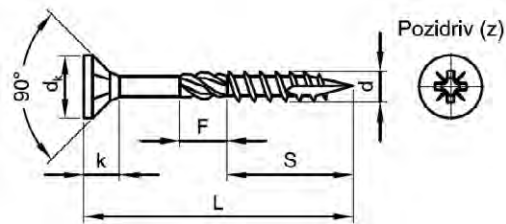

Technical Data

d	dk	k	No. cross recess	d	dk	k	No. cross recess
3	6	3.5	1	4.5	9	5.0	2
3.5	7	4.0	2	5	10	5.5	2
4	8	4.5	2	6	12	6.3	3

- Full boxes only.
- F=9mm only if L≥40mm.
- Diameters 3 and 3,5 are unfit for structural timber joints and therefore not CE marked

Article groups

Driving features	Material	Surface treatment	Code	Page
Pozidriv	St	Zipl	30000	6-149
Pozidriv	St	Zipl yell.p.	30005	6-149
Pozidriv	St.St. A2		30015	6-150

30000 MAXXFAST Universal woodscrew cross recessed countersunk head Pozidriv

MF0A

Material Steel
Surface treatment Zinc plated

MAXXFAST
PROFESSIONAL HARDWARE



CE

d x L (S)	Art.number	d x L (S)	Art.number	d x L (S)	Art.number
3X10MM (6)	200 30000.030.010	4X40MM (25)	200 30000.040.040	5X45MM (30)	200 30000.050.045
3X12MM (8)	200 30000.030.012	4X45MM (30)	200 30000.040.045	5X50MM (35)	200 30000.050.050
3X16MM (12)	200 30000.030.016	4X50MM (35)	200 30000.040.050	5X60MM (45)	200 30000.050.060
3X20MM (16)	200 30000.030.020	4X60MM (45)	200 30000.040.060	5X70MM (54)	200 30000.050.070
3X25MM (21)	200 30000.030.025	4X70MM (54)	200 30000.040.070	5X80MM (54)	100 30000.050.080
3X30MM (26)	200 30000.030.030			5X90MM (60)	100 30000.050.090
3X35MM (31)	200 30000.030.035	4,5X16MM (11)	200 30000.045.016	5X100MM (66)	100 30000.050.100
		4,5X20MM (15)	200 30000.045.020		
3,5X12MM (8)	200 30000.035.012	4,5X25MM (20)	200 30000.045.025	6X30MM (23)	200 30000.060.030
3,5X16MM (12)	200 30000.035.016	4,5X30MM (25)	200 30000.045.030	6X35MM (28)	200 30000.060.035
3,5X20MM (16)	200 30000.035.020	4,5X35MM (30)	200 30000.045.035	6X40MM (25)	200 30000.060.040
3,5X25MM (21)	200 30000.035.025	4,5X40MM (25)	200 30000.045.040	6X45MM (30)	200 30000.060.045
3,5X30MM (26)	200 30000.035.030	4,5X45MM (30)	200 30000.045.045	6X50MM (35)	200 30000.060.050
3,5X35MM (31)	200 30000.035.035	4,5X50MM (35)	200 30000.045.050	6X60MM (45)	200 30000.060.060
3,5X40MM (25)	200 30000.035.040	4,5X60MM (45)	200 30000.045.060	6X70MM (54)	200 30000.060.070
3,5X45MM (30)	200 30000.035.045	4,5X70MM (54)	200 30000.045.070	6X80MM (54)	100 30000.060.080
3,5X50MM (35)	200 30000.035.050	4,5X80MM (54)	200 30000.045.080	6X90MM (60)	100 30000.060.090
				6X100MM (66)	100 30000.060.100
4X12MM (7)	200 30000.040.012	5X16MM (9)	200 30000.050.016	6X110MM (73)	100 30000.060.110
4X16MM (11)	200 30000.040.016	5X20MM (14)	200 30000.050.020	6X120MM (80)	100 30000.060.120
4X20MM (15)	200 30000.040.020	5X25MM (19)	200 30000.050.025	6X130MM (86)	100 30000.060.130
4X25MM (20)	200 30000.040.025	5X30MM (24)	200 30000.050.030	6X140MM (93)	100 30000.060.140
4X30MM (25)	200 30000.040.030	5X35MM (29)	200 30000.050.035	6X150MM (100)	100 30000.060.150
4X35MM (30)	200 30000.040.035	5X40MM (25)	200 30000.050.040		

30005 MAXXFAST Universal woodscrew cross recessed countersunk head Pozidriv

MF0A

Material Steel
Surface treatment Zinc plated yellow passivated

MAXXFAST
PROFESSIONAL HARDWARE



CE

d x L (S)	Art.number	d x L (S)	Art.number	d x L (S)	Art.number
3X10MM (6)	200 30005.030.010	3X35MM (31)	200 30005.030.035	3,5X30MM (26)	200 30005.035.030
3X12MM (8)	200 30005.030.012			3,5X35MM (31)	200 30005.035.035
3X16MM (12)	200 30005.030.016	3,5X12MM (8)	200 30005.035.012	3,5X40MM (25)	200 30005.035.040
3X20MM (16)	200 30005.030.020	3,5X16MM (12)	200 30005.035.016	3,5X45MM (30)	200 30005.035.045
3X25MM (21)	200 30005.030.025	3,5X20MM (16)	200 30005.035.020	3,5X50MM (35)	200 30005.035.050
3X30MM (26)	200 30005.030.030	3,5X25MM (21)	200 30005.035.025		

30005 MAXXFAST Universal woodscrew cross recessed countersunk head Pozidriv

d x L (S)	☒	Art.number	d x L (S)	☒	Art.number	d x L (S)	☒	Art.number
4X12MM (7)	200	30005.040.012	4,5X45MM (30)	200	30005.045.045	5X100MM (66)	100	30005.050.100
4X16MM (11)	200	30005.040.016	4,5X50MM (35)	200	30005.045.050	6X30MM (23)	200	30005.060.030
4X20MM (15)	200	30005.040.020	4,5X60MM (45)	200	30005.045.060	6X35MM (28)	200	30005.060.035
4X25MM (20)	200	30005.040.025	4,5X70MM (54)	200	30005.045.070	6X40MM (25)	200	30005.060.040
4X30MM (25)	200	30005.040.030	4,5X80MM (54)	200	30005.045.080	6X45MM (30)	200	30005.060.045
4X35MM (30)	200	30005.040.035				6X50MM (35)	200	30005.060.050
4X40MM (25)	200	30005.040.040	5X16MM (9)	200	30005.050.016	6X60MM (45)	200	30005.060.060
4X45MM (30)	200	30005.040.045	5X20MM (14)	200	30005.050.020	6X70MM (54)	200	30005.060.070
4X50MM (35)	200	30005.040.050	5X25MM (19)	200	30005.050.025	6X80MM (54)	100	30005.060.080
4X60MM (45)	200	30005.040.060	5X30MM (24)	200	30005.050.030	6X90MM (60)	100	30005.060.090
4X70MM (54)	200	30005.040.070	5X35MM (29)	200	30005.050.035	6X100MM (66)	100	30005.060.100
			5X40MM (25)	200	30005.050.040	6X110MM (73)	100	30005.060.110
4,5X16MM (11)	200	30005.045.016	5X45MM (30)	200	30005.050.045	6X120MM (80)	100	30005.060.120
4,5X20MM (15)	200	30005.045.020	5X50MM (35)	200	30005.050.050	6X130MM (86)	100	30005.060.130
4,5X25MM (20)	200	30005.045.025	5X60MM (45)	200	30005.050.060	6X140MM (93)	100	30005.060.140
4,5X30MM (25)	200	30005.045.030	5X70MM (54)	200	30005.050.070	6X150MM (100)	100	30005.060.150
4,5X35MM (30)	200	30005.045.035	5X80MM (54)	100	30005.050.080			
4,5X40MM (25)	200	30005.045.040	5X90MM (60)	100	30005.050.090			

30015 MAXXFAST Universal woodscrew cross recessed countersunk head Pozidriv MF0A

Material Stainless steel A2



CE

6

d x L (S)	☒	Art.number	d x L (S)	☒	Art.number	d x L (S)	☒	Art.number
3X10MM (6)	200	30015.030.010	4X40MM (25)	200	30015.040.040	5X45MM (30)	200	30015.050.045
3X12MM (8)	200	30015.030.012	4X45MM (30)	200	30015.040.045	5X50MM (35)	200	30015.050.050
3X16MM (12)	200	30015.030.016	4X50MM (35)	200	30015.040.050	5X60MM (45)	200	30015.050.060
3X20MM (16)	200	30015.030.020	4X60MM (45)	200	30015.040.060	5X70MM (54)	200	30015.050.070
3X25MM (21)	200	30015.030.025	4X70MM (54)	200	30015.040.070	5X80MM (54)	100	30015.050.080
3X30MM (26)	200	30015.030.030				5X90MM (60)	100	30015.050.090
3X35MM (31)	200	30015.030.035	4,5X16MM (11)	200	30015.045.016	5X100MM (66)	100	30015.050.100
			4,5X20MM (15)	200	30015.045.020	6X30MM (23)	200	30015.060.030
3,5X12MM (8)	200	30015.035.012	4,5X25MM (20)	200	30015.045.025	6X35MM (28)	200	30015.060.035
3,5X16MM (12)	200	30015.035.016	4,5X30MM (25)	200	30015.045.030	6X40MM (25)	200	30015.060.040
3,5X20MM (16)	200	30015.035.020	4,5X35MM (30)	200	30015.045.035	6X45MM (30)	200	30015.060.045
3,5X25MM (21)	200	30015.035.025	4,5X40MM (25)	200	30015.045.040	6X50MM (35)	200	30015.060.050
3,5X30MM (26)	200	30015.035.030	4,5X45MM (30)	200	30015.045.045	6X60MM (45)	200	30015.060.060
3,5X35MM (31)	200	30015.035.035	4,5X50MM (35)	200	30015.045.050	6X70MM (54)	200	30015.060.070
3,5X40MM (25)	200	30015.035.040	4,5X60MM (45)	200	30015.045.060	6X80MM (54)	100	30015.060.080
3,5X45MM (30)	200	30015.035.045	4,5X70MM (54)	200	30015.045.070	6X90MM (60)	100	30015.060.090
3,5X50MM (35)	200	30015.035.050	4,5X80MM (54)	200	30015.045.080	6X100MM (66)	100	30015.060.100
						6X110MM (73)	100	30015.060.110
4X12MM (7)	200	30015.040.012	5X16MM (9)	200	30015.050.016	6X120MM (80)	100	30015.060.120
4X16MM (11)	200	30015.040.016	5X20MM (14)	200	30015.050.020	6X130MM (86)	100	30015.060.130
4X20MM (15)	200	30015.040.020	5X25MM (19)	200	30015.050.025	6X140MM (93)	100	30015.060.140
4X25MM (20)	200	30015.040.025	5X30MM (24)	200	30015.050.030	6X150MM (100)	100	30015.060.150
4X30MM (25)	200	30015.040.030	5X35MM (29)	200	30015.050.035			
4X35MM (30)	200	30015.040.035	5X40MM (25)	200	30015.050.040			

Universal woodscrew countersunk head with ttap®

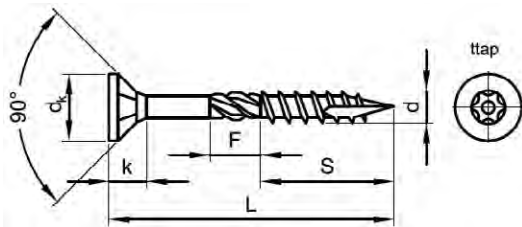

Technical Data

d	dk	k	No. ttap	d	dk	k	No. ttap
3	6	3.5	10	4.5	9	5.0	20
3.5	7	4.0	15	5	10	5.5	25
4	8	4.5	20	6	12	6.3	25

- Full boxes only.
- F=9mm only if L≥40mm.
- Diameters 3 and 3,5 are unfit for structural timber joints and therefore not CE marked

Article groups

Driving features	Material	Surface treatment	Code	Page
ttap®	St	Zipl	30100	6-151
ttap®	St	Zipl yell.p.	30105	6-151
ttap®	St.St. A2		30115	6-152

30100 MAXXFAST Universal woodscrew countersunk head with ttap®

MF0A

Material Steel
Surface treatment Zinc plated

MAXXFAST
PROFESSIONAL HARDWARE



CE

d x L (S)	Art.number	d x L (S)	Art.number	d x L (S)	Art.number
3X10MM (6)	200 30100.030.010	4X40MM (25)	200 30100.040.040	5X45MM (30)	200 30100.050.045
3X12MM (8)	200 30100.030.012	4X45MM (30)	200 30100.040.045	5X50MM (35)	200 30100.050.050
3X16MM (12)	200 30100.030.016	4X50MM (35)	200 30100.040.050	5X60MM (45)	200 30100.050.060
3X20MM (16)	200 30100.030.020	4X60MM (45)	200 30100.040.060	5X70MM (54)	200 30100.050.070
3X25MM (21)	200 30100.030.025	4X70MM (54)	200 30100.040.070	5X80MM (54)	100 30100.050.080
3X30MM (26)	200 30100.030.030			5X90MM (60)	100 30100.050.090
3X35MM (31)	200 30100.030.035	4,5X16MM (11)	200 30100.045.016	5X100MM (66)	100 30100.050.100
		4,5X20MM (15)	200 30100.045.020		
3,5X12MM (8)	200 30100.035.012	4,5X25MM (20)	200 30100.045.025	6X30MM (23)	200 30100.060.030
3,5X16MM (12)	200 30100.035.016	4,5X30MM (25)	200 30100.045.030	6X35MM (28)	200 30100.060.035
3,5X20MM (16)	200 30100.035.020	4,5X35MM (30)	200 30100.045.035	6X40MM (25)	200 30100.060.040
3,5X25MM (21)	200 30100.035.025	4,5X40MM (25)	200 30100.045.040	6X45MM (30)	200 30100.060.045
3,5X30MM (26)	200 30100.035.030	4,5X45MM (30)	200 30100.045.045	6X50MM (35)	200 30100.060.050
3,5X35MM (31)	200 30100.035.035	4,5X50MM (35)	200 30100.045.050	6X60MM (45)	200 30100.060.060
3,5X40MM (25)	200 30100.035.040	4,5X60MM (45)	200 30100.045.060	6X70MM (54)	200 30100.060.070
3,5X45MM (30)	200 30100.035.045	4,5X70MM (54)	200 30100.045.070	6X80MM (54)	100 30100.060.080
3,5X50MM (35)	200 30100.035.050	4,5X80MM (54)	200 30100.045.080	6X90MM (60)	100 30100.060.090
				6X100MM (66)	100 30100.060.100
4X12MM (7)	200 30100.040.012	5X16MM (9)	200 30100.050.016	6X110MM (73)	100 30100.060.110
4X16MM (11)	200 30100.040.016	5X20MM (14)	200 30100.050.020	6X120MM (80)	100 30100.060.120
4X20MM (15)	200 30100.040.020	5X25MM (19)	200 30100.050.025	6X130MM (86)	100 30100.060.130
4X25MM (20)	200 30100.040.025	5X30MM (24)	200 30100.050.030	6X140MM (93)	100 30100.060.140
4X30MM (25)	200 30100.040.030	5X35MM (29)	200 30100.050.035	6X150MM (100)	100 30100.060.150
4X35MM (30)	200 30100.040.035	5X40MM (25)	200 30100.050.040		

30105 MAXXFAST Universal woodscrew countersunk head with ttap®

MF0A

Material Steel
Surface treatment Zinc plated yellow passivated

MAXXFAST
PROFESSIONAL HARDWARE



CE

d x L (S)	Art.number	d x L (S)	Art.number	d x L (S)	Art.number
3X10MM (6)	200 30105.030.010	3X35MM (31)	200 30105.030.035	3,5X30MM (26)	200 30105.035.030
3X12MM (8)	200 30105.030.012			3,5X35MM (31)	200 30105.035.035
3X16MM (12)	200 30105.030.016	3,5X12MM (8)	200 30105.035.012	3,5X40MM (25)	200 30105.035.040
3X20MM (16)	200 30105.030.020	3,5X16MM (12)	200 30105.035.016	3,5X45MM (30)	200 30105.035.045
3X25MM (21)	200 30105.030.025	3,5X20MM (16)	200 30105.035.020	3,5X50MM (35)	200 30105.035.050
3X30MM (26)	200 30105.030.030	3,5X25MM (21)	200 30105.035.025		

30105 MAXXFAST Universal woodscrew countersunk head with ttap®								
d x L (S)	☒	Art.number	d x L (S)	☒	Art.number	d x L (S)	☒	Art.number
4X12MM (7)	200	30105.040.012	4,5X45MM (30)	200	30105.045.045	5X100MM (66)	100	30105.050.100
4X16MM (11)	200	30105.040.016	4,5X50MM (35)	200	30105.045.050			
4X20MM (15)	200	30105.040.020	4,5X60MM (45)	200	30105.045.060	6X30MM (23)	200	30105.060.030
4X25MM (20)	200	30105.040.025	4,5X70MM (54)	200	30105.045.070	6X35MM (28)	200	30105.060.035
4X30MM (25)	200	30105.040.030	4,5X80MM (54)	200	30105.045.080	6X40MM (25)	200	30105.060.040
4X35MM (30)	200	30105.040.035				6X45MM (30)	200	30105.060.045
4X40MM (25)	200	30105.040.040	5X16MM (9)	200	30105.050.016	6X50MM (35)	200	30105.060.050
4X45MM (30)	200	30105.040.045	5X20MM (14)	200	30105.050.020	6X60MM (45)	200	30105.060.060
4X50MM (35)	200	30105.040.050	5X25MM (19)	200	30105.050.025	6X70MM (54)	200	30105.060.070
4X60MM (45)	200	30105.040.060	5X30MM (24)	200	30105.050.030	6X80MM (54)	100	30105.060.080
4X70MM (54)	200	30105.040.070	5X35MM (29)	200	30105.050.035	6X90MM (60)	100	30105.060.090
			5X40MM (25)	200	30105.050.040	6X100MM (66)	100	30105.060.100
4,5X16MM (11)	200	30105.045.016	5X45MM (30)	200	30105.050.045	6X110MM (73)	100	30105.060.110
4,5X20MM (15)	200	30105.045.020	5X50MM (35)	200	30105.050.050	6X120MM (80)	100	30105.060.120
4,5X25MM (20)	200	30105.045.025	5X60MM (45)	200	30105.050.060	6X130MM (86)	100	30105.060.130
4,5X30MM (25)	200	30105.045.030	5X70MM (54)	200	30105.050.070	6X140MM (93)	100	30105.060.140
4,5X35MM (30)	200	30105.045.035	5X80MM (54)	100	30105.050.080	6X150MM (100)	100	30105.060.150
4,5X40MM (25)	200	30105.045.040	5X90MM (60)	100	30105.050.090			

30115 MAXXFAST Universal woodscrew countersunk head with ttap®		MF0A
Material	Stainless steel A2	
CE		

6

d x L (S)	☒	Art.number	d x L (S)	☒	Art.number	d x L (S)	☒	Art.number
3X10MM (6)	200	30115.030.010	4X40MM (25)	200	30115.040.040	5X45MM (30)	200	30115.050.045
3X12MM (8)	200	30115.030.012	4X45MM (30)	200	30115.040.045	5X50MM (35)	200	30115.050.050
3X16MM (12)	200	30115.030.016	4X50MM (35)	200	30115.040.050	5X60MM (45)	200	30115.050.060
3X20MM (16)	200	30115.030.020	4X60MM (45)	200	30115.040.060	5X70MM (54)	200	30115.050.070
3X25MM (21)	200	30115.030.025	4X70MM (54)	200	30115.040.070	5X80MM (54)	100	30115.050.080
3X30MM (26)	200	30115.030.030				5X90MM (60)	100	30115.050.090
3X35MM (31)	200	30115.030.035	4,5X16MM (11)	200	30115.045.016	5X100MM (66)	100	30115.050.100
			4,5X20MM (15)	200	30115.045.020			
3,5X12MM (8)	200	30115.035.012	4,5X25MM (20)	200	30115.045.025	6X30MM (23)	200	30115.060.030
3,5X16MM (12)	200	30115.035.016	4,5X30MM (25)	200	30115.045.030	6X35MM (28)	200	30115.060.035
3,5X20MM (16)	200	30115.035.020	4,5X35MM (30)	200	30115.045.035	6X40MM (25)	200	30115.060.040
3,5X25MM (21)	200	30115.035.025	4,5X40MM (25)	200	30115.045.040	6X45MM (30)	200	30115.060.045
3,5X30MM (26)	200	30115.035.030	4,5X45MM	200	30115.045.045	6X50MM (35)	200	30115.060.050
3,5X35MM (31)	200	30115.035.035	4,5X50MM	200	30115.045.050	6X60MM (45)	200	30115.060.060
3,5X40MM (25)	200	30115.035.040	4,5X60MM (45)	200	30115.045.060	6X70MM (54)	200	30115.060.070
3,5X45MM (30)	200	30115.035.045	4,5X70MM (54)	200	30115.045.070	6X80MM (54)	100	30115.060.080
3,5X50MM (35)	200	30115.035.050	4,5X80MM (54)	200	30115.045.080	6X90MM (60)	100	30115.060.090
						6X100MM (66)	100	30115.060.100
4X12MM (7)	200	30115.040.012	5X16MM (9)	200	30115.050.016	6X110MM (73)	100	30115.060.110
4X16MM (11)	200	30115.040.016	5X20MM (14)	200	30115.050.020	6X120MM (80)	100	30115.060.120
4X20MM (15)	200	30115.040.020	5X25MM (19)	200	30115.050.025	6X130MM (86)	100	30115.060.130
4X25MM (20)	200	30115.040.025	5X30MM (24)	200	30115.050.030	6X140MM (93)	100	30115.060.140
4X30MM (25)	200	30115.040.030	5X35MM (29)	200	30115.050.035	6X150MM (100)	100	30115.060.150
4X35MM (30)	200	30115.040.035	5X40MM (25)	200	30115.050.040			

Chipboard Screws

General

Chipboard screws, also called speedscrews or particle board screws, are specially developed to prevent the problems arising with the application of the conventional woodscrews in chipboard and different types of wood. Chipboard screws have many technical improvements which ensure easy, and with modern tools, fast assembly, so saving on total costs.

Properties

The benefits are achieved by the following properties: adapted geometry of the thread, the thread angle of the wood thread has been diminished from 60° to 40°.

Advantages

With the same major diameter the minor diameter is smaller and of equal thickness over the full screwlength (except the point). The normal length chipboard screws have thread, till just under the head. Depending on have thread, till just under the head. Depending on availability can be supplied fully threaded as well as partially threaded. A sharp selfcentering point, through which easier start of drilling and less risk of wobbling. Expensive and time consuming pre-drilling is often unnecessary. The sharper and deeper profile of the thread does not push aside the material, but cuts into it. Less risk of crumbling and splitting of small, crosscut sides e.g. with the installation of door and window furniture. Besides this a better grip (up to 35% higher pull-out values) and up to 40% lower installation torque.

Material

Chipboard screws are made of stainless steel as well as casehardened steel and surface hardened. They are stronger and more wear resistant than woodscrews, increasing the cutting performance and preventing damage during installation. A toughened core avoids breaking of screw head at bending.

Assembly

Steel chipboard screws are provided with a special corrosion resistant lubricant causing a decrease of the installation torque.

Types

Chipboard screws are available in Pozidriv (Z) and hexalobular recess. Fabory carries, next to the HECO-FIX chipboard screws, an extensive range of MaxxFast universal screws with ttap®-recess. See the relevant product pages in this section for more detailed information.

Technical data

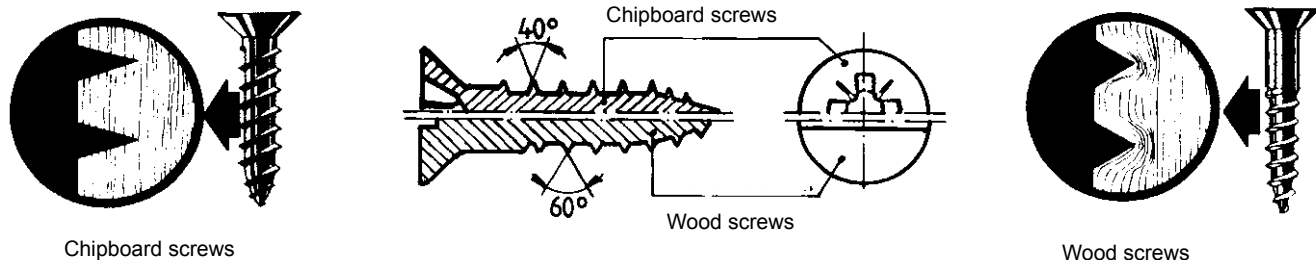

Cross recessed countersunk head screw for chipboard

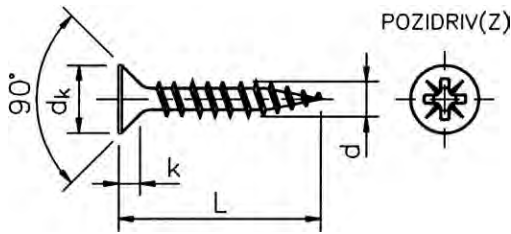

Technical Data

d	d _k (max.)	k (max.)	No. cross recess
2.5	5	1.2	1
3	5.9	1.9	1
3.5	6.9	2.1	2
4	7.9	2.5	2
4.5	8.9	2.7	2
5	9.6	3	2
6	11.6	3.6	3

All dimensions are guide values and may deviate dependent on the manufacturer.

Article groups

Driving features	Material	Surface treatment	Code	Page
Pozidriv	St	Zipl	29240	6-154
Pozidriv	St	Zipl	large pack 29242	6-155
Pozidriv	St	Zipl	HECO-FIX PLUS 29248	6-155
Pozidriv	St	Zipl yell.p.	29440	6-155
Pozidriv	St.St. A2		51750	6-156
Pozidriv	St.St. A4		55750	6-156
Pozidriv	St	Zipl	HECO-TOPIX 29349	6-157
Pozidriv	St	Zipl yell.p.	HECO-TOPIX 29353	6-157
Pozidriv	St	Zipl	HECO-UNIX PLUS 29370	6-157

6

29240 Cross recessed countersunk head screw for chipboard Pozidriv



K01A

Material Steel
Surface treatment Zinc plated





d x L	☒	Art.number	d x L	☒	Art.number	d x L	☒	Art.number
2.5X10MM	200	29240.025.010	4X35MM	200	29240.040.035	5X45MM	200	29240.050.045
2.5X12MM	200	29240.025.012	4X40MM	200	29240.040.040	5X50MM	200	29240.050.050
2.5X16MM	200	29240.025.016	4X45MM	200	29240.040.045	5X60MM	200	29240.050.060
			4X50MM	200	29240.040.050	5X70MM	200	29240.050.070
3X10MM	200	29240.030.010	4X60MM	200	29240.040.060	5X80MM	200	29240.050.080
3X12MM	200	29240.030.012	4X70MM	200	29240.040.070	5X90MM	200	29240.050.090
3X16MM	200	29240.030.016				5X100MM	200	29240.050.100
3X20MM	200	29240.030.020	4,5X16MM	200	29240.045.016			
3X25MM	200	29240.030.025	4,5X20MM	200	29240.045.020	6X30MM	200	29240.060.030
3X30MM	200	29240.030.030	4,5X25MM	200	29240.045.025	6X35MM	200	29240.060.035
3X35MM	200	29240.030.035	4,5X30MM	200	29240.045.030	6X40MM	200	29240.060.040
			4,5X35MM	200	29240.045.035	6X45MM	200	29240.060.045
3,5X12MM	200	29240.035.012	4,5X40MM	200	29240.045.040	6X50MM	200	29240.060.050
3,5X16MM	200	29240.035.016	4,5X45MM	200	29240.045.045	6X60MM	200	29240.060.060
3,5X20MM	200	29240.035.020	4,5X50MM	200	29240.045.050	6X70MM	200	29240.060.070
3,5X25MM	200	29240.035.025	4,5X60MM	200	29240.045.060	6X80MM	200	29240.060.080
3,5X30MM	200	29240.035.030	4,5X70MM	200	29240.045.070	6X90MM	200	29240.060.090
3,5X35MM	200	29240.035.035	4,5X80MM	200	29240.045.080	6X100MM	200	29240.060.100
3,5X40MM	200	29240.035.040				6X110MM	200	29240.060.110
			5X20MM	200	29240.050.020	6X120MM	200	29240.060.120
4X12MM	200	29240.040.012	5X25MM	200	29240.050.025	6X130MM	200	29240.060.130
4X16MM	200	29240.040.016	5X30MM	200	29240.050.030	6X140MM	200	29240.060.140
4X20MM	200	29240.040.020	5X35MM	200	29240.050.035	6X150MM	200	29240.060.150
4X25MM	200	29240.040.025	5X40MM	200	29240.050.040	6X160MM	100	29240.060.160
4X30MM	200	29240.040.030						

Warning: electro-galvanizing of these products may cause hydrogen embrittlement.

29242 Cross recessed countersunk head screw for chipboard Pozidriv		K01A
Material	Steel	 
Surface treatment	Zinc plated	

d x L	☒	Art.number	d x L	☒	Art.number	d x L	☒	Art.number
3X16MM	2000	29242.030.016	3,5X25MM	2000	29242.035.025	4X25MM	2000	29242.040.025
3X20MM	2000	29242.030.020	3,5X30MM	2000	29242.035.030	4X30MM	2000	29242.040.030
3X25MM	2000	29242.030.025	3,5X40MM	2000	29242.035.040	4X35MM	2000	29242.040.035
3,5X16MM	2000	29242.035.016	4X16MM	2000	29242.040.016	4X40MM	2000	29242.040.040
3,5X20MM	2000	29242.035.020	4X20MM	2000	29242.040.020	4X45MM	2000	29242.040.045
						4X50MM	2000	29242.040.050

- Warning: electro-galvanizing of these products may cause hydrogen embrittlement.

29248 HECO-FIX PLUS Cross recessed countersunk head screw for chipboard Pozidriv		K04A
Material	Steel	  
Surface treatment	Zinc plated	

d x L	☒	Art.number	d x L	☒	Art.number	d x L	☒	Art.number
2,5X10MM	200	29248.025.010	4X20MM	200	29248.040.020	5X40MM	200	29248.050.040
2,5X12MM	200	29248.025.012	4X25MM	200	29248.040.025	5X45MM	200	29248.050.045
2,5X16MM	200	29248.025.016	4X30MM	200	29248.040.030	5X50MM	200	29248.050.050
2,5X20MM	200	29248.025.020	4X35MM	200	29248.040.035	5X60MM	200	29248.050.060
3X10MM	200	29248.030.010	4X40MM	200	29248.040.040	5X70MM	200	29248.050.070
3X12MM	200	29248.030.012	4X45MM	200	29248.040.045	5X80MM	200	29248.050.080
3X16MM	200	29248.030.016	4X50MM	200	29248.040.050	5X90MM	200	29248.050.090
3X20MM	200	29248.030.020	4X55MM	200	29248.040.055	5X100MM	200	29248.050.100
3X25MM	200	29248.030.025	4X60MM	200	29248.040.060			
3X30MM	200	29248.030.030	4X70MM	200	29248.040.070	6X30MM	200	29248.060.030
3X35MM	200	29248.030.035	4,5X16MM	200	29248.045.016	6X35MM	200	29248.060.035
3X40MM	200	29248.030.040	4,5X20MM	200	29248.045.020	6X40MM	200	29248.060.040
3X45MM	500	29248.030.045	4,5X25MM	200	29248.045.025	6X45MM	200	29248.060.045
3,5X12MM	1000	29248.035.012	4,5X30MM	200	29248.045.030	6X50MM	200	29248.060.050
3,5X15MM	200	29248.035.015	4,5X35MM	200	29248.045.035	6X60MM	200	29248.060.060
3,5X16MM	200	29248.035.016	4,5X40MM	200	29248.045.040	6X70MM	200	29248.060.070
3,5X20MM	200	29248.035.020	4,5X45MM	200	29248.045.045	6X80MM	100	29248.060.080
3,5X25MM	200	29248.035.025	4,5X50MM	200	29248.045.050	6X90MM	100	29248.060.090
3,5X30MM	200	29248.035.030	4,5X55MM	200	29248.045.055	6X100MM	100	29248.060.100
3,5X35MM	200	29248.035.035	4,5X60MM	200	29248.045.060	6X110MM	100	29248.060.110
3,5X40MM	200	29248.035.040	4,5X70MM	200	29248.045.070	6X120MM	100	29248.060.120
3,5X45MM	200	29248.035.045	4,5X80MM	200	29248.045.080	6X130MM	100	29248.060.130
3,5X50MM	200	29248.035.050	5X20MM	200	29248.050.020	6X140MM	100	29248.060.140
4X16MM	200	29248.040.016	5X25MM	200	29248.050.025	6X150MM	100	29248.060.150
			5X30MM	200	29248.050.030	6X160MM	100	29248.060.160
			5X35MM	200	29248.050.035	6X180MM	100	29248.060.180
						6X200MM	100	29248.060.200

- Specific features HECO-FIX PLUS screws for chipboard:
- Reduction of required drive torque of up to 30%.
- Easier handling.
- Substantially higher screwing performance on using storage battery screw drivers.
- Axial forces are reduced, thereby less wear of screw driver bits.
- By means of the tooth geometry, a higher unscrewing moment is nevertheless achieved and consequently, a secure screwed connection is obtained.
- Warning: electro-galvanizing of these products may cause hydrogen embrittlement

29440 Cross recessed countersunk head screw for chipboard Pozidriv		K01B
Material	Steel	
Surface treatment	Zinc plated yellow passivated	

d x L	☒	Art.number	d x L	☒	Art.number	d x L	☒	Art.number
2,5X12MM	200	29440.025.013	3X25MM	200	29440.030.025	3,5X35MM	200	29440.035.035
2,5X15MM	200	29440.025.015	3X30MM	200	29440.030.030	3,5X40MM	200	29440.035.040
2,5X16MM	200	29440.025.016	3X35MM	200	29440.030.035	3,5X45MM	200	29440.035.045
2,5X17MM	200	29440.025.017				3,5X50MM	200	29440.035.050
3X10MM	200	29440.030.010	3,5X12MM	200	29440.035.012			
3X12MM	200	29440.030.012	3,5X16MM	200	29440.035.016	4X12MM	200	29440.040.012
3X16MM	200	29440.030.016	3,5X20MM	200	29440.035.020	4X16MM	200	29440.040.016
3X20MM	200	29440.030.020	3,5X25MM	200	29440.035.025	4X20MM	200	29440.040.020
			3,5X30MM	200	29440.035.030	4X25MM	200	29440.040.025



29440 Cross recessed countersunk head screw for chipboard Pozidriv

d x L	☒	Art.number	d x L	☒	Art.number	d x L	☒	Art.number
4X30MM	200	29440.040.030	4,5X60MM	200	29440.045.060	5X100MM	200	29440.050.100
4X35MM	200	29440.040.035	4,5X70MM	200	29440.045.070	6X30MM	200	29440.060.030
4X40MM	200	29440.040.040	4,5X80MM	200	29440.045.080	6X40MM	200	29440.060.040
4X45MM	200	29440.040.045				6X50MM	200	29440.060.050
4X50MM	200	29440.040.050	5X20MM	200	29440.050.020	6X60MM	200	29440.060.060
4X60MM	200	29440.040.060	5X25MM	200	29440.050.025	6X70MM	200	29440.060.070
4X70MM	200	29440.040.070	5X30MM	200	29440.050.030	6X80MM	200	29440.060.080
4,5X16MM	200	29440.045.016	5X35MM	200	29440.050.035	6X90MM	200	29440.060.090
4,5X20MM	200	29440.045.020	5X40MM	200	29440.050.040	6X100MM	200	29440.060.100
4,5X25MM	200	29440.045.025	5X45MM	200	29440.050.045	6X110MM	200	29440.060.110
4,5X30MM	200	29440.045.030	5X50MM	200	29440.050.050	6X120MM	200	29440.060.120
4,5X35MM	200	29440.045.035	5X55MM	200	29440.050.055	6X130MM	200	29440.060.130
4,5X40MM	200	29440.045.040	5X60MM	200	29440.050.060	6X140MM	200	29440.060.140
4,5X45MM	200	29440.045.045	5X70MM	200	29440.050.070	6X150MM	200	29440.060.150
4,5X50MM	200	29440.045.050	5X80MM	200	29440.050.080			
			5X90MM	200	29440.050.090			

• Warning: electro-galvanizing of these products may cause hydrogen embrittlement.

51750 Cross recessed countersunk head screw for chipboard Pozidriv



Material Stainless steel A2 **R03A**

d x L	☒	Art.number	d x L	☒	Art.number	d x L	☒	Art.number
3X10MM	200	51750.030.010	4X25MM	200	51750.040.025	5X45MM	200	51750.050.045
3X12MM	200	51750.030.012	4X30MM	200	51750.040.030	5X50MM	200	51750.050.050
3X13MM	200	51750.030.013	4X35MM	200	51750.040.035	5X55MM*	200	51750.050.055
3X14MM	200	51750.030.014	4X40MM	200	51750.040.040	5X60MM	200	51750.050.060
3X16MM	200	51750.030.016	4X45MM	200	51750.040.045	5X65MM*	100	51750.050.065
3X20MM	200	51750.030.020	4X50MM	200	51750.040.050	5X70MM	200	51750.050.070
3X25MM	200	51750.030.025	4X60MM	200	51750.040.060	5X80MM	200	51750.050.080
3X30MM	200	51750.030.030	4X70MM	200	51750.040.070	5X90MM	100	51750.050.090
3X35MM	200	51750.030.035				5X100MM	100	51750.050.100
3X40MM	200	51750.030.040	4,5X20MM	200	51750.045.020	5X120MM	100	51750.050.120
3X50MM*	200	51750.030.050	4,5X25MM	200	51750.045.025	6X20MM*	100	51750.060.020
			4,5X30MM	200	51750.045.030	6X25MM*	100	51750.060.025
3,5X12MM*	500	51750.035.012	4,5X35MM	200	51750.045.035	6X30MM	100	51750.060.030
3,5X13MM	200	51750.035.013	4,5X40MM	200	51750.045.040	6X35MM	100	51750.060.035
3,5X16MM	200	51750.035.016	4,5X45MM	200	51750.045.045	6X40MM	100	51750.060.040
3,5X20MM	200	51750.035.020	4,5X50MM	200	51750.045.050	6X45MM	100	51750.060.045
3,5X25MM	200	51750.035.025	4,5X60MM	200	51750.045.060	6X50MM	100	51750.060.050
3,5X30MM	200	51750.035.030	4,5X70MM	200	51750.045.070	6X60MM	100	51750.060.060
3,5X35MM	200	51750.035.035				6X70MM	100	51750.060.070
3,5X40MM	200	51750.035.040	5X20MM	200	51750.050.020	6X80MM	100	51750.060.080
			5X25MM	200	51750.050.025	6X90MM	100	51750.060.090
4X12MM*	500	51750.040.012	5X30MM	200	51750.050.030	6X100MM	100	51750.060.100
4X16MM	200	51750.040.016	5X35MM	200	51750.050.035	6X110MM	100	51750.060.110
4X20MM	200	51750.040.020	5X40MM	200	51750.050.040	6X120MM	100	51750.060.120

55750 Cross recessed countersunk head screw for chipboard Pozidriv

Material Stainless steel A4 **R43A**

d x L	☒	Art.number	d x L	☒	Art.number	d x L	☒	Art.number
3X12MM	200	55750.030.012	4X20MM	200	55750.040.020	5X20MM*	500	55750.050.020
3X16MM	200	55750.030.016	4X25MM	200	55750.040.025	5X30MM	200	55750.050.030
3X20MM	200	55750.030.020	4X30MM	200	55750.040.030	5X40MM	200	55750.050.040
3X25MM	200	55750.030.025	4X35MM	200	55750.040.035	5X50MM	200	55750.050.050
3X30MM	200	55750.030.030	4X40MM	200	55750.040.040	5X60MM	200	55750.050.060
			4X45MM	200	55750.040.045	5X65MM*	100	55750.050.065
3,5X12MM	200	55750.035.012	4X50MM	200	55750.040.050	5X70MM	200	55750.050.070
3,5X16MM	200	55750.035.016	4X60MM	200	55750.040.060			
3,5X20MM	200	55750.035.020	4X70MM*	200	55750.040.070	6X40MM	100	55750.060.040
3,5X25MM	200	55750.035.025				6X50MM*	100	55750.060.050
3,5X30MM	200	55750.035.030	4,5X20MM*	500	55750.045.020	6X60MM	100	55750.060.060
3,5X35MM	200	55750.035.035	4,5X40MM*	200	55750.045.040	6X70MM	100	55750.060.070
3,5X40MM	200	55750.035.040	4,5X45MM*	200	55750.045.045	6X80MM	100	55750.060.080
			4,5X50MM*	200	55750.045.050	6X90MM	100	55750.060.090
4X12MM	200	55750.040.012	4,5X60MM*	200	55750.045.060			
4X16MM	200	55750.040.016	4,5X70MM*	200	55750.045.070			

29349 HECO TOPIX Cross recessed countersunk head screw for chipboard Pozidriv K04A

Material	Steel	 	
Surface treatment	Zinc plated		

d x L	☒	Art.number	d x L	☒	Art.number	d x L	☒	Art.number
3,5X20MM	1000	29349.035.020	4X50MM	500	29349.040.050	5X60MM	200	29349.050.060
3,5X25MM	1000	29349.035.025	4X60MM	200	29349.040.060	5X70MM	200	29349.050.070
3,5X30MM	1000	29349.035.030	4X70MM	200	29349.040.070	5X80MM	200	29349.050.080
3,5X35MM	1000	29349.035.035				5X90MM	200	29349.050.090
3,5X40MM	500	29349.035.040	4,5X30MM	500	29349.045.030	5X100MM	200	29349.050.100
3,5X45MM	500	29349.035.045	4,5X35MM	500	29349.045.035	5X120MM	100	29349.050.120
3,5X50MM	500	29349.035.050	4,5X40MM	500	29349.045.040			
			4,5X45MM	500	29349.045.045	6X50MM	200	29349.060.050
4X25MM	1000	29349.040.025	4,5X50MM	200	29349.045.050	6X80MM	200	29349.060.080
4X30MM	1000	29349.040.030	4,5X60MM	200	29349.045.060	6X100MM	100	29349.060.100
4X35MM	1000	29349.040.035				6X110MM	100	29349.060.110
4X40MM	500	29349.040.040	5X40MM	500	29349.050.040	6X120MM	100	29349.060.120
4X45MM	500	29349.040.045	5X50MM	200	29349.050.050			

• Warning: electro-galvanizing of these products may cause hydrogen embrittlement.

29353 HECO TOPIX Cross recessed countersunk head screw for chipboard Pozidriv K04A

Material	Steel		
Surface treatment	Zinc plated yellow passivated		

d x L	☒	Art.number	d x L	☒	Art.number	d x L	☒	Art.number
3,5X15MM	1000	29353.035.015	4X60MM	200	29353.040.060	5X60MM	200	29353.050.060
3,5X30MM	1000	29353.035.030				5X70MM	200	29353.050.070
3,5X35MM	1000	29353.035.035	4,5X30MM	500	29353.045.030	5X80MM	200	29353.050.080
			4,5X35MM	500	29353.045.035			
4X25MM	1000	29353.040.025	4,5X40MM	500	29353.045.040	6X80MM	100	29353.060.080
4X30MM	1000	29353.040.030	4,5X70MM	200	29353.045.070	6X90MM	100	29353.060.090
4X35MM	500	29353.040.035				6X100MM	100	29353.060.100
4X40MM	500	29353.040.040	5X40MM	500	29353.050.040	6X120MM	100	29353.060.120
4X50MM	500	29353.040.050	5X50MM	200	29353.050.050			

• Warning: electro-galvanizing of these products may cause hydrogen embrittlement.

29370 HECO UNIX PLUS Cross recessed countersunk head screw for chipboard Pozidriv K04A

Material	Steel	 	
Surface treatment	Zinc plated		

d x L	☒	Art.number	d x L	☒	Art.number	d x L	☒	Art.number
3,5X20MM	1000	29370.035.020	4X60MM	200	29370.040.060	5X45MM	200	29370.050.045
3,5X25MM	1000	29370.035.025				5X50MM	200	29370.050.050
3,5X30MM	1000	29370.035.030	4,5X25MM	500	29370.045.025	5X60MM	200	29370.050.060
3,5X35MM	1000	29370.035.035	4,5X30MM	500	29370.045.030	5X80MM	200	29370.050.080
3,5X40MM	500	29370.035.040	4,5X35MM	500	29370.045.035			
3,5X50MM	500	29370.035.050	4,5X40MM	500	29370.045.040	6X35MM	200	29370.060.035
			4,5X45MM	500	29370.045.045	6X40MM	200	29370.060.040
4X25MM	1000	29370.040.025	4,5X50MM	200	29370.045.050	6X45MM	200	29370.060.045
4X30MM	1000	29370.040.030	4,5X60MM	200	29370.045.060	6X50MM	200	29370.060.050
4X35MM	500	29370.040.035				6X60MM	200	29370.060.060
4X40MM	500	29370.040.040	5X30MM	500	29370.050.030	6X80MM	100	29370.060.080
4X45MM	500	29370.040.045	5X35MM	500	29370.050.035	6X100MM	100	29370.060.100
4X50MM	500	29370.040.050	5X40MM	500	29370.050.040	6X120MM	100	29370.060.120

• Warning: electro-galvanizing of these products may cause hydrogen embrittlement.

Cross recessed countersunk head screw with hole for chipboard

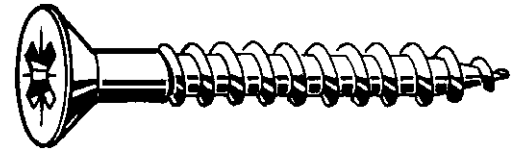
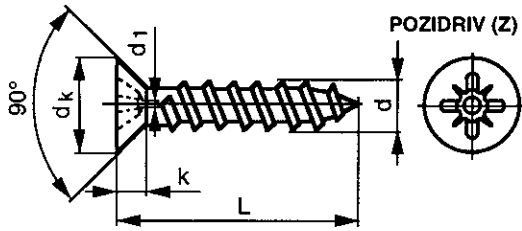

Technical Data

d	d ₁	d _k	k	No. cross recess
4	2.5	8	2.6	2
4.5	2.5	9	2.9	2
5	2.5	10	3.2	2
6	2.5	12	3.9	3

• All dimensions are guide values and may deviate dependent on the manufacturer.

29385 Cross recessed countersunk head screw with hole for chipboard Pozidriv

K03A

Material Steel
Surface treatment Zinc plated



6

d x L	☒	Art.number	d x L	☒	Art.number	d x L	☒	Art.number
4X50MM	200	29385.040.050	4,5X60MM	200	29385.045.060	6X50MM	200	29385.060.050
4,5X20MM	200	29385.045.020	4,5X70MM	200	29385.045.070	6X60MM	100	29385.060.060
4,5X25MM	200	29385.045.025	5X40MM	200	29385.050.040	6X70MM	100	29385.060.070
4,5X30MM	200	29385.045.030	5X50MM	200	29385.050.050	6X80MM	100	29385.060.080
4,5X35MM	200	29385.045.035	5X60MM	200	29385.050.060	6X90MM	100	29385.060.090
4,5X40MM	200	29385.045.040	5X70MM	200	29385.050.070	6X100MM	100	29385.060.100
4,5X45MM	200	29385.045.045	5X80MM	200	29385.050.080	6X110MM	100	29385.060.110
4,5X50MM	200	29385.045.050	5X100MM	200	29385.050.100			

• Warning: electro-galvanizing of these products may cause hydrogen embrittlement.

Cross recessed small countersunk head screw for chipboard

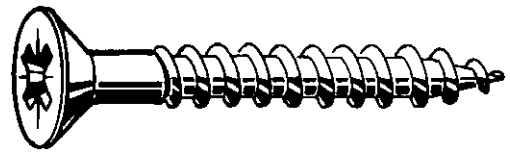
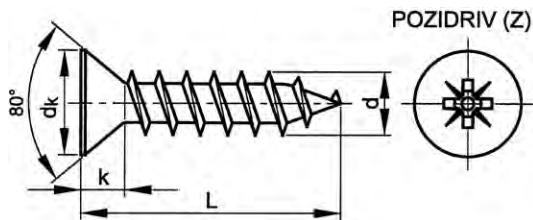

Technical Data

d	d _k	k	No. cross recess
3	5	1.9	1

- All dimensions are guide values and may deviate dependent on the manufacturer.

29243 Cross recessed small countersunk head screw for chipboard Pozidriv

K03A

Material Steel
Surface treatment Zinc plated yellow passivated



d x L	☒	Art.number	d x L	☒	Art.number	d x L	☒	Art.number
3X13MM	200	29243.030.013	3X17MM	200	29243.030.017	3X25MM	200	29243.030.025
3X15MM	200	29243.030.015	3X20MM	200	29243.030.020			

- Warning: electro-galvanizing of these products may cause hydrogen embrittlement.

Hexalobular socket countersunk head screw for chipboard

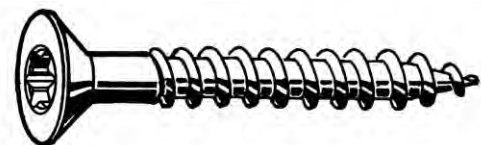
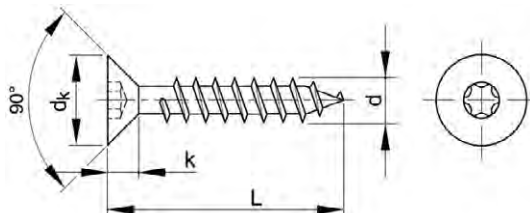

Technical Data

d	d _k	k	Socket	d	d _k	k	Socket
3	6	1.9	T10	5	10	3.2	T25
3.5	7	2.3	T15	6	12	3.5	T30
4	8	2.6	T20	8	14	4.1	T40
4.5	9	2.9	T25				

- All dimensions are guide values and may deviate dependent on the manufacturer.

Article groups

Driving features	Material	Surface treatment	Code	Page
Hexalobular	St	Zipl	29310	6-159
Hexalobular	St	Zipl	HECO-TOPIX	6-160
Hexalobular	St	Zipl	HECO-UNIX TOP	6-160
Hexalobular	St.St. A2		51775	6-160
Hexalobular	St.St. A4		55775	6-161

29310 Hexalobular socket countersunk head screw for chipboard

K01A



Material Steel
Surface treatment Zinc plated



d x L	☒	Art.number	d x L	☒	Art.number	d x L	☒	Art.number
3X16MM	200	29310.030.016	3X30MM	200	29310.030.030	3,5X20MM	200	29310.035.020
3X20MM	200	29310.030.020				3,5X25MM	200	29310.035.025
3X25MM	200	29310.030.025	3,5X16MM	200	29310.035.016	3,5X30MM	200	29310.035.030



29310 Hexalobular socket countersunk head screw for chipboard								
d x L	☒	Art.number	d x L	☒	Art.number	d x L	☒	Art.number
3,5X35MM	200	29310.035.035				5X25MM	1000	29310.050.025
3,5X40MM	200	29310.035.040	4,5X20MM	200	29310.045.020	5X30MM	200	29310.050.030
4X16MM	200	29310.040.016	4,5X25MM	200	29310.045.025	5X35MM	200	29310.050.035
4X20MM	200	29310.040.020	4,5X30MM	200	29310.045.030	5X40MM	200	29310.050.040
4X25MM	200	29310.040.025	4,5X35MM	200	29310.045.035	5X45MM	200	29310.050.045
4X30MM	200	29310.040.030	4,5X40MM	200	29310.045.040	5X50MM	200	29310.050.050
4X35MM	200	29310.040.035	4,5X45MM	200	29310.045.045	5X60MM	200	29310.050.060
4X40MM	200	29310.040.040	4,5X50MM	200	29310.045.050	5X70MM	200	29310.050.070
4X45MM	200	29310.040.045	4,5X60MM	200	29310.045.060	5X80MM	200	29310.050.080
4X50MM	200	29310.040.050	4,5X70MM	200	29310.045.070	5X90MM	200	29310.050.090
4X60MM	200	29310.040.060	5X20MM	1000	29310.050.020	5X100MM	200	29310.050.100

• Warning: electro-galvanizing of these products may cause hydrogen embrittlement.

29360 HECO TOPIX Hexalobular socket countersunk head screw for chipboard		K04A
Material	Steel	 
Surface treatment	Zinc plated	
		

d x L	☒	Art.number	d x L	☒	Art.number	d x L	☒	Art.number
3,5X30MM	1000	29360.035.030	4,5X40MM	500	29360.045.040	5X100MM	200	29360.050.100
3,5X35MM	1000	29360.035.035	4,5X45MM	500	29360.045.045	6X50MM	200	29360.060.050
3,5X40MM	500	29360.035.040	4,5X50MM	200	29360.045.050	6X60MM	200	29360.060.060
3,5X50MM	500	29360.035.050	4,5X60MM	200	29360.045.060	6X70MM	200	29360.060.070
4X30MM	1000	29360.040.030	4,5X70MM	200	29360.045.070	6X80MM	100	29360.060.080
4X35MM	500	29360.040.035	4,5X80MM	200	29360.045.080	6X90MM	100	29360.060.090
4X40MM	500	29360.040.040	5X40MM	500	29360.050.040	6X100MM	100	29360.060.100
4X45MM	500	29360.040.045	5X50MM	200	29360.050.050	6X120MM	100	29360.060.120
4X50MM	500	29360.040.050	5X60MM	200	29360.050.060	6X140MM	100	29360.060.140
4X60MM	200	29360.040.060	5X70MM	200	29360.050.070	6X160MM	100	29360.060.160
4X70MM	200	29360.040.070	5X80MM	200	29360.050.080	6X180MM	100	29360.060.180
			5X90MM	200	29360.050.090	6X200MM	100	29360.060.200

• Warning: electro-galvanizing of these products may cause hydrogen embrittlement.

29375 HECO UNIX TOP Hexalobular socket countersunk head screw for chipboard		K04A
Material	Steel	 
Surface treatment	Zinc plated	
		

d x L	☒	Art.number	d x L	☒	Art.number	d x L	☒	Art.number
3,5X30MM	1000	29375.035.030	4,5X40MM	500	29375.045.040	5X90MM	200	29375.050.090
3,5X35MM	1000	29375.035.035	4,5X45MM	500	29375.045.045	5X100MM	100	29375.050.100
3,5X40MM	500	29375.035.040	4,5X50MM	200	29375.045.050	5X120MM	100	29375.050.120
3,5X45MM	500	29375.035.045	4,5X60MM	200	29375.045.060	6X50MM	200	29375.060.050
3,5X50MM	500	29375.035.050	4,5X70MM	200	29375.045.070	6X60MM	200	29375.060.060
4X35MM	500	29375.040.035	4,5X80MM	200	29375.045.080	6X70MM	200	29375.060.070
4X40MM	500	29375.040.040	5X40MM	500	29375.050.040	6X80MM	100	29375.060.080
4X45MM	500	29375.040.045	5X45MM	200	29375.050.045	6X90MM	100	29375.060.090
4X50MM	500	29375.040.050	5X50MM	200	29375.050.050	6X100MM	100	29375.060.100
4X60MM	200	29375.040.060	5X60MM	200	29375.050.060	6X120MM	100	29375.060.120
4X70MM	200	29375.040.070	5X70MM	200	29375.050.070	6X140MM	100	29375.060.140
			5X80MM	200	29375.050.080	6X160MM	100	29375.060.160



• Warning: electro-galvanizing of these products may cause hydrogen embrittlement.

51775 Hexalobular socket countersunk head screw for chipboard		R03A
Material	Stainless steel A2	

d x L	☒	Art.number	d x L	☒	Art.number	d x L	☒	Art.number
3X10MM*	500	51775.030.010	4X40MM	200	51775.040.040	5X60MM	200	51775.050.060
3X12MM*	500	51775.030.012	4X45MM	200	51775.040.045	5X65MM*	100	51775.050.065
3X16MM	200	51775.030.016	4X50MM	200	51775.040.050	5X70MM	200	51775.050.070
3X20MM	200	51775.030.020	4X60MM	200	51775.040.060	5X80MM	100	51775.050.080
3X25MM	200	51775.030.025	4X70MM	200	51775.040.070	5X90MM	100	51775.050.090
3X30MM	200	51775.030.030				5X100MM*	100	51775.050.100
3X35MM	200	51775.030.035	4,5X20MM	200	51775.045.020	5X120MM	100	51775.050.120
3X40MM	200	51775.030.040	4,5X25MM	200	51775.045.025			
3X50MM*	200	51775.030.050	4,5X30MM	200	51775.045.030	6X20MM*	100	51775.060.020
			4,5X35MM	200	51775.045.035	6X25MM*	100	51775.060.025
3,5X12MM*	500	51775.035.012	4,5X40MM	200	51775.045.040	6X30MM*	100	51775.060.030
3,5X16MM	200	51775.035.016	4,5X45MM	200	51775.045.045	6X35MM*	100	51775.060.035
3,5X20MM	200	51775.035.020	4,5X50MM	200	51775.045.050	6X40MM	100	51775.060.040
3,5X25MM	200	51775.035.025	4,5X60MM	200	51775.045.060	6X50MM*	100	51775.060.050
3,5X30MM	200	51775.035.030	4,5X70MM*	200	51775.045.070	6X60MM	100	51775.060.060
3,5X35MM	200	51775.035.035				6X70MM*	100	51775.060.070
3,5X40MM	200	51775.035.040	5X20MM	200	51775.050.020	6X80MM	100	51775.060.080
			5X25MM	200	51775.050.025	6X90MM*	100	51775.060.090
4X12MM*	500	51775.040.012	5X30MM	200	51775.050.030	6X100MM*	100	51775.060.100
4X16MM	200	51775.040.016	5X35MM	200	51775.050.035	6X120MM	100	51775.060.120
4X20MM	200	51775.040.020	5X40MM	200	51775.050.040			
4X25MM	200	51775.040.025	5X45MM	200	51775.050.045	8X60MM*	100	51775.080.060
4X30MM	200	51775.040.030	5X50MM	200	51775.050.050	8X90MM	100	51775.080.090
4X35MM	200	51775.040.035	5X55MM*	200	51775.050.055			

55775 Hexalobular socket countersunk head screw for chipboard R43A

Material Stainless steel A4

6

d x L	☒	Art.number	d x L	☒	Art.number	d x L	☒	Art.number
3X16MM*	200	55775.030.016	4X30MM*	200	55775.040.030	5X20MM*	200	55775.050.020
3X20MM*	200	55775.030.020	4X35MM*	200	55775.040.035	5X25MM*	200	55775.050.025
3X25MM*	200	55775.030.025	4X40MM*	200	55775.040.040	5X30MM*	200	55775.050.030
3X30MM*	200	55775.030.030	4X45MM*	200	55775.040.045	5X35MM*	200	55775.050.035
3X40MM*	200	55775.030.040	4X50MM*	200	55775.040.050	5X40MM*	200	55775.050.040
			4X60MM*	200	55775.040.060	5X45MM*	200	55775.050.045
3,5X16MM*	200	55775.035.016				5X50MM*	200	55775.050.050
3,5X20MM*	200	55775.035.020	4,5X20MM*	200	55775.045.020	5X55MM*	200	55775.050.055
3,5X25MM*	200	55775.035.025	4,5X25MM*	200	55775.045.025	5X60MM*	100	55775.050.060
3,5X30MM*	200	55775.035.030	4,5X30MM*	200	55775.045.030	5X70MM*	100	55775.050.070
3,5X35MM*	200	55775.035.035	4,5X35MM*	200	55775.045.035	5X80MM*	100	55775.050.080
3,5X40MM*	200	55775.035.040	4,5X40MM*	200	55775.045.040	5X90MM*	100	55775.050.090
3,5X45MM*	200	55775.035.045	4,5X45MM*	200	55775.045.045	5X100MM*	100	55775.050.100
			4,5X50MM*	200	55775.045.050	5X120MM*	100	55775.050.120
4X16MM*	200	55775.040.016	4,5X55MM*	200	55775.045.055			
4X20MM*	200	55775.040.020	4,5X60MM*	200	55775.045.060			
4X25MM*	200	55775.040.025	4,5X70MM*	200	55775.045.070			

Hexalobular socket countersunk head screw for chipboard

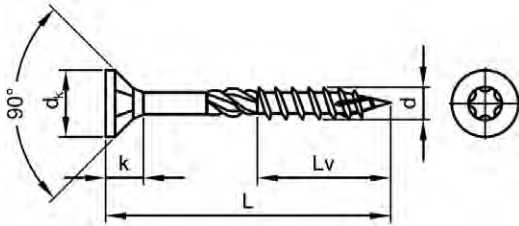

Technical Data

d	d _k (max.)	k (max.)	Socket
3.5	7.0	2.1	T15
4	8.0	2.5	T15
4.5	9.0	2.7	T25
5	9.7	3.0	T25
6	11.8	3.6	T25

51773 HECO TOPIX Hexalobular socket countersunk head screw for chipboard K04A

Material: Stainless steel A2

6

d x L	☒	Art.number	d x L	☒	Art.number	d x L	☒	Art.number
3,5X30MM	200	51773.035.030	4,5X40MM	200	51773.045.040	5X70MM	200	51773.050.070
3,5X35MM	200	51773.035.035	4,5X45MM	200	51773.045.045	5X80MM	200	51773.050.080
3,5X40MM	200	51773.035.040	4,5X50MM	200	51773.045.050	5X90MM	200	51773.050.090
3,5X45MM	200	51773.035.045	4,5X60MM	200	51773.045.060	5X100MM	200	51773.050.100
3,5X50MM	200	51773.035.050	4,5X70MM	200	51773.045.070	6X50MM	200	51773.060.050
4X30MM	200	51773.040.030	4,5X80MM	200	51773.045.080	6X60MM	200	51773.060.060
4X35MM	200	51773.040.035	5X40MM	200	51773.050.040	6X70MM	200	51773.060.070
4X40MM	200	51773.040.040	5X45MM	200	51773.050.045	6X80MM	100	51773.060.080
4X45MM	200	51773.040.045	5X50MM	200	51773.050.050	6X90MM	200	51773.060.090
4X50MM	200	51773.040.050	5X60MM	200	51773.050.060	6X100MM	100	51773.060.100
4X60MM	200	51773.040.060				6X120MM	100	51773.060.120

Countersunk chipboard screw ribs cut point

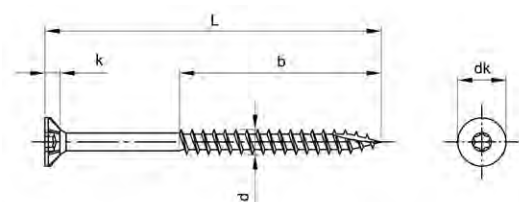

Technical Data

d	d _k	k	Socket
3	6	1.9	T10
3.5	7	2.1	T10
4	8	2.5	T20
4.5	9	2.7	T20
5	10	3	T25
6	12	3.6	T25

55755 Countersunk chipboard screw ribs cut point

R43A

Material Stainless steel A4



6

d x L x b	☒	Art.number	d x L x b	☒	Art.number	d x L x b	☒	Art.number
3X12x12MM*	500	55755.030.012	4X45x30MM*	200	55755.040.045	5X45x30MM*	200	55755.050.045
3X16x16MM*	500	55755.030.016	4X50x30MM*	200	55755.040.050	5X50x30MM*	200	55755.050.050
3X20x20MM*	500	55755.030.020	4X60x36MM*	200	55755.040.060	5X55x36MM*	200	55755.050.055
3X25x18MM*	500	55755.030.025	4X70x42MM*	200	55755.040.070	5X60x36MM*	100	55755.050.060
3X30x18MM*	500	55755.030.030				5X70x42MM*	100	55755.050.070
3X40x24MM*	200	55755.030.040	4,5X20x20MM*	500	55755.045.020	5X80x48MM*	100	55755.050.080
			4,5X25x18MM*	500	55755.045.025	5X90x54MM*	100	55755.050.090
3,5X16x16MM*	500	55755.035.016	4,5X30x18MM*	500	55755.045.030	5X100x60MM*	100	55755.050.100
3,5X20x20MM*	500	55755.035.020	4,5X35x24MM*	500	55755.045.035	5X120x70MM*	100	55755.050.120
3,5X25x18MM*	500	55755.035.025	4,5X40x24MM*	200	55755.045.040			
3,5X30x18MM*	500	55755.035.030	4,5X45x30MM*	200	55755.045.045	6X30x20MM*	100	55755.060.030
3,5X35x24MM*	500	55755.035.035	4,5X50x30MM*	200	55755.045.050	6X40x24MM*	100	55755.060.040
3,5X40x24MM*	200	55755.035.040	4,5X55x36MM*	200	55755.045.055	6X45x30MM*	100	55755.060.045
3,5X45x30MM*	200	55755.035.045	4,5X60x36MM*	200	55755.045.060	6X50x30MM*	100	55755.060.050
3,5X50x30MM*	200	55755.035.050	4,5X70x42MM*	200	55755.045.070	6X60x36MM*	100	55755.060.060
			4,5X80x48MM*	200	55755.045.080	6X70x42MM*	100	55755.060.070
4X16x16MM*	500	55755.040.016				6X80x48MM*	100	55755.060.080
4X20x20MM*	500	55755.040.020	5X20x20MM*	500	55755.050.020	6X90x54MM*	100	55755.060.090
4X25x18MM*	500	55755.040.025	5X25x18MM*	500	55755.050.025	6X100x70MM*	100	55755.060.100
4X30x18MM*	500	55755.040.030	5X30x20MM*	500	55755.050.030	6X110x70MM*	100	55755.060.110
4X35x24MM*	500	55755.040.035	5X35x24MM*	500	55755.050.035	6X120x70MM*	100	55755.060.120
4X40x24MM*	200	55755.040.040	5X40x24MM*	200	55755.050.040			

Decking woodscrew reduced countersunk head with ttap®

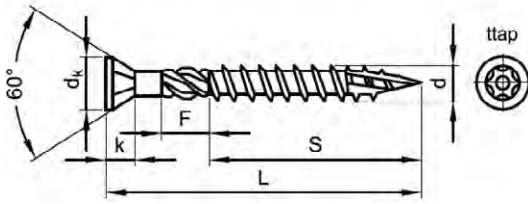

Technical Data

d	dk	k	No. ttap
5	9	5.1	20

- Full boxes only.
- F=9mm only if L≥40mm.

30250 MAXXFAST Decking woodscrew reduced countersunk head with ttap® MF0A

Material: Stainless steel A2

MAXXFAST
PROFESSIONAL HARDWARE

RoHS

6

d x L (S)	☒	Art.number	d x L (S)	☒	Art.number	d x L (S)	☒	Art.number
5X40MM (25)	200	30250.050.040	5X50MM (35)	200	30250.050.050	5X70MM (55)	100	30250.050.070
5X45MM (30)	200	30250.050.045	5X60MM (45)	100	30250.050.060	5X80MM (65)	100	30250.050.080

Hexalobular decking woodscrew reduced countersunk head

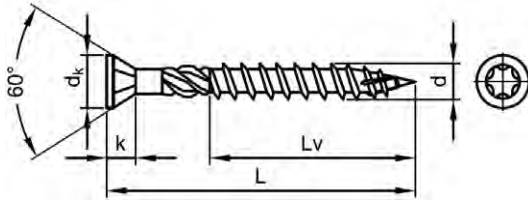

Technical Data

d	dk (max.)	k (max.)	Socket
5	8.5	2.7	T25

51774 HECO TOPIX Hexalobular decking woodscrew reduced countersunk head K04A

Material: Stainless steel A2

HECO
SCHRAUBEN

RoHS

d x L	☒	Art.number	d x L	☒	Art.number	d x L	☒	Art.number
5X40MM	200	51774.050.040	5X60MM	200	51774.050.060	5X80MM	200	51774.050.080
5X50MM	200	51774.050.050	5X70MM	200	51774.050.070			

Terrace screw cylindrical head

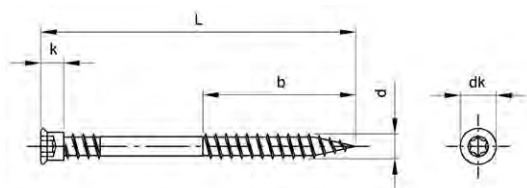

Technical Data

d	d_k	k	Socket
5.5	8	5.1	No.25

55561 Terrace screw cylindrical head

R03A

Material Stainless steel A4



d x L x b	☒	Art.number	d x L x b	☒	Art.number	d x L x b	☒	Art.number
5,5X40X18MM*	100	55561.055.040	5,5X70X34MM*	100	55561.055.070	5,5X90X36MM*	100	55561.055.090
5,5X50X18MM*	100	55561.055.050	5,5X80X36MM*	100	55561.055.080	5,5X100X36MM*	100	55561.055.100
5,5X60X24MM*	100	55561.055.060						

6

Universal woodscrew cross recessed raised cheese head

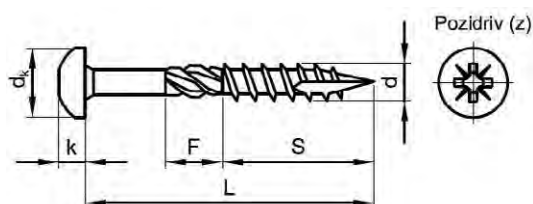

Technical Data

d	d _k	k	No. cross recess	d	d _k	k	No. cross recess
3	6	2.4	1	4.5	9	3.2	2
3.5	7	2.6	2	5	10	3.6	2
4	8	3.0	2	6	12	4.9	3

- Full boxes only.
- F=9mm only if L≥40mm.
- Diameters 3 and 3,5 are unfit for structural timber joints and therefore not CE marked

Article groups

Driving features	Material	Surface treatment	Code	Page
Pozidriv	St	Zipl	30025	6-165
Pozidriv	St	Zipl yell.p.	30030	6-166
Pozidriv	St.St. A2		30040	6-166

30025 MAXXFAST Universal woodscrew cross recessed (Z) raised cheese head

MF0A

Material Steel
Surface treatment Zinc plated

MAXXFAST
PROFESSIONAL HARDWARE



CE

d x L (S)	☒	Art.number	d x L (S)	☒	Art.number	d x L (S)	☒	Art.number
3X12MM (9)	200	30025.030.012	3,5X16MM (13)	200	30025.035.016	4X12MM (9)	200	30025.040.012
3X16MM (13)	200	30025.030.016	3,5X20MM (17)	200	30025.035.020	4X16MM (13)	200	30025.040.016
3X20MM (17)	200	30025.030.020	3,5X25MM (22)	200	30025.035.025	4X20MM (17)	200	30025.040.020
3X25MM (22)	200	30025.030.025	3,5X30MM (27)	200	30025.035.030	4X25MM (22)	200	30025.040.025
3X30MM (27)	200	30025.030.030	3,5X35MM (32)	200	30025.035.035	4X30MM (27)	200	30025.040.030
			3,5X40MM (25)	200	30025.035.040	4X35MM (32)	200	30025.040.035
3,5X12MM (9)	200	30025.035.012				4X40MM (25)	200	30025.040.040

30025 MAXXFAST Universal woodscrew cross recessed (Z) raised cheese head

d x L (S)	☒	Art.number	d x L (S)	☒	Art.number	d x L (S)	☒	Art.number
4X45MM (30)	200	30025.040.045	4,5X50MM (35)	200	30025.045.050	5X70MM (54)	200	30025.050.070
4X50MM (35)	200	30025.040.050				5X80MM (54)	100	30025.050.080
4X60MM (45)	200	30025.040.060	5X16MM (12)	200	30025.050.016			
			5X20MM (16)	200	30025.050.020	6X30MM (25)	200	30025.060.030
4,5X16MM (12)	200	30025.045.016	5X25MM (21)	200	30025.050.025	6X40MM (25)	200	30025.060.040
4,5X20MM (16)	200	30025.045.020	5X30MM (26)	200	30025.050.030	6X50MM (35)	200	30025.060.050
4,5X25MM (21)	200	30025.045.025	5X35MM (31)	200	30025.050.035	6X60MM (45)	200	30025.060.060
4,5X30MM (26)	200	30025.045.030	5X40MM (25)	200	30025.050.040	6X80MM (54)	100	30025.060.080
4,5X35MM (31)	200	30025.045.035	5X45MM (30)	200	30025.050.045	6X100MM (66)	100	30025.060.100
4,5X40MM (25)	200	30025.045.040	5X50MM (35)	200	30025.050.050			
4,5X45MM (30)	200	30025.045.045	5X60MM (45)	200	30025.050.060			

30030 MAXXFAST Universal woodscrew cross recessed (Z) raised cheese head MF0A

Material Steel
Surface treatment Zinc plated yellow passivated

MAXXFAST
PROFESSIONAL HARDWARE



CE

d x L (S)	☒	Art.number	d x L (S)	☒	Art.number	d x L (S)	☒	Art.number
3X12MM (9)	200	30030.030.012	4X30MM (27)	200	30030.040.030	5X25MM (21)	200	30030.050.025
3X16MM (13)	200	30030.030.016	4X35MM (32)	200	30030.040.035	5X30MM (26)	200	30030.050.030
3X20MM (17)	200	30030.030.020	4X40MM (25)	200	30030.040.040	5X35MM (31)	200	30030.050.035
3X25MM (22)	200	30030.030.025	4X45MM (30)	200	30030.040.045	5X40MM (25)	200	30030.050.040
3X30MM (27)	200	30030.030.030	4X50MM (35)	200	30030.040.050	5X45MM (30)	200	30030.050.045
			4X60MM (45)	200	30030.040.060	5X50MM (35)	200	30030.050.050
3,5X12MM (9)	200	30030.035.012				5X60MM (45)	200	30030.050.060
3,5X16MM (13)	200	30030.035.016	4,5X16MM (12)	200	30030.045.016	5X70MM (54)	200	30030.050.070
3,5X20MM (17)	200	30030.035.020	4,5X20MM (16)	200	30030.045.020	5X80MM (54)	100	30030.050.080
3,5X25MM (22)	200	30030.035.025	4,5X25MM (21)	200	30030.045.025			
3,5X30MM (27)	200	30030.035.030	4,5X30MM (26)	200	30030.045.030	6X30MM (25)	200	30030.060.030
3,5X35MM (32)	200	30030.035.035	4,5X35MM (31)	200	30030.045.035	6X40MM (25)	200	30030.060.040
3,5X40MM (25)	200	30030.035.040	4,5X40MM (25)	200	30030.045.040	6X50MM (35)	200	30030.060.050
			4,5X45MM (30)	200	30030.045.045	6X60MM (45)	200	30030.060.060
4X12MM (9)	200	30030.040.012	4,5X50MM (35)	200	30030.045.050	6X80MM (54)	100	30030.060.080
4X16MM (13)	200	30030.040.016				6X100MM (66)	100	30030.060.100
4X20MM (17)	200	30030.040.020	5X16MM (12)	200	30030.050.016			
4X25MM (22)	200	30030.040.025	5X20MM (16)	200	30030.050.020			

30040 MAXXFAST Universal woodscrew cross recessed (Z) raised cheese head MF0A

Material Stainless steel A2

MAXXFAST
PROFESSIONAL HARDWARE

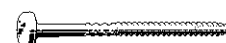

CE



d x L (S)	☒	Art.number	d x L (S)	☒	Art.number	d x L (S)	☒	Art.number
3X16MM (13)	200	30040.030.016	4X16MM (13)	200	30040.040.016	5X20MM (16)	200	30040.050.020
3X20MM (17)	200	30040.030.020	4X20MM (17)	200	30040.040.020	5X25MM (21)	200	30040.050.025
3X25MM (22)	200	30040.030.025	4X25MM (22)	200	30040.040.025	5X30MM (26)	200	30040.050.030
3X30MM (27)	200	30040.030.030	4X30MM (27)	200	30040.040.030	5X40MM (25)	200	30040.050.040
			4X35MM (32)	200	30040.040.035	5X50MM (35)	200	30040.050.050
3,5X16MM (13)	200	30040.035.016	4X40MM (25)	200	30040.040.040	5X60MM (45)	200	30040.050.060
3,5X20MM (17)	200	30040.035.020	4X45MM (30)	200	30040.040.045			
3,5X25MM (22)	200	30040.035.025	4X50MM (35)	200	30040.040.050			
3,5X30MM (27)	200	30040.035.030						

Universal woodscrew raised cheese head with ttap®

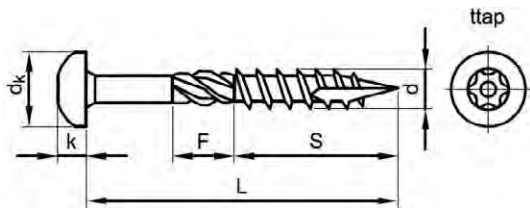

Technical Data

d	dk	k	No. ttap	d	dk	k	No. ttap
3	6	2.4	10	4.5	9	3.2	20
3.5	7	2.6	15	5	10	3.6	25
4	8	2.9	20	6	12	4.2	25

- Full boxes only.
- F=9mm only if L≥40mm.
- Diameters 3 and 3,5 are unfit for structural timber joints and therefore not CE marked

Article groups

Driving features	Material	Surface treatment	Code	Page
ttap®	St	Zipl	30125	6-167
ttap®	St	Zipl yell.p.	30130	6-167
ttap®	St.St. A2		30140	6-168

30125 MAXXFAST Universal woodscrew raised cheese head with ttap®

MF0A

Material Steel
Surface treatment Zinc plated

MAXXFAST
PROFESSIONAL HARDWARE



CE

d x L (S)	Art.number	d x L (S)	Art.number	d x L (S)	Art.number
3X12MM (9)	200 30125.030.012	4X30MM (27)	200 30125.040.030	5X20MM (16)	200 30125.050.020
3X16MM (13)	200 30125.030.016	4X35MM (32)	200 30125.040.035	5X25MM (21)	200 30125.050.025
3X20MM (17)	200 30125.030.020	4X40MM (25)	200 30125.040.040	5X30MM (26)	200 30125.050.030
3X25MM (22)	200 30125.030.025	4X45MM (30)	200 30125.040.045	5X35MM (31)	200 30125.050.035
3X30MM (27)	200 30125.030.030	4X50MM (35)	200 30125.040.050	5X40MM (25)	200 30125.050.040
		4X60MM (45)	200 30125.040.060	5X45MM (30)	200 30125.050.045
3,5X12MM (9)	200 30125.035.012	4,5X16MM (12)	200 30125.045.016	5X50MM (35)	200 30125.050.050
3,5X16MM (13)	200 30125.035.016	4,5X20MM (16)	200 30125.045.020	5X60MM (45)	200 30125.050.060
3,5X20MM (17)	200 30125.035.020	4,5X25MM (21)	200 30125.045.025	5X70MM (54)	200 30125.050.070
3,5X25MM (22)	200 30125.035.025	4,5X30MM (26)	200 30125.045.030	5X80MM (54)	100 30125.050.080
3,5X30MM (27)	200 30125.035.030	4,5X35MM (31)	200 30125.045.035	6X30MM (25)	200 30125.060.030
3,5X35MM (32)	200 30125.035.035	4,5X40MM (25)	200 30125.045.040	6X40MM (25)	200 30125.060.040
3,5X40MM (25)	200 30125.035.040	4,5X45MM (30)	200 30125.045.045	6X50MM (35)	200 30125.060.050
4X12MM (9)	200 30125.040.012	4,5X50MM (35)	200 30125.045.050	6X60MM (45)	200 30125.060.060
4X16MM (13)	200 30125.040.016	5X16MM (12)	200 30125.050.016	6X80MM (54)	100 30125.060.080
4X20MM (17)	200 30125.040.020			6X100MM (66)	100 30125.060.100
4X25MM (22)	200 30125.040.025				

30130 MAXXFAST Universal woodscrew raised cheese head with ttap®

MF0A

Material Steel
Surface treatment Zinc plated yellow passivated



MAXXFAST
PROFESSIONAL HARDWARE



CE

d x L (S)	Art.number	d x L (S)	Art.number	d x L (S)	Art.number
3X12MM (9)	200 30130.030.012	3,5X40MM (25)	200 30130.035.040	4,5X16MM (12)	200 30130.045.016
3X16MM (13)	200 30130.030.016	4X12MM (9)	200 30130.040.012	4,5X20MM (16)	200 30130.045.020
3X20MM (17)	200 30130.030.020	4X16MM (13)	200 30130.040.016	4,5X25MM (21)	200 30130.045.025
3X25MM (22)	200 30130.030.025	4X20MM (17)	200 30130.040.020	4,5X30MM (26)	200 30130.045.030
3X30MM (27)	200 30130.030.030	4X25MM (22)	200 30130.040.025	4,5X35MM (31)	200 30130.045.035
3,5X12MM (9)	200 30130.035.012	4X30MM (27)	200 30130.040.030	4,5X40MM (25)	200 30130.045.040
3,5X16MM (13)	200 30130.035.016	4X35MM (32)	200 30130.040.035	4,5X45MM (30)	200 30130.045.045
3,5X20MM (17)	200 30130.035.020	4X40MM (25)	200 30130.040.040	4,5X50MM (35)	200 30130.045.050
3,5X25MM (22)	200 30130.035.025	4X45MM (30)	200 30130.040.045	5X16MM (12)	200 30130.050.016
3,5X30MM (27)	200 30130.035.030	4X50MM (35)	200 30130.040.050	5X20MM (16)	200 30130.050.020
3,5X35MM (32)	200 30130.035.035	4X60MM (45)	200 30130.040.060		

30130 MAXXFAST Universal woodscrew raised cheese head with ttap®								
d x L (S)	☒	Art.number	d x L (S)	☒	Art.number	d x L (S)	☒	Art.number
5X25MM (21)	200	30130.050.025	5X60MM (45)	200	30130.050.060	6X50MM (35)	200	30130.060.050
5X30MM (26)	200	30130.050.030	5X70MM (54)	200	30130.050.070	6X60MM (45)	200	30130.060.060
5X35MM (31)	200	30130.050.035	5X80MM (54)	100	30130.050.080	6X80MM (54)	100	30130.060.080
5X40MM (25)	200	30130.050.040				6X100MM (66)	100	30130.060.100
5X45MM (30)	200	30130.050.045	6X30MM (25)	200	30130.060.030			
5X50MM (35)	200	30130.050.050	6X40MM (25)	200	30130.060.040			

30140 MAXXFAST Universal woodscrew raised cheese head with ttap®		MF0A
Material	Stainless steel A2	
CE		
		  

d x L (S)	☒	Art.number	d x L (S)	☒	Art.number	d x L (S)	☒	Art.number
3X16MM (13)	200	30140.030.016	4X16MM (13)	200	30140.040.016	5X20MM (16)	200	30140.050.020
3X20MM (17)	200	30140.030.020	4X20MM (17)	200	30140.040.020	5X25MM (21)	200	30140.050.025
3X25MM (22)	200	30140.030.025	4X25MM (22)	200	30140.040.025	5X30MM (26)	200	30140.050.030
3X30MM (27)	200	30140.030.030	4X30MM (27)	200	30140.040.030	5X40MM (25)	200	30140.050.040
3,5X16MM (13)	200	30140.035.016	4X35MM (32)	200	30140.040.035	5X50MM (35)	200	30140.050.050
3,5X20MM (17)	200	30140.035.020	4X40MM (25)	200	30140.040.040	5X60MM (45)	200	30140.050.060
3,5X25MM (22)	200	30140.035.025	4X45MM (30)	200	30140.040.045			
3,5X30MM (27)	200	30140.035.030	4X50MM (35)	200	30140.040.050			

6

Cross recessed raised cheese head screw for chipboard





Technical Data

d	d _k (max.)	k (max.)	No. cross recess
2.5	5	2.12	1
3	5.9	2.2	1
3.5	6.9	2.6	2
4	7.9	2.8	2
4.5	8.9	3.05	2
5	9.6	3.4	2
5.5	10.5	4.2	3
6	11.6	4	3

• All dimensions are guide values and may deviate dependent on the manufacturer.

Article groups

Driving features	Material	Surface treatment	Code	Page	
Pozidriv	St	Zipl	29340	6-168	
Pozidriv	St	Zipl	HECO-FIX PLUS	29345	6-169
Pozidriv	St.St. A2		51770	6-169	

29340 Cross recessed raised cheese head screw for chipboard Pozidriv		K01A
Material	Steel	
Surface treatment	Zinc plated	
		 

d x L	☒	Art.number	d x L	☒	Art.number	d x L	☒	Art.number
3X12MM	200	29340.030.012	3,5X12MM	200	29340.035.012	3,5X35MM	200	29340.035.035
3X16MM	200	29340.030.016	3,5X16MM	200	29340.035.016	3,5X40MM	200	29340.035.040
3X20MM	200	29340.030.020	3,5X20MM	200	29340.035.020			
3X25MM	200	29340.030.025	3,5X25MM	200	29340.035.025	4X12MM	200	29340.040.012
3X30MM	200	29340.030.030	3,5X30MM	200	29340.035.030	4X16MM	200	29340.040.016

29340 Cross recessed raised cheese head screw for chipboard Pozidriv								
d x L	☒	Art.number	d x L	☒	Art.number	d x L	☒	Art.number
4X20MM	200	29340.040.020	4,5X25MM	200	29340.045.025	5X30MM	200	29340.050.030
4X25MM	200	29340.040.025	4,5X30MM	200	29340.045.030	5X35MM	200	29340.050.035
4X30MM	200	29340.040.030	4,5X35MM	200	29340.045.035	5X40MM	200	29340.050.040
4X35MM	200	29340.040.035	4,5X40MM	200	29340.045.040	5X45MM	200	29340.050.045
4X40MM	200	29340.040.040	4,5X45MM	200	29340.045.045	5X50MM	200	29340.050.050
4X45MM	200	29340.040.045	4,5X50MM	200	29340.045.050	5X60MM	200	29340.050.060
4X50MM	200	29340.040.050				5X70MM	200	29340.050.070
			5X16MM	200	29340.050.016	5X80MM	200	29340.050.080
4,5X16MM	200	29340.045.016	5X20MM	200	29340.050.020			
4,5X20MM	200	29340.045.020	5X25MM	200	29340.050.025			

- Warning: electro-galvanizing of these products may cause hydrogen embrittlement.

29345 HECO-FIX PLUS Cross recessed raised cheese head screw for chipboard Pozidriv		K04A
Material	Steel	
Surface treatment	Zinc plated	

d x L	☒	Art.number	d x L	☒	Art.number	d x L	☒	Art.number
2,5X12MM	1000	29345.025.012	4X16MM	200	29345.040.016	5X20MM	200	29345.050.020
2,5X16MM	200	29345.025.016	4X20MM	200	29345.040.020	5X25MM	200	29345.050.025
			4X25MM	200	29345.040.025	5X30MM	200	29345.050.030
3X12MM	200	29345.030.012	4X30MM	200	29345.040.030	5X35MM	200	29345.050.035
3X15MM	200	29345.030.015	4X35MM	200	29345.040.035	5X40MM	200	29345.050.040
3X16MM	200	29345.030.016	4X40MM	200	29345.040.040	5X45MM	200	29345.050.045
3X20MM	200	29345.030.020	4X45MM	200	29345.040.045	5X50MM	200	29345.050.050
3X25MM	200	29345.030.025	4X50MM	200	29345.040.050	5X60MM	200	29345.050.060
3X30MM	200	29345.030.030	4X60MM	200	29345.040.060	5X70MM	200	29345.050.070
						5X80MM	200	29345.050.080
3,5X15MM	200	29345.035.015	4,5X15MM	200	29345.045.015			
3,5X16MM	200	29345.035.016	4,5X16MM	200	29345.045.016	6X30MM	200	29345.060.030
3,5X20MM	200	29345.035.020	4,5X20MM	200	29345.045.020	6X35MM	200	29345.060.035
3,5X25MM	200	29345.035.025	4,5X25MM	200	29345.045.025	6X40MM	200	29345.060.040
3,5X30MM	200	29345.035.030	4,5X30MM	200	29345.045.030	6X50MM	200	29345.060.050
3,5X35MM	200	29345.035.035	4,5X40MM	200	29345.045.040	6X55MM	200	29345.060.055
3,5X40MM	200	29345.035.040	4,5X45MM	200	29345.045.045	6X60MM	200	29345.060.060
			4,5X50MM	200	29345.045.050	6X70MM	200	29345.060.070
4X12MM	200	29345.040.012	4,5X60MM	200	29345.045.060	6X80MM	200	29345.060.080
4X15MM	200	29345.040.015						

- Specific features HECO-FIX PLUS screws for chipboard:
- Reduction of required drive torque of up to 30%.
- Easier handling.
- Substantially higher screwing performance on using storage battery screw drivers.
- Axial forces are reduced, thereby less wear of screw driver bits.
- By means of the tooth geometry, a higher unscrewing moment is nevertheless, achieved and consequently, a secure screwed connection is obtained.
- Warning: electro-galvanizing of these products may cause hydrogen embrittlement.

51770 Cross recessed raised cheese head screw for chipboard Pozidriv		R03A
Material	Stainless steel A2	

d x L	☒	Art.number	d x L	☒	Art.number	d x L	☒	Art.number
3X16MM	200	51770.030.016	4X45MM	200	51770.040.045	5X35MM	200	51770.050.035
3X20MM	200	51770.030.020	4X50MM	200	51770.040.050	5X40MM	200	51770.050.040
3X25MM	200	51770.030.025	4X60MM	200	51770.040.060	5X45MM	200	51770.050.045
3X30MM	200	51770.030.030	4X70MM*	200	51770.040.070	5X50MM	200	51770.050.050
3X35MM*	500	51770.030.035				5X60MM	100	51770.050.060
			4,5X16MM*	500	51770.045.016	5X70MM	100	51770.050.070
3,5X16MM	200	51770.035.016	4,5X20MM*	500	51770.045.020	5X80MM	100	51770.050.080
3,5X20MM	200	51770.035.020	4,5X25MM*	500	51770.045.025	5X90MM	100	51770.050.090
3,5X25MM	200	51770.035.025	4,5X30MM	200	51770.045.030	5X100MM	100	51770.050.100
3,5X30MM	200	51770.035.030	4,5X35MM	200	51770.045.035			
3,5X35MM	200	51770.035.035	4,5X40MM	200	51770.045.040	5,5X50MM*	200	51770.055.050
3,5X40MM	200	51770.035.040	4,5X45MM*	200	51770.045.045			
			4,5X50MM	200	51770.045.050	6X20MM*	100	51770.060.020
4X16MM	200	51770.040.016	4,5X60MM*	200	51770.045.060	6X25MM*	100	51770.060.025
4X20MM	200	51770.040.020	4,5X70MM*	200	51770.045.070	6X30MM*	100	51770.060.030
4X25MM	200	51770.040.025				6X35MM*	100	51770.060.035
4X30MM	200	51770.040.030	5X20MM	200	51770.050.020	6X40MM*	100	51770.060.040
4X35MM	200	51770.040.035	5X25MM	200	51770.050.025	6X50MM*	100	51770.060.050
4X40MM	200	51770.040.040	5X30MM	200	51770.050.030	6X60MM*	100	51770.060.060

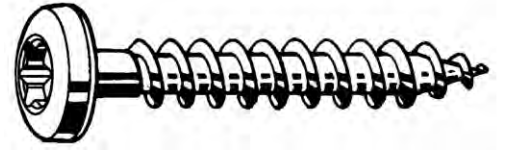
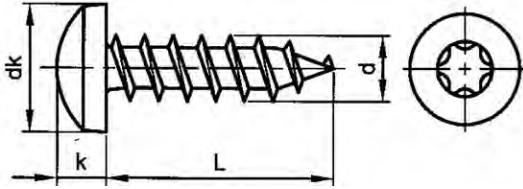

51770 Cross recessed raised cheese head screw for chipboard Pozidriv								
d x L	☒	Art.number	d x L	☒	Art.number	d x L	☒	Art.number
6X70MM*	100	51770.060.070	6X100MM*	100	51770.060.100	6X130MM*	100	51770.060.130
6X80MM*	100	51770.060.080	6X110MM*	100	51770.060.110			
6X90MM*	100	51770.060.090	6X120MM*	100	51770.060.120			

Hexalobular socket raised cheese head screw for chipboard



Technical Data							
d	d _k	k	Socket	d	d _k	k	Socket
3	5.7/6.0	2.1/2.3	T10	4.5	8.7/9.0	2.9/3.1	T25
3.5	6.7/7.0	2.2/2.4	T15	5	9.7/10.0	3.3/3.5	T25
4	7.7/8.0	2.6/2.8	T20				

6

29346 Hexalobular socket raised cheese head screw for chipboard		K01A
Material	Steel	
Surface treatment	Zinc plated	
		
		

d x L	☒	Art.number	d x L	☒	Art.number	d x L	☒	Art.number
3X10MM	1000	29346.030.010	4X12MM	1000	29346.040.012	4,5X30MM	500	29346.045.030
3X12MM	1000	29346.030.012	4X13MM	1000	29346.040.013	4,5X35MM	500	29346.045.035
3X13MM	1000	29346.030.013	4X15MM	1000	29346.040.015	4,5X40MM	500	29346.045.040
3X15MM	1000	29346.030.015	4X16MM	1000	29346.040.016	4,5X45MM	500	29346.045.045
3X16MM	1000	29346.030.016	4X16MM	1000	29346.040.016	4,5X50MM	200	29346.045.050
3X20MM	1000	29346.030.020	4X20MM	1000	29346.040.020	4,5X60MM	200	29346.045.060
3X25MM	1000	29346.030.025	4X25MM	1000	29346.040.025	4,5X70MM	200	29346.045.070
3X30MM	1000	29346.030.030	4X30MM	1000	29346.040.030			
3X35MM	500	29346.030.035	4X35MM	500	29346.040.035	5X16MM	1000	29346.050.016
3X40MM	500	29346.030.040	4X40MM	500	29346.040.040	5X20MM	1000	29346.050.020
			4X45MM	500	29346.040.045	5X25MM	500	29346.050.025
3,5X16MM	1000	29346.035.016	4X50MM	500	29346.040.050	5X30MM	500	29346.050.030
3,5X20MM	1000	29346.035.020	4X60MM	500	29346.040.060	5X35MM	500	29346.050.035
3,5X25MM	1000	29346.035.025	4X70MM	500	29346.040.070	5X40MM	500	29346.050.040
3,5X30MM	1000	29346.035.030				5X45MM	200	29346.050.045
3,5X35MM	1000	29346.035.035	4,5X15MM	1000	29346.045.015	5X50MM	200	29346.050.050
3,5X40MM	500	29346.035.040	4,5X16MM	1000	29346.045.016	5X60MM	200	29346.050.060
3,5X45MM	500	29346.035.045	4,5X20MM	1000	29346.045.020	5X70MM	200	29346.050.070
3,5X50MM	500	29346.035.050	4,5X25MM	500	29346.045.025	5X80MM	200	29346.050.080

Hexalobular pan head hinge strip screw

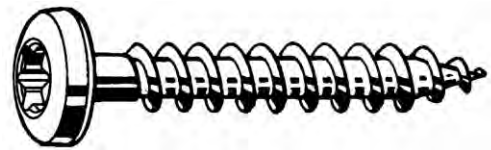
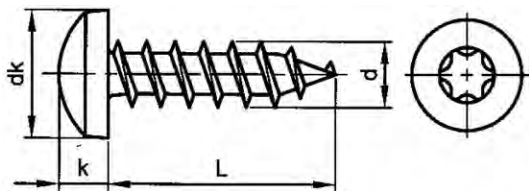

Technical Data

d	d _k	k	Socket
6	13	3	T30
7	14	3	T30

51789 Hexalobular pan head hinge strip screw

R03A

Material Stainless steel A2



d _s x L	☒	Art.number	d _s x L	☒	Art.number	d _s x L	☒	Art.number
6X20MM*	200	51789.060.020	6X45MM*	200	51789.060.045	7X40MM*	200	51789.070.040
6X25MM*	200	51789.060.025	6X50MM*	200	51789.060.050	7X50MM*	200	51789.070.050
6X30MM*	200	51789.060.030				7X60MM*	200	51789.070.060
6X35MM*	200	51789.060.035	7X30MM*	200	51789.070.030	7X70MM*	200	51789.070.070
6X40MM*	200	51789.060.040	7X35MM*	200	51789.070.035			

6

Cross recessed raised countersunk head screw for chipboard

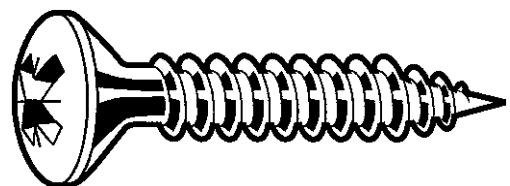
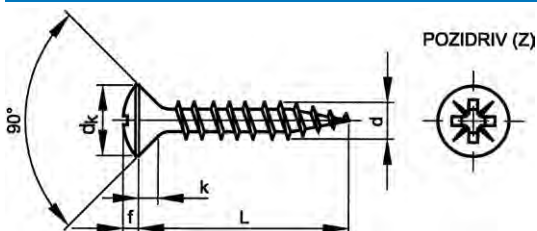

Technical Data

d	d _k (max.)	f ≈	k (max.)	No. cross recess
3	5.9	0.7	1.9	1
3.5	6.9	0.9	2.1	2
4	7.9	1.05	2.45	2
4.5	8.9	1.2	2.7	2
5	9.6	1.2	3.1	2
6	11.6	1.6	3.7	3

Article groups

Driving features	Material	Surface treatment	Code	Page
Pozidriv	St	Zipl	29367	6-171
Pozidriv	St.St. A2		51756	6-172

29367 HECO-FIX PLUS Cross recessed raised countersunk head screw for chipboard Pozidriv

K04A

Material Steel
Surface treatment Zinc plated



d x L	☒	Art.number	d x L	☒	Art.number	d x L	☒	Art.number
3X20MM	1000	29367.030.020	3,5X25MM	1000	29367.035.025	4X20MM	1000	29367.040.020
3,5X16MM	1000	29367.035.016	3,5X30MM	1000	29367.035.030	4X30MM	1000	29367.040.030
3,5X20MM	1000	29367.035.020	3,5X35MM	1000	29367.035.035	4X35MM	500	29367.040.035
			3,5X40MM	500	29367.035.040			

29367 HECO-FIX PLUS Cross recessed raised countersunk head screw for chipboard Pozidriv ←

d x L	☒	Art.number	d x L	☒	Art.number	d x L	☒	Art.number
4X40MM	500	29367.040.040	4X50MM	500	29367.040.050	4,5X40MM	500	29367.045.040
4X45MM	500	29367.040.045						

- Specific features HECO-FIX PLUS screws for chipboard:
- Reduction of required drive torque of up to 30%.
- Easier handling.
- Substantially higher screwing performance on using storage battery screw drivers.
- Axial forces are reduced, thereby less wear of screw driver bits.
- By means of the tooth geometry, a higher unscrewing moment is nevertheless achieved and consequently, a secure screwed connection is obtained.
- Warning: electro-galvanizing of these products may cause hydrogen embrittlement.

51756 Cross recessed raised countersunk head screw for chipboard Pozidriv R03A

Material Stainless steel A2

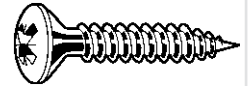

d x L	☒	Art.number	d x L	☒	Art.number	d x L	☒	Art.number
3X16MM	200	51756.030.016	4X45MM	200	51756.040.045	5X50MM	200	51756.050.050
3X20MM	200	51756.030.020	4X50MM	200	51756.040.050	5X60MM	200	51756.050.060
3X25MM	200	51756.030.025				5X70MM	200	51756.050.070
3X30MM	200	51756.030.030	4,5X20MM	200	51756.045.020	5X90MM	100	51756.050.090
			4,5X25MM	200	51756.045.025	5X100MM	100	51756.050.100
3,5X16MM	200	51756.035.016	4,5X30MM	200	51756.045.030			
3,5X20MM	200	51756.035.020	4,5X35MM	200	51756.045.035	6X20MM	200	51756.060.020
3,5X25MM	200	51756.035.025	4,5X40MM	200	51756.045.040	6X25MM	200	51756.060.025
3,5X30MM	200	51756.035.030	4,5X45MM	200	51756.045.045	6X30MM	100	51756.060.030
3,5X35MM	200	51756.035.035	4,5X50MM	200	51756.045.050	6X35MM	100	51756.060.035
3,5X40MM	200	51756.035.040	4,5X60MM	200	51756.045.060	6X40MM	100	51756.060.040
						6X45MM	100	51756.060.045
4X16MM	200	51756.040.016	5X20MM	200	51756.050.020	6X50MM	100	51756.060.050
4X20MM	200	51756.040.020	5X25MM	200	51756.050.025	6X60MM	100	51756.060.060
4X25MM	200	51756.040.025	5X30MM	200	51756.050.030	6X70MM	100	51756.060.070
4X30MM	200	51756.040.030	5X35MM	200	51756.050.035	6X80MM	100	51756.060.080
4X35MM	200	51756.040.035	5X40MM	200	51756.050.040	6X90MM	100	51756.060.090
4X40MM	200	51756.040.040	5X45MM	200	51756.050.045	6X100MM	100	51756.060.100

- All dimensions are guide values and may deviate dependent on the manufacturer.

Hexagon head wood screw

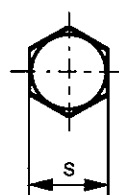
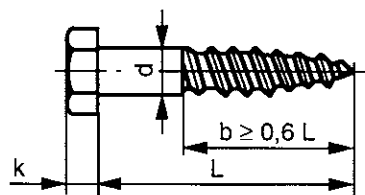

DIN 571
NEN 2260
NF E25-607

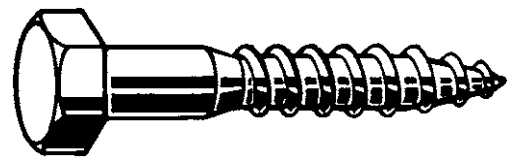

Technical Data

d	k	s	d	k	s
4	2.8	7	10	7	17
5	3.5	8	12	8	19
6	4	10	16	10	24
7	5	12	20	13	30
8	5.5	13			

- Wood screw thread acc. to DIN 7998.

Article groups

Driving features	Material	Surface treatment	Code	Page
Hexagon	St	Zipl	08280	6-173
Hexagon	St	Hot d.g.	08450	6-174
Hexagon	St.St. A2		51900	6-174
Hexagon	St.St. A4		55900	6-175
Hexagon	St.St. A2	bitumen washer	51890	6-176

6

08280 Hexagon head wood screw

E07A

Material Steel
Surface treatment Zinc plated



d x L	☒	Art.number	d x L	☒	Art.number	d x L	☒	Art.number
5X20MM	200	08280.050.020	7X90MM	100	08280.070.090	8X260MM	25	08280.080.260
5X25MM	200	08280.050.025	7X100MM	100	08280.070.100	8X280MM	25	08280.080.280
5X30MM	200	08280.050.030	7X110MM	100	08280.070.110	8X300MM	25	08280.080.300
5X35MM	200	08280.050.035	7X120MM	100	08280.070.120			
5X40MM	200	08280.050.040	7X130MM	100	08280.070.130	10X30MM	200	08280.100.030
5X45MM	200	08280.050.045	7X140MM	100	08280.070.140	10X35 MM	100	08280.100.035
5X50MM	200	08280.050.050	7X150MM	100	08280.070.150	10X40MM	100	08280.100.040
5X60MM	200	08280.050.060	7X160MM	50	08280.070.160	10X45MM	100	08280.100.045
			7X170MM	50	08280.070.170	10X50MM	100	08280.100.050
6X20MM	200	08280.060.020	7X200MM	50	08280.070.200	10X55MM	100	08280.100.055
6X25MM	200	08280.060.025	7X210MM	50	08280.070.210	10X60MM	100	08280.100.060
6X30MM	200	08280.060.030	7X230MM	50	08280.070.230	10X65 MM	100	08280.100.065
6X35MM	200	08280.060.035	7X250MM	50	08280.070.250	10X70MM	100	08280.100.070
6X40MM	200	08280.060.040	7X270MM	50	08280.070.270	10X80MM	100	08280.100.080
6X45MM	200	08280.060.045				10X90MM	100	08280.100.090
6X50MM	200	08280.060.050	8X25MM	200	08280.080.025	10X100MM	100	08280.100.100
6X55MM	200	08280.060.055	8X30MM	200	08280.080.030	10X110MM	50	08280.100.110
6X60MM	200	08280.060.060	8X35MM	200	08280.080.035	10X120MM	50	08280.100.120
6X65MM	200	08280.060.065	8X40MM	200	08280.080.040	10X130MM	50	08280.100.130
6X70MM	200	08280.060.070	8X45MM	200	08280.080.045	10X140MM	50	08280.100.140
6X80MM	200	08280.060.080	8X50MM	200	08280.080.050	10X150MM	50	08280.100.150
6X90MM	100	08280.060.090	8X55MM	200	08280.080.055	10X160MM	50	08280.100.160
6X100MM	100	08280.060.100	8X60MM	200	08280.080.060	10X180MM	50	08280.100.180
6X110MM	100	08280.060.110	8X65MM	200	08280.080.065	10X200MM	50	08280.100.200
6X120MM	100	08280.060.120	8X70MM	200	08280.080.070	10X220MM	25	08280.100.220
6X130MM	100	08280.060.130	8X80MM	200	08280.080.080	10X240MM	25	08280.100.240
6X140MM	100	08280.060.140	8X90MM	100	08280.080.090	10X260MM	25	08280.100.260
6X150MM	100	08280.060.150	8X100MM	100	08280.080.100	10X280MM	25	08280.100.280
6X160MM	100	08280.060.160	8X110MM	100	08280.080.110	10X300MM	25	08280.100.300
6X180MM	100	08280.060.180	8X120MM	100	08280.080.120			
6X200MM	100	08280.060.200	8X130MM	100	08280.080.130	12X40 MM	100	08280.120.040
			8X140MM	50	08280.080.140	12X45MM	100	08280.120.045
7X35MM	100	08280.070.035	8X150MM	50	08280.080.150	12X50MM	100	08280.120.050
7X40MM	100	08280.070.040	8X160MM	50	08280.080.160	12X55MM	100	08280.120.055
7X50MM	100	08280.070.050	8X180MM	50	08280.080.180	12X60MM	100	08280.120.060
7X60MM	100	08280.070.060	8X200MM	50	08280.080.200	12X70MM	50	08280.120.070
7X70MM	100	08280.070.070	8X220MM	50	08280.080.220	12X80MM	50	08280.120.080
7X80MM	100	08280.070.080	8X240MM	50	08280.080.240	12X90MM	50	08280.120.090

08280 Hexagon head wood screw								
d x L	☒	Art.number	d x L	☒	Art.number	d x L	☒	Art.number
12X100MM	50	08280.120.100	12X280MM	25	08280.120.280	16X160MM	25	08280.160.160
12X110MM	50	08280.120.110	12X300MM	25	08280.120.300	16X180MM	25	08280.160.180
12X120MM	50	08280.120.120				16X200MM	25	08280.160.200
12X130MM	50	08280.120.130	16X60MM	25	08280.160.060	16X220MM	25	08280.160.220
12X140MM	50	08280.120.140	16X70MM	25	08280.160.070			
12X150MM	50	08280.120.150	16X80MM	25	08280.160.080	20X120MM	25	08280.200.120
12X160MM	25	08280.120.160	16X90 MM	25	08280.160.090	20X140MM	25	08280.200.140
12X180MM	25	08280.120.180	16X100MM	25	08280.160.100	20X160MM	10	08280.200.160
12X200MM	25	08280.120.200	16X110MM	25	08280.160.110	20X180MM	10	08280.200.180
12X220MM	25	08280.120.220	16X120MM	25	08280.160.120	20X200MM	10	08280.200.200
12X240MM	25	08280.120.240	16X140MM	25	08280.160.140			
12X260MM	25	08280.120.260	16X150MM	25	08280.160.150			

08450 Hexagon head wood screw		A08A
Material	Steel	
Surface treatment	Hot dip galvanized	
		 

d x L	☒	Art.number	d x L	☒	Art.number	d x L	☒	Art.number
7X70MM	100	08450.070.070	10X50MM	100	08450.100.050	12X100MM	50	08450.120.100
7X8MM	100	08450.070.080	10X60MM	100	08450.100.060	12X120MM	50	08450.120.120
7X90MM	100	08450.070.090	10X70MM	100	08450.100.070	12X140MM	50	08450.120.140
7X120MM	100	08450.070.120	10X80MM	100	08450.100.080	12X150MM	50	08450.120.150
7X130MM	100	08450.070.130	10X90MM	100	08450.100.090	12X160MM	25	08450.120.160
7X150MM	100	08450.070.150	10X100MM	100	08450.100.100	12X180MM	25	08450.120.180
7X170MM	50	08450.070.170	10X110MM	50	08450.100.110	12X200MM	25	08450.120.200
7X190MM	50	08450.070.190	10X120MM	50	08450.100.120	12X220MM	25	08450.120.220
			10X130MM	50	08450.100.130	12X240MM	25	08450.120.240
8X40MM	200	08450.080.040	10X140MM	50	08450.100.140			
8X50MM	200	08450.080.050	10X150MM	50	08450.100.150	16X60MM	25	08450.160.060
8X60MM	200	08450.080.060	10X160MM	50	08450.100.160	16X80MM	25	08450.160.080
8X70MM	200	08450.080.070	10X180MM	50	08450.100.180	16X100MM	25	08450.160.100
8X80MM	200	08450.080.080	10X200MM	50	08450.100.200	16X120MM	25	08450.160.120
8X90MM	100	08450.080.090	10X220MM	25	08450.100.220	16X130MM	25	08450.160.130
8X100MM	100	08450.080.100	10X240MM	25	08450.100.240	16X140MM	25	08450.160.140
8X110MM	100	08450.080.110				16X160MM	25	08450.160.160
8X120MM	100	08450.080.120	12X60MM	100	08450.120.060	16X180MM	25	08450.160.180
8X130MM	100	08450.080.130	12X70MM	50	08450.120.070	16X200MM	25	08450.160.200
8X140MM	50	08450.080.140	12X80MM	50	08450.120.080	16X220MM	25	08450.160.220
8X150MM	50	08450.080.150	12X90MM	50	08450.120.090	16X240MM	25	08450.160.240

51900 Hexagon head wood screw		R03A
Material	Stainless steel A2	
		 

d x L	☒	Art.number	d x L	☒	Art.number	d x L	☒	Art.number
4X20MM*	200	51900.040.020	6X55MM*	200	51900.060.055	7X130MM	25	51900.070.130
4X25MM	200	51900.040.025	6X60MM	50	51900.060.060	7X140MM*	100	51900.070.140
4X30MM*	200	51900.040.030	6X65MM*	100	51900.060.065	7X150MM	25	51900.070.150
4X40MM*	200	51900.040.040	6X70MM	50	51900.060.070	7X160MM*	100	51900.070.160
4X45MM*	200	51900.040.045	6X80MM	50	51900.060.080	7X170MM	25	51900.070.170
			6X90MM	50	51900.060.090	7X180MM*	100	51900.070.180
5X20MM*	200	51900.050.020	6X100MM	50	51900.060.100	7X190MM*	100	51900.070.190
5X25MM*	200	51900.050.025	6X110MM	25	51900.060.110	7X210MM*	100	51900.070.210
5X30MM	100	51900.050.030	6X120MM	25	51900.060.120			
5X35MM*	200	51900.050.035	6X130MM*	100	51900.060.130	8X25MM*	100	51900.080.025
5X40MM	100	51900.050.040	6X140MM*	100	51900.060.140	8X30MM	50	51900.080.030
5X45MM*	200	51900.050.045				8X35MM*	100	51900.080.035
5X50MM	100	51900.050.050	7X30MM	50	51900.070.030	8X40MM	50	51900.080.040
5X60MM	100	51900.050.060	7X35MM*	200	51900.070.035	8X45MM	50	51900.080.045
5X70MM	100	51900.050.070	7X40MM	50	51900.070.040	8X50MM	50	51900.080.050
5X80MM*	200	51900.050.080	7X45MM*	200	51900.070.045	8X55MM	50	51900.080.055
5X90MM*	200	51900.050.090	7X50MM	50	51900.070.050	8X60MM	50	51900.080.060
			7X60MM	50	51900.070.060	8X65MM*	100	51900.080.065
6X25MM	100	51900.060.025	7X70MM	50	51900.070.070	8X70MM	25	51900.080.070
6X30MM	100	51900.060.030	7X80MM	50	51900.070.080	8X75MM*	100	51900.080.075
6X35MM	100	51900.060.035	7X90MM	50	51900.070.090	8X80MM	25	51900.080.080
6X40MM	100	51900.060.040	7X100MM	50	51900.070.100	8X90MM	25	51900.080.090
6X45MM	100	51900.060.045	7X110MM	50	51900.070.110	8X100MM	25	51900.080.100
6X50MM	100	51900.060.050	7X120MM	25	51900.070.120	8X110MM	25	51900.080.110

51900 Hexagon head wood screw								
d x L	☒	Art.number	d x L	☒	Art.number	d x L	☒	Art.number
8X120MM	10	51900.080.120	10X160MM	10	51900.100.160	12X220MM*	25	51900.120.220
8X130MM	10	51900.080.130	10X180MM	10	51900.100.180	12X240MM*	25	51900.120.240
8X140MM	10	51900.080.140	10X200MM	10	51900.100.200	12X250MM*	25	51900.120.250
8X150MM	10	51900.080.150	10X220MM*	50	51900.100.220	12X260MM*	25	51900.120.260
8X160MM	10	51900.080.160	10X240MM*	50	51900.100.240	12X280MM*	25	51900.120.280
8X180MM	10	51900.080.180	10X260MM*	25	51900.100.260	12X300MM*	25	51900.120.300
8X200MM	10	51900.080.200	10X280MM*	25	51900.100.280			
			10X300MM*	25	51900.100.300	16X50MM*	25	51900.160.050
10X40MM	25	51900.100.040				16X60MM*	25	51900.160.060
10X45MM*	100	51900.100.045	12X50MM	10	51900.120.050	16X70MM*	25	51900.160.070
10X50MM	25	51900.100.050	12X60MM	10	51900.120.060	16X80MM*	25	51900.160.080
10X55MM*	100	51900.100.055	12X70MM	10	51900.120.070	16X90MM*	25	51900.160.090
10X60MM	25	51900.100.060	12X80MM	10	51900.120.080	16X100MM*	25	51900.160.100
10X65MM*	100	51900.100.065	12X90MM	10	51900.120.090	16X110MM*	25	51900.160.110
10X70MM	25	51900.100.070	12X100MM	10	51900.120.100	16X120MM*	25	51900.160.120
10X80MM	10	51900.100.080	12X110MM	10	51900.120.110	16X130MM*	25	51900.160.130
10X90MM	10	51900.100.090	12X120MM	10	51900.120.120	16X140MM*	25	51900.160.140
10X100MM	10	51900.100.100	12X130MM	10	51900.120.130	16X150MM*	25	51900.160.150
10X110MM	10	51900.100.110	12X140MM	10	51900.120.140	16X160MM*	25	51900.160.160
10X120MM	10	51900.100.120	12X150MM	10	51900.120.150	16X180MM*	25	51900.160.180
10X130MM	10	51900.100.130	12X160MM	10	51900.120.160	16X200MM*	25	51900.160.200
10X140MM	10	51900.100.140	12X180MM	10	51900.120.180			
10X150MM	10	51900.100.150	12X200MM	10	51900.120.200			

55900 Hexagon head wood screw		R43A
Material	Stainless steel A4	
		 

d x L	☒	Art.number	d x L	☒	Art.number	d x L	☒	Art.number
5X25MM*	200	55900.050.025	8X50MM	50	55900.080.050	10X200MM*	50	55900.100.200
5X30MM*	200	55900.050.030	8X60MM	50	55900.080.060			
5X35MM*	200	55900.050.035	8X65MM*	100	55900.080.065	12X50MM*	100	55900.120.050
5X40MM*	200	55900.050.040	8X70MM	25	55900.080.070	12X60MM*	100	55900.120.060
5X45MM*	200	55900.050.045	8X75MM*	100	55900.080.075	12X65MM*	100	55900.120.065
5X50MM*	200	55900.050.050	8X80MM	25	55900.080.080	12X70MM*	50	55900.120.070
5X60MM*	200	55900.050.060	8X90MM	25	55900.080.090	12X75MM*	50	55900.120.075
5X70MM*	200	55900.050.070	8X100MM	25	55900.080.100	12X80 MM	50	55900.120.080
			8X110MM*	100	55900.080.110	12X90MM*	50	55900.120.090
6X25MM	100	55900.060.025	8X120MM*	100	55900.080.120	12X100MM*	50	55900.120.100
6X30MM	100	55900.060.030	8X130MM*	100	55900.080.130	12X110MM*	25	55900.120.110
6X35MM*	200	55900.060.035	8X140MM*	50	55900.080.140	12X120MM*	25	55900.120.120
6X40MM	100	55900.060.040	8X150MM*	50	55900.080.150	12X130MM*	25	55900.120.130
6X45MM	100	55900.060.045	8X160MM*	50	55900.080.160	12X140MM*	25	55900.120.140
6X50MM	100	55900.060.050	8X180MM*	50	55900.080.180	12X150MM*	25	55900.120.150
6X60MM	50	55900.060.060	8X200MM*	50	55900.080.200	12X160MM*	25	55900.120.160
6X65MM*	100	55900.060.065				12X180MM*	25	55900.120.180
6X70MM	50	55900.060.070	10X40MM	25	55900.100.040	12X200MM*	25	55900.120.200
6X75MM*	100	55900.060.075	10X50MM	25	55900.100.050			
6X80MM	50	55900.060.080	10X55MM*	100	55900.100.055	16X50MM*	25	55900.160.050
6X90MM*	100	55900.060.090	10X60MM	25	55900.100.060	16X60MM*	25	55900.160.060
6X100MM*	100	55900.060.100	10X65MM*	100	55900.100.065	16X70MM*	25	55900.160.070
6X110MM*	100	55900.060.110	10X70MM	25	55900.100.070	16X80MM*	25	55900.160.080
6X120MM*	100	55900.060.120	10X75MM*	100	55900.100.075	16X90MM*	25	55900.160.090
6X130MM*	100	55900.060.130	10X80MM	10	55900.100.080	16X100MM*	25	55900.160.100
			10X90MM*	50	55900.100.090	16X110MM*	25	55900.160.110
7X100MM*	100	55900.070.100	10X100MM	10	55900.100.100	16X120MM*	25	55900.160.120
7X110MM	100	55900.070.110	10X110MM*	50	55900.100.110	16X130MM*	25	55900.160.130
			10X120MM*	50	55900.100.120	16X140MM*	25	55900.160.140
8X25MM*	100	55900.080.025	10X130MM*	50	55900.100.130	16X150MM*	25	55900.160.150
8X30MM	50	55900.080.030	10X140MM*	50	55900.100.140	16X160MM*	25	55900.160.160
8X35MM*	100	55900.080.035	10X150MM*	50	55900.100.150	16X180MM*	25	55900.160.180
8X40MM	50	55900.080.040	10X160MM*	50	55900.100.160	16X200MM*	25	55900.160.200
8X45MM*	100	55900.080.045	10X180MM*	50	55900.100.180			

51890	Hexagon head wood screw with stainless steel-lead-bitumen washers	R03A
Material	Stainless steel A2	DIN ≈571

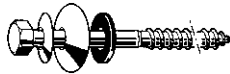

d x L	☒	Art.number	d x L	☒	Art.number	d x L	☒	Art.number
7X110MM	100	51890.070.110	7X130MM	100	51890.070.130	7X150MM	100	51890.070.150

Universal construction woodscrew countersunk head with ttap®

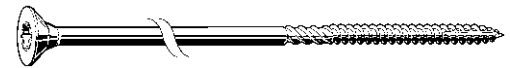
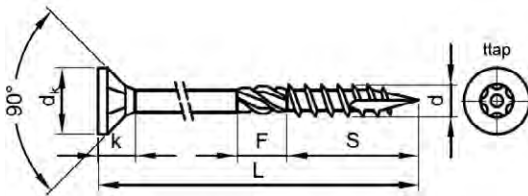

Technical Data

d	dk	k	No. ttap
6	12	3.8	30
8	15	4.8	40
10	18.4	5.8	40

- Full boxes only.
- F=9mm only if L≥40mm.

6

30205	MAXXFAST Universal construction woodscrew countersunk head with ttap®	MF0A
Material	Steel	MAXXFAST PROFESSIONAL HARDWARE
Surface treatment	Zinc plated yellow passivated	



CE

d x L (S)	☒	Art.number	d x L (S)	☒	Art.number	d x L (S)	☒	Art.number
6X160MM (98)	50	30205.060.160	8X200MM (124)	50	30205.080.200	10X140MM (85)	50	30205.100.140
6X180MM (111)	50	30205.060.180	8X220MM (138)	50	30205.080.220	10X160MM (98)	50	30205.100.160
6X200MM (124)	50	30205.060.200	8X240MM (152)	50	30205.080.240	10X180MM (111)	50	30205.100.180
6X220MM (138)	50	30205.060.220	8X260MM (166)	50	30205.080.260	10X200MM (124)	50	30205.100.200
6X240MM (152)	50	30205.060.240	8X280MM (178)	50	30205.080.280	10X220MM (138)	50	30205.100.220
6X260MM (166)	50	30205.060.260	8X300MM (192)	50	30205.080.300	10X240MM (152)	50	30205.100.240
6X280MM (178)	50	30205.060.280	8X320MM (205)	50	30205.080.320	10X260MM (166)	50	30205.100.260
6X300MM (192)	50	30205.060.300	8X340MM (218)	50	30205.080.340	10X280MM (178)	50	30205.100.280
			8X360MM (232)	50	30205.080.360	10X300MM (192)	50	30205.100.300
8X80MM (45)	50	30205.080.080	8X380MM (246)	50	30205.080.380	10X320MM (205)	50	30205.100.320
8X100MM (58)	50	30205.080.100	8X400MM (258)	50	30205.080.400	10X340MM (218)	50	30205.100.340
8X120MM (72)	50	30205.080.120				10X360MM (232)	50	30205.100.360
8X140MM (85)	50	30205.080.140	10X80MM (45)	50	30205.100.080	10X380MM (246)	50	30205.100.380
8X160MM (98)	50	30205.080.160	10X100MM (58)	50	30205.100.100	10X400MM (258)	50	30205.100.400
8X180MM (111)	50	30205.080.180	10X120MM (72)	50	30205.100.120			

Heavy construction woodscrew flange head ttap®

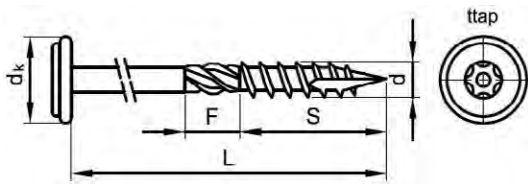

Technical Data

d	dk	k	No. ttap
6	15	3.3	30
8	18	4.2	40
10	21	4.7	40

- Full boxes only.
- F=9mm only if L≥40mm.

Article groups

Driving features	Material	Surface treatment	Code	Page
ttap®	St	Zipl yell.p.	30225	6-177
ttap®	St.St. A2		30230	6-177

30225 MAXXFAST Universal construction woodscrew flange head with ttap®

MF0A

Material Steel
Surface treatment Zinc plated yellow passivated

MAXXFAST
PROFESSIONAL HARDWARE



CE

d x L (S)	☒	Art.number	d x L (S)	☒	Art.number	d x L (S)	☒	Art.number
6X80MM (45)	100	30225.060.080	8X140MM (85)	50	30225.080.140	10X100MM (58)	50	30225.100.100
6X100MM (58)	100	30225.060.100	8X160MM (98)	50	30225.080.160	10X120MM (72)	50	30225.100.120
6X120MM (72)	100	30225.060.120	8X180MM (111)	50	30225.080.180	10X140MM (85)	50	30225.100.140
6X140MM (85)	100	30225.060.140	8X200MM (124)	50	30225.080.200	10X160MM (98)	50	30225.100.160
6X160MM (98)	50	30225.060.160	8X220MM (138)	50	30225.080.220	10X180MM (111)	50	30225.100.180
6X180MM (111)	50	30225.060.180	8X240MM (152)	50	30225.080.240	10X200MM (124)	50	30225.100.200
6X200MM (124)	50	30225.060.200	8X260MM (166)	50	30225.080.260	10X220MM (138)	50	30225.100.220
6X220MM (138)	50	30225.060.220	8X280MM (178)	50	30225.080.280	10X240MM (152)	50	30225.100.240
6X240MM (152)	50	30225.060.240	8X300MM (192)	50	30225.080.300	10X260MM (166)	50	30225.100.260
6X260MM (166)	50	30225.060.260	8X320MM (205)	50	30225.080.320	10X280MM (178)	50	30225.100.280
6X280MM (178)	50	30225.060.280	8X340MM (218)	50	30225.080.340	10X300MM (192)	50	30225.100.300
6X300MM (192)	50	30225.060.300	8X360MM (232)	50	30225.080.360	10X320MM (205)	50	30225.100.320
			8X380MM (246)	50	30225.080.380	10X340MM (218)	50	30225.100.340
			8X400MM (258)	50	30225.080.400	10X360MM (232)	50	30225.100.360
						10X380MM (246)	50	30225.100.380
						10X400MM (258)	50	30225.100.400

30230 MAXXFAST construction woodscrew flange head with ttap®

MF0A

Material Stainless steel A2

MAXXFAST
PROFESSIONAL HARDWARE



CE

d x L (S)	☒	Art.number	d x L (S)	☒	Art.number	d x L (S)	☒	Art.number
8X80MM (45)	50	30230.080.080	8X120MM (72)	50	30230.080.120	8X160MM (98)	50	30230.080.160
8X100MM (58)	50	30230.080.100	8X140MM (85)	50	30230.080.140	8X180MM (111)	50	30230.080.180

Hexalobular countersunk timber screw

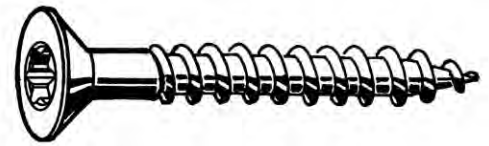
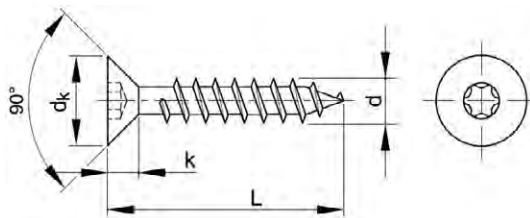

Technical Data

d	d _k	k	Socket
3	6	1.9	T10
3.5	7	2.1	T10
4	8	2.5	T20
4.5	9	2.7	T20
5	10	3	T25
6	12	3.6	T25
8	15	4.1	T40



Article groups

Driving features	Material	Code	Page
Hexalobular	St.St. A2	51878	6-178
Hexalobular	St.St. A4	55878	6-179

6

51878	Hexalobular countersunk timber screw	R03A
Material	Stainless steel A2	
		
		

d x L	☒	Art.number	d x L	☒	Art.number	d x L	☒	Art.number
3,0X25MM*	500	51878.030.025	4,5X55MM*	200	51878.045.055	6,0X110MM*	100	51878.060.110
3,0X30MM*	500	51878.030.030	4,5X60MM*	200	51878.045.060	6,0X130MM*	100	51878.060.130
3,0X35MM*	500	51878.030.035	4,5X70MM*	200	51878.045.070	6,0X140MM*	100	51878.060.140
3,0X40MM*	200	51878.030.040	4,5X80MM*	200	51878.045.080	6,0X150MM*	100	51878.060.150
3,0X45MM*	200	51878.030.045	4,5X100MM*	200	51878.045.100	6,0X160MM*	100	51878.060.160
3,0X50MM*	200	51878.030.050				6,0X180MM*	100	51878.060.180
			5,0X20MM*	500	51878.050.020	6,0X200MM*	100	51878.060.200
3,5X25MM*	500	51878.035.025	5,0X25MM*	500	51878.050.025	6,0X220MM*	100	51878.060.220
3,5X30MM*	500	51878.035.030	5,0X35MM*	500	51878.050.035	6,0X240MM*	100	51878.060.240
3,5X35MM*	500	51878.035.035	5,0X40MM*	200	51878.050.040	6,0X260MM*	100	51878.060.260
3,5X40MM*	200	51878.035.040	5,0X45MM*	200	51878.050.045	6,0X280MM*	100	51878.060.280
3,5X45MM*	200	51878.035.045	5,0X50MM*	200	51878.050.050	6,0X300MM*	100	51878.060.300
3,5X50MM*	200	51878.035.050	5,0X55MM*	200	51878.050.055			
			5,0X60MM*	100	51878.050.060	8,0X70MM*	100	51878.080.070
4,0X25MM*	500	51878.040.025	5,0X65MM*	100	51878.050.065	8,0X80MM*	100	51878.080.080
4,0X30MM*	500	51878.040.030	5,0X80MM*	100	51878.050.080	8,0X100MM*	100	51878.080.100
4,0X35MM*	500	51878.040.035	5,0X90MM*	100	51878.050.090	8,0X120MM*	100	51878.080.120
4,0X40MM*	200	51878.040.040	5,0X100MM*	100	51878.050.100	8,0X140MM*	100	51878.080.140
4,0X45MM*	200	51878.040.045	5,0X110MM*	100	51878.050.110	8,0X160MM*	100	51878.080.160
4,0X50MM*	200	51878.040.050				8,0X180MM*	100	51878.080.180
4,0X55MM*	200	51878.040.055	6,0X30MM*	100	51878.060.030	8,0X200MM*	100	51878.080.200
4,0X60MM*	200	51878.040.060	6,0X35MM*	100	51878.060.035	8,0X220MM*	100	51878.080.220
4,0X65MM*	200	51878.040.065	6,0X40MM*	100	51878.060.040	8,0X225MM*	100	51878.080.225
4,0X80MM*	200	51878.040.080	6,0X45MM*	100	51878.060.045	8,0X240MM*	100	51878.080.240
			6,0X50MM*	100	51878.060.050	8,0X260MM*	100	51878.080.260
4,5X25MM*	500	51878.045.025	6,0X55MM*	100	51878.060.055	8,0X280MM*	100	51878.080.280
4,5X30MM*	500	51878.045.030	6,0X60MM*	100	51878.060.060	8,0X300MM*	100	51878.080.300
4,5X35MM*	500	51878.045.035	6,0X70MM*	100	51878.060.070	8,0X325MM*	100	51878.080.325
4,5X40MM*	200	51878.045.040	6,0X80MM*	100	51878.060.080	8,0X350MM*	100	51878.080.350
4,5X45MM*	200	51878.045.045	6,0X90MM*	100	51878.060.090	8,0X360MM*	100	51878.080.360
4,5X50MM*	200	51878.045.050	6,0X100MM*	100	51878.060.100	8,0X375MM*	100	51878.080.375

55878	Hexalobular countersunk timber screw		R43A
Material	Stainless steel A4		
			 

d x L	☒	Art.number	d x L	☒	Art.number	d x L	☒	Art.number
6,0X40MM*	100	55878.060.040	6,0X120MM*	100	55878.060.120	8,0X70MM*	100	55878.080.070
6,0X45MM*	100	55878.060.045	6,0X130MM*	100	55878.060.130	8,0X80MM*	100	55878.080.080
6,0X50MM*	100	55878.060.050	6,0X140MM*	100	55878.060.140	8,0X90MM*	100	55878.080.090
6,0X60MM*	100	55878.060.060	6,0X150MM*	100	55878.060.150	8,0X100MM*	100	55878.080.100
6,0X70MM*	100	55878.060.070	6,0X160MM*	100	55878.060.160	8,0X120MM*	100	55878.080.120
6,0X80MM*	100	55878.060.080	6,0X180MM*	100	55878.060.180	8,0X140MM*	100	55878.080.140
6,0X90MM*	100	55878.060.090	6,0X200MM*	100	55878.060.200	8,0X160MM*	100	55878.080.160
6,0X100MM*	100	55878.060.100				8,0X180MM*	100	55878.080.180
6,0X110MM*	100	55878.060.110	8,0X60MM*	100	55878.080.060	8,0X200MM*	100	55878.080.200

Slotted countersunk (flat) head wood screw

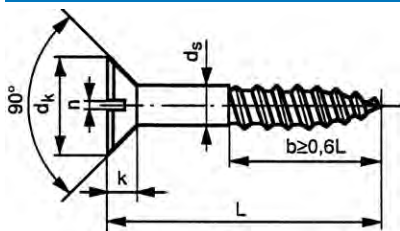

DIN 97
NEN 2250
NF E25-604

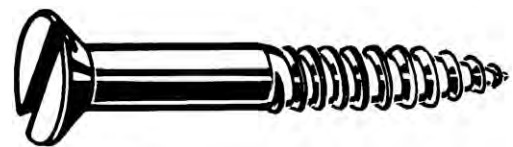

Technical Data							
d _s	d _k	k (max.)	n	d _s	d _k	k (max.)	n
2	3.8	1.2	0.5	5	9.2	2.5	1.2
2.5	4.7	1.5	0.6	5.5	10.2	2.75	1.2
3	5.6	1.65	0.8	6	11	3	1.6
3.5	6.5	1.93	0.8	7	12.5	3.5	2
4	7.5	2.2	1	8	14.5	4	2
4.5	8.3	2.35	1	10	18	5	2.5

* Wood screw thread acc. to DIN 7998.

Article groups

Driving features	Material	Surface treatment	Code	Page
Slotted	St	Zipl	25130	6-179
Slotted	St.St. A2		51870	6-180
Slotted	St.St. A4		55870	6-180
Slotted	Br Cu2/Cu3		49230	6-181
Slotted	Br Cu2/Cu3	Ni.pl.	49330	6-181

25130	Slotted countersunk (flat) head wood screw		K05A
Material	Steel		
Surface treatment	Zinc plated		
			 

d _s x L	☒	Art.number	d _s x L	☒	Art.number	d _s x L	☒	Art.number
2X10MM	200	25130.020.010	3X30MM	200	25130.030.030	4X10MM	200	25130.040.010
2X12MM	200	25130.020.012	3X35MM	200	25130.030.035	4X16MM	200	25130.040.016
2X16MM	200	25130.020.016	3X40MM	200	25130.030.040	4X20MM	200	25130.040.020
2X20MM	200	25130.020.020	3X45MM	200	25130.030.045	4X25MM	200	25130.040.025
			3X50MM	200	25130.030.050	4X30MM	200	25130.040.030
2,5X10MM	200	25130.025.010				4X35MM	200	25130.040.035
2,5X12MM	200	25130.025.012	3,5X10MM	200	25130.035.010	4X40MM	200	25130.040.040
2,5X16MM	200	25130.025.016	3,5X12MM	200	25130.035.012	4X45MM	200	25130.040.045
2,5X20MM	200	25130.025.020	3,5X16MM	200	25130.035.016	4X50MM	200	25130.040.050
2,5X30MM	200	25130.025.030	3,5X20MM	200	25130.035.020	4X60MM	200	25130.040.060
			3,5X25MM	200	25130.035.025	4X70MM	200	25130.040.070
3X10MM	200	25130.030.010	3,5X30MM	200	25130.035.030	4X80MM	200	25130.040.080
3X12MM	200	25130.030.012	3,5X35MM	200	25130.035.035	4X100MM	200	25130.040.100
3X16MM	200	25130.030.016	3,5X40MM	200	25130.035.040			
3X20MM	200	25130.030.020	3,5X45MM	200	25130.035.045			
3X25MM	200	25130.030.025	3,5X50MM	200	25130.035.050	4,5X20MM	200	25130.045.020

25130 Slotted countersunk (flat) head wood screw								
d _s x L	☒	Art.number	d _s x L	☒	Art.number	d _s x L	☒	Art.number
4,5X25MM	200	25130.045.025	5X50MM	200	25130.050.050	6X40MM	200	25130.060.040
4,5X30MM	200	25130.045.030	5X60MM	200	25130.050.060	6X45MM	200	25130.060.045
4,5X35MM	200	25130.045.035	5X70MM	200	25130.050.070	6X50MM	200	25130.060.050
4,5X40MM	200	25130.045.040	5X80MM	200	25130.050.080	6X60MM	100	25130.060.060
4,5X45MM	200	25130.045.045				6X70MM	100	25130.060.070
4,5X50MM	200	25130.045.050	5,5X25MM	200	25130.055.025	6X80MM	100	25130.060.080
4,5X60MM	200	25130.045.060	5,5X30MM	200	25130.055.030	6X90MM	100	25130.060.090
4,5X70MM	200	25130.045.070	5,5X40MM	200	25130.055.040	6X100MM	100	25130.060.100
			5,5X45MM	200	25130.055.045	6X120MM	100	25130.060.120
			5,5X50MM	200	25130.055.050			
5X20MM	200	25130.050.020				7X50MM	100	25130.070.050
5X25MM	200	25130.050.025				7X60MM	100	25130.070.060
5X30MM	200	25130.050.030	6X20MM	200	25130.060.020	7X70MM	100	25130.070.070
5X35MM	200	25130.050.035	6X25MM	200	25130.060.025	7X80MM	100	25130.070.080
5X40MM	200	25130.050.040	6X30MM	200	25130.060.030	7X100MM	100	25130.070.100
5X45MM	200	25130.050.045	6X35MM	200	25130.060.035			

51870 Slotted countersunk (flat) head wood screw		R03A
Material	Stainless steel A2	
		
		

d _s x L	☒	Art.number	d _s x L	☒	Art.number	d _s x L	☒	Art.number
2,5X10MM	200	51870.025.010	4X60MM	200	51870.040.060	5,5X50MM	200	51870.055.050
2,5X12MM	200	51870.025.012	4X70MM	200	51870.040.070	5,5X60MM	100	51870.055.060
2,5X16MM	200	51870.025.016				5,5X70MM	100	51870.055.070
2,5X20MM	200	51870.025.020	4,5X16MM*	200	51870.045.016	5,5X75MM*	100	51870.055.075
2,5X25MM	200	51870.025.025	4,5X20MM	200	51870.045.020	5,5X90MM	100	51870.055.090
			4,5X25MM	200	51870.045.025	5,5X100MM	100	51870.055.100
3X10MM	200	51870.030.010	4,5X30MM	200	51870.045.030			
3X12MM	200	51870.030.012	4,5X35MM	200	51870.045.035	6X25MM	200	51870.060.025
3X16MM	200	51870.030.016	4,5X40MM	200	51870.045.040	6X30MM	200	51870.060.030
3X20MM	200	51870.030.020	4,5X45MM	200	51870.045.045	6X35MM	200	51870.060.035
3X25MM	200	51870.030.025	4,5X50MM	200	51870.045.050	6X40MM	200	51870.060.040
3X30MM	200	51870.030.030	4,5X60MM*	200	51870.045.060	6X45MM	200	51870.060.045
3X35MM*	200	51870.030.035	4,5X70MM*	200	51870.045.070	6X50MM	200	51870.060.050
3X40MM*	200	51870.030.040				6X60MM	100	51870.060.060
			5X16MM*	200	51870.050.016	6X65MM*	100	51870.060.065
3,5X12MM	200	51870.035.012	5X20MM	200	51870.050.020	6X70MM	100	51870.060.070
3,5X16MM	200	51870.035.016	5X25MM	200	51870.050.025	6X80MM	100	51870.060.080
3,5X20MM	200	51870.035.020	5X30MM	200	51870.050.030	6X90MM*	100	51870.060.090
3,5X25MM	200	51870.035.025	5X35MM	200	51870.050.035	6X100MM	100	51870.060.100
3,5X30MM	200	51870.035.030	5X40MM	200	51870.050.040	6X110MM*	100	51870.060.110
3,5X35MM	200	51870.035.035	5X45MM	200	51870.050.045	6X120MM*	100	51870.060.120
3,5X40MM	200	51870.035.040	5X50MM	200	51870.050.050			
3,5X45MM*	200	51870.035.045	5X60MM	200	51870.050.060	8X30MM*	100	51870.080.030
3,5X50MM	200	51870.035.050	5X65MM*	100	51870.050.065	8X40MM*	100	51870.080.040
			5X70MM	200	51870.050.070	8X50MM*	100	51870.080.050
4X10MM*	200	51870.040.010	5X75MM*	100	51870.050.075	8X60MM*	100	51870.080.060
4X12MM*	200	51870.040.012	5X80MM	200	51870.050.080	8X70MM*	100	51870.080.070
4X16MM	200	51870.040.016	5X90MM	200	51870.050.090	8X80MM*	100	51870.080.080
4X20MM	200	51870.040.020	5X100MM*	100	51870.050.100	8X90MM*	100	51870.080.090
4X25MM	200	51870.040.025				8X100MM*	100	51870.080.100
4X30MM	200	51870.040.030	5,5X25MM	200	51870.055.025	8X120MM*	100	51870.080.120
4X35MM	200	51870.040.035	5,5X30MM	200	51870.055.030			
4X40MM	200	51870.040.040	5,5X35MM	200	51870.055.035			
4X45MM	200	51870.040.045	5,5X40MM	200	51870.055.040			
4X50MM	200	51870.040.050	5,5X45MM	200	51870.055.045			

55870 Slotted countersunk (flat) head wood screw		R43A
Material	Stainless steel A4	
		
		

d _s x L	☒	Art.number	d _s x L	☒	Art.number	d _s x L	☒	Art.number
2,5X12MM*	500	55870.025.012	3X20MM	200	55870.030.020	3,5X20MM	200	55870.035.020
2,5X16MM*	500	55870.025.016	3X25MM*	200	55870.030.025	3,5X25MM	200	55870.035.025
2,5X20MM*	500	55870.025.020	3X30MM*	200	55870.030.030	3,5X30MM*	200	55870.035.030
2,5X25MM*	500	55870.025.025	3X35MM*	200	55870.030.035	3,5X35MM*	200	55870.035.035
			3X40MM*	200	55870.030.040	3,5X40MM*	200	55870.035.040
3X10MM*	200	55870.030.010				3,5X45MM*	200	55870.035.045
3X12MM*	200	55870.030.012	3,5X12MM*	200	55870.035.012	3,5X50MM*	200	55870.035.050
3X16MM	200	55870.030.016	3,5X16MM*	200	55870.035.016			

55870 Slotted countersunk (flat) head wood screw								
d _s x L	☒	Art.number	d _s x L	☒	Art.number	d _s x L	☒	Art.number
4X16MM*	200	55870.040.016				6X40MM*	200	55870.060.040
4X20MM*	200	55870.040.020	5X16MM*	200	55870.050.016	6X45MM*	200	55870.060.045
4X25MM	200	55870.040.025	5X20MM*	200	55870.050.020	6X50MM	200	55870.060.050
4X30MM	200	55870.040.030	5X25MM*	200	55870.050.025	6X60MM	100	55870.060.060
4X35MM*	200	55870.040.035	5X30MM	200	55870.050.030	6X70MM	100	55870.060.070
4X40MM	200	55870.040.040	5X35MM*	200	55870.050.035	6X80MM	100	55870.060.080
4X45MM*	200	55870.040.045	5X40MM	200	55870.050.040	6X90MM	100	55870.060.090
4X50MM	200	55870.040.050	5X45MM*	200	55870.050.045	6X100MM	100	55870.060.100
4X60MM*	200	55870.040.060	5X50MM	200	55870.050.050	6X110MM*	100	55870.060.110
			5X60MM	200	55870.050.060			
4,5X25MM*	200	55870.045.025	5X70MM	200	55870.050.070	8X40MM*	100	55870.080.040
4,5X30MM*	200	55870.045.030	5X80MM	200	55870.050.080	8X50MM*	100	55870.080.050
4,5X35MM*	200	55870.045.035	5X90MM	200	55870.050.090	8X60MM*	100	55870.080.060
4,5X40MM*	200	55870.045.040				8X70MM*	100	55870.080.070
4,5X45MM*	200	55870.045.045	5,5X40MM	200	55870.055.040	8X80MM*	100	55870.080.080
4,5X50MM*	200	55870.045.050				8X100MM*	100	55870.080.100
4,5X60MM*	200	55870.045.060	6X30MM*	200	55870.060.030			
4,5X80MM*	200	55870.045.080	6X35MM*	200	55870.060.035			

49230 Slotted countersunk (flat) head wood screw		M07A
Material	Brass Cu2/Cu3	
		
		

d _s x L	☒	Art.number	d _s x L	☒	Art.number	d _s x L	☒	Art.number
2X8MM	200	49230.020.008	3,5X40MM	200	49230.035.040	5X40MM	200	49230.050.040
2X10MM	200	49230.020.010	3,5X45MM	200	49230.035.045	5X45MM	200	49230.050.045
2X12MM	200	49230.020.012	3,5X50MM	200	49230.035.050	5X50MM	200	49230.050.050
2X16MM	200	49230.020.016				5X60MM	200	49230.050.060
2X20MM	200	49230.020.020	4X12MM	200	49230.040.012	5X70MM	200	49230.050.070
			4X16MM	200	49230.040.016	5X80MM	200	49230.050.080
2,5X10MM	200	49230.025.010	4X20MM	200	49230.040.020			
2,5X12MM	200	49230.025.012	4X25MM	200	49230.040.025	5,5X30MM	200	49230.055.030
2,5X16MM	200	49230.025.016	4X30MM	200	49230.040.030	5,5X40MM	200	49230.055.040
2,5X20MM	200	49230.025.020	4X35MM	200	49230.040.035	5,5X45MM	200	49230.055.045
2,5X25MM	200	49230.025.025	4X40MM	200	49230.040.040	5,5X50MM	200	49230.055.050
2,5X30MM	200	49230.025.030	4X45MM	200	49230.040.045	5,5X60MM	100	49230.055.060
			4X50MM	200	49230.040.050	5,5X70MM	100	49230.055.070
3X10MM	200	49230.030.010	4X60MM	200	49230.040.060	5,5X80MM	100	49230.055.080
3X12MM	200	49230.030.012	4X70MM	200	49230.040.070	5,5X90MM	100	49230.055.090
3X16MM	200	49230.030.016				5,5X100MM	100	49230.055.100
3X20MM	200	49230.030.020	4,5X20MM	200	49230.045.020			
3X25MM	200	49230.030.025	4,5X25MM	200	49230.045.025	6X30MM	200	49230.060.030
3X30MM	200	49230.030.030	4,5X30MM	200	49230.045.030	6X35MM	200	49230.060.035
3X35MM	200	49230.030.035	4,5X35MM	200	49230.045.035	6X40MM	200	49230.060.040
3X40MM	200	49230.030.040	4,5X40MM	200	49230.045.040	6X45MM	200	49230.060.045
			4,5X45MM	200	49230.045.045	6X50MM	200	49230.060.050
3,5X10MM	200	49230.035.010	4,5X50MM	200	49230.045.050	6X60MM	100	49230.060.060
3,5X12MM	200	49230.035.012	4,5X60MM	200	49230.045.060	6X70MM	100	49230.060.070
3,5X16MM	200	49230.035.016				6X80MM	100	49230.060.080
3,5X20MM	200	49230.035.020	5X20MM	200	49230.050.020	6X90MM	100	49230.060.090
3,5X25MM	200	49230.035.025	5X25MM	200	49230.050.025	6X100MM	100	49230.060.100
3,5X30MM	200	49230.035.030	5X30MM	200	49230.050.030			
3,5X35MM	200	49230.035.035	5X35MM	200	49230.050.035	7X70MM	100	49230.070.070

49330 Slotted countersunk (flat) head wood screw		M07A
Material	Brass Cu2/Cu3	
Surface treatment	Nickel plated	
		
		

d _s x L	☒	Art.number	d _s x L	☒	Art.number	d _s x L	☒	Art.number
2X10MM	200	49330.020.010	3X25MM	200	49330.030.025	4X25MM	200	49330.040.025
2X12MM	200	49330.020.012				4X30MM	200	49330.040.030
			3,5X10MM	200	49330.035.010	4X35MM	200	49330.040.035
2,5X12MM	200	49330.025.012	3,5X16MM	200	49330.035.016	4X40MM	200	49330.040.040
2,5X16MM	200	49330.025.016	3,5X20MM	200	49330.035.020	4X45MM	200	49330.040.045
2,5X20MM	200	49330.025.020	3,5X25MM	200	49330.035.025	4X50MM	200	49330.040.050
			3,5X40MM	200	49330.035.040			
3X10MM	200	49330.030.010				4,5X20MM	200	49330.045.020
3X12MM	200	49330.030.012	4X12MM	200	49330.040.012	4,5X25MM	200	49330.045.025
3X16MM	200	49330.030.016	4X16MM	200	49330.040.016	4,5X30MM	200	49330.045.030
3X20MM	200	49330.030.020	4X20MM	200	49330.040.020	4,5X35MM	200	49330.045.035

49330 Slotted countersunk (flat) head wood screw								
$d_s \times L$	☒	Art.number	$d_s \times L$	☒	Art.number	$d_s \times L$	☒	Art.number
4,5X40MM	200	49330.045.040				6X30MM	200	49330.060.030
4,5X60MM	200	49330.045.060	5,5X25MM	200	49330.055.025	6X40MM	200	49330.060.040
4,5X70MM	200	49330.045.070	5,5X30MM	200	49330.055.030	6X50MM	200	49330.060.050
			5,5X40MM	200	49330.055.040	6X60MM	100	49330.060.060
5X30MM	200	49330.050.030	5,5X50MM	200	49330.055.050	6X70MM	100	49330.060.070
5X40MM	200	49330.050.040	5,5X60MM	100	49330.055.060	6X80MM	100	49330.060.080
5X45MM	200	49330.050.045	5,5X70MM	100	49330.055.070			
5X60MM	200	49330.050.060						

Slotted round head wood screw

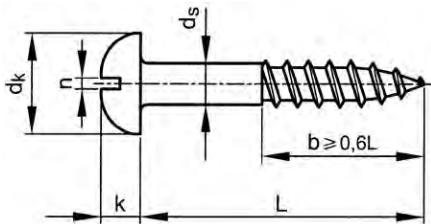

DIN 96
NEN 2251
NF E25-606



Technical Data

d_s	d_k	k (max.)	n
2	4	1.4	0.5
2.5	5	1.7	0.6
3	6	2.1	0.8
3.5	7	2.4	0.8
4	8	2.8	1
4.5	9	3.1	1
5	10	3.5	1.2
5.5	11	3.8	1.2
6	12	4.2	1.6
7	14	4.9	2
8	16	5.6	2

- Wood screw thread acc. to DIN 7998.



Article groups

Driving features	Material	Surface treatment	Code	Page
Slotted	St	Zipl	25110	6-182
Slotted	St.St. A2		51860	6-183
Slotted	St.St. A4		55860	6-183
Slotted	Br Cu2/Cu3		49210	6-184
Slotted	Br Cu2/Cu3	Ni.pl.	49310	6-184

25110 Slotted round head wood screw			K05A
Material	Steel		
Surface treatment	Zinc plated		

$d_s \times L$	☒	Art.number	$d_s \times L$	☒	Art.number	$d_s \times L$	☒	Art.number
2X10MM	200	25110.020.010				4X40MM	200	25110.040.040
2X12MM	200	25110.020.012	3,5X10MM	200	25110.035.010	4X50MM	200	25110.040.050
			3,5X12MM	200	25110.035.012	4X60MM	200	25110.040.060
2,5X10MM	200	25110.025.010	3,5X16MM	200	25110.035.016	4X70MM	200	25110.040.070
2,5X12MM	200	25110.025.012	3,5X20MM	200	25110.035.020	4X80MM	200	25110.040.080
2,5X16MM	200	25110.025.016	3,5X25MM	200	25110.035.025			
2,5X20MM	200	25110.025.020	3,5X30MM	200	25110.035.030	4,5X16MM	200	25110.045.016
2,5X25MM	200	25110.025.025	3,5X35MM	200	25110.035.035	4,5X20MM	200	25110.045.020
2,5X30MM	200	25110.025.030	3,5X40MM	200	25110.035.040	4,5X25MM	200	25110.045.025
			3,5X45MM	200	25110.035.045	4,5X30MM	200	25110.045.030
3X10MM	200	25110.030.010	3,5X60MM	200	25110.035.060	4,5X40MM	200	25110.045.040
3X12MM	200	25110.030.012				4,5X45MM	200	25110.045.045
3X16MM	200	25110.030.016	4X12MM	200	25110.040.012	4,5X50MM	200	25110.045.050
3X20MM	200	25110.030.020	4X16MM	200	25110.040.016	4,5X60MM	200	25110.045.060
3X25MM	200	25110.030.025	4X20MM	200	25110.040.020			
3X30MM	200	25110.030.030	4X25MM	200	25110.040.025	5X16MM	200	25110.050.016
3X35MM	200	25110.030.035	4X30MM	200	25110.040.030	5X20MM	200	25110.050.020
3X40MM	200	25110.030.040	4X35MM	200	25110.040.035	5X25MM	200	25110.050.025

25110 Slotted round head wood screw								
d _s x L	☒	Art.number	d _s x L	☒	Art.number	d _s x L	☒	Art.number
5X30MM	200	25110.050.030	5,5X25MM	200	25110.055.025	6X30MM	200	25110.060.030
5X35MM	200	25110.050.035	5,5X30MM	200	25110.055.030	6X35MM	200	25110.060.035
5X40MM	200	25110.050.040	5,5X40MM	200	25110.055.040	6X40MM	200	25110.060.040
5X45MM	200	25110.050.045	5,5X45MM	200	25110.055.045	6X50MM	200	25110.060.050
5X50MM	200	25110.050.050	5,5X50MM	200	25110.055.050	6X60MM	100	25110.060.060
5X60MM	200	25110.050.060	5,5X60MM	100	25110.055.060	6X70MM	100	25110.060.070
5X70MM	200	25110.050.070	5,5X70MM	100	25110.055.070	6X80MM	100	25110.060.080
5X80MM	200	25110.050.080	5,5X100MM	100	25110.055.100			
5,5X20MM	200	25110.055.020	6X25MM	200	25110.060.025	7X50MM	100	25110.070.050
						7X60MM	100	25110.070.060

51860 Slotted round head wood screw		R03A
Material	Stainless steel A2	
		

d _s x L	☒	Art.number	d _s x L	☒	Art.number	d _s x L	☒	Art.number
2,5X10MM	200	51860.025.010	4X35MM	200	51860.040.035	5X80MM	200	51860.050.080
2,5X12MM	200	51860.025.012	4X40MM	200	51860.040.040	5X90MM	200	51860.050.090
2,5X16MM	200	51860.025.016	4X45MM	200	51860.040.045	5X100MM*	100	51860.050.100
2,5X20MM	200	51860.025.020	4X50MM	200	51860.040.050			
2,5X25MM*	500	51860.025.025	4X60MM	200	51860.040.060	5,5X25MM	200	51860.055.025
			4X70MM*	200	51860.040.070	5,5X30MM	200	51860.055.030
3X10MM	200	51860.030.010				5,5X35MM	200	51860.055.035
3X12MM	200	51860.030.012	4,5X16MM*	200	51860.045.016	5,5X40MM	200	51860.055.040
3X16MM	200	51860.030.016	4,5X20MM*	200	51860.045.020	5,5X50MM	200	51860.055.050
3X20MM	200	51860.030.020	4,5X25MM	200	51860.045.025	5,5X60MM*	200	51860.055.060
3X25MM	200	51860.030.025	4,5X30MM	200	51860.045.030	5,5X90MM*	100	51860.055.090
3X30MM	200	51860.030.030	4,5X35MM	200	51860.045.035			
3X35MM*	200	51860.030.035	4,5X40MM	200	51860.045.040	6X20MM*	200	51860.060.020
3X40MM*	200	51860.030.040	4,5X45MM*	200	51860.045.045	6X25MM	200	51860.060.025
			4,5X50MM	200	51860.045.050	6X30MM	200	51860.060.030
3,5X12MM	200	51860.035.012	4,5X60MM*	200	51860.045.060	6X35MM	200	51860.060.035
3,5X16MM	200	51860.035.016	4,5X70MM*	200	51860.045.070	6X40MM	200	51860.060.040
3,5X20MM	200	51860.035.020				6X45MM	200	51860.060.045
3,5X25MM	200	51860.035.025	5X16MM	200	51860.050.016	6X50MM	200	51860.060.050
3,5X30MM	200	51860.035.030	5X20MM	200	51860.050.020	6X55MM*	200	51860.060.055
3,5X35MM	200	51860.035.035	5X25MM	200	51860.050.025	6X60MM	100	51860.060.060
3,5X40MM*	200	51860.035.040	5X30MM	200	51860.050.030	6X70MM	100	51860.060.070
3,5X45MM*	200	51860.035.045	5X35MM	200	51860.050.035	6X80MM	100	51860.060.080
3,5X50MM*	200	51860.035.050	5X40MM	200	51860.050.040	6X90MM	100	51860.060.090
			5X45MM	200	51860.050.045	6X100MM	100	51860.060.100
4X12MM	200	51860.040.012	5X50MM	200	51860.050.050	6X110MM*	100	51860.060.110
4X16MM	200	51860.040.016	5X55MM*	200	51860.050.055	6X120MM*	100	51860.060.120
4X20MM	200	51860.040.020	5X60MM	200	51860.050.060			
4X25MM	200	51860.040.025	5X65MM*	100	51860.050.065	8X60MM*	100	51860.080.060
4X30MM	200	51860.040.030	5X70MM	200	51860.050.070			

55860 Slotted round head wood screw		R43A
Material	Stainless steel A4	
		

d _s x L	☒	Art.number	d _s x L	☒	Art.number	d _s x L	☒	Art.number
2,5X10MM*	500	55860.025.010	3,5X50MM*	200	55860.035.050	5X25MM*	200	55860.050.025
2,5X12MM*	500	55860.025.012				5X30MM*	200	55860.050.030
2,5X20MM*	500	55860.025.020	4X16MM*	200	55860.040.016	5X35MM*	200	55860.050.035
			4X20MM*	200	55860.040.020	5X40MM*	200	55860.050.040
3X12MM*	200	55860.030.012	4X25MM*	200	55860.040.025	5X45MM*	200	55860.050.045
3X16MM*	200	55860.030.016	4X30MM*	200	55860.040.030	5X50MM*	200	55860.050.050
3X20MM*	200	55860.030.020	4X35MM*	200	55860.040.035	5X60MM*	200	55860.050.060
3X25MM*	200	55860.030.025	4X40MM*	200	55860.040.040	5X70MM*	100	55860.050.070
3X30MM*	200	55860.030.030	4X45MM*	200	55860.040.045	5X75MM*	100	55860.050.075
3X40MM*	200	55860.030.040	4X50MM*	200	55860.040.050			
						6X30MM*	200	55860.060.030
3,5X16MM*	200	55860.035.016	4,5X20MM*	200	55860.045.020	6X35MM*	200	55860.060.035
3,5X20MM*	200	55860.035.020	4,5X35MM*	200	55860.045.035	6X40MM*	200	55860.060.040
3,5X25MM*	200	55860.035.025	4,5X50MM*	200	55860.045.050	6X45MM*	200	55860.060.045
3,5X30MM*	200	55860.035.030				6X50MM*	200	55860.060.050
3,5X40MM*	200	55860.035.040	5X20MM*	200	55860.050.020	6X70MM*	100	55860.060.070

49210 Slotted round head wood screw M07A

Material Brass Cu2/Cu3



d _s x L	☒	Art.number	d _s x L	☒	Art.number	d _s x L	☒	Art.number
2X8MM	200	49210.020.008	3,5X30MM	200	49210.035.030	5X20MM	200	49210.050.020
2X10MM	200	49210.020.010	3,5X35MM	200	49210.035.035	5X25MM	200	49210.050.025
2X12MM	200	49210.020.012	3,5X40MM	200	49210.035.040	5X30MM	200	49210.050.030
2X16MM	200	49210.020.016	3,5X45MM	200	49210.035.045	5X35MM	200	49210.050.035
			3,5X50MM	200	49210.035.050	5X40MM	200	49210.050.040
2,5X10MM	200	49210.025.010				5X45MM	200	49210.050.045
2,5X12MM	200	49210.025.012	4X12MM	200	49210.040.012	5X50MM	200	49210.050.050
2,5X16MM	200	49210.025.016	4X16MM	200	49210.040.016	5X60MM	200	49210.050.060
2,5X20MM	200	49210.025.020	4X20MM	200	49210.040.020	5X70MM	200	49210.050.070
2,5X25MM	200	49210.025.025	4X25MM	200	49210.040.025	5X80MM	200	49210.050.080
2,5X30MM	200	49210.025.030	4X30MM	200	49210.040.030			
			4X35MM	200	49210.040.035	5,5X20MM	200	49210.055.020
3X10MM	200	49210.030.010	4X40MM	200	49210.040.040	5,5X30MM	200	49210.055.030
3X12MM	200	49210.030.012	4X45MM	200	49210.040.045	5,5X40MM	200	49210.055.040
3X16MM	200	49210.030.016	4X50MM	200	49210.040.050	5,5X50MM	200	49210.055.050
3X20MM	200	49210.030.020	4X60MM	200	49210.040.060	5,5X60MM	100	49210.055.060
3X25MM	200	49210.030.025	4X70MM	200	49210.040.070	5,5X70MM	100	49210.055.070
3X30MM	200	49210.030.030						
3X35MM	200	49210.030.035	4,5X20MM	200	49210.045.020	6X30MM	200	49210.060.030
3X40MM	200	49210.030.040	4,5X25MM	200	49210.045.025	6X35MM	200	49210.060.035
			4,5X30MM	200	49210.045.030	6X40MM	200	49210.060.040
3,5X10MM	200	49210.035.010	4,5X35MM	200	49210.045.035	6X45MM	200	49210.060.045
3,5X12MM	200	49210.035.012	4,5X40MM	200	49210.045.040	6X50MM	200	49210.060.050
3,5X16MM	200	49210.035.016	4,5X45MM	200	49210.045.045	6X60MM	100	49210.060.060
3,5X20MM	200	49210.035.020	4,5X50MM	200	49210.045.050	6X70MM	100	49210.060.070
3,5X25MM	200	49210.035.025				6X80MM	100	49210.060.080

6

49310 Slotted round head wood screw M07A

Material Brass Cu2/Cu3
Surface treatment Nickel plated



d _s x L	☒	Art.number	d _s x L	☒	Art.number	d _s x L	☒	Art.number
2X10MM	200	49310.020.010	3,5X16MM	200	49310.035.016	4,5X35MM	200	49310.045.035
2X12MM	200	49310.020.012	3,5X20MM	200	49310.035.020	4,5X40MM	200	49310.045.040
2X16MM	200	49310.020.016	3,5X25MM	200	49310.035.025	4,5X50MM	200	49310.045.050
			3,5X30MM	200	49310.035.030			
2,5X10MM	200	49310.025.010	3,5X35MM	200	49310.035.035	5X25MM	200	49310.050.025
2,5X12MM	200	49310.025.012	3,5X40MM	200	49310.035.040	5X30MM	200	49310.050.030
2,5X16MM	200	49310.025.016				5X35MM	200	49310.050.035
2,5X20MM	200	49310.025.020	4X12MM	200	49310.040.012	5X40MM	200	49310.050.040
2,5X25MM	200	49310.025.025	4X20MM	200	49310.040.020	5X50MM	200	49310.050.050
			4X25MM	200	49310.040.025			
3X10MM	200	49310.030.010	4X30MM	200	49310.040.030	5,5X50MM	200	49310.055.050
3X12MM	200	49310.030.012	4X35MM	200	49310.040.035	5,5X60MM	100	49310.055.060
3X16MM	200	49310.030.016	4X40MM	200	49310.040.040	5,5X70MM	100	49310.055.070
3X20MM	200	49310.030.020	4X45MM	200	49310.040.045			
3X25MM	200	49310.030.025	4X50MM	200	49310.040.050	6X30MM	200	49310.060.030
3X30MM	200	49310.030.030				6X40MM	200	49310.060.040
			4,5X20MM	200	49310.045.020	6X60MM	100	49310.060.060
3,5X10MM	200	49310.035.010	4,5X25MM	200	49310.045.025	6X70MM	100	49310.060.070
3,5X12MM	200	49310.035.012	4,5X30MM	200	49310.045.030	6X80MM	100	49310.060.080

Slotted raised countersunk head wood screw

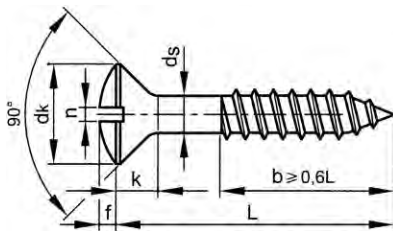

DIN 95
NEN 2252
NF E25-605



Technical Data

d_s	d_k	$f \approx$	k (max.)	n
2	3.8	0.5	1.2	0.5
2.5	4.7	0.6	1.5	0.6
3	5.6	0.75	1.65	0.8
3.5	6.5	0.9	1.93	0.8
4	7.5	1	2.2	1
4.5	8.3	1.1	2.35	1
5	9.2	1.25	2.5	1.2
5.5	10.2	1.4	2.75	1.2
6	11	1.5	3	1.6
7	12.5	1.75	3.5	1.8
8	14.5	2	4	2

• Wood screw thread acc. to DIN 7998.

Article groups

Driving features	Material	Surface treatment	Code	Page
Slotted	St.St. A2		51880	6-185
Slotted	St.St. A4		55880	6-186
Slotted	Br Cu2/Cu3		49250	6-186
Slotted	Br Cu2/Cu3	Ni.pl.	49350	6-186

51880 Slotted raised countersunk head wood screw

R03A

Material Stainless steel A2



$d_s \times L$	☒	Art.number	$d_s \times L$	☒	Art.number	$d_s \times L$	☒	Art.number
2,5X10MM	200	51880.025.010	4X45MM	200	51880.040.045	5,5X20MM*	200	51880.055.020
2,5X12MM*	500	51880.025.012	4X50MM	200	51880.040.050	5,5X30MM*	200	51880.055.030
2,5X16MM	200	51880.025.016	4X60MM	200	51880.040.060	5,5X35MM*	200	51880.055.035
2,5X20MM	200	51880.025.020	4X70MM*	200	51880.040.070	5,5X40MM	200	51880.055.040
2,5X25MM	200	51880.025.025				5,5X45MM	200	51880.055.045
			4,5X16MM*	200	51880.045.016	5,5X50MM	200	51880.055.050
3X10MM*	200	51880.030.010	4,5X20MM*	200	51880.045.020	5,5X60MM	100	51880.055.060
3X12MM	200	51880.030.012	4,5X25MM	200	51880.045.025	5,5X70MM	100	51880.055.070
3X16MM	200	51880.030.016	4,5X30MM	200	51880.045.030			
3X20MM	200	51880.030.020	4,5X35MM	200	51880.045.035	6X20MM*	200	51880.060.020
3X25MM	200	51880.030.025	4,5X40MM	200	51880.045.040	6X25MM*	200	51880.060.025
3X30MM	200	51880.030.030	4,5X45MM	200	51880.045.045	6X30MM	200	51880.060.030
3X35MM	200	51880.030.035	4,5X50MM	200	51880.045.050	6X35MM	200	51880.060.035
3X40MM*	200	51880.030.040	4,5X60MM*	200	51880.045.060	6X40MM	200	51880.060.040
			4,5X65MM*	200	51880.045.065	6X45MM	200	51880.060.045
3,5X12MM	200	51880.035.012	4,5X70MM*	200	51880.045.070	6X50MM	200	51880.060.050
3,5X16MM	200	51880.035.016				6X60MM	100	51880.060.060
3,5X20MM	200	51880.035.020	5X16MM*	200	51880.050.016	6X65MM*	100	51880.060.065
3,5X25MM	200	51880.035.025	5X20MM	200	51880.050.020	6X70MM	100	51880.060.070
3,5X30MM	200	51880.035.030	5X25MM	200	51880.050.025	6X75MM*	100	51880.060.075
3,5X35MM	200	51880.035.035	5X30MM	200	51880.050.030	6X80MM*	100	51880.060.080
3,5X40MM	200	51880.035.040	5X35MM	200	51880.050.035	6X90MM*	100	51880.060.090
3,5X45MM*	200	51880.035.045	5X40MM	200	51880.050.040	6X100MM*	100	51880.060.100
3,5X50MM*	200	51880.035.050	5X45MM	200	51880.050.045	6X110MM*	100	51880.060.110
			5X50MM	200	51880.050.050	6X120MM*	100	51880.060.120
4X12MM	200	51880.040.012	5X60MM	200	51880.050.060			
4X16MM	200	51880.040.016	5X70MM	200	51880.050.070	7X80MM*	100	51880.070.080
4X20MM	200	51880.040.020	5X75MM*	100	51880.050.075			
4X25MM	200	51880.040.025	5X80MM*	100	51880.050.080	8X40MM*	100	51880.080.040
4X30MM	200	51880.040.030	5X90MM*	100	51880.050.090	8X45MM*	100	51880.080.045
4X35MM	200	51880.040.035	5X100MM*	100	51880.050.100	8X60MM*	100	51880.080.060
4X40MM	200	51880.040.040				8X80MM*	100	51880.080.080

51880 Slotted raised countersunk head wood screw

d _s x L	☒	Art.number
8X90MM*	100	51880.080.090

55880 Slotted raised countersunk head wood screw
R43A
Material Stainless steel A4

d _s x L	☒	Art.number	d _s x L	☒	Art.number	d _s x L	☒	Art.number
2.5X10MM*	500	55880.025.010	4X16MM*	200	55880.040.016	5X40MM*	200	55880.050.040
2.5X12MM*	500	55880.025.012	4X20MM*	200	55880.040.020	5X45MM*	200	55880.050.045
2.5X16MM*	500	55880.025.016	4X25MM*	200	55880.040.025	5X50MM*	200	55880.050.050
2.5X20MM*	500	55880.025.020	4X30MM*	200	55880.040.030	5X60MM*	200	55880.050.060
3X12MM*	200	55880.030.012	4X35MM*	200	55880.040.035	5X70MM*	100	55880.050.070
3X16MM*	200	55880.030.016	4X40MM*	200	55880.040.040	5X80MM*	100	55880.050.080
3X20MM*	200	55880.030.020	4X45MM*	200	55880.040.045	6X20MM*	200	55880.060.020
3X25MM*	200	55880.030.025	4X50MM*	200	55880.040.050	6X25MM*	200	55880.060.025
3X30MM*	200	55880.030.030	4X60MM*	200	55880.040.060	6X30MM*	200	55880.060.030
3X35MM*	200	55880.030.035	4X70MM*	200	55880.040.070	6X35MM*	200	55880.060.035
3X40MM*	200	55880.030.040	4.5X20MM*	200	55880.045.020	6X40MM*	200	55880.060.040
3.5X16MM*	200	55880.035.016	4.5X25MM*	200	55880.045.025	6X45MM*	200	55880.060.045
3.5X20MM*	200	55880.035.020	4.5X30MM*	200	55880.045.030	6X50MM*	200	55880.060.050
3.5X25MM*	200	55880.035.025	4.5X45MM*	200	55880.045.045	6X60MM*	200	55880.060.060
3.5X30MM*	200	55880.035.030	4.5X50MM*	200	55880.045.050	6X70MM*	100	55880.060.070
3.5X35MM*	200	55880.035.035	5X20MM*	200	55880.050.020	6X75MM*	100	55880.060.075
3.5X40MM*	200	55880.035.040	5X25MM*	200	55880.050.025	6X80MM*	100	55880.060.080
3.5X45MM*	200	55880.035.045	5X30MM*	200	55880.050.030	8X80MM*	100	55880.080.080
			5X35MM*	200	55880.050.035	8X90MM*	100	55880.080.090

6
49250 Slotted raised countersunk head wood screw
M07A
Material Brass Cu2/Cu3



d _s x L	☒	Art.number	d _s x L	☒	Art.number	d _s x L	☒	Art.number
2.5X10MM	200	49250.025.010	4X16MM	200	49250.040.016	4.5X70MM	200	49250.045.070
2.5X12MM	200	49250.025.012	4X20MM	200	49250.040.020	5X25MM	200	49250.050.025
2.5X16MM	200	49250.025.016	4X25MM	200	49250.040.025	5X30MM	200	49250.050.030
3X12MM	200	49250.030.012	4X30MM	200	49250.040.030	5X35MM	200	49250.050.035
3X16MM	200	49250.030.016	4X35MM	200	49250.040.035	5X40MM	200	49250.050.040
3X20MM	200	49250.030.020	4X40MM	200	49250.040.040	5X45MM	200	49250.050.045
3X25MM	200	49250.030.025	4X45MM	200	49250.040.045	5X50MM	200	49250.050.050
3X30MM	200	49250.030.030	4X50MM	200	49250.040.050	5X60MM	200	49250.050.060
3.5X12MM	200	49250.035.012	4X60MM	200	49250.040.060	5X70MM	200	49250.050.070
3.5X16MM	200	49250.035.016	4X70MM	200	49250.040.070	5X80MM	200	49250.050.080
3.5X20MM	200	49250.035.020	4.5X25MM	200	49250.045.025	5.5X40MM	200	49250.055.040
3.5X25MM	200	49250.035.025	4.5X30MM	200	49250.045.030	5.5X50MM	200	49250.055.050
3.5X30MM	200	49250.035.030	4.5X35MM	200	49250.045.035	5.5X60MM	100	49250.055.060
3.5X35MM	200	49250.035.035	4.5X40MM	200	49250.045.040	5.5X70MM	100	49250.055.070
3.5X40MM	200	49250.035.040	4.5X45MM	200	49250.045.045	5.5X80MM	100	49250.055.080
			4.5X50MM	200	49250.045.050			
			4.5X60MM	200	49250.045.060			

49350 Slotted raised countersunk head wood screw
M07A
Material Brass Cu2/Cu3
Surface treatment Nickel plated

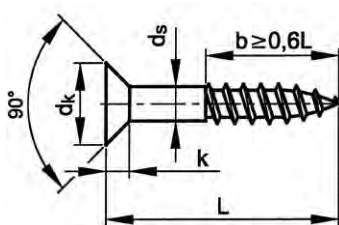

d _s x L	☒	Art.number	d _s x L	☒	Art.number	d _s x L	☒	Art.number
2X10MM	200	49350.020.010	2.5X16MM	200	49350.025.016	3X12MM	200	49350.030.012
2X12MM	200	49350.020.012	2.5X20MM	200	49350.025.020	3X16MM	200	49350.030.016
2X16MM	200	49350.020.016	2.5X25MM	200	49350.025.025	3X20MM	200	49350.030.020
2.5X10MM	200	49350.025.010	2.5X30MM	200	49350.025.030	3X25MM	200	49350.030.025
2.5X12MM	200	49350.025.012	3X10MM	200	49350.030.010	3X30MM	200	49350.030.030
						3X35MM	200	49350.030.035

49350 Slotted raised countersunk head wood screw								
$d_s \times L$	☒	Art.number	$d_s \times L$	☒	Art.number	$d_s \times L$	☒	Art.number
3X40MM	200	49350.030.040	4X45MM	200	49350.040.045	5X40MM	200	49350.050.040
3,5X12MM	200	49350.035.012	4X50MM	200	49350.040.050	5X45MM	200	49350.050.045
3,5X16MM	200	49350.035.016	4X60MM	200	49350.040.060	5X50MM	200	49350.050.050
3,5X20MM	200	49350.035.020	4X70MM	200	49350.040.070	5X60MM	200	49350.050.060
3,5X25MM	200	49350.035.025	4,5X20MM	200	49350.045.020	5X70MM	200	49350.050.070
3,5X30MM	200	49350.035.030	4,5X25MM	200	49350.045.025	5,5X40MM	200	49350.055.040
3,5X35MM	200	49350.035.035	4,5X30MM	200	49350.045.030	5,5X50MM	200	49350.055.050
3,5X40MM	200	49350.035.040	4,5X35MM	200	49350.045.035	5,5X60MM	100	49350.055.060
3,5X45MM	200	49350.035.045	4,5X40MM	200	49350.045.040	5,5X70MM	100	49350.055.070
3,5X50MM	200	49350.035.050	4,5X45MM	200	49350.045.045	6X30MM	200	49350.060.030
4X12MM	200	49350.040.012	4,5X50MM	200	49350.045.050	6X35MM	200	49350.060.035
4X16MM	200	49350.040.016	4,5X60MM	200	49350.045.060	6X40MM	200	49350.060.040
4X20MM	200	49350.040.020	4,5X70MM	200	49350.045.070	6X45MM	200	49350.060.045
4X25MM	200	49350.040.025	5X20MM	200	49350.050.020	6X50MM	200	49350.060.050
4X30MM	200	49350.040.030	5X25MM	200	49350.050.025	6X60MM	100	49350.060.060
4X35MM	200	49350.040.035	5X30MM	200	49350.050.030	6X70MM	100	49350.060.070
4X40MM	200	49350.040.040	5X35MM	200	49350.050.035	6X80MM	100	49350.060.080

Cross recessed countersunk (flat) head wood screw

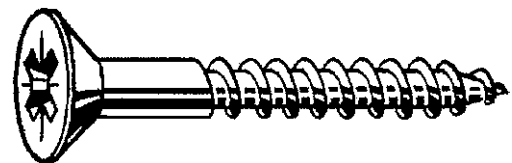

POZIDRIV (Z) DIN 7997-Z
NEN 2253
NF E25-601



6

Technical Data

d_s	d_k	k (max.)	No. cross recess
3	5.6	1.65	1
3.5	6.5	1.93	2
4	7.5	2.2	2
4.5	8.3	2.35	2
5	9.2	2.5	2
6	11	3	3

• Wood screw thread acc. to DIN 7998.

51876 Cross recessed countersunk (flat) head wood screw Pozidriv		R03A
Material	Stainless steel A2	

$d_s \times L$	☒	Art.number	$d_s \times L$	☒	Art.number	$d_s \times L$	☒	Art.number
3X12MM	200	51876.030.012	4X50MM	200	51876.040.050	5X60MM	200	51876.050.060
3X16MM	200	51876.030.016	4X60MM	200	51876.040.060	5X70MM	200	51876.050.070
3X20MM	200	51876.030.020	4,5X20MM	200	51876.045.020	5X75MM*	100	51876.050.075
3X25MM	200	51876.030.025	4,5X25MM	200	51876.045.025	5X80MM	200	51876.050.080
3X30MM*	200	51876.030.030	4,5X30MM	200	51876.045.030	5X90MM	200	51876.050.090
3,5X16MM	200	51876.035.016	4,5X35MM	200	51876.045.035	5X100MM	200	51876.050.100
3,5X20MM	200	51876.035.020	4,5X40MM	200	51876.045.040	6X30MM*	200	51876.060.030
3,5X25MM	200	51876.035.025	4,5X45MM*	200	51876.045.045	6X35MM*	200	51876.060.035
3,5X30MM	200	51876.035.030	4,5X50MM	200	51876.045.050	6X40MM	200	51876.060.040
3,5X35MM*	200	51876.035.035	4,5X60MM*	200	51876.045.060	6X45MM*	200	51876.060.045
3,5X40MM	200	51876.035.040	5X20MM	200	51876.050.020	6X50MM	200	51876.060.050
4X16MM	200	51876.040.016	5X25MM*	200	51876.050.025	6X60MM	100	51876.060.060
4X20MM	200	51876.040.020	5X30MM	200	51876.050.030	6X70MM	100	51876.060.070
4X25MM	200	51876.040.025	5X35MM*	200	51876.050.035	6X80MM	100	51876.060.080
4X30MM	200	51876.040.030	5X40MM	200	51876.050.040	6X90MM*	100	51876.060.090
4X35MM	200	51876.040.035	5X45MM	200	51876.050.045	6X100MM	100	51876.060.100
4X40MM	200	51876.040.040	5X50MM	200	51876.050.050	6X110MM*	100	51876.060.110
4X45MM	200	51876.040.045				6X120MM*	100	51876.060.120

Countersunk head timber screw/ribs PZ

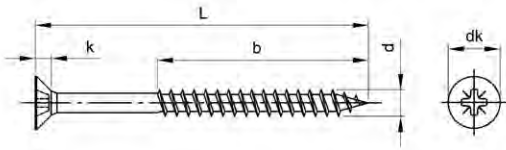

Technical Data

d	d _k	k	No. cross recess
3	6	1.9	1
3.5	7	2.1	2
4	8	2.5	2
4.5	9	2.7	2
5	10	3	2
6	12	3.6	3

Article groups

Driving features	Material	Code	Page
Pozidriv	St.St. A2	51874	6-188
Pozidriv	St.St. A4	55874	6-188

6

51874	Countersunk head timber screw/ribs PZ	R03A
Material	Stainless steel A2	

d _s x L x b	☒	Art.number	d _s x L x b	☒	Art.number	d _s x L x b	☒	Art.number
3X25X18MM*	500	51874.030.025	4X70X36MM*	200	51874.040.070	5X70X42MM*	100	51874.050.070
3X30X18MM*	500	51874.030.030	4X80X48MM*	200	51874.040.080	5X80X48MM*	100	51874.050.080
3X35X24MM*	500	51874.030.035				5X90X54MM*	100	51874.050.090
3X40X24MM*	200	51874.030.040	4,5X25X18MM*	500	51874.045.025	5X100X60MM*	100	51874.050.100
3X45X30MM*	200	51874.030.045	4,5X30X18MM*	500	51874.045.030	5X110X70MM*	100	51874.050.110
3X50X30MM*	200	51874.030.050	4,5X35X24MM*	500	51874.045.035			
			4,5X40X24MM*	200	51874.045.040	6X30X20MM*	100	51874.060.030
3,5X25X18MM*	500	51874.035.025	4,5X45X30MM*	200	51874.045.045	6X35X24MM*	100	51874.060.035
3,5X30X18MM*	500	51874.035.030	4,5X50X30MM*	200	51874.045.050	6X40X24MM*	100	51874.060.040
3,5X35X24MM*	500	51874.035.035	4,5X55X36MM*	200	51874.045.055	6X45X30MM*	100	51874.060.045
3,5X40X24MM*	200	51874.035.040	4,5X60X36MM*	200	51874.045.060	6X50X30MM*	100	51874.060.050
3,5X45X30MM*	200	51874.035.045	4,5X80X48MM*	200	51874.045.080	6X55X36MM*	100	51874.060.055
3,5X50X30MM*	200	51874.035.050	4,5X100X60MM*	200	51874.045.100	6X60X36MM*	100	51874.060.060
						6X70X42MM*	100	51874.060.070
4X25X18MM*	500	51874.040.025	5X25X18MM*	500	51874.050.025	6X80X48MM*	100	51874.060.080
4X30X18MM*	500	51874.040.030	5X30X20MM*	500	51874.050.030	6X90X54MM*	100	51874.060.090
4X35X24MM*	500	51874.040.035	5X35X24MM*	500	51874.050.035	6X130X70MM*	100	51874.060.130
4X40X24MM*	200	51874.040.040	5X40X24MM*	200	51874.050.040	6X140X70MM*	100	51874.060.140
4X45X30MM*	200	51874.040.045	5X45X30MM*	200	51874.050.045	6X150X70MM*	100	51874.060.150
4X50X30MM*	200	51874.040.050	5X50X30MM*	200	51874.050.050	6X160X70MM*	100	51874.060.160
4X55X36MM*	200	51874.040.055	5X55X36MM*	200	51874.050.055	6X180X70MM*	100	51874.060.180
4X60X36MM*	200	51874.040.060	5X60X36MM*	100	51874.050.060	6X200X70MM*	100	51874.060.200
4X65X36MM*	200	51874.040.065	5X65X36MM*	100	51874.050.065			

55874	Countersunk head timber screw/ribs PZ	R43A
Material	Stainless steel A4	

d _s x L x b	☒	Art.number	d _s x L x b	☒	Art.number	d _s x L x b	☒	Art.number
4X40X24MM*	200	55874.040.040	4,5X25X18MM*	500	55874.045.025	4,5X60X36MM*	200	55874.045.060
4X45X30MM*	200	55874.040.045	4,5X30X18MM*	500	55874.045.030	4,5X70X42MM*	200	55874.045.070
4X50X30MM*	200	55874.040.050	4,5X35X24MM*	500	55874.045.035	4,5X100X60MM*	100	55874.045.100
4X55X36MM*	200	55874.040.055	4,5X40X24MM*	200	55874.045.040			
4X60X36MM*	200	55874.040.060	4,5X45X30MM*	200	55874.045.045	5X25X18MM*	500	55874.050.025
4X70X42MM*	200	55874.040.070	4,5X50X30MM*	200	55874.045.050	5X30X20MM*	500	55874.050.030
			4,5X55X36MM*	200	55874.045.055	5X35X24MM*	500	55874.050.035

55874 Countersunk head timber screw/ribs PZ								
$d_s \times L \times b$	☒	Art.number	$d_s \times L \times b$	☒	Art.number	$d_s \times L \times b$	☒	Art.number
5X40X24MM*	200	55874.050.040	6X30X20MM*	100	55874.060.030	6X120X70MM*	100	55874.060.120
5X45X30MM*	200	55874.050.045	6X35X24MM*	100	55874.060.035	6X130X70MM*	100	55874.060.130
5X50X30MM*	200	55874.050.050	6X40X24MM*	100	55874.060.040	6X140X70MM*	100	55874.060.140
5X55X36MM*	200	55874.050.055	6X45X60MM*	100	55874.060.045	6X150X70MM*	100	55874.060.150
5X60X36MM*	100	55874.050.060	6X50X60MM*	100	55874.060.050	6X160X70MM*	100	55874.060.160
5X65X36MM*	100	55874.050.065	6X55X36MM*	100	55874.060.055	6X180X70MM*	100	55874.060.180
5X80X48MM*	100	55874.050.080	6X60X36MM*	100	55874.060.060	6X200X70MM*	100	55874.060.200
5X90X54MM*	100	55874.050.090	6X100X70MM*	100	55874.060.100			
			6X110X70MM*	100	55874.060.110			

Cross recessed round head wood screw

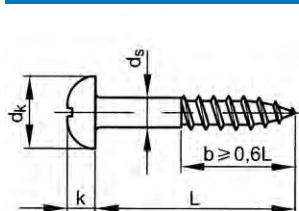

PHILLIPS (H)



Pozidriv (Z)

DIN 7996
NEN 2254
NF E25-603

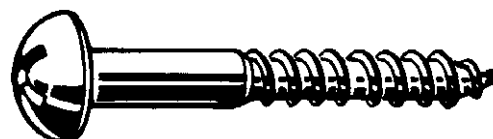

Technical Data

d_s	d_k	k	No. cross recess
3	6	2.1	1
3.5	7	2.35	2
4	8	2.8	2
4.5	9	3.1	2
5	10	3.5	2
6	12	4.2	3

• Wood screw thread acc. to DIN 7998.

Article groups

Driving features	Material	Surface treatment	Code	Page
Phillips	St	Zipl	25710	6-189
Pozidriv	St.St. A2		51866	6-189

25710 Cross recessed round head wood screw Phillips				K05A
Material	Steel	DIN	7996-H	
Surface treatment	Zinc plated			

$d_s \times L$	☒	Art.number	$d_s \times L$	☒	Art.number	$d_s \times L$	☒	Art.number
4X15MM	200	25710.040.015	4X25MM	200	25710.040.025	4X40MM	200	25710.040.040
4X20MM	200	25710.040.020	4X30MM	200	25710.040.030	4X50MM	200	25710.040.050

51866 Cross recessed round head wood screw Pozidriv				R03A
Material	Stainless steel A2	DIN	7996-Z	

$d_s \times L$	☒	Art.number	$d_s \times L$	☒	Art.number	$d_s \times L$	☒	Art.number
3X10MM	200	51866.030.010	4X12MM	200	51866.040.012	4,5X30MM*	200	51866.045.030
3X12MM*	200	51866.030.012	4X16MM	200	51866.040.016	4,5X35MM*	200	51866.045.035
3X16MM	200	51866.030.016	4X20MM	200	51866.040.020	4,5X40MM*	200	51866.045.040
3X20MM	200	51866.030.020	4X25MM	200	51866.040.025	4,5X45MM*	200	51866.045.045
3X25MM	200	51866.030.025	4X35MM*	200	51866.040.035	4,5X60MM*	200	51866.045.060
3X30MM*	200	51866.030.030	4X40MM	200	51866.040.040			
			4X45MM*	200	51866.040.045	5X20MM	200	51866.050.020
3,5X20MM	200	51866.035.020	4X50MM*	200	51866.040.050	5X25MM	200	51866.050.025
3,5X25MM	200	51866.035.025	4X60MM*	200	51866.040.060	5X30MM	200	51866.050.030
3,5X30MM	200	51866.035.030				5X35MM	200	51866.050.035
3,5X35MM*	200	51866.035.035				5X40MM	200	51866.050.040
3,5X40MM*	200	51866.035.040	4,5X25MM*	200	51866.045.025	5X45MM	200	51866.050.045

51866 Cross recessed round head wood screw Pozidriv								
$d_s \times L$	☒	Art.number	$d_s \times L$	☒	Art.number	$d_s \times L$	☒	Art.number
5X50MM	200	51866.050.050	5X100MM	200	51866.050.100	6X50MM*	200	51866.060.050
5X60MM	200	51866.050.060				6X60MM*	200	51866.060.060
5X70MM	200	51866.050.070	6X30MM*	200	51866.060.030	6X70MM*	100	51866.060.070
5X80MM	200	51866.050.080	6X40MM*	200	51866.060.040	6X80MM*	100	51866.060.080
5X90MM	200	51866.050.090	6X45MM*	200	51866.060.045			

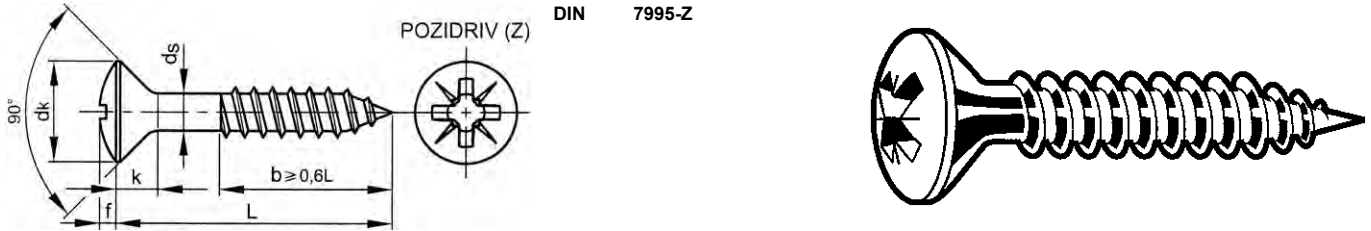

Cross recessed raised countersunk head wood screw



Technical Data

d_s	d_k	$f \approx$	k (max.)	No. cross recess
3	5.6	0.75	1.65	1
3.5	6.5	0.9	1.93	2
4	7.5	1	2.2	2
4.5	8.3	1.1	2.35	2
5	9.2	1.25	2.5	2
6	11	1.5	3	3

6

51866 Cross recessed raised countersunk head wood screw Pozidriv		R03A
Material	Stainless steel A2	
		

$d_s \times L$	☒	Art.number	$d_s \times L$	☒	Art.number	$d_s \times L$	☒	Art.number
3X16MM	200	51886.030.016	4X60MM*	200	51886.040.060	5X25MM*	200	51886.050.025
3X20MM*	200	51886.030.020	4X70MM*	200	51886.040.070	5X30MM*	200	51886.050.030
3X25MM	200	51886.030.025				5X35MM*	200	51886.050.035
3X30MM*	200	51886.030.030	4,5X20MM*	200	51886.045.020	5X40MM	200	51886.050.040
3X35MM*	200	51886.030.035	4,5X25MM*	200	51886.045.025	5X45MM*	200	51886.050.045
			4,5X30MM*	200	51886.045.030	5X50MM*	200	51886.050.050
3,5X16MM	200	51886.035.016	4,5X35MM*	200	51886.045.035	5X60MM*	200	51886.050.060
3,5X20MM	200	51886.035.020	4,5X40MM*	200	51886.045.040	5X70MM*	100	51886.050.070
3,5X25MM*	200	51886.035.025	4,5X45MM*	200	51886.045.045	5X80MM*	100	51886.050.080
3,5X30MM*	200	51886.035.030	4,5X50MM*	200	51886.045.050			
3,5X35MM*	200	51886.035.035	4,5X55MM*	200	51886.045.055	6X25MM*	200	51886.060.025
			4,5X60MM*	200	51886.045.060	6X35MM*	200	51886.060.035
4X16MM	200	51886.040.016	4,5X65MM*	200	51886.045.065	6X40MM*	200	51886.060.040
4X20MM	200	51886.040.020	4,5X70MM*	200	51886.045.070	6X45MM*	200	51886.060.045
4X25MM	200	51886.040.025	4,5X80MM*	200	51886.045.080	6X50MM*	200	51886.060.050
4X30MM*	200	51886.040.030	4,5X90MM*	200	51886.045.090	6X60MM*	200	51886.060.060
4X35MM*	200	51886.040.035	4,5X100MM*	200	51886.045.100	6X70MM*	100	51886.060.070
4X40MM*	200	51886.040.040	4,5X120MM*	200	51886.045.120	6X80MM*	100	51886.060.080
4X45MM*	200	51886.040.045	4,5X150MM*	200	51886.045.150	6X90MM*	100	51886.060.090
4X50MM*	200	51886.040.050				6X100MM*	100	51886.060.100

Woodscrew with washers Pozidriv

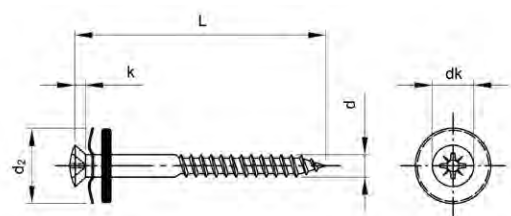

Technical Data

d	d _k	k	No. cross recess
4.5	8.3	2.35	2
5	9.2	2.5	2

Article groups

Driving features	Material	Surface treatment	Code	Page	
Pozidriv	St.St. A2	ring ø=15mm	51781	6-191	
Pozidriv	St.St. A2	ring ø=20mm	51785	6-191	
Pozidriv	St.St. A2	ring ø=25mm	51787	6-191	
Pozidriv	St.St. A2	Copper plated	ring ø=15mm	51844	6-192
Pozidriv	St.St. A2	Copper plated	ring ø=20mm	51846	6-192
Pozidriv	St.St. A2	Copper plated	ring ø=25mm	51848	6-192

51781 Woodscrew with washers 15mm Pozidriv

R03A

Material Stainless steel A2



d x L x d ₂	☒	Art.number	d x L x d ₂	☒	Art.number	d x L x d ₂	☒	Art.number
4,5X20x15MM*	200	51781.045.020	4,5X55x15MM*	200	51781.045.055	4,5X100x15MM*	100	51781.045.100
4,5X25x15MM*	200	51781.045.025	4,5X60x15MM*	200	51781.045.060	4,5X120x15MM*	100	51781.045.120
4,5X30x15MM*	200	51781.045.030	4,5X65x15MM*	200	51781.045.065	4,5X150x15MM*	100	51781.045.150
4,5X35x15MM*	200	51781.045.035	4,5X70x15MM*	200	51781.045.070			
4,5X40x15MM*	200	51781.045.040	4,5X80x15MM*	200	51781.045.080	5,0X180x15MM*	100	51781.050.180
4,5X45x15MM*	200	51781.045.045	4,5X90x15MM*	200	51781.045.090	5,0X200x15MM*	100	51781.050.200
4,5X50x15MM*	200	51781.045.050						

51785 Woodscrew with washers 20mm Pozidriv

R03A

Material Stainless steel A2



d x L x d ₂	☒	Art.number	d x L x d ₂	☒	Art.number	d x L x d ₂	☒	Art.number
4,5X20x20MM*	200	51785.045.020	4,5X35x20MM*	200	51785.045.035	4,5X60x20MM*	200	51785.045.060
4,5X25x20MM*	200	51785.045.025	4,5X45x20MM*	200	51785.045.045	4,5X70x20MM*	200	51785.045.070
4,5X30x20MM*	200	51785.045.030	4,5X55x20MM*	200	51785.045.055	4,5X80x20MM*	200	51785.045.080

51787 Woodscrew with washers 25mm Pozidriv

R03A

Material Stainless steel A2



d x L x d ₂	☒	Art.number	d x L x d ₂	☒	Art.number	d x L x d ₂	☒	Art.number
4,5X20x25MM*	200	51787.045.020	4,5X35x25MM*	200	51787.045.035	4,5X70x25MM*	200	51787.045.070
4,5X25x25MM*	200	51787.045.025	4,5X60x25MM*	200	51787.045.060			

51844 **Woodscrew with washers 15mm Pozidriv** **R03A**

Material Stainless steel A2
Surface treatment Copper plated



d x L x d ₂	☒	Art.number	d x L x d ₂	☒	Art.number	d x L x d ₂	☒	Art.number
4,5X20x15MM*	200	51844.045.020	4,5X60x15MM*	200	51844.045.060	4,5X150x15MM*	100	51844.045.150
4,5X25x15MM*	200	51844.045.025	4,5X70x15MM*	200	51844.045.070			
4,5X35x15MM*	200	51844.045.035	4,5X80x15MM*	200	51844.045.080	5,0X180x15MM*	100	51844.050.180
4,5X45x15MM*	200	51844.045.045	4,5X100x15MM*	100	51844.045.100	5,0X200x15MM*	100	51844.050.200
4,5X55x15MM*	200	51844.045.055	4,5X120x15MM*	100	51844.045.120			

51846 **Woodscrew with washers 20mm Pozidriv** **R03A**

Material Stainless steel A2
Surface treatment Copper plated



d x L x d ₂	☒	Art.number	d x L x d ₂	☒	Art.number	d x L x d ₂	☒	Art.number
4,5X20x20MM*	200	51846.045.020	4,5X35x20MM*	200	51846.045.035	4,5X60x20MM*	200	51846.045.060
4,5X25x20MM*	200	51846.045.025	4,5X50x20MM*	200	51846.045.050	4,5X70x20MM*	200	51846.045.070

6

51848 **Woodscrew with washers 25mm Pozidriv** **R03A**

Material Stainless steel A2
Surface treatment Copper plated



d x L x d ₂	☒	Art.number	d x L x d ₂	☒	Art.number
4,5X35x25MM*	200	51848.045.035	4,5X45x25MM*	200	51848.045.045

Woodscrew with washer Pozidriv

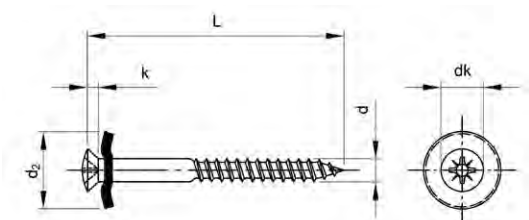

Technical Data

d	d _k	k	No. cross recess
4.5	8.3	2.35	2
5	9.2	2.5	2

Article groups

Driving features	Material	Surface treatment	Code	Page
Pozidriv	St.St. A2	ring ø=15mm	51780	6-193
Pozidriv	St.St. A2	ring ø=20mm	51788	6-193
Pozidriv	St.St. A2	ring ø=25mm	51786	6-193
Pozidriv	St.St. A2	Copper plated ring ø=15mm	51843	6-194
Pozidriv	St.St. A2	Copper plated ring ø=20mm	51845	6-194
Pozidriv	St.St. A2	Copper plated ring ø=25mm	51847	6-194

51780 Woodscrew with washer 15mm Pozidriv

R03A

Material Stainless steel A2



d x L x d ₂	☒	Art.number	d x L x d ₂	☒	Art.number	d x L x d ₂	☒	Art.number
4,5X20x15MM*	200	51780.045.020	4,5X60x15MM*	200	51780.045.060	4,5X150x15MM*	100	51780.045.150
4,5X25x15MM*	200	51780.045.025	4,5X65x15MM*	200	51780.045.065	5,0X180x15MM*	100	51780.050.180
4,5X30x15MM*	200	51780.045.030	4,5X70x15MM*	200	51780.045.070	5,0X200x15MM*	100	51780.050.200
4,5X35x15MM*	200	51780.045.035	4,5X80x15MM*	200	51780.045.080	5,0X220x15MM*	100	51780.050.220
4,5X40x15MM*	200	51780.045.040	4,5X90x15MM*	200	51780.045.090	5,0X250x15MM*	100	51780.050.250
4,5X45x15MM*	200	51780.045.045	4,5X100x15MM*	100	51780.045.100	5,0X300x15MM*	100	51780.050.300
4,5X50x15MM*	200	51780.045.050	4,5X120x15MM*	100	51780.045.120			
4,5X55x15MM*	200	51780.045.055						

51788 Woodscrew with washer 20mm Pozidriv

R03A

Material Stainless steel A2



d x L x d ₂	☒	Art.number	d x L x d ₂	☒	Art.number	d x L x d ₂	☒	Art.number
4,5X20x20MM*	200	51788.045.020	4,5X55x20MM*	200	51788.045.055	4,5X150x20MM*	100	51788.045.150
4,5X25x20MM*	200	51788.045.025	4,5X60x20MM*	200	51788.045.060	5,0X180x20MM*	100	51788.050.180
4,5X30x20MM*	200	51788.045.030	4,5X65x20MM*	100	51788.045.065	5,0X200x20MM*	100	51788.050.200
4,5X35x20MM*	200	51788.045.035	4,5X70x20MM*	100	51788.045.070	5,0X220x20MM*	100	51788.050.220
4,5X40x20MM*	200	51788.045.040	4,5X80x20MM*	100	51788.045.080	5,0X250x20MM*	100	51788.050.250
4,5X45x20MM*	200	51788.045.045	4,5X100x20MM*	100	51788.045.100			
4,5X50x20MM*	200	51788.045.050	4,5X120x20MM*	100	51788.045.120			

51786 Woodscrew with washer 25mm Pozidriv

R03A

Material Stainless steel A2



d x L x d ₂	☒	Art.number	d x L x d ₂	☒	Art.number	d x L x d ₂	☒	Art.number
4,5X20x25MM*	200	51786.045.020	4,5X40x25MM*	200	51786.045.040	4,5X55x25MM*	200	51786.045.055
4,5X25x25MM*	200	51786.045.025	4,5X45x25MM*	200	51786.045.045	4,5X60x25MM*	200	51786.045.060
4,5X30x25MM*	200	51786.045.030	4,5X50x25MM*	200	51786.045.050	4,5X70x25MM*	200	51786.045.070
4,5X35x25MM*	200	51786.045.035						

51843 Woodscrew with washer 15mm Pozidriv R03A

Material Stainless steel A2
Surface treatment Copper plated



d x L x d ₂	☒	Art.number	d x L x d ₂	☒	Art.number	d x L x d ₂	☒	Art.number
4,5X20x15MM*	200	51843.045.020	4,5X55x15MM*	200	51843.045.055	4,5X150x15MM*	100	51843.045.150
4,5X25x15MM*	200	51843.045.025	4,5X60x15MM*	200	51843.045.060			
4,5X30x15MM*	200	51843.045.030	4,5X65x15MM*	200	51843.045.065	5,0X220x15MM*	100	51843.050.220
4,5X35x15MM*	200	51843.045.035	4,5X80x15MM*	200	51843.045.080	5,0X250x15MM*	100	51843.050.250
4,5X40x15MM*	200	51843.045.040	4,5X100x15MM*	100	51843.045.100	5,0X280x15MM*	100	51843.050.280
4,5X45x15MM*	200	51843.045.045	4,5X120x15MM*	100	51843.045.120	5,0X300x15MM*	100	51843.050.300
4,5X50x15MM*	200	51843.045.050						

51845 Woodscrew with washer 20mm Pozidriv R03A

Material Stainless steel A2
Surface treatment Copper plated



d x L x d ₂	☒	Art.number	d x L x d ₂	☒	Art.number	d x L x d ₂	☒	Art.number
4,5X20x20MM*	200	51845.045.020	4,5X45x20MM*	200	51845.045.045	4,5X70x20MM*	100	51845.045.070
4,5X25x20MM*	200	51845.045.025	4,5X50x20MM*	200	51845.045.050	4,5X80x20MM*	100	51845.045.080
4,5X30x20MM*	200	51845.045.030	4,5X55x20MM*	200	51845.045.055	4,5X100x20MM*	100	51845.045.100
4,5X35x20MM*	200	51845.045.035	4,5X60x20MM*	200	51845.045.060	4,5X120x20MM*	100	51845.045.120
4,5X40x20MM*	200	51845.045.040	4,5X65x20MM*	100	51845.045.065			

51847 Woodscrew with washer 25mm Pozidriv R03A

Material Stainless steel A2
Surface treatment Copper plated



d x L x d ₂	☒	Art.number	d x L x d ₂	☒	Art.number	d x L x d ₂	☒	Art.number
4,5X20x25MM*	200	51847.045.020	4,5X35x25MM*	200	51847.045.035	4,5X50x25MM*	200	51847.045.050
4,5X25x25MM*	200	51847.045.025	4,5X40x25MM*	200	51847.045.040	4,5X60x25MM*	200	51847.045.060
4,5X30x25MM*	200	51847.045.030	4,5X45x25MM*	200	51847.045.045	4,5X70x25MM*	200	51847.045.070

6

Woodscrew with washers hexalobular

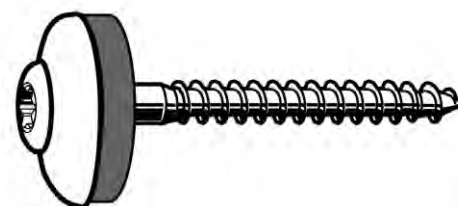
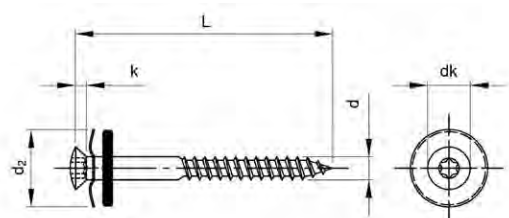

Technical Data

d	d _k	k	Socket
4.5	8.3	2.35	T20
5	9.2	2.5	T20

Article groups

Driving features	Material	Surface treatment	Code	Page
Hexalobular	St.St. A2	ring ø=15mm	51793	6-195
Hexalobular	St.St. A2	ring ø=20mm	51795	6-195
Hexalobular	St.St. A2	ring ø=25mm	51797	6-195
Hexalobular	St.St. A2	Copper plated ring ø=15mm	51850	6-196
Hexalobular	St.St. A2	Copper plated ring ø=20mm	51852	6-196

51793 Woodscrew with washers 15mm hexalobular

R03A

Material Stainless steel A2



d x L x d ₂	☒	Art.number	d x L x d ₂	☒	Art.number	d x L x d ₂	☒	Art.number
4,5X20X15MM*	200	51793.045.020	4,5X55X15MM*	200	51793.045.055	4,5X120X15MM*	100	51793.045.120
4,5X25X15MM*	200	51793.045.025	4,5X60X15MM*	200	51793.045.060	4,5X150X15MM*	100	51793.045.150
4,5X30X15MM*	200	51793.045.030	4,5X65X15MM*	200	51793.045.065			
4,5X35X15MM*	200	51793.045.035	4,5X70X15MM*	200	51793.045.070	5,0X180X15MM*	100	51793.050.180
4,5X40X15MM*	200	51793.045.040	4,5X80X15MM*	200	51793.045.080	5,0X200X15MM*	100	51793.050.200
4,5X45X15MM*	200	51793.045.045	4,5X90X15MM*	200	51793.045.090	5,0X250X15MM*	100	51793.050.250
4,5X50X15MM*	200	51793.045.050	4,5X100X15MM*	100	51793.045.100	5,0X300X15MM*	100	51793.050.300

51795 Woodscrew with washers 20mm hexalobular

R03A

Material Stainless steel A2



d x L x d ₂	☒	Art.number	d x L x d ₂	☒	Art.number	d x L x d ₂	☒	Art.number
4,5X20X20MM*	200	51795.045.020	4,5X40X20MM*	200	51795.045.040	4,5X60X20MM*	200	51795.045.060
4,5X25X20MM*	200	51795.045.025	4,5X45X20MM*	200	51795.045.045	4,5X65X20MM*	100	51795.045.065
4,5X30X20MM*	200	51795.045.030	4,5X50X20MM*	200	51795.045.050	4,5X70X20MM*	100	51795.045.070
4,5X35X20MM*	200	51795.045.035	4,5X55X20MM*	200	51795.045.055	4,5X80X20MM*	100	51795.045.080

51797 Woodscrew with washers 25mm hexalobular

R03A

Material Stainless steel A2



d x L x d ₂	☒	Art.number	d x L x d ₂	☒	Art.number	d x L x d ₂	☒	Art.number
4,5X25X25MM*	200	51797.045.025	4,5X45X25MM*	200	51797.045.045	4,5X55X25MM*	200	51797.045.055
4,5X35X25MM*	200	51797.045.035						

51850 Woodscrew with washers 15mm hexalobular R03A

Material Stainless steel A2
Surface treatment Copper plated



d x L x d ₂	☒	Art.number	d x L x d ₂	☒	Art.number	d x L x d ₂	☒	Art.number
4,5X20X15MM*	200	51850.045.020	4,5X65X15MM*	200	51850.045.065	5,0X180X15MM*	100	51850.050.180
4,5X25X15MM*	200	51850.045.025	4,5X70X15MM*	200	51850.045.070	5,0X200X15MM*	100	51850.050.200
4,5X30X15MM*	200	51850.045.030	4,5X80X15MM*	200	51850.045.080	5,0X220X15MM*	100	51850.050.220
4,5X35X15MM*	200	51850.045.035	4,5X100X15MM*	100	51850.045.100	5,0X250X15MM*	100	51850.050.250
4,5X45X15MM*	200	51850.045.045	4,5X120X15MM*	100	51850.045.120	5,0X280X15MM*	100	51850.050.280
4,5X55X15MM*	200	51850.045.055	4,5X150X15MM*	100	51850.045.150	5,0X300X15MM*	100	51850.050.300
4,5X60X15MM*	200	51850.045.060						

51852 Woodscrew with washers 20mm hexalobular R03A

Material Stainless steel A2
Surface treatment Copper plated



d x L x d ₂	☒	Art.number	d x L x d ₂	☒	Art.number	d x L x d ₂	☒	Art.number
4,5X20X20MM*	200	51852.045.020	4,5X40X20MM*	200	51852.045.040	4,5X60X20MM*	200	51852.045.060
4,5X25X20MM*	200	51852.045.025	4,5X45X20MM*	200	51852.045.045	4,5X70X20MM*	100	51852.045.070
4,5X35X20MM*	200	51852.045.035	4,5X50X20MM*	200	51852.045.050			

6

Woodscrew with washer hexalobular

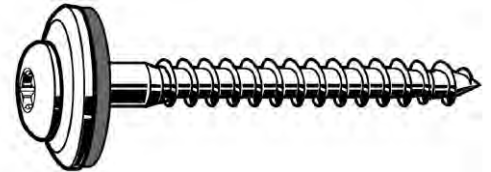
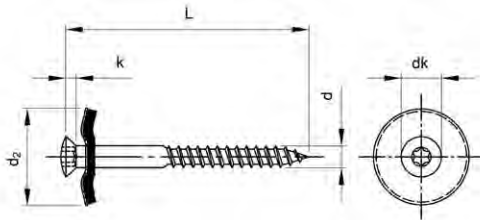

Technical Data

d	d _k	k	Socket
4.5	8.3	2.35	T20
5	9.2	2.5	T20
5.5	8.3	5.1	T20

Article groups

Driving features	Material	Surface treatment	Code	Page
Hexalobular	St.St. A2	ring ø=15mm	51792	6-196
Hexalobular	St.St. A2	ring ø=20mm	51794	6-197
Hexalobular	St.St. A2	ring ø=25mm	51796	6-197
Hexalobular	St.St. A2	Copper plated ring ø=15mm	51849	6-197
Hexalobular	St.St. A2	Copper plated ring ø=20mm	51851	6-197

51792 Woodscrew with washer 15mm hexalobular R03A

Material Stainless steel A2

d x L x d ₂	☒	Art.number	d x L x d ₂	☒	Art.number	d x L x d ₂	☒	Art.number
4,5X20X15MM*	200	51792.045.020	4,5X60X15MM*	200	51792.045.060	5,0X180X15MM*	100	51792.050.180
4,5X25X15MM*	200	51792.045.025	4,5X65X15MM*	200	51792.045.065	5,0X200X15MM*	100	51792.050.200
4,5X30X15MM*	200	51792.045.030	4,5X70X15MM*	200	51792.045.070	5,0X220X15MM*	100	51792.050.220
4,5X35X15MM*	200	51792.045.035	4,5X80X15MM*	200	51792.045.080	5,0X250X15MM*	100	51792.050.250
4,5X40X15MM*	200	51792.045.040	4,5X90X15MM*	200	51792.045.090	5,0X280X15MM*	100	51792.050.280
4,5X45X15MM*	200	51792.045.045	4,5X120X15MM*	100	51792.045.120	5,0X300X15MM*	100	51792.050.300
4,5X50X15MM*	200	51792.045.050	4,5X150X15MM*	100	51792.045.150			
4,5X55X15MM*	200	51792.045.055						

51794 Woodscrew with washer 20mm hexalobular R03A

Material Stainless steel A2



d x L x d ₂	☒	Art.number	d x L x d ₂	☒	Art.number	d x L x d ₂	☒	Art.number
4,5X20X20MM*	200	51794.045.020	4,5X55X20MM*	200	51794.045.055	4,5X150X20MM*	100	51794.045.150
4,5X25X20MM*	200	51794.045.025	4,5X60X20MM*	200	51794.045.060	5,0X180X20MM*	100	51794.050.180
4,5X30X20MM*	200	51794.045.030	4,5X65X20MM*	100	51794.045.065	5,0X200X20MM*	100	51794.050.200
4,5X35X20MM*	200	51794.045.035	4,5X70X20MM*	100	51794.045.070	5,0X220X20MM*	100	51794.050.220
4,5X40X20MM*	200	51794.045.040	4,5X80X20MM*	100	51794.045.080	5,0X250X20MM*	100	51794.050.250
4,5X45X20MM*	200	51794.045.045	4,5X100X20MM*	100	51794.045.100			
4,5X50X20MM*	200	51794.045.050	4,5X120X20MM*	100	51794.045.120			

51796 Woodscrew with washer 25mm hexalobular R03A

Material Stainless steel A2



d x L x d ₂	☒	Art.number	d x L x d ₂	☒	Art.number	d x L x d ₂	☒	Art.number
4,5X20X25MM*	200	51796.045.020	4,5X45X25MM*	200	51796.045.045	4,5X60X25MM*	200	51796.045.060
4,5X25X25MM*	200	51796.045.025	4,5X55X25MM*	200	51796.045.055	4,5X70X25MM*	100	51796.045.070
4,5X35X25MM*	200	51796.045.035						

51849 Woodscrew with washer 15mm hexalobular R03A

Material Stainless steel A2
Surface treatment Copper plated



d x L x d ₂	☒	Art.number	d x L x d ₂	☒	Art.number	d x L x d ₂	☒	Art.number
4,5X20X15MM*	200	51849.045.020	4,5X55X15MM*	200	51849.045.055	4,5X150X15MM*	100	51849.045.150
4,5X25X15MM*	200	51849.045.025	4,5X60X15MM*	200	51849.045.060	5,0X180X15MM*	100	51849.045.180
4,5X30X15MM*	200	51849.045.030	4,5X65X15MM*	200	51849.045.065	5,0X200X15MM*	100	51849.050.200
4,5X35X15MM*	200	51849.045.035	4,5X70X15MM*	200	51849.045.070	5,0X220X15MM*	100	51849.050.220
4,5X40X15MM*	200	51849.045.040	4,5X80X15MM*	200	51849.045.080	5,0X250X15MM*	100	51849.050.250
4,5X45X15MM*	200	51849.045.045	4,5X90X15MM*	200	51849.045.090	5,0X280X15MM*	100	51849.050.280
4,5X50X15MM*	200	51849.045.050	4,5X100X15MM*	100	51849.045.100	5,0X300X15MM*	100	51849.050.300
			4,5X120X15MM*	100	51849.045.120			

51851 Woodscrew with washer 20mm hexalobular R03A

Material Stainless steel A2
Surface treatment Copper plated



d x L x d ₂	☒	Art.number	d x L x d ₂	☒	Art.number	d x L x d ₂	☒	Art.number
4,5X20X20MM*	200	51851.045.020	4,5X55X20MM*	200	51851.045.055	5,0X200X20MM*	100	51851.050.200
4,5X25X20MM*	200	51851.045.025	4,5X60X20MM*	200	51851.045.060	5,0X220X20MM*	100	51851.050.220
4,5X30X20MM*	200	51851.045.030	4,5X65X20MM*	100	51851.045.065	5,0X250X20MM*	100	51851.050.250
4,5X35X20MM*	200	51851.045.035	4,5X70X20MM*	100	51851.045.070	5,0X280X20MM*	100	51851.050.280
4,5X40X20MM*	200	51851.045.040	4,5X80X20MM*	100	51851.045.080	5,0X300X20MM*	100	51851.050.300
4,5X45X20MM*	200	51851.045.045	4,5X100X20MM*	100	51851.045.100			
4,5X50X20MM*	200	51851.045.050	4,5X120X20MM*	100	51851.045.120			

Cross recessed dry wall screw

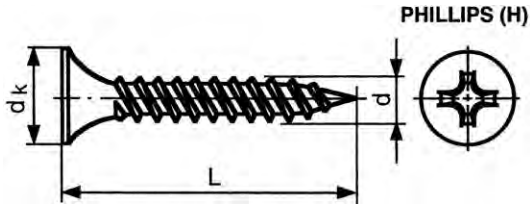

Technical Data

No.	d	d _k	No. cross recess
6	3.5	8.3	2

Special features of dry wall screws:

- suitable for fastening of gypsum plasterboard on framework of every type of wood or metal up to 0,75mm thickness
- the trumpet (bugle) shaped head countersinks in such a way that it can be easily covered and leaving no visible protruding spot

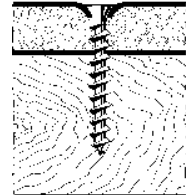

6

31305 Cross recessed dry wall screw with two-start thread (fine) Phillips		J11A
Material	Steel	
Surface treatment	Phosphated	
		 

No. x L	✉	Art.number	No. x L	✉	Art.number	No. x L	✉	Art.number
NO.6X1 Inch	1000	31305.035.025	NO.6X1.5/8	1000	31305.035.041	NO.6X2.1/4	500	31305.035.057

- Quick penetration due to the two-start thread (fine).

Cross recessed dry wall screw



Technical Data

d	dk	No. cross recess
3.5	8.5	2
3.9	8.5	2
4.2	8.5	2
4.8	8.5	2

Special features of dry wall screws:

- suitable for fastening of gypsum plasterboard on framework of every type of wood or metal up to 0,75mm thickness
- the trumpet (bugle) shaped head countersinks in such a way that it can be easily covered and leaving no visible protruding spot

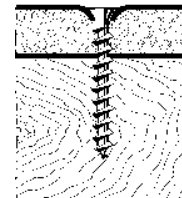

6

31310 Cross recessed dry wall screw with two-start thread (fine) Phillips

J11A

Material Steel
Surface treatment Phosphated



d x L	☒	Art.number	d x L	☒	Art.number	d x L	☒	Art.number
3,5X25MM	1000	31310.035.025	3,9X45MM	1000	31310.039.045	4,2X75MM	1000	31310.042.075
3,5X35MM	1000	31310.035.035	3,9X65MM	1000	31310.039.065	4,8X70MM	250	31310.048.070
3,5X45MM	1000	31310.035.045						
3,5X55MM	500	31310.035.055						

- Quick penetration due to the two-start thread (fine).

Cover for countersunk head screw with hole

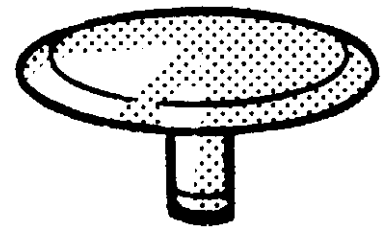
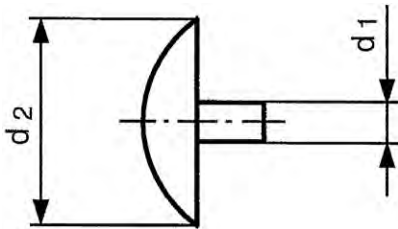

RAL	
1001	Beige
1005	Honey yellow
1011	Brown beige
1014	Ivory
1015	Light ivory
1017	Saffron yellow

RAL	
6009	Fir green
7001	Silver grey
7011	Iron grey
7035	Light grey
7038	Agate grey

RAL	
8001	Ochre brown
8007	Fawn brown
8011	Nut brown
8014	Sepia brown

RAL	
9005	Black
9010	Pure white

Article groups

Material	Class	Color	Code	Page	
Plastic PA	PA 6.6	Assorted	25860	6-200	
Plastic PA	PA 6.6	d2=15mm	Assorted	25862	6-200

6

25860 Cover for countersunk head screw with hole				K90A
Material	Plastic Polyamide (nylon)			
Class	PA 6.6			
Color	Assorted			

d ₁ x d ₂ - RAL	☒	Art.number	d ₁ x d ₂ - RAL	☒	Art.number	d ₁ x d ₂ - RAL	☒	Art.number
2,5x12-1001	200	25860.251.001	2,5x12-7035	200	25860.257.035	3x15-1014	200	25860.301.014
2,5x12-1005	200	25860.251.005	2,5x12-7038	200	25860.257.038	3x15-1017	200	25860.301.017
2,5x12-1011	200	25860.251.011	2,5x12-8001	200	25860.258.001	3x15-8001	200	25860.308.001
2,5x12-1014	200	25860.251.014	2,5x12-8011	200	25860.258.011	3x15-8007	200	25860.308.007
2,5x12-1015	200	25860.251.015	2,5x12-8014	200	25860.258.014	3x15-8011	200	25860.308.011
2,5x12-6009	200	25860.256.009	2,5x12-9005	200	25860.259.005	3x15-9005	200	25860.309.005
2,5x12-7001	200	25860.257.001	2,5x12-9010	200	25860.259.010	3x15-9010	200	25860.309.010
2,5x12-7011	200	25860.257.011	3x15-1011	200	25860.301.011			

25862 Cover for countersunk head screw with hole d2=15mm				K90A
Material	Plastic Polyamide (nylon)			
Class	PA 6.6			
Color	Assorted			

d ₁ x d ₂ - RAL	☒	Art.number	d ₁ x d ₂ - RAL	☒	Art.number	d ₁ x d ₂ - RAL	☒	Art.number
2,5x15-1011	200	25862.251.011	2,5x15-8007	200	25862.258.007	2,5x15-9005	200	25862.259.005
2,5x15-1014	200	25862.251.014	2,5x15-8011	200	25862.258.011	2,5x15-9010	200	25862.259.010

Cover for cross recessed countersunk head screw for chipboard

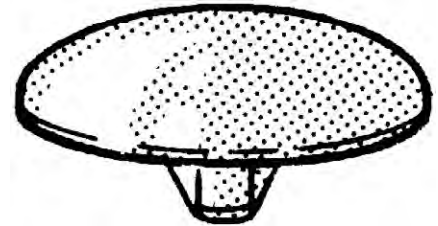
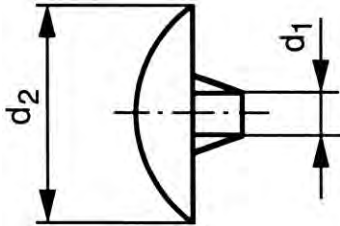

- Special features for covers for cross recessed countersunk head screws for chipboard Pozidriv:
- Prevent corrosion and dirt accumulation in the recess.
- Neat appearance.
- Easy to assemble.
- Re-useable.

RAL	
1011	Brown beige
1014	Ivory
1017	Saffron yellow

RAL	
7001	Silver grey

RAL	
8001	Ochre brown
8007	Fawn brown
8011	Nut brown
8012	Red brown

RAL	
9005	Black
9010	Pure white

29390 Cover for cross recessed countersunk head screw for chipboard Pozidriv

K03D

Material	Plastic Polyamide (nylon)
Class	PA 6.6
Color	Assorted

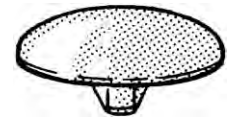

6

$d_1 \times d_2$ - RAL	☒	Art.number	$d_1 \times d_2$ - RAL	☒	Art.number	$d_1 \times d_2$ - RAL	☒	Art.number
2x12-7001	200	29390.001.770	2x12-8007	200	29390.028.007	3x14,5-1014	200	29390.031.014
2x12-1011	200	29390.021.011	2x12-8011	200	29390.028.011	3x14,5-8011	200	29390.038.011
2x12-1014	200	29390.021.014	2x12-8012	200	29390.028.012	3x14,5-9005	200	29390.039.005
2x12-1017	200	29390.021.017	2x12-9005	200	29390.029.005	3x14,5-9010	200	29390.039.010
2x12-8001	200	29390.028.001	2x12-9010	200	29390.029.010			

Cover for hexagon head wood screw

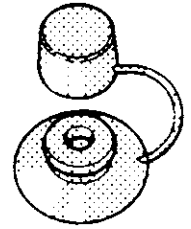

08290	Cover for hexagon head wood screw	E07A
Material	Plastic Polyamide (nylon)	
Class	6	
Color	Assorted	

For nom. size	✉	Art.number	For nom. size	✉	Art.number
6-7MM BLACK	100	08290.070.001	7MM GREY	100	08290.070.011

Snap cap for screw

6

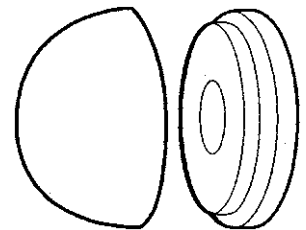
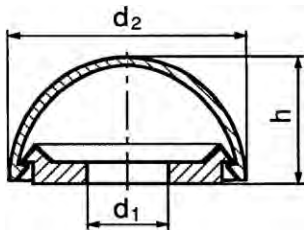

Technical Data

d	d ₁	d ₂	h	d	d ₁	d ₂	h
M4	4.3	12	5.9	M6	6.4	16.8	7.5
M5	5.3	14.5	6.5	M8	8.4	20.8	10.2

Example of application

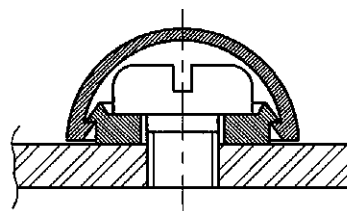

56610	Snap cap for screw	W02A
Material	Plastic Polyamide (nylon)	
Class	PA 6.6	
Color	White	

d	✉	Art.number	d	✉	Art.number	d	✉	Art.number
M4	250	56610.040.001	M6	250	56610.060.001	M8	250	56610.080.001
M5	250	56610.050.001						

Thumb screw

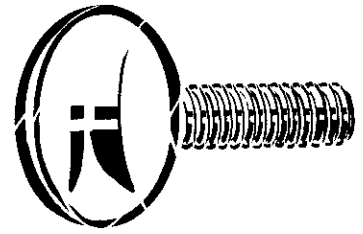
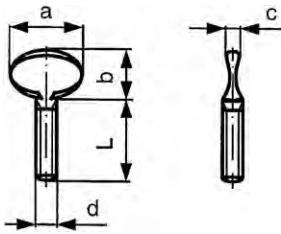

Technical Data

d	a	b	c	P
M5	20.5	15.5	3.5	0.8
M6	23.5	16	4.5	1
M8	27.5	19	4.5	1.25
M10	36	25	6.5	1.5

16295 Thumb screw

F11G

Thread Metric thread
Material Cast iron 35
Surface treatment Zinc plated

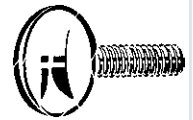

d x L	☒	Art.number	d x L	☒	Art.number	d x L	☒	Art.number
M5X10	200	16295.050.010	M6X20	100	16295.060.020	M8X40	50	16295.080.040
M5X12	200	16295.050.012	M6X25	100	16295.060.025	M8X50	50	16295.080.050
M5X16	200	16295.050.016	M6X30	100	16295.060.030	M10X20	50	16295.100.020
M5X20	200	16295.050.020	M8X16	100	16295.080.016	M10X25	50	16295.100.025
M6X10	200	16295.060.010	M8X20	100	16295.080.020	M10X30	50	16295.100.030
M6X12	200	16295.060.012	M8X25	100	16295.080.025	M10X40	50	16295.100.040
M6X16	100	16295.060.016	M8X30	100	16295.080.030	M10X50	20	16295.100.050

• L = useable thread length.

Knurled thumb screw high type

DIN 464

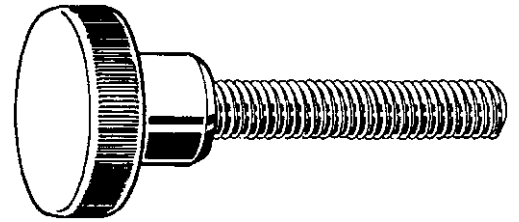
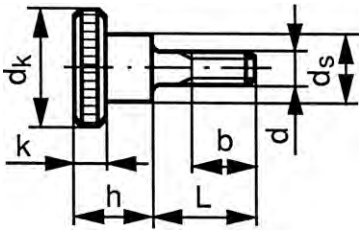

Technical Data

d	b	d _k	d _s	Full thread L ≤	h	k	P
M3	9	12	6	12	7.5	2.5	0.5
M4	12	16	8	16	9.5	3.5	0.7
M5	15	20	10	16	11.5	4	0.8
M6	18	24	12	20	15	5	1
M8	24	30	16	25	18	6	1.25
M10	30	36	20	30	23	8	1.5

Article groups

Thread	Material	Surface treatment	Code	Page
M	Free-cutting steel	Zipl	16650	6-204
M	St.St. A1		51829	6-204
M	Br Cu3		47480	6-205

6

16650 Knurled thumb screw high type

F11G

Thread Metric thread
Material Free-cutting steel
Surface treatment Zinc plated

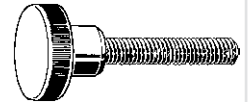

d x L	☒	Art.number	d x L	☒	Art.number	d x L	☒	Art.number
M3X6	100	16650.030.006	M5X6	50	16650.050.006	M6X40	25	16650.060.040
M3X8	100	16650.030.008	M5X8	50	16650.050.008	M6X50	25	16650.060.050
M3X10	100	16650.030.010	M5X10	50	16650.050.010	M8X10	25	16650.080.010
M3X12	100	16650.030.012	M5X12	50	16650.050.012	M8X12	25	16650.080.012
M3X16	100	16650.030.016	M5X16	50	16650.050.016	M8X16	25	16650.080.016
M3X20	100	16650.030.020	M5X20	50	16650.050.020	M8X20	25	16650.080.020
M3X25	100	16650.030.025	M5X25	50	16650.050.025	M8X25	25	16650.080.025
M3X30	100	16650.030.030	M5X30	50	16650.050.030	M8X30	25	16650.080.030
M4X6	50	16650.040.006	M5X40	50	16650.050.040	M8X40	25	16650.080.040
M4X8	50	16650.040.008	M6X8	25	16650.060.008	M8X50	25	16650.080.050
M4X10	50	16650.040.010	M6X10	25	16650.060.010	M10X16	10	16650.100.016
M4X12	50	16650.040.012	M6X12	25	16650.060.012	M10X20	10	16650.100.020
M4X16	50	16650.040.016	M6X16	25	16650.060.016	M10X25	10	16650.100.025
M4X20	50	16650.040.020	M6X20	25	16650.060.020	M10X30	10	16650.100.030
M4X25	50	16650.040.025	M6X25	25	16650.060.025	M10X40	10	16650.100.040
M4X30	50	16650.040.030	M6X30	25	16650.060.030	M10X50	10	16650.100.050
M4X40	50	16650.040.040						

51829 Knurled thumb screw high type

R09A

Thread Metric thread
Material Stainless steel A1

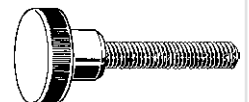

d x L	☒	Art.number	d x L	☒	Art.number	d x L	☒	Art.number
M3X4*	50	51829.030.004	M4X8*	50	51829.040.008	M5X16*	25	51829.050.016
M3X5*	50	51829.030.005	M4X10*	50	51829.040.010	M5X18*	25	51829.050.018
M3X6*	50	51829.030.006	M4X12*	50	51829.040.012	M5X20*	25	51829.050.020
M3X8*	50	51829.030.008	M4X16*	50	51829.040.016	M6X8*	25	51829.060.008
M3X10*	50	51829.030.010	M4X20*	50	51829.040.020	M6X10*	25	51829.060.010
M3X12*	50	51829.030.012	M4X25*	50	51829.040.025	M6X12*	25	51829.060.012
M3X16*	50	51829.030.016	M5X6*	25	51829.050.006	M6X16*	25	51829.060.016
M3X20*	50	51829.030.020	M5X8*	25	51829.050.008	M6X20*	25	51829.060.020
M4X5*	50	51829.040.005	M5X10*	25	51829.050.010	M6X25*	25	51829.060.025
M4X6*	50	51829.040.006	M5X12*	25	51829.050.012			

51829 Knurled thumb screw high type ←

d x L	☒	Art.number	d x L	☒	Art.number
M8X12*	25	51829.080.012	M8X20*	25	51829.080.020
M8X16*	25	51829.080.016	M8X25*	25	51829.080.025

47480 Knurled thumb screw high type M11D

Thread	Metric thread
Material	Brass Cu3

d x L	☒	Art.number	d x L	☒	Art.number	d x L	☒	Art.number
M3X6	100	47480.030.006	M5X8	50	47480.050.008	M6X16	25	47480.060.016
M3X8	100	47480.030.008	M5X10	50	47480.050.010	M6X20	25	47480.060.020
M3X10	100	47480.030.010	M5X12	50	47480.050.012	M6X25	25	47480.060.025
M3X12	100	47480.030.012	M5X16	50	47480.050.016	M6X30	25	47480.060.030
M3X16	100	47480.030.016	M5X20	50	47480.050.020	M6X40	25	47480.060.040
M3X20	100	47480.030.020	M5X25	50	47480.050.025	M8X12	25	47480.080.012
M4X8	50	47480.040.008	M5X30	50	47480.050.030	M8X16	25	47480.080.016
M4X10	50	47480.040.010	M6X8	25	47480.060.008	M8X20	25	47480.080.020
M4X12	50	47480.040.012	M6X10	25	47480.060.010	M8X25	25	47480.080.025
M4X16	50	47480.040.016	M6X12	25	47480.060.012	M8X30	25	47480.080.030
M4X20	50	47480.040.020				M8X40	25	47480.080.040
M4X30	50	47480.040.030						

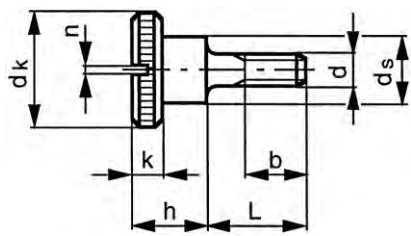
Slotted knurled thumb screw high type

DIN 464 Sz

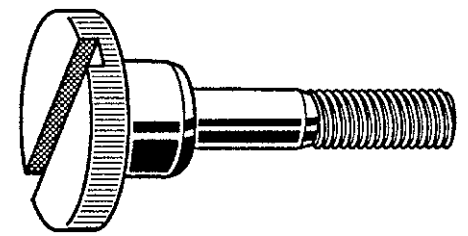
Technical Data

d	b	dk	ds	Full thread L ≤	h	k	n	P
M3	9	12	6	10	7.5	2.5	0.8	0.5
M4	12	16	8	16	9.5	3.5	1	0.7
M5	15	20	10	16	11.5	4	1.2	0.8
M6	18	24	12	20	15	5	1.6	1

51828 Slotted knurled thumb screw high type R09A

Thread	Metric thread
Material	Stainless steel A1

d x L	☒	Art.number	d x L	☒	Art.number	d x L	☒	Art.number
M3X6	50	51828.030.006	M4X12	25	51828.040.012	M5X40	25	51828.050.040
M3X8	50	51828.030.008	M4X16	25	51828.040.016	M6X10	10	51828.060.010
M3X10	50	51828.030.010	M4X20	25	51828.040.020	M6X12	10	51828.060.012
M3X12*	50	51828.030.012	M4X30	25	51828.040.030	M6X16	10	51828.060.016
M3X16*	50	51828.030.016	M5X10	25	51828.050.010	M6X20	10	51828.060.020
M4X6*	50	51828.040.006	M5X12	25	51828.050.012	M6X25	10	51828.060.025
M4X8	25	51828.040.008	M5X16	25	51828.050.016	M6X30	10	51828.060.030
M4X10	25	51828.040.010	M5X20	25	51828.050.020			

Knurled thumb screw thin type

DIN 653

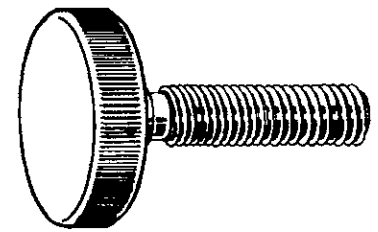
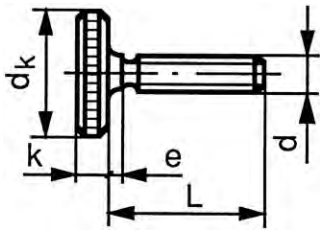

Technical Data

d	d _k	e	Full thread L ≤	k	P
M3	12	2	10	2.5	0.5
M4	16	3	16	3.5	0.7
M5	20	3	16	4	0.8
M6	24	4	16	5	1
M8	30	5	20	6	1.25
M10	36	6	25	8	1.5

Article groups

Thread	Material	Surface treatment	Code	Page
M	Free-cutting steel	Zipl	16660	6-206
M	St.St. A1		51503	6-206
M	Br Cu3		47490	6-207

6

16660 Knurled thumb screw thin type F11G

Thread Metric thread
Material Free-cutting steel
Surface treatment Zinc plated

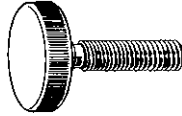
d x L	Art.number	d x L	Art.number	d x L	Art.number
M3X6	100 16660.030.006	M5X8	50 16660.050.008	M6X40	25 16660.060.040
M3X8	100 16660.030.008	M5X10	50 16660.050.010	M6X50	25 16660.060.050
M3X10	100 16660.030.010	M5X12	50 16660.050.012	M8X12	25 16660.080.012
M3X12	100 16660.030.012	M5X16	50 16660.050.016	M8X16	25 16660.080.016
M3X16	100 16660.030.016	M5X20	50 16660.050.020	M8X20	25 16660.080.020
M3X20	100 16660.030.020	M5X25	50 16660.050.025	M8X25	25 16660.080.025
M3X25	100 16660.030.025	M5X30	50 16660.050.030	M8X30	25 16660.080.030
M4X6	50 16660.040.006	M5X40	50 16660.050.040	M8X40	25 16660.080.040
M4X8	50 16660.040.008	M6X10	25 16660.060.010	M8X50	25 16660.080.050
M4X10	50 16660.040.010	M6X12	25 16660.060.012	M10X20	10 16660.100.020
M4X12	50 16660.040.012	M6X16	25 16660.060.016	M10X25	10 16660.100.025
M4X16	50 16660.040.016	M6X20	25 16660.060.020	M10X30	10 16660.100.030
M4X20	50 16660.040.020	M6X25	25 16660.060.025	M10X40	10 16660.100.040
M4X25	50 16660.040.025	M6X30	25 16660.060.030	M10X50	10 16660.100.050
M4X30	50 16660.040.030				

51503 Knurled thumb screw thin type R09A

Thread Metric thread
Material Stainless steel A1



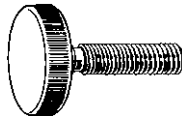

d x L	Art.number	d x L	Art.number	d x L	Art.number
M3X10*	50 51503.030.010	M5X10*	25 51503.050.010	M6X20*	25 51503.060.020
M3X12*	50 51503.030.012	M5X12*	25 51503.050.012	M6X25*	25 51503.060.025
M3X16*	50 51503.030.016	M5X16*	25 51503.050.016	M6X30*	25 51503.060.030
M4X8*	50 51503.040.008	M5X20*	25 51503.050.020	M8X12*	25 51503.080.012
M4X10*	50 51503.040.010	M6X10*	25 51503.060.010	M8X16*	25 51503.080.016
M4X12*	50 51503.040.012	M6X12*	25 51503.060.012	M8X20*	25 51503.080.020
M4X16*	50 51503.040.016	M6X16*	25 51503.060.016	M8X25*	25 51503.080.025
M4X20*	50 51503.040.020			M8X30*	25 51503.080.030
M4X25*	50 51503.040.025				

47490	Knurled thumb screw thin type		M11D
Thread	Metric thread		
Material	Brass Cu3		
			

d x L	☒	Art.number	d x L	☒	Art.number	d x L	☒	Art.number
M3X6	100	47490.030.006	M4X25	50	47490.040.025	M6X12	25	47490.060.012
M3X8	100	47490.030.008				M6X16	25	47490.060.016
M3X10	100	47490.030.010	M5X8	50	47490.050.008	M6X20	25	47490.060.020
M3X12	100	47490.030.012	M5X10	50	47490.050.010	M6X25	25	47490.060.025
M3X16	100	47490.030.016	M5X12	50	47490.050.012	M6X30	25	47490.060.030
M3X20	100	47490.030.020	M5X16	50	47490.050.016			
M4X8	50	47490.040.008	M5X20	50	47490.050.020	M8X16	25	47490.080.016
M4X10	50	47490.040.010	M5X25	50	47490.050.025	M8X20	25	47490.080.020
M4X12	50	47490.040.012	M5X30	50	47490.050.030	M8X25	25	47490.080.025
M4X16	50	47490.040.016	M6X10	25	47490.060.010	M8X30	25	47490.080.030
M4X20	50	47490.040.020				M8X40	25	47490.080.040

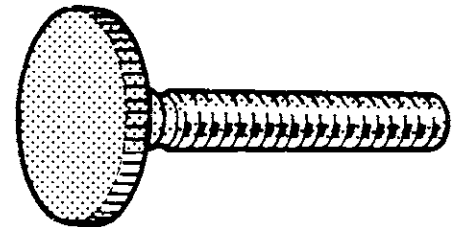
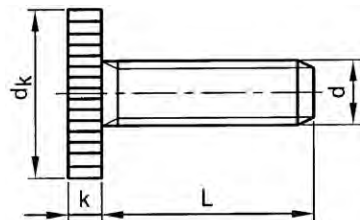
Knurled thumb screw



6

Technical Data			
d	d _k	k	P
M5	16	3.4	0.8
M6	16	3.4	1
M8	16	3.4	1.25

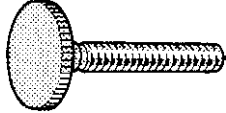
56230	Knurled thumb screw plastic		W02A
Thread	Metric thread		
Material	Plastic		
Class	PA 6.6		
Color	White		

d x L	☒	Art.number	d x L	☒	Art.number	d x L	☒	Art.number
M5X30	100	56230.050.030	M6X16	50	56230.060.016	M8X16	25	56230.080.016
			M6X20	50	56230.060.020	M8X20	25	56230.080.020
M6X8	100	56230.060.008	M6X25	50	56230.060.025	M8X25	25	56230.080.025
M6X10	50	56230.060.010	M6X30	50	56230.060.030			

Wing screw light (American) type

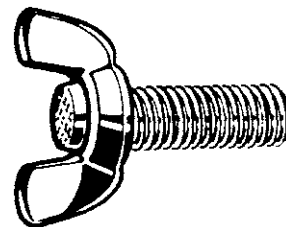
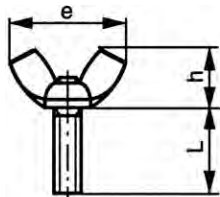

Technical Data

d	e ≈	h ≈	P	d	e ≈	h ≈	P
M3	18.5	8.8	0.5	M8	30.3	14.8	1.25
M4	22	10.5	0.7	M10	35.3	17.3	1.5
M5	22	10.5	0.8	M12	47.4	22.3	1.75
M6	26.8	12.9	1				

Article groups

Thread	Driving features	Material	Code	Page
M	Wing	St.St. A2	51820	6-208
M	Wing	St.St. A4	55820	6-208

6

51820 Wing screw light (American) type		R09A
Thread	Metric thread	
Material	Stainless steel A2	
		
		

d x L	☒	Art.number	d x L	☒	Art.number	d x L	☒	Art.number
M3X10*	100	51820.030.010	M5X40*	50	51820.050.040	M8X45*	50	51820.080.045
M3X12*	100	51820.030.012	M5X45*	50	51820.050.045	M8X50*	50	51820.080.050
M3X16*	100	51820.030.016	M5X50*	50	51820.050.050	M8X60*	50	51820.080.060
M3X20*	100	51820.030.020						
M3X25*	100	51820.030.025	M6X10	25	51820.060.010	M10X16*	25	51820.100.016
			M6X12*	50	51820.060.012	M10X20	10	51820.100.020
M4X10*	100	51820.040.010	M6X15/16	25	51820.060.015	M10X25	10	51820.100.025
M4X12*	100	51820.040.012	M6X16	25	51820.060.016	M10X30	10	51820.100.030
M4X16	25	51820.040.016	M6X20	25	51820.060.020	M10X35*	25	51820.100.035
M4X20*	100	51820.040.020	M6X25	25	51820.060.025	M10X40	10	51820.100.040
M4X25*	100	51820.040.025	M6X30	25	51820.060.030	M10X50	10	51820.100.050
M4X30*	100	51820.040.030	M6X35*	50	51820.060.035	M10X60*	25	51820.100.060
M4X35*	100	51820.040.035	M6X40	25	51820.060.040			
M4X40*	100	51820.040.040	M6X45*	50	51820.060.045	M12X20*	25	51820.120.020
			M6X50*	50	51820.060.050	M12X25*	25	51820.120.025
M5X10	25	51820.050.010				M12X30*	25	51820.120.030
M5X12*	50	51820.050.012	M8X15/16	10	51820.080.015	M12X35*	25	51820.120.035
M5X15/16	25	51820.050.015	M8X20	10	51820.080.020	M12X40*	25	51820.120.040
M5X20	25	51820.050.020	M8X25	10	51820.080.025	M12X50*	25	51820.120.050
M5X25	25	51820.050.025	M8X30	10	51820.080.030	M12X60*	25	51820.120.060
M5X30	25	51820.050.030	M8X35*	50	51820.080.035			
M5X35*	50	51820.050.035	M8X40	10	51820.080.040			

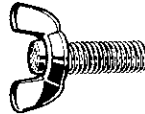
55820 Wing screw light (American) type		R49A
Thread	Metric thread	
Material	Stainless steel A4	
		
		

d x L	☒	Art.number	d x L	☒	Art.number	d x L	☒	Art.number
M3X12*	100	55820.030.012	M5X15/16	25	55820.050.015	M6X30	25	55820.060.030
M3X16*	100	55820.030.016	M5X20*	50	55820.050.020	M6X40	25	55820.060.040
M3X30*	100	55820.030.030	M5X25*	50	55820.050.025			
			M5X30*	50	55820.050.030	M8X15/16	10	55820.080.015
M4X10*	100	55820.040.010				M8X20	10	55820.080.020
M4X12*	100	55820.040.012	M6X10	25	55820.060.010	M8X25	10	55820.080.025
M4X16*	100	55820.040.016	M6X12*	50	55820.060.012	M8X30	10	55820.080.030
M4X20*	100	55820.040.020	M6X15/16	25	55820.060.015	M8X35*	50	55820.080.035
			M6X20	25	55820.060.020	M8X40	10	55820.080.040
M5X10	25	55820.050.010	M6X25	25	55820.060.025	M8X45*	50	55820.080.045
M5X12*	50	55820.050.012						

55820 Wing screw light (American) type								
d x L	☒	Art.number	d x L	☒	Art.number	d x L	☒	Art.number
M8X50*	50	55820.080.050	M10X25	10	55820.100.025			
M8X55*	50	55820.080.055	M10X30	10	55820.100.030	M12X20*	25	55820.120.020
			M10X40	10	55820.100.040	M12X25*	25	55820.120.025
M10X20	10	55820.100.020	M10X45*	25	55820.100.045	M12X30*	25	55820.120.030

Wing screw rounded wings

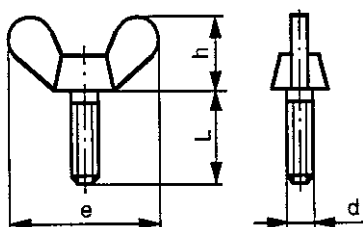

DIN 316
NEN 1624

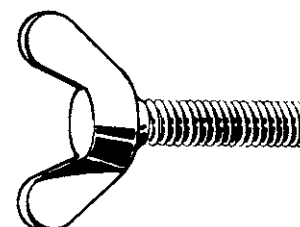

Technical Data

d	e (max.)	h (max.)	P	d	e (max.)	h (max.)	P
M4	20	10.5	0.7	M10	51	25	1.5
M5	26	13	0.8	M12	65	33.5	1.75
M6	33	17	1	M16	73	37.5	2
M8	39	20	1.25				

Article groups

Thread	Driving features	Material	Surface treatment	Code	Page
M	Wing	Cl	Zipl	16210	6-209
M	Wing	St.St. A2		51812	6-209
M	Wing	Br		47530	6-210

6

16210 Wing screw rounded wings			F11G
Thread	Metric thread		
Material	Cast iron		
Surface treatment	Zinc plated		

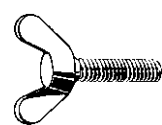

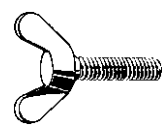

d x L	☒	Art.number	d x L	☒	Art.number	d x L	☒	Art.number
M4X10	200	16210.040.010	M6X30	100	16210.060.030	M10X60	20	16210.100.060
M4X16	200	16210.040.016	M6X40	100	16210.060.040	M10X70	20	16210.100.070
M4X20	200	16210.040.020	M6X50	100	16210.060.050	M10X80	20	16210.100.080
M4X25	200	16210.040.025						
			M8X12	100	16210.080.012	M12X20	20	16210.120.020
M5X10	200	16210.050.010	M8X16	100	16210.080.016	M12X25	20	16210.120.025
M5X16	200	16210.050.016	M8X20	100	16210.080.020	M12X30	20	16210.120.030
M5X20	200	16210.050.020	M8X25	100	16210.080.025	M12X40	20	16210.120.040
M5X25	200	16210.050.025	M8X30	100	16210.080.030	M12X50	20	16210.120.050
M5X30	100	16210.050.030	M8X40	50	16210.080.040	M12X60	20	16210.120.060
M5X35	100	16210.050.035	M8X50	50	16210.080.050	M12X70	20	16210.120.070
M5X40	100	16210.050.040	M8X60	50	16210.080.060	M12X80	20	16210.120.080
M5X50	100	16210.050.050						
			M10X16	50	16210.100.016	M16X30	10	16210.160.030
M6X10	200	16210.060.010	M10X20	50	16210.100.020	M16X40	10	16210.160.040
M6X12	100	16210.060.012	M10X25	50	16210.100.025	M16X50	10	16210.160.050
M6X16	100	16210.060.016	M10X30	50	16210.100.030	M16X60	10	16210.160.060
M6X20	100	16210.060.020	M10X40	50	16210.100.040			
M6X25	100	16210.060.025	M10X50	20	16210.100.050			

51812 Wing screw rounded wings			Q01A
Thread	Metric thread		
Material	Stainless steel A2		

d x L	☒	Art.number	d x L	☒	Art.number	d x L	☒	Art.number
M6X25*	50	51812.060.025	M8X30*	25	51812.080.030	M10X30*	25	51812.100.030
M6X30*	50	51812.060.030				M10X50*	25	51812.100.050
			M10X25*	25	51812.100.025			

47530	Wing screw rounded wings	M11D
Thread	Metric thread	
Material	Brass	
		

d x L	☒	Art.number	d x L	☒	Art.number	d x L	☒	Art.number
M5X12	100	47530.050.012	M6X25	100	47530.060.025	M8X30	25	47530.080.030
M5X16	100	47530.050.016	M6X30	100	47530.060.030	M8X40	25	47530.080.040
M5X20	100	47530.050.020	M6X40	100	47530.060.040	M8X50	25	47530.080.050
M5X25	100	47530.050.025						
M5X30	100	47530.050.030	M8X10	50	47530.080.010	M10X20	50	47530.100.020
			M8X12	50	47530.080.012	M10X25	50	47530.100.025
M6X10	100	47530.060.010	M8X16	50	47530.080.016	M10X30	25	47530.100.030
M6X12	100	47530.060.012	M8X20	50	47530.080.020	M10X40	25	47530.100.040
M6X16	100	47530.060.016	M8X25	50	47530.080.025	M10X50	25	47530.100.050
M6X20	100	47530.060.020						

The satisfaction of successfully completing your projects, that's what it's all about! Delivering flawless work requires know-how and the right, top quality materials. Because only the very best is good enough for experienced professionals. You expect quality because you deliver quality!

MaxxFast is a high quality no-nonsense brand in the hardware market. MaxxFast offers a wide range of fasteners, tools and industrial supplies. No matter what product you choose, quality is guaranteed. And it comes at a competitive price! MaxxFast gives you everything you need for the trouble-free completion of your project, so you can start with confidence on your next challenge.

Even though quality always comes first, a good price is just as important to achieve success. MaxxFast works closely with solid partners and aims for a streamlined production process with large-scale production to keep costs down. The bottom line is that this means a competitive retail price. That's good business for you and for your customers. Success guaranteed!

- Top quality
- A wide range of products
- Quality at a competitive price

**JOB DONE,
ON TO THE
NEXT**



Revolutionary woodscrews



High performance self drilling screws



A great range of quality anchors



Proven quality chemical anchors



Leading hose clamps



New cable ties



Screw bits the right fit



Holesaws the sharp edge



Quality assortments

www.maxxfast.com

MAXXFAST
PROFESSIONAL HARDWARE

Professionals build on innovation.



As a world-wide leading expert in nylon fixings, steel anchors and chemical fixings we are your reliable partner with our innovative products.

fischer  [®]
innovative solutions

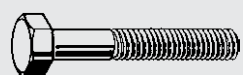

1 Bolts



2 Hexagon socket products



3 Nuts, rivet nuts & inserts



4 Threaded rods & studbolts



5 Hook & eye products



6 Screws

I Index



7 Washers & O-rings



8 Anchoring products



9 Rivets, pins & keys



10 Systems, furniture & security fasteners

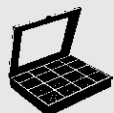

11 Assortments & storage systems

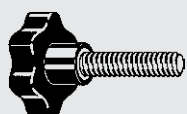

12 Engineering parts & machine parts

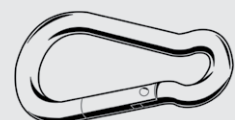

13 Maritime products

T Fastening technology

Alphabetical Index

A					
ABA	clip	clamp	12-21		
			with rubber	12-20	
	flexible	socket	screwdriver	12-23	
	hose	clamp		12-7/12-11, 12-18	
			assortment	12-22	
			micro	12-16	
			mini	12-13	
			robust	12-14, 12-15	
	one	ear	clip	12-16	
	two	ear	clip	12-17	
	Adapter	carrier	Amecoil	3-158	
	Adjustable	clamping joint		12-53	
fixing		Fischer	8-43		
screw		Fischer	8-42		
tail clamp		Lindapter	10-29		
Adjusting	clamp	ring	7-132/7-133		
	ring		7-134/7-136		
Aircrete	anchor	plug	Fischer 8-21		
Amecoil	carrier	adapter	3-158		
	extractor		3-159		
insert	wire thread	metric	3-146		
		metric extra fine	3-147		
		metric extra fine for spark	3-148		
		plugs			
		metric fine	3-147		
		metric self locking	3-146		
		UNC	3-148		
		UNF	3-149		
		machine	tap	metric fine for wire thread	3-144
				insert	
				metric for wire thread	3-143
				insert	
		UNC for wire	3-145		
		thread insert			
		UNF for wire	3-145		
		thread insert			
multidimensional	manual fitting tool	metric	3-154		
		metric complete	3-155, 3-156		
		metric with nozzle	3-155		
nozzle	mandrel	metric	3-156/3-158		
repair	kit		3-153		
staged	tap	metric fine for wire thread	3-144		
		insert			
tang	break		3-159		
workshop	kit	BSW	3-152		
		metric	3-149		
		metric extra fine	3-150, 3-151		
		metric fine	3-150		
		UNC	3-151		
		UNF	3-152		
AMF	counter	catch	for toggle clamp 12-162		
	hook	toggle	clamp 12-159		
			horizontal clamp 12-160		
			vertical clamp 12-161		
	horizontal	toggle	clamp 12-153/12-155		
	push-pull	toggle	clamp 12-156/12-158		
vertical	toggle	clamp 12-151/12-152			
Anchor	accessories	MaxxFast	8-88		
	aircrete	plug	Fischer 8-21		
	bolt	Fischer	8-74, 8-78		
	tool	Fischer	8-78		
chemical	capsule	Fischer	8-84		
		Spit	8-85		
		internal	Fischer 8-90		
	threaded				
expansion	metric brass	Fischer	8-48		
	cone				
	shield	Rawlplug	8-45, 8-47, 8-48		
Fischer			8-22, 8-23, 8-49		
frame	MaxxFast		8-33, 8-34		
hammer-in	Spit		8-26		
hammerset	Fischer		8-54		
	MaxxFast		8-52, 8-53		
high performance	metric	Fischer	8-75, 8-77		
		MaxxFast	8-72		
hollow	Fischer		8-56		
ceiling					
hook	metric with 100mm hook		8-93, 8-94		
		metric with 50mm hook	8-93		
injection	accessories	Fischer	8-89		
rod	metric		8-82		
self drilling	for plasterboard		8-19		
sleeve	Fischer		8-50		
through bolt	Fischer		8-68/8-70		
		MaxxFast	8-66, 8-67		
		Spit	8-71		
Anchoring screw	concrete	countersunk	Powers 8-64		
		hexagon	Powers 8-61		
		mushroom	Powers 8-63		
		head			
		round head	Powers 8-63		
		counter-sunk	Powers 8-57, 8-60		
	hexagon	slotted	Powers	8-59	
			round head	Powers 8-58	
			concrete	hexagon Powers 8-62	
	Anchoring screw A4				
	Angle	bracket	Fischer	10-45	
		installation	bracket	Fischer 10-44	
Arm	cantilever	console	Fischer 10-40		
Assortment	accessories		11-24		
		cabinet drawers	11-23		
		S-box	11-24		
	blind rivet	nut		3-141	
	box	plastic		11-3	
			steel	11-14, 11-22	
			wall plug	Fischer 8-8	
	hose	clamp	ABA	12-22	
			MaxxFast	12-21	
	locking	cable	tie	12-124	
	metric	V-Coil		3-163, 3-164	
	non-metric	V-Coil		3-164, 3-165	
T-bolt	for T-Slot		10-12, 10-13		
Awab	exhaust	clamp	12-24		
	pipe				
Awning	hook		13-121		
B					
Back	panel	screw	cross recessed head 6-107, 6-139		
Ball	joint	metric/mf inside left hand thread	12-47, 12-48		
		metric/mf inside right hand thread	12-47		

Ball	knob	conical hole	12-77	
		metric	12-76	
	stud		10-76	
		technical	12-111/12-114	
Banding	perforated	steel Fischer	10-51	
Band-It	clamping system		12-26/12-28	
Bar	connector	Vemo	8-97	
Bar guide	locking		10-73	
Beam	clamp	Fischer	10-47	
	clip		10-56, 10-58	
Beam clip	combination		10-56, 10-57	
	universal		10-55	
Bearing	slide		12-146	
	spherical	plain external thread	12-52	
		left hand	12-52	
	plain internal thread		12-51	
		left hand	12-51	
Binder	screw	metric	10-104	
Blanking	plug		12-116	
Blind	expanding	rivet with yellow cap	9-69	
	Blind rivet	countersunk	9-63/9-68, 9-73, 9-77	
domed		9-56/9-60, 9-69, 9-70		
expanding		9-79		
mushroom head		9-65/9-67, 9-71/9-76		
nut	expanding		9-78	
	extra large domed head		9-72	
	large domed head		9-61, 9-62	
	assortment		3-141	
	countersunk		3-131/3-133, 3-138	
	cylindrical		3-128/3-130, 3-137	
	reduced countersunk		3-134, 3-135	
hexagon shank		3-135, 3-136		
tool			3-140	
	screw	cylindrical	3-139	
			9-81	
hand pliers			9-80	
	pneumatic		9-80	
			9-80	
Boat	door	holder	13-128	
Bolt	anchor	Fischer	8-74, 8-78	
		tool Fischer	8-78	
	carriage	metric		1-72/1-75
		short square		1-80
		metric with hexagon nut		1-75, 1-76
		UNC		1-77/1-79
	connector	Fischer		10-53
	eye	metric		5-4, 5-5
		metric fully threaded		5-6
	hexagon	BSF		1-59
BSW			1-58	
ISO metric			1-8	
metric			1-3/1-17	
metric fine			1-36/1-38	
metric for pressure vessels			1-12	
metric oversized			1-9	
metric with hexagon nut			1-18	
UNC			1-41/1-50	
UNF			1-52/1-57	
lifting eye	BSW		5-9	
	metric		5-8, 5-9	
locking	metric fine		12-61	
	metric fine with locking groove		12-60	
	metric fine without locking groove		12-60	

masonry	metric		8-91, 8-92	
metric for T-slot			10-4	
roofing and cladding	self drilling	with elastomer sealing	6-115	
		with elastomer sealing	6-112	
		SFS-Topform	6-111	
	with elasto-	SFS-Topform	6-112	
	mer sealing			
	without			
	point			
square head	metric with short dog point		1-84	
	UNC	short dog point	1-85	
stud	welding		10-128	
t-head	Fischer		10-41, 10-44	
	metric		5-3	
	square ends		5-2	
trackshoe	Caterpillar		1-87	
Bolt with flange	hexagon	metric	1-66/1-69	
		self locking	1-64, 1-65	
		Ripp	1-62, 1-63	
		metric fine	1-70	
		metric serrated	1-69	
	Bonded seal ring			7-150
	with rubber		6-117, 7-150	
Book	nut		10-101	
	screw		10-102, 10-103	
		elongation piece		10-103
Bow	nut		3-107	
	shackle		13-9	
		with screw collar pin	5-22, 5-23	
Box	assortment	plastic	11-3	
		steel	11-14, 11-22	
		wall plug Fischer	8-8	
	carrying	Fischer	11-26	
Bracket			13-122, 13-123	
	angle	Fischer	10-45	
	installation	angle Fischer	10-44	
	spring		10-82	
	wall		13-79	
Break	tang	Amecoil	3-159	
Bridge	handle		12-90, 12-91	
		metric	12-91	
		metric brass threaded bush		12-90
Bright	key	parallel	9-50	
BSF	hexagon	bolt	1-59	
		nut	3-28	
		non metallic self locking insert		3-63
		screw		1-61
BSW	cheese	screw hexagon socket	2-32	
	head	screw	hexagon socket	2-50
			counter-sunk	hexagon socket
			slotted	6-27
	domed	nut	high	3-99
	hexagon	bolt		1-58
		nut		3-27, 3-28, 3-30
			non metallic self locking insert	3-63
		screw		1-60

Alphabetical Index

BSW	lifting eye bolt	5-9	
	set screw cup point hexagon socket	2-90	
	studbolt	4-33	
	threaded rod	4-20	
	wing nut	3-106	
	workshop kit Amecoil	3-152	
Buffer	protective	12-143	
Bumper	self adhesive	12-142	
Buoy hook		13-16	
Bush		12-73	
	insulating	12-146, 12-147	
	Vemo	8-97	
Button	lubricating G nipple	12-46	
		metric fine 12-44	
Button head	nut metric hexagon socket	10-94	
	screw	metric double slotted	6-55, 6-56
		metric double slotted and hexagon nut	6-56
		metric hexagon socket	2-51/2-53, 10-95
		metric hexalobular	2-54, 2-55
		metric slotted	6-32, 6-33
		UNC hexagon socket	2-56, 2-57
		UNF hexagon socket	2-58, 2-59
	screw with flange	metric hexagon socket	2-59/2-61
		metric hexalobular	2-62
security screw	metric hexagon socket with pin	10-110	
	metric hexagon socket with plug	10-111	
	metric hexalobular with pin	10-112	
	self tapping	10-117, 10-118	

C

Cabinet drawers	assortment accessories	11-23	
Cable	driller tie	12-134	
	hand pliers tie MaxxFast	12-129	
	locking tie		12-121, 12-131
		assortment	12-124
		MaxxFast	12-120/12-122
		mount	12-128
			MaxxFast 12-128
		releasable MaxxFast	12-126
		self adhesive	12-132, 12-133
		Ty-Rap	12-123
		with eye	12-124
		with label	12-125, 12-126
	with mount releasable	12-127	
	run clip	10-59	
Cage	nut metric	3-119	
Cantilever	arm console Fischer	10-40	
Cap	cover	6-110	
		Fischer 10-41	
		for cross recessed head screw for chipboard 6-201	
		for cross recessed head screws with hole 6-200	
		for hexagon head wood screw 6-202	
		for window Fischer 8-41	
		frame screw	
	hammer-in square GMT	12-69	
	protective for hexagon bolt, screw and nut	1-98, 1-99	
		plug 12-150	

	sealing push-in	12-40	
	snap	6-202	
tube	conical	10-106	
	rectangular	10-105	
	round	10-104	
	square	10-105	
Caphead tapping screw	metric cross recessed head	6-108	
	metric Torx®	6-109	
Capstan	screw metric	6-33	
Capsule	chemical anchor Fischer	8-84	
		Spit 8-85	
Cardan joint	double	12-49	
	single	12-48	
Carriage bolt	metric	1-77/1-75	
		short square 1-80	
		metric with hexagon nut 1-75, 1-76	
		UNC 1-77/1-79	
Carrier	adapter Amecoil	3-158	
Carrying	box Fischer	11-26	
Cartridge injection	Fischer	8-86	
	MaxxFast	8-85, 8-86	
Cast hinge		13-99, 13-100	
	with thread	13-102, 13-103	
Castle nut	metric	3-86, 3-87	
		thin 3-89	
	metric fine	3-88, 3-90	
		thin 3-91	
		UNF 3-92	
Catch counter for toggle clamp	AMF	12-162	
Caterpillar trackshoe	bolt	1-87	
Cavity fixing	Fischer	8-16	
	MaxxFast	8-15	
	tool Fischer	8-17	
		MaxxFast 8-17	
Center	grooved pin	9-21	
	point cladding screw	6-115	
Chain		13-136	
	quick link	13-137	
Channel	connector Fischer	10-48	
	rail Fischer	10-39	
	washer Fischer	10-43	
Cheese head screw	BSW hexagon socket	2-32	
	metric	2-18, 2-19	
	metric fine hexagon socket	2-20	
	metric fully threaded	2-17/2-19	
	metric hexagon socket	2-2/2-15	
	metric hexalobular	2-16, 6-43	
	metric slotted	6-10/6-15	
		UNC 2-26	
		hexagon socket 2-21/2-22, 2-25, 2-27	
		UNF hexagon socket 2-29, 2-30, 2-31	
	screw with flange	metric hexagon socket	2-63
	security screw	self tapping with 2 holes	10-120
Chemical anchor capsule	Fischer	8-84	
	Spit	8-85	

Chemical	anchor	internal	Fischer	8-90	snap			10-58
		threaded			three part			10-85
	rod	fixing	Fischer	8-81	two	ear	ABA	12-17
			MaxxFast	8-80	wire rope			5-24, 5-25, 13-59
			Spit	8-83	Coat	hook		13-115/13-118
Cladding	center	point		6-115	Collar ring	serrated	Dubo	7-112
screw					Combi	screw	metric slotted	6-35
Clamp	adjusting	ring		7-132, 7-133	Combination	beam clip		10-56, 10-57
	beam	Fischer		10-47	Compres-	helical	spring	12-74
	clip	ABA		12-21	sion			
		with rubber	ABA	12-20	Concrete	anchoring	countersunk Powers	8-64
			MaxxFast	12-19		screw		
	exhaust	Awab		12-24			hexagon Powers	8-61
	pipe						mushroom Powers	8-63
	flange head	Lindapter		10-31			head	
		with set	Lindapter	10-31			round head Powers	8-63
		screw and					anchoring hexagon Powers	8-62
		nut					screw A4	
	Flush	Lindapter		10-32	Cone point	roofing and	screw	6-113
	hanger	Fischer		10-50		cladding		
	high friction	Lindapter		10-27		set screw	metric hexagon socket	2-83, 2-84
	high slip	Lindapter		10-23			metric slotted	6-6, 6-7
	resistance				Conical	lubricating	metric	12-42
	hinged	pipe	Fischer	10-36		nipple		
	hook	toggle	AMF	12-159			metric extra fine	12-45
	horizontal	toggle	AMF	12-153/12-155			metric fine	12-44
	hose	ABA		12-7/12-11, 12-18			non-metric	12-45
		assortment	ABA	12-22			UNF	12-46
			MaxxFast	12-21			retaining spring	10-80
			MaxxFast	12-6, 12-8, 12-10			spring washer	7-89, 7-90
		micro	ABA	12-16			spring washer	7-61
		mini	ABA	12-13			tube cap	10-106
			MaxxFast	12-12	Connection	round	metric	3-124, 3-125
		plastic		12-130	nut			
		robust	ABA	12-14, 12-15	Connector	bar	Vemo	8-97
	pipe			12-25		bolt	Fischer	10-53
		full		12-37, 12-38		channel	Fischer	10-48
		half		12-33, 12-36		corner	socket hexagon socket	10-96
		two parts	Fischer	10-37		double	plate Fischer	10-52
	push-pull	toggle	AMF	12-156/12-158		multiple	system	12-53
	refrigeration	pipe	Fischer	10-38		parallel	Fischer	10-49
	self adjust-	Lindapter		10-28	Console	cantilever	arm Fischer	10-40
	ing				Contact	lock washer		7-107, 7-108
	vertical	toggle	AMF	12-151, 12-152		spring washer		7-82
Clamp lever	liftable			12-101, 12-102	Continuous	hinge		13-105
		metric		12-99, 12-100	Corner	socket	connector hexagon socket	10-96
		with threaded rod		12-102	Cotter of a	spring	double	9-43, 9-44
		metric firm high		12-103, 12-104	bolt			
Clamping	adjustable			12-53			single	9-42
joint					Cotter pin	spring		13-67
Clamping	Band-It			12-26/12-28	Counter	catch	for toggle AMF	12-162
system							clamp	
Clevis	pin			9-36	Counter-	anchoring	concrete Powers	8-64
Clip	beam			10-56, 10-58	sunk	screw		
	clamp	ABA		12-21			Powers	8-57, 8-60
		with rubber	ABA	12-20		blind rivet		9-63/9-65, 9-68,
			MaxxFast	12-19				9-73, 9-77
	fixing	Norma		12-117, 12-118			nut	3-131/3-133, 3-138
	grating	Lindapter		10-34		decking	hexalobular Heco-Topix	6-164
	one	ear	ABA	12-16		screw		
	rail	Lindapter		10-30		Hollo-bolt	Lindapter	10-18
	retaining			7-131		nib bolt	metric with hexagon nut	1-81

Alphabetical Index

Counter-sunk	nut	metric slotted	3-126
	rivet		9-34, 9-35, 9-36
screw	BSW	hexagon socket	2-50
		slotted	6-27
		cross recess self drilling	6-145
		and wings	
		cross self drilling MaxxFast	6-130, 6-131
		recessed	
		cross self drilling	6-132, 6-133
		recessed	
		head	
		for thermo plastics	6-72
		metric	6-49, 6-50
			thread rolling 6-68
		metric cross recessed head	6-44/6-48
			thread cutting 6-59
		metric hexagon socket	2-39/2-44
		metric hexalobular	2-44, 2-45, 6-49
			thread rolling 6-68
		metric slotted	6-21/6-23, 6-25, 6-26
		metric Torx® thread	TAPTITE 6-64
			forming 2000®
	Torx®	self drilling 6-143	
	UNC	hexagon socket 2-46, 2-47	
		hexalobular thread cutting 6-61	
		Torx® self drilling 6-144	
	UNF	hexagon socket 2-49, 2-50	
	wings and	self drilling 6-142	
	Torx®		
screw for chipboard	cross recessed head		6-154, 6-155, 6-156
		Heco-Fix	6-155
		Heco-Topix	6-157
		Heco-Unix Plus	6-157
		hole	6-158
		small head	6-159
		hexalobular	6-159, 6-160, 6-161
			Heco-Topix 6-160, 6-162
			Heco-Unix Top 6-160
	security screw	metric	
		metric with 2 holes	10-116
		self tapping	10-122, 10-123, 10-124
serrated	lock washer		7-69
	tapping screw	metric cross recessed head	6-87, 6-88, 6-89, 6-90
screw		metric hexalobular	6-91, 6-92
		metric slotted	6-75
		metric with square recessed head	6-93
	ttap®	decking MaxxFast	6-164
screw		MaxxFast	6-151, 6-152, 6-176
		self drilling MaxxFast	6-134, 6-135, 6-141
	wood screw	cross MaxxFast	6-149, 6-150
wood screw		recessed	
		cross recessed head	6-187, 6-188, 6-190
		hexalobular	6-163, 6-178, 6-179
		slotted	6-179/6-181, 6-185, 6-186
	Cover	cap	
	Fischer		10-41
	for cross recessed head screw for chipboard		6-201
	for cross recessed head screws with hole		6-200
	for hexagon head wood screw		6-202
	for window Fischer		8-41
	frame screw		
	for hexagon socket screws		2-91
	plug		12-149
Covered	hinge		13-104, 13-105
Crank	handle	foldaway	12-96
		with threaded bush	12-96
Cross	dowel	metric slotted	10-96
	wire	rope clip	13-78
Cup	hook		13-120
		metric	5-29
		non-metric	5-32, 5-33
Cup point	set screw	BSW hexagon socket	2-90
		metric	2-76
		metric fine	2-72
		metric hexagon socket	2-69, 2-70, 2-71
		metric slotted	6-7, 6-8
		UNC hexagon socket	2-73, 2-74
Cupped	lubricating nipple	metric	12-43
		washer	for seating screw 1-83
		Curved	spring washer 7-63/7-66
Cutter	wire rope		13-56
Cylindrical	blind rivet	nut	3-128/3-130, 3-137
		screw	3-139
		vibration	metric 12-62, 12-63, 12-64
		isolator	
Cylindrical pipe thread	socket	screw	2-98
		with collar	2-97, 2-98
D			
D	shackle		5-20, 5-21, 13-5/13-11
Decking screw	counter-sunk	hexalobular Heco-Topix	6-164
		ttap® MaxxFast	6-164
Deep	washer	Lindapter	10-27
Descender	eight	figure	13-33
Disc	knob	metric through hole	12-81
		metric with threaded bush	12-81, 12-82
		metric with threaded rod	12-81, 12-82
	locking	spring	7-93, 7-94, 7-104, 7-105
		spring	7-86, 7-88
			for ball bearing location
		for critical application	7-83/7-85, 7-91
Dog point	set screw	metric	2-87, 6-9
		metric hexagon socket	2-86, 2-87, 2-89
Domed	blind rivet		9-56/9-60, 9-69, 9-70
		expanding	9-79
	nut	BSW high	3-99
		metric high	3-97, 3-98, 3-99
		low	3-101, 3-102
		metric with welded cap	3-100
	serrated lock washer	7-67	

Domed cap	hexagon	metric with self locking	3-102, 3-103
nut		non metallic insert	
Door	boat holder		13-128
	holder		13-127, 13-128
Double	cardan joint		12-49
	connector plate	Fischer	10-52
	spring	cotter of a bolt	9-43, 9-44
	spring washer		7-60
Double end	stud	metric with reduced shank	4-61, 4-62
Double locking	spring	hook	13-25
Dowel	cross	metric slotted	10-96
	nut	metric hexagon socket	10-92
	screw		13-76
		metric	5-36/5-39
Driller	cable	tie	12-134
Drive	rivet		12-136
	screw		9-23
Drive-in	lubricating nipple	metric	12-43
	nut	metric for wood	10-89
Driver bit	screw	pneumatic self drilling unit	6-146
		screwdriver self drilling	6-146
		setting tool self drilling	6-146
		socket self drilling	6-147
Dry wall	screw	cross recessed head	6-198, 6-199
Dubo	retaining ring		7-110, 7-111
	serrated	collar ring	7-112
E			
Ear	one	clip ABA	12-16
	two	clip ABA	12-17
Edge	locking	washer	7-66
Eight	figure	descender	13-33
Element	packing	Lindapter	10-24/10-26
Elongation piece	book	screw	10-103
Exhaust	nut		3-43
		self locking	3-42
Exhaust pipe	clamp	Awab	12-24
Expanding	blind	rivet with yellow cap	9-69
	domed	blind rivet	9-79
	mushroom	blind rivet	9-78
	head		
	plug		8-45
		MaxxFast	8-44
Expansion	anchor	metric brass Fischer cone	8-48
	shield	anchor Rawlplug	8-45, 8-47, 8-48
		metric with conical nut	8-46
Extension	nut	metric	10-8
External taper pipe thread	socket	screw	2-93
Extra large	mushroom	blind rivet	9-72
domed head	head		
Extractor	Amecoil		3-159
Eye	bolt	metric	5-4, 5-5
		metric fully threaded	5-6

folding pad			13-129
nut	metric		5-11, 5-12
		metric with CE marking	5-11
screw	metric		5-28
		non-metric	5-30/5-32
F			
Ferrule			13-61
FESTA-PLAN	sealing ring		7-148, 7-149
Fiber	flat	washer for cars	7-150
	packing	ring	7-149
Figure	eight	descender	13-33
Fischer	adjustable	screw	8-42
	aircrete	anchor plug	8-21
	anchor		8-22, 8-23, 8-49
	angle	bracket	10-45
	assortment	box wall plug	8-8
	beam	clamp	10-47
	bolt	anchor	8-74, 8-78
		tool	8-78
		connector	10-53
	cantilever	arm console	10-40
	carrying	box	11-26
	cavity	fixing	8-16
		tool	8-17
	channel	connector	10-48
		rail	10-39
		washer	10-43
	chemical	anchor capsule	8-84
		internal threaded	8-90
		rod fixing	8-81
	clamp	hanger	10-50
	cover	cap	10-41
		for window frame screw	8-41
	double	connector plate	10-52
	expansion	anchor metric brass cone	8-48
	fixing	adjustable	8-43
		universal	8-14
	frame	fixing	8-35/8-39
	hammer	fix	8-29, 8-30
		with isolating washer	8-31
	hammerset	anchor	8-54
	high performance	anchor metric	8-75, 8-77
	hinged	pipe clamp	10-36
	hollow	anchor	8-56
	ceiling		
	injection	anchor accessories	8-89
		cartridge	8-86
		tool	8-87
	installation	angle bracket	10-44
		tool	8-24
	long	shaft fixing	8-32, 8-33
	nail	sleeve	8-27
	parallel	connector	10-49
	perforated	banding steel	10-51
	pipe	clamp two parts	10-37
	plaster-board	fixing	8-20
	plug	toggle	8-25
		universal	8-13
	refrigeration	pipe clamp	10-38

Alphabetical Index

Fischer	saddle				10-35	
		flange			10-46	
	setting	tool			8-55, 8-83	
	sleeve	anchor			8-50	
	sliding	nut			10-42	
	t-head	bolt			10-41, 10-44	
	through bolt	anchor			8-68, 8-69, 8-70	
	wallplug				8-7, 8-9, 8-11	
	window	frame	screw		8-41	
	Fit bolt	hexagon	metric with long thread		1-71	
	Five lobe	grip	metric		12-83	
Fix	hammer	Fischer			8-29, 8-30	
		with isola- ting washer	Fischer		8-31	
Fixing	adjustable	Fischer			8-43	
	cavity	Fischer			8-16	
		MaxxFast			8-15	
		tool	Fischer		8-17	
			MaxxFast		8-17	
	chemical	rod	Fischer		8-81	
			MaxxFast		8-80	
			Spit		8-83	
	clip	Norma			12-117, 12-118	
	frame	Fischer			8-35/8-39	
	long	shaft	Fischer		8-32, 8-33	
	plaster- board	Fischer			8-20	
			MaxxFast		8-18	
steelwork	Lindapter			10-20/10-23		
universal	Fischer			8-14		
Fixing washer	for shaft - with cap				7-128	
	for shaft - with conical cap				7-128	
	for shaft - without cap				7-130, 7-131	
	tool	handle				7-129
		handle, magnetic				7-129
		handle, magnetic				7-129
Flange	saddle	Fischer		10-46		
Flange head	clamp	Lindapter			10-31	
		with set	Lindapter		10-31	
		screw and nut				
		ttap®	screw	timber	MaxxFast	6-177
	Flange nut	hexagon	metric with non metallic insert	self locking	3-81	
Flat	nut	metric hexagon socket			10-93	
	screw	metric hexagon socket			10-95	
	washer				7-47, 7-48, 7-49	
	for cars	fiber		7-150		
Flat counter- sunk	square neck bolt	metric with hexagon nut	long square	1-82		
Flat point	roofing and cladding	screw			6-114	
	set screw	metric fine				2-81
metric hexagon socket				2-79, 2-80		
metric slotted				6-4, 6-5		
UNC		hexagon socket			2-77, 2-82, 2-85, 2-88	
UNF		hexagon socket			2-75, 2-76, 2-78	
Flat tension	lever	liftable		12-98		
			with threaded rod	12-98		
Flexible	machine	support			12-72	
		socket	screwdriver	ABA	12-23	
			MaxxFast		12-23	
Floorfast	locking	Lindapter			10-33	
	system					
Flush	clamp	Lindapter			10-32	
Flush Fit	Hollo-bolt	Lindapter			10-19	
Foldaway	handle	crank			12-96	
			with threaded bush		12-96	
		metric revolvable			12-95	
	handwheel	solid			12-108, 12-109	
		two spokes			12-106	
Folding pad	eye				13-129	
Foot plate	GMT				12-70	
Fork	joint	with spring pin			12-50	
		left hand			12-50	
Frame	anchor	MaxxFast			8-33, 8-34	
	fixing	Fischer			8-35/8-39	
	window	screw	Fischer		8-41	
			MaxxFast		8-40	
Front load	receptacle			10-83		
G						
G	button	lubricating nipple			12-46	
Gate	hook	non-metric with 2 screw eyes			5-42	
Gear lever	handle	metric			12-97	
Glide	support				12-141	
GMT	foot plate				12-70	
	hammer-in	cap	square		12-69	
	spindle				12-71	
Grating	clip	Lindapter			10-34	
Grip	five lobe	metric			12-83	
	T	metric brass threaded bush			12-89	
		metric with steel zinc plated threaded rod			12-89	
	wing	metric			12-87	
Grommet					10-78, 12-115	
	nut				12-140	
Grooved	center	pin			9-21	
	parallel	pin			9-18, 9-19	
			pilot		9-14	
	reverse	pin			9-20	
	round head	pin			9-22	
	taper	pin			9-15, 9-16, 9-17	
	Ground plate	wall bracket				13-80
H						
Hammer	fix	Fischer			8-29, 8-30	
		with isola- ting washer	Fischer		8-31	
Hammer-in	anchor	Spit			8-26	
	cap	square	GMT		12-69	
Hammerset	anchor	Fischer			8-54	
		MaxxFast			8-52, 8-53	
Hand pliers	blind rivet	tool			9-80	
	cable	tie	MaxxFast		12-129	
Hand swager	swaging die				13-62	
Handle					13-134, 13-135	
	bridge				12-90, 12-91	
		metric				12-91
	metric brass threaded bush			12-90		

Handle	crank	foldaway		12-96	
			with threaded bush	12-96	
	foldaway	metric	revolvable	12-95	
	gear lever	metric		12-97	
	metric			12-92	
	not revolvable	metric		12-93	
	revolvable	metric		12-94 , 12-95	
	spinner			12-93	
	Handwheel			12-104 , 12-105	
	foldaway	two spokes		12-106	
solid			12-107		
	foldaway		12-108 , 12-109		
	two spokes		12-106		
Hanger	clamp	Fischer	10-50		
Hardened	washer		10-11		
Hasp	swivel		13-106 , 13-107		
			13-108		
Head	terminal		13-75		
Heco-Fix	counter-sunk	screw for	cross recessed head	6-155	
			chipboard		
	raised	screw for	cross recessed head	6-169	
	cheese	chipboard			
head	raised	screw for	cross recessed head	6-171	
		counter-sunk	chipboard		
Heco-Topix	counter-sunk	decking	hexalobular	6-164	
			screw		
		screw for	cross recessed head	6-157	
		chipboard			
		hexalobular	6-160 , 6-162		
Heco-Unix Plus	counter-sunk	screw for	cross recessed head	6-157	
		chipboard			
Heco-Unix Top	counter-sunk	screw for	hexalobular	6-160	
		chipboard			
Helical	compression	spring		12-74	
		tension	spring with English eye	12-75	
Helical extra duty	spring lock	square ends		7-56 , 7-57	
		washer			
Helical heavy	spring lock	washer		7-55 , 7-56	
Helical high collar	spring lock	washer		7-59	
Helical regular	spring lock	square ends		7-53 , 7-54	
Hexagon	anchoring	concrete	Powers	8-61	
			screw		
		slotted	Powers	8-59	
		concrete	Powers	8-62	
	anchoring	concrete	Powers	8-62	
	screw A4				
bolt	BSF			1-59	
				1-58	
				1-8	
				1-3/1-17	
				1-36 , 1-37 , 1-38	
				1-12	
				1-9	
				1-18	
				1-41/1-50	
				1-52/1-57	

bolt with	metric		1-66/1-69
flange	self locking		1-64 , 1-65
		Ripp	1-62 , 1-63
		metric fine	1-70
		metric serrated	1-69
domed cap	metric with	self locking	3-102 , 3-103
nut	non metallic	insert	
fit bolt	metric with long thread		1-71
flange nut	metric with	self locking	3-81
	non metallic	insert	
Hollo-bolt	Lindapter		10-16 , 10-17
nut	BSF		3-83
			3-28
		non metallic self locking	3-63
		insert	
	BSW		3-27 , 3-28 , 3-30
		non metallic self locking	3-63
		insert	
	ISO metric		3-8 , 3-44
		thin	3-33 , 3-39
	knuckle thread		8-95
	metric		3-6/3-46 , 4-62 , 10-6
			10-7
		left hand	3-6 , 3-7 , 3-11 , 3-12
		Peiner	1-91
		Permaglas	4-22
		self locking	3-65 , 3-75 , 3-76
			3-85
		thin	3-32 , 3-33 , 3-34
metric all	self locking	Snep	3-72
aluminium			
metric all	self locking		3-66 , 3-73
metal			
		Securit	3-74
		Snep	3-71 , 3-72
		Stover	3-65 , 3-66
metric all	self locking		3-64
stainless			
steel			
		Snep	3-71
metric ASTM A194			4-59
metric fine			3-15 , 3-16 , 3-53
		thin	3-35 , 3-36 , 3-37
metric fine	self locking		3-67
all metal			
metric fine left hand			3-15 , 3-16
		thin	3-36 , 3-37
metric fine	self locking		3-39 , 3-52 , 3-53
non metallic			
insert			
metric for double end stud			4-62
metric for pressure vessels ISO			3-19
metric left	thin		3-33 , 3-34
hand			
metric oversized			3-8 , 3-9 , 3-44
		thin	3-33

Alphabetical Index

Hexagon nut	metric with self locking			3-84	
	captive serrated lock washer				
	metric with flange			3-76, 3-77	
	metric with self locking			3-48, 3-49, 3-50, 3-51, 3-54	
	non metallic insert				
	parallel trackshoe thread			3-41	
	UNC			3-20/3-22, 3-23, 3-57	
	all metal self locking			3-68, 3-69	
	ASTM A194			4-57, 4-58, 4-59	
	non metallic self locking insert			3-55/3-61	
	UNF			3-24/3-26, 3-58	
	all metal self locking			3-70	
	non metallic self locking insert			3-58, 3-59, 3-61, 3-62	
	wheel with flange Nord-Lock			3-83	
	with flange self locking Ripp			3-74	
	nut with collar	metric			10-7, 10-8
	nut with flange	metric			3-79
		metric serrated			3-78, 3-79, 3-82
		UNC with flange self locking			3-80
	plug	security			10-127
	screw	BSF			1-61
		BSW			1-60
		ISO metric			1-24
metric				1-20/1-36	
		thread cutting			6-60
metric fine				1-39, 1-40, 1-41	
metric for pressure vessels				1-27	
metric oversized				1-25	
metric slotted				1-35	
metric with small hexagon and dog point				1-86	
screw with flange		metric thread TAPTITE forming 2000®			6-63
		self drilling			6-137, 6-138
structural assembly set		metric with hexagon nut			1-94, 1-95, 1-96, 1-97
tapping screw				6-98, 6-99, 6-100	
	metric washer faced			6-100	
	self drilling MaxxFast			6-135, 6-136	
	without point			6-99	
weld nut	metric			3-109	
wood screw				6-173, 6-174	
	with bitumen washer			6-176	
	with stainless steel lead bitumen washer			6-174, 6-175	
Hexagon shank	blind rivet nut	reduced countersunk		3-135, 3-136	
	High domed	nut	BSW	3-99	
			metric	3-97, 3-98, 3-99	
High knurled	knob	metric for hexagon bolt, screw and nut		12-84	
	nut	metric		3-113	
	thumb screw	metric		6-204, 6-205	
		metric slotted		6-205	
	trackshoe nut	UNF		3-41	
High friction clamp	Lindapter			10-27	
High performance	anchor	metric	Fischer	8-75, 8-77	
			MaxxFast	8-72	
High slip resistance	clamp	Lindapter		10-23	
High strength	structural bolt	metric	Peiner	1-89	
Hinge				12-55, 13-82/13-97	
	cast			13-99, 13-100	
		with thread			13-102, 13-103
	continuous			13-105	
	covered			13-104, 13-105	
	welding			12-54	
Hinged pipe	clamp	Fischer		10-36	
Holder	boat door			13-128	
	door			13-127, 13-128	
Hole	counter-sunk	screw for chipboard		6-158	
Hollo-bolt	counter-sunk	Lindapter		10-18	
	Flush Fit	Lindapter		10-19	
	hexagon	Lindapter		10-16, 10-17	
Hollow ceiling	anchor	Fischer		8-56	
Hood	ornamental			12-39	
Hook				13-31, 13-114	
	anchor	metric with 100mm hook		8-93, 8-94	
		metric with 50mm hook		8-93	
	awning			13-121	
	coat			13-115/13-118	
	cup			13-120	
		metric		5-29	
		non-metric		5-32, 5-33	
	gate	non-metric with 2 screw eyes		5-42	
	S-			5-42	
	short cord			13-123	
	snap			5-26	
	spring			13-14/13-23, 13-32/13-34	
	double locking			13-25	
square hook	non-metric			5-34	
	non-metric cross recessed head			5-35	
toggle	clamp	AMF		12-159	
	horizontal clamp	AMF		12-160	
	vertical clamp	AMF		12-161	
trailer				13-3	
	with swivel			13-3	
	with thread			13-124	
Horizontal toggle	clamp	AMF		12-153/12-155	
Horizontal clamp	hook	toggle	AMF	12-160	
Hose	clamp	ABA		12-7, 12-11, 12-18	
	assortment	ABA		12-22	
		MaxxFast		12-21	
		MaxxFast		12-6, 12-8, 12-10	
	micro	ABA		12-16	
	mini	ABA		12-13	

Hose	clamp	MaxxFast	12-12	
		plastic	12-130	
		robust ABA	12-14, 12-15	
Information page	Amecoil	Wire thread inserts	03-142	
		Chipboard screws	06-153	
	Demu/ Vemo	Fixing anchors	08-96	
		Double end studs	04-60	
	Fabory	Blind rivet nuts and bolts		03-127
		Blind rivets		09-53
		Blind rivets II		09-54
		Fastclip fixing system		10-54
		Quality assortments		11-2
		Quick System Pawl latches		10-65
		Quick System Quarter turn fasteners		10-74
		Quick System Toggle latches		10-60
		Security Fasteners		10-107
		Self cutting threaded inserts		03-171
		Self cutting threaded inserts II		03-179
		Technical balls		12-110
		Global partner for studbolts		04-35
	Spedec self drilling screws		06-121	
		Fischer		08-6
	Kalei	Press nuts		03-93
	Keepstock	Hardware		11-25
	Lindapter	Steelwork connections		10-15
	MaxxFast	Anchors		08-3
		Assortment boxes		11-13
		Cable ties		12-119
		Chemical anchoring		08-79
		Hose clamps		12-5
Self Drilling screws		06-118		
Wood screws		06-148		
Nord-Lock				07-95
Peiner		High strength structural bolts		01-88
REMFORM®		Thread forming screws		06-69
Studbolts - threaded rods - heavy hexagon nuts			04-36	
TAPTITE	Thread rolling bolts and screws		06-62	
2000®				
ttap®	Drive		06-125	
Injection	anchor	accessories Fischer	8-89	
	cartridge	Fischer	8-86	
		MaxxFast	8-85, 8-86	
tool	Fischer		8-87	
	MaxxFast		8-87	
Insert			10-86, 10-87	
knock-in	with collar		10-91	
screw			10-88	
	hexagon socket		10-89, 10-90, 10-91	
	socket slotted		10-90	
threaded	self cutting		3-172, 3-173, 3-174	
	hexagon socket		3-174, 3-175	
tool	wire thread V-Coil		3-166/3-170	
tube	Vemo		8-98, 8-99	
	with nailing Vemo		8-98, 8-100	
	plate			
wire thread	metric Amecoil		3-146	
	metric extra Amecoil		3-147	
	fine			

	metric Amecoil		3-148	
	extra fine for spark plugs			
	metric fine Amecoil		3-147	
	metric self Amecoil		3-146	
	locking			
	UNC Amecoil		3-148	
	UNF Amecoil		3-149	
Insert tool	threaded	self cutting	3-176, 3-177	
		self tapping hexagon socket	3-178	
Installation	angle bracket	Fischer	10-44	
	tool	Fischer	8-24	
Insulating	bush		12-146, 12-147	
	tube		12-148	
Internal threaded	chemical anchor	Fischer	8-90	
Internal/external	serrated lock washer		7-69	
Isolator	vibration metric		12-65/12-69	
J				
Jacknut			3-121	
Jamnut	UNC		3-40	
Joint	ball	metric/mf inside left hand thread	12-47, 12-48	
		metric/mf inside right hand thread	12-47	
	cardan	double	12-49	
		single	12-48	
	fork	with spring pin	12-50	
left hand		12-50		
K				
Kalei	press nut metric		3-94, 3-95	
Key	bright parallel		9-50	
	parallel		9-47, 9-49	
	taper		9-52	
	woodruff		9-51, 9-52	
Kit	repair	Amecoil	3-153	
		metric V-Coil	3-160	
		non-metric V-Coil	3-161, 3-162	
		spark plug V-Coil		3-162
	workshop	BSW Amecoil		3-152
		metric Amecoil		3-149
		metric extra Amecoil		3-150, 3-151
		fine		
		metric fine Amecoil		3-150
		UNC Amecoil		3-151
UNF Amecoil			3-152	
Knob	ball	conical hole	12-77	
		metric	12-76	
	disc	metric through hole		12-81
		metric with threaded bush		12-81, 12-82
		metric with threaded rod		12-81, 12-82
	knurled	metric for high hexagon bolt, screw and nut		12-84
			thin	12-84
		metric for hexagon socket head cap screw		12-85
		metric with threaded bush		12-86, 12-87
		metric with threaded end		12-86
		metric with threaded rod		12-85
star	metric		12-78, 12-79	

Alphabetical Index

Knob	triangular star	with threaded bush	12-82 , 12-83	
		with threaded rod	12-82	
	turning	through hole	12-79	
		with threaded bush	12-79 , 12-80	
		with threaded rod	12-80	
Knock-in	insert	with collar	10-91	
Knuckle thread	hexagon	nut	8-95	
		shuttering	threaded rod	8-95
Knurled	knob	metric for high	12-84	
		hexagon bolt, screw and nut		
		thin	12-84	
		metric for hexagon socket head cap screw	12-85	
		metric with threaded bush	12-86 , 12-87	
		metric with threaded end	12-86	
		metric with threaded rod	12-85	
	nut	metric		3-115 , 10-92
			high	3-113
			thin	3-114 , 3-115
thumb screw	metric		6-207	
		high	6-204 , 6-205	
		thin	6-206 , 6-207	
		metric high	6-205	
		slotted		
L				
Large domed head	mushroom head	blind rivet	9-61 , 9-62	
Latch			13-109 , 13-110	
	pawl		10-68 , 10-70	
		accessory	10-72	
	toggle		10-61 , 10-62	
Left hand	fork	joint with spring pin	12-50	
		hexagon nut metric	3-6 , 3-7 , 3-11 , 3-12	
	round nut	Tr	4-26	
	spherical bearing	plain external thread	12-52	
		plain internal thread	12-51	
	threaded rod	metric	4-5 , 4-6 , 4-8 , 4-9	
		Tr	4-24	
Lever	flat tension	liftable	12-98	
		with threaded rod	12-98	
	tension	liftable	12-98	
		with threaded rod	12-98	
License plate	screw	cross recessed head	6-107 , 6-108	
		slotted	6-109	
Liftable	clamp lever		12-101 , 12-102	
		metric	12-99 , 12-100	
		with threaded rod	12-102	
	flat tension lever		12-98	
		with threaded rod	12-98	
	tension lever	with threaded rod	12-98	
Lifting	ring		13-111 , 13-112	
			13-113	
Lifting eye	bolt	BSW	5-9	
		metric	5-8 , 5-9	
Linch	pin		9-46	

Lindapter	adjustable clamp	tail clamp	10-29
		high slip resistance	10-23
		self adjusting	10-28
	clip	grating	10-34
	deep	washer	10-27
	flange head clamp		10-31
		with set screw and nut	10-31
	Floorfast	locking system	10-33
	Flush	clamp	10-32
	high friction	clamp	10-27
Hollo-bolt	countersunk	10-18	
	Flush Fit	10-19	
	hexagon	10-16 , 10-17	
packing	element	10-24 , 10-25 , 10-26	
rail	clip	10-30	
steelwork	fixing		10-20 , 10-21 , 10-22
			10-23
Lock washer	contact		7-107 , 7-108
		serrated	7-68 , 7-70/7-81
		countersunk	7-69
		internal/external	7-69
	spring		7-58
		square ends	7-50 , 7-51 , 7-52 , 7-57 , 7-58
Locking		10-66 , 10-67	
bar guide			10-73
	bolt	metric fine	12-61
		metric fine with locking groove	12-60
		metric fine without locking groove	12-60
	cable tie		12-121 , 12-131
		assortment	12-124
		MaxxFast	12-120 , 12-121 , 12-122
		mount	12-128
		MaxxFast	12-128
		releasable MaxxFast	12-126
		self adhesive	12-132 , 12-133
		Ty-Rap	12-123
		with eye	12-124
		with label	12-125 , 12-126
	with mount releasable	12-127	
	disc	spring	7-93 , 7-94 , 7-104 , 7-105
	edge	washer	7-66
Locking system	Floorfast	Lindapter	10-33
	shaft fixing	Fischer	8-32 , 8-33
Long square	flat counter-sunk bolt	square neck metric with hexagon nut	1-82
	domed nut	metric	3-101 , 3-102
Low head cap	screw	metric hexagon socket	2-33/2-38
Lubricating nipple	button	G	12-46
		metric fine	12-44
	conical	metric	12-42
		metric extra fine	12-45
		metric fine	12-44
		non-metric	12-45
		UNF	12-46
	cupped	metric	12-43
	drive-in	metric	12-43

M

Machine	flexible support				12-72
	tap	metric fine	Amecoil		3-144
		for wire			
		thread insert			
		metric for	Amecoil		3-143
		wire thread			
		insert			
	UNC	for wire	Amecoil		3-145
		thread			
		insert			
	UNF	for wire	Amecoil		3-145
		thread			
		insert			
Mandrel	nozzle	metric	Amecoil		3-156, 3-157, 3-158
Manual fitting tool	multidimensional	metric	Amecoil		3-154
		metric	Amecoil		3-155, 3-156
		complete			
		metric with	Amecoil		3-155
		nozzle			
Masonry	bolt	metric			8-91, 8-92
Massive ball					13-78, 13-79
Master clamp					10-59
Matching key					10-71
MaxxFast	anchor	accessories			8-88
	cavity	fixing			8-15
			tool		8-17
	chemical	rod	fixing		8-80
	clip	clamp	with rubber		12-19
	counter-sunk	screw	cross self drilling		6-130, 6-131
			recessed		
		ttap®	decking screw		6-164
			screw		6-151, 6-152, 6-176
			self drilling		6-134, 6-135, 6-141
	wood screw	cross recessed			6-149, 6-150
	expanding	plug			8-44
	flange head	ttap®	screw timber		6-177
	flexible	socket	screwdriver		12-23
	frame	anchor			8-33, 8-34
	hammerset	anchor			8-52, 8-53
	hand pliers	cable	tie		12-129
	hexagon	tapping	self drilling		6-135, 6-136
		screw			
	high performance	anchor	metric		8-72
	hose	clamp			12-6, 12-8, 12-10
			assortment		12-21
			mini		12-12
	injection	cartridge			8-85, 8-86
		tool			8-87
	locking	cable	tie		12-120, 12-121, 12-122
					12-128
			mount		12-128
			reasable		12-126
	pan head	cross	screw self drilling		6-120
		recessed			
		screw	cross self drilling		6-119
			recessed		
		square	screw self drilling		6-128
		socket			
		ttap®	screw self drilling		6-126, 6-127
	plaster-board	fixing			8-18
	raised	ttap®	woodscrew		6-167, 6-168
	cheese				
	head				
		woodscrew	cross recessed		6-165, 6-166
	setting	tool			8-55
	through bolt	anchor			8-66, 8-67
	wallplug				8-4, 8-10, 8-12, 8-28
	window	frame	screw		8-40
Micro	hose	clamp	ABA		12-16
Mini	hose	clamp	ABA		12-13
			MaxxFast		12-12
Mount	locking	cable	tie		12-128
					12-128
			MaxxFast		12-128
Mudwing	repair	washer			7-44, 7-45
Multidimensional fitting tool	manual	metric	Amecoil		3-154
		metric	Amecoil		3-155, 3-156
		complete			
		metric with	Amecoil		3-155
		nozzle			
Multiple	connector	system			12-53
Mushroom head	anchoring	concrete	Powers		8-63
	screw				
	blind rivet				9-65/9-76
		expanding			9-78
		extra large domed head			9-72
		large domed head			9-61, 9-62
	screw	metric cross thread	Remform		6-71
		recessed	forming		
		head			
		SR recess	self drilling		6-140
	security	self tapping	Tri-wing		10-122
	screw				
	tapping	metric cross recessed head			6-103
	screw				
Musketon					13-23, 13-24
N					
Nail	ring				13-133
	sleeve	Fischer			8-27
Neck bolt	wing	metric with	Seha		1-80
		hexagon			
		nut			
Nib bolt	counter-sunk	metric with hexagon nut			1-81
Non-metric	assortment	V-Coil			3-164, 3-165
Nord-Lock	hexagon	nut	wheel with flange		3-83
	vibration	proof	washer		7-96/7-103
Norma	fixing	clip			12-117, 12-118
Not revolvable	handle	metric			12-93
Nozzle	mandrel	metric	Amecoil		3-156, 3-157, 3-158
Nut	blind rivet	assortment			3-141
		countersunk			3-131, 3-132, 3-133, 3-138
					3-128, 3-129, 3-130, 3-137
		cylindrical			3-128, 3-129, 3-130, 3-137
		reduced countersunk			3-134, 3-135
			hexagon shank		3-135, 3-136
		tool			3-140
book					10-101

Alphabetical Index

Nut	bow		3-107		
	button head	metric hexagon socket	10-94		
	cage	metric	3-119		
	castle	metric		3-86 , 3-87	
			thin	3-89	
		metric fine		3-88 , 3-90	
			thin	3-91	
		UNF	3-92		
	counter-sunk	metric slotted	3-126		
	domed	BSW	high	3-99	
			metric	3-97 , 3-98 , 3-99	
			low	3-101 , 3-102	
			metric with welded cap	3-100	
	dowel	metric hexagon socket	10-92		
	drive-in	metric for wood	10-89		
	exhaust			3-43	
			self locking	3-42	
	extension	metric	10-8		
	eye	metric		5-11 , 5-12	
				metric with CE marking	5-11
	flat	metric hexagon socket	10-93		
	for turnbuckle			13-77	
	grommet			12-140	
	hexagon			3-83	
		BSF		3-28	
				non metallic self locking insert	3-63
		BSW		3-27 , 3-28 , 3-30	
				non metallic self locking insert	3-63
				ISO metric	3-8 , 3-44
				thin	3-33 , 3-39
		knuckle thread		8-95	
		metric			3-6/3-46 , 4-62 , 10-6 , 10-7
				left hand	3-6 , 3-7 , 3-11 , 3-12
				Peiner	1-91
				Permaglas	4-22
				self locking	3-65 , 3-75 , 3-76 , 3-85
					thin
			self locking	Snep	3-72
	metric all aluminium				3-66 , 3-73
	metric all metal				
				Securit	3-74
				Snep	3-71 , 3-72
				Stover	3-65 , 3-66
	metric all stainless steel		self locking		3-64
			Snep	3-71	
	metric ASTM A194			4-59	
	metric fine			3-15 , 3-16 , 3-53	
			thin	3-35 , 3-36 , 3-37	
	metric fine	self locking		3-67	
	all metal				
	metric fine	left hand		3-15 , 3-16	
			thin	3-36 , 3-37	
	metric fine	self locking		3-39 , 3-52 , 3-53	
	non metallic				
	insert				
	metric for double end stud			4-62	
	metric for pressure vessels ISO			3-19	
	metric left	thin		3-33 , 3-34	
	hand				
	metric oversized			3-8 , 3-9 , 3-44	
		thin		3-33	
	metric with	self locking		3-84	
	captive serrated lock				
	washer				
	metric with flange			3-76 , 3-77	
	metric with	self locking		3-48 , 3-49 , 3-50 , 3-51 , 3-54	
	non metallic			3-51 , 3-54	
	insert				
	parallel	trackshoe		3-41	
	thread				
	UNC			3-20/3-23 , 3-57	
		all metal	self locking	3-68 , 3-69	
		ASTM A194		4-57 , 4-58 , 4-59	
		non metallic	self locking	3-55/3-61	
		insert			
	UNF			3-24/3-26 , 3-58	
		all metal	self locking	3-70	
		non metallic	self locking	3-58 , 3-59 , 3-61 , 3-62	
		insert		3-62	
	wheel	with flange	Nord-Lock	3-83	
	with flange	self locking	Ripp	3-74	
	knurled	metric		3-115 , 10-92	
			high	3-113	
			thin	3-114 , 3-115	
	metric for T-slot			10-5	
	pointed	metric		3-118	
	press	metric	Kalei	3-94 , 3-95	
	Rawlnut	metric brass	Rawlplug	8-51	
			threaded bush		
	round	metric for hook spanners		3-123	
metric slotted			3-123 , 3-124		
metric with		self locking	3-126		
non metallic		insert			
Tr			4-25 , 4-26 , 4-27		
	left hand		4-26		
sleeve	metric		10-100		
sliding	Fischer		10-42		
speed			3-120		
spot weld	metric		3-111		
square	metric		3-117 , 3-118		
		thin	3-116 , 3-117		
toggle			3-107		
trackshoe	UNF	high	3-41		
		square	3-42		
		thin	3-42		
turnbuckle	metric		5-15		
		metric hexagon	5-13		
		metric made from tubes	5-13		
		metric with hook and eye	5-15 , 5-16		
		metric with two eyes	5-16 , 5-17		
		metric with two flat eyes	5-19		

Nut	turnbuckle	metric with two hooks	5-18
		metric with two studs	5-14
	weld	metric with smooth flange	3-110
	wing	BSW	3-106
		metric	3-108
		metric light (American) type	3-103, 3-104
metric rounded wings		3-104, 3-105	
	metric with threaded bush	12-88	
Nut with collar	hexagon	metric	10-7, 10-8
	wing	metric	3-108
Nut with flange	hexagon	metric	3-79
		metric serrated	3-78, 3-79, 3-82
	UNC	with flange self locking	3-80
O			
One	ear	clip ABA	12-16
One way	raised	security self tapping	10-126
	counter-sunk head		
	security screw	self tapping	10-121
		Pan head	10-121
O-ring			7-151/7-156
	wire		7-157
Ornamental	hood		12-39
Oval point	set screw	UNC hexagon socket	2-90
P			
Packing	element	Lindapter	10-24, 10-25, 10-26
	ring	fiber	7-149
Pan head	cross recessed	screw self drilling MaxxFast	6-120
		one way security screw self tapping	10-121
	screw	cross self drilling MaxxFast	6-119
		recessed	
		for thermo plastics	6-72
		metric cross recessed head	6-78/6-83
		metric cross recessed head without point	6-83
		metric hexalobular	6-84, 6-85
		metric large head	6-20
		metric slotted	6-16, 6-17, 6-18, 6-73, 6-74
		metric slotted without point	6-74
		metric small head	6-19
	self drilling	cross recessed head	6-122, 6-123, 6-124
		square socket drive	6-130
		SR	6-129
	security screw	metric	10-113
		metric with 2 holes	10-113
		self tapping	10-119
	shoulder screw	metric slotted	6-34
	square socket	screw self drilling MaxxFast	6-128
tapping screw	metric with square recessed head	6-86	
ttap®	screw self drilling MaxxFast	6-126, 6-127	
wood screw	cross recessed head	6-193, 6-194	
	hexalobular	6-171, 6-195/6-197	

Panel	back	screw	cross recessed head	6-107, 6-139
Parallel	bright	key		9-50
	connector	Fischer		10-49
	grooved	pin		9-18, 9-19
			pilot	9-14
	key			9-47, 9-49
Parallel thread	pin		9-5/9-10	
		internal thread	9-13	
	hexagon nut	trackshoe	3-41	
Pawl	latch		10-68, 10-70	
		accessory	10-72	
Peiner	hexagon nut	metric	1-91	
	high strength	structural bolt	1-89	
	square washer	taper	washer	1-93
				for I-section 1-93 for U-section 1-93
	washer		1-92	
	Pelican hook			13-51, 13-52
Perforated	banding	steel	Fischer	10-51
Permaglas	hexagon threaded	nut rod	metric metric	4-22 4-21
	washer	plain		4-23
				9-21
Pin	center	grooved		9-21
	clevis			9-36
	linch			9-46
	parallel			9-5/9-10
		grooved		9-18, 9-19
			pilot	9-14
			internal thread	9-13
	pipe			9-45
	reverse	grooved		9-20
	ring			13-68
	round head	grooved		9-22
	spare threaded			3-178
	split			9-38/9-41
	square hook	metric		5-29
non-metric			5-35	
taper			9-3, 9-4	
		external thread	9-11	
		grooved	9-15, 9-16, 9-17	
		internal thread	9-12	
Pipe	clamp		12-25	
		full	12-37, 12-38	
		half	12-33/12-36	
		two parts	Fischer	10-37
	hinged	clamp	Fischer	10-36
	pin			9-45
	plug	Vemo		8-101
	refrigeration	clamp	Fischer	10-38
	Pipe thread	socket	screw with collar	2-95
	Plaster-board	fixing	Fischer	8-20
MaxxFast			8-18	
Plastic	hose	clamp	12-130	
Plate	double	connector	Fischer	10-52
	license	screw	cross recessed head	6-107, 6-108
			slotted	6-109
	welding	spring		10-81
Plug	aircrete	anchor	Fischer	8-21

Alphabetical Index

Plug	blanking				12-116				
	cover				12-149				
	expanding					8-45			
		MaxxFast				8-44			
	hexagon	security			10-127				
	pipe	Vemo			8-101				
	protective	cap			12-150				
	security	hexalobular			10-128				
	socket	metric fine hexagon socket			2-92				
	toggle	Fischer			8-25				
	universal	Fischer			8-13				
Plunger	spring	metric with ball			12-56				
		metric with pin			12-57 , 12-58				
		metric with plastic pin			12-59				
		smooth			12-59				
Pneumatic	blind rivet	tool			9-80				
Point	center	cladding screw			6-115				
Pointed	nut	metric			3-118				
Powers	anchoring screw	concrete	countersunk		8-64				
			hexagon		8-61				
			mushroom head		8-63				
			round head		8-63				
			countersunk		8-57 , 8-60				
	hexagon	slotted		8-59					
	round head			8-58					
	anchoring screw A4	concrete	hexagon		8-62				
	Press	nut	metric	Kalei		3-94 , 3-95			
	Proof	vibration	washer	Nord-Lock		7-96/7-103			
Protection	cup				10-85				
Protective	buffer				12-143				
		cap	for hexagon bolt, screw and nut		1-98 , 1-99				
		plug				12-150			
	washer				10-79				
Push	rivet				12-139				
Push-in	sealing	cap			12-40				
Push-pull	toggle	clamp	AMF		12-156/12-158				
Q									
Quick attach	terminal				13-53 , 13-54				
Quick link	chain				13-137				
R									
Rail	channel	Fischer			10-39				
	clip	Lindapter			10-30				
	turnbuckle				13-69				
Raised	screw	metric cross recessed head			6-36/6-40				
cheese head									
						thread cutting			6-57
						thread	Remform		6-70
						forming			
						metric hexalobular			6-41 , 6-42
						metric	thread rolling		6-66
						raised			
						cheese			
						head			
						metric Torx®	thread forming		6-71
							TAPTITE		6-65
							2000®		
						metric with	thread rolling		6-67
						small head			
						screw for chipboard	cross recessed head	Heco-Fix	
hexalobular		6-170							
ttap®	woodscrew	MaxxFast	6-167 , 6-168						
woodscrew	cross	MaxxFast	6-165 , 6-166						
	recessed								
Raised	screw	metric		6-102 , 6-103					
countersunk									
head									
	metric cross recessed head		6-51/6-53 , 6-94/6-97						
	thread cutting		6-58						
	metric hexalobular		6-54 , 6-55						
	metric slotted		6-28/6-30 , 6-76 , 6-77						
screw for chipboard	cross recessed head		6-172						
	Heco-Fix		6-171						
security	self tapping	one way		10-126					
screw	wood screw	cross recessed head		6-191 , 6-192					
Raised head	security	self tapping	with 2 holes		10-125				
screw									
Ratched	rivet				12-138				
Rawlnut	nut	metric brass	Rawlplug		8-51				
		threaded							
		bush							
Rawlplug	expansion	shield	anchor		8-45 , 8-47 , 8-48				
	Rawlnut	nut	metric brass threaded		8-51				
		bush							
Receptacle	front load				10-83				
	slip-on	spring			10-82				
Rectangular	tube	cap			10-105				
Reduced	blind rivet	nut			3-134 , 3-135				
			countersunk	hexagon shank		3-135 , 3-136			
Reducer					3-48				
Refrigeration	pipe	clamp	Fischer		10-38				
Releasable	locking	cable	tie	MaxxFast	12-126				
			with mount		12-127				
Remform	mushroom head	screw	metric cross thread	recessed forming head	6-71				
			raised	screw	metric cross thread	6-70			
			cheese	recessed forming head					
			head						
Repair	kit	Amecoil			3-153				
		metric	V-Coil		3-160				
		non-metric	V-Coil		3-161 , 3-162				
		spark plug	V-Coil		3-162				
		washer	Mudwing		7-44 , 7-45				
Retaining	clip				7-131				
		ring	Dubo		7-110 , 7-111				
			for bore		7-124				
		for shaft		7-121					
	washer			10-77 , 12-144					
		for shaft		7-125 , 7-126					
Retaining	conical				10-80				
spring									
Reverse	grooved	pin			9-20				
Revolvable	handle	metric			12-94 , 12-95				
Ring					13-131/13-133				

Ring	adjusting	7-134, 7-135, 7-136		
	bonded seal	7-150		
		with rubber	6-117, 7-150	
	clamp	adjusting	7-132, 7-133	
	lifting	13-111/13-113		
	nail	13-133		
	packing	fiber	7-149	
	pin	13-68		
	retaining	Dubo	7-110, 7-111	
		for bore	7-124	
		for shaft	7-121	
	rosette	10-97/10-99, 12-143, 12-144		
	sealing	7-146/7-148, 10-79		
		FESTAPLAN	7-148, 7-149	
		with elastomer sealing	6-116	
	shim	7-138, 7-139, 7-140		
	snap	for shaft	7-127	
	welded	for safety swing hooks	5-41	
	Ripp	cheese screw with metric self locking	2-63	
		head flange hexagon socket		
hexagon bolt with metric self locking		1-62, 1-63		
nut with flange self locking		3-74		
Rivet	countersunk drive	9-34, 9-35, 9-36, 12-136		
	expanding blind with yellow cap	9-69		
	push	12-139		
	ratched	12-138		
	round head	9-32, 9-33, 9-34		
	screw	12-137		
	spring plate	10-80		
	Rivet bush round metric	3-96		
	Robust hose clamp ABA	12-14, 12-15		
	Rod	anchor metric	8-82	
chemical fixing Fischer		8-81		
		MaxxFast	8-80	
		Spit	8-83	
threaded BSW		4-20		
		ISO metric	4-5, 4-7	
		metric	4-3/4-12	
			left hand	4-5, 4-6, 4-8, 4-9
			Permaglas	4-21
		metric ASTM A193	4-38	
		metric fine	4-13	
		metric oversized	4-5, 4-7, 4-10, 4-11	
		Tr	4-24, 4-25	
			left hand	4-24
		UNC	4-14, 4-15, 4-16, 4-17	
			ASTM A193	4-37
	UNF	4-18, 4-19		
Roofing and bolt cladding	with elastomer sealing	6-112		
		SFS-Topform	6-111	
	with elasto-mer sealing	SFS-Topform	6-112	
	without point			
	cone point screw	6-113		
	flat point screw	6-114		

screw	cone	6-113		
	flat	6-112		
self drilling bolt	with elastomer sealing	6-115		
Rope clip	cross wire	13-78		
Rope shortener	13-35			
Rosette	ring	10-97/10-99, 12-143, 12-144		
Round	connection metric	3-124, 3-125		
	nut			
		metric for hook spanners	3-123	
		metric slotted	3-123, 3-124	
		metric with self locking	3-126	
		non metallic		
		insert		
		Tr	4-25, 4-26, 4-27	
			left hand	4-26
	rivet bush	metric	3-96	
tube	cap	10-104		
Round head	anchoring concrete Powers	8-63		
	screw			
		Powers	8-58	
	grooved	pin	9-22	
	rivet	9-32, 9-33, 9-34		
	screw	metric slotted	6-31	
	security	square socket drive	10-126, 10-127	
	wood screw			
	wood screw	cross recessed head	6-189	
		slotted	6-182, 6-183, 6-184	
Run clip	cable	10-59		

S

S-	hook	5-42		
Saddle	Fischer	10-35		
	flange Fischer	10-46		
SAE washer	plain	7-12, 7-13		
Safety	swing hook	metric	5-41	
		non-metric	5-40	
	washer	7-106		
S-box	assortment accessories	11-24		
Screw	adjustable Fischer	8-42		
	back panel	cross recessed head	6-107, 6-139	
	binder	metric	10-104	
	blind rivet	cylindrical	3-139	
	book	10-102, 10-103		
		elongation piece	10-103	
	button head	metric double slotted	6-55, 6-56	
		metric double slotted and hexagon nut	6-56	
		metric hexagon socket	2-51/2-53, 10-95	
		metric hexalobular	2-54, 2-55	
		metric slotted	6-32, 6-33	
		UNC hexagon socket	2-56, 2-57	
		UNF hexagon socket	2-58, 2-59	
	capstan	metric	6-33	
	cheese head	BSW hexagon socket	2-32	
		metric	2-18, 2-19	
	metric fine hexagon socket	2-20		
	metric fully threaded	2-17, 2-18, 2-19		
	metric hexagon socket	2-2/2-15		
	metric hexalobular	2-16, 6-43		
	metric slotted	6-10/6-15		
	UNC	2-26		

Alphabetical Index

Screw	cheese head	hexagon socket	2-21, 2-22, 2-25, 2-27	license plate	cross recessed head	6-107, 6-108
		UNF hexagon socket	2-29, 2-30, 2-31		slotted	6-109
	combi	metric slotted	6-35	low head	metric hexagon socket	2-33/2-38
	cone point	roofing and cladding	6-113	cap		
	counter-sunk	BSW hexagon socket	2-50	mushroom head	metric cross thread forming head	6-71
			slotted	6-27		SR recess self drilling
		cross recess self drilling and wings	6-145	pan head	cross self drilling MaxxFast	6-119, 6-120
		cross self drilling MaxxFast	6-130, 6-131		recessed for thermo plastics	6-72
		recessed			metric cross recessed head	6-78/6-83
		cross self drilling	6-132, 6-133		metric cross recessed head without point	6-83
		recessed head			metric hexalobular	6-84, 6-85
		for thermo plastics	6-72		metric large head	6-20
		metric	6-49, 6-50		metric slotted	6-16, 6-17, 6-18, 6-73, 6-74
		thread rolling	6-68		metric slotted without point	6-74
		metric cross recessed head	6-44/6-48		metric small head	6-19
		thread cutting	6-59		self drilling cross recessed head	6-122, 6-123, 6-124
		metric hexagon socket	2-39/2-44		square socket drive	6-130
		metric hexalobular	2-44, 2-45, 6-49		SR	6-129
		thread rolling	6-68		square self drilling MaxxFast	6-128
		metric slotted	6-21/6-26		socket	
		metric Torx® thread TAPTITE forming 2000®	6-64		tmap® self drilling MaxxFast	6-126, 6-127
		Torx® self drilling	6-143	raised cheese head	metric cross recessed head	6-36, 6-37, 6-38, 6-39, 6-40
		tmap® MaxxFast	6-151, 6-152, 6-176		thread cutting	6-57
		self drilling MaxxFast	6-134, 6-135, 6-141		thread forming	6-70
		UNC hexagon socket	2-46, 2-47		metric hexalobular	6-41, 6-42
		hexalobular thread cutting	6-61		metric thread rolling	6-66
		Torx® self drilling	6-144		raised cheese head	
		UNF hexagon socket	2-49, 2-50		metric Torx® thread forming	6-71
		wings and Torx®	6-142		TAPTITE 2000®	6-65
	dowel		13-76		metric with thread rolling small head	6-67
		metric	5-36/5-39	raised counter-sunk head	metric	6-102, 6-103
	drive		9-23		metric cross recessed head	6-51/6-53, 6-94/6-97
	driver bit	pneumatic self drilling unit	6-146		thread cutting	6-58
		screwdriver self drilling	6-146		metric hexalobular	6-54, 6-55
		setting tool self drilling	6-146		metric slotted	6-28/6-30, 6-76/6-77
		socket self drilling	6-147	rivet		12-137
	dry wall	cross recessed head	6-198, 6-199	roofing and cladding	cone	6-113
	eye	metric	5-28		flat	6-112
		non-metric	5-30, 5-31, 5-32	round head	metric slotted	6-31
	flange head	tmap® timber MaxxFast	6-177	seating	metric	1-82, 1-83
	flat	metric hexagon socket	10-95	shoulder	metric hexagon socket	2-64, 2-65, 2-68
	flat point	roofing and cladding	6-114		UNC	2-67
	hexagon	BSF	1-61		hexagon socket	2-66, 2-67
		BSW	1-60	socket	cylindrical pipe thread	2-98
		ISO metric	1-24		with collar	2-97, 2-98
		metric	1-20/1-36		external taper pipe thread	2-93
		thread cutting	6-60		metric fine collar	2-96
		metric fine	1-39, 1-40, 1-41			
		metric for pressure vessels	1-27			
		metric oversized	1-25			
		metric slotted	1-35			
		metric with small hexagon and dog point	1-86			
	insert		10-88			
		hexagon socket	10-89, 10-90, 10-91			
		socket slotted	10-90			

Screw	socket	metric fine hexagon socket			2-94		
		metric fine with collar			2-96		
		pipe thread with collar			2-95		
	terrace	hexalobular			6-165		
	thumb	metric			6-203		
	window					6-104, 6-105, 6-106	
		frame	Fischer			8-41	
			MaxxFast			8-40	
	wing	metric light (American) type			6-208		
		metric rounded wings			6-209, 6-210		
metric with threaded end				12-88			
Screw for chipboard	counter-sunk	cross recessed head			6-154, 6-155, 6-156		
			Heco-Fix			6-155	
			Heco-Topix			6-157	
			Heco-Unix Plus			6-157	
			hole			6-158	
			small head			6-159	
		hexalobular			6-159, 6-160, 6-161		
			Heco-Topix			6-160, 6-162	
			Heco-Unix Top			6-160	
	raised cheese head	cross recessed head			6-168, 6-169		
			Heco-Fix			6-169	
			hexalobular			6-170	
	raised counter-sunk head	cross recessed head			6-172		
			Heco-Fix			6-171	
	Screw with flange	button head	metric hexagon socket			2-59, 2-60, 2-61	
metric hexalobular					2-62		
cheese head		metric	self locking	Ripp	2-63		
		hexagon socket					
		hexagon	metric	thread forming	TAPTITE 2000®	6-63	
			self drilling			6-137, 6-138	
Screwdriver flexible		socket	ABA			12-23	
			MaxxFast			12-23	
Sealing ring		cap			12-40		
					7-146/7-148, 10-79		
	FESTAPLAN				7-148, 7-149		
	with elastomer sealing			6-116			
	washer			12-41			
Seating screw	metric			1-82, 1-83			
Securit hexagon nut	metric all metal	self locking			3-74		
Security plug	hexagon			10-127			
	hexalobular			10-128			
	wire			13-66			
Security nut	metric			10-108			
	shear	metric			10-109		
Security screw	button head	metric hexagon socket with pin			10-110		
		metric hexagon socket with plug			10-111		
		metric hexalobular with pin			10-112		
	self tapping			10-117, 10-118			
	cheese head	self tapping	with 2 holes			10-120	
counter-sunk	metric			10-114, 10-115			
		metric with 2 holes			10-116		
		self tapping			10-122/10-124		
	mushroom head	self tapping	Tri-wing			10-122	
		one way	self tapping			10-121	
			Pan head			10-121	
	pan head	metric			10-113		
		metric with 2 holes			10-113		
		self tapping			10-119		
	raised counter-sunk head	self tapping	one way			10-126	
	self tapping	with 2 holes			10-125		
Security round head	square socket drive			10-126, 10-127			
wood screw							
Seha wing	neck bolt	metric with hexagon nut			1-80		
Self adhesive bumper					12-142		
	locking	cable tie			12-132, 12-133		
Self adjusting clamp	Lindapter			10-28			
Self cutting threaded	insert			3-172, 3-173, 3-174			
				3-174, 3-175			
				3-176, 3-177			
Self drilling anchor	for plasterboard			8-19			
		counter-sunk	screw	cross recess and wings	6-145		
			cross	MaxxFast	6-130, 6-131		
			recessed				
			cross recessed head			6-132, 6-133	
			Torx®			6-143	
			UNC	Torx®			6-144
			wings and Torx®			6-142	
		ttap®	screw	MaxxFast			6-134, 6-135, 6-141
	hexagon	screw with flange			6-137, 6-138		
tapping		MaxxFast			6-135, 6-136		
	screw						
mushroom head	screw	SR recess			6-140		
pan head	cross recessed	screw	MaxxFast			6-120	
		screw	cross	MaxxFast			6-119
		recessed					
		cross recessed head			6-122, 6-123, 6-124		
		square socket drive			6-130		
		SR			6-129		
		square socket	screw	MaxxFast			6-128
		ttap®	screw	MaxxFast			6-126, 6-127
	roofing and cladding	bolt	with elastomer sealing			6-115	
	screw	driver bit	pneumatic unit			6-146	
screwdriver					6-146		
setting tool					6-146		
socket					6-147		
Self locking cheese head	screw with flange	metric	Ripp			2-63	
		hexagon socket					
exhaust	nut			3-42			

Alphabetical Index

Self locking	hexagon	bolt with flange	metric	1-64, 1-65		
			Ripp	1-62, 1-63		
	domed cap nut	metric with non metallic insert		3-102, 3-103		
			flange nut	3-81		
	nut	BSF	non metallic insert		3-63	
				BSW	non metallic insert	3-63
						metric
		metric all aluminium	Snep		3-72	
				metric all metal	3-66, 3-73	
		metric all stainless steel	Snep	Securit	3-74	
				Snep	3-71, 3-72	
				Stover	3-65, 3-66	
		metric fine all metal	Snep		3-67	
				metric fine non metallic insert	3-39, 3-52, 3-53	
	metric with captive serrated lock washer	metric with non metallic insert	UNC	all metal	3-68, 3-69	
				non metallic insert	3-55/3-61	
		UNC	all metal		3-70	
				non metallic insert	3-58, 3-59, 3-61, 3-62	
		with flange	Ripp		3-74	
				nut with flange	3-80	
		round	nut	metric with non metallic insert		3-126
		Self tapping	button head	security screw		10-117, 10-118
					cheese head	10-120
	counter-sunk		security screw		10-122, 10-123, 10-124	
				mushroom head	10-122	
	one way		security screw		10-121	
				Pan head	10-121	
	pan head		security screw		10-119	
	raised counter-sunk head		security screw	one way	10-126	
	raised head		security screw	with 2 holes	10-125	
	threaded		insert tool	hexagon socket	3-178	
Serrated	collar ring lock washer		Dubo		7-112	
				countersunk	7-69	
				internal/external	7-69	
Serrated lock washer	domed			7-67		
Set screw	cone point		metric hexagon socket	2-83, 2-84		
		metric slotted	6-6, 6-7			
cup point	BSW	hexagon socket		2-90		
			metric	2-76		
			metric fine	2-72		
			metric hexagon socket	2-69, 2-70, 2-71		
			metric slotted	6-7, 6-8		
	UNC	hexagon socket		2-73, 2-74		
			dog point	2-87, 6-9		
	metric hexagon socket		2-86, 2-87, 2-89			
		flat point	metric fine	2-81		
	metric hexagon socket		2-79, 2-80			
metric slotted			6-4, 6-5			
UNC		hexagon socket	2-77, 2-82, 2-85, 2-88			
UNF	hexagon socket		2-75, 2-76, 2-78			
		oval point	UNC	hexagon socket	2-90	
shank	metric slotted		6-8			
Setting tool	Fischer		8-55, 8-83			
		MaxxFast	8-55			
		Spit	8-56			
SFS-Top-form	roofing and cladding	bolt with elastomer sealing		6-111		
			with elastomer sealing without point	6-112		
		Shackle		13-12		
bow		13-9				
	with screw collar pin	5-22, 5-23				
D		5-20, 5-21, 13-5/13-11				
swivel	snap		13-26, 13-27			
		Shaft	long fixing Fischer	8-32, 8-33		
Shank	set screw	metric slotted	6-8			
Shear	security nut	metric	10-109			
Shield	expansion	anchor	Rawlplug	8-45, 8-47, 8-48		
			metric with conical nut	8-46		
Shim	ring		7-138, 7-139, 7-140			
S-hook			13-119			
Short cord	hook		13-123			
Short	carriage	bolt	metric	1-80		
square						
Shoulder	screw	metric hexagon socket		2-64, 2-65, 2-68		
			UNC	2-67		
Shoulder screw	pan head	metric slotted		2-66, 2-67		
				6-34		
Shuttering	threaded rod	knuckle thread		8-95		
Single	cardan	joint		12-48		
			spring	cotter of a bolt	9-42	
Ski tow	transom mount		13-125			
Sleeve	anchor	Fischer		8-50		
		nail	Fischer	8-27		
		nut	metric	10-100		
Slide	bearing		12-146			
Sliding	nut	Fischer		10-42		
Slip hook			13-38			
Slip-on	spring	receptacle		10-82		
Small head	counter-sunk	screw for chipboard	cross recessed head		6-159	
Snap	cap			6-202		
		clip		10-58		
		hook		5-26		

Snap	ring	for shaft			7-127			
	swivel	shackle			13-26, 13-27			
Sneq	hexagon	nut	metric all	self locking	3-72			
			aluminium					
			metric all	self locking	3-71, 3-72			
			metal					
Socket	corner	connector	metric all	self locking	3-71			
			aluminium					
			metric all	self locking	3-71			
			metal					
Socket	flexible	screwdriver	hexagon socket		10-96			
			ABA		12-23			
			MaxxFast		12-23			
			insert	screw	slotted	10-90		
			plug	metric fine	hexagon socket	2-92		
			screw	cylindrical	pipe thread			2-98
						with collar		2-97, 2-98
						external taper	pipe thread	2-93
						metric fine	collar	2-96
						metric fine	hexagon socket	2-94
			screw	metric	pipe thread	with collar		2-95
						with collar		2-95
with collar		2-95						
tapping	metric			6-101				
screw								
Solid	handwheel				12-107			
		foldaway			12-108, 12-109			
Spacer					3-46, 12-135, 12-147			
	with 2x	internal thread			3-47			
Spare	pin				3-178			
threaded								
Spark plug	repair	kit	V-Coil		3-162			
Speed	nut				3-120			
Spherical	bearing	plain	external thread		12-52			
			left hand		12-52			
			plain	internal thread	12-51			
			left hand		12-51			
			washer	conical		10-10		
			spherical			10-9, 10-10		
Spindle	GMT				12-71			
Spinner	handle				12-93			
Spit	chemical	anchor	capsule		8-85			
		rod	fixing		8-83			
	hammer-in	anchor			8-26			
	setting	tool			8-56			
	through bolt	anchor			8-71			
Split	pin				9-38/9-41			
Spot weld	nut	metric			3-111			
Spring	bracket				10-82			
		conical	washer		7-89, 7-90			
	cotter of a	double			9-43, 9-44			
	bolt					9-42		
		single				9-42		
	cotter pin				13-67			
	disc					7-86, 7-88		
		for ball bearing	location			7-92		
		for critical	application			7-83/7-85, 7-91		
	helical	compression				12-74		
tension		with English eye			12-75			
hook					13-14/13-34			
	double locking				13-25			
lock washer					7-58			
	square ends				7-50/7-52, 7-57, 7-58			
locking	disc				7-93, 7-94, 7-104, 7-105			
plunger	metric	with ball			12-56			
		with pin			12-57, 12-58			
		with plastic pin			12-59			
		smooth			12-59			
slip-on	receptacle				10-82			
straight pin					9-24/9-30			
welding	plate				10-81			
Spring lock	helical extra	square ends			7-56, 7-57			
washer	duty				7-55, 7-56			
		helical heavy			7-55, 7-56			
		helical high collar			7-59			
		helical	square ends		7-53, 7-54			
regular								
Spring plate	rivet				10-80			
Spring	conical				7-61			
washer	contact				7-82			
		curved			7-63/7-66			
		double			7-60			
		wave			7-62			
		hammer-in	cap	GMT		12-69		
nut	metric				3-117, 3-118			
		thin			3-116, 3-117			
		taper	washer	for I-section	7-142, 7-143			
		Peiner		1-93				
		for U-section		7-144, 7-145				
		Peiner		1-93				
trackshoe	nut	UNF			3-42			
tube	cap				10-105			
washer					7-141, 7-142			
weld nut	metric				3-112			
Square	bolt	metric	with short dog point		1-84			
		UNC	short dog point		1-85			
Square	hook	non-metric			5-34			
hook		non-metric	cross recessed head		5-35			
	pin	metric			5-29			
		non-metric			5-35			
Square neck	flat counter-	metric	with long square		1-82			
		sunk	hexagon nut					
bolt	pan head	screw	self drilling	MaxxFast	6-128			
		socket						
Staged	tap	metric fine	Amecoil		3-144			
		for wire	thread insert					
Star	knob	metric			12-78, 12-79			
Stay	adjuster				13-50, 13-51			
Steel pin					13-64, 13-65			
Steelwork	fixing	Lindapter			10-20/10-23			
Stover	hexagon	nut	metric all	self locking	3-65, 3-66			
			metal					
Straight pin	spring				9-24/9-30			
Strike					10-63, 10-64			
Structural	hexagon	metric	with hexagon nut		1-94/1-97			
			assembly					
set								

Alphabetical Index

Structural bolt	high strength	metric	Peiner	1-89
Stud	ball			10-76
	bolt	welding		10-128
	double end	metric with reduced shank		4-61, 4-62
	slotted			10-75
Studbolt				13-44, 13-45, 13-46
	BSW			4-33
	metric			4-27/4-34
	metric for T-slot			10-11
	metric with 2 hexagon nuts			4-55
	slotted			10-76
	UNC	with 2 hexagon nuts		4-39/4-53
	wing head			10-75
Support	flexible	machine		12-72
	glide			12-141
Swaging die	hand swager			13-62
Swing hook	safety	metric		5-41
		non-metric		5-40
Swivel				13-29, 13-30
	hasp			13-106/13-108
	snap	shackle		13-26, 13-27
System	multiple	connector		12-53
T	grip	metric brass threaded bush		12-89
		metric with steel zinc plated threaded rod		12-89

T

Tab	washer			7-113/7-118
Tail clamp	adjustable	Lindapter		10-29
Tang	break	Amecoil		3-159
Tap	machine	metric fine	Amecoil	3-144
		for wire		
		thread insert		
		metric for	Amecoil	3-143
		wire thread		
		insert		
		UNC	for wire	Amecoil
			thread	
			insert	
		UNF	for wire	Amecoil
			thread	
			insert	
	staged	metric fine	Amecoil	3-144
		for wire		
		thread insert		
Taper	grooved	pin		9-15, 9-16, 9-17
	key			9-52
	pin			9-3, 9-4
		external thread		9-11
		internal thread		9-12
	square	washer	for I-section	7-142, 7-143
			Peiner	1-93
			for U-section	7-144, 7-145
			Peiner	1-93
Tapping screw	caphead	metric cross recessed head		6-108
		metric Torx®		6-109
	counter-sunk	metric cross recessed head		6-87/6-90
		metric hexalobular		6-91, 6-92
		metric slotted		6-75
		metric with square recessed head		6-93

hexagon				6-98, 6-99, 6-100
		metric washer faced		6-100
		self drilling	MaxxFast	6-135, 6-136
		without point		6-99
mushroom head		metric cross recessed head		6-103
pan head		metric with square recessed head		6-86
socket		metric		6-101
TAPTITE 2000®	counter-sunk	screw	metric thread	6-64
			Torx® forming	
	hexagon	screw with	metric thread	6-63
		flange	forming	
	raised	screw	metric thread	6-65
	cheese		Torx® forming	
	head			
T-bolt	assortment	for T-Slot		10-12, 10-13
Technical	ball			12-111/12-114
Tension	helical	spring	with English eye	12-75
	lever	liftable		12-98
			with threaded rod	12-98
Terminal				13-71/13-74
	head			13-75
	quick attach			13-53, 13-54
Terrace	screw	hexalobular		6-165
T-head	bolt	Fischer		10-41, 10-44
		metric		5-3
		square ends		5-2
Thimble				5-27
	wire			13-57, 13-58
Thin	castle	nut	metric	3-89
			metric fine	3-91
	hexagon	nut	ISO metric	3-33, 3-39
			metric	3-32, 3-33, 3-34
			metric fine	3-35, 3-36, 3-37
			metric fine left hand	3-36, 3-37
			metric left hand	3-33, 3-34
			metric oversized	3-33
	knurled	knob	metric for hexagon bolt, screw and nut	12-84
		nut	metric	3-114, 3-115
		thumb	metric	6-206, 6-207
		screw		
	square	nut	metric	3-116, 3-117
	trackshoe	nut	UNF	3-42
Thread cutting	counter-sunk	screw	metric cross recessed head	6-59
			UNC hexalobular	6-61
	hexagon	screw	metric	6-60
	raised	screw	metric cross recessed head	6-57
	cheese		head	
	head			
	raised	screw	metric cross recessed head	6-58
	counter-sunk		head	
	head			
Thread forming	counter-sunk	screw	metric TAPTITE 2000®	6-64
	hexagon	screw with	metric TAPTITE 2000®	6-63
		flange		
	mushroom head	screw	metric cross recessed head	6-71
			Remform	

Thread forming	raised cheese head	screw	metric cross Remform	6-70	horizontal clamp	AMF	12-160			
			recessed head		vertical clamp	AMF	12-161			
			metric Torx®		horizontal clamp	AMF	12-153, 12-154, 12-155			
			TAPTITE 2000®	6-65						
Thread rolling	counter-sunk	screw	metric	6-68	latch		10-61, 10-62			
			metric hexalobular	6-68	nut		3-107			
	raised cheese head	screw	metric raised cheese head	6-66	plug	Fischer	8-25			
			metric with small head	6-67	push-pull	clamp AMF	12-156/12-158			
Threaded	insert	self cutting		3-172, 3-173, 3-174	vertical clamp	AMF	12-151, 12-152			
			hexagon socket	3-174, 3-175	with eye		13-50			
	insert tool	self cutting		3-176, 3-177	Tool	blind rivet		9-81		
			self tapping hexagon socket	3-178	hand pliers		9-80			
	rod	BSW		4-20	nut		3-140			
			ISO metric	4-5, 4-7	pneumatic		9-80			
		metric		4-3/4-12	bolt	anchor	Fischer	8-78		
			left hand	4-5, 4-6, 4-8, 4-9	cavity	fixing	Fischer	8-17		
			Permaglas	4-21			MaxxFast	8-17		
		metric ASTM A193		4-38	fixing washer		7-129			
		metric fine		4-13	handle		7-129			
		metric oversized		4-5, 4-7, 4-10, 4-11	handle, magnetic		7-129			
		Tr			4-24, 4-25	injection	Fischer	8-87		
			left hand		4-24	MaxxFast		8-87		
	UNC			4-14, 4-15, 4-16, 4-17	installation	Fischer	8-24			
		ASTM A193		4-37	setting	Fischer	8-55, 8-83			
UNF			4-18, 4-19	MaxxFast		8-55				
Threaded rod	shuttering clip	knuckle thread		8-95	Spit		8-56			
				8-95	wire thread insert	V-Coil	3-166/3-170			
Three part	clip			10-85	Tr	round nut	4-25, 4-26, 4-27			
Through bolt anchor			Fischer	8-68, 8-69, 8-70	threaded rod		4-24, 4-25			
			MaxxFast	8-66, 8-67	left hand		4-24			
			Spit	8-71						
Thumb screw	screw	metric		6-203	Trackshoe	bolt	Caterpillar	1-87		
Thumb screw	knurled	metric	high	6-204, 6-205	hexagon nut	parallel thread	3-41			
			thin	6-206, 6-207	nut	UNF	high	3-41		
			metric high	6-205			square	3-42		
			metric slotted		6-205			thin	3-42	
Tie	cable	locking		12-131	Trailer	hook	13-3			
				12-134	with swivel		13-3			
	hand pliers	cable	MaxxFast		12-129	Transom	ski tow	13-125		
					12-121	mount		13-125		
	locking	cable		assortment	12-124	Triangular star	knob	with threaded bush	12-82, 12-83	
				MaxxFast	12-120, 12-121, 12-122			with threaded rod	12-82	
				mount	12-128	Ttap®	counter-sunk	decking screw	MaxxFast	6-164
				MaxxFast	12-120, 12-121, 12-122			screw	MaxxFast	6-151, 6-152, 6-176
					12-128			self drilling	MaxxFast	6-134, 6-135, 6-141
				releasable	MaxxFast	12-126		flange head	screw timber	MaxxFast
self adhesive					12-132, 12-133		pan head	screw self drilling	MaxxFast	6-126, 6-127
Ty-Rap					12-123		raised cheese head	woodscrew	MaxxFast	6-167, 6-168
with eye		12-124		T-terminal		13-47				
with label		12-125, 12-126		Tube	cap	conical	10-106			
with mount releasable		12-127				rectangular	10-105			
Toggle				13-48, 13-49		round	10-104			
hook	clamp	AMF		12-159			square	10-105		
				12-159	insert	Vemo		8-98, 8-99		
				12-159		with nailing plate	Vemo	8-98, 8-100		

Alphabetical Index

Tube	insulating			12-148	
Turnbuckle				13-37/13-43	
nut	metric			5-15	
		metric hexagon		5-13	
		metric made from tubes		5-13	
		metric with hook and eye		5-15, 5-16	
		metric with two eyes		5-16, 5-17	
		metric with two flat eyes		5-19	
		metric with two hooks		5-18	
		metric with two studs		5-14	
rail			13-69		
Turning	knob	through hole		12-79	
		with threaded bush		12-79, 12-80	
		with threaded rod		12-80	
Two	ear clip	ABA		12-17	
Two parts	pipe clamp	Fischer		10-37	
Ty-Rap	locking cable	tie		12-123	
U					
U-bolt	type A metric			12-30	
	type B metric			12-31, 12-32	
UNC	button head screw	hexagon socket		2-56, 2-57	
		carriage bolt		1-77, 1-78, 1-79	
	cheese head	screw		2-26	
		hexagon socket		2-21, 2-22, 2-25, 2-27	
	counter-sunk	screw	hexagon socket		2-46, 2-47
			hexalobular thread cutting		6-61
			Torx® self drilling		6-144
	hexagon	bolt			1-41/1-50
			nut		3-20, 3-21, 3-22, 3-23, 3-57
			all metal self locking		
ASTM A194					4-57, 4-58, 4-59
non metallic self locking insert					3-55/3-61
nut with flange		with flange self locking		3-80	
insert	wire thread Amecoil		3-148		
jamnut			3-40		
machine	tap	for wire thread insert		3-145	
		cup point hexagon socket		2-73, 2-74	
set screw	flat point hexagon socket			2-77, 2-82, 2-85, 2-88	
				2-90	
		oval point hexagon socket		2-67	
shoulder	screw	hexagon socket		2-66, 2-67	
		bolt short dog point		1-85	
head					
studbolt	with 2 hexagon nuts			4-39/4-53	
threaded	rod			4-14, 4-15, 4-16, 4-17	
				4-37	
		ASTM A193		4-37	
		workshop kit Amecoil		3-151	
UNF	button head screw	hexagon socket		2-58, 2-59	
		castle nut		3-92	
	cheese head	screw hexagon socket			2-29, 2-30, 2-31
			conical lubricating nipple		12-46

counter-sunk	screw	hexagon socket		2-49, 2-50	
hexagon	bolt			1-52, 1-53, 1-54, 1-56, 1-57	
		nut		3-24, 3-25, 3-26, 3-58	
		all metal self locking		3-70	
		non metallic self locking insert		3-58, 3-59, 3-61, 3-62	
insert	wire thread Amecoil			3-149	
machine	tap	for wire thread insert		3-145	
		hexagon socket		2-75, 2-76, 2-78	
threaded	rod			4-18, 4-19	
trackshoe	nut	high		3-41	
		square		3-42	
		thin		3-42	
workshop	kit Amecoil			3-152	
USS	washer	plain		7-10	
V					
V-Coil	assortment	metric		3-163, 3-164	
		non-metric		3-164, 3-165	
	repair	kit	metric		3-160
			non-metric		3-161, 3-162
	tool	wire thread insert			3-166/3-170
Vemo	bar	connector		8-97	
	bush			8-97	
	pipe	plug		8-101	
	tube	insert			8-98, 8-99
			with nailing plate		8-98, 8-100
Vertical	toggle clamp	AMF		12-151, 12-152	
Vertical	hook toggle	AMF		12-161	
clamp					
Vibration	isolator	metric		12-65/12-69	
	proof washer	Nord-Lock		7-96/7-103	
Vibration isolator	cylindrical	metric		12-62, 12-63, 12-64	
W					
Wall	bracket			13-79	
Wall bracket	ground plate			13-80	
Wallplug				8-5	
	assortment box	Fischer		8-8	
	Fischer			8-7, 8-9, 8-11	
	MaxxFast			8-4, 8-10, 8-12, 8-28	
Washer	channel	Fischer		10-43	
	conical	spring		7-89, 7-90	
	cupped	for seating screw		1-83	
	deep	Lindapter		10-27	
	flat				7-47, 7-48, 7-49
		for cars	fiber		7-150
	for steel structures			7-22, 7-23	
	for wood constructions			7-43	
	hardened			10-11	
	locking	edge		7-66	
	Peiner			1-92	
	plain			7-57/7-40	
		Permaglas		4-23	
plain for cheese head screw			7-25, 7-26		
plain for clevis pin			7-27, 7-28, 7-29		
plain for wood construction			7-40, 7-41, 7-42		

Washer	plain with heavy type spring pin				7-23 , 7-24
	plain with single chamfer				7-33 , 7-34
	protective				10-79
	repair	Mudwing			7-44 , 7-45
	retaining				10-77 , 12-144
		for shaft			7-125 , 7-126
	SAE	plain			7-12 , 7-13
	safety				7-106
	sealing				12-41
	spherical				10-9 , 10-10
		conical			10-10
	square				7-141 , 7-142
		taper	for I-section		7-142 , 7-143
			Peiner		1-93
			for U-section		7-144 , 7-145
			Peiner		1-93
	tab				7-113/7-118
	USS	plain			7-10
	vibration	proof	Nord-Lock		7-96/7-103
	with shoulder				12-145
	Wave	spring washer			7-62
	Weld	nut	metric with smooth flange		3-110
	Weld nut	hexagon	metric		3-109
square		metric		3-112	
Welded	ring	for safety swing hooks		5-41	
Welding	hinge			12-54	
	spring	plate		10-81	
	stud	bolt		10-128	
Wheel	hexagon	nut	with flange Nord-Lock	3-83	
Window	frame	screw	Fischer	8-41	
			MaxxFast	8-40	
	screw			6-104 , 6-105 , 6-106	
Wing	grip	metric		12-87	
			neck bolt	metric with Seha	1-80
		hexagon			
		nut			
	nut	BSW			3-106
			metric		3-108
			metric light (American) type		3-103 , 3-104
			metric rounded wings		3-104 , 3-105
			metric with threaded bush		12-88
	nut with collar	metric			3-108
screw			metric light (American) type	6-208	
metric rounded wings				6-209 , 6-210	
	metric with threaded end		12-88		
Wire	cross	rope clip		13-78	
	o-ring			7-157	
	security			13-66	
	thimble			13-57 , 13-58	
Wire rope				13-55	
	clip			5-24 , 5-25 , 13-59	
	cutter			13-56	
Wire thread	insert	metric	Amecoil	3-146	
		metric extra	Amecoil	3-147	
		fine			
		metric	Amecoil		3-148
		extra fine for			
		spark plugs			
		metric fine	Amecoil		3-147
		metric self	Amecoil		3-146
		locking			
	UNC	Amecoil		3-148	
	UNF	Amecoil		3-149	
tool	insert	V-Coil		3-166/3-170	
Wood screw	counter-sunk	cross	MaxxFast	6-149 , 6-150	
		recessed			
		cross recessed head			6-187 , 6-188 , 6-190
		hexalobular			6-163 , 6-178 , 6-179
	slotted			6-179/6-181 , 6-185 , 6-186	
hexagon				6-173 , 6-174	
	with bitumen washer			6-176	
	with stainless steel lead bitumen washer			6-174 , 6-175	
pan head	cross recessed head			6-193 , 6-194	
	hexalobular			6-171 , 6-195/6-197	
raised	cross recessed head			6-191 , 6-192	
counter-sunk head					
round head	cross recessed head			6-189	
	slotted			6-182 , 6-183 , 6-184	
Woodruff	key			9-51 , 9-52	
Woodscrew	raised	cross	MaxxFast	6-165 , 6-166	
		recessed			
	head	ttap®	MaxxFast		6-167 , 6-168
Workshop	kit	BSW	Amecoil	3-152	
		metric	Amecoil	3-149	
		metric extra	Amecoil	3-150 , 3-151	
		fine			
		metric fine	Amecoil		3-150
		UNC	Amecoil		3-151
	UNF	Amecoil		3-152	

Norm Index

ASME

B16.5	4-39	≈4168-5	2-72, 2-76	404	6-33	≈608	1-80
B18.16.6	3-55, 3-57, 3-58, 3-59, 3-60, 3-61	-/4168-5	7-134	417	6-9	609	1-71
≈B18.17	3-103	≈4168-6	2-51, 2-54	427	6-8	648 A	12-52
≈B18.2.1	1-41, 1-52	≈4168-7	2-64, 2-68	431 A	3-40	648 B	12-50
B18.2.2	4-57	4168-8	2-39	432	7-117	653	6-206
≈B18.2.2	3-20, 3-23, 3-26, 3-40	≈4168-8	2-39	433	7-25	660/124	9-32
B18.2.3.1M	1-2, 1-19	4174	6-73, 6-75, 6-76, 6-98	≈433	7-25	661/302	9-34
≈B18.2.3.1M	1-2, 1-19, 1-35	4183	6-10, 6-16, 6-21, 6-28	434	7-145	≈705A/ISO 4027	7-134
≈B18.2.3.4M	1-66, 1-67, 1-69, 1-70	4183≈	6-10, 6-16, 6-21	≈434	7-145	705A/ISO 4027	7-137
B18.2.4.5M	3-32, 3-35	4219	6-6	435	7-143	(DIN 914)	
B18.21.1	7-9, 7-12, 7-53, 7-55, 7-57, 7-59, 7-69, 7-70, 7-74, 7-76	4235-1	9-47, 9-52	≈435	7-143	705A/ISO 4029	7-134
≈B18.21.1	7-36, 7-37, 7-46	4235-2	9-51	436	7-142	705A/EN 27434	7-134
B18.3	2-66	4278	5-7	≈436	7-142	≈705A/EN 27434	7-134
≈B18.3 (1936)	2-22, 2-28	4464 A	7-58	438	6-7	741/555 (1987)	5-24
≈B18.3 (1960)	2-21	≈4464 A	7-58	439 B (1987)	3-32, 3-35	787	10-4
B18.3.1M	2-2, 2-20	4464 B	7-49	440 R	7-40	808 E	12-48
≈B18.3.1M	2-2, 2-17	≈4464 B	7-49	≈440R	7-40	808 D	12-49
≈B18.3.3M	2-64, 2-68	4620	9-32, 9-34	440V	7-42	835	4-34
≈B18.3.4M	2-51, 2-54	4882	4-39	≈443	12-40	906	2-92, 2-93
B18.3.6M	2-69, 2-78, 2-83, 2-86	≈4882	4-55	444 B	5-4	908	2-94, 2-95
≈B18.3.6M	2-72, 2-76, 2-81	4929-1	3-65	444 LB	5-6	910	2-96, 2-97
≈B18.3	2-45, 2-48, 2-73, 2-75, 2-77, 2-78, 2-82, 2-88, 2-85, 2-90	4933/-	1-75, 1-81, 1-82	462	7-116	912	2-2, 2-20
B18.31.3	4-14, 4-17	4933	1-72	463	7-114	≈912	2-2, 2-17
B18.5.2.3M	1-72	≈4933	1-80	464	6-204	913	2-78
B18.5.2.3M	1-77	7060	9-27	464 Sz	6-205	≈913	2-81
B18.5.2.3M/-	1-75	≈7060	9-30	466	3-113	914	2-83
B18.6.4	6-78	≈7599	6-100	467	3-114	915	2-86
≈B18.6.4	6-84, 6-86	DIN		≈470	12-41	916	2-69
B18.6.5M	6-98	1 B	9-3	471	7-119	≈916	2-72, 2-76
B18.6.7M	6-10, 6-16, 6-21, 6-28	7	9-5	≈471	7-119	917	3-101
≈B18.6.7M	6-10, 6-16, 6-21	84	6-10	472	7-122	920	6-19
BS		≈84	6-10	≈472	7-122	921	6-20
≈450 (1958)	6-27, 6-31	85	6-16	479	1-84	923	6-34
≈1083 (1965)	1-59, 1-61, 3-28	≈85	6-16	508	10-5	928	3-112
≈1768	1-41, 1-52, 3-20, 3-23, 3-92	93	7-113	529 A	8-90	929	3-109
1769	4-57	94	9-37	529 E	8-91	931	1-2
1804-2	9-5	95	6-185	546	3-123	≈931	1-2
2470	2-66	96	6-182	551	6-4	≈931 (1954)	1-58
≈2470	2-21, 2-32, 2-45, 2-48, 2-50, 2-73, 2-90	97	6-179	553	6-6	933	1-19
2485	10-4, 10-5	125-1A	7-4	555 (1987)	3-31	≈933	1-19, 1-35
3673-2	7-125	125-1B	7-33	-/ 555 (1987)	1-80	≈933 (1954)	1-60
3673-4	7-119, 7-122	126	7-11	557	3-117	≈934 (1954)	3-27, 3-30
4168-1	2-2, 2-20	127 B	7-49	561	1-86	934 (1987)	3-5, 3-14
≈4168-1	2-2, 2-17	≈127 B	7-49	562	3-116	≈934 (1987)	3-5
4168-2	2-78	128 A	7-64	571	6-173	935	3-88
≈4168-2	2-81	≈128 A	7-64, 7-66	≈571	6-173	935-1	3-86
4168-3	2-83	137 A	7-63	580	5-7	936	3-38, 3-39
4168-4	2-86	137 B	7-61	≈580 (1957)	5-7	937	3-90
4168-5	2-69	≈137 B	7-61	≠580	5-9	938	4-27
		186 B	5-2	582	5-10	939	4-29
		≈313 (1956)	3-106	≈582 (1957)	5-12	≈939 (1955)	4-33
		315	3-104	≠582	5-10	950	12-105
		316	6-209	601/555 (1987)	1-18	960	1-36
		≈319 C	12-76	603	1-72	961	1-39
		≈319 E	12-76	≈603	1-74	963	6-21
		≈319 M	12-77	603/555 (1987)	1-75	≈963	6-21
		388-1C	12-104	604/555 (1987)	1-81	964	6-28
				605/555 (1987)	1-82	≈965	6-44, 6-49

965-H	6-44	≈6336 L	12-78	7972 C	6-76		
965-Z	6-44	6340	10-10	7973 C	6-98	ISO	
≈966	6-54	6379	10-11	7976 C	6-98	299	10-4, 10-5
966-H	6-51	6796	7-89	7976 F	9-11	1051	9-32, 9-34
966-Z	6-51	6797 A	7-80	7977	9-12	1207	6-10
976-1	4-12	≈6797A	7-80	7978 A	9-13	≈1207	9-37
976-1A	4-2	6797 J	7-79	7979 D	7-58	1234	6-16
≈976-1	4-12	≈6797 J	7-79	7980	7-58	1479 C	6-98
979	3-89, 3-91	6798 A	7-77	≈7980	6-84, 6-86	1479 F	6-98
980V(1987)	3-65, 3-67	≈6798 A	7-77	≈7981 C	6-78	1481 C	6-73
982	3-53	6798 J	7-73	7981 F-H	6-78	1481 F	6-73
≈982	3-53	≈6798 J	7-73	7981 C-H	6-78	1482 C	6-75
985 (1987)	3-48, 3-52	6798 V	7-68	7981 C-Z	6-91, 6-93	1483 C	6-76
≈985 (1987)	3-48	6799	7-125	≈7982 C	6-87	1580	3-101
986	3-102	6880	9-50	7982 C-H	6-87	≈1580	6-16
988	7-137	≈6880	9-50	7982 C-Z	6-102	1617	6-21
1052	7-43	6885 A	9-47	≈7983 C	6-94	2009	6-28
1434	9-36	6887	9-52	7983 C-H	6-94	≈2009	6-21
1440	7-27	6888	9-51	7983 C-Z	2-32	2010	9-5
1441	7-28	≈6900	6-35	7984	6-35	2338	2-83, 6-8
1470	9-14	6912	2-36	7985-H	6-35	2339 B	9-3
1471	9-15	6917	1-93	7985-Z	6-35	2342	5-7
1472	9-16	6918	1-94	≈7985-Z	7-22	3266	12-111
1473	9-18	6921	1-66, 1-70	7989-1	2-39	3290	9-51
1474	9-19	≈6921	1-67, 1-69	7991	2-39, 2-44	3912	1-2
1475	9-21	6923 (1983)	3-78	≈7991	7-126	4014	1-19
1476	9-22	≈6923	3-81	7993 A	6-190	≈4014	1-2
1478	5-13	6926	3-82	7995-Z	6-189	4014/4032	1-94
≈1479	5-13	≈6926	6-100	7996-H	6-187	4016/-	1-18
1480	5-14, 5-15	≈6928 C	9-69	7996-Z	6-189	4017	2-78
≈1480	5-15, 5-16, 5-17, 5-18,	≈7337 A	9-24	7997-Z	3-146, 3-147	4017/4032	1-97
	5-19	7343	9-25	8140-1A	3-146	≈4017	1-19, 1-35
1481	9-27	≈7343	9-26	8140-1B	7-38	4026	2-83
≈1481	9-30	7344	9-29	9021	9-44	≈4026	2-81
1587 (1987)	3-97	7346	7-23	11024	9-42, 9-43	4027	2-86
≈1587 (1987)	3-97	7349	6-63	11024≈	1-82, 1-83	4028	2-69
1804 W	3-122	≈7500	6-65, 6-64	15237	7-82	4029	3-17
2093	7-85	≈7500-1	6-126, 6-127, 6-128,	43699	12-44, 12-45, 12-46	≈4029	2-72, 2-76
2093 A	7-82		6-129, 6-130	≈71412 A/B/C	12-42	4032	3-39
≈2093 A/C	7-88	≈7504 M	6-122	≈71412	12-49	4035	3-76
2093 B	7-83	7504 M-H	6-119, 6-120	71752	12-49	≈4126	1-67
2093 C	7-84	≈7504 M-H	6-137	71752 LH	12-47	4161	2-2, 2-20
2095	12-74	7504 K	6-135	71802 CS	7-61	≈4161	3-78
2097	12-75	≈7504 K	6-134	74361 C	3-107	4762	6-4
2510 L/NF	4-61	≈7504 O	6-132	80701	3-107	≈4762	2-2, 2-17
2510 NF	4-62	7504 O-H	6-130	80704	5-19	≈4162	1-66, 1-69, 1-70
≈3404 A	12-44, 12-46	≈7504 O-H	6-60	≈82101 A	3-76	4766	3-48
≈3405 A	12-43	7513 A	6-59			7040	3-65
≈5401	12-111	7516 DE-H	6-57	EN		≈7040	3-48, 3-53
6319 C	10-9	7516 AE-H	6-58	≈1665	1-66, 1-67, 1-69, 1-70	7042	3-81
6319 D	10-9	7516 EE-H	7-146	15048	1-94, 1-97	7043	7-4, 7-31
6325	9-8	7603 A	7-146	14399-4	1-89, 1-91	7045-H	6-35
≈6325	9-10	7603 C	10-90	14399-6	1-92	7045-Z	6-35
6330 B	10-6	7965	3-84			≈7045-Z	6-35
6331	10-7	7967	3-84	IFI		≈7046-1	6-44
≈6331	10-7	≈7967	6-73	100/107	3-68, 3-69, 3-80	7046-1-H	6-44
6334	3-43	7971 C	6-73			7046-1-Z	6-44
≈6336 K	12-78	7971 F	6-75			7046-2-H	6-44

Norm Index

7046-2-Z	6-44	14579	6-43	2250	6-179	2451	7-79
7047-H	6-51	14580	6-41	2251	6-182	≈2451	7-79
7047-Z	6-51	≈14581	6-49	2252	6-185	2452	3-65, 3-67
≈7049 C	6-86	14583	6-137	2253	6-187	2453	7-77
7049 C-H	6-78	≈14584	6-54	2254	6-189	≈2453	7-77
7049 C-Z	6-78	14585 C	6-84	2260	6-173	2454	7-73
7049 F-H	6-78	14586 C	6-91	2268	7-11	≈2454	7-73
≈7050 C	6-93	14587 C	6-102	2269 A	7-4	2456	7-63
7050 C-H	6-87	15480	6-10	2269 B	7-33	2457	7-61
7050 C-Z	6-87	≈15480	6-135	2270	7-25	≈2457	7-61
7051 C-H	6-94	15481 H	6-122	≈2270	7-25	2458	9-27
7051 C-Z	6-94	≈15481 H	6-119, 6-120	2272	7-145	≈2458	2-30
≈7053 C	6-100	≈15481	6-126, 6-127, 6-128,	≈2272	7-145	2459	9-29
7089	7-33, 7-35		6-129, 6-130	2273	7-143	2460	9-22
7090	7-11	15482 H	6-132	≈2273	7-143	2462	9-11
7091	7-25	≈15482 H	6-130	2274	7-23	2463	9-12
7092	7-32, 7-38	≈15482	6-134	2275	7-40	2464	9-13
≈7092	7-25	R 773	9-47	≈2275	7-40	2553	9-24
7093	7-40	R 774	9-52	2276	7-38	≈2553	9-25
7094	6-6			2277	7-113	2554	9-26
≈7094	7-40	NEN		2278	7-114	2601	9-14
≈7379	2-64, 2-68	10 B	9-3	2279	7-117	2602	9-15
7380-1	2-51	102/697	1-18	2281	9-5	2603	9-16
≈7380-1	2-54	182	9-37	2282	9-8	2604	9-18
7380-2	2-59	303	1-72	≈2282	9-10	2605	9-19
≈7380-2	2-62	303/697	1-75	2307	10-6	2606	9-21
7434	6-7	697	3-31	≈2308 C	10-9	5514	1-94
7436	1-39	-/697	1-80	2308 D	10-9	5515	1-93
8676	1-72	729	3-86	2309	5-2		
8677	9-11	≈964	5-19	2310 B	5-4, 5-6	NF	
8677/-	1-75	1197 B	7-49	≈2324 (1960)	3-106	E21-301	10-4, 10-5
≈8677	1-74	≈1197 B	7-49	2328 A	8-90	E22-163	7-119
8734 A	9-8	1241	2-2, 2-20	2328 E	8-91	E22-165	7-122
≈8734 A	9-10	≈1241	2-2, 2-17	2331	4-27	E25-104	7-85
8735 A	9-13	1486	6-7	2332	4-29	≈E25-107	2-44
8736 A	9-12	1487	6-4	2334 B	3-32	E25-112	1-2
8737	7-27	1488	6-6	≈2336 (1961)	1-58	≈E25-112	1-2
8738	9-14	1555	1-2, 1-36	≈2337 (1961)	1-60	E25-114	1-19
8739	9-18	≈1555	1-2	≈2338 (1960)	3-27, 3-30	≈E25-114	1-19
8740	9-19	1560	3-5, 3-14	2341	2-78	E25-115-1/	1-18
8741	9-21	≈1560	3-5, 3-29	≈2341	2-81	E25-402	
8742	9-15	1568	1-19, 1-39	2343	2-69	E25-119-1	6-44
8744	9-16	≈1568	1-19, 1-35	2343	7-134	≈E25-119-1	6-44, 6-49
8745	9-22	1570	7-64	≈2343	2-72, 2-76	E25-119-2	6-44
8746	9-26	≈1570	7-64, 7-66	2344	2-86	E25-120	6-51
8748	9-24	1601	2-32	≈2346 (1962)	4-33	E25-123	6-21
8750	9-27	1602	6-10	≈2347 (1960)	5-9	≈E25-123	6-21
≈8750	9-25	≈1602	6-10	≈2348 (1960)	5-12	E25-124	6-28
8752	1-36	1603	6-16	2355/697	1-81	E25-125	2-2, 2-20
≈8752	9-30	≈1603	6-16	2359	2-39	≈E25-125	2-2, 2-17
8765	3-52	1618	3-97	≈2359	2-39	≈E25-126	2-51, 2-54
10512	3-67	≈1618	3-97	≈2369	4-2, 4-12	E25-127	6-10
10513	2-39	1624	6-209	2370	6-21	≈E25-127	6-10
10642	2-39, 2-44	1625	3-104	≈2370	6-21	E25-128	6-16
≈10642	6-35	≈1779 A (1960)	6-31	2371	6-28	≈E25-128	6-16
≈10644	9-29	≈1780 A (1960)	6-27	2430	9-47	E25-129	6-56
12240-4	12-50, 12-52	1927	5-7	2450	7-80	≈E25-129	6-32, 6-55
13337	2-16	1928	5-10	≈2450	7-80	E25-133	1-86

E25-134	1-84	E25-410	3-65, 3-67	E25-656	6-87	-/E27-183	7-134
E25-135	4-27, 4-29	E25-412	3-48, 3-52	E25-656 C	6-87	≈E27-183	2-72, 2-76
≈E25-136	4-2, 4-12	≈E25-412	3-48	E25-657	6-94	≈E27-453	3-97
≈E25-137	1-35	E25-453	3-35	E25-657 C	6-94	E27-460	3-84
E25-151	1-39	E25-511	7-107	E25-658	6-78	≈E27-460	3-84
E25-152	1-36	E25-512	7-67	E25-658 C	6-78	E27-475	9-8, 9-13
E25-160	6-4	E25-513	7-11, 7-38, 7-40	E25-660 C	6-75	≈E27-475	9-10
E25-161	6-6	≈E25-513	7-40	E25-661 C	6-76	E27-479	9-12
E25-163	6-7	E25-515	7-49	E25-662 C	6-98	E27-620	7-61
E25-401	3-5, 3-14	≈E25-515	7-49	E25-662 F	6-98	≈E27-620	7-61
≈E25-401	3-5, 3-29	E25-518	10-10	E25-663 C	6-73	E27-624	7-77
E25-402	3-31	E25-601	6-187	E25-663 F	6-73	≈E27-624	7-77
-/E25-402	1-75, 1-80, 1-81, 1-82	E25-603	6-189	E25-774	9-37	E27-625	7-73
E25-404	3-117	E25-604	6-179	E27-180	2-78	≈E27-625	7-73
E25-405-1	3-32	E25-605	6-185	≈E27-180	2-81	≈E27-626	7-72
E25-406	3-76	E25-606	6-182	E27-181	2-83	E27-627	7-68
≈E25-406	3-78	E25-607	6-173	E27-182	2-86		
≈E25-409	3-53	≈E25-654 C	6-84, 6-86	E27-183	2-69		

Group Index

Group	Page	Group	Page	Group	Page	Group	Page	Group	Page	Group	Page
0		01586	3-33	07090	2-33	09561	8-46	12350	3-50	15920	12-156
01000	1-3	01587	3-39	07095	2-63	09610	8-45	12352	3-52	15925	12-157
01010	1-20	03000	1-59	07105	2-34	1		12400	3-63	15930	12-158
01030	1-84	03010	1-61	07111	2-64	11007	3-16	12410	3-50	15935	12-159
01036	1-80	03060	3-28	07116	2-67	11040	3-6	12422	3-53	15940	12-162
01040	1-71	03400	1-58	07117	2-68	11042	3-7	12450	3-50	15945	12-160
01049	1-65	03410	1-60	07141	2-59	11060	3-32	12460	3-81	15950	12-161
01050	1-64	03460	3-27	07150	2-51	11070	3-35	12470	3-74	16000	5-8
01055	1-65	03600	3-27	07151	2-52	11074	3-36	12471	3-74	16010	5-8
01060	1-36	04025	1-91	07160	2-4	11075	3-36	12474	3-74	16040	5-9
01061	1-37	04035	1-92	07165	2-16	11080	3-29	12479	3-83	16100	5-11
01070	1-39	04100	1-10	07170	2-5	11120	3-117	12480	3-96	16110	5-11
01071	1-39	04105	1-11	07200	2-32	11140	3-117	12530	3-85	16140	5-12
01098	1-86	04108	1-11	07212	2-21	11200	3-28	12531	3-85	16150	5-15
01100	3-6	04110	1-26	07250	2-30	11280	3-30	12600	3-54	16151	5-13
01104	3-17	04116	1-26	07260	2-25	11300	3-10	12662	3-54	16153	5-13
01110	3-6	04118	1-27	07290	2-54	11350	3-33	12858	3-65	16160	5-14
01120	3-15	04119	3-9	07400	2-40	11360	3-32	12880	3-66	16170	5-15
01130	3-15	04120	3-8	07407	2-41	11380	3-36	12910	3-66	16172	5-19
01149	3-75	04121	3-9	07450	2-44	11382	3-33	12912	3-67	16177	5-16
01150	3-75	04122	3-9	07470	2-39	11393	3-48	13000	3-74	16178	5-18
01155	3-76	04124	3-18	07560	2-49	11396	3-47	13100	3-71	16180	5-4
01200	1-5	04125	3-9	07600	2-50	11398	3-46	13190	3-73	16182	5-6
01210	1-21	04127	3-19	07620	2-95	11400	3-43	13200	3-72	16190	5-2
01220	1-6	04130	3-19	07640	2-94	11401	3-124	14000	3-112	16196	10-5
01222	1-94	04132	1-67	07650	2-93	11408	3-45	14020	3-109	16202	10-4
01226	1-7	04135	1-70	07660	2-92	11411	3-44	14100	10-89	16203	10-6
01230	1-22	04160	1-38	07670	2-97	11417	3-44	14110	10-89	16204	10-7
01232	1-96	04161	1-38	07680	2-96	11418	3-44	14200	3-111	16205	10-11
01236	1-24	04170	1-40	07760	2-91	11430	10-108	14210	3-111	16206	10-9
01240	1-37	04171	1-41	07800	2-83	11490	3-84	14230	3-110	16207	10-10
01241	1-37	04180	3-16	07810	2-79	11560	3-126	14410	10-90	16210	6-209
01250	1-40	04190	3-9	07812	2-81	11572	3-123	14439	10-89	16225	10-8
01251	1-40	04210	1-89	07820	2-86	11590	3-76	14440	10-90	16226	10-11
01256	1-66	04225	1-91	07840	2-69	11595	3-77	14441	10-95	16227	10-12
01258	1-69	04237	1-92	07850	2-70	11598	3-77	14442	10-95	16228	10-13
01300	3-7	04240	1-93	07852	2-72	11609	3-78	14443	10-92	16229	10-11
01301	3-17	04250	1-93	07860	2-79	11610	3-78	14444	10-91	16250	3-103
01310	3-7	04400	1-62	07890	2-76	11611	3-79	14445	10-92	16260	3-104
01320	3-7	04405	1-63	07930	2-70	11740	3-23	14446	10-91	16270	3-104
01321	3-18	04410	1-63	07940	2-90	11750	3-26	14450	10-96	16280	3-106
01325	3-6	06000	1-87	08070	1-81	11772	3-123	14451	10-96	16295	6-203
01326	3-7	06060	3-41	08100	3-31	11790	3-126	14456	10-93	16300	3-100
01330	3-15	06070	3-42	08110	3-31	11840	3-40	14457	10-94	16410	3-101
01336	3-8	06080	3-42	08200	1-18	12000	3-86	14483	10-93	16450	3-102
01337	3-18	07000	2-7	08206	1-82	12010	3-87	14484	10-94	16500	3-97
01340	3-15	07010	2-18	08250	1-75	12020	3-88	15000	3-94	16510	3-97
01400	1-8	07015	2-6	08260	1-80	12060	3-89	15010	3-95	16516	3-98
01405	1-95	07025	2-9	08280	6-173	12080	3-91	15020	3-95	16540	3-99
01410	1-24	07030	2-36	08290	6-202	12161	3-92	15060	3-94	16650	6-204
01415	1-97	07040	2-20	08310	1-72	12300	3-48	15070	3-95	16660	6-206
01420	1-9	07041	2-20	08320	1-72	12302	3-49	15080	3-95	16680	3-113
01430	1-25	07060	2-2	08420	1-76	12307	3-49	15900	12-151	16690	3-114
01500	3-8	07065	2-6	08450	6-174	12310	3-49	15905	12-152	16711	5-20
01510	3-18	07070	2-17	08750	1-12	12320	3-52	15910	12-153	16713	5-20
01560	3-8	07071	2-18	08760	1-27	12340	3-63	15915	12-155	16715	5-23
01580	3-33	07080	2-33	08781	3-19	12348	3-49	15916	12-154	16717	5-23

Group	Page	Group	Page	Group	Page	Group	Page	Group	Page	Group	Page
16728	5-25	20147	4-11	22320	4-45	25751	10-127	29570	6-107	30575	8-52
16733	5-26	20150	4-7	22330	4-47	25860	6-200	29580	6-139	30576	8-53
16812	5-21	20155	4-10	22380	4-58	25862	6-200	29581	6-139	30577	8-52
16813	5-20	20157	4-11	22382	4-58	26000	6-73	3		30579	8-55
16817	5-22	20160	4-5	22383	4-58	26040	6-77	30000	6-149	30580	8-86
16829	5-24	20170	4-7	22384	4-58	26080	6-98	30005	6-149	30581	8-85
16831	5-27	20200	4-4	22386	4-59	26100	6-74	30015	6-150	30585	8-80
16833	5-26	20220	4-6	22390	4-58	26180	6-99	30025	6-165	30595	8-87
17020	5-30	20230	4-6	22393	4-58	26200	6-79	30030	6-166	30596	8-88
17022	5-32	20232	4-6	22534	4-50	26210	6-80	30040	6-166	30650	12-6
17023	5-31	20235	4-13	22538	4-51	26220	6-88	30100	6-151	30660	12-8
17080	5-35	20240	4-20	22551	4-53	26240	6-96	30105	6-151	30664	12-10
17119	5-34	20252	4-20	22554	4-53	26300	6-83	30115	6-152	30666	12-19
17120	5-34	20300	4-5	23010	1-17	26400	6-80	30125	6-167	30667	12-12
17123	5-29	20302	4-5	23510	4-61	26402	6-80	30130	6-167	30668	12-21
17140	5-35	20330	4-10	23530	4-61	26432	6-89	30140	6-168	30669	12-23
17199	5-33	20360	4-13	23550	4-62	26450	6-95	30205	6-176	30900	12-120
17200	5-32	20372	4-10	23620	4-62	26452	6-95	30225	6-177	30901	12-121
17203	5-29	20376	4-6	23660	4-62	26456	6-103	30230	6-177	30902	12-121
17210	5-33	20380	4-5	24210	6-31	26501	6-84	30250	6-164	30903	12-126
17220	5-33	20395	4-11	24220	6-27	26521	6-91	30300	6-130	30904	12-126
17243	12-31	20410	4-11	24402	6-12	26600	6-73	30305	6-131	30905	12-122
17260	12-30	20420	8-95	24412	6-23	26620	6-75	30310	6-131	30906	12-129
17261	12-30	20430	8-95	24422	6-41	26640	6-76	30320	6-119	30907	12-129
17262	12-30	20460	4-24	24510	6-11	26660	6-78	30325	6-120	30908	12-128
17310	5-39	20464	4-24	24515	6-11	26670	6-79	30330	6-120	30950	11-22
17315	5-39	20466	4-24	24520	6-10	26680	6-87	30350	6-134	31100	6-138
17320	5-36	20470	4-25	24540	6-21	26690	6-88	30355	6-134	31120	6-123
17380	5-42	20474	4-26	24560	6-22	26700	6-94	30360	6-135	31140	6-133
17420	5-28	20476	4-26	24565	6-22	26760	6-79	30365	6-141	31230	6-137
17443	5-40	20478	4-27	24570	6-28	26770	6-88	30375	6-141	31235	6-137
17445	5-41	20610	8-93	24640	6-16	26780	6-95	30380	6-126	31250	6-123
17447	5-41	20620	8-93	24650	6-55	26820	6-130	30385	6-126	31255	6-122
17545	5-30	20630	8-93	24660	6-36	26910	10-121	30390	6-127	31256	6-132
17567	12-32	20640	8-93	24662	6-37	27010	6-60	30400	6-128	31260	6-132
17571	5-42	20650	8-93	24665	6-36	27100	6-57	30410	6-135	31282	6-145
17576	5-38	20660	8-94	24670	6-45	27160	6-59	30415	6-136	31290	6-61
17620	5-31	20661	8-94	24671	6-44	27180	6-58	30420	6-136	31305	6-198
17690	5-28	20663	8-82	24672	6-45	27410	9-23	30500	8-4	31310	6-199
17902	12-75	20710	8-91	24677	6-49	28100	6-100	30502	8-10	31411	6-143
17912	12-74	20750	8-92	24690	6-52	29240	6-154	30505	8-12	31416	6-143
18040	8-99	21500	4-29	24691	6-51	29242	6-155	30509	8-34	31426	6-144
18060	8-100	21510	4-30	24692	6-52	29243	6-159	30510	8-28	31445	6-140
18120	8-98	21515	4-30	24700	3-118	29248	6-155	30530	8-18	31460	6-142
18140	8-98	21520	4-31	24769	3-116	29310	6-159	30531	8-18	31480	6-129
18550	8-97	21540	4-33	24770	3-116	29340	6-168	30532	8-18	31535	6-146
18570	8-97	21560	4-27	24800	6-37	29345	6-169	30537	8-15	31536	6-147
18600	8-101	22060	4-55	24810	6-37	29346	6-170	30539	8-17	31570	6-146
2		22080	4-39	24840	6-45	29349	6-157	30550	8-66	31572	6-146
20000	6-7	22082	4-41	24862	6-56	29353	6-157	30551	8-66	31702	6-115
20010	6-4	22090	4-42	24874	6-56	29360	6-160	30552	8-66	31705	6-112
20030	6-6	22100	4-38	24904	6-35	29367	6-171	30553	8-67	31710	6-111
20108	4-3	22180	4-37	24992	6-34	29370	6-157	30554	8-72	31711	6-111
20130	4-7	22190	4-37	25110	6-182	29375	6-160	30564	8-40	31720	6-112
20132	4-7	22200	4-59	25130	6-179	29385	6-158	30565	8-40	31780	6-116
20140	4-5	22280	4-57	25710	6-189	29390	6-201	30569	8-33	31781	6-116
20145	4-10	22290	4-57	25750	10-126	29440	6-155	30570	8-44	31810	6-138

Group Index

Group	Page	Group	Page	Group	Page	Group	Page	Group	Page	Group	Page
31815	6-138	36302	7-84	37980	7-96	38435	7-24	39250	9-47	43280	12-26
31820	6-123	36303	7-85	37981	7-102	38438	7-24	39270	9-50	43295	12-123
31825	6-123	36307	7-86	37982	7-99	38490	7-144	39310	9-38	43299	12-123
31830	6-133	36325	7-93	37983	7-103	38495	7-144	39350	9-38	43310	12-124
31860	6-138	36326	7-94	37984	7-101	38500	7-144	39360	9-39	43317	12-121
31870	6-124	36390	7-105	37985	7-96	38520	7-142	39400	9-32	43323	12-124
31880	6-133	36395	7-104	37986	7-99	38540	7-143	39410	9-34	43324	12-125
32635	9-65	36396	7-105	37987	7-102	38583	7-139	39610	9-42	43325	12-126
32642	9-68	36397	7-105	37988	7-103	38585	7-139	39630	9-43	45008	2-43
33190	9-58	36411	7-105	38031	7-5	38590	7-140	39660	9-46	45010	1-33
33410	9-78	36420	7-106	38043	7-20	38600	7-138	39680	9-45	45070	4-9
33600	9-75	36425	7-106	38045	7-20	38602	7-139	39700	9-14	45080	3-12
33610	9-74	36450	7-91	38047	7-21	38650	7-113	39710	9-15	45110	3-51
33620	9-77	36460	7-92	38053	7-18	38670	7-118	39720	9-17	45140	10-98
33650	9-75	37000	7-50	38055	7-18	38684	7-116	39730	9-18	45150	7-30
33670	9-76	37020	7-50	38057	7-19	38690	7-115	39740	9-20	45180	7-29
33695	9-76	37024	7-51	38063	7-14	38740	7-12	39750	9-21	45184	7-8
33900	9-69	37025	7-51	38065	7-14	38760	7-27	39760	9-22	45191	7-146
34110	9-56	37030	7-50	38067	7-15	38793	7-150	39797	9-36	45192	7-147
34113	9-61	37060	7-51	38073	7-16	38796	7-150	4		45193	7-147
34120	9-63	37070	7-66	38075	7-16	38801	7-151	41000	11-3	45205	2-15
34121	9-79	37080	7-64	38077	7-17	38802	7-151	41010	11-14	45208	2-44
34125	9-71	37092	7-65	38080	7-6	38803	7-152	41020	11-24	45210	1-33
34126	9-62	37110	7-63	38081	7-5	38805	7-152	41030	11-23	45270	4-9
34128	9-73	37120	7-63	38093	7-7	38806	7-152	41040	11-24	45280	3-13
34130	9-58	37150	7-62	38100	7-5	38807	7-152	43010	12-9	45300	3-72
34140	9-64	37160	7-62	38125	7-7	38808	7-153	43011	12-9	45425	6-48
34150	9-60	37200	7-57	38130	7-5	38810	7-153	43019	12-11	45445	6-40
34180	9-59	37220	7-58	38131	7-31	38812	7-154	43020	12-10	45790	7-52
34184	9-65	37240	7-60	38133	7-31	38814	7-154	43024	12-14	45810	1-33
34185	9-70	37260	7-82	38140	7-6	38816	7-154	43025	12-18	45850	3-13
34186	9-60	37265	7-108	38143	7-6	38840	7-157	43026	12-18	45910	1-34
34190	9-57	37282	7-107	38152	7-6	38869	7-155	43030	12-23	45920	3-13
34200	9-64	37300	7-81	38157	7-6	38871	7-155	43033	12-15	45930	7-9
34205	9-72	37302	7-81	38160	7-33	38873	7-155	43055	12-22	45940	4-9
34250	9-72	37320	7-80	38180	7-34	38874	7-155	43062	12-13	46010	1-33
34310	9-57	37400	7-77	38190	7-34	38875	7-155	43063	12-13	46060	1-34
34320	9-66	37420	7-78	38200	7-11	38877	7-156	43065	12-16	46090	4-9
34330	9-66	37430	7-78	38205	7-11	38883	7-156	43074	12-16	46210	1-60
34350	9-67	37440	7-78	38209	7-38	38885	7-156	43076	12-17	46290	4-20
35145	9-80	37460	7-73	38210	7-38	38887	7-156	43080	12-7	47000	3-13
35146	9-81	37480	7-73	38211	7-39	38900	12-115	43081	12-7	47030	3-34
35760	9-80	37500	7-68	38212	7-39	38950	12-116	43110	12-20	47050	3-13
36000	7-121	37520	7-68	38220	7-39	38958	7-28	43111	12-20	47100	3-28
36050	7-124	37560	7-67	38230	7-41	39000	9-3	43115	12-21	47170	3-26
36200	7-125	37580	7-72	38240	7-40	39011	9-11	43213	12-117	47195	3-45
36215	7-127	37590	7-72	38250	7-25	39012	9-12	43214	12-118	47220	2-98
36230	7-130	37810	7-134	38270	7-22	39060	9-29	43241	12-25	47300	3-102
36233	7-128	37815	7-134	38280	7-22	39070	9-5	43246	12-24	47340	3-98
36239	7-128	37820	7-134	38300	7-141	39078	9-10	43270	12-26	47360	3-99
36250	7-129	37840	7-132	38310	7-141	39080	9-8	43271	12-27	47480	6-205
36251	7-129	37845	7-133	38320	7-141	39090	9-13	43272	12-27	47490	6-207
36252	7-129	37900	7-110	38400	7-44	39100	9-28	43273	12-27	47500	3-113
36265	7-131	37901	7-111	38401	7-45	39140	9-24	43274	12-27	47510	3-114
36270	7-89	37910	7-110	38410	7-44	39150	9-26	43275	12-28	47511	3-115
36273	7-89	37920	7-112	38420	7-23	39200	9-51	43276	12-28	47530	6-210
36300	7-83	37979	7-98	38430	7-24	39220	9-52	43279	12-27	47550	3-105

Group	Page	Group	Page	Group	Page	Group	Page	Group	Page	Group	Page
47560	3-105	51020	2-18	51180	3-109	51418	7-15	51590	7-41	51765	6-105
47570	3-106	51028	2-60	51182	3-110	51419	7-17	51591	10-113	51766	6-106
47711	10-103	51029	2-55	51183	3-111	51420	7-7	51592	10-116	51767	6-104
47715	10-103	51030	2-52	51190	10-128	51422	6-117	51593	10-119	51768	6-105
47720	10-102	51036	10-110	51200	3-41	51427	7-35	51594	10-124	51769	6-106
47750	10-102	51037	10-112	51207	6-19	51428	9-30	51595	10-120	51770	6-169
47780	10-101	51040	2-34	51208	6-20	51430	9-25	51596	10-124	51771	6-114
47790	10-101	51041	2-62	51209	6-34	51435	7-121	51597	10-125	51773	6-162
47796	10-100	51042	2-37	51210	6-29	51437	7-124	51598	10-119	51774	6-164
48020	6-14	51044	2-65	51212	10-100	51440	7-126	51599	10-117	51775	6-160
48040	6-18	51047	2-44	51215	6-32	51445	7-131	51600	6-74	51777	6-114
48170	6-25	51050	2-10	51220	3-87	51446	7-128	51620	6-75	51780	6-193
48180	6-30	51051	2-19	51221	3-38	51447	7-90	51640	6-77	51781	6-191
48210	6-31	51052	2-16	51222	3-39	51448	7-88	51650	6-99	51785	6-191
48220	6-27	51056	2-21	51224	3-89	51450	7-51	51651	6-101	51786	6-193
48520	6-15	51060	2-41	51225	3-90	51456	7-81	51652	6-108	51787	6-191
48530	6-18	51064	4-8	51230	2-87	51458	7-80	51653	6-109	51788	6-193
48550	6-26	51068	4-3	51240	2-80	51460	7-78	51660	6-81	51789	6-171
48570	6-30	51070	4-8	51250	2-84	51462	7-74	51661	6-82	51790	5-5
49210	6-184	51071	4-10	51260	2-71	51463	7-68	51663	6-86	51792	6-196
49230	6-181	51072	4-12	51270	4-31	51468	7-105	51664	6-84	51793	6-195
49250	6-186	51074	4-8	51280	4-28	51480	9-35	51667	10-113	51794	6-197
49310	6-184	51076	4-24	51281	5-38	51490	9-32	51668	10-121	51795	6-195
49330	6-181	51077	4-25	51285	4-34	51500	1-73	51669	10-122	51796	6-197
49350	6-186	51080	3-10	51287	5-37	51501	1-74	51670	6-81	51797	6-195
5		51081	3-19	51289	6-33	51503	6-206	51671	10-126	51798	6-72
50020	7-29	51082	3-10	51290	6-9	51505	1-82	51672	10-111	51799	6-115
50030	7-30	51088	3-118	51291	6-8	51506	1-83	51673	10-115	51800	3-105
50040	7-34	51089	3-11	51292	6-4	51520	7-65	51674	10-127	51801	6-72
50060	7-8	51090	3-34	51293	6-6	51530	7-39	51675	10-128	51810	3-103
50065	7-8	51092	3-36	51296	6-8	51531	7-32	51680	6-89	51812	6-209
50100	7-26	51093	3-34	51300	6-46	51532	7-24	51681	6-89	51820	6-208
50150	7-34	51095	3-116	51302	6-46	51533	7-43	51683	6-92	51828	6-205
50210	9-41	51097	10-109	51305	6-49	51534	7-27	51689	6-96	51829	6-204
50230	10-97	51098	3-124	51320	6-52	51535	7-29	51690	6-96	51830	3-113
50260	10-97	51100	3-10	51322	6-53	51540	7-114	51693	6-102	51840	3-114
50280	10-98	51101	3-45	51325	6-54	51546	10-99	51700	9-39	51843	6-194
50300	7-147	51102	10-6	51327	6-67	51550	7-64	51710	3-71	51844	6-192
50301	7-147	51104	10-7	51329	6-68	51551	7-62	51718	3-54	51845	6-194
50302	7-148	51106	3-44	51330	6-66	51552	7-138	51720	3-64	51846	6-192
50303	7-148	51108	3-77	51331	6-68	51554	7-138	51728	3-51	51847	6-194
50332	7-148	51109	3-29	51340	6-38	51555	7-140	51729	3-50	51848	6-192
50333	7-148	51110	6-23	51342	6-38	51556	7-139	51730	3-50	51849	6-197
50334	7-149	51111	6-23	51345	6-41	51557	7-140	51734	3-82	51850	6-196
50370	9-34	51112	3-83	51350	10-97	51560	9-4	51735	3-85	51851	6-197
50380	9-36	51113	3-125	51370	7-135	51572	10-118	51738	3-81	51852	6-196
50390	9-41	51119	3-79	51371	7-135	51573	10-123	51739	3-53	51860	6-183
50500	7-66	51120	6-12	51372	7-135	51574	10-115	51740	5-3	51864	6-93
50540	7-79	51121	6-12	51373	7-136	51577	7-42	51742	5-16	51866	6-189
50670	9-33	51122	6-43	51380	3-101	51578	10-114	51743	5-18	51870	6-180
50680	9-35	51128	3-119	51390	7-58	51580	9-6	51744	5-17	51874	6-188
50900	7-149	51140	6-16	51400	3-98	51582	9-19	51750	6-156	51876	6-187
51000	1-12	51160	3-16	51405	3-103	51583	9-20	51756	6-172	51878	6-178
51010	1-27	51162	3-11	51410	7-45	51585	9-16	51760	6-104	51880	6-185
51012	1-35	51166	3-37	51415	7-22	51586	9-17	51761	6-105	51886	6-190
51014	1-69	51170	4-26	51416	7-21	51588	10-122	51762	6-106	51890	6-176
51018	1-67	51178	3-112	51417	7-19	51589	9-22	51764	6-104	51891	6-112

Group Index

Group	Page	Group	Page	Group	Page	Group	Page	Group	Page	Group	Page
51892	6-113	54124	13-14	54210	13-44	54307	13-72	54538	13-94	54596	13-110
51893	6-113	54125	13-15	54211	13-45	54308	13-73	54539	13-83	54597	13-108
51894	6-113	54126	13-15	54212	13-45	54309	13-73	54540	13-86	54598	13-108
51900	6-174	54127	13-16	54213	13-45	54310	13-73	54541	13-96	54599	13-114
51908	7-142	54128	13-17	54214	13-45	54311	13-73	54542	13-96	54600	13-112
51910	7-115	54129	13-15	54215	13-45	54312	13-73	54543	13-96	54601	13-112
51914	7-118	54130	13-15	54216	13-46	54313	13-73	54544	13-86	54602	13-113
51920	7-145	54131	13-15	54217	13-47	54314	13-74	54545	13-86	54603	13-111
51922	7-143	54132	13-19	54218	13-47	54315	13-74	54546	13-97	54604	13-113
51930	7-25	54133	13-19	54219	13-48	54316	13-75	54547	13-88	54605	13-115
51935	10-10	54134	13-19	54220	13-48	54317	13-75	54548	13-88	54606	13-115
51936	10-10	54135	13-19	54221	13-48	54318	13-75	54549	13-99	54607	13-116
51940	5-8	54136	13-19	54222	13-50	54319	13-76	54550	13-102	54608	13-116
51941	5-8	54137	13-19	54223	13-49	54320	13-76	54551	13-99	54609	13-116
51950	5-11	54138	13-15	54224	13-49	54321	13-77	54552	13-102	54610	13-116
51951	5-11	54139	13-20	54225	13-50	54322	13-78	54553	13-99	54611	13-116
51961	2-92	54140	13-21	54226	13-51	54323	13-78	54554	13-102	54612	13-116
51962	2-93	54141	13-137	54227	13-51	54324	13-79	54555	13-99	54613	13-117
51964	2-95	54142	13-20	54228	13-52	54325	13-79	54556	13-102	54614	13-117
51965	2-96	54143	13-21	54229	13-53	54326	13-80	54557	13-99	54615	13-117
51966	2-97	54144	13-22	54230	13-53	54500	13-82	54558	13-102	54616	13-118
51970	9-42	54145	13-23	54231	13-54	54501	13-85	54559	13-99	54617	13-118
52420	7-8	54146	13-23	54232	13-55	54502	13-82	54560	13-102	54618	13-119
52451	7-52	54147	13-24	54233	13-55	54503	13-82	54561	13-100	54619	13-119
53080	3-11	54148	13-24	54234	13-55	54504	13-87	54562	13-103	54620	13-119
53162	3-12	54149	13-24	54235	13-55	54505	13-89	54563	13-100	54621	13-119
53460	7-79	54150	13-25	54236	13-55	54506	13-89	54564	13-103	54622	13-120
53510	1-16	54151	13-26	54237	13-57	54507	13-92	54565	13-100	54623	13-121
53520	1-31	54152	13-26	54238	13-57	54508	13-90	54566	13-103	54624	13-121
53521	1-32	54153	13-26	54239	13-57	54509	13-90	54567	13-100	54625	13-122
53570	2-14	54154	13-26	54240	13-58	54511	13-92	54568	13-103	54626	13-122
53580	3-12	54155	13-26	54241	13-59	54512	13-93	54569	13-100	54627	13-123
53581	3-20	54156	13-27	54242	13-59	54513	13-85	54570	13-103	54628	13-123
54100	13-3	54157	13-22	54243	13-59	54514	13-82	54571	13-100	54629	13-124
54101	13-3	54158	13-29	54244	13-59	54515	13-82	54572	13-103	54630	13-125
54102	13-5	54159	13-29	54245	13-61	54516	13-85	54573	13-94	54631	13-125
54103	13-9	54160	13-30	54246	13-61	54517	13-82	54574	13-94	54632	13-127
54104	13-6	54161	13-30	54247	13-61	54518	13-90	54576	13-104	54633	13-127
54105	13-6	54162	13-30	54248	13-64	54519	13-93	54577	13-104	54634	13-127
54106	13-6	54163	13-30	54249	13-65	54520	13-90	54578	13-105	54635	13-127
54107	13-6	54164	13-31	54250	13-65	54521	13-90	54579	13-105	54636	13-127
54108	13-9	54165	13-32	54251	13-65	54522	13-94	54580	13-105	54637	13-127
54109	13-6	54166	13-34	54252	13-66	54523	13-87	54581	13-106	54638	13-128
54110	13-9	54167	13-32	54253	13-66	54524	13-90	54582	13-106	54639	13-128
54111	13-9	54168	13-33	54254	13-67	54525	13-91	54583	13-107	54640	13-128
54112	13-6	54169	13-33	54255	13-67	54526	13-88	54584	13-108	54641	13-129
54113	13-7	54170	13-33	54256	13-68	54527	13-85	54585	13-108	54642	13-129
54114	13-10	54171	13-35	54257	13-68	54528	13-85	54586	13-108	54643	13-131
54115	13-7	54200	13-37	54258	13-56	54529	13-91	54587	13-111	54644	13-131
54116	13-7	54201	13-37	54259	13-62	54530	13-85	54588	13-111	54645	13-132
54117	13-7	54202	13-37	54300	13-69	54531	13-83	54589	13-111	54646	13-132
54118	13-10	54203	13-38	54301	13-71	54532	13-83	54590	13-111	54647	13-132
54119	13-11	54204	13-39	54302	13-72	54533	13-83	54591	13-111	54648	13-132
54120	13-11	54206	13-41	54303	13-72	54534	13-91	54592	13-114	54649	13-132
54121	13-12	54207	13-41	54304	13-72	54535	13-95	54593	13-114	54650	13-132
54122	13-12	54208	13-41	54305	13-72	54536	13-95	54594	13-109	54651	13-133
54123	13-14	54209	13-41	54306	13-72	54537	13-86	54595	13-109	54652	13-133

Group	Page	Group	Page	Group	Page	Group	Page	Group	Page	Group	Page
54653	13-133	55221	3-38	55512	9-50	55950	5-11	56806	12-146	57012	12-82
54654	13-134	55225	3-90	55516	9-52	55951	5-12	56818	12-137	57013	12-55
54655	13-134	55230	2-87	55520	7-65	55961	2-92	56819	12-136	57014	12-91
54656	13-135	55240	2-80	55530	7-39	55962	2-93	56824	12-139	57015	12-91
54701	13-136	55250	2-84	55531	7-33	55963	2-94	56830	12-138	57020	12-82
54702	13-136	55260	2-71	55532	7-24	55964	2-95	56832	12-133	57021	12-82
54703	13-137	55270	4-32	55533	7-43	55965	2-96	56833	12-128	57023	12-83
54704	13-42	55280	4-28	55534	7-28	55966	2-98	56834	12-127	57025	12-85
54705	13-43	55282	5-38	55540	7-114	55970	9-44	56835	12-132	57027	12-86
54706	13-43	55285	4-34	55551	7-62	56050	4-21	56837	12-134	57028	12-86
55000	1-14	55292	6-5	55561	6-165	56052	4-22	56839	12-135	57030	12-92
55010	1-29	55293	6-7	55577	7-42	56054	4-23	56840	12-131	57031	12-93
55012	1-36	55300	6-47	55580	9-7	56090	1-17	56843	12-141	57033	12-93
55018	1-68	55302	6-48	55590	7-41	56100	1-34	56890	12-142	57035	12-94
55020	2-19	55303	6-50	55651	6-101	56120	2-19	56901	12-104	57037	12-95
55025	2-61	55320	6-53	55660	6-83	56170	4-9	56914	12-76	57040	12-79
55030	2-53	55322	6-53	55661	6-82	56200	3-14	56915	12-77	57041	12-79
55032	2-55	55325	6-55	55664	6-85	56210	12-140	56916	12-76	57043	12-80
55040	2-35	55340	6-39	55680	6-90	56220	3-65	56921	12-79	57045	12-80
55042	2-38	55342	6-40	55681	6-90	56230	6-207	56922	12-78	57046	12-80
55047	2-45	55345	6-42	55683	6-92	56240	3-115	56931	12-86	57048	12-80
55050	2-12	55350	10-99	55689	6-97	56250	3-99	56940	12-105	57049	12-95
55060	2-42	55380	3-102	55690	6-97	56280	3-108	56949	2-89	57050	12-88
55067	4-13	55390	7-58	55693	6-103	56290	3-108	56950	12-56	57051	12-88
55068	4-4	55400	3-98	55700	9-40	56300	7-8	56951	12-56	57053	12-89
55070	4-8	55402	3-98	55718	3-54	56310	7-9	56952	12-60	57054	12-89
55071	4-11	55410	7-45	55720	3-64	56320	7-26	56953	12-60	57060	12-106
55072	4-12	55415	7-23	55730	3-51	56330	7-40	56954	12-109	57061	12-106
55074	4-9	55416	7-21	55734	3-82	56332	7-40	56955	12-92	57063	12-96
55080	3-11	55417	7-19	55735	3-85	56410	6-15	56956	12-98	57064	12-96
55081	3-20	55418	7-15	55738	3-81	56420	6-18	56957	12-98	57066	12-90
55088	3-118	55419	7-17	55739	3-53	56440	6-26	56958	12-98	57067	12-90
55089	3-12	55420	7-7	55740	5-3	56460	6-33	56959	12-98	57070	12-102
55090	3-34	55425	7-32	55750	6-156	56480	10-104	56960	12-99	57071	12-102
55092	3-37	55426	7-34	55755	6-163	56610	6-202	56961	12-99	57076	12-103
55095	3-117	55427	7-35	55775	6-161	56660	1-98	56964	12-100	57077	12-104
55098	3-124	55436	7-97	55782	5-2	56661	1-99	56965	12-100	57080	12-107
55100	3-12	55437	7-97	55790	5-5	56662	1-99	56966	12-87	57081	12-107
55101	3-46	55438	7-98	55792	3-107	56672	12-130	56970	12-83	57083	12-108
55102	10-7	55443	7-93	55793	3-107	56680	12-143	56971	12-103	57084	12-108
55104	10-8	55447	7-90	55800	3-105	56690	12-144	56972	12-87	57090	12-81
55106	3-44	55450	7-51	55810	3-104	56710	12-145	56973	12-100	57091	12-81
55108	3-77	55453	7-100	55820	6-208	56730	12-84	56974	12-100	57092	12-81
55109	3-30	55454	7-101	55860	6-183	56735	12-84	56975	12-57	57425	12-47
55110	6-25	55456	7-100	55870	6-180	56740	12-85	56976	12-57	57426	12-47
55113	3-125	55460	7-78	55874	6-188	56760	12-146	56977	12-58	57475	12-47
55119	3-79	55462	7-74	55878	6-179	56767	12-147	56978	12-58	57476	12-48
55120	6-13	55463	7-97	55880	6-186	56770	12-144	56979	12-59	57510	12-48
55140	6-17	55464	7-98	55900	6-175	56772	12-148	56980	12-59	57560	12-49
55160	3-16	55465	7-100	55908	7-142	56780	12-149	56988	12-94	57578	12-50
55166	3-37	55466	7-101	55910	7-115	56783	12-150	57001	12-61	57580	12-50
55178	3-112	55490	9-33	55914	7-118	56790	10-106	57003	12-97	57600	12-52
55180	3-109	55500	1-73	55920	7-145	56792	10-104	57004	12-101	57605	12-51
55200	3-41	55501	1-75	55922	7-143	56795	10-105	57005	12-101	57650	12-52
55210	6-29	55505	1-83	55930	7-26	56797	10-105	57007	12-53	57655	12-51
55212	10-100	55506	1-83	55940	5-8	56799	12-143	57008	12-53	57676	12-72
55220	3-87	55510	9-49	55941	5-9	56800	12-147	57011	12-82	57730	12-69

Group Index

Group	Page	Group	Page	Group	Page	Group	Page	Group	Page	Group	Page
57745	12-70	61650	10-26	63150	8-8	63691	8-87	69035	3-134	71330	3-145
57747	12-70	61670	10-26	63152	11-26	64010	10-86	69045	3-132	71340	3-145
57748	12-70	61810	10-27	63158	8-5	64030	10-87	69135	3-128	71410	3-143
57749	12-71	61850	10-32	63159	8-5	64050	10-86	69155	3-131	71510	3-154
57750	12-71	61860	10-31	63160	8-9	64100	10-36	69190	3-137	71550	3-172
57770	12-62	61936	10-30	63174	8-33	64108	10-37	69195	3-138	71551	3-174
57771	12-63	61937	10-30	63186	8-84	64122	10-38	69315	3-129	71552	3-173
57779	12-64	61938	10-30	63187	8-81	64130	10-39	69335	3-133	71554	3-174
57780	12-64	61939	10-30	63188	8-81	64132	10-41	69355	3-137	71556	3-175
57792	12-65	61941	10-33	63189	8-83	64134	10-40	69400	3-130	71560	3-173
57793	12-66	61942	10-34	63190	8-36	64136	10-45	69407	3-130	71566	3-172
57794	12-67	61944	10-16	63191	8-35	64140	10-46	69435	3-134	71570	10-88
57795	12-68	61945	10-17	63192	8-39	64144	10-44	69440	3-136	71580	3-178
57805	12-69	61946	10-17	63195	8-37	64152	10-48	69445	3-135	71592	3-177
57807	12-73	61948	10-19	63196	8-38	64154	10-47	69450	3-135	71595	3-176
6		61949	10-19	63223	8-27	64158	10-43	69525	3-132	71597	3-178
60311	10-56	61951	10-28	63226	8-50	64162	10-41	69526	3-129	71610	3-155
60313	10-56	61952	10-18	63227	8-90	64163	10-44	69670	3-141	71620	3-155
60315	10-57	61953	10-18	63240	8-16	64168	10-42	69685	3-140	71640	3-156
60317	10-58	61961	10-28	63243	8-87	64180	10-49	69975	3-139	71710	3-156
60319	10-55	61963	10-33	63248	8-17	64270	10-52	7		71711	3-157
60321	10-55	62255	10-61	63252	8-86	64271	10-52	70520	8-61	71720	3-157
60323	10-59	62257	10-62	63260	8-25	64272	10-51	70521	8-62	71730	3-158
60325	10-58	62265	10-63	63261	8-20	64273	10-53	70522	8-63	71740	3-157
60331	10-59	62267	10-64	63270	8-14	64275	10-50	70523	8-63	71760	3-160
61015	10-20	62272	10-75	63276	8-13	64500	12-33	70524	8-64	71762	3-163
61020	10-20	62273	10-75	63277	8-13	64501	12-37	70525	8-59	71764	3-162
61035	10-20	62274	10-76	63298	8-32	64502	12-37	70526	8-60	71766	3-161
61040	10-21	62276	10-76	63300	8-21	64503	12-35	70527	8-57	71768	3-161
61055	10-21	62282	10-77	63309	8-22	64504	12-36	70528	8-57	71770	3-161
61060	10-21	62283	10-78	63310	8-23	64505	12-38	70529	8-57	71772	3-162
61115	10-21	62284	10-78	63312	8-24	64506	12-38	70530	8-58	71774	3-164
61120	10-21	62285	10-79	63313	8-24	64507	12-34	70531	8-58	71776	3-165
61135	10-22	62286	10-79	63320	8-54	65411	3-121	70532	8-58	71778	3-165
61140	10-22	62302	10-80	63321	8-54	65421	8-51	70615	8-85	71780	3-165
61155	10-22	62303	10-80	63322	8-55	65435	8-47	70636	8-83	71782	3-166
61165	10-22	62304	10-81	63323	8-74	65445	8-48	70646	8-83	71784	3-167
61170	10-22	62305	10-82	63324	8-69	65450	8-45	70665	8-26	71786	3-168
61180	10-23	62306	10-82	63325	8-70	66813	12-111	70880	8-19	71788	3-160
61265	10-27	62323	10-83	63328	8-68	66816	12-111	70882	8-19	71790	3-164
61290	10-29	62325	10-85	63400	8-48	66819	12-112	70927	8-71	71792	3-169
61300	10-29	62332	10-85	63410	8-49	66860	12-112	70967	8-56	71794	3-169
61317	10-31	62411	10-66	63421	8-75	66910	12-112	71010	3-149	71796	3-169
61355	10-31	62412	10-68	63422	8-77	66920	12-112	71020	3-150	71798	3-170
61390	10-31	62413	10-67	63428	8-56	66930	12-112	71021	3-150	71810	3-159
61415	10-24	62414	10-70	63445	8-78	66950	12-113	71030	3-152	71860	3-159
61420	10-24	62415	10-71	63500	10-35	66955	12-113	71040	3-151	71910	3-151
61430	10-25	62416	10-72	63560	8-41	66960	12-114	71050	3-152	71920	3-148
61435	10-25	62417	10-73	63562	8-41	66970	12-114	71090	3-153	71930	3-144
61440	10-25	63050	8-89	63590	8-41	66990	12-114	71110	3-146	71940	3-155
61450	10-23	63051	8-86	63600	8-43	67020	6-63	71120	3-147	71950	3-158
61515	10-24	63052	8-89	63601	8-42	67080	6-64	71121	3-147	72000	6-109
61530	10-24	63060	8-86	63611	8-29	67155	6-65	71130	3-149	72002	6-109
61555	10-25	63100	8-7	63615	8-30	67551	6-70	71140	3-148	72004	9-69
61570	10-26	63110	8-7	63616	8-30	67552	6-71	71210	3-146	72005	6-108
61615	10-24	63120	8-11	63617	8-31	67553	6-71	71310	3-143	72008	6-107
61630	10-25	63121	8-11	63690	8-78	69025	3-129	71320	3-144	72011	6-110

Group	Page	Group	Page	Group	Page	Group	Page	Group	Page	Group	Page
72018	6-110	U		U07810	2-82	U12601	3-59	U38200	7-12	U51460	7-70
72022	6-108	U01000	1-43	U07820	2-88	U12705	3-60	U38205	7-13	U51462	7-75
72030	7-61	U01060	1-52	U07840	2-73	U12910	3-68	U38400	7-48	U51500	1-79
72037	7-150	U01062	1-53	U07845	2-90	U12920	3-68	U38402	7-48	U51530	7-36
72045	6-100	U01080	1-85	U07852	2-75	U12950	3-70	U38403	7-47	U51566	2-50
72100	12-39	U01100	3-21	U07890	2-77	U12960	3-70	U38405	7-48	U51705	3-61
72110	12-39	U01120	3-24	U07891	2-78	U20170	4-16	U43150	7-54	U51718	3-60
72122	3-43	U01200	1-44	U08100	3-20	U20200	4-14	U50450	7-71	U51730	3-57
72123	3-43	U01300	3-21	U08110	3-21	U20300	4-15	U50462	7-76	U51738	3-56
72130	3-42	U01330	3-24	U08160	3-24	U20360	4-18	U51000	1-49	U51915	3-69
72131	3-42	U04100	1-47	U08161	3-24	U20365	4-18	U51007	1-57	U51960	3-70
72150	12-40	U04104	1-46	U08200	1-41	U37000	7-53	U51030	2-57	U53460	7-71
72160	12-41	U04120	3-21	U08210	1-42	U37020	7-53	U51041	2-30	U53462	7-75
72170	12-43	U04122	3-22	U08300	1-77	U37025	7-54	U51044	2-67	U55000	1-50
72185	12-46	U04160	1-54	U08305	1-78	U37060	7-53	U51050	2-26	U55041	2-31
72186	12-44	U04162	3-25	U08307	1-78	U37170	7-56	U51060	2-47	U55050	2-27
72210	12-42	U04180	3-24	U08320	1-78	U37171	7-57	U51067	4-19	U55067	4-19
72213	12-42	U04181	3-25	U12100	3-80	U37180	7-55	U51070	4-16	U55070	4-17
72220	12-44	U04360	1-56	U12120	3-80	U37183	7-56	U51080	3-22	U55080	3-22
72221	12-45	U07000	2-22	U12300	3-55	U37200	7-59	U51130	2-59	U55205	7-13
72230	12-43	U07001	2-25	U12320	3-61	U37320	7-76	U51160	3-25	U55410	7-49
72240	12-45	U07040	2-29	U12348	3-55	U37321	7-76	U51205	7-13	U55411	3-62
72243	12-45	U07111	2-66	U12353	3-62	U37420	7-70	U51260	2-74	U55420	7-10
72260	12-46	U07150	2-56	U12380	3-58	U37480	7-75	U51261	2-76	U55450	7-54
72293	3-120	U07151	2-57	U12381	3-58	U37500	7-69	U51390	7-59	U55460	7-71
72340	3-120	U07230	2-58	U12411	3-56	U37590	7-69	U51410	7-48	U55462	7-75
72350	3-119	U07410	2-46	U12421	3-62	U38100	7-10	U51411	3-62	U55530	7-36
8		U07415	2-47	U12422	3-62	U38130	7-10	U51420	7-10	U55730	3-56
87911	12-54	U07566	2-49	U12423	3-57	U38157	7-10	U51422	3-59	U55915	3-69
87916	12-54	U07800	2-85	U12450	3-56	U38160	7-37	U51450	7-54		

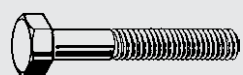

1 Bolts



2 Hexagon socket products



3 Nuts, rivet nuts & inserts



4 Threaded rods & studbolts



5 Hook & eye products



6 Screws

I Index



7 Washers & O-rings



8 Anchoring products

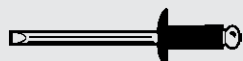

9 Rivets, pins & keys

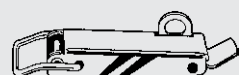

10 Systems, furniture & security fasteners

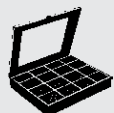

11 Assortments & storage systems

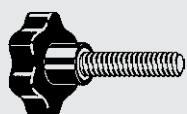



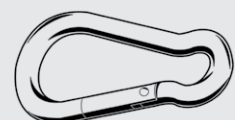

12 Engineering parts & machine parts



13 Maritime products

T Fastening technology





Washers & O-rings 7

 Page 7-4 DIN 125-1A Plain	 Page 7-9 ASME B18.21.1 Plain USS	 Page 7-11 DIN 126 Plain	 Page 7-12 ASME B18.21.1 Plain SAE	 Page 7-14 NF E25-513 Type L
 Page 7-16 NF E25-513 Type LL	 Page 7-18 NF E25-513 Type M	 Page 7-20 NF E25-513 Type Z	 Page 7-22 DIN 7989-1 For steel structures	 Page 7-23 DIN 7349 For bolts with heavy type spring pins
 Page 7-25 DIN 433 For cheese head screws	 Page 7-27 DIN 1440 For clevis pins	 Page 7-28 DIN 1441 For clevis pins	 Page 7-29 Aluminium - Brass	 Page 7-30 Aluminium AG3
 Page 7-31 ISO 7089 Plain	 Page 7-32 ISO 7093 Plain	 Page 7-33 DIN 125-1B With chamfer	 Page 7-35 ISO 7090 Plain	 Page 7-36 ASME ≈B18.21.1 Plain fender washer
 Page 7-37 ASME ≈B18.21.1 Plain custom fender Steel	 Page 7-38 DIN 9021 3xd	 Page 7-40 DIN 440 R For wood construction	 Page 7-42 DIN 440V For wood construction	 Page 7-43 DIN 1052 For wood construction
 Page 7-44 Repair washer	 Page 7-46 ASME ≈B18.21.1 Custom flat	 Page 7-49 DIN 127 B Square ends	 Page 7-52 ASME B18.21.1 Square ends	 Page 7-55 ASME B18.21.1 Square ends heavy
 Page 7-56 ASME B18.21.1 Square ends, extra duty	 Page 7-57 DIN 7980 For cylinder head screw	 Page 7-59 ASME B18.21.1 For cylinder head screw	 Page 7-60 Double	 Page 7-61 DIN 74361 C Conical spring washer
 Page 7-61 DIN 137 B Wave	 Page 7-63 DIN 137 A Curved	 Page 7-64 DIN 128 A Curved	 Page 7-66 DIN ≈128 A Locking edge washer	 Page 7-67 NF E25-512 Type JZC
 Page 7-68 DIN 6798 V Type V	 Page 7-69 ASME B18.21.1 External countersunk	 Page 7-69 ASME B18.21.1 External/internal	 Page 7-70 ASME B18.21.1 External	 Page 7-72 NF ≈E27-626 Type DD
 Page 7-73 DIN 6798 J Type J	 Page 7-74 ASME B18.21.1 Internal	 Page 7-76 ASME B18.21.1 Heavy	 Page 7-77 DIN 6798 A Type A	 Page 7-79 DIN 6797 J Type J

Washers & O-rings 7

 Page 7-80 DIN 6797 A Type A	 Page 7-82 DIN 43699 For switchgear plant	 Page 7-82 DIN 2093 A Type A heavy	 Page 7-83 DIN 2093 B Type B middle	 Page 7-84 DIN 2093 C Type C light
 Page 7-85 DIN 2093 Universal application	 Page 7-88 DIN ≈2093 A/C Type A heavy	 Page 7-89 DIN 6796 For bolted connections	 Page 7-90 Critical application	 Page 7-92 For ball bearing
 Page 7-93 Type M	 Page 7-94 Type Z	 Page 7-96 NORD-LOCK	 Page 7-98 NORD-LOCK Inches	 Page 7-99 NORD-LOCK large outside diameter
 Page 7-101 NORD-LOCK Large diameter Inches	 Page 7-102 NORD-LOCK X-Series	 Page 7-102 NORD-LOCK X-Series Inches	 Page 7-103 NORD-LOCK X-Series large outside diameter	 Page 7-103 NORD-LOCK X-Series large diameter Inches
 Page 7-104 Type S	 Page 7-106 Type VS	 Page 7-107 NF E25-511 Type M	 Page 7-108 Type P	 Page 7-109 DUBO For hexagon bolt and nut
 Page 7-110 DUBO For socket head screw	 Page 7-111 DUBO Toothed collar ring	 Page 7-113 DIN 93 With long tab	 Page 7-114 DIN 463 With tab and wing	 Page 7-116 DIN 462 With internal tab
 Page 7-117 DIN 432 With external tab	 Page 7-119 DIN 471 Type A	 Page 7-122 DIN 472 Type J	 Page 7-125 DIN 6799 Retaining washer	 Page 7-126 DIN 7993 A Snap ring
 Page 7-127 Fixing washer for shafts type A	 Page 7-128 Fixing washer for shafts type 4A	 Page 7-129 Fixing washer installation tool	 Page 7-129 Magnetic ferrule	 Page 7-130 Fixing washer for shafts
 Page 7-131 Type SL	 Page 7-132 With hexagon head cap screw	 Page 7-133 With 2x hexagon head cap screw	 Page 7-133 DIN 705A With set screw	 Page 7-136 DIN 705A/ISO 4027 (DIN 914) With 2 set screws
 Page 7-136 DIN 988 Shim ring	 Page 7-141 DIN 436 For wood construction	 Page 7-142 DIN 435 For I-sections	 Page 7-144 DIN 434 For U-sections	 Page 7-145 DIN 7603 A/C Sealing washer

Washers & O-rings 7

 Page 7-149 Packing ring	 Page 7-150 Flat washer for Toyota	 Page 7-150 Sealing washer with rubber	 Page 7-151 O-ring	 Page 7-157 O-ring wire
---	---	---	--	--

Plain washer

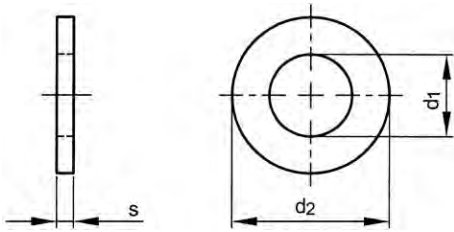

DIN 125-1A
ISO 7089
NEN 2269 A

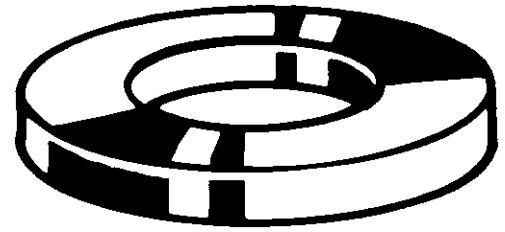

Technical Data

For nom.size	d ₁	d ₂	s	For nom.size	d ₁	d ₂	s
M1 (#DIN)	1.1	3.2	0.3	M18	19	34	3
M1.2 (#DIN)	1.3	3.8	0.3	M20	21	37	3
M1.4 (#DIN)	1.5	3.8	0.3	M22	23	39	3
M1.6	1.7	4	0.3	M24	25	44	4
M1.7	1.8	4.5	0.3	M26 (#DIN)	27.3	49.5	3.8
M2	2.2	5	0.3	M27	28	50	4
M2.5	2.7	6	0.5	M30	31	56	4
M2.6	2.8	7	0.5	M33	34	60	5
M3	3.2	7	0.5	M36	37	66	5
M3.5	3.7	8	0.5	M39	40	72	6
M4	4.3	9	0.8	M42	43	78	7
M5	5.3	10	1	M45	46	85	7
M6	6.4	12	1.6	M48	50	92	8
M7	7.4	14	1.6	M50	52	92	8
M8	8.4	16	1.6	M52	54	98	8
M10	10.5	20	2	M56	58	105	9
M11 (#DIN)	12	24	2.5	M58 (#DIN)	60	110	9
M12	13	24	2.5	M60	62	110	9
M14	15	28	2.5	M64	66	115	9
M14.5 (#DIN)	14.5	22	2.2	M72 (#DIN)	74.3	123.7	9.75
M16	17	30	3				

- Plain washers without chamfer acc. to DIN 125-1 A with a minimum hardness of 140HV.
- Because of the low compression strength these plain washers are exclusively appropriate in combination with bolts with property class < 8.8 c.q. with nuts with property class < 8.

7

Article groups

Material	Class	Surface treatment	Code	Page
St 140HV			38100	7-5
St 140HV		Zipl	38031	7-5
St 140HV		ZNTHP-NC6	38081	7-5
St 140HV		Zipl	38130	7-5
St 140HV		Zipl	38140	7-6
St 140HV		Zipl yell.p.	38080	7-6
St 140HV		Zipl blk p.	38143	7-6
St 140HV		Hot d.g.	38157	7-6
St 140HV		FLZNNC-NC6	38152	7-6
St 200HV		Zipl	38093	7-7
St 200HV		FLZNNC-NC6	38125	7-7
St.St. A2			51420	7-7
St.St. A4			55420	7-7
St.St. A5			52420	7-8
Al			45184	7-8
Br			50060	7-8
Br		Ni.pl.	50065	7-8
Plastic PA	PA 6.6		56300	7-8
Plastic PA	PA 6.6		56310	7-9
Ti			45930	7-9

38100 Plain washer L01A

Material Steel 140HV



For nom. size	☒	Art.number	For nom. size	☒	Art.number	For nom. size	☒	Art.number
M3	250	38100.030.001	M18	100	38100.180.001	M42	10	38100.420.001
M4	250	38100.040.001	M20	100	38100.200.001	M45	10	38100.450.001
M5	250	38100.050.001	M22	50	38100.220.001	M48	10	38100.480.001
M6	250	38100.060.001	M24	50	38100.240.001	M52	5	38100.520.001
M8	250	38100.080.001	M27	100	38100.270.001	M56	5	38100.560.001
M10	200	38100.100.001	M30	25	38100.300.001	M58	1	38100.580.001
M11	150	38100.110.001	M33	25	38100.330.001	M60	1	38100.600.001
M12	150	38100.120.001	M36	25	38100.360.001	M64	1	38100.640.001
M14	100	38100.140.001	M39	10	38100.390.001	M72	1	38100.720.001
M16	100	38100.160.001						

38031 Plain washer without chamfer flatpunched L01A

Material Steel 140HV
Surface treatment Zinc plated



For nom. size	☒	Art.number	For nom. size	☒	Art.number	For nom. size	☒	Art.number
M3	250	38031.030.001	M11	150	38031.110.001	M22	50	38031.220.001
M4	250	38031.040.001	M12	150	38031.120.001	M24	25	38031.240.001
M5	250	38031.050.001	M14	100	38031.140.001	M27	10	38031.270.001
M6	250	38031.060.001	M16	100	38031.160.001	M30	10	38031.300.001
M8	250	38031.080.001	M18	100	38031.180.001			
M10	200	38031.100.001	M20	100	38031.200.001			

38081 Plain washer L95A

Material Steel 140HV
Surface treatment Galvanized thick Cr³⁺ passivated



For nom. size	☒	Art.number	For nom. size	☒	Art.number	For nom. size	☒	Art.number
M3	250	38081.030.001	M10	200	38081.100.001	M22	50	38081.220.001
M4	250	38081.040.001	M12	150	38081.120.001	M24	50	38081.240.001
M5	250	38081.050.001	M14	100	38081.140.001	M27	25	38081.270.001
M6	250	38081.060.001	M16	100	38081.160.001	M30	25	38081.300.001
M7	250	38081.070.001	M18	100	38081.180.001			
M8	250	38081.080.001	M20	100	38081.200.001			

38130 Plain washer L01A

Material Steel 140HV
Surface treatment Zinc plated





For nom. size	☒	Art.number	For nom. size	☒	Art.number	For nom. size	☒	Art.number
M1,6	500	38130.016.001	M11	150	38130.110.001	M33	25	38130.330.001
M2	500	38130.020.001	M12	150	38130.120.001	M36	25	38130.360.001
M2,5	500	38130.025.001	M14	100	38130.140.001	M39	10	38130.390.001
M2,6	500	38130.026.001	M16	100	38130.160.001	M42	10	38130.420.001
M3	250	38130.030.001	M18	100	38130.180.001	M45	10	38130.450.001
M4	250	38130.040.001	M20	100	38130.200.001	M48	10	38130.480.001
M5	250	38130.050.001	M22	50	38130.220.001	M52	5	38130.520.001
M6	250	38130.060.001	M24	50	38130.240.001	M56	5	38130.560.001
M7	250	38130.070.001	M26	50	38130.260.001	M60	5	38130.600.001
M8	250	38130.080.001	M27	25	38130.270.001	M64	5	38130.640.001
M10	200	38130.100.001	M30	25	38130.300.001			

38140	Plain washer						L01A
Material	Steel 140HV						
Surface treatment	Zinc plated						
							

For nom. size	☒	Art.number	For nom. size	☒	Art.number	For nom. size	☒	Art.number
M2		2500 38140.020.001	M6		2000 38140.060.001	M14		400 38140.140.001
M3		2500 38140.030.001	M8		2000 38140.080.001	M16		400 38140.160.001
M3,5		2500 38140.035.001	M10		1000 38140.100.001	M20		250 38140.200.001
M4		2500 38140.040.001	M11		500 38140.110.001	M24		250 38140.240.001
M5		2500 38140.050.001	M12		500 38140.120.001			

38080	Plain washer						L01A
Material	Steel 140HV						
Surface treatment	Zinc plated yellow passivated						



For nom. size	☒	Art.number	For nom. size	☒	Art.number	For nom. size	☒	Art.number
M3		250 38080.030.001	M10		200 38080.100.001	M20		100 38080.200.001
M4		250 38080.040.001	M11		150 38080.110.001	M22		50 38080.220.001
M5		250 38080.050.001	M12		150 38080.120.001	M24		50 38080.240.001
M6		250 38080.060.001	M14		100 38080.140.001	M27		25 38080.270.001
M7		250 38080.070.001	M16		100 38080.160.001	M30		25 38080.300.001
M8		250 38080.080.001	M18		100 38080.180.001	M33		25 38080.330.001

38143	Plain washer						L01A
Material	Steel 140HV						
Surface treatment	Zinc plated black passivated						

For nom. size	☒	Art.number	For nom. size	☒	Art.number	For nom. size	☒	Art.number
M3		250 38143.030.001	M8		250 38143.080.001	M14		100 38143.140.001
M4		250 38143.040.001	M10		200 38143.100.001	M16		100 38143.160.001
M5		250 38143.050.001	M12		150 38143.120.001	M20		100 38143.200.001
M6		250 38143.060.001						

38157	Plain washer						A08A
Material	Steel 140HV						
Surface treatment	Hot dip galvanized						
							

For nom. size	☒	Art.number	For nom. size	☒	Art.number	For nom. size	☒	Art.number
M8		200 38157.080.001	M18		100 38157.180.001	M27		50 38157.270.001
M10		200 38157.100.001	M20		100 38157.200.001	M30		50 38157.300.001
M12		150 38157.120.001	M24		100 38157.240.001	M36		50 38157.360.001
M16		100 38157.160.001						

38152	Plain washer						L01A
Material	Steel 140HV						
Surface treatment	Zinc flake Cr ⁶⁺ free - ISO 10683 flZnnc						
							

For nom. size	☒	Art.number	For nom. size	☒	Art.number	For nom. size	☒	Art.number
M6		250 38152.060.001	M14		100 38152.140.001	M24		50 38152.240.001
M8		250 38152.080.001	M16		100 38152.160.001	M27		50 38152.270.001
M10		200 38152.100.001	M20		100 38152.200.001	M30		25 38152.300.001
M12		150 38152.120.001						

7

38093 Plain washer L01A

Material Steel 200HV
Surface treatment Zinc plated



For nom. size	☒	Art.number	For nom. size	☒	Art.number	For nom. size	☒	Art.number
M6	250	38093.060.001	M16	100	38093.160.001	M27	25	38093.270.001
M8	250	38093.080.001	M18	100	38093.180.001	M30	25	38093.300.001
M10	200	38093.100.001	M20	100	38093.200.001	M33	25	38093.330.001
M12	150	38093.120.001	M24	50	38093.240.001	M36	25	38093.360.001
M14	100	38093.140.001						

38125 Plain washer L01A

Material Steel 200HV
Surface treatment Zinc flake Cr⁶⁺ free - ISO 10683 flZnnc



For nom. size	☒	Art.number	For nom. size	☒	Art.number	For nom. size	☒	Art.number
M6	250	38125.060.001	M12	150	38125.120.001	M24	50	38125.240.001
M8	250	38125.080.001	M16	100	38125.160.001	M30	25	38125.300.001
M10	200	38125.100.001	M20	100	38125.200.001			

51420 Plain washer R05A

Material Stainless steel A2





For nom. size	☒	Art.number	For nom. size	☒	Art.number	For nom. size	☒	Art.number
M1,2	200	51420.012.001	M7	500	51420.070.001	M27	50	51420.270.001
M1,6	200	51420.016.001	M8	500	51420.080.001	M30	50	51420.300.001
M1,7*	2000	51420.017.001	M10	500	51420.100.001	M33	50	51420.330.001
M2	200	51420.020.001	M12	500	51420.120.001	M36	50	51420.360.001
M2,5	200	51420.025.001	M14	200	51420.140.001	M39	25	51420.390.001
M3	500	51420.030.001	M16	200	51420.160.001	M40*	25	51420.400.001
M3,5	500	51420.035.001	M18	200	51420.180.001	M42	20	51420.420.001
M4	500	51420.040.001	M20	200	51420.200.001	M46*	10	51420.460.001
M5	500	51420.050.001	M22	100	51420.220.001	M50*	10	51420.500.001
M6	500	51420.060.001	M24	100	51420.240.001	M52	10	51420.520.001

55420 Plain washer R45A

Material Stainless steel A4





For nom. size	☒	Art.number	For nom. size	☒	Art.number	For nom. size	☒	Art.number
M1,6	200	55420.016.001	M8	500	55420.080.001	M27	50	55420.270.001
M1,7*	2000	55420.017.001	M10	500	55420.100.001	M30	50	55420.300.001
M2	200	55420.020.001	M12	500	55420.120.001	M33	50	55420.330.001
M2,5	200	55420.025.001	M14	200	55420.140.001	M36	50	55420.360.001
M3	500	55420.030.001	M16	200	55420.160.001	M39*	25	55420.390.001
M3,5*	1000	55420.035.001	M18	200	55420.180.001	M42*	25	55420.420.001
M4	500	55420.040.001	M20	200	55420.200.001	M45	10	55420.450.001
M5	500	55420.050.001	M22	100	55420.220.001	M50*	10	55420.500.001
M6	500	55420.060.001	M24	100	55420.240.001	M52*	10	55420.520.001
M7	500	55420.070.001						

52420	Plain washer	R45A
Material	Stainless steel A5	
		

For nom. size	☒	Art.number	For nom. size	☒	Art.number	For nom. size	☒	Art.number
M6*	1000	52420.060.001	M12*	200	52420.120.001	M24*	100	52420.240.001
M8*	500	52420.080.001	M16*	200	52420.160.001	M27*	50	52420.270.001
M10*	500	52420.100.001	M20*	200	52420.200.001			

45184	Plain washer	W010
Material	Aluminium	
		

For nom. size	☒	Art.number	For nom. size	☒	Art.number	For nom. size	☒	Art.number
M3	250	45184.030.001	M8	250	45184.080.001	M16	100	45184.160.001
M4	250	45184.040.001	M10	200	45184.100.001	M20	100	45184.200.001
M5	250	45184.050.001	M12	150	45184.120.001	M30	50	45184.300.001
M6	250	45184.060.001						

50060	Plain washer	M11F
Material	Brass	
		

For nom. size	☒	Art.number	For nom. size	☒	Art.number	For nom. size	☒	Art.number
M3	250	50060.030.001	M8	250	50060.080.001	M16	100	50060.160.001
M4	250	50060.040.001	M10	100	50060.100.001	M18	50	50060.180.001
M5	250	50060.050.001	M12	100	50060.120.001	M20	50	50060.200.001
M6	250	50060.060.001	M14	100	50060.140.001	M24	50	50060.240.001
M7	250	50060.070.001						

50065	Plain washer	M11F
Material	Brass	
Surface treatment	Nickel plated	
		

For nom. size	☒	Art.number	For nom. size	☒	Art.number	For nom. size	☒	Art.number
M3	250	50065.030.001	M8	250	50065.080.001	M16	100	50065.160.001
M4	250	50065.040.001	M10	100	50065.100.001	M20	50	50065.200.001
M5	250	50065.050.001	M12	100	50065.120.001	M24	50	50065.240.001
M6	250	50065.060.001						

56300	Plain washer	W02A
Material	Plastic Polyamide (nylon)	
Class	PA 6.6	

For nom. size	☒	Art.number	For nom. size	☒	Art.number	For nom. size	☒	Art.number
M1,8	200	56300.018.001	M8	200	56300.080.001	M20	50	56300.200.001
M2	200	56300.020.001	M10	100	56300.100.001	M22	50	56300.220.001
M2,5	200	56300.025.001	M12	100	56300.120.001	M24	50	56300.240.001
M3	200	56300.030.001	M14	100	56300.140.001	M27	50	56300.270.001
M4	200	56300.040.001	M14,5	100	56300.145.001	M30	50	56300.300.001
M5	200	56300.050.001	M16	50	56300.160.001	M33	50	56300.330.001
M6	200	56300.060.001	M18	100	56300.180.001	M36	50	56300.360.001

56310 Plain washer W02A

Material Class Plastic Polyamide (nylon)
PA 6.6



For nom. size	☒	Art.number	For nom. size	☒	Art.number	For nom. size	☒	Art.number
M3		1000 56310.030.001	M8		1000 56310.080.001	M14		500 56310.140.001
M4		1000 56310.040.001	M10		500 56310.100.001	M16		500 56310.160.001
M5		1000 56310.050.001	M12		500 56310.120.001	M20		500 56310.200.001
M6		1000 56310.060.001						

45930 Plain washer W01A

Material Titanium



For nom. size	☒	Art.number	For nom. size	☒	Art.number	For nom. size	☒	Art.number
M6		25 45930.060.001	M8		25 45930.080.001	M10		25 45930.100.001

- Titanium Grade 2 (materialnumber 3.7035) with a high percentage of pure titanium, ensures product stability and -suitability in extremely corrosive environments where other materials i.e. stainless steel fail.
- Titanium Grade 2 is also suitable for other light loaded applications.

Plain washer USS

ASME B18.21.1

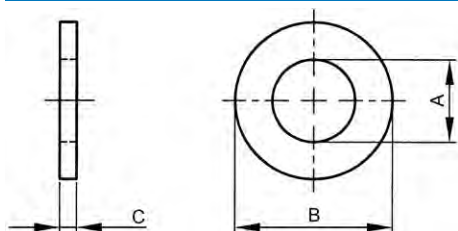

Technical Data



For nom.size	A	B	C
1/4	0.312	0.734	0.065
5/16	0.375	0.875	0.083
3/8	0.438	1.000	0.083
7/16	0.500	1.250	0.083
1/2	0.562	1.375	0.109
9/16	0.625	1.469	0.109
5/8	0.688	1.750	0.134
3/4	0.812	2.000	0.148
7/8	0.938	2.250	0.165
1 Inch	1.062	2.500	0.165
1.1/8	1.250	2.750	0.165
1.1/4	1.375	3.000	0.165
1.3/8	1.500	3.250	0.180
1.1/2	1.625	3.500	0.180

Article groups

Material	Surface treatment	Code	Page
St		U38100	7-10
St	Zipl	U38130	7-10
St	Hot d.g.	U38157	7-10
St.St. A2 (AISI304/18-8)		U51420	7-10
St.St. A4 (AISI316/18-10)		U55420	7-10

U38100 Plain washer USS X09A

Material Steel

For nom. size	☒	Art.number	For nom. size	☒	Art.number	For nom. size	☒	Art.number
1/4*	100	U38100.025.0001	9/16*	25	U38100.056.0001	1.1/8*	5	U38100.112.0001
5/16*	100	U38100.031.0001	5/8*	25	U38100.062.0001	1.1/4*	5	U38100.125.0001
3/8*	100	U38100.037.0001	3/4*	20	U38100.075.0001	1.3/8*	5	U38100.137.0001
7/16*	50	U38100.043.0001	7/8*	10	U38100.087.0001	1.1/2*	5	U38100.150.0001
1/2*	50	U38100.050.0001	1 Inch*	5	U38100.100.0001			

U38130 Plain washer USS X09A

Material Steel
Surface treatment Zinc plated



For nom. size	☒	Art.number	For nom. size	☒	Art.number	For nom. size	☒	Art.number
1/4*	100	U38130.025.0001	9/16*	25	U38130.056.0001	1.1/8*	5	U38130.112.0001
5/16*	100	U38130.031.0001	5/8*	25	U38130.062.0001	1.1/4*	5	U38130.125.0001
3/8*	100	U38130.037.0001	3/4*	20	U38130.075.0001	1.3/8*	5	U38130.137.0001
7/16*	50	U38130.043.0001	7/8*	10	U38130.087.0001	1.1/2*	5	U38130.150.0001
1/2*	50	U38130.050.0001	1 Inch*	5	U38130.100.0001			

U38157 Plain washer USS X09A

Material Steel
Surface treatment Hot dip galvanized



For nom. size	☒	Art.number	For nom. size	☒	Art.number	For nom. size	☒	Art.number
1/4*	100	U38157.025.0001	9/16*	25	U38157.056.0001	1.1/8*	5	U38157.112.0001
5/16*	100	U38157.031.0001	5/8*	25	U38157.062.0001	1.1/4*	5	U38157.125.0001
3/8*	100	U38157.037.0001	3/4*	20	U38157.075.0001	1.3/8*	5	U38157.137.0001
7/16*	50	U38157.043.0001	7/8*	10	U38157.087.0001	1.1/2*	5	U38157.150.0001
1/2*	50	U38157.050.0001	1 Inch*	5	U38157.100.0001			

U51420 Plain washer USS X15A

Material Stainless steel A2 (AISI 304/18-8)

For nom. size	☒	Art.number	For nom. size	☒	Art.number	For nom. size	☒	Art.number
1/4*	50	U51420.025.0001	9/16*	25	U51420.056.0001	1.1/8*	5	U51420.112.0001
5/16*	50	U51420.031.0001	5/8*	25	U51420.062.0001	1.1/4*	5	U51420.125.0001
3/8*	50	U51420.037.0001	3/4*	20	U51420.075.0001	1.3/8*	5	U51420.137.0001
7/16*	25	U51420.043.0001	7/8*	5	U51420.087.0001	1.1/2*	5	U51420.150.0001
1/2*	25	U51420.050.0001	1 Inch*	5	U51420.100.0001			

U55420 Plain washer USS X15A

Material Stainless steel A4 (AISI 316/18-10)





For nom. size	☒	Art.number	For nom. size	☒	Art.number	For nom. size	☒	Art.number
1/4*	50	U55420.025.0001	1/2*	25	U55420.050.0001	1.1/8*	5	U55420.112.0001
5/16*	50	U55420.031.0001	5/8*	25	U55420.062.0001	1.1/4*	5	U55420.125.0001
3/8*	50	U55420.037.0001	7/8*	5	U55420.087.0001	1.3/8*	5	U55420.137.0001
7/16*	25	U55420.043.0001	1 Inch*	5	U55420.100.0001	1.1/2*	5	U55420.150.0001

7

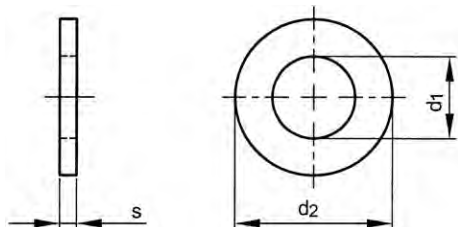
Plain washer

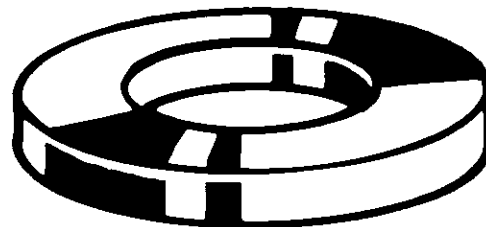

DIN 126
ISO 7091
NEN 2268
NF E25-513



Technical Data

For nom.size	d ₁	d ₂	s	For nom.size	d ₁	d ₂	s
M5	5.5	10	1	M33	36	60	5
M6	6.6	12	1.6	M36	39	66	5
M8	9	16	1.6	M39	42	72	6
M10	11	20	2	M42	45	78	7
M12	13.5	24	2.5	M45	48	85	7
M14	15.5	28	3	M48	52	92	8
M16	17.5	30	3	M52	56	98	8
M18	20	34	3	M56	62	105	9
M20	22	37	3	M60	66	110	9
M22	24	39	3	M64	70	115	9
M24	26	44	4	M72	78	125	10
M27	30	50	4	M80	86	140	12
M30	33	56	4	M90	96	160	12

Article groups

Material	Surface treatment	Code	Page
St		38200	7-11
St	Zipl	38205	7-11
St	Hot d.g.	38740	7-12

38200 Plain washer

L07G

Material Steel



For nom. size	☒	Art.number	For nom. size	☒	Art.number	For nom. size	☒	Art.number
M5	1000	38200.050.001	M24	100	38200.240.001	M52	25	38200.520.001
M6	1000	38200.060.001	M27	100	38200.270.001	M56	25	38200.560.001
M8	1000	38200.080.001	M30	100	38200.300.001	M60	10	38200.600.001
M10	1000	38200.100.001	M33	100	38200.330.001	M64	10	38200.640.001
M12	500	38200.120.001	M36	100	38200.360.001	M72	10	38200.720.001
M14	250	38200.140.001	M39	50	38200.390.001	M80	5	38200.800.001
M16	250	38200.160.001	M42	50	38200.420.001	M90	5	38200.900.001
M20	200	38200.200.001	M45	25	38200.450.001			
M22	100	38200.220.001	M48	25	38200.480.001			

38205 Plain washer

L07G

Material Steel
Surface treatment Zinc plated



For nom. size	☒	Art.number	For nom. size	☒	Art.number	For nom. size	☒	Art.number
M6	1000	38205.060.001	M18	200	38205.180.001	M33	100	38205.330.001
M8	1000	38205.080.001	M20	200	38205.200.001	M36	100	38205.360.001
M10	1000	38205.100.001	M22	200	38205.220.001	M39	50	38205.390.001
M12	500	38205.120.001	M24	100	38205.240.001	M52	10	38205.520.001
M14	100	38205.140.001	M27	100	38205.270.001			
M16	250	38205.160.001	M30	100	38205.300.001			

38740	Plain washer	A08G
Material	Steel	
Surface treatment	Hot dip galvanized	
		 

For nom. size	☒	Art.number	For nom. size	☒	Art.number	For nom. size	☒	Art.number
M6	1000	38740.060.001	M22	100	38740.220.001	M42	50	38740.420.001
M8	1000	38740.080.001	M24	100	38740.240.001	M45	25	38740.450.001
M10	1000	38740.100.001	M27	100	38740.270.001	M48	25	38740.480.001
M12	500	38740.120.001	M30	100	38740.300.001	M52	25	38740.520.001
M14	100	38740.140.001	M33	100	38740.330.001	M56	25	38740.560.001
M16	250	38740.160.001	M36	100	38740.360.001	M60	10	38740.600.001
M18	250	38740.180.001	M39	50	38740.390.001	M64	10	38740.640.001
M20	200	38740.200.001						

Plain washer SAE

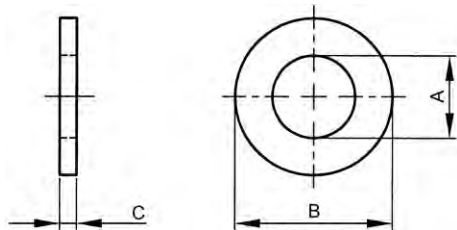

ASME B18.21.1

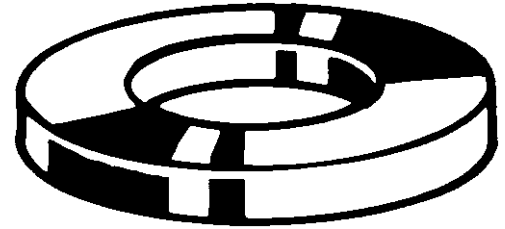



Technical Data

For nom.size	A	B	C
1/4	0.281	0.625	0.065
5/16	0.344	0.688	0.065
3/8	0.406	0.812	0.065
7/16	0.469	0.922	0.065
1/2	0.531	1.062	0.095
9/16	0.594	1.156	0.095
5/8	0.656	1.312	0.095
3/4	0.812	1.469	0.134
7/8	0.938	1.750	0.134
1 Inch	1.062	2.000	0.134
1.1/8	1.250	2.250	0.134
1.1/4	1.375	2.500	0.165
1.3/8	1.500	2.750	0.165
1.1/2	1.625	3.000	0.165

Article groups

Material	Surface treatment	Code	Page
St		U38200	7-12
St	Zipl	U38205	7-13
St.St. A2 (AISI304/18-8)		U51205	7-13
St.St. A4 (AISI316/18-10)		U55205	7-13

U38200	Plain washer SAE	X09A
Material	Steel	
		 

For nom. size	☒	Art.number	For nom. size	☒	Art.number	For nom. size	☒	Art.number
1/4*	100	U38200.025.0001	9/16*	25	U38200.056.0001	1.1/8*	5	U38200.112.0001
5/16*	100	U38200.031.0001	5/8*	25	U38200.062.0001	1.1/4*	5	U38200.125.0001
3/8*	100	U38200.037.0001	3/4*	20	U38200.075.0001	1.3/8*	5	U38200.137.0001
7/16*	50	U38200.043.0001	7/8*	10	U38200.087.0001	1.1/2*	5	U38200.150.0001
1/2*	50	U38200.050.0001	1 Inch*	5	U38200.100.0001			

U38205 Plain washer SAE X09A

Material Steel
Surface treatment Zinc plated



For nom. size	☒	Art.number	For nom. size	☒	Art.number	For nom. size	☒	Art.number
1/4*	100	U38205.025.0001	9/16*	25	U38205.056.0001	1.1/8*	5	U38205.112.0001
5/16*	100	U38205.031.0001	5/8*	25	U38205.062.0001	1.1/4*	5	U38205.125.0001
3/8*	100	U38205.037.0001	3/4*	20	U38205.075.0001	1.3/8*	5	U38205.137.0001
7/16*	50	U38205.043.0001	7/8*	10	U38205.087.0001	1.1/2*	5	U38205.150.0001
1/2*	50	U38205.050.0001	1 Inch*	5	U38205.100.0001			

U51205 Plain washer SAE X15A

Material Stainless steel A2 (AISI 304/18-8)



For nom. size	☒	Art.number	For nom. size	☒	Art.number	For nom. size	☒	Art.number
1/4*	50	U51205.025.0001	9/16*	25	U51205.056.0001	1.1/8*	5	U51205.112.0001
5/16*	50	U51205.031.0001	5/8*	25	U51205.062.0001	1.1/4*	5	U51205.125.0001
3/8*	50	U51205.037.0001	3/4*	20	U51205.075.0001	1.3/8*	5	U51205.137.0001
7/16*	25	U51205.043.0001	7/8*	5	U51205.087.0001	1.1/2*	5	U51205.150.0001
1/2*	25	U51205.050.0001	1 Inch*	5	U51205.100.0001			

U55205 Plain washer SAE X15A

Material Stainless steel A4 (AISI 316/18-10)



For nom. size	☒	Art.number	For nom. size	☒	Art.number	For nom. size	☒	Art.number
1/4*	50	U55205.025.0001	9/16*	25	U55205.056.0001	1.1/8*	5	U55205.112.0001
5/16*	50	U55205.031.0001	5/8*	25	U55205.062.0001	1.1/4*	5	U55205.125.0001
3/8*	50	U55205.037.0001	3/4*	20	U55205.075.0001	1.3/8*	5	U55205.137.0001
7/16*	25	U55205.043.0001	7/8*	5	U55205.087.0001	1.1/2*	5	U55205.150.0001
1/2*	25	U55205.050.0001	1 Inch*	5	U55205.100.0001			

Plain washer type L

NF E25-513

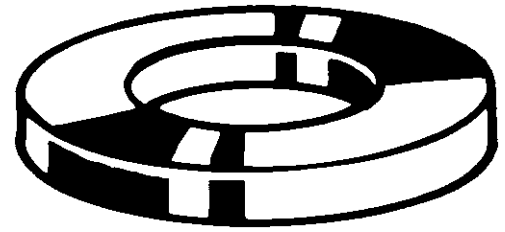
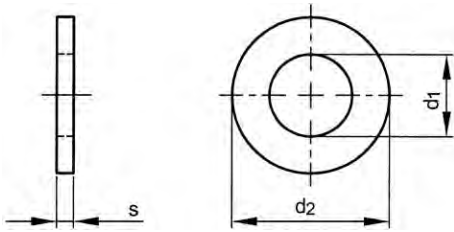

Technical Data

For nom.size	d ₁ (min.)	d ₂ (max.)	s	For nom.size	d ₁ (min.)	d ₂ (max.)	s
M3	3.2	12	0.8	M14	15	36	2.5
M4	4.3	14	0.8	M16	17	40	3
M5	5.3	16	1	M18	19	45	3
M6	6.4	18	1.2	M20	21	50	3
M7	7.4	20	1.5	M22	23	55	3
M8	8.4	22	1.5	M24	25	60	4
M10	10.5	27	2	M27	28	65	4
M12	13	32	2.5	M30	31	70	4

Article groups

Material	Surface treatment	Code	Page
St		38063	7-14
St	Zipl	38065	7-14
St	Zipl yell.p.	38067	7-15
St.St. A2		51418	7-15
St.St. A4		55418	7-15

7

38063 Plain washer type L L07G

Material: Steel



For nom. size	☒	Art.number	For nom. size	☒	Art.number	For nom. size	☒	Art.number
M3	500	38063.030.001	M10	200	38063.100.001	M22	100	38063.220.001
M4	500	38063.040.001	M12	200	38063.120.001	M24	100	38063.240.001
M5	500	38063.050.001	M14	200	38063.140.001	M27	100	38063.270.001
M6	500	38063.060.001	M16	100	38063.160.001	M30	100	38063.300.001
M7	250	38063.070.001	M18	100	38063.180.001			
M8	250	38063.080.001	M20	100	38063.200.001			

38065 Plain washer type L L07G

Material: Steel
Surface treatment: Zinc plated



For nom. size	☒	Art.number	For nom. size	☒	Art.number	For nom. size	☒	Art.number
M3	500	38065.030.001	M10	200	38065.100.001	M22	100	38065.220.001
M4	500	38065.040.001	M12	200	38065.120.001	M24	100	38065.240.001
M5	500	38065.050.001	M14	200	38065.140.001	M27	100	38065.270.001
M6	500	38065.060.001	M16	100	38065.160.001	M30	100	38065.300.001
M7	250	38065.070.001	M18	100	38065.180.001			
M8	250	38065.080.001	M20	100	38065.200.001			

38067	Plain washer type L	L07G
Material	Steel	
Surface treatment	Zinc plated yellow passivated	

For nom. size	☒	Art.number	For nom. size	☒	Art.number	For nom. size	☒	Art.number
M3	500	38067.030.001	M10	200	38067.100.001	M22	100	38067.220.001
M4	500	38067.040.001	M12	200	38067.120.001	M24	100	38067.240.001
M5	500	38067.050.001	M14	100	38067.140.001	M27	100	38067.270.001
M6	500	38067.060.001	M16	100	38067.160.001	M30	100	38067.300.001
M7	250	38067.070.001	M18	100	38067.180.001			
M8	250	38067.080.001	M20	100	38067.200.001			

51418	Plain washer type L	R05A
Material	Stainless steel A2	
	NF ≈E25-513	

For nom. size	☒	Art.number	For nom. size	☒	Art.number	For nom. size	☒	Art.number
M3	250	51418.030.001	M10	250	51418.100.001	M18	100	51418.180.001
M4	250	51418.040.001	M12	200	51418.120.001	M20	100	51418.200.001
M5	250	51418.050.001	M14	200	51418.140.001	M24	50	51418.240.001
M6	250	51418.060.001	M16	100	51418.160.001	M27	50	51418.270.001
M8	250	51418.080.001						

55418	Plain washer type L	R45A
Material	Stainless steel A4	
	NF ≈E25-513	

For nom. size	☒	Art.number	For nom. size	☒	Art.number	For nom. size	☒	Art.number
M3	250	55418.030.001	M10	250	55418.100.001	M20	100	55418.200.001
M4	250	55418.040.001	M12	200	55418.120.001	M24	50	55418.240.001
M5	250	55418.050.001	M14	200	55418.140.001	M27	50	55418.270.001
M6	250	55418.060.001	M16	100	55418.160.001	M30	25	55418.300.001
M8	250	55418.080.001	M18	100	55418.180.001			

Plain washer type LL

NF E25-513

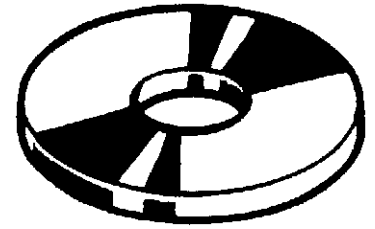
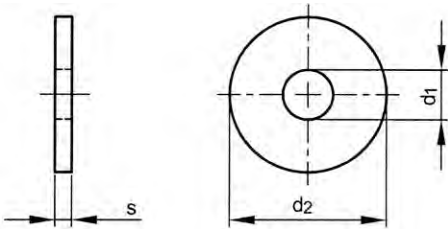

Technical Data

For nom.size	d ₁ (min.)	d ₂ (max.)	s	For nom.size	d ₁ (min.)	d ₂ (max.)	s
M3	3.2	14	0.8	M14	15	45	2.5
M4	4.3	16	0.8	M16	17	50	3
M5	5.3	20	1	M18	19	55	3
M6	6.4	24	1.2	M20	21	60	3
M7	7.4	27	1.5	M22 (#NF)	23	65	3
M8	8.4	30	1.5	M24 (#NF)	25	70	4
M10	10.5	36	2	M27 (#NF)	28	78	4
M12	13	40	2.5	M30 (#NF)	31	80	4



Article groups

Material	Surface treatment	Code	Page
St		38073	7-16
St	Zipl	38075	7-16
St	Zipl yell.p.	38077	7-17
St.St. A2		51419	7-17
St.St. A4		55419	7-17

7

38073 Plain washer type LL L07G

Material: Steel

For nom. size	Art.number	For nom. size	Art.number	For nom. size	Art.number
M3	1000 38073.030.001	M10	200 38073.100.001	M22	100 38073.220.001
M4	500 38073.040.001	M12	200 38073.120.001	M24	100 38073.240.001
M5	500 38073.050.001	M14	100 38073.140.001	M27	100 38073.270.001
M6	250 38073.060.001	M16	100 38073.160.001	M30	100 38073.300.001
M7	250 38073.070.001	M18	100 38073.180.001		
M8	250 38073.080.001	M20	100 38073.200.001		

38075 Plain washer type LL L07G



Material: Steel
Surface treatment: Zinc plated





For nom. size	Art.number	For nom. size	Art.number	For nom. size	Art.number
M3	1000 38075.030.001	M10	200 38075.100.001	M22	100 38075.220.001
M4	500 38075.040.001	M12	200 38075.120.001	M24	100 38075.240.001
M5	500 38075.050.001	M14	100 38075.140.001	M27	100 38075.270.001
M6	250 38075.060.001	M16	100 38075.160.001	M30	100 38075.300.001
M7	250 38075.070.001	M18	100 38075.180.001		
M8	250 38075.080.001	M20	100 38075.200.001		

38077	Plain washer type LL	L07G
Material	Steel	
Surface treatment	Zinc plated yellow passivated	

For nom. size	☒	Art.number	For nom. size	☒	Art.number	For nom. size	☒	Art.number
M3		1000 38077.030.001	M10		200 38077.100.001	M22		100 38077.220.001
M4		500 38077.040.001	M12		200 38077.120.001	M24		100 38077.240.001
M5		500 38077.050.001	M14		100 38077.140.001	M27		100 38077.270.001
M6		250 38077.060.001	M16		100 38077.160.001	M30		100 38077.300.001
M7		250 38077.070.001	M18		100 38077.180.001			
M8		250 38077.080.001	M20		100 38077.200.001			

51419	Plain washer type LL	R05A
Material	Stainless steel A2	NF ≈E25-513
		
		

For nom. size	☒	Art.number	For nom. size	☒	Art.number	For nom. size	☒	Art.number
M3*		500 51419.030.001	M6		250 51419.060.001	M12		200 51419.120.001
M4		250 51419.040.001	M8		250 51419.080.001	M14		100 51419.140.001
M5		250 51419.050.001	M10		250 51419.100.001	M16		100 51419.160.001

55419	Plain washer type LL	R45A
Material	Stainless steel A4	NF ≈E25-513
		
		

For nom. size	☒	Art.number	For nom. size	☒	Art.number	For nom. size	☒	Art.number
M3*		500 55419.030.001	M6		250 55419.060.001	M12		200 55419.120.001
M4*		500 55419.040.001	M8		250 55419.080.001	M16*		50 55419.160.001
M5*		200 55419.050.001	M10		250 55419.100.001			

Plain washer type M

NF E25-513

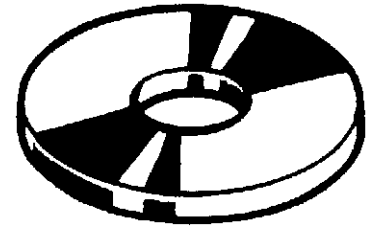
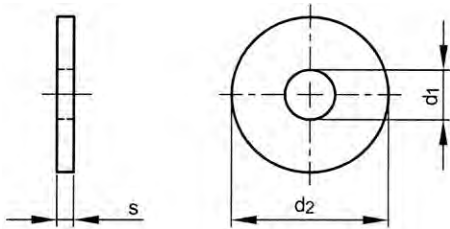

Technical Data

For nom.size	d ₁ (min.)	d ₂ (max.)	s	For nom.size	d ₁ (min.)	d ₂ (max.)	s
M2	2.0	5.5	0.5	M20	21	40	3
M2.5 (#DIN)	2.7	7	0.5	M22	23	45	3
M3	3.2	8	0.8	M24	25	50	4
M4	4.3	10	0.8	M27	28	55	4
M5	5.3	12	1	M30	31	60	4
M6	6.4	14	1.2	M33	34	65	5
M7	7.4	16	1.5	M36	37	70	5
M8	8.4	18	1.5	M39	40	75	6
M10	10.5	22	2	M42	43	80	6
M12	13	27	2.5	M45	46	85	7
M14	15	30	2.5	M48	50	90	7
M16	17	32	3	M52	54	100	8
M18	19	36	3	M56 (#NF)	60	105	9

Article groups

Material	Surface treatment	Code	Page
St		38053	7-18
St	Zipl	38055	7-18
St	Zipl yell.p.	38057	7-19
St.St. A2		51417	7-19
St.St. A4		55417	7-19

7

38053 Plain washer type M L07G

Material: Steel



For nom. size	☒	Art.number	For nom. size	☒	Art.number	For nom. size	☒	Art.number
M3	500	38053.030.001	M14	200	38053.140.001	M33	100	38053.330.001
M4	500	38053.040.001	M16	100	38053.160.001	M36	100	38053.360.001
M5	500	38053.050.001	M18	100	38053.180.001	M39	100	38053.390.001
M6	500	38053.060.001	M20	100	38053.200.001	M42	100	38053.420.001
M7	250	38053.070.001	M22	100	38053.220.001	M45	100	38053.450.001
M8	250	38053.080.001	M24	100	38053.240.001	M48	25	38053.480.001
M10	200	38053.100.001	M27	100	38053.270.001	M52	25	38053.520.001
M12	200	38053.120.001	M30	100	38053.300.001	M56	25	38053.560.001

38055 Plain washer type M L07G



Material: Steel
Surface treatment: Zinc plated



For nom. size	☒	Art.number	For nom. size	☒	Art.number	For nom. size	☒	Art.number
M3	500	38055.030.001	M12	200	38055.120.001	M27	100	38055.270.001
M4	500	38055.040.001	M14	200	38055.140.001	M30	100	38055.300.001
M5	500	38055.050.001	M16	100	38055.160.001	M33	100	38055.330.001
M6	500	38055.060.001	M18	100	38055.180.001	M36	100	38055.360.001
M7	250	38055.070.001	M20	100	38055.200.001	M39	100	38055.390.001
M8	250	38055.080.001	M22	100	38055.220.001	M42	100	38055.420.001
M10	200	38055.100.001	M24	100	38055.240.001	M45	100	38055.450.001

38057	Plain washer type M	L07G
Material	Steel	
Surface treatment	Zinc plated yellow passivated	

For nom. size	☒	Art.number	For nom. size	☒	Art.number	For nom. size	☒	Art.number
M3	500	38057.030.001	M14	200	38057.140.001	M30	100	38057.300.001
M4	500	38057.040.001	M16	100	38057.160.001	M33	100	38057.330.001
M5	500	38057.050.001	M18	100	38057.180.001	M36	100	38057.360.001
M6	500	38057.060.001	M20	100	38057.200.001	M39	100	38057.390.001
M7	250	38057.070.001	M22	100	38057.220.001	M42	100	38057.420.001
M8	250	38057.080.001	M24	100	38057.240.001	M45	100	38057.450.001
M10	200	38057.100.001	M27	100	38057.270.001	M48	50	38057.480.001
M12	200	38057.120.001						

51417	Plain washer type M	R05A	
Material	Stainless steel A2	NF ≈E25-513	
			

For nom. size	☒	Art.number	For nom. size	☒	Art.number	For nom. size	☒	Art.number
M2*	500	51417.020.001	M10	250	51417.100.001	M22	50	51417.220.001
M2,5	250	51417.025.001	M12	200	51417.120.001	M24	50	51417.240.001
M3	250	51417.030.001	M14	100	51417.140.001	M27	25	51417.270.001
M4	250	51417.040.001	M16	100	51417.160.001	M30	25	51417.300.001
M5	250	51417.050.001	M18	100	51417.180.001	M33	25	51417.330.001
M6	250	51417.060.001	M20	100	51417.200.001	M36	25	51417.360.001
M8	250	51417.080.001						

55417	Plain washer type M	R45A	
Material	Stainless steel A4	NF ≈E25-513	
			

For nom. size	☒	Art.number	For nom. size	☒	Art.number	For nom. size	☒	Art.number
M2*	500	55417.020.001	M10	250	55417.100.001	M22	50	55417.220.001
M2,5*	500	55417.025.001	M12	200	55417.120.001	M24	50	55417.240.001
M3	250	55417.030.001	M14	100	55417.140.001	M27	25	55417.270.001
M4	250	55417.040.001	M16	100	55417.160.001	M30	25	55417.300.001
M5	250	55417.050.001	M18	100	55417.180.001	M33	25	55417.330.001
M6	250	55417.060.001	M20	100	55417.200.001	M36	25	55417.360.001
M8	250	55417.080.001						

Plain washer type Z

NF E25-513

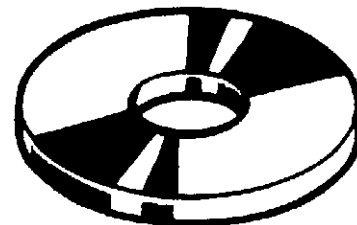
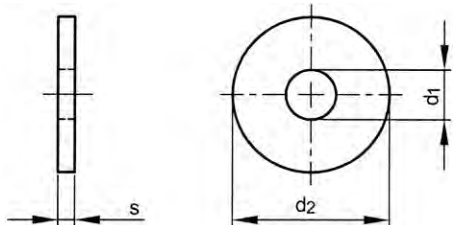

Technical Data

For nom.size	d ₁ (min.)	d ₂ (max.)	s	For nom.size	d ₁ (min.)	d ₂ (max.)	s
M2	2.2	4	0.5	M12	13	24	2.5
M2.5	2.7	5	0.5	M14	15	27	2.5
M3	3.2	6	0.8	M16	17	30	3
M4	4.3	8	0.8	M18	19	32	3
M5	5.3	10	1	M20	21	36	3
M6	6.4	12	1.2	M22	23	40	3
M7	7.4	14	1.5	M24	25	45	4
M8	8.4	16	1.5	M27	28	48	4
M10	10.5	20	2	M30	31	52	4

Article groups

Material	Surface treatment	Code	Page
St		38043	7-20
St	Zipl	38045	7-20
St	Zipl yell.p.	38047	7-21
St.St. A2		51416	7-21
St.St. A4		55416	7-21

38043 Plain washer type Z

L07G

Material Steel



For nom. size	☒	Art.number	For nom. size	☒	Art.number	For nom. size	☒	Art.number
M3	500	38043.030.001	M10	200	38043.100.001	M20	100	38043.200.001
M4	500	38043.040.001	M12	150	38043.120.001	M22	100	38043.220.001
M5	500	38043.050.001	M14	100	38043.140.001	M24	100	38043.240.001
M6	250	38043.060.001	M16	100	38043.160.001	M27	100	38043.270.001
M8	250	38043.080.001	M18	100	38043.180.001	M30	100	38043.300.001

38045 Plain washer type Z

L07G



Material Steel
Surface treatment Zinc plated





For nom. size	☒	Art.number	For nom. size	☒	Art.number	For nom. size	☒	Art.number
M3	500	38045.030.001	M10	200	38045.100.001	M20	100	38045.200.001
M4	500	38045.040.001	M12	150	38045.120.001	M22	100	38045.220.001
M5	500	38045.050.001	M14	100	38045.140.001	M24	100	38045.240.001
M6	250	38045.060.001	M16	100	38045.160.001	M27	100	38045.270.001
M8	250	38045.080.001	M18	100	38045.180.001	M30	100	38045.300.001

38047	Plain washer type Z	L07G
Material	Steel	
Surface treatment	Zinc plated yellow passivated	

For nom. size	☒	Art.number	For nom. size	☒	Art.number	For nom. size	☒	Art.number
M3	500	38047.030.001	M10	200	38047.100.001	M22	100	38047.220.001
M4	500	38047.040.001	M12	150	38047.120.001	M24	100	38047.240.001
M5	500	38047.050.001	M14	100	38047.140.001	M27	100	38047.270.001
M6	250	38047.060.001	M16	100	38047.160.001	M30	100	38047.300.001
M7	250	38047.070.001	M18	100	38047.180.001			
M8	250	38047.080.001	M20	100	38047.200.001			

51416	Plain washer type Z	R05A
Material	Stainless steel A2	NF ≈E25-513
		
		

For nom. size	☒	Art.number	For nom. size	☒	Art.number	For nom. size	☒	Art.number
M2*	500	51416.020.001	M6	250	51416.060.001	M20	100	51416.200.001
M2,5*	500	51416.025.001	M8	250	51416.080.001	M24	50	51416.240.001
M3	250	51416.030.001	M10	200	51416.100.001	M27	25	51416.270.001
M4	250	51416.040.001	M12	200	51416.120.001	M30	25	51416.300.001
M5	250	51416.050.001	M16	100	51416.160.001			

55416	Plain washer type Z	R45A
Material	Stainless steel A4	NF ≈E25-513
		
		

For nom. size	☒	Art.number	For nom. size	☒	Art.number	For nom. size	☒	Art.number
M2*	500	55416.020.001	M6	250	55416.060.001	M16	100	55416.160.001
M2,5*	500	55416.025.001	M8	250	55416.080.001	M20	100	55416.200.001
M3	250	55416.030.001	M10	200	55416.100.001	M24	50	55416.240.001
M4	250	55416.040.001	M12	200	55416.120.001	M30	25	55416.300.001
M5	250	55416.050.001	M14*	50	55416.140.001			

Washer for steel structures

DIN 7989-1

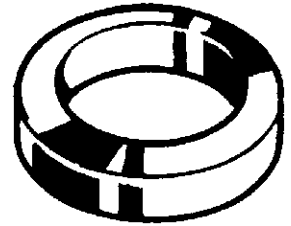
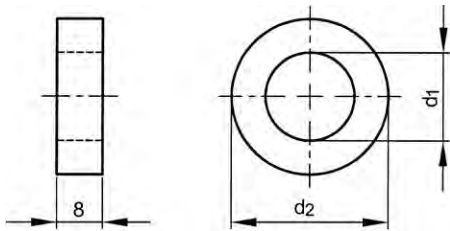

Technical Data

For nom.size	d ₁	d ₂	For nom.size	d ₁	d ₂
M10	11	20	M24	26	44
M12	13.5	24	M27	30	50
M16	17.5	30	M30	33	56
M20	22	37	M33 (#DIN)	35	60
M22 (#DIN)	24	39	M36 (#DIN)	38	66

- Thickness 8 mm, specially applicable for hexagon head bolts, for steel structures, acc. to DIN 7990.

Article groups

Material	Surface treatment	Code	Page
St	Zipl	38280	7-22
St	Hot d.g.	38270	7-22
St.St. A2		51415	7-22
St.St. A4		55415	7-23

38280 Washer for steel structures

L07G

Material Steel
Surface treatment Zinc plated



For nom. size	☒	Art.number	For nom. size	☒	Art.number	For nom. size	☒	Art.number
M10	500	38280.100.001	M20	100	38280.200.001	M30	50	38280.300.001
M12	500	38280.120.001	M24	100	38280.240.001	M33	25	38280.330.001
M16	250	38280.160.001	M27	50	38280.270.001	M36	25	38280.360.001

38270 Washer for steel structures

A08G

Material Steel
Surface treatment Hot dip galvanized



For nom. size	☒	Art.number	For nom. size	☒	Art.number	For nom. size	☒	Art.number
M10	500	38270.100.001	M20	100	38270.200.001	M30	50	38270.300.001
M12	500	38270.120.001	M24	100	38270.240.001	M36	50	38270.360.001
M16	250	38270.160.001	M27	50	38270.270.001			

51415 Washer for steel structures

R05A

Material Stainless steel A2



For nom. size	☒	Art.number	For nom. size	☒	Art.number	For nom. size	☒	Art.number
M10*	50	51415.100.001	M20*	50	51415.200.001	M27*	25	51415.270.001
M12*	50	51415.120.001	M22*	50	51415.220.001	M30*	10	51415.300.001
M16*	50	51415.160.001	M24*	25	51415.240.001	M33*	10	51415.330.001

55415	Washer for steel structures	R45A
Material	Stainless steel A4	
		

For nom. size	☒	Art.number	For nom. size	☒	Art.number	For nom. size	☒	Art.number
M10*	50	55415.100.001	M20*	50	55415.200.001	M27*	25	55415.270.001
M12*	50	55415.120.001	M22*	50	55415.220.001	M30*	10	55415.300.001
M16*	50	55415.160.001	M24*	25	55415.240.001			

Washer for bolts with heavy type spring pins

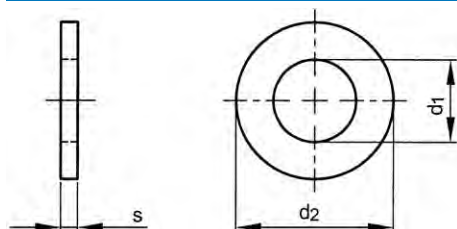

DIN 7349
NEN 2274

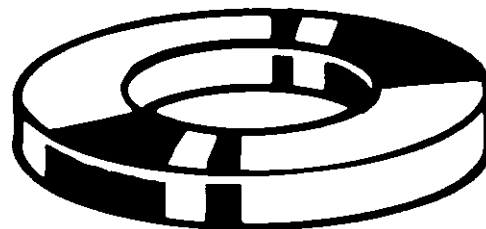

Technical Data

For nom.size	d ₁	d ₂	s	For nom.size	d ₁	d ₂	s
M3	3.2	9	1	M16	17	40	6
M4	4.3	12	1.6	M18	19	44	8
M5	5.3	15	2	M20	21	44	8
M6	6.4	17	3	M22	23	50	8
M8	8.4	21	4	M24	25	50	10
M10	10.5	25	4	M27	28	60	10
M12	13	30	6	M30	31	68	10
M14	15	36	6				

- These washers are applied in combination with spring type straight pins slotted acc. to DIN 1481 (ISO 8752).

Article groups

Material	Surface treatment	Code	Page
St		38420	7-23
St	Zipl	38430	7-24
St	Zipl yell.p.	38435	7-24
St	Hot d.g.	38438	7-24
St.St. A2		51532	7-24
St.St. A4		55532	7-24

38420	Washer for bolts with heavy type spring pins	L07G
Material	Steel	
		

For nom. size	☒	Art.number	For nom. size	☒	Art.number	For nom. size	☒	Art.number
M3	250	38420.030.001	M10	100	38420.100.001	M20	50	38420.200.001
M4	250	38420.040.001	M12	100	38420.120.001	M22	100	38420.220.001
M5	250	38420.050.001	M14	50	38420.140.001	M24	25	38420.240.001
M6	100	38420.060.001	M16	50	38420.160.001	M30	25	38420.300.001
M8	100	38420.080.001	M18	100	38420.180.001			

38430 Washer for bolts with heavy type spring pins L07G

Material Steel
Surface treatment Zinc plated



For nom. size	☒	Art.number	For nom. size	☒	Art.number	For nom. size	☒	Art.number
M3	250	38430.030.001	M10	200	38430.100.001	M20	100	38430.200.001
M4	250	38430.040.001	M12	150	38430.120.001	M22	50	38430.220.001
M5	250	38430.050.001	M14	50	38430.140.001	M24	50	38430.240.001
M6	250	38430.060.001	M16	100	38430.160.001	M27	25	38430.270.001
M8	250	38430.080.001	M18	100	38430.180.001	M30	25	38430.300.001

38435 Washer for bolts with heavy type spring pins L07G

Material Steel
Surface treatment Zinc plated yellow passivated



For nom. size	☒	Art.number	For nom. size	☒	Art.number	For nom. size	☒	Art.number
M5	250	38435.050.001	M10	200	38435.100.001	M20	100	38435.200.001
M6	250	38435.060.001	M12	150	38435.120.001	M24	50	38435.240.001
M8	250	38435.080.001	M16	100	38435.160.001			

38438 Washer for bolts with heavy type spring pins L07G



Material Steel
Surface treatment Hot dip galvanized



For nom. size	☒	Art.number	For nom. size	☒	Art.number	For nom. size	☒	Art.number
M5	250	38438.050.001	M12	150	38438.120.001	M22	50	38438.220.001
M6	250	38438.060.001	M16	100	38438.160.001	M24	50	38438.240.001
M8	250	38438.080.001	M18	100	38438.180.001	M30	50	38438.300.001
M10	200	38438.100.001	M20	100	38438.200.001			

51532 Washer for bolts with heavy type spring pins R09A

Material Stainless steel A2

For nom. size	☒	Art.number	For nom. size	☒	Art.number	For nom. size	☒	Art.number
M3	100	51532.030.001	M10	100	51532.100.001	M18*	50	51532.180.001
M4	100	51532.040.001	M12	50	51532.120.001	M20	50	51532.200.001
M5	100	51532.050.001	M14*	100	51532.140.001	M22*	50	51532.220.001
M6	100	51532.060.001	M16	50	51532.160.001	M24*	50	51532.240.001
M8	100	51532.080.001						

55532 Washer for bolts with heavy type spring pins R49A

Material Stainless steel A4





For nom. size	☒	Art.number	For nom. size	☒	Art.number	For nom. size	☒	Art.number
M3	100	55532.030.001	M8	100	55532.080.001	M16	50	55532.160.001
M4	100	55532.040.001	M10	100	55532.100.001	M20	50	55532.200.001
M5	100	55532.050.001	M12	50	55532.120.001	M22*	50	55532.220.001
M6	100	55532.060.001	M14*	100	55532.140.001	M24	50	55532.240.001

7

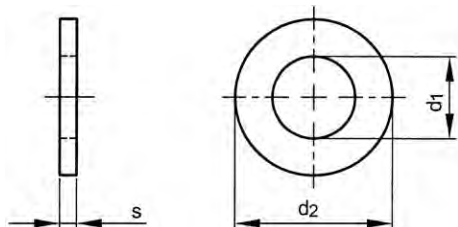
Plain washer for cheese head screws

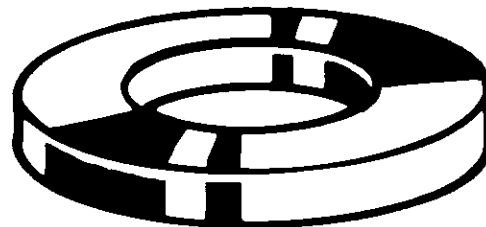

DIN 433
ISO 7092
NEN 2270



Technical Data

For nom. size	d ₁	d ₂	s	For nom. size	d ₁	d ₂	s
M1.7	1.7	3.5	0.3	M6	6.4	11	1.6
M2.2	2.2	4.5	0.3	M8	8.4	15	1.6
M2	2.2	4.5	0.3	M10	10.5	18	1.6
M2.5	2.7	5.0	0.5	M12	13	20	2
M2.6 (#DIN)	2.7	5	0.5	M14	15	24	2.5
M3	3.2	6	0.5	M16	17	28	2.5
M3.5	3.7	7	0.5	M18	19	30	2.5
M4	4.3	8	0.5	M20	21	34	3
M5	5.3	9	1				

Article groups

Material	Class	Surface treatment	Color	Code	Page
St		Zipl		38250	7-25
St.St. A2				51930	7-25
St.St. A4				55930	7-26
Br		Ni.pl.		50100	7-26
Plastic PA	PA 6.6		White	56320	7-26

38250 Plain washer for cheese head screws

L07G

Material Steel
Surface treatment Zinc plated



For nom. size	☒	Art.number	For nom. size	☒	Art.number	For nom. size	☒	Art.number
M2	500	38250.020.001	M6	250	38250.060.001	M14	100	38250.140.001
M2,6	500	38250.026.001	M8	200	38250.080.001	M16	100	38250.160.001
M3	250	38250.030.001	M10	200	38250.100.001	M18	100	38250.180.001
M4	250	38250.040.001	M12	100	38250.120.001	M20	100	38250.200.001
M5	250	38250.050.001						

51930 Plain washer for cheese head screws

R09A

Material Stainless steel A2



For nom. size	☒	Art.number	For nom. size	☒	Art.number	For nom. size	☒	Art.number
M1,7*	2000	51930.017.001	M5	500	51930.050.001	M14	100	51930.140.001
M2,5	500	51930.025.001	M6	500	51930.060.001	M16	100	51930.160.001
M3	500	51930.030.001	M8	200	51930.080.001	M18	100	51930.180.001
M3,5*	1000	51930.035.001	M10	200	51930.100.001	M20	100	51930.200.001
M4	500	51930.040.001	M12	100	51930.120.001			

55930 Plain washer for cheese head screws R49A

Material Stainless steel A4



For nom. size	☒	Art.number	For nom. size	☒	Art.number	For nom. size	☒	Art.number
M2	100	55930.020.001	M5	500	55930.050.001	M14	100	55930.140.001
M2,5	100	55930.025.001	M6	500	55930.060.001	M16	100	55930.160.001
M3	500	55930.030.001	M8	200	55930.080.001	M18	100	55930.180.001
M3,5*	1000	55930.035.001	M10	200	55930.100.001	M20	100	55930.200.001
M4	500	55930.040.001	M12	100	55930.120.001			

50100 Plain washer for cheese head screws M11F

Material Brass
Surface treatment Nickel plated





For nom. size	☒	Art.number	For nom. size	☒	Art.number	For nom. size	☒	Art.number
M2	500	50100.020.001	M5	250	50100.050.001	M12	100	50100.120.001
M2,6	500	50100.026.001	M6	250	50100.060.001	M14	100	50100.140.001
M3	250	50100.030.001	M8	200	50100.080.001	M16	100	50100.160.001
M4	250	50100.040.001	M10	200	50100.100.001			

56320 Plain washer for cheese head screws W02A

Material Plastic Polyamide (nylon)
Class PA 6.6
Color White

DIN ≈433
ISO ≈7092
NEN ≈2270



For nom. size	☒	Art.number	For nom. size	☒	Art.number	For nom. size	☒	Art.number
M3	200	56320.030.001	M5	200	56320.050.001	M8	200	56320.080.001
M4	200	56320.040.001	M6	200	56320.060.001	M10	100	56320.100.001

Plain washer for clevis pins

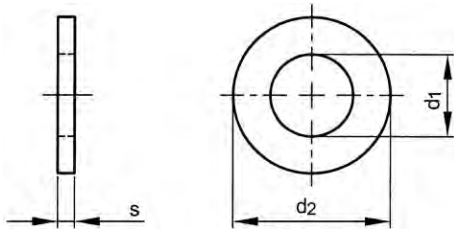

DIN 1440
ISO (8738)

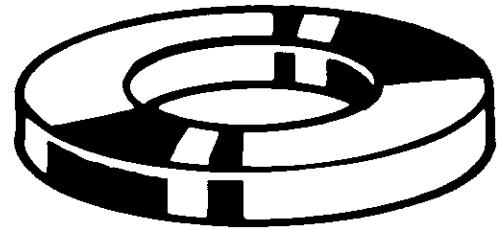

Technical Data

For pin ø	d ₁ (H11)	d ₂	s	For pin ø	d ₁ (H11)	d ₂	s
3	3	6	0.8	20	20	32	4
4	4	8	0.8	22	22	34	4
5	5	10	0.8 (1)	23	23	36	4
6	6	12	1.6	24	24	38	4
7	7	14	1.6	25	25	40	4
8	8	16 (15)	2	26	26	40	5
10	10	20 (18)	2.5	27	27	40	5
12	12	25 (20)	3	28	28	42	5
13	13	25	3	30	30	45	5
14	14	28 (22)	3	32	32	50	5
16	16	28 (24)	3	35	35	52	6
18	18	30	4	40	40	58	6

- Depending on availability can be supplied acc. to ISO 8738 with the appropriate values stated between brackets.

Article groups

Material	Surface treatment	Code	Page
St	Zipl	38760	7-27
St.St. A2		51534	7-27
St.St. A4		55534	7-28

38760 Plain washer for clevis pins

L07G

Material Steel
Surface treatment Zinc plated



For pin ø	Art.number	For pin ø	Art.number	For pin ø	Art.number
4MM	250 38760.040.001	14MM	150 38760.140.001	25MM	25 38760.250.001
5MM	250 38760.050.001	16MM	100 38760.160.001	26MM	25 38760.260.001
6MM	250 38760.060.001	18MM	100 38760.180.001	28MM	25 38760.280.001
8MM	250 38760.080.001	20MM	100 38760.200.001	30MM	25 38760.300.001
10MM	200 38760.100.001	22MM	50 38760.220.001		
12MM	150 38760.120.001	23MM	25 38760.230.001		

51534 Plain washer for clevis pins

R09A



Material Stainless steel A2



For pin ø	Art.number	For pin ø	Art.number	For pin ø	Art.number
3MM*	500 51534.030.001	13MM*	100 51534.130.001	25MM*	50 51534.250.001
4MM	100 51534.040.001	14MM	50 51534.140.001	26MM*	50 51534.260.001
5MM	100 51534.050.001	16MM	50 51534.160.001	27MM*	50 51534.270.001
6MM	100 51534.060.001	18MM*	100 51534.180.001	28MM*	50 51534.280.001
7MM*	500 51534.070.001	20MM*	100 51534.200.001	30MM*	50 51534.300.001
8MM	100 51534.080.001	22MM*	100 51534.220.001	32MM*	50 51534.320.001
10MM	100 51534.100.001	23MM*	50 51534.230.001	35MM*	25 51534.350.001
12MM	100 51534.120.001	24MM*	50 51534.240.001	40MM*	25 51534.400.001

55534 Plain washer for clevis pins R45A

Material: Stainless steel A4

For pin ø	☒	Art.number	For pin ø	☒	Art.number	For pin ø	☒	Art.number
M3*	500	55534.030.001	M12*	200	55534.120.001	M24*	50	55534.240.001
M4*	500	55534.040.001	M13*	100	55534.130.001	M25*	50	55534.250.001
M5*	500	55534.050.001	M14*	100	55534.140.001	M26*	50	55534.260.001
M6*	500	55534.060.001	M16*	100	55534.160.001	M28*	50	55534.280.001
M7*	500	55534.070.001	M18*	100	55534.180.001	M30*	50	55534.300.001
M8*	200	55534.080.001	M20*	100	55534.200.001	M32*	50	55534.320.001
M10*	200	55534.100.001	M22*	100	55534.220.001			

Plain washer for clevis pins

DIN 1441

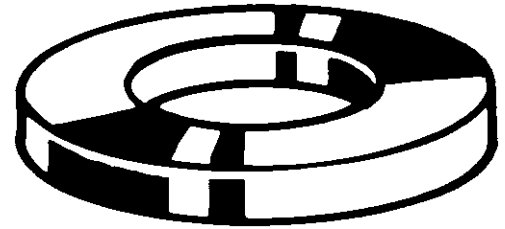
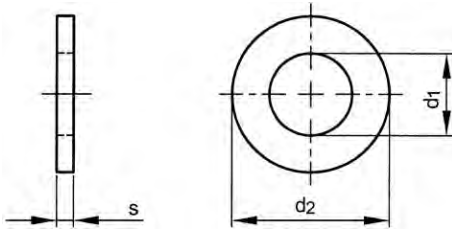

Technical Data



For pin ø	d ₁	d ₂	s	For pin ø	d ₁	d ₂	s
5	5.5	10	0.8	24	25	38	4
6	7	12	1.6	25	26	40	4
7	8	14	1.6	26	27	40	5
8	9	16	2	28	29	42	5
10	11	20	2.5	30	31	45	5
12	13	25	3	33	34	50	5
13	13	25	3	36	37	52	6
14	15	28	3	40	41	58	6
16	17	28	3	50	51	68	8
18	19	30	4	60	62	80	9
20	21	32	4	70	72	95	10
22	23	34	4	75	78	100	10
23	24	36	4	80	82	110	12

Article groups

Material	Code	Page
St	38958	7-28
St.St. A1	51535	7-29

38958 Plain washer for clevis pins L07G

Material: Steel

For pin ø	☒	Art.number	For pin ø	☒	Art.number	For pin ø	☒	Art.number
12MM	500	38958.120.001	23MM	100	38958.230.001	40MM	100	38958.400.001
14MM	500	38958.140.001	25MM	100	38958.250.001	50MM	100	38958.500.001
16MM	500	38958.160.001	28MM	100	38958.280.001	60MM	25	38958.600.001
18MM	100	38958.180.001	30MM	100	38958.300.001	70MM	25	38958.700.001
20MM	100	38958.200.001	33MM	100	38958.330.001	75MM	25	38958.750.001
22MM	100	38958.220.001	36MM	100	38958.360.001	80MM	25	38958.800.001

51535 Plain washer for clevis pins R05A

Material Stainless steel A1



For pin ø	☒	Art.number	For pin ø	☒	Art.number	For pin ø	☒	Art.number
5MM*	200	51535.050.001	13MM*	100	51535.130.001	24MM*	50	51535.240.001
6MM*	100	51535.060.001	14MM*	100	51535.140.001	26MM*	25	51535.260.001
7MM*	100	51535.070.001	16MM*	100	51535.160.001	28MM*	25	51535.280.001
8MM*	100	51535.080.001	18MM*	50	51535.180.001	30MM*	25	51535.300.001
10MM*	100	51535.100.001	20MM*	50	51535.200.001			
12MM*	100	51535.120.001	22MM*	50	51535.220.001			

Plain washer

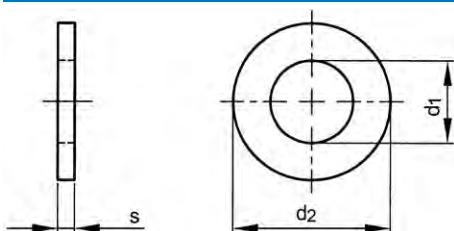

Technical Data

For nom.size	d ₁	d ₂	s	For nom.size	d ₁	d ₂	s
M2	2.2	5.5	0.3	M10	10.3	22	1.5
M2.6	2.8	7	0.5	M12	13.2	28	2
M3	3.5	8	0.5	M14	14.8	31	2
M3.5	3.7	8	0.5	M16	16.5	34	2
M4	4.2	9	0.6	M20	21	40	2.5
M5	5.2	12	0.7	M22	22.8	46	2.5
M6	6.5	14	0.8	M24	26.5	52	3
M8	8.5	18	1.5				

Article groups

Material	Surface treatment	Code	Page
Al		45180	7-29
Br	Ni.pl.	50020	7-29
Br	Ni.pl.	large pack 50030	7-30

45180 Plain washer W01A

Material Aluminium





For nom. size	☒	Art.number	For nom. size	☒	Art.number	For nom. size	☒	Art.number
M4	1000	45180.040.001	M8	250	45180.080.001	M16	100	45180.160.001
M5	1000	45180.050.001	M10	250	45180.100.001	M20	50	45180.200.001
M6	1000	45180.060.001	M12	100	45180.120.001			

50020 Plain washer M11F

Material Brass
Surface treatment Nickel plated





For nom. size	☒	Art.number	For nom. size	☒	Art.number	For nom. size	☒	Art.number
M2	500	50020.020.001	M3,5	250	50020.035.001	M5	250	50020.050.001
M2,6	500	50020.026.001	M4	250	50020.040.001	M6	250	50020.060.001
M3	250	50020.030.001						

50030	Plain washer	M11F
Material	Brass	
Surface treatment	Nickel plated	
		

For nom. size	☒	Art.number	For nom. size	☒	Art.number	For nom. size	☒	Art.number
M8	250	50030.080.001	M14	100	50030.140.001	M22	50	50030.220.001
M10	250	50030.100.001	M16	100	50030.160.001	M24	50	50030.240.001
M12	100	50030.120.001	M20	50	50030.200.001			

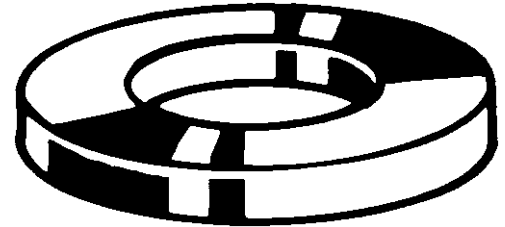
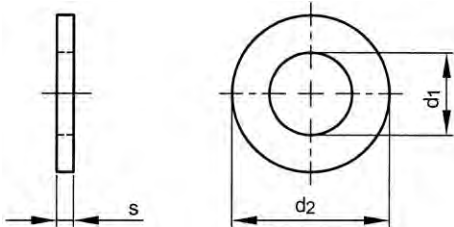
Plain washer Aluminium



Technical Data

For nom.size	d ₁	d ₂	s
M3	3.5	8	0.8
M4	4.5	10	0.8
M5	5.5	12	1
M6	6.25	14	1.2
M8	8.25	18	1.5
M10	10.25	22	2

45150	Plain washer Aluminium	W01A
Material	Aluminium Sopral A-G3	
Surface treatment	Anodized	

For nom. size	☒	Art.number	For nom. size	☒	Art.number	For nom. size	☒	Art.number
M3	500	45150.030.001	M5	500	45150.050.001	M8	250	45150.080.001
M4	500	45150.040.001	M6	500	45150.060.001	M10	200	45150.100.001

7

Plain washer

ISO 7089

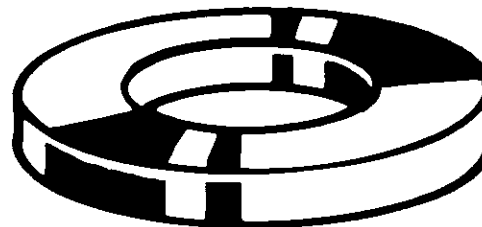
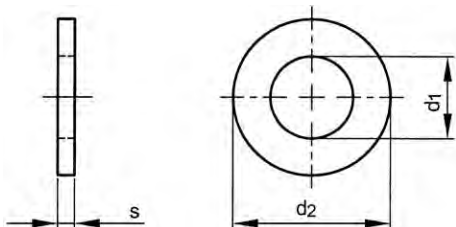

Technical Data

For nom.size	d ₁	d ₂	s
M3	3.2	7	0.5
M4	4.3	9	0.8
M5	5.3	10	1
M6	6.4	12	1.6
M8	8.4	16	1.6
M10	10.5	20	2
M12	13	24	2.5
M14	15	28	2.5
M16	17	30	3
M18	19	34	3
M20	21	37	3
M22	23	39	3
M24	25	44	4
M27	28	50	4
M30	31	56	4
M33	34	60	5
M36	37	66	5
M39	42	72	6
M42	45	78	8
M45	48	85	8

Article groups

Material	Surface treatment	Code	Page
St 200HV	Zipl	38131	7-31
St 200HV	Hot d.g.	38133	7-31
St.St. A4		55425	7-32

7

38131 Plain washer L01A

Material: Steel 200HV
Surface treatment: Zinc plated

For nom. size	☒	Art.number	For nom. size	☒	Art.number	For nom. size	☒	Art.number
M10	500	38131.100.001	M20	100	38131.200.001	M30	50	38131.300.001
M12	500	38131.120.001	M24	50	38131.240.001	M36	50	38131.360.001
M16	250	38131.160.001	M27	50	38131.270.001			

38133 Plain washer L01A



Material: Steel 200HV
Surface treatment: Hot dip galvanized

For nom. size	☒	Art.number	For nom. size	☒	Art.number	For nom. size	☒	Art.number
M10	500	38133.100.001	M20	100	38133.200.001	M30	50	38133.300.001
M12	500	38133.120.001	M24	50	38133.240.001	M36	50	38133.360.001
M16	250	38133.160.001	M27	50	38133.270.001			

55425 Plain washer R45A

Material Stainless steel A4



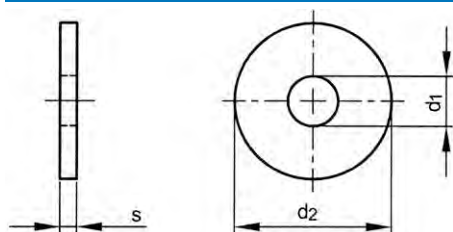

For nom. size	☒	Art.number	For nom. size	☒	Art.number	For nom. size	☒	Art.number
M3*	1000	55425.030.001	M14*	200	55425.140.001	M30*	50	55425.300.001
M4*	1000	55425.040.001	M16*	200	55425.160.001	M33*	25	55425.330.001
M5*	1000	55425.050.001	M18*	200	55425.180.001	M36*	25	55425.360.001
M6*	500	55425.060.001	M20*	200	55425.200.001	M39*	25	55425.390.001
M8*	500	55425.080.001	M22*	100	55425.220.001	M42*	25	55425.420.001
M10*	200	55425.100.001	M24*	100	55425.240.001	M45*	10	55425.450.001
M12*	200	55425.120.001	M27*	50	55425.270.001			

Plain washer

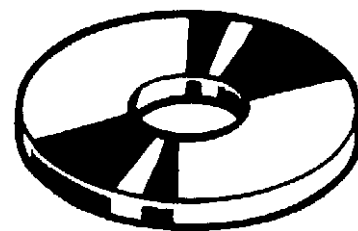

ISO 7093



Technical Data



For nom.size	d ₁	d ₂	s
M3	3.2	9	0.8
M3.5	3.7	11	0.8
M4	4.3	12	1
M5	5.3	15	1
M6	6.4	18	1.6
M8	8.4	24	2
M10	10.5	30	2.5
M12	13	37	3
M14	15	44	3
M16	17	50	3
M18	19	56	4
M20	21	60	4
M22	23	66	5
M24	25	72	5
M30	33	92	6

Article groups

Material	Code	Page
St.St. A2	51531	7-32
St.St. A4	55531	7-33

51531 Plain washer R05A

Material Stainless steel A2





For nom. size	☒	Art.number	For nom. size	☒	Art.number	For nom. size	☒	Art.number
M3*	1000	51531.030.001	M8*	500	51531.080.001	M18*	50	51531.180.001
M3,5*	1000	51531.035.001	M10*	200	51531.100.001	M20*	50	51531.200.001
M4*	1000	51531.040.001	M12*	200	51531.120.001	M22*	50	51531.220.001
M5*	1000	51531.050.001	M14*	100	51531.140.001	M24*	25	51531.240.001
M6*	500	51531.060.001	M16*	100	51531.160.001	M30*	25	51531.300.001

55531	Plain washer	R45A
Material	Stainless steel A4	
		 

For nom. size	☒	Art.number	For nom. size	☒	Art.number	For nom. size	☒	Art.number
M3*		1000 55531.030.001	M10*		200 55531.100.001	M20*		50 55531.200.001
M4*		1000 55531.040.001	M12*		200 55531.120.001	M22*		50 55531.220.001
M5*		1000 55531.050.001	M14*		100 55531.140.001	M24*		25 55531.240.001
M6*		500 55531.060.001	M16*		100 55531.160.001	M30*		25 55531.300.001
M8*		500 55531.080.001	M18*		50 55531.180.001			

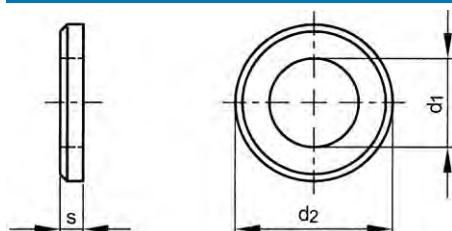
Single chamfer plain washer



DIN 125-1B
ISO 7090
NEN 2269 B

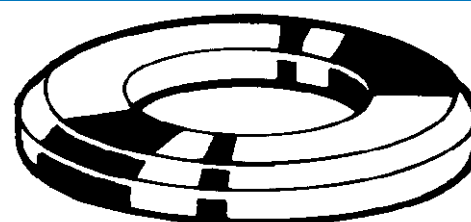

Technical Data

For nom.size	d ₁	d ₂	s	For nom.size	d ₁	d ₂	s
M2.5	2.7	6	0.5	M24	25	44	4
M3	3.2	7	0.5	M27	28	50	4
M4	4.3	9	0.8	M30	31	56	4
M5	5.3	10	1	M33	34	60	5
M6	6.4	12	1.6	M36	37	66	5
M7	7.4	14	1.6	M39	40	72	6
M8	8.4	16	1.6	M42	43	78	7
M10	10.5	20	2	M45	46	85	7
M12	13	24	2.5	M48	50	92	8
M14	15	28	2.5	M52	54	98	8
M16	17	30	3	M56	58	105	9
M18	19	34	3	M60	62	110	9
M20	21	37	3	M64	66	115	9
M22	23	39	3				

Article groups

Material	Surface treatment	Code	Page
St 140HV		38160	7-33
St 140HV	Zipl	38180	7-34
St 140HV	Zipl	38190	7-34
St.St. A4		55426	7-34
Br		50040	7-34
Br	Ni.pl.	50150	7-34

38160	Single chamfer plain washer	L07G
Material	Steel 140HV	
		 

For nom. size	☒	Art.number	For nom. size	☒	Art.number	For nom. size	☒	Art.number
M4		250 38160.040.001	M18		100 38160.180.001	M39		10 38160.390.001
M5		250 38160.050.001	M20		100 38160.200.001	M42		10 38160.420.001
M6		250 38160.060.001	M22		50 38160.220.001	M45		10 38160.450.001
M7		250 38160.070.001	M24		50 38160.240.001	M48		10 38160.480.001
M8		250 38160.080.001	M27		25 38160.270.001	M52		5 38160.520.001
M10		200 38160.100.001	M30		25 38160.300.001	M56		5 38160.560.001
M12		150 38160.120.001	M33		25 38160.330.001	M60		5 38160.600.001
M14		100 38160.140.001	M36		25 38160.360.001	M64		5 38160.640.001
M16		100 38160.160.001						

38180 Single chamfer plain washer L07G

Material Steel 140HV
Surface treatment Zinc plated



For nom. size	☒	Art.number	For nom. size	☒	Art.number	For nom. size	☒	Art.number
M4	250	38180.040.001	M18	100	38180.180.001	M42	10	38180.420.001
M5	250	38180.050.001	M20	100	38180.200.001	M45	10	38180.450.001
M6	250	38180.060.001	M22	50	38180.220.001	M48	10	38180.480.001
M7	250	38180.070.001	M24	50	38180.240.001	M52	5	38180.520.001
M8	250	38180.080.001	M27	25	38180.270.001	M56	5	38180.560.001
M10	200	38180.100.001	M30	25	38180.300.001	M60	5	38180.600.001
M12	150	38180.120.001	M33	25	38180.330.001	M64	5	38180.640.001
M14	100	38180.140.001	M36	25	38180.360.001			
M16	100	38180.160.001	M39	10	38180.390.001			

38190 Single chamfer plain washer L07G



Material Steel 140HV
Surface treatment Zinc plated

For nom. size	☒	Art.number	For nom. size	☒	Art.number	For nom. size	☒	Art.number
M5	2500	38190.050.001	M8	2000	38190.080.001	M12	500	38190.120.001
M6	2000	38190.060.001	M10	1000	38190.100.001	M16	400	38190.160.001

55426 Single chamfer plain washer R45A



Material Stainless steel A4

For nom. size	☒	Art.number	For nom. size	☒	Art.number	For nom. size	☒	Art.number
M5	250	55426.050.001	M12	200	55426.120.001	M24	50	55426.240.001
M6	250	55426.060.001	M16	100	55426.160.001	M27	25	55426.270.001
M8	250	55426.080.001	M20	100	55426.200.001	M30	25	55426.300.001
M10	200	55426.100.001						

50040 Single chamfer plain washer M11F



Material Brass

For nom. size	☒	Art.number	For nom. size	☒	Art.number	For nom. size	☒	Art.number
M3	250	50040.030.001	M10	100	50040.100.001	M22	50	50040.220.001
M4	250	50040.040.001	M12	100	50040.120.001	M24	50	50040.240.001
M5	250	50040.050.001	M14	100	50040.140.001	M27	50	50040.270.001
M6	250	50040.060.001	M16	100	50040.160.001	M30	25	50040.300.001
M7	250	50040.070.001	M18	100	50040.180.001			
M8	250	50040.080.001	M20	50	50040.200.001			

50150 Single chamfer plain washer M11F

Material Brass
Surface treatment Nickel plated

For nom. size	☒	Art.number	For nom. size	☒	Art.number	For nom. size	☒	Art.number
M2,5	250	50150.025.001	M5	250	50150.050.001	M10	100	50150.100.001
M3	250	50150.030.001	M6	250	50150.060.001	M12	100	50150.120.001
M4	250	50150.040.001	M8	250	50150.080.001	M16	100	50150.160.001

7

Plain washer

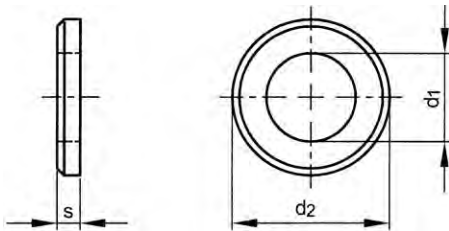

ISO 7090

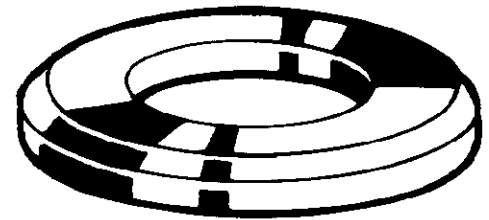

Technical Data

For nom.size	d ₁	d ₂	s
M5	5.3	10	1
M6	6.4	12	1.6
M8	8.4	16	1.6
M10	10.5	20	2
M12	13	24	2.5
M14	15	28	2.5
M16	17	30	3
M18	19	34	3
M20	21	37	3
M22	23	39	3
M24	25	44	4
M27	28	50	4
M30	31	56	4
M33	34	60	5
M36	37	66	5

Article groups

Material	Code	Page
St.St. A2	51427	7-35
St.St. A4	55427	7-35

51427 Plain washer R05A

Material: Stainless steel A2



For nom. size	☒	Art.number	For nom. size	☒	Art.number	For nom. size	☒	Art.number
M5*	200	51427.050.001	M14*	100	51427.140.001	M24*	50	51427.240.001
M6*	200	51427.060.001	M16*	100	51427.160.001	M27*	25	51427.270.001
M8*	200	51427.080.001	M18*	100	51427.180.001	M30*	25	51427.300.001
M10*	100	51427.100.001	M20*	50	51427.200.001	M33*	10	51427.330.001
M12*	100	51427.120.001	M22*	50	51427.220.001	M36*	10	51427.360.001

55427 Plain washer R45A

Material: Stainless steel A4



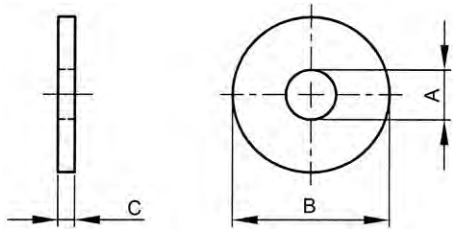

For nom. size	☒	Art.number	For nom. size	☒	Art.number	For nom. size	☒	Art.number
M5*	200	55427.050.001	M14*	100	55427.140.001	M22*	50	55427.220.001
M6*	200	55427.060.001	M16*	100	55427.160.001	M24*	50	55427.240.001
M8*	200	55427.080.001	M18*	100	55427.180.001	M27*	25	55427.270.001
M10*	100	55427.100.001	M20*	50	55427.200.001	M30*	25	55427.300.001
M12*	100	55427.120.001						

Plain fender washer Stainless Steel

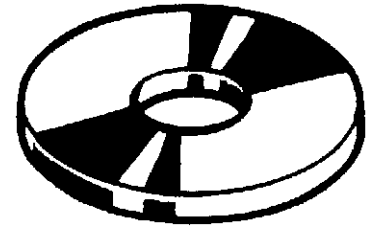

ASME ≈B18.21.1





Technical Data

For nom.size	A	B	C
U51530.013.0001 NO.6	0.1560	0.6250	0.0310
U51530.013.0002 NO.6	0.1560	0.5630	0.0470
U51530.019.0001 NO.10	0.2190	0.5000	0.0470
U51530.019.0002 NO.10	0.2190	0.6880	0.0470
U51530.025.0001 1/4	0.2810	0.5000	0.0470
U51530.025.0002 1/4	0.2810	0.5630	0.0650
U51530.025.0006 1/4	0.2850	1.2500	0.1250
U51530.031.0001 5/16	0.3480	0.6250	0.0650
U55530.013.0001 NO.6	0.1560	0.5630	0.0470
U55530.019.0002 NO.10	0.2190	0.6880	0.0470
U55530.025.0001 1/4	0.2810	0.5000	0.0470
U55530.025.0002 1/4	0.2810	0.5630	0.0650
U55530.031.0001 5/16	0.3480	0.6250	0.0650

Article groups

Material	Code	Page
St.St. A2 (AISI304/18-8)	U51530	7-36
St.St. A4 (AISI316/18-10)	U55530	7-36

U51530	Plain fender washer Stainless Steel	X15A
Material	Stainless steel A2 (AISI 304/18-8)	
		

For nom. size	☒	Art.number	For nom. size	☒	Art.number	For nom. size	☒	Art.number
NO.6*	50	U51530.013.0001	NO.10*	50	U51530.019.0002	1/4*	50	U51530.025.0006
NO.6*	50	U51530.013.0002	1/4*	50	U51530.025.0001	5/16*	50	U51530.031.0001
NO.10*	50	U51530.019.0001	1/4*	50	U51530.025.0002			

U55530	Plain fender washer Stainless Steel	X15A
Material	Stainless steel A4 (AISI 316/18-10)	
		

For nom. size	☒	Art.number	For nom. size	☒	Art.number	For nom. size	☒	Art.number
NO.6*	50	U55530.013.0001	1/4*	50	U55530.025.0001	5/16*	50	U55530.031.0001
NO.10*	50	U55530.019.0002	1/4*	50	U55530.025.0002			

7

Plain custom fender washer

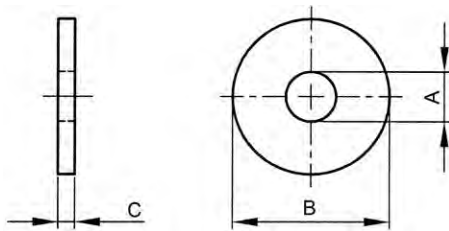

ASME ≈B18.21.1

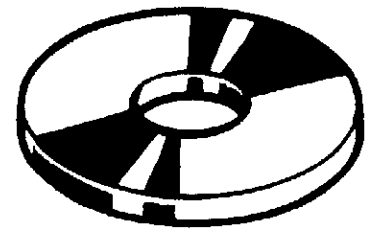

Technical Data

For nom.size	A	B	C
U38160.013.0002 NO.6	0.1560	0.5630	0.0470
U38160.016.0001 NO.8	0.1880	0.7500	0.0470
U38160.019.0002 NO.10	0.2190	0.6880	0.0470
U38160.019.0008 NO.10	0.2190	1.0000	0.1250
U38160.019.0009 NO.10	0.2190	1.0000	0.2500
U38160.025.0001 1/4	0.2850	0.5000	0.0470
U38160.025.0002 1/4	0.2850	0.5630	0.0470
U38160.025.0008 1/4	0.2850	1.5000	0.1250
U38160.025.0009 1/4	0.2850	1.5000	0.2500
U38160.031.0001 5/16	0.3480	0.6250	0.0470
U38160.031.0008 5/16	0.3480	2.0000	0.1250
U38160.031.0009 5/16	0.3480	2.0000	0.2500
U38160.037.0005 3/8	0.4100	2.0000	0.1250
U38160.037.0006 3/8	0.4100	2.0000	0.2500
U38160.050.0003 1/2	0.5350	2.0000	0.1250
U38160.050.0004 1/2	0.5350	2.0000	0.2500
U38160.050.0006 1/2	0.5350	3.0000	0.2500
U38160.062.0001 5/8	0.6880	2.5000	0.1250
U38160.062.0002 5/8	0.6880	2.5000	0.2500
U38160.062.0003 5/8	0.6880	3.0000	0.2500
U38160.075.0001 3/4	0.7810	3.0000	0.1250
U38160.075.0002 3/4	0.7810	3.0000	0.2500
U38160.075.0003 3/4	0.7810	3.0000	0.3750
U38160.087.0001 7/8	0.9380	3.0000	0.2500
U38160.087.0002 7/8	0.9380	3.2500	0.1250
U38160.087.0003 7/8	0.9380	3.2500	0.2500
U38160.087.0004 7/8	0.9380	3.2500	0.3750
U38160.100.0001 1	1.0630	3.2500	0.2500
U38160.100.0002 1	1.0630	3.5000	0.1250
U38160.100.0003 1	1.0630	3.5000	0.2500
U38160.100.0004 1	1.0630	3.5000	0.3750
U38160.125.0001 1.1/4	1.3750	4.0000	0.5000

7

U38160 Plain custom fender washer		X09A
Material	Steel	

For nom. size	☒	Art.number	For nom. size	☒	Art.number	For nom. size	☒	Art.number
NO.6*	100	U38160.013.0002	5/16*	100	U38160.031.0009	3/4*	20	U38160.075.0003
NO.8*	100	U38160.016.0001	3/8*	100	U38160.037.0005	7/8*	10	U38160.087.0001
NO.10*	100	U38160.019.0002	3/8*	100	U38160.037.0006	7/8*	10	U38160.087.0002
NO.10*	100	U38160.019.0008	1/2*	50	U38160.050.0003	7/8*	10	U38160.087.0003
NO.10*	100	U38160.019.0009	1/2*	50	U38160.050.0004	7/8*	10	U38160.087.0004
1/4*	100	U38160.025.0001	1/2*	50	U38160.050.0006	1 Inch*	5	U38160.100.0001
1/4*	100	U38160.025.0002	5/8*	25	U38160.062.0001	1 Inch*	5	U38160.100.0002
1/4*	100	U38160.025.0008	5/8*	25	U38160.062.0002	1 Inch*	5	U38160.100.0003
1/4*	100	U38160.025.0009	5/8*	25	U38160.062.0003	1 Inch*	5	U38160.100.0004
5/16*	100	U38160.031.0001	3/4*	20	U38160.075.0001	1.1/4*	5	U38160.125.0001
5/16*	100	U38160.031.0008	3/4*	20	U38160.075.0002			

Plain washer, outer diameter $\approx 3 \times d$

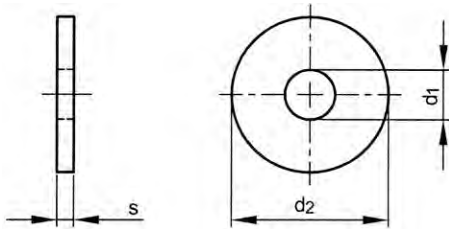

DIN 9021
ISO 7093
NEN 2276
NF E25-513

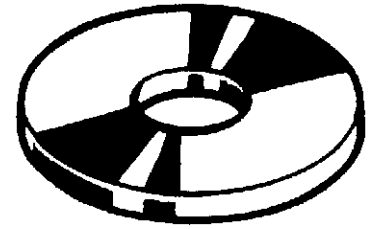

Technical Data

For nom.size	d ₁ (min.)	d ₂ (max.)	s	For nom.size	d ₁ (min.)	d ₂ (max.)	s
M2 (#DIN)	2.2	7	0.8	M10	10.5	30	2.5
M2.5	2.7	8	0.8	M12	13	37	3
M3	3.2	9	0.8	M14	15	44	3
M3.5	3.7	11	0.8	M16	17	50	3
M4	4.3	12	1	M18	20	56	4
M5	5.3	15	1.2	M20	22	60	4
M6	6.4	18	1.6	M24	26	72	5
M7	7.4	22	2	M30	33	92	6
M8	8.4	24	2	M36	39	110	8



Article groups

Material	Class	Surface treatment	Color	Code	Page
St				38209	7-38
St		Zipl		38210	7-38
St		Zipl	large pack	38220	7-39
St		Zipl yell.p.		38211	7-39
St		Hot d.g.		38212	7-39
St.St. A2				51530	7-39
St.St. A4				55530	7-39
Plastic PA	PA 6.6		Black	56332	7-40
Plastic PA	PA 6.6		White	56330	7-40

7

38209 Plain washer, outer diameter $\approx 3 \times d$		L01A	
Material	Steel		
			

For nom. size	☒	Art.number	For nom. size	☒	Art.number	For nom. size	☒	Art.number
M4	500	38209.040.001	M8	200	38209.080.001	M14	100	38209.140.001
M5	200	38209.050.001	M10	200	38209.100.001	M16	100	38209.160.001
M6	200	38209.060.001	M12	100	38209.120.001	M20	100	38209.200.001

38210 Plain washer, outer diameter $\approx 3 \times d$		L01A	
Material	Steel		
Surface treatment	Zinc plated		

For nom. size	☒	Art.number	For nom. size	☒	Art.number	For nom. size	☒	Art.number
M3	250	38210.030.001	M7	250	38210.070.001	M16	100	38210.160.001
M3,5	250	38210.035.001	M8	250	38210.080.001	M18	100	38210.180.001
M4	250	38210.040.001	M10	200	38210.100.001	M20	100	38210.200.001
M5	250	38210.050.001	M12	200	38210.120.001	M24	100	38210.240.001
M6	250	38210.060.001	M14	100	38210.140.001	M30	50	38210.300.001

38220 Plain washer, outer diameter ≈ 3 x d				L01A				
Material		Steel						
Surface treatment		Zinc plated						
For nom. size	☒	Art.number	For nom. size	☒	Art.number	For nom. size	☒	Art.number
M4		2500 38220.040.001	M7		2000 38220.070.001	M10		750 38220.100.001
M5		2500 38220.050.001	M8		1000 38220.080.001	M12		500 38220.120.001
M6		2000 38220.060.001						

38211 Plain washer, outer diameter ≈ 3 x d				L01A				
Material		Steel						
Surface treatment		Zinc plated yellow passivated						
For nom. size	☒	Art.number	For nom. size	☒	Art.number	For nom. size	☒	Art.number
M3		250 38211.030.001	M7		250 38211.070.001	M14		100 38211.140.001
M4		250 38211.040.001	M8		250 38211.080.001	M16		100 38211.160.001
M5		250 38211.050.001	M10		200 38211.100.001	M20		100 38211.200.001
M6		250 38211.060.001	M12		200 38211.120.001	M24		100 38211.240.001

38212 Plain washer, outer diameter ≈ 3 x d				L01A				
Material		Steel						
Surface treatment		Hot dip galvanized						
For nom. size	☒	Art.number	For nom. size	☒	Art.number	For nom. size	☒	Art.number
M8		200 38212.080.001	M16		100 38212.160.001	M24		50 38212.240.001
M10		200 38212.100.001	M20		100 38212.200.001	M30		25 38212.300.001
M12		100 38212.120.001						

51530 Plain washer, outer diameter ≈ 3 x d				R05A				
Material		Stainless steel A2						
For nom. size	☒	Art.number	For nom. size	☒	Art.number	For nom. size	☒	Art.number
M2*		1000 51530.020.001	M6		200 51530.060.001	M16		200 51530.160.001
M2,5*		1000 51530.025.001	M7*		500 51530.070.001	M18		200 51530.180.001
M3		200 51530.030.001	M8		200 51530.080.001	M20		200 51530.200.001
M3,5*		1000 51530.035.001	M10		200 51530.100.001	M24		25 51530.240.001
M4		200 51530.040.001	M12		200 51530.120.001	M30*		25 51530.300.001
M5		200 51530.050.001	M14		200 51530.140.001	M36*		10 51530.360.001

55530 Plain washer, outer diameter ≈ 3 x d				R45A				
Material		Stainless steel A4						
For nom. size	☒	Art.number	For nom. size	☒	Art.number	For nom. size	☒	Art.number
M2*		1000 55530.020.001	M6		200 55530.060.001	M16		200 55530.160.001
M2,5*		1000 55530.025.001	M7*		500 55530.070.001	M18		50 55530.180.001
M3		200 55530.030.001	M8		200 55530.080.001	M20		200 55530.200.001
M3,5*		1000 55530.035.001	M10		200 55530.100.001	M24		25 55530.240.001
M4		200 55530.040.001	M12		200 55530.120.001	M30		25 55530.300.001
M5		200 55530.050.001	M14		200 55530.140.001			

56332 Plain washer, outer diameter $\approx 3 \times d$		W02A	
Material	Plastic Polyamide (nylon)		
Class	PA 6.6		
Color	Black		
			
For nom. size	<input type="checkbox"/>	Art.number	For nom. size
M3	200	56332.030.001	M6
M4	200	56332.040.001	M8
M5	200	56332.050.001	
			M10
			M12
			100
			100
			56332.100.001
			56332.120.001

56330 Plain washer, outer diameter $\approx 3 \times d$		W02A	
Material	Plastic Polyamide (nylon)		
Class	PA 6.6		
Color	White		
			
For nom. size	<input type="checkbox"/>	Art.number	For nom. size
M3	200	56330.030.009	M6
M4	200	56330.040.012	M6 (s=2)
M5	200	56330.050.015	M8
			M10
			M12 (d2=40)
			M16
			100
			100
			100
			56330.100.030
			56330.120.040
			56330.160.050

Washer for wood construction

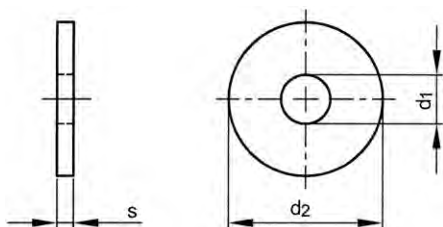

DIN 440 R
ISO 7094
NEN 2275
NF E25-513

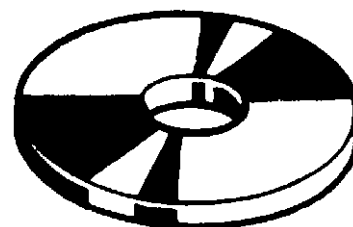



7

Technical Data

For nom.size	d ₁	d ₂	s	For nom.size	d ₁	d ₂	s
M5	5.5	18	2	M16	17.5	56	5
M6	6.6	22	2	M20	22	72	6
M8	9	28	3	M22	24	80	6
M10	11	34	3	M24	26	85	6
M12	13.5	44	4	M27	30	98	6
M14	15.5	50	4	M30	33	105	6



Article groups

Material	Surface treatment	Code	Page
St	Zipl	38240	7-40
St	Hot d.g.	38230	7-41
St.St. A2		51590	7-41
St.St. A4		55590	7-41



38240 Washer for wood construction		L07G	
Material	Steel		
Surface treatment	Zinc plated		
			
			
For nom. size	<input type="checkbox"/>	Art.number	For nom. size
M5	100	38240.050.001	M12
M6	100	38240.060.001	M16
M8	100	38240.080.001	M20
M10	100	38240.100.001	
			M24
			M27
			M30
			25
			25
			25
			38240.240.001
			38240.270.001
			38240.300.001

38230	Washer for wood construction				A08G
Material	Steel				
Surface treatment	Hot dip galvanized				
					

For nom. size	☒	Art.number	For nom. size	☒	Art.number	For nom. size	☒	Art.number
M5	100	38230.050.001	M12	100	38230.120.001	M24	25	38230.240.001
M6	100	38230.060.001	M16	100	38230.160.001	M27	25	38230.270.001
M8	100	38230.080.001	M20	50	38230.200.001	M30	25	38230.300.001
M10	100	38230.100.001						

51590	Washer for wood construction				R09A
Material	Stainless steel A2		DIN	≈440R	
			ISO	≈7094	
			NEN	≈2275	
			NF	≈E25-513	

For nom. size	☒	Art.number	For nom. size	☒	Art.number	For nom. size	☒	Art.number
M5	50	51590.050.001	M12	50	51590.120.001	M20	25	51590.200.001
M6	50	51590.060.001	M14*	50	51590.140.001	M22*	25	51590.220.001
M8	50	51590.080.001	M16	50	51590.160.001	M24	10	51590.240.001
M10	50	51590.100.001						

55590	Washer for wood construction				R49A
Material	Stainless steel A4		DIN	≈440R	
			ISO	≈7094	
			NEN	≈2275	
			NF	≈E25-513	

For nom. size	☒	Art.number	For nom. size	☒	Art.number	For nom. size	☒	Art.number
M5	50	55590.050.001	M10	50	55590.100.001	M20	25	55590.200.001
M6	50	55590.060.001	M12	50	55590.120.001	M22*	25	55590.220.001
M8	50	55590.080.001	M16	50	55590.160.001	M24	10	55590.240.001

Washer for wood constructions

DIN 440V

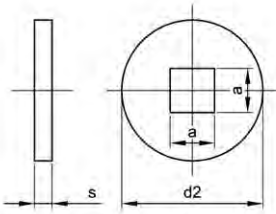

Technical Data

For nom.size	a	d ₂	s
M5	5.5	18	2
M6	6.6	22	2
M8	9	28	3
M10	11	34	3
M12	14	44	4
M16	18	56	5
M20	22	72	6

Article groups

Material	Code	Page
St.St. A2	51577	7-42
St.St. A4	55577	7-42

51577 Washer for wood constructions R09A



Material: Stainless steel A2



For nom. size	☒	Art.number	For nom. size	☒	Art.number	For nom. size	☒	Art.number
M5*	100	51577.050.001	M10*	50	51577.100.001	M16*	50	51577.160.001
M6*	100	51577.060.001	M12*	50	51577.120.001	M20*	25	51577.200.001
M8*	100	51577.080.001						

55577 Washer for wood constructions R49A

Material: Stainless steel A4

For nom. size	☒	Art.number	For nom. size	☒	Art.number	For nom. size	☒	Art.number
M8*	100	55577.080.001	M10*	50	55577.100.001	M12*	50	55577.120.001

7

Washer for wood constructions

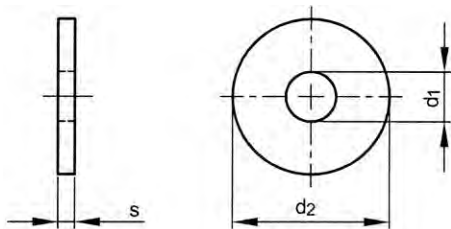

DIN 1052

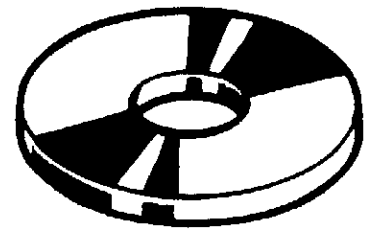

Technical Data



d	d ₁	d ₂	s
M12	14	58	6
M16	18	68	6
M20	23	80	8
M22	25	92	8
M24	27	105	8

Article groups

Material	Code	Page
St.St. A2	51533	7-43
St.St. A4	55533	7-43

51533 Washer for wood constructions		R05A
Material	Stainless steel A2	
		

d	☒	Art.number	d	☒	Art.number	d	☒	Art.number
M12*	50	51533.120.001	M20*	25	51533.200.001	M24*	25	51533.240.001
M16*	50	51533.160.001	M22*	25	51533.220.001			

55533 Washer for wood constructions		R45A
Material	Stainless steel A4	
		

d	☒	Art.number	d	☒	Art.number	d	☒	Art.number
M12*	50	55533.120.001	M20*	25	55533.200.001	M24*	25	55533.240.001
M16*	50	55533.160.001	M22*	25	55533.220.001			

Mudwing repair washer

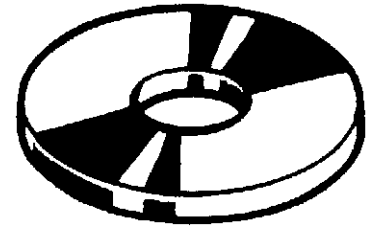
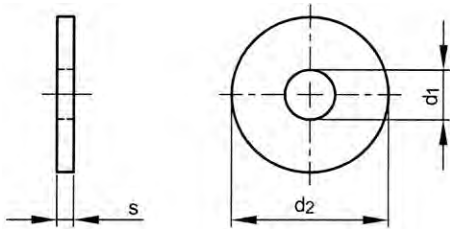

Technical Data

For nom.size	d ₁	s	For nom.size	d ₁	s
M3	3.3	0.8	M14	14.5	2
M4	4.2	1.2	M16	16.5	2.5
M5	5.2	1.3	M17	17.2	2.5
M6	6.5	1.5	M20	20.2	2.5
M7	7.4	1.5	M22	24	4
M8	8.4	1.5	M24	25	4
M10	10.5	1.5	M27	28	4
M11	11.5	1.5	M30	32	4
M12	12.5	2			

Article groups

Material	Surface treatment	Code	Page
St	Zipl	38400	7-44
St	Zipl	large pack	7-44
St	Zipl yell.p.	38401	7-45
St.St. A2		51410	7-45
St.St. A4		55410	7-45

38400 Mudwing repair washer

L01A

Material Steel
Surface treatment Zinc plated



For nom. size x d ₂	☒	Art.number	For nom. size x d ₂	☒	Art.number	For nom. size x d ₂	☒	Art.number
M3X10	100	38400.030.010	M8X25	100	38400.080.025	M12X60	100	38400.120.060
M4X20	100	38400.040.020	M8X30	100	38400.080.030	M14X36	100	38400.140.036
M4X30	250	38400.040.030	M8X35	100	38400.080.035	M14X40	100	38400.140.040
M5X20	100	38400.050.020	M8X38	100	38400.080.038	M14X45	100	38400.140.045
M5X25	100	38400.050.025	M8X40	100	38400.080.040	M16X40	100	38400.160.040
M5X30	100	38400.050.030	M8X45	100	38400.080.045	M16X45	100	38400.160.045
M6X14	100	38400.060.014	M8X50	100	38400.080.050	M16X50	100	38400.160.050
M6X20	100	38400.060.020	M10X30	100	38400.100.030	M17X40	100	38400.170.040
M6X25	100	38400.060.025	M10X35	100	38400.100.035	M17X45	100	38400.170.045
M6X27	100	38400.060.027	M10X38	100	38400.100.038	M20X50	100	38400.200.050
M6X30	100	38400.060.030	M10X40	100	38400.100.040	M20X55	100	38400.200.055
M6X35	100	38400.060.035	M10X50	100	38400.100.050	M22X75	50	38400.220.075
M6X38	100	38400.060.038	M10X50(s=3)	100	38400.100.051	M24X80	50	38400.240.080
M6X40	100	38400.060.040	M10X60	100	38400.100.060	M24X85	50	38400.240.085
M7X20	100	38400.070.020	M11X35	100	38400.110.035	M27X85	25	38400.270.085
M7X25	100	38400.070.025	M12X30	100	38400.120.030	M30X95	25	38400.300.095
M7X30	100	38400.070.030	M12X36	100	38400.120.036			
M8X20	250	38400.080.020	M12X40	100	38400.120.040			

38410 Mudwing repair washer

L01A

Material Steel
Surface treatment Zinc plated



For nom. size x d ₂	☒	Art.number	For nom. size x d ₂	☒	Art.number	For nom. size x d ₂	☒	Art.number
M4X20	2000	38410.040.020	M6X25	700	38410.060.025	M8X30	700	38410.080.030
M5X20	1000	38410.050.020	M6X30	700	38410.060.030	M10X30	700	38410.100.030
M5X30	1000	38410.050.030	M8X25	700	38410.080.025			

38401	Mudwing repair washer	L01A
Material	Steel	
Surface treatment	Zinc plated yellow passivated	

For nom. size x d ₂	☒	Art.number	For nom. size x d ₂	☒	Art.number	For nom. size x d ₂	☒	Art.number
M3X10	100	38401.030.010	M6X30	100	38401.060.030	M10X30	100	38401.100.030
M4X20	100	38401.040.020	M6X40	100	38401.060.040	M12X36	100	38401.120.036
M5X20	100	38401.050.020	M7X25	100	38401.070.025	M14X36	100	38401.140.036
M5X25	100	38401.050.025	M8X25	100	38401.080.025	M16X50	100	38401.160.050
M5X30	100	38401.050.030	M8X30	100	38401.080.030	M20X55	100	38401.200.055
M6X25	100	38401.060.025	M8X40	100	38401.080.040	M24X85	50	38401.240.085

51410	Mudwing repair washer	R05A
Material	Stainless steel A2	



For nom. size x d ₂	☒	Art.number	For nom. size x d ₂	☒	Art.number	For nom. size x d ₂	☒	Art.number
M4X12*	500	51410.040.012	M6X40	200	51410.060.040	M10X30	200	51410.100.030
M4X15*	500	51410.040.015	M6X45*	200	51410.060.045	M10X35	200	51410.100.035
M4X20	200	51410.040.020	M6X50*	200	51410.060.050	M10X40	100	51410.100.040
M4X25*	200	51410.040.025	M6X55*	200	51410.060.055	M10X45*	200	51410.100.045
M5X15*	500	51410.050.015	M8X20	200	51410.080.020	M10X50*	200	51410.100.050
M5X20	200	51410.050.020	M8X25	200	51410.080.025	M12X30	200	51410.120.030
M5X25	200	51410.050.025	M8X30	200	51410.080.030	M12X35*	200	51410.120.035
M5X30*	200	51410.050.030	M8X35*	200	51410.080.035	M12X36	200	51410.120.036
M6X18	200	51410.060.018	M8X40	200	51410.080.040	M12X40*	200	51410.120.040
M6X20	200	51410.060.020	M8X45*	200	51410.080.045	M12X45*	200	51410.120.045
M6X25	200	51410.060.025	M8X50*	200	51410.080.050	M12X50*	200	51410.120.050
M6X30	200	51410.060.030	M8X55*	200	51410.080.055	M16X40	200	51410.160.040
M6X35*	200	51410.060.035	M10X25	200	51410.100.025	M16X50	200	51410.160.050

55410	Mudwing repair washer	R45A
Material	Stainless steel A4	



For nom. size x d ₂	☒	Art.number	For nom. size x d ₂	☒	Art.number	For nom. size x d ₂	☒	Art.number
M4X12*	500	55410.040.012	M6X25	200	55410.060.025	M10X25*	200	55410.100.025
M4X15*	500	55410.040.015	M6X30	200	55410.060.030	M10X30X1,5	200	55410.100.030
M4X20	200	55410.040.020	M6X35*	200	55410.060.035	M10X35*	200	55410.100.035
M4X25*	200	55410.040.025	M6X40*	200	55410.060.040	M10X40*	200	55410.100.040
M5X15*	500	55410.050.015	M8X20	200	55410.080.020	M12X30	200	55410.120.030
M5X20	200	55410.050.020	M8X25	200	55410.080.025	M12X35*	200	55410.120.035
M5X24*	200	55410.050.025	M8X30	200	55410.080.030	M12X36	200	55410.120.036
M5X30*	200	55410.050.030	M8X35*	200	55410.080.035	M12X40*	200	55410.120.040
M6X20*	500	55410.060.020	M8X40*	200	55410.080.040	M16X40	200	55410.160.040

Custom flat washer

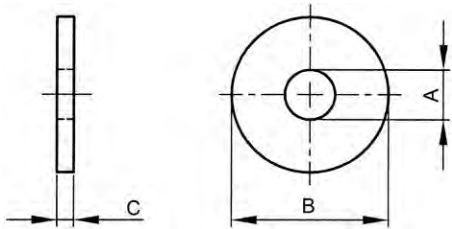

ASME ≈B18.21.1

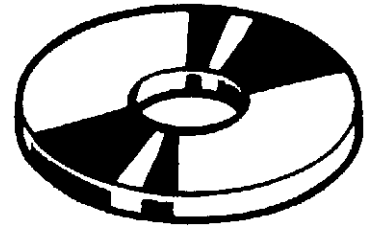

Technical Data

Nr.	A	B	C	Nr.	A	B	C
U38400.006.0001 NO.0	0.063	0.125	0.031	U38402.016.0001 NO.8	0.188	0.438	0.049
U38400.006.0002 NO.0	0.063	0.188	0.031	U38402.018.0001 1/4	0.281	0.562	0.049
U38400.006.0003 NO.0	0.063	0.250	0.031	U38402.019.0001 NO.10	0.219	0.500	0.049
U38400.007.0001 NO.2	0.094	0.156	0.031	U38402.175.0001 1.3/4	1.875	4.000	0.180
U38400.007.0002 NO.2	0.094	0.219	0.031	U38402.200.0001 2 Inch	2.125	4.500	0.180
U38400.007.0003 NO.2	0.094	0.281	0.031	U38402.225.0001 2.1/4	2.375	4.750	0.220
U38400.008.0001 NO.2	0.094	0.188	0.031	U38402.250.0001 2.1/2	2.625	5.000	0.238
U38400.008.0002 NO.2	0.094	0.250	0.031	U38402.300.0001 3 Inch	3.125	5.500	0.284
U38400.008.0003 NO.2	0.094	0.344	0.031	U38403.011.0001 NO.4	0.125	0.313	0.078
U38400.011.0001 NO.2	0.094	0.250	0.016	U38403.013.0001 NO.6	0.156	0.375	0.078
U38400.011.0002 NO.4	0.125	0.250	0.047	U38403.016.0001 NO.8	0.188	0.438	0.078
U38400.011.0003 NO.4	0.125	0.313	0.031	U38403.019.0001 NO.8	0.188	0.500	0.094
U38400.011.0004 NO.4	0.125	0.375	0.047	U38403.025.0001 1/4	0.281	0.625	0.125
U38400.011.0005 NO.4	0.125	0.438	0.047	U38403.031.0001 5/16	0.344	0.750	0.125
U38400.013.0001 NO.6	0.156	0.375	0.049	U38403.037.0001 3/8	0.406	0.875	0.125
U38400.013.0002 NO.6	0.156	0.313	0.047	U38403.043.0001 7/16	0.469	1.000	0.125
U38400.013.0003 NO.6	0.156	0.438	0.047	U38403.050.0001 1/2	0.531	1.125	0.125
U38400.013.0004 NO.6	0.156	0.563	0.047	U38403.062.0001 5/8	0.656	1.375	0.125
U38400.016.0001 NO.8	0.188	0.438	0.049	U38403.075.0001 3/4	0.781	1.625	0.125
U38400.016.0002 NO.8	0.188	0.375	0.047	U38403.087.0001 7/8	0.906	1.750	0.156
U38400.016.0003 NO.8	0.188	0.500	0.047	U38403.100.0001 1 Inch	1.031	2.000	0.188
U38400.016.0004 NO.8	0.188	0.625	0.063	U38403.112.0001 1.1/8	1.156	2.250	0.219
U38400.016.0005 NO.10	0.219	0.375	0.047	U38403.125.0001 1.1/4	1.281	2.500	0.281
U38400.018.0001 1/4	0.281	0.562	0.049	U38405.025.0001 1/4	0.281	0.625	0.094
U38400.019.0001 NO.8	0.188	0.406	0.047	U38405.031.0001 5/16	0.344	0.688	0.094
U38400.019.0002 NO.8	0.188	0.563	0.047	U38405.037.0001 3/8	0.406	0.813	0.125
U38400.019.0003 NO.8	0.188	0.718	0.063	U38405.043.0001 7/16	0.469	0.906	0.125
U38400.019.0004 NO.10	0.219	0.500	0.049	U38405.056.0001 9/16	0.594	1.156	0.172
U38400.025.0001 1/4	0.281	0.500	0.063	U38405.062.0001 5/8	0.656	1.313	0.219
U38400.025.0002 1/4	0.281	0.718	0.063	U38405.075.0001 3/4	0.781	1.469	0.219
U38400.025.0003 1/4	0.281	1.000	0.063	U38405.087.0001 7/8	0.938	1.750	0.250
U38400.025.0004 5/16	0.344	0.750	0.063	U38405.100.0001 1 Inch	1.063	2.000	0.250
U38400.031.0001 5/16	0.344	0.625	0.063	U38405.112.0001 1.1/8	1.188	2.250	0.250
U38400.031.0002 5/16	0.344	0.875	0.063	U38405.125.0001 1.1/4	1.375	2.500	0.250
U38400.031.0003 5/16	0.344	1.125	0.063	U38405.137.0001 1.3/8	1.438	2.750	0.250
U38400.037.0001 3/8	0.406	0.718	0.063	U38405.150.0001 1.1/2	1.563	3.000	0.250
U38400.037.0002 3/8	0.406	1.000	0.063	U51410.006.0001 NO.0	0.063	0.125	0.016
U38400.037.0003 3/8	0.406	1.250	0.109	U51410.007.0001 NO.2	0.094	0.156	0.016
U38400.043.0001 7/16	0.469	0.875	0.063	U51410.008.0001 NO.2	0.094	0.188	0.031
U38400.043.0002 7/16	0.469	0.906	0.063	U51410.011.0001 NO.4	0.125	0.313	0.078
U38400.043.0003 7/16	0.469	1.125	0.063	U51410.011.0002 NO.4	0.125	0.250	0.063
U38400.043.0004 7/16	0.469	1.469	0.109	U51410.011.0003 NO.4	0.125	0.313	0.031
U38400.050.0001 1/2	0.531	1.000	0.063	U51410.013.0001 NO.6	0.156	0.375	0.049
U38400.050.0002 1/2	0.531	1.250	0.109	U51410.013.0002 NO.6	0.156	0.313	0.063
U38400.050.0003 1/2	0.531	1.750	0.109	U51410.013.0003 NO.6	0.156	0.375	0.031
U38400.056.0001 9/16	0.594	1.813	0.094	U51410.013.0004 NO.6	0.156	0.375	0.078
U38400.056.0002 5/8	0.625	1.500	0.109	U51410.016.0001 NO.6	0.156	0.375	0.063
U38400.075.0001 3/4	0.781	1.469	0.141	U51410.016.0002 NO.8	0.188	0.438	0.049
U38400.075.0002 3/4	0.781	1.500	0.141	U51410.016.0003 NO.8	0.188	0.438	0.078
U38400.075.0003 3/4	0.781	2.000	0.156	U51410.019.0001 NO.8	0.188	0.500	0.094
U38400.075.0004 3/4	0.813	2.000	0.156	U51410.019.0002 NO.10	0.219	0.500	0.049
U38400.112.0001 1.1/4	1.250	2.750	0.156	U51410.021.0001 1/4	0.281	0.562	0.065
U38400.125.0001 1.1/4	1.375	2.500	0.156	U51410.021.0002 1/4	0.281	0.500	0.047
U38400.137.0001 1.3/8	1.500	2.750	0.156	U51410.025.0001 1/4	0.281	0.500	0.078
U38400.137.0002 1.3/8	1.500	3.250	0.156	U51410.025.0002 1/4	0.281	0.625	0.047
U38400.150.0001 1.1/2	1.625	3.000	0.156	U51410.025.0003 1/4	0.281	0.625	0.125
U38402.013.0001 NO.6	0.156	0.375	0.049	U51410.025.0004 1/4	0.281	0.625	0.188

Technical Data				Technical Data			
Nr.	A	B	C	Nr.	A	B	C
U51410.025.0005 1/4	0.313	0.750	0.047	U51410.075.0004 3/4	0.781	1.625	0.250
U51410.031.0001 5/16	0.344	0.625	0.094	U51410.075.0005 3/4	0.781	1.750	0.078
U51410.031.0002 5/16	0.344	0.688	0.047	U51410.075.0006 3/4	0.781	1.750	0.109
U51410.031.0003 5/16	0.344	0.688	0.094	U51410.075.0007 3/4	0.781	2.000	0.125
U51410.031.0004 5/16	0.344	0.750	0.047	U51410.087.0001 7/8	0.906	1.750	0.156
U51410.031.0005 5/16	0.344	0.750	0.094	U51410.087.0002 7/8	0.906	1.750	0.250
U51410.031.0006 5/16	0.344	0.750	0.125	U51410.087.0003 7/8	0.938	2.000	0.094
U51410.031.0007 5/16	0.344	0.750	0.188	U51410.087.0004 7/8	0.938	2.000	0.109
U51410.031.0008 11/32	0.375	0.875	0.063	U51410.087.0005 7/8	0.938	2.250	0.141
U51410.037.0001 11/32	0.375	0.875	0.047	U51410.100.0001 1 Inch	1.031	2.000	0.188
U51410.037.0002 3/8	0.406	0.750	0.094	U51410.100.0002 1 Inch	1.031	2.000	0.250
U51410.037.0003 3/8	0.406	0.813	0.047	U51410.100.0003 1 Inch	1.031	2.000	0.281
U51410.037.0004 3/8	0.406	0.875	0.125	U51410.100.0004 1 Inch	1.063	2.000	0.109
U51410.037.0005 3/8	0.406	1.000	0.125	U51410.100.0005 1 Inch	1.063	2.500	0.141
U51410.037.0006 3/8	0.406	1.000	0.188	U51410.112.0001 1.1/8	1.156	2.250	0.219
U51410.037.0007 7/16	0.438	1.000	0.063	U51410.125.0001 1.1/4	1.281	2.500	0.281
U51410.043.0001 7/16	0.469	0.906	0.047	U55410.011.0001 NO.4	0.125	0.313	0.031
U51410.043.0002 7/16	0.469	0.906	0.125	U55410.016.0001 NO.6	0.156	0.375	0.031
U51410.043.0003 7/16	0.469	1.000	0.125	U55410.019.0001 NO.8	0.188	0.438	0.031
U51410.043.0004 7/16	0.469	1.000	0.188	U55410.019.0002 NO.10	0.219	0.500	0.049
U51410.043.0005 1/2	0.500	1.125	0.047	U55410.025.0001 1/4	0.281	0.625	0.047
U51410.043.0006 1/2	0.500	1.125	0.063	U55410.025.0002 1/4	0.313	0.750	0.047
U51410.043.0007 1/2	0.500	1.250	0.063	U55410.031.0001 5/16	0.344	0.688	0.047
U51410.050.0001 1/2	0.531	1.063	0.063	U55410.031.0002 5/16	0.344	0.750	0.047
U51410.050.0002 1/2	0.531	1.063	0.188	U55410.031.0003 11/32	0.375	0.875	0.063
U51410.050.0003 1/2	0.531	1.125	0.125	U55410.037.0001 11/32	0.375	0.875	0.047
U51410.050.0004 1/2	0.531	1.125	0.188	U55410.037.0002 3/8	0.406	0.813	0.047
U51410.050.0005 9/16	0.563	1.250	0.063	U55410.037.0003 7/16	0.438	1.000	0.063
U51410.050.0006 9/16	0.563	1.375	0.094	U55410.043.0001 7/16	0.469	0.906	0.047
U51410.056.0001 9/16	0.594	1.813	0.188	U55410.043.0002 1/2	0.500	1.250	0.063
U51410.056.0002 5/8	0.625	1.500	0.094	U55410.050.0001 1/2	0.531	1.063	0.063
U51410.062.0001 5/8	0.656	1.313	0.063	U55410.050.0002 9/16	0.563	1.250	0.063
U51410.062.0002 5/8	0.656	1.313	0.219	U55410.050.0003 9/16	0.563	1.375	0.094
U51410.062.0003 5/8	0.656	1.375	0.125	U55410.056.0001 5/8	0.625	1.500	0.094
U51410.062.0004 5/8	0.656	1.375	0.188	U55410.062.0001 5/8	0.656	1.313	0.063
U51410.062.0005 5/8	0.688	1.500	0.063	U55410.062.0002 5/8	0.688	1.500	0.078
U51410.062.0006 5/8	0.688	1.500	0.078	U55410.062.0003 5/8	0.688	1.750	0.109
U51410.062.0007 5/8	0.688	1.750	0.109	U55410.075.0001 3/4	0.781	1.500	0.109
U51410.075.0001 3/4	0.781	1.500	0.109	U55410.075.0002 3/4	0.781	2.000	0.125
U51410.075.0002 3/4	0.781	1.500	0.219	U55410.100.0001 1 Inch	1.063	2.000	0.109
U51410.075.0003 3/4	0.781	1.625	0.125	U55410.100.0002 1 Inch	1.063	2.500	0.141

7

Article groups			
Material	Surface treatment	Code	Page
St		U38403	7-47
St Case-hardened		U38402	7-48
St	Zipl	U38400	7-48
St	Zipl yell.p.	U38405	7-48
St.St. A2 (AISI304/18-8)		U51410	7-48
St.St. A4 (AISI316/18-10)		U55410	7-49



U38403 Custom flat washer X09A

Material: Steel

For nom. size	☒	Art.number	For nom. size	☒	Art.number	For nom. size	☒	Art.number
NO.4*	100	U38403.011.0001	5/16*	100	U38403.031.0001	3/4*	20	U38403.075.0001
NO.6*	100	U38403.013.0001	3/8*	50	U38403.037.0001	7/8*	10	U38403.087.0001
NO.8*	100	U38403.016.0001	7/16*	50	U38403.043.0001	1 Inch*	5	U38403.100.0001
NO.10*	100	U38403.019.0001	1/2*	50	U38403.050.0001	1.1/8*	5	U38403.112.0001
1/4*	100	U38403.025.0001	5/8*	25	U38403.062.0001	1.1/4*	5	U38403.125.0001

U38402	Custom flat washer	X09A
Material	Steel Case-hardened	 



For nom. size	☒	Art.number	For nom. size	☒	Art.number	For nom. size	☒	Art.number
NO.6*	100	U38402.013.0001	NO.10*	100	U38402.019.0001	2.1/4*	5	U38402.225.0001
NO.8*	100	U38402.016.0001	1.3/4*	5	U38402.175.0001	2.1/2*	5	U38402.250.0001
3/16*	100	U38402.018.0001	2 Inch*	5	U38402.200.0001	3 Inch*	5	U38402.300.0001

U38400	Custom flat washer	X09A
Material	Steel	 
Surface treatment	Zinc plated	
ASME ≈B18.21.1		

For nom. size	☒	Art.number	For nom. size	☒	Art.number	For nom. size	☒	Art.number
NO.0*	100	U38400.006.0001	NO.8*	100	U38400.016.0002	7/16*	50	U38400.043.0001
NO.0*	100	U38400.006.0002	NO.8*	100	U38400.016.0003	7/16*	50	U38400.043.0002
NO.0*	100	U38400.006.0003	NO.8*	100	U38400.016.0004	7/16*	50	U38400.043.0003
NO.1*	100	U38400.007.0001	NO.8*	100	U38400.016.0005	7/16*	50	U38400.043.0004
NO.1*	100	U38400.007.0002	3/16*	100	U38400.018.0001	1/2*	50	U38400.050.0001
NO.1*	100	U38400.007.0003	NO.10*	100	U38400.019.0001	1/2*	50	U38400.050.0002
NO.2*	100	U38400.008.0001	NO.10*	100	U38400.019.0002	1/2*	50	U38400.050.0003
NO.2*	100	U38400.008.0002	NO.10*	100	U38400.019.0003	9/16*	25	U38400.056.0001
NO.2*	100	U38400.008.0003	NO.10*	100	U38400.019.0004	9/16*	25	U38400.056.0002
NO.2*	100	U38400.011.0001	1/4*	100	U38400.025.0001	3/4*	20	U38400.075.0001
NO.4*	100	U38400.011.0002	1/4*	100	U38400.025.0002	3/4*	20	U38400.075.0002
NO.4*	100	U38400.011.0003	1/4*	100	U38400.025.0003	3/4*	20	U38400.075.0003
NO.4*	100	U38400.011.0004	1/4*	100	U38400.025.0004	3/4*	20	U38400.075.0004
NO.4*	100	U38400.011.0005	5/16*	100	U38400.031.0001	1.1/8*	5	U38400.112.0001
NO.6*	100	U38400.013.0001	5/16*	100	U38400.031.0002	1.1/4*	5	U38400.125.0001
NO.6*	100	U38400.013.0002	5/16*	100	U38400.031.0003	1.3/8*	5	U38400.137.0001
NO.6*	100	U38400.013.0003	3/8*	100	U38400.037.0001	1.3/8*	5	U38400.137.0002
NO.6*	100	U38400.013.0004	3/8*	100	U38400.037.0002	1.1/2*	5	U38400.150.0001
NO.8*	100	U38400.016.0001	3/8*	100	U38400.037.0003			

U38405	Custom flat washer	X09A
Material	Steel	
Surface treatment	Zinc plated yellow passivated	

For nom. size	☒	Art.number	For nom. size	☒	Art.number	For nom. size	☒	Art.number
1/4*	100	U38405.025.0001	5/8*	25	U38405.062.0001	1.1/8*	5	U38405.112.0001
5/16*	100	U38405.031.0001	3/4*	20	U38405.075.0001	1.1/4*	5	U38405.125.0001
3/8*	100	U38405.037.0001	7/8*	10	U38405.087.0001	1.3/8*	5	U38405.137.0001
7/16*	50	U38405.043.0001	1 Inch*	5	U38405.100.0001	1.1/2*	5	U38405.150.0001
9/16*	25	U38405.056.0001						

U51410	Custom flat washer	X15A
Material	Stainless steel A2 (AISI 304/18-8)	 

For nom. size	☒	Art.number	For nom. size	☒	Art.number	For nom. size	☒	Art.number
NO.0*	50	U51410.006.0001	NO.8*	50	U51410.016.0003	5/16*	50	U51410.031.0003
NO.1*	50	U51410.007.0001	NO.10*	50	U51410.019.0001	5/16*	50	U51410.031.0004
NO.2*	50	U51410.008.0001	NO.10*	50	U51410.019.0002	5/16*	50	U51410.031.0005
NO.4*	50	U51410.011.0001	NO.12*	50	U51410.021.0001	5/16*	50	U51410.031.0006
NO.4*	50	U51410.011.0002	NO.12*	50	U51410.021.0002	5/16*	50	U51410.031.0007
NO.4*	50	U51410.011.0003	1/4*	50	U51410.025.0001	5/16*	50	U51410.031.0008
NO.6*	50	U51410.013.0001	1/4*	50	U51410.025.0002	3/8*	50	U51410.037.0001
NO.6*	50	U51410.013.0002	1/4*	50	U51410.025.0003	3/8*	50	U51410.037.0002
NO.6*	50	U51410.013.0003	1/4*	50	U51410.025.0004	3/8*	50	U51410.037.0003
NO.6*	50	U51410.013.0004	1/4*	50	U51410.025.0005	3/8*	50	U51410.037.0004
NO.8*	50	U51410.016.0001	5/16*	50	U51410.031.0001	3/8*	50	U51410.037.0005
NO.8*	50	U51410.016.0002	5/16*	50	U51410.031.0002	3/8*	50	U51410.037.0006

7

U51410 Custom flat washer								
For nom. size	☒	Art.number	For nom. size	☒	Art.number	For nom. size	☒	Art.number
3/8*	50	U51410.037.0007	9/16*	25	U51410.056.0001	3/4*	20	U51410.075.0006
7/16*	25	U51410.043.0001	9/16*	25	U51410.056.0002	3/4*	20	U51410.075.0007
7/16*	25	U51410.043.0002	5/8*	25	U51410.062.0001	7/8*	5	U51410.087.0001
7/16*	25	U51410.043.0003	5/8*	25	U51410.062.0002	7/8*	5	U51410.087.0002
7/16*	25	U51410.043.0004	5/8*	25	U51410.062.0003	7/8*	5	U51410.087.0003
7/16*	25	U51410.043.0005	5/8*	25	U51410.062.0004	7/8*	5	U51410.087.0004
7/16*	25	U51410.043.0006	5/8*	25	U51410.062.0005	7/8*	5	U51410.087.0005
7/16*	25	U51410.043.0007	5/8*	25	U51410.062.0006	1 Inch*	5	U51410.100.0001
1/2*	25	U51410.050.0001	5/8*	25	U51410.062.0007	1 Inch*	5	U51410.100.0002
1/2*	25	U51410.050.0002	3/4*	20	U51410.075.0001	1 Inch*	5	U51410.100.0003
1/2*	25	U51410.050.0003	3/4*	20	U51410.075.0002	1 Inch*	5	U51410.100.0004
1/2*	25	U51410.050.0004	3/4*	20	U51410.075.0003	1 Inch*	5	U51410.100.0005
1/2*	25	U51410.050.0005	3/4*	20	U51410.075.0004	1.1/8*	5	U51410.112.0001
1/2*	25	U51410.050.0006	3/4*	20	U51410.075.0005	1.1/4*	5	U51410.125.0001

U55410 Custom flat washer		X15A
Material	Stainless steel A4 (AISI 316/18-10)	

For nom. size	☒	Art.number	For nom. size	☒	Art.number	For nom. size	☒	Art.number
NO.4*	50	U55410.011.0001	3/8*	50	U55410.037.0001	5/8*	25	U55410.062.0001
NO.8*	50	U55410.016.0001	3/8*	50	U55410.037.0002	5/8*	25	U55410.062.0002
NO.10*	50	U55410.019.0001	3/8*	50	U55410.037.0003	5/8*	25	U55410.062.0003
NO.10*	50	U55410.019.0002	7/16*	25	U55410.043.0001	3/4*	20	U55410.075.0001
1/4*	50	U55410.025.0001	7/16*	25	U55410.043.0002	3/4*	20	U55410.075.0002
1/4*	50	U55410.025.0002	1/2*	25	U55410.050.0001	1 Inch*	5	U55410.100.0001
5/16*	50	U55410.031.0001	1/2*	25	U55410.050.0002	1 Inch*	5	U55410.100.0002
5/16*	50	U55410.031.0002	1/2*	25	U55410.050.0003			
5/16*	50	U55410.031.0003	9/16*	25	U55410.056.0001			

Helical spring lock washer

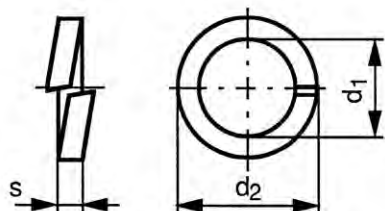

DIN 127 B
 NEN 1197 B
 NF E25-515
 BS 4464 B



7

Technical Data							
For nom.size	d ₁ (min.)	d ₂ (max.)	s	For nom.size	d ₁ (min.)	d ₂ (max.)	s
M2	2.1	4.4	0.5	M22	22.5	35.9	4
M2.3 (#DIN)	2.4	4.9	0.6	M24	24.5	40	5
M2.5	2.6	5.1	0.6	M27	27.5	43	5
M2.6 (#DIN)	2.7	5.2	0.6	M30	30.5	48.2	6
M3	3.1	6.2	0.8	M33 (#DIN)	33.5	55.2	6
M3.5	3.6	6.7	0.8	M36	36.5	58.2	6
M4	4.1	7.6	0.9	M39	39.5	61.2	6
M5	5.1	9.2	1.2	M42	42.5	68.2	7
M6	6.1	11.8	1.6	M45	45.5	71.2	7
M7	7.1	12.8	1.6	M48	49	75	7
M8	8.1	14.8	2	M52	53	83	8
M10	10.2	18.1	2.2	M56	57	87	8
M11 (#DIN)	11.2	18.2	2.2	M60	61	91	8
M12	12.2	21.1	2.5	M64	65	95	8
M14	14.2	24.1	3	M68	69	99	8
M16	16.2	27.4	3.5	M72	73	103	8
M18	18.2	29.4	3.5	M76 (#DIN)	77	107	8
M20	20.2	33.6	4				

- Spring washers acc. to DIN 127 B should be used in combination with fasteners of property class ≤ 5.8, use under dynamic load is not allowed.
- For locking under dynamic load is referred to locking edge washers and NORD-LOCK vibration proof washers.
- Depending on availability these articles can be supplied zinc plated as well as mechanical plated.
- WARNING: electro-galvanizing of these products may cause hydrogen embrittlement

Article groups

Material	Surface treatment	Code	Page	
Spring steel DIN267-26		37000	7-50	
Spring steel DIN267-26	Zipl	37020	7-50	
Spring steel DIN267-26	Zipl	large pack	37030	7-50
Spring steel DIN267-26	Zipl yell.p.	37060	7-51	
Spring steel DIN267-26	FLZNNC-NC6	37024	7-51	
Spring steel DIN267-26	Hot d.g.	37025	7-51	
St.St. A2		51450	7-51	
St.St. A4		55450	7-51	
St.St. A5		52451	7-52	
Al P60		45790	7-52	

37000 Helical spring lock washer L05A

Material	Spring steel DIN267-26		
-----------------	------------------------	---	---

For nom. size	☒	Art.number	For nom. size	☒	Art.number	For nom. size	☒	Art.number
M3	250	37000.030.001	M16	100	37000.160.001	M42	10	37000.420.001
M3,5	250	37000.035.001	M18	100	37000.180.001	M45	10	37000.450.001
M4	250	37000.040.001	M20	100	37000.200.001	M48	10	37000.480.001
M5	250	37000.050.001	M22	50	37000.220.001	M52	10	37000.520.001
M6	250	37000.060.001	M24	50	37000.240.001	M56	5	37000.560.001
M7	250	37000.070.001	M27	25	37000.270.001	M60	5	37000.600.001
M8	200	37000.080.001	M30	25	37000.300.001	M64	5	37000.640.001
M10	200	37000.100.001	M33	25	37000.330.001	M68	5	37000.680.001
M11	150	37000.110.001	M36	25	37000.360.001	M72	5	37000.720.001
M12	150	37000.120.001	M39	10	37000.390.001	M76	5	37000.760.001
M14	100	37000.140.001						

37020 Helical spring lock washer L05A

Material	Spring steel DIN267-26		
Surface treatment	Zinc plated		

For nom. size	☒	Art.number	For nom. size	☒	Art.number	For nom. size	☒	Art.number
M2	500	37020.020.001	M7	250	37020.070.001	M20	100	37020.200.001
M2,3	500	37020.023.001	M8	200	37020.080.001	M22	50	37020.220.001
M2,6	500	37020.026.001	M10	200	37020.100.001	M24	50	37020.240.001
M3	250	37020.030.001	M11	150	37020.110.001	M27	25	37020.270.001
M3,5	250	37020.035.001	M12	150	37020.120.001	M30	25	37020.300.001
M4	250	37020.040.001	M14	100	37020.140.001	M33	25	37020.330.001
M5	250	37020.050.001	M16	100	37020.160.001	M36	25	37020.360.001
M6	250	37020.060.001	M18	100	37020.180.001	M39	10	37020.390.001

37030 Helical spring lock washer L05A

Material	Spring steel DIN267-26		
Surface treatment	Zinc plated		

For nom. size	☒	Art.number	For nom. size	☒	Art.number	For nom. size	☒	Art.number
M3	2500	37030.030.001	M8	2000	37030.080.001	M16	500	37030.160.001
M4	2500	37030.040.001	M10	1500	37030.100.001	M20	250	37030.200.001
M5	2500	37030.050.001	M12	1000	37030.120.001	M22	250	37030.220.001
M6	2000	37030.060.001	M14	500	37030.140.001	M24	250	37030.240.001

37060	Helical spring lock washer			L05A
Material	Spring steel DIN267-26			
Surface treatment	Zinc plated yellow passivated			



For nom. size	☒	Art.number	For nom. size	☒	Art.number	For nom. size	☒	Art.number
M3	250	37060.030.001	M8	200	37060.080.001	M18	100	37060.180.001
M4	250	37060.040.001	M10	200	37060.100.001	M20	100	37060.200.001
M5	250	37060.050.001	M12	150	37060.120.001	M22	50	37060.220.001
M6	250	37060.060.001	M14	100	37060.140.001	M24	50	37060.240.001
M7	250	37060.070.001	M16	100	37060.160.001			

37024	Helical spring lock washer			L05A
Material	Spring steel DIN267-26			
Surface treatment	Zinc flake Cr ⁶⁺ free - ISO 10683 flZnnc			
				

For nom. size	☒	Art.number	For nom. size	☒	Art.number	For nom. size	☒	Art.number
M6	250	37024.060.001	M12	150	37024.120.001	M24	50	37024.240.001
M8	200	37024.080.001	M16	100	37024.160.001	M30	25	37024.300.001
M10	200	37024.100.001	M20	100	37024.200.001			



37025	Helical spring lock washer			A08A
Material	Spring steel DIN267-26			
Surface treatment	Hot dip galvanized			
				

For nom. size	☒	Art.number	For nom. size	☒	Art.number	For nom. size	☒	Art.number
M6	250	37025.060.001	M16	100	37025.160.001	M24	50	37025.240.001
M8	200	37025.080.001	M18	100	37025.180.001	M27	25	37025.270.001
M10	200	37025.100.001	M20	100	37025.200.001	M30	25	37025.300.001
M12	150	37025.120.001	M22	50	37025.220.001	M36	25	37025.360.001
M14	150	37025.140.001						

51450	Helical spring lock washer			R07A
Material	Stainless steel A2			
	DIN	≈127 B		
	NEN	≈1197 B		
	NF	≈E25-515		
	BS	≈4464 B		
				

For nom. size	☒	Art.number	For nom. size	☒	Art.number	For nom. size	☒	Art.number
M2	200	51450.020.001	M8	500	51450.080.001	M24	100	51450.240.001
M2,3	200	51450.023.001	M10	500	51450.100.001	M27	50	51450.270.001
M2,5	200	51450.025.001	M11	500	51450.110.001	M30	50	51450.300.001
M2,6	200	51450.026.001	M12	500	51450.120.001	M33	50	51450.330.001
M3	500	51450.030.001	M14	200	51450.140.001	M36	50	51450.360.001
M3,5	500	51450.035.001	M16	200	51450.160.001	M39*	25	51450.390.001
M4	500	51450.040.001	M18	200	51450.180.001	M42*	25	51450.420.001
M5	500	51450.050.001	M20	200	51450.200.001	M45*	25	51450.450.001
M6	500	51450.060.001	M22	100	51450.220.001	M48*	25	51450.480.001
M7	500	51450.070.001						



• Technical data is according to DIN with the exception of material type stainless steel.

55450	Helical spring lock washer			R47A
Material	Stainless steel A4			
	DIN	≈127 B		
	NEN	≈1197 B		
	NF	≈E25-515		
	BS	≈4464 B		
				

For nom. size	☒	Art.number	For nom. size	☒	Art.number	For nom. size	☒	Art.number
M2	200	55450.020.001	M3	500	55450.030.001	M4	500	55450.040.001
M2,5	200	55450.025.001	M3,5*	1000	55450.035.001	M5	500	55450.050.001

55450 Helical spring lock washer								
For nom. size	☒	Art.number	For nom. size	☒	Art.number	For nom. size	☒	Art.number
M6		500 55450.060.001	M18		200 55450.180.001	M33		50 55450.330.001
M8		500 55450.080.001	M20		200 55450.200.001	M36		50 55450.360.001
M10		500 55450.100.001	M22		100 55450.220.001	M39*		25 55450.390.001
M12		500 55450.120.001	M24		100 55450.240.001	M42*		25 55450.420.001
M14		200 55450.140.001	M27		50 55450.270.001			
M16		200 55450.160.001	M30		50 55450.300.001			

• Technical data is according to DIN with the exception of material type stainless steel.

52451 Helical spring lock washer						R45A
Material	Stainless steel A5		DIN	≈127 B		
		NEN	≈1197 B			
		NF	≈E25-515			
		BS	≈4464 B			
						
For nom. size	☒	Art.number	For nom. size	☒	Art.number	
M8*		1000 52451.080.001	M10*		500 52451.100.001	

45790 Helical spring lock washer						W01A		
Material	Aluminium P60		DIN	≈127 B				
		NEN	≈1197 B					
		NF	≈E25-515					
		BS	≈4464 B					
For nom. size	☒	Art.number	For nom. size	☒	Art.number	For nom. size	☒	Art.number
M6		250 45790.060.001	M10		200 45790.100.001	M14		100 45790.140.001
M8		200 45790.080.001	M12		150 45790.120.001	M16		100 45790.160.001

Helical spring lock washer

ASME B18.21.1

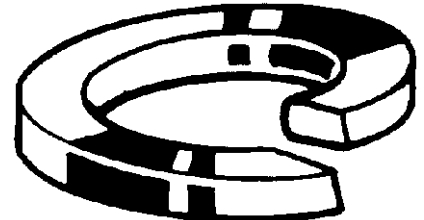
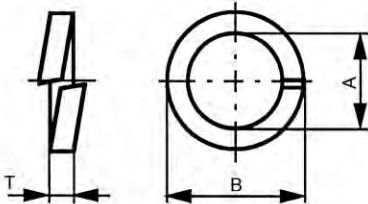

Technical Data

For nom.size	A	B	T
No.2	0.088	0.172	0.02
No.3	0.101	0.195	0.025
No.4	0.114	0.209	0.025
No.5	0.127	0.236	0.031
No.6	0.141	0.25	0.031
No.8	0.167	0.293	0.040
No.10	0.193	0.334	0.047
No.12	0.22	0.377	0.056
1/4	0.252	0.487	0.062
5/16	0.314	0.583	0.078
3/8	0.377	0.68	0.094
7/16	0.44	0.77	0.109
1/2	0.502	0.869	0.125
9/16	0.564	0.965	0.141
5/8	0.628	1.073	0.156
3/4	0.753	1.265	0.188
7/8	0.878	1.459	0.219
1 Inch	1.003	1.656	0.25
1.1/8	1.129	1.847	0.281
1.1/4	1.254	2.036	0.312
1.3/8	1.379	2.219	0.344
1.1/2	1.504	2.419	0.375
1.5/8	1.633	2.553	0.359

Technical Data			
For nom.size	A	B	T
1.3/4	1.758	2.679	0.389
1.7/8	1.883	2.811	0.422
2 Inch	2.008	2.936	0.422
2.1/2	2.512	3.471	0.44
3 Inch	3.012	4.074	0.458

Article groups			
Material	Surface treatment	Code	Page
St		U37000	7-53
St	Zipl	U37020	7-53
St	Zipl yell.p.	U37060	7-53
St	Hot d.g.	U37025	7-54
St.St. A2 (AISI304/18-8)		U51450	7-54
St.St. A4 (AISI316/18-10)		U55450	7-54
Br SL		U43150	7-54

U37000 Helical spring lock washer X09A

Material Steel



For nom. size	☒	Art.number	For nom. size	☒	Art.number	For nom. size	☒	Art.number
NO.2	100	U37000.008.0001	3/8*	50	U37000.037.0001	1.1/4*	5	U37000.125.0001
NO.3*	100	U37000.009.0001	7/16*	25	U37000.043.0001	1.3/8*	5	U37000.137.0001
NO.4*	100	U37000.011.0001	1/2*	25	U37000.050.0001	1.1/2*	5	U37000.150.0001
NO.5*	100	U37000.012.0001	9/16*	25	U37000.056.0001	1.5/8*	5	U37000.162.0001
NO.6*	100	U37000.013.0001	5/8*	10	U37000.062.0001	1.3/4*	5	U37000.175.0001
NO.8*	100	U37000.016.0001	3/4*	10	U37000.075.0001	1.7/8*	5	U37000.187.0001
NO.10*	100	U37000.019.0001	7/8*	5	U37000.087.0001	2 Inch*	5	U37000.200.0001
NO.12*	100	U37000.021.0001	1 Inch*	5	U37000.100.0001	2.1/2*	5	U37000.250.0001
1/4*	100	U37000.025.0001	1.1/8*	5	U37000.112.0001	3 Inch*	5	U37000.300.0001
5/16*	100	U37000.031.0001						

U37020 Helical spring lock washer X09A

Material Steel
Surface treatment Zinc plated



For nom. size	☒	Art.number	For nom. size	☒	Art.number	For nom. size	☒	Art.number
NO.2*	100	U37020.008.0001	1/4*	100	U37020.025.0001	7/8*	5	U37020.087.0001
NO.3*	100	U37020.009.0001	5/16*	100	U37020.031.0001	1 Inch*	5	U37020.100.0001
NO.4*	100	U37020.011.0001	3/8*	50	U37020.037.0001	1.1/8*	5	U37020.112.0001
NO.5*	100	U37020.012.0001	7/16*	25	U37020.043.0001	1.1/4*	5	U37020.125.0001
NO.6*	100	U37020.013.0001	1/2*	25	U37020.050.0001	1.3/8*	5	U37020.137.0001
NO.8*	100	U37020.016.0001	9/16*	25	U37020.056.0001	1.1/2*	5	U37020.150.0001
NO.10*	100	U37020.019.0001	5/8*	10	U37020.062.0001	1.3/4*	5	U37020.175.0001
NO.12*	100	U37020.021.0001	3/4*	10	U37020.075.0001	2 Inch*	5	U37020.200.0001

U37060 Helical spring lock washer X09A

Material Steel
Surface treatment Zinc plated yellow passivated



For nom. size	☒	Art.number	For nom. size	☒	Art.number	For nom. size	☒	Art.number
1/4*	100	U37060.025.0001	5/8*	10	U37060.062.0001	1.3/8*	5	U37060.137.0001
5/16*	100	U37060.031.0001	3/4*	10	U37060.075.0001	1.1/2*	5	U37060.150.0001
3/8*	50	U37060.037.0001	7/8*	5	U37060.087.0001	1.3/4*	5	U37060.175.0001
7/16*	25	U37060.043.0001	1 Inch*	5	U37060.100.0001	2 Inch*	5	U37060.200.0001
1/2*	25	U37060.050.0001	1.1/8*	5	U37060.112.0001			
9/16*	25	U37060.056.0001	1.1/4*	5	U37060.125.0001			

U37025 Helical spring lock washer X09A

Material Steel
Surface treatment Hot dip galvanized



For nom. size	☒	Art.number	For nom. size	☒	Art.number	For nom. size	☒	Art.number
1/4*	100	U37025.025.0001	3/4*	10	U37025.075.0001	1.1/2*	5	U37025.150.0001
5/16*	100	U37025.031.0001	7/8*	5	U37025.087.0001	1.3/4*	5	U37025.175.0001
3/8*	50	U37025.037.0001	1 Inch*	5	U37025.100.0001	2 Inch*	5	U37025.200.0001
7/16*	25	U37025.043.0001	1.1/8*	5	U37025.112.0001	2.1/2*	5	U37025.250.0001
1/2*	25	U37025.050.0001	1.1/4*	5	U37025.125.0001			
5/8*	10	U37025.062.0001	1.3/8*	5	U37025.137.0001			

U51450 Helical spring lock washer X15A

Material Stainless steel A2 (AISI 304/18-8)



For nom. size	☒	Art.number	For nom. size	☒	Art.number	For nom. size	☒	Art.number
NO.2*	50	U51450.008.0001	NO.12*	50	U51450.021.0001	5/8*	10	U51450.062.0001
NO.3*	50	U51450.009.0001	1/4*	50	U51450.025.0001	3/4*	5	U51450.075.0001
NO.4*	50	U51450.011.0001	5/16*	50	U51450.031.0001	7/8*	5	U51450.087.0001
NO.5*	50	U51450.012.0001	3/8*	50	U51450.037.0001	1 Inch*	5	U51450.100.0001
NO.6*	50	U51450.013.0001	7/16*	25	U51450.043.0001	1.1/8*	5	U51450.112.0001
NO.8*	50	U51450.016.0001	1/2*	10	U51450.050.0001	1.1/4*	5	U51450.125.0001
NO.10*	50	U51450.019.0001	9/16*	10	U51450.056.0001	1.1/2*	5	U51450.150.0001

U55450 Helical spring lock washer X15A

Material Stainless steel A4 (AISI 316/18-10)



For nom. size	☒	Art.number	For nom. size	☒	Art.number	For nom. size	☒	Art.number
NO.2*	50	U55450.008.0001	1/4*	50	U55450.025.0001	3/4*	5	U55450.075.0001
NO.3*	50	U55450.009.0001	5/16*	50	U55450.031.0001	7/8*	5	U55450.087.0001
NO.4*	50	U55450.011.0001	3/8*	50	U55450.037.0001	1 Inch*	5	U55450.100.0001
NO.6*	50	U55450.013.0001	7/16*	25	U55450.043.0001	1.1/8*	5	U55450.112.0001
NO.8*	50	U55450.016.0001	1/2*	10	U55450.050.0001	1.1/4*	5	U55450.125.0001
NO.10*	50	U55450.019.0001	9/16*	10	U55450.056.0001	1.1/2*	5	U55450.150.0001
NO.12*	50	U55450.021.0001	5/8*	10	U55450.062.0001			

U43150 Helical spring lock washer X09A

Material Bronze SL





For nom. size	☒	Art.number	For nom. size	☒	Art.number	For nom. size	☒	Art.number
NO.4*	100	U43150.011.0001	1/4*	100	U43150.025.0001	1/2*	25	U43150.050.0001
NO.10*	100	U43150.019.0001	3/8*	50	U43150.037.0001	5/8*	10	U43150.062.0001
NO.12*	100	U43150.021.0001						

7

Spring lock washer helical heavy

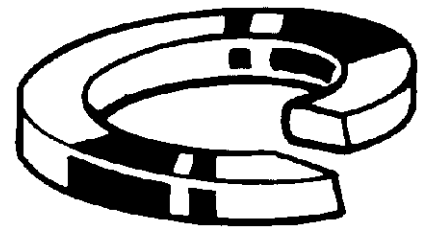
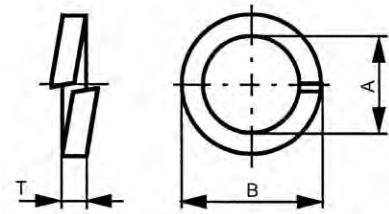
ASME B18.21.1



Technical Data

For nom.size	A	B	T
No.2	0.088	0.182	0.025
No.3	0.101	0.209	0.031
No.4	0.114	0.223	0.031
No.5	0.127	0.252	0.040
No.6	0.141	0.266	0.040
No.8	0.167	0.307	0.047
No.10	0.193	0.350	0.056
No.12	0.220	0.391	0.063
1/4	0.252	0.489	0.077
5/16	0.314	0.593	0.097
3/8	0.377	0.688	0.115
7/16	0.440	0.784	0.133
1/2	0.502	0.879	0.151
9/16	0.564	0.975	0.170
5/8	0.628	1.087	0.189
3/4	0.753	1.285	0.226
7/8	0.878	1.489	0.266
1 Inch	1.003	1.700	0.306
1.1/8	1.129	1.903	0.345
1.1/4	1.254	2.104	0.384
1.3/8	1.379	2.301	0.422
1.1/2	1.504	2.491	0.458
1.5/8	1.633	2.694	0.458
1.3/4	1.758	2.82	0.458
2 Inch	2.008	3.144	0.496
2.1/4	2.262	3.398	0.496
2.1/2	2.512	3.648	0.496
3 Inch	3.012	4.160	0.526

7

Article groups

Material	Surface treatment	Code	Page
St HV		U37180	7-55
St HV	Zipl	U37183	7-56

U37180 Spring lock washer helical heavy

X09A

Material Steel HV



For nom. size	☒	Art.number	For nom. size	☒	Art.number	For nom. size	☒	Art.number
NO.4*	100	U37180.011.0001	7/16*	25	U37180.043.0001	1.3/8*	5	U37180.137.0001
NO.5*	100	U37180.012.0001	1/2*	25	U37180.050.0001	1.1/2*	5	U37180.150.0001
NO.6*	100	U37180.013.0001	9/16*	25	U37180.056.0001	1.5/8*	5	U37180.162.0001
NO.8*	100	U37180.016.0001	5/8*	10	U37180.062.0001	1.3/4*	5	U37180.175.0001
NO.10*	100	U37180.019.0001	3/4*	10	U37180.075.0001	2 Inch*	5	U37180.200.0001
NO.12*	100	U37180.021.0001	7/8*	5	U37180.087.0001	2.1/4*	5	U37180.225.0001
1/4*	100	U37180.025.0001	1 Inch*	5	U37180.100.0001	2.1/2*	5	U37180.250.0001
5/16*	100	U37180.031.0001	1.1/8*	5	U37180.112.0001	3 Inch*	5	U37180.300.0001
3/8*	50	U37180.037.0001	1.1/4*	5	U37180.125.0001			

U37183 Spring lock washer helical heavy X09A

Material Steel HV
Surface treatment Zinc plated



For nom. size	☒	Art.number	For nom. size	☒	Art.number	For nom. size	☒	Art.number
NO.3*	100	U37183.009.0001	1/4*	100	U37183.025.0001	3/4*	10	U37183.075.0001
NO.4*	100	U37183.011.0001	5/16*	100	U37183.031.0001	7/8*	5	U37183.087.0001
NO.5*	100	U37183.012.0001	3/8*	50	U37183.037.0001	1 Inch*	5	U37183.100.0001
NO.6*	100	U37183.013.0001	7/16*	25	U37183.043.0001	1.1/8*	5	U37183.112.0001
NO.8*	100	U37183.016.0001	1/2*	25	U37183.050.0001	1.1/4*	5	U37183.125.0001
NO.10*	100	U37183.019.0001	9/16*	25	U37183.056.0001	1.3/8*	5	U37183.137.0001
NO.12*	100	U37183.021.0001	5/8*	10	U37183.062.0001	1.1/2*	5	U37183.150.0001

Spring lock washer helical extra duty

ASME B18.21.1

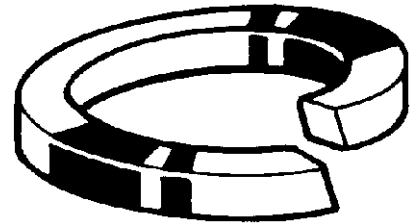
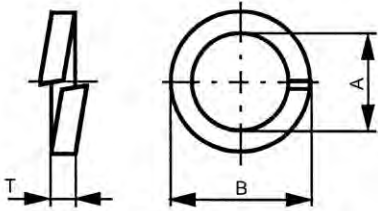

Technical Data

For nom.size	A	B	T
No.4	0.114	0.253	0.034
No.6	0.141	0.314	0.045
No.8	0.167	0.375	0.057
No.10	0.193	0.434	0.068
No.12	0.220	0.497	0.080
1/4	0.252	0.533	0.084
5/16	0.314	0.619	0.108
3/8	0.377	0.738	0.123
7/16	0.440	0.836	0.143
1/2	0.502	0.935	0.162
9/16	0.564	1.035	0.182
5/8	0.628	1.151	0.202
3/4	0.753	1.355	0.241
7/8	0.878	1.571	0.285
1 Inch	1.003	1.794	0.330
1.1/8	1.129	2.013	0.375
1.1/4	1.254	2.222	0.417
1.1/2	1.504	2.627	0.496

Article groups

Material	Surface treatment	Code	Page
St		U37170	7-56
St	Zipl	U37171	7-57

U37170 Spring lock washer helical extra duty X09A

Material Steel



For nom. size	☒	Art.number	For nom. size	☒	Art.number	For nom. size	☒	Art.number
NO.4*	100	U37170.011.0001	3/8*	50	U37170.037.0001	7/8*	5	U37170.087.0001
NO.6*	100	U37170.013.0001	7/16*	25	U37170.043.0001	1 Inch*	5	U37170.100.0001
NO.8*	100	U37170.016.0001	1/2*	25	U37170.050.0001	1.1/8*	5	U37170.112.0001
NO.10*	100	U37170.019.0001	9/16*	25	U37170.056.0001	1.1/4*	5	U37170.125.0001
1/4*	100	U37170.025.0001	5/8*	10	U37170.062.0001	1.1/2*	5	U37170.150.0001
5/16*	100	U37170.031.0001	3/4*	10	U37170.075.0001			

U37171 Spring lock washer helical extra duty X09A

Material Steel
Surface treatment Zinc plated

For nom. size	☒	Art.number	For nom. size	☒	Art.number	For nom. size	☒	Art.number
NO.4*	100	U37171.011.0001	5/16*	100	U37171.031.0001	7/8*	5	U37171.087.0001
NO.6*	100	U37171.013.0001	3/8*	50	U37171.037.0001	1 Inch*	5	U37171.100.0001
NO.8*	100	U37171.016.0001	7/16*	25	U37171.043.0001	1.1/8*	5	U37171.112.0001
NO.10*	100	U37171.019.0001	9/16*	25	U37171.056.0001	1.1/4*	5	U37171.125.0001
NO.12*	100	U37171.021.0001	5/8*	10	U37171.062.0001	1.1/2*	5	U37171.150.0001
1/4*	100	U37171.025.0001	3/4*	10	U37171.075.0001			

Spring lock washer for screw with cylindrical head

DIN 7980
BS 4464 A

Technical Data			
For nom.size	d ₁ (min.)	d ₂ (max.)	s
M3	3.1	5.6	1
M3.5	3.6	6.1	1
M4	4.1	7	1.2
M5	5.1	8.8	1.6
M6	6.1	9.9	1.6
M8	8.1	12.7	2
M10	10.2	16	2.5
M12	12.2	18	2.5
M14	14.2	21.1	3

For nom.size	d ₁ (min.)	d ₂ (max.)	s
M16	16.2	24.4	3.5
M18	18.2	26.4	3.5
M20	20.2	30.6	4.5
M22	22.5	32.9	4.5
M24	24.5	35.9	5
M27	27.5	38.9	5
M30	30.5	44.1	6
M36	36.5	52.2	7

Article groups			
Material	Surface treatment	Code	Page
Spring steel DIN267-26		37200	7-57
Spring steel DIN267-26	Zipl	37220	7-58
St.St. A2		51390	7-58
St.St. A4		55390	7-58

37200 Spring lock washer for screw with cylindrical head L07D

Material Spring steel DIN267-26

For nom. size	☒	Art.number	For nom. size	☒	Art.number	For nom. size	☒	Art.number
M3	250	37200.030.001	M12	150	37200.120.001	M24	50	37200.240.001
M4	250	37200.040.001	M14	100	37200.140.001	M27	50	37200.270.001
M5	250	37200.050.001	M16	100	37200.160.001	M30	50	37200.300.001
M6	250	37200.060.001	M18	250	37200.180.001	M36	50	37200.360.001
M8	200	37200.080.001	M20	100	37200.200.001			
M10	200	37200.100.001	M22	50	37200.220.001			

- Spring lock washers acc. to DIN 7980 should be used in combination with fasteners of property class < 8.8, use under dynamic load is not allowed.
- For locking under dynamic load is referred to locking edge washers and NORD-LOCK vibration proof washers.
- Depending on availability these articles can be supplied zinc plated as well as mechanical plated.
- Warning: electro-galvanizing of these products may cause hydrogen embrittlement.

37220 Spring lock washer for screw with cylindrical head L07D

Material Spring steel DIN267-26
Surface treatment Zinc plated





For nom. size	☒	Art.number	For nom. size	☒	Art.number	For nom. size	☒	Art.number
M3	250	37220.030.001	M10	200	37220.100.001	M22	50	37220.220.001
M4	250	37220.040.001	M12	150	37220.120.001	M24	50	37220.240.001
M5	250	37220.050.001	M14	100	37220.140.001	M27	50	37220.270.001
M6	250	37220.060.001	M16	100	37220.160.001	M30	50	37220.300.001
M8	200	37220.080.001	M20	100	37220.200.001			

- Spring lock washers acc. to DIN 7980 should be used in combination with fasteners of property class < 8.8, use under dynamic load is not allowed.
- For locking under dynamic load is referred to locking edge washers and NORD-LOCK vibration proof washers.
- Depending on availability these articles can be supplied zinc plated as well as mechanical plated.

51390 Spring lock washer for screw with cylindrical head R09A

Material Stainless steel A2
DIN ≈7980
BS ≈4464 A





For nom. size	☒	Art.number	For nom. size	☒	Art.number	For nom. size	☒	Art.number
M3	250	51390.030.001	M8	250	51390.080.001	M18	100	51390.180.001
M3,5*	1000	51390.035.001	M10	200	51390.100.001	M20	100	51390.200.001
M4	250	51390.040.001	M12	200	51390.120.001	M24	50	51390.240.001
M5	250	51390.050.001	M14	100	51390.140.001	M27	50	51390.270.001
M6	250	51390.060.001	M16	100	51390.160.001	M30	50	51390.300.001

- Use under dynamic load is not allowed.
- For locking under dynamic load is referred to NORD-LOCK vibration proof washers.
- The austenetic steel type is at the manufacturer's discretion, and can vary from the steel types stated in DIN 267-11.

55390 Spring lock washer for screw with cylindrical head R49A

Material Stainless steel A4
DIN ≈7980
BS ≈4464 A

For nom. size	☒	Art.number	For nom. size	☒	Art.number	For nom. size	☒	Art.number
M3	250	55390.030.001	M10	200	55390.100.001	M20	100	55390.200.001
M4	250	55390.040.001	M12	200	55390.120.001	M24	50	55390.240.001
M5	250	55390.050.001	M14	100	55390.140.001	M27	50	55390.270.001
M6	250	55390.060.001	M16	100	55390.160.001	M30	50	55390.300.001
M8	250	55390.080.001	M18	100	55390.180.001			

- Use under dynamic load is not allowed.
- For locking under dynamic load is referred to NORD-LOCK vibration proof washers.
- The austenetic steel type is at the manufacturer's discretion, and can vary from the steel types stated in DIN 267-11.

7

Spring lock washer helical high collar

ASME B18.21.1

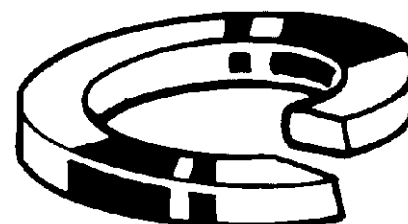
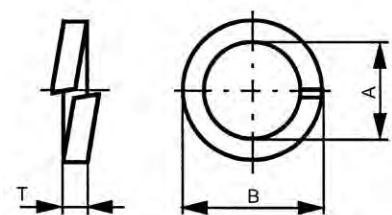

Technical Data

For nom.size	A	B	T
No.4	0.114	0.173	0.022
No.5	0.127	0.202	0.030
No.6	0.141	0.216	0.03
No.8	0.167	0.267	0.047
No.10	0.193	0.294	0.047
1/4	0.252	0.363	0.078
5/16	0.314	0.457	0.093
3/8	0.377	0.550	0.125
7/16	0.440	0.644	0.140
1/2	0.502	0.733	0.172
5/8	0.628	0.917	0.203
3/4	0.753	1.105	0.218
7/8	0.878	1.291	0.234
1 Inch	1.003	1.478	0.250
1.1/4	1.254	1.790	0.313
1.1/2	1.504	2.159	0.375

Article groups

Material	Code	Page
St	U37200	7-59
St.St. A2 (AISI304/18-8)	U51390	7-59

U37200 Spring lock washer helical high collar X09A

Material: Steel



For nom. size	☒	Art.number	For nom. size	☒	Art.number	For nom. size	☒	Art.number
NO.4*	100	U37200.011.0001	5/16*	100	U37200.031.0001	7/8*	5	U37200.087.0001
NO.5*	100	U37200.012.0001	3/8*	50	U37200.037.0001	1 Inch*	5	U37200.100.0001
NO.6*	100	U37200.013.0001	7/16*	25	U37200.043.0001	1.1/4*	5	U37200.125.0001
NO.8*	100	U37200.016.0001	1/2*	25	U37200.050.0001	1.1/2*	5	U37200.150.0001
NO.10*	100	U37200.019.0001	5/8*	10	U37200.062.0001			
1/4*	100	U37200.025.0001	3/4*	10	U37200.075.0001			

U51390 Spring lock washer helical high collar X15A

Material: Stainless steel A2 (AISI 304/18-8)



For nom. size	☒	Art.number	For nom. size	☒	Art.number	For nom. size	☒	Art.number
1/4	50	U51390.025.0001	3/8*	50	U51390.037.0001	7/16*	25	U51390.043.0001
5/16*	50	U51390.031.0001						

Double coil spring lock washer

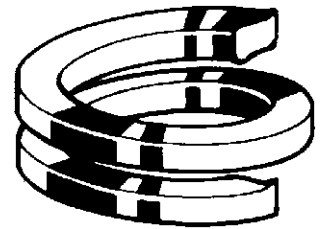
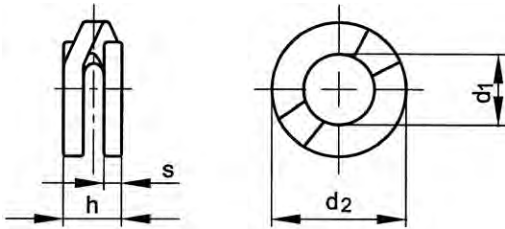

Technical Data

For nom. size	d ₁	d ₂	h	s
M5	5.1	8.7	4.2	1.2
M6	6.1	11.1	5.6	1.6
M8	8.2	14.2	7	2
M10	10.2	17.2	7.7	2.2
M12	12.2	20.2	8.8	2.5
M16	16.2	26.2	12.3	3.5
M20	20.2	32.2	14	4
M22	22.5	34.5	14	4
M26	26.5	40.5	17.5	5

37240 Double coil spring lock washer

L07D

Material Spring steel



For nom. size	☒	Art.number	For nom. size	☒	Art.number	For nom. size	☒	Art.number
M5	100	37240.050.001	M10	100	37240.100.001	M20	50	37240.200.001
M6	100	37240.060.001	M12	100	37240.120.001	M22	25	37240.220.001
M8	100	37240.080.001	M16	50	37240.160.001	M26	25	37240.260.001

- Warning: electro-galvanizing of these products may cause hydrogen embrittlement.

Conical spring washer

DIN 74361 C

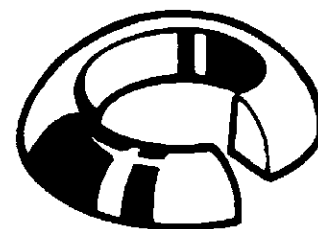
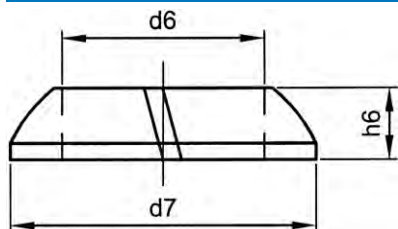

Technical Data

d	d ₆	d ₇	h ₆	d	d ₆	d ₇	h ₆
M12	12.5	23	5	M18	18.5	29	7
M14	14.5	26	6	M20	20.5	34	8
M16 (#DIN)	17.5	27	7	M22	22.5	34	8

72030 Conical spring washer

Y92E

Material Spring steel DIN17221



d	☒	Art.number	d	☒	Art.number	d	☒	Art.number
M12	50	72030.120.001	M16	50	72030.160.001	M20	25	72030.200.001
M14	50	72030.140.001	M18	25	72030.180.001	M22	25	72030.220.001

- Usable for wheelbolts

Wave spring washer

DIN 137 B
NEN 2457
NF E27-620

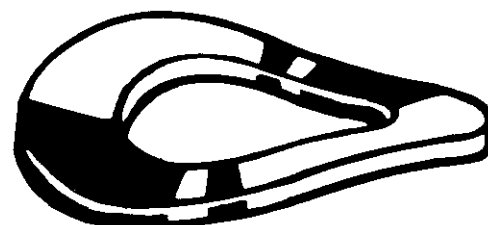
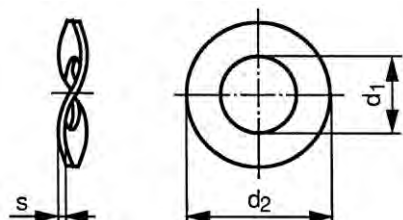



Technical Data

For nom.size	d ₁	d ₂	s	For nom.size	d ₁	d ₂	s
M3	3.2	8	0.5	M12	13	24	1.2
M3.5	3.7	8	0.5	M14	15	28	1.6
M4	4.3	9	0.5	M16	17	30	1.6
M5	5.3	11	0.5	M18	19	34	1.6
M6	6.4	12	0.5	M20	21	36	1.6
M7	7.4	14	0.8	M22	23	40	1.8
M8	8.4	15	0.8	M24	25	44	1.8
M10	10.5	21	1	M27	28	50	2

Article groups

Material	Surface treatment	Code	Page
Spring steel DIN267-26		37160	7-62
Spring steel DIN267-26	Zipl yell.p.	37150	7-62
St.St. A2		51551	7-62
St.St. A4		55551	7-62

37160	Wave spring washer	L07D
Material	Spring steel DIN267-26	
		

For nom. size	☒	Art.number	For nom. size	☒	Art.number	For nom. size	☒	Art.number
M3	1000	37160.030.001	M8	1000	37160.080.001	M16	100	37160.160.001
M4	1000	37160.040.001	M10	500	37160.100.001	M20	100	37160.200.001
M5	1000	37160.050.001	M12	500	37160.120.001	M22	100	37160.220.001
M6	1000	37160.060.001	M14	100	37160.140.001	M24	100	37160.240.001
M7	1000	37160.070.001						



- Spring washers acc. to DIN 137 should be used in combination with fasteners of property class < 5.8, use under dynamic load is not allowed.
- They are intended to counteract the effect of "play or setting" which results in bolt/nut assemblies working loose (see DIN 267-26).
- They do not effectively prevent loosening of the assembly under varying radial load and are designed for use with short bolts predominantly subject to thrust.
- For locking under dynamic load is referred to locking edge washers and NORD-LOCK vibration proof washers.
- **Warning:** electro-galvanizing of these products may cause hydrogen embrittlement.

37150	Wave spring washer	L07D
Material	Spring steel DIN267-26	
Surface treatment	Zinc plated yellow passivated	

For nom. size	☒	Art.number	For nom. size	☒	Art.number	For nom. size	☒	Art.number
M3	1000	37150.030.001	M7	1000	37150.070.001	M12	500	37150.120.001
M4	1000	37150.040.001	M8	1000	37150.080.001	M14	100	37150.140.001
M5	1000	37150.050.001	M10	500	37150.100.001	M16	100	37150.160.001
M6	1000	37150.060.001						



- Spring washers acc. to DIN 137 should be used in combination with fasteners of property class < 5.8, use under dynamic load is not allowed.
- They are intended to counteract the effect of "play or setting" which results in bolt/nut assemblies working loose (see DIN 267-26).
- They do not effectively prevent loosening of the assembly under varying radial load and are designed for use with short bolts predominantly subject to thrust.
- For locking under dynamic load is referred to locking edge washers and NORD-LOCK vibration proof washers.
- **Warning:** electro-galvanizing of these products may cause hydrogen embrittlement.

7

51551	Wave spring washer	R09A
Material	Stainless steel A2	
		
		DIN ≈137 B NEN ≈2457 NF ≈E27-620

For nom. size	☒	Art.number	For nom. size	☒	Art.number	For nom. size	☒	Art.number
M3	200	51551.030.001	M8	200	51551.080.001	M20	50	51551.200.001
M3,5*	1000	51551.035.001	M10	100	51551.100.001	M22*	100	51551.220.001
M4	200	51551.040.001	M12	100	51551.120.001	M24	50	51551.240.001
M5	200	51551.050.001	M14*	200	51551.140.001	M27*	100	51551.270.001
M6	200	51551.060.001	M16	100	51551.160.001			
M7*	500	51551.070.001	M18*	200	51551.180.001			

- Use under dynamic load is not allowed.
- For locking under dynamic load is referred to NORD-LOCK vibration proof washers.
- The austenetic steel type is at the manufacturer's discretion, and can vary from the steel types stated in DIN 267-11.

55551	Wave spring washer	R49A
Material	Stainless steel A4	
		
		DIN ≈137 B NEN ≈2457 NF ≈E27-620

For nom. size	☒	Art.number	For nom. size	☒	Art.number	For nom. size	☒	Art.number
M3*	1000	55551.030.001	M5*	1000	55551.050.001	M8*	500	55551.080.001
M4*	1000	55551.040.001	M6*	500	55551.060.001			

Curved spring washer

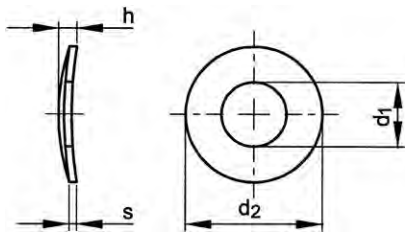

DIN 137 A
NEN 2456

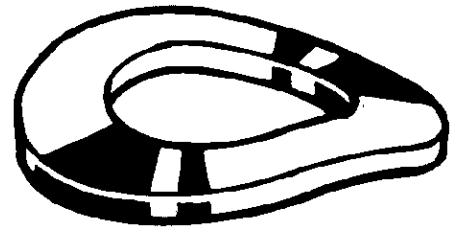

Technical Data

For nom. size	d ₁	d ₂	h (max.)	s
M2	2.2	4.5	1	0.3
M2.3	2.5	5	1	0.3
M2.5 (#DIN)	2.6	5	1	0.3
M2.6	2.8	5.5	1.1	0.3
M3	3.2	6	1.3	0.4
M3.5	3.7	7	1.4	0.4
M4	4.3	8	1.6	0.5
M5	5.3	10	1.8	0.5
M6	6.4	11	2.2	0.5
M7	7.4	12	2.4	0.5
M8	8.4	15	3.4	0.5
M10	10.5	18	4	0.8

- Spring washers acc. to DIN 137 should be used in combination with fasteners of property class < 5.8, use under dynamic load is not allowed.
- They are intended to counteract the effect of "play or setting" which results in bolt/nut assemblies working loose (see DIN 267-26).
- They do not effectively prevent loosening of the assembly under varying radial load and are designed for use with short bolts predominantly subject to thrust.
- For locking under dynamic load is referred to locking edge washers and NORD-LOCK vibration proof washers.

Article groups

Material	Surface treatment	Code	Page
Spring steel DIN267-26		37120	7-63
Spring steel DIN267-26	Zipl yell.p.	37110	7-63
St.St. A1		51550	7-64

37120 Curved spring washer L07D

Material Spring steel DIN267-26



For nom. size	☒	Art.number	For nom. size	☒	Art.number	For nom. size	☒	Art.number
M2	500	37120.020.001	M3,5	500	37120.035.001	M7	500	37120.070.001
M2,3	500	37120.023.001	M4	500	37120.040.001	M8	500	37120.080.001
M2,6	500	37120.026.001	M5	500	37120.050.001	M10	200	37120.100.001
M3	500	37120.030.001	M6	500	37120.060.001			

- Warning: electro-galvanizing of these products may cause hydrogen embrittlement.

37110 Curved spring washer L07D

Material Spring steel DIN267-26
Surface treatment Zinc plated yellow passivated



For nom. size	☒	Art.number	For nom. size	☒	Art.number	For nom. size	☒	Art.number
M2	500	37110.020.001	M4	500	37110.040.001	M7	500	37110.070.001
M2,5	500	37110.025.001	M5	500	37110.050.001	M8	500	37110.080.001
M3	500	37110.030.001	M6	500	37110.060.001	M10	200	37110.100.001

- Warning: electro-galvanizing of these products may cause hydrogen embrittlement.

51550 Curved spring washer R05A

Material Stainless steel A1



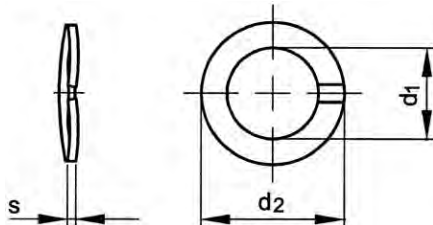

For nom. size	☒	Art.number	For nom. size	☒	Art.number	For nom. size	☒	Art.number
M2*	1000	51550.020.001	M3,5*	1000	51550.035.001	M7*	500	51550.070.001
M2,3*	1000	51550.023.001	M4*	1000	51550.040.001	M8*	500	51550.080.001
M2,5*	1000	51550.025.001	M5*	1000	51550.050.001	M10*	500	51550.100.001
M3*	1000	51550.030.001	M6*	500	51550.060.001			

Curved spring lock washer

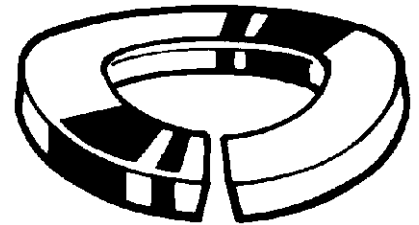

DIN 128 A
NEN 1570



Technical Data

For nom.size	d ₁ (min.)	d ₂ (max.)	s	For nom.size	d ₁ (min.)	d ₂ (max.)	s
M2	2.1	4.4	0.5	M14	14.2	24.1	2.4
M2.3 (#DIN)	2.4	4.9	0.6	M16	16.2	27.4	2.8
M2.5	2.6	5.1	0.6	M18	18.2	29.4	2.8
M2.6 (#DIN)	2.7	5.2	0.6	M20	20.2	33.6	3.2
M3	3.1	6.2	0.7	M22	22.5	35.9	3.2
M3.5	3.6	6.7	0.7	M24	24.5	40	4
M4	4.1	7.6	0.8	M27	27.5	43	4
M5	5.1	9.2	1	M30	30.5	48.2	6
M6	6.1	11.8	1.3	M33 (#DIN)	34	54.2	6
M7	7.1	12.7	1.3	M36	36.5	58.2	6
M8	8.1	14.8	1.6	M39 (#DIN)	39.5	59.2	6
M10	10.2	18.1	1.8	M42 (#DIN)	42.5	68.2	7
M11 (#DIN)	11.3	19.3	2.1	M45 (#DIN)	46.7	70.5	7
M12	12.2	21.1	2.1	M48 (#DIN)	49	75	7

Article groups

Material	Surface treatment	Code	Page
Spring steel DIN267-26	Mech.zipl.	37080	7-64
Spring steel DIN267-26	Zipl yell.p.	37092	7-65
St.St. A2		51520	7-65
St.St. A4		55520	7-65
Phosphor bronze Cu4		50500	7-66

37080 Curved spring lock washer L07D

Material Spring steel DIN267-26
Surface treatment Mechanical zinc plated



For nom. size	☒	Art.number	For nom. size	☒	Art.number	For nom. size	☒	Art.number
M2	500	37080.020.001	M8	200	37080.080.001	M24	50	37080.240.001
M2,5	500	37080.025.001	M10	200	37080.100.001	M27	25	37080.270.001
M2,6	500	37080.026.001	M11	150	37080.110.001	M30	25	37080.300.001
M3	250	37080.030.001	M12	150	37080.120.001	M33	25	37080.330.001
M3,5	250	37080.035.001	M14	100	37080.140.001	M36	25	37080.360.001
M4	250	37080.040.001	M16	100	37080.160.001	M39	10	37080.390.001
M5	250	37080.050.001	M18	100	37080.180.001	M42	10	37080.420.001
M6	250	37080.060.001	M20	100	37080.200.001	M45	10	37080.450.001
M7	250	37080.070.001	M22	50	37080.220.001	M48	10	37080.480.001

37080 Curved spring lock washer ←

- Curved spring lock washers acc. to DIN 128 A are improved compared to spring lock washers acc. to DIN 127 A and due to the curved form have moreover the advantages: do not damage surfaces of the construction, nut or bolt; also to use with left hand thread; do not disform during tightening and dis-assembly, thus re-useable; do not tangle, so suitable for automatic feeding and should be used in combination with fasteners of property class < 8.8, use under dynamic load is not allowed.
- For locking under dynamic load is referred to locking edge washers and NORD-LOCK vibration proof washers, see elsewhere in this section.

37092 Curved spring lock washer L07D

Material Spring steel DIN267-26
Surface treatment Zinc plated yellow passivated



For nom. size	☒	Art.number	For nom. size	☒	Art.number	For nom. size	☒	Art.number
M4	250	37092.040.001	M8	200	37092.080.001	M12	150	37092.120.001
M5	250	37092.050.001	M10	200	37092.100.001	M14	100	37092.140.001
M6	250	37092.060.001						

- Curved spring lock washers acc. to DIN 128 A are improved compared to spring lock washers acc. to DIN 127 A and due to the curved form have moreover the advantages: do not damage surfaces of the construction, nut or bolt; also to use with left hand thread; do not disform during tightening and dis-assembly, thus re-useable; do not tangle, so suitable for automatic feeding and should be used in combination with fasteners of property class < 8.8, use under dynamic load is not allowed.
- For locking under dynamic load is referred to locking edge washers and NORD-LOCK vibration proof washers, see elsewhere in this section.

51520 Curved spring lock washer R09A

Material Stainless steel A2 **DIN** ≈128 A
NEN ≈1570



For nom. size	☒	Art.number	For nom. size	☒	Art.number	For nom. size	☒	Art.number
M2	100	51520.020.001	M6	250	51520.060.001	M18	100	51520.180.001
M2,5	100	51520.025.001	M8	200	51520.080.001	M20	100	51520.200.001
M2,6	100	51520.026.001	M10	200	51520.100.001	M22	50	51520.220.001
M3	250	51520.030.001	M12	150	51520.120.001	M24	50	51520.240.001
M3,5	250	51520.035.001	M14	100	51520.140.001	M30	25	51520.300.001
M4	250	51520.040.001	M16	100	51520.160.001	M36	25	51520.360.001
M5	250	51520.050.001						

- The measurements deviate slightly from DIN 128 A, these spring lock washers have a deviating "reinforced" thickness resulting in considerably improved spring characteristics.
- Curved spring lock washers acc. to DIN 128 A are improved compared to spring lock washers acc. to DIN 127 A and due to the curved form have moreover the advantages: do not damage surfaces of the construction, nut or bolt; also to use with left hand thread; do not disform during tightening and dis-assembly, thus re-useable; do not tangle, so suitable for automatic feeding. Use under dynamic load is not allowed.
- For locking under dynamic load is referred to NORD-LOCK vibration proof washers.
- The austenetic steel type is at the manufacturer's discretion, and can vary from the steel types stated in DIN 267-11.

55520 Curved spring lock washer R49A

Material Stainless steel A4 **DIN** ≈128 A
NEN ≈1570



For nom. size	☒	Art.number	For nom. size	☒	Art.number	For nom. size	☒	Art.number
M2*	1000	55520.020.001	M6	250	55520.060.001	M14*	250	55520.140.001
M2,5*	1000	55520.025.001	M8	200	55520.080.001	M16	100	55520.160.001
M3	250	55520.030.001	M10	200	55520.100.001	M20	100	55520.200.001
M4	250	55520.040.001	M12	150	55520.120.001	M24*	100	55520.240.001
M5	250	55520.050.001						

- The measurements deviate slightly from DIN 128 A, these spring lock washers have a deviating "reinforced" thickness resulting in considerably improved spring characteristics.
- Curved spring lock washers acc. to DIN 128 A are improved compared to spring lock washers acc. to DIN 127 A and due to the curved form have moreover the advantages: do not damage surfaces of the construction, nut or bolt; also to use with left hand thread; do not disform during tightening and dis-assembly, thus re-useable; do not tangle, so suitable for automatic feeding.
- Use under dynamic load is not allowed. For locking under dynamic load is referred to NORD-LOCK vibration proof washers.
- The austenetic steel type is at the manufacturer's discretion, and can vary from the steel types stated in DIN 267-11.

50500	Curved spring lock washer					M11F
Material	Phosphor bronze Cu4	DIN	≈128 A			
		NEN	≈1570			

For nom. size	☒	Art.number	For nom. size	☒	Art.number	For nom. size	☒	Art.number
M2,6	500	50500.026.001	M6	250	50500.060.001	M16	100	50500.160.001
M3	250	50500.030.001	M8	200	50500.080.001	M18	100	50500.180.001
M4	250	50500.040.001	M10	200	50500.100.001	M20	100	50500.200.001
M5	250	50500.050.001	M12	150	50500.120.001			

• The measurements deviate slightly from DIN 128 A, these spring lock washers have a deviating "reinforced" thickness resulting in considerably improved spring characteristics.

Locking edge washer

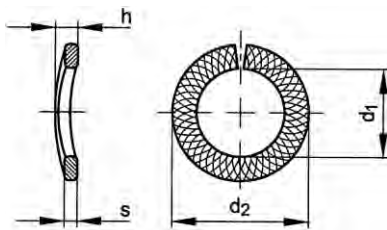

DIN ≈128 A
NEN ≈1570

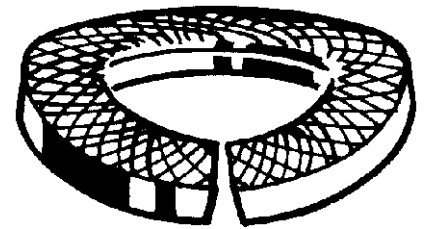

Technical Data

For nom.size	d ₁	d ₂ (max.)	s	For nom.size	d ₁	d ₂ (max.)	s
M4	4.1	7.6	0.8	M16	16.2	27.4	2.8
M5	5.1	9.2	1	M18	18.2	29.4	2.8
M6	6.1	11.8	1.3	M20	20.2	33.6	3.2
M8	8.1	14.9	1.6	M22	22.5	35.9	3.2
M10	10.2	18.1	1.8	M24	24.5	40	4
M12	12.2	21.1	2.1	M27	27.5	43	4
M14	14.2	24.1	2.4	M30	30.5	48.2	6

7

Special features of FABORY locking edge washers:

- applicable with hexagon head bolts, hexagon nuts, etc. of property class ≤ 8.8
- the profile surface (patented) ensures good locking against loosening properties and reduces loss of assembly pre-load
- compensation against play or setting of the joint by a long spring deflection
- little damage, so also usable with softer materials and surface coatings
- re-usable
- suited for automatic installation
- insensitive for temperature from -10°C up to +300°C
- sizes and other properties according to DIN 128 A
- simple application together with current standard fasteners
- also applicable for hexagon head bolts, hexagon nuts etc. with left-hand thread

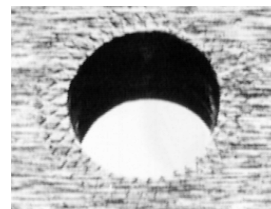
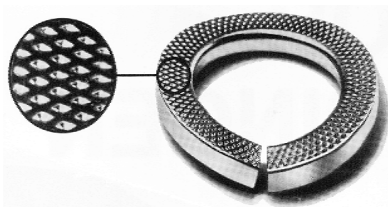

37070	Locking edge washer profiled					L07D
Material	Spring steel DIN267-26					
Surface treatment	Mechanical zinc plated yellow passivated					

For nom. size	☒	Art.number	For nom. size	☒	Art.number	For nom. size	☒	Art.number
M4	250	37070.040.001	M8	200	37070.080.001	M14	100	37070.140.001
M5	250	37070.050.001	M10	200	37070.100.001	M16	100	37070.160.001
M6	250	37070.060.001	M12	150	37070.120.001	M18	100	37070.180.001

37070 Locking edge washer profiled								
For nom. size	☒	Art.number	For nom. size	☒	Art.number	For nom. size	☒	Art.number
M20	100	37070.200.001	M24	50	37070.240.001	M30	25	37070.300.001
M22	50	37070.220.001	M27	25	37070.270.001			

Heavy domed internal serrated lock washer type JZC

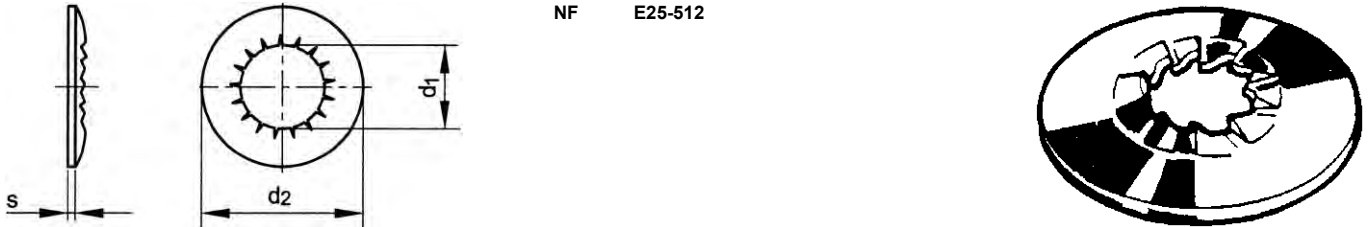



Technical Data

For nom.size	d ₁	d ₂	s	For nom.size	d ₁	d ₂	s
M3	3.2	8.7	0.5	M6	6.1	18.3	1
M4	4.3	11.2	0.6	M10	10.2	26.3	1.4
M5	5.1	16.2	1	M12	12.2	32.4	1.4

- The main purpose of toothed lock washers is to permit the flow of electric current between components coated by varnish, anti-corrosive agents or similar materials, the bend ends of the washers piercing the coating when such components are joined. Where such washers are intended to keep fasteners of a low property class from working loose, their effectiveness shall be checked for the application concerned.
- Internal teeth and extra large outside diameter d₂, extra resilience because of its domed form.

37560 Heavy domed internal serrated lock washer type JZC L07D

Material Spring steel

For nom. size	☒	Art.number	For nom. size	☒	Art.number	For nom. size	☒	Art.number
M3	1000	37560.030.001	M5	1000	37560.050.001	M10	100	37560.100.001
M4	1000	37560.040.001	M6	1000	37560.060.001	M12	100	37560.120.001

- Warning: electro-galvanizing of these products may cause hydrogen embrittlement.

Countersunk serrated lock washer external teeth

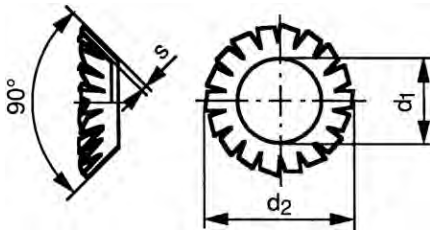

DIN 6798 V
NF E27-627

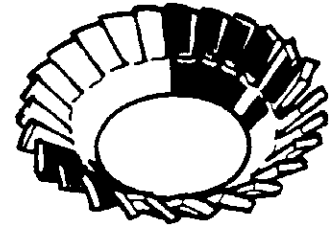

Technical Data

For nom.size	d ₁	d ₂ ≈	s	For nom.size	d ₁	d ₂ ≈	s
M3	3.2	6	0.2	M10	10.5	19	0.5
M4	4.3	8	0.25	M12	13	23	0.5
M5	5.3	9.8	0.3	M14	15	26.2	0.6
M6	6.4	11.8	0.4	M16	17	30.2	0.6
M8	8.4	15.3	0.4				

- The main purpose of toothed lock washers is to permit the flow of electric current between components coated by varnish, anti-corrosive agents or similar materials, the bend ends of the washers piercing the coating when such components are joined. Where such washers are intended to keep fasteners of a low property class from working loose, their effectiveness shall be checked for the application concerned.
- Suitable for bolts and nuts with normal widths across flats.

Article groups

Material	Surface treatment	Code	Page
Spring steel 350-425 HV10		37500	7-68
Spring steel 350-425 HV10	Zipl	37520	7-68
St.St. A2		51463	7-68

37500 Countersunk serrated lock washer external teeth L07D

Material Spring steel 350-425 HV10



For nom. size	☒	Art.number	For nom. size	☒	Art.number	For nom. size	☒	Art.number
M3	1000	37500.030.001	M6	1000	37500.060.001	M12	500	37500.120.001
M4	1000	37500.040.001	M8	1000	37500.080.001	M14	100	37500.140.001
M5	1000	37500.050.001	M10	1000	37500.100.001	M16	100	37500.160.001

- Warning: electro-galvanizing of these products may cause hydrogen embrittlement.

37520 Countersunk serrated lock washer external teeth L07D

Material Spring steel 350-425 HV10
Surface treatment Zinc plated





For nom. size	☒	Art.number	For nom. size	☒	Art.number	For nom. size	☒	Art.number
M4	1000	37520.040.001	M6	1000	37520.060.001	M10	1000	37520.100.001
M5	1000	37520.050.001	M8	1000	37520.080.001	M12	500	37520.120.001

- Warning: electro-galvanizing of these products may cause hydrogen embrittlement.

51463 Countersunk serrated lock washer external teeth R09A

Material Stainless steel A2

For nom. size	☒	Art.number	For nom. size	☒	Art.number	For nom. size	☒	Art.number
M3*	1000	51463.030.001	M6*	1000	51463.060.001	M12*	500	51463.120.001
M4*	1000	51463.040.001	M8*	500	51463.080.001	M16*	200	51463.160.001
M5*	1000	51463.050.001	M10*	500	51463.100.001			

Serrated lock washer external countersunk

ASME B18.21.1

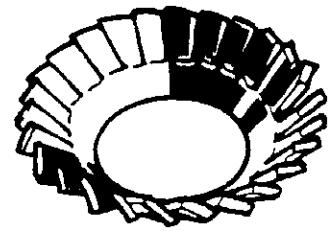
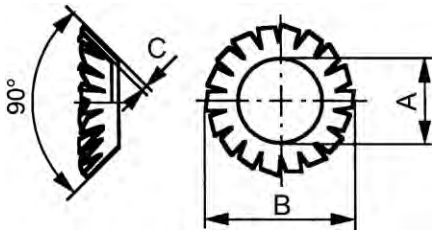

Technical Data

For nom.size	A	B	C
No.6	0.140	0.289	0.017
No.8	0.167	0.322	0.017
No.10	0.195	0.354	0.020
No.12	0.220	0.421	0.020
1/4	0.255	0.454	0.020
5/16	0.318	0.599	0.023
3/8	0.383	0.765	0.028

U37500 Serrated lock washer external countersunk

X09A

Material Spring steel
Surface treatment Zinc plated



For nom. size	☒	Art.number	For nom. size	☒	Art.number	For nom. size	☒	Art.number
NO.6*	100	U37500.013.0001	NO.12*	100	U37500.021.0001	5/16*	100	U37500.031.0001
NO.8*	100	U37500.016.0001	1/4*	100	U37500.025.0001	3/8*	50	U37500.037.0001
NO.10*	100	U37500.019.0001						

Serrated lock washer internal/external

ASME B18.21.1

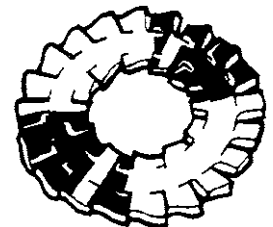
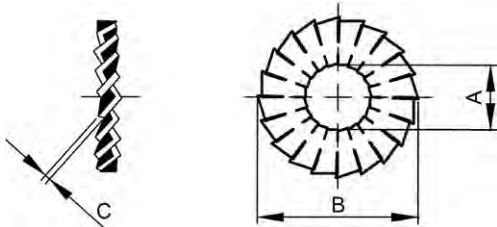

Technical Data

For nom.size	A	B	C
No.4	0.115	0.510	0.017
No.6	0.141	0.610	0.023
No.8	0.168	0.690	0.028
No.10	0.195	0.740	0.032
1/4	0.256	0.965	0.037
5/16	0.320	1.045	0.042
3/8	0.384	1.130	0.042
1/2	0.512	1.3801	0.052

U37590 Serrated lock washer internal/external

X09A

Material Spring steel
Surface treatment Zinc plated



For nom. size	☒	Art.number	For nom. size	☒	Art.number	For nom. size	☒	Art.number
NO.4*	100	U37590.011.0001	NO.10*	100	U37590.019.0001	3/8*	50	U37590.037.0001
NO.6*	100	U37590.013.0001	1/4*	100	U37590.025.0001	1/2*	25	U37590.050.0001
NO.8*	100	U37590.016.0001	5/16*	100	U37590.031.0001			

Serrated lock washer external

ASME B18.21.1

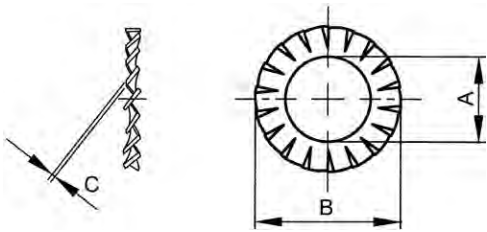

Technical Data

For nom.size	A	B	C
No.3	0.102	0.220	0.01
No.4	0.115	0.245	0.012
No.5	0.129	0.270	0.014
No.6	0.141	0.305	0.016
No.8	0.168	0.365	0.018
No.10	0.195	0.395	0.018
No.12	0.221	0.460	0.020
1/4	0.256	0.494	0.023
5/16	0.320	0.588	0.028
3/8	0.384	0.670	0.032
7/16	0.448	0.740	0.032
1/2	0.513	0.880	0.037
9/16	0.576	0.960	0.037
5/8	0.641	1.045	0.042
3/4	0.768	1.22	0.047
7/8	0.897	1.380	0.052
1 Inch	1.025	1.59	0.059



Article groups

Material	Code	Page
St	U37420	7-70
St.St. A2 (AISI304/18-8)	U51460	7-70
St.St. A4 (AISI316/18-10)	U55460	7-71
St.St. AISI410	U53460	7-71
Br PH	U50450	7-71

7

U37420 Serrated lock washer external X09A

Material: Steel



For nom. size	Art.number	For nom. size	Art.number	For nom. size	Art.number
NO.4*	100 U37420.011.0001	1/4*	100 U37420.025.0001	9/16*	25 U37420.056.0001
NO.6*	100 U37420.013.0001	5/16*	100 U37420.031.0001	5/8*	10 U37420.062.0001
NO.8*	100 U37420.016.0001	3/8*	50 U37420.037.0001	3/4*	10 U37420.075.0001
NO.10*	100 U37420.019.0001	7/16*	25 U37420.043.0001	7/8*	5 U37420.087.0001
NO.12*	100 U37420.021.0001	1/2*	25 U37420.050.0001	1 Inch*	5 U37420.100.0001



U51460 Serrated lock washer external X15A



Material: Stainless steel A2 (AISI 304/18-8)

For nom. size	Art.number	For nom. size	Art.number	For nom. size	Art.number
NO.4*	50 U51460.011.0001	NO.10*	50 U51460.019.0001	3/8*	50 U51460.037.0001
NO.6*	50 U51460.013.0001	1/4*	50 U51460.025.0001	1/2*	10 U51460.050.0001
NO.8*	50 U51460.016.0001	5/16*	50 U51460.031.0001		

U55460 Serrated lock washer external		X15A						
Material: Stainless steel A4 (AISI 316/18-10)								
								
								
For nom. size	☒	Art.number	For nom. size	☒	Art.number	For nom. size	☒	Art.number
NO.3*	50	U55460.009.0001	NO.5*	50	U55460.012.0001	NO.8*	50	U55460.016.0001
NO.4*	50	U55460.011.0001	NO.6*	50	U55460.013.0001	NO.10*	50	U55460.019.0001

U53460 Serrated lock washer external		X15A						
Material: Stainless steel AISI410								
								
								
For nom. size	☒	Art.number	For nom. size	☒	Art.number	For nom. size	☒	Art.number
NO.4*	50	U53460.011.0001	1/4*	50	U53460.025.0001	1/2*	10	U53460.050.0001
NO.6*	50	U53460.013.0001	5/16*	50	U53460.031.0001	5/8*	10	U53460.062.0001
NO.8*	50	U53460.016.0001	3/8*	50	U53460.037.0001	3/4*	5	U53460.075.0001
NO.10*	50	U53460.019.0001	7/16*	25	U53460.043.0001			

U50450 Serrated lock washer external		X09A						
Material: Bronze PH								
								
								
For nom. size	☒	Art.number	For nom. size	☒	Art.number	For nom. size	☒	Art.number
NO.4	100	U50450.011.0001	NO.10*	100	U50450.019.0001	3/8*	50	U50450.037.0001
NO.6*	100	U50450.013.0001	1/4*	100	U50450.025.0001	1/2*	25	U50450.050.0001
NO.8*	100	U50450.016.0001	5/16*	100	U50450.031.0001			

Double serrated lock washer type DD

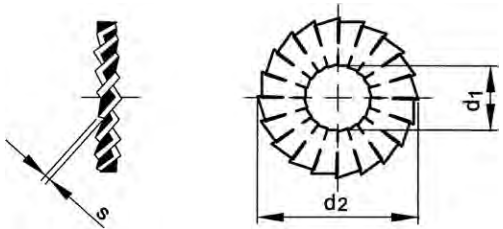

NF ≈E27-626

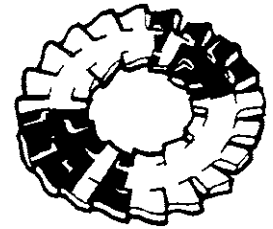

Technical Data

For nom.size	d ₁	d ₂	s	For nom.size	d ₁	d ₂	s
M4	4.2	15.6	0.8	M10	10.3	26.1	1.1
M5	5.2	17.9	0.8	M12	12.3	30.3	1.2
M6	6.2	18.2	0.8	M16	16.5	36.1	1.4
M8	8.2	22.3	1				

- The main purpose of toothed lock washers is to permit the flow of electric current between components coated by varnish, anti-corrosive agents or similar materials, the bend ends of the washers piercing the coating when such components are joined. Where such washers are intended to keep fasteners of a low property class from working loose, their effectiveness shall be checked for the application concerned.
- Double serrated teeth and extra large outside diameter d₂. Recommended for oversized and elongated holes, where a larger contact surface is required and between parts to prevent them from moving.

Article groups

Material	Surface treatment	Code	Page
Spring steel		37580	7-72
Spring steel	Zipl	37590	7-72

37580 Double serrated lock washer type DD L07D

Material Spring steel

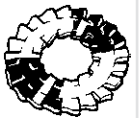



For nom. size	☒	Art.number	For nom. size	☒	Art.number	For nom. size	☒	Art.number
M4	1000	37580.040.001	M8	500	37580.080.001	M12	100	37580.120.001
M5	1000	37580.050.001	M10	500	37580.100.001	M16	100	37580.160.001
M6	500	37580.060.001						

- Warning: electro-galvanizing of these products may cause hydrogen embrittlement.

37590 Double serrated lock washer type DD L07D

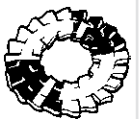
Material Spring steel
Surface treatment Zinc plated



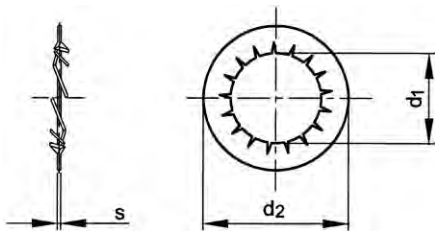

For nom. size	☒	Art.number	For nom. size	☒	Art.number	For nom. size	☒	Art.number
M4	1000	37590.040.001	M8	500	37590.080.001	M12	100	37590.120.001
M5	1000	37590.050.001	M10	500	37590.100.001	M16	100	37590.160.001
M6	500	37590.060.001						

Serrated lock washer internal teeth

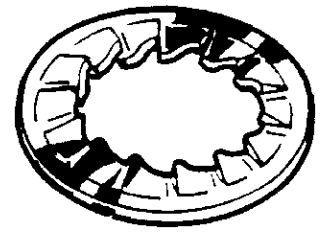

DIN 6798 J
NEN 2454
NF E27-625



Technical Data

For nom.size	d ₁	d ₂	s	For nom.size	d ₁	d ₂	s
M2	2.2	4.5	0.3	M8	8.4	15	0.8
M2.3 (#DIN)	2.5	5	0.4	M10	10.5	18	0.9
M2.5	2.7	5.5	0.4	M12	13	20.5	1
M3	3.2	6	0.4	M14	15	24	1
M3.5	3.7	7	0.5	M16	17	26	1.2
M4	4.3	8	0.5	M18	19	30	1.4
M5 (#DIN)	5.1	9	0.5	M20	21	33	1.4
M5	5.3	10	0.6	M22	23	36	1.5
M6	6.4	11	0.7	M24	25	38	1.5
M7	7.4	12.5	0.8	M27	28	44	1.6
M8 (#DIN)	8.2	14	0.8	M30	31	48	1.6

- The main purpose of toothed lock washers is to permit the flow of electric current between components coated by varnish, anti-corrosive agents or similar materials, the bend ends of the washers piercing the coating when such components are joined. Where such washers are intended to keep fasteners of a low property class from working loose, their effectiveness shall be checked for the application concerned.
- Suitable for bolts and nuts with normal widths across flats.

Article groups

Material	Surface treatment	Code	Page
Spring steel 350-425 HV10		37460	7-73
Spring steel 350-425 HV10	Zipl	37480	7-73
St.St. A2		51462	7-74
St.St. A4		55462	7-74

37460 Serrated lock washer internal teeth

L07D

Material Spring steel 350-425 HV10



For nom. size	☒	Art.number	For nom. size	☒	Art.number	For nom. size	☒	Art.number
M2	1000	37460.020.001	M7	1000	37460.070.001	M18	100	37460.180.001
M3	1000	37460.030.001	M8 (#DIN)	1000	37460.080.001	M20	100	37460.200.001
M3.5	1000	37460.035.001	M8	1000	37460.080.002	M22	100	37460.220.001
M4	1000	37460.040.001	M10	1000	37460.100.001	M24	100	37460.240.001
M5 (#DIN)	1000	37460.050.001	M12	1000	37460.120.001	M27	100	37460.270.001
M5	1000	37460.050.002	M14	500	37460.140.001	M30	100	37460.300.001
M6	1000	37460.060.001	M16	500	37460.160.001			

37480 Serrated lock washer internal teeth

L07D

Material Spring steel 350-425 HV10
Surface treatment Zinc plated

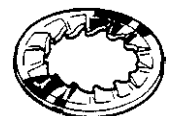

For nom. size	☒	Art.number	For nom. size	☒	Art.number	For nom. size	☒	Art.number
M2	1000	37480.020.001	M6	1000	37480.060.001	M14	500	37480.140.001
M2.5	1000	37480.025.001	M7	1000	37480.070.001	M16	500	37480.160.001
M3	1000	37480.030.001	M8 (#DIN)	1000	37480.080.001	M18	100	37480.180.001
M3.5	1000	37480.035.001	M8	1000	37480.080.002	M20	100	37480.200.001
M4	1000	37480.040.001	M10	1000	37480.100.001	M22	100	37480.220.001
M5 (#DIN)	1000	37480.050.001	M12	1000	37480.120.001	M24	100	37480.240.001
M5	1000	37480.050.002						

51462 Serrated lock washer internal teeth R09A

Material Stainless steel A2 **DIN** ≈6798 J
NEN ≈2454
NF ≈E27-625

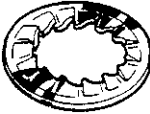

For nom. size	☒	Art.number	For nom. size	☒	Art.number	For nom. size	☒	Art.number
M2,5	200	51462.025.001	M8	200	51462.080.001	M18	100	51462.180.001
M3	200	51462.030.001	M8 (#DIN)*	1000	51462.082.001	M20	100	51462.200.001
M4	200	51462.040.001	M10	100	51462.100.001	M22*	200	51462.220.001
M5	200	51462.050.001	M12	100	51462.120.001	M24	50	51462.240.001
M5 (#DIN)*	1000	51462.051.001	M14	100	51462.140.001	M27	50	51462.270.001
M6	200	51462.060.001	M16	100	51462.160.001	M30*	100	51462.300.001
M7*	1000	51462.070.001						

• The austenitic steel type is at the manufacturer's discretion, and can vary from the steel types stated in DIN 267-11.

55462 Serrated lock washer internal teeth R49A

Material Stainless steel A4 **DIN** ≈6798 J
NEN ≈2454
NF ≈E27-625

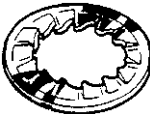

For nom. size	☒	Art.number	For nom. size	☒	Art.number	For nom. size	☒	Art.number
M2,3*	1000	55462.023.001	M8	200	55462.080.001	M18	100	55462.180.001
M3	200	55462.030.001	M8*	1000	55462.080.002	M20	100	55462.200.001
M4	200	55462.040.001	M8 (#DIN)*	1000	55462.082.001	M22*	200	55462.220.001
M5	200	55462.050.001	M10	100	55462.100.001	M24	50	55462.240.001
M5*	1000	55462.050.002	M12	100	55462.120.001	M27*	100	55462.270.001
M5 (#DIN)*	1000	55462.051.001	M14	100	55462.140.001	M30*	100	55462.300.001
M6	200	55462.060.001	M16	100	55462.160.001			

• The austenitic steel type is at the manufacturer's discretion, and can vary from the steel types stated in DIN 267-11.

Serrated lock washer internal

ASME B18.21.1

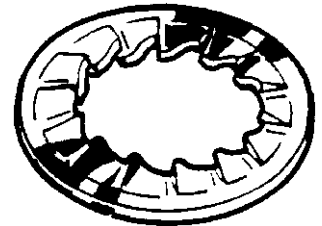
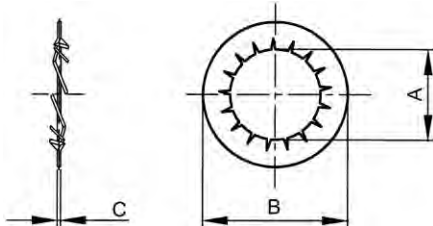

Technical Data

For nom.size	A	B	C
No.2	0.089	0.172	0.010
No.3	0.102	0.215	0.010
No.4	0.115	0.245	0.012
No.6	0.141	0.275	0.016
No.8	0.168	0.325	0.018
No.10	0.195	0.365	0.018
No.12	0.221	0.394	0.020
1/4	0.256	0.460	0.023
5/16	0.320	0.594	0.028
3/8	0.384	0.670	0.032
7/16	0.448	0.740	0.032
1/2	0.512	0.867	0.037
9/16	0.576	0.957	0.037
5/8	0.640	1.045	0.042
3/4	0.769	1.220	0.047
7/8	0.894	1.364	0.052
1 Inch	1.019	1.590	0.059

Article groups

Material	Surface treatment	Code	Page
St	Zipl	U37480	7-75
St.St. A2 (AISI304/18-8)		U51462	7-75

Article groups			
Material	Surface treatment	Code	Page
St.St. A4 (AISI316/18-10)		U55462	7-75
St.St. AISI410		U53462	7-75
Br PH		U50462	7-76

U37480 Serrated lock washer internal X09A

Material Steel
Surface treatment Zinc plated



For nom. size	Art.number	For nom. size	Art.number	For nom. size	Art.number
NO.2* 100	U37480.008.0001	1/4* 100	U37480.025.0001	5/8* 10	U37480.062.0001
NO.4* 100	U37480.011.0001	5/16* 100	U37480.031.0001	3/4* 10	U37480.075.0001
NO.6* 100	U37480.013.0001	3/8* 50	U37480.037.0001	7/8* 5	U37480.087.0001
NO.8* 100	U37480.016.0001	7/16* 25	U37480.043.0001	1 Inch* 5	U37480.100.0001
NO.10* 100	U37480.019.0001	1/2* 25	U37480.050.0001		
NO.12* 100	U37480.021.0001	9/16* 25	U37480.056.0001		

U51462 Serrated lock washer internal X15A

Material Stainless steel A2 (AISI 304/18-8)



For nom. size	Art.number	For nom. size	Art.number	For nom. size	Art.number
NO.4* 50	U51462.011.0001	1/4* 50	U51462.025.0001	9/16* 10	U51462.056.0001
NO.6* 50	U51462.013.0001	5/16* 50	U51462.031.0001	5/8* 10	U51462.062.0001
NO.8* 50	U51462.016.0001	3/8* 50	U51462.037.0001	3/4* 5	U51462.075.0001
NO.10* 50	U51462.019.0001	1/2* 10	U51462.050.0001		

U55462 Serrated lock washer internal X15A

Material Stainless steel A4 (AISI 316/18-10)



For nom. size	Art.number	For nom. size	Art.number	For nom. size	Art.number
NO.4* 50	U55462.011.0001	NO.10* 50	U55462.019.0001	5/16* 50	U55462.031.0001
NO.6* 50	U55462.013.0001	1/4* 50	U55462.025.0001	3/8* 50	U55462.037.0001
NO.8* 50	U55462.016.0001				

U53462 Serrated lock washer internal X15A

Material Stainless steel AISI410



For nom. size	Art.number	For nom. size	Art.number	For nom. size	Art.number
NO.2* 50	U53462.008.0001	NO.10* 50	U53462.019.0001	7/16* 25	U53462.043.0001
NO.3* 50	U53462.009.0001	NO.12* 50	U53462.021.0001	1/2* 10	U53462.050.0001
NO.4* 50	U53462.011.0001	1/4* 50	U53462.025.0001	5/8* 10	U53462.062.0001
NO.6* 50	U53462.013.0001	5/16* 50	U53462.031.0001	3/4* 5	U53462.075.0001
NO.8* 50	U53462.016.0001	3/8* 50	U53462.037.0001		

U50462 Serrated lock washer internal X09A

Material Bronze PH



For nom. size	☒	Art.number	For nom. size	☒	Art.number	For nom. size	☒	Art.number
NO.2*	100	U50462.008.0001	NO.8*	100	U50462.016.0001	5/16*	100	U50462.031.0001
NO.4*	100	U50462.011.0001	NO.10*	100	U50462.019.0001	3/8*	50	U50462.037.0001
NO.6*	100	U50462.013.0001	1/4*	100	U50462.025.0001	1/2*	25	U50462.050.0001

Serrated lock washer internal heavy

ASME B18.21.1

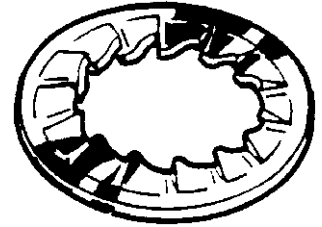
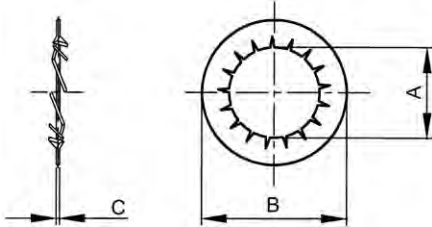

Technical Data

For nom.size	A	B	C
1/4	0.256	0.500	0.035
5/16	0.320	0.590	0.040
3/8	0.384	0.700	0.042
1/2	0.512	0.880	0.055
5/8	0.640	1.100	0.059
3/4	0.768	1.240	0.070

Article groups

Material	Surface treatment	Code	Page
Spring steel HV		U37320	7-76
Spring steel HV	Zipl	U37321	7-76

7

U37320 Serrated lock washer internal heavy X09A

Material Spring steel HV



For nom. size	☒	Art.number	For nom. size	☒	Art.number	For nom. size	☒	Art.number
1/4*	100	U37320.025.0001	3/8*	50	U37320.037.0001	5/8*	10	U37320.062.0001
5/16*	100	U37320.031.0001	1/2*	25	U37320.050.0001	3/4*	10	U37320.075.0001

U37321 Serrated lock washer internal heavy X09A

Material Spring steel HV
Surface treatment Zinc plated



For nom. size	☒	Art.number	For nom. size	☒	Art.number	For nom. size	☒	Art.number
1/4*	100	U37321.025.0001	3/8*	50	U37321.037.0001	5/8*	10	U37321.062.0001
5/16*	100	U37321.031.0001	1/2*	25	U37321.050.0001	3/4*	10	U37321.075.0001

Serrated lock washer external teeth

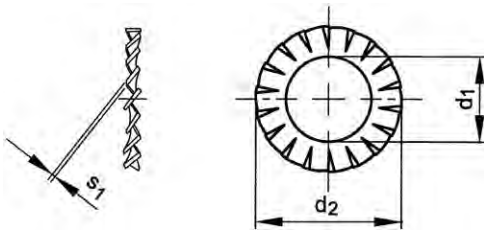

DIN 6798 A
NEN 2453
NF E27-624



Technical Data

For nom.size	d ₁	d ₂	s ₁	For nom.size	d ₁	d ₂	s ₁
M2	2.2	4.5	0.3	M10	10.5	18	0.9
M2.5	2.7	5.5	0.4	M11 (≠DIN)	11.5	19.5	0.9
M2.6 (≠DIN)	2.8	5.5	0.4	M12	13	20.5	1
M3	3.2	6	0.4	M14	15	24	1
M3.5	3.7	7	0.5	M16	17	26	1.2
M4	4.3	8	0.5	M18	19	30	1.4
M5 (≠DIN)	5.1	9	0.5	M20	21	33	1.4
M5	5.3	10	0.6	M22	23	36	1.5
M6	6.4	11	0.7	M24	25	38	1.5
M7	7.4	12.5	0.8	M27	28	44	1.6
M8 (≠DIN)	8.2	14	0.8	M30	31	48	1.6
M8	8.4	15	0.8				

- The main purpose of toothed lock washers is to permit the flow of electric current between components coated by varnish, anti-corrosive agents or similar materials, the bend ends of the washers piercing the coating when such components are joined. Where such washers are intended to keep fasteners of a low property class from working loose, their effectiveness shall be checked for the application concerned.
- Suitable for bolts and nuts with normal widths across flats.

Article groups

Material	Surface treatment	Code	Page
Spring steel 350-425 HV10		37400	7-77
Spring steel 350-425 HV10	Zipl	37420	7-78
Spring steel 350-425 HV10	Zipl	large pack	7-78
Spring steel 350-425 HV10	Zipl yell.p.	37440	7-78
St.St. A2		51460	7-78
St.St. A4		55460	7-78
St.St. A5		53460	7-79
Phosphor bronze Cu4		50540	7-79

7

37400 Serrated lock washer external teeth

L07D

Material Spring steel 350-425 HV10





For nom. size	✉	Art.number	For nom. size	✉	Art.number	For nom. size	✉	Art.number
M2	1000	37400.020.001	M7	1000	37400.070.001	M18	100	37400.180.001
M3	1000	37400.030.001	M8 (≠DIN)	1000	37400.080.001	M20	100	37400.200.001
M3,5	1000	37400.035.001	M8	1000	37400.080.002	M22	100	37400.220.001
M4	1000	37400.040.001	M10	1000	37400.100.001	M24	100	37400.240.001
M5 (≠DIN)	1000	37400.050.001	M12	1000	37400.120.001	M27	100	37400.270.001
M5	1000	37400.050.002	M14	500	37400.140.001	M30	100	37400.300.001
M6	1000	37400.060.001	M16	500	37400.160.001			

- Warning: electro-galvanizing of these products may cause hydrogen embrittlement.

37420 Serrated lock washer external teeth		L07D
Material	Spring steel 350-425 HV10	 
Surface treatment	Zinc plated	



For nom. size	☒	Art.number	For nom. size	☒	Art.number	For nom. size	☒	Art.number
M2	200	37420.020.001	M7	200	37420.070.001	M16	100	37420.160.001
M2,5	200	37420.025.001	M8 (#DIN)	200	37420.080.001	M18	100	37420.180.001
M3	200	37420.030.001	M8	200	37420.080.002	M20	100	37420.200.001
M3,5	200	37420.035.001	M10	100	37420.100.001	M22	100	37420.220.001
M4	200	37420.040.001	M11	100	37420.110.001	M24	100	37420.240.001
M5 (#DIN)	200	37420.050.001	M12	100	37420.120.001	M27	100	37420.270.001
M5	200	37420.050.002	M14	100	37420.140.001	M30	50	37420.300.001
M6	200	37420.060.001						

37430 Serrated lock washer external teeth		L07D
Material	Spring steel 350-425 HV10	 
Surface treatment	Zinc plated	

For nom. size	☒	Art.number	For nom. size	☒	Art.number	For nom. size	☒	Art.number
M2,5	10000	37430.025.001	M5 (#DIN)	10000	37430.050.001	M10	2000	37430.100.001
M3	10000	37430.030.001	M6	5000	37430.060.001	M12	2000	37430.120.001
M4	10000	37430.040.001	M8 (#DIN)	5000	37430.080.001			



37440 Serrated lock washer external teeth		L07D
Material	Spring steel 350-425 HV10	 
Surface treatment	Zinc plated yellow passivated	

For nom. size	☒	Art.number	For nom. size	☒	Art.number	For nom. size	☒	Art.number
M3	200	37440.030.001	M8 (#DIN)	200	37440.080.001	M16	100	37440.160.001
M4	200	37440.040.001	M10	100	37440.100.001	M20	100	37440.200.001
M5 (#DIN)	200	37440.050.001	M12	100	37440.120.001	M24	100	37440.240.001
M6	200	37440.060.001						

51460 Serrated lock washer external teeth		R09A
Material	Stainless steel A2	 
	DIN ≈6798 A NEN ≈2453 NF ≈E27-624	

For nom. size	☒	Art.number	For nom. size	☒	Art.number	For nom. size	☒	Art.number
M2	200	51460.020.001	M6	200	51460.060.001	M16	100	51460.160.001
M2,5	200	51460.025.001	M7	200	51460.070.001	M18	100	51460.180.001
M2,6 (#DIN)	200	51460.026.001	M8	200	51460.080.001	M20	100	51460.200.001
M3	200	51460.030.001	M8 (#DIN)*	1000	51460.082.001	M22	50	51460.220.001
M3,5	200	51460.035.001	M10	100	51460.100.001	M24	50	51460.240.001
M4	200	51460.040.001	M12	100	51460.120.001	M27	50	51460.270.001
M5	200	51460.050.001	M14	100	51460.140.001	M30	25	51460.300.001
M5 (#DIN)*	1000	51460.051.001						



* The austenitic steel type is at the manufacturer's discretion and can vary from the steel types stated in DIN 267-11.

55460 Serrated lock washer external teeth		R49A
Material	Stainless steel A4	 
	DIN ≈6798 A NEN ≈2453 NF ≈E27-624	



For nom. size	☒	Art.number	For nom. size	☒	Art.number	For nom. size	☒	Art.number
M2	200	55460.020.001	M3	200	55460.030.001	M5	200	55460.050.001
M2,5	200	55460.025.001	M3,5	200	55460.035.001	M5 (#DIN)*	1000	55460.050.002
M2,6 (#DIN)	200	55460.026.001	M4	200	55460.040.001	M5,1*	1000	55460.051.001

55460 Serrated lock washer external teeth								
For nom. size	☒	Art.number	For nom. size	☒	Art.number	For nom. size	☒	Art.number
M6		200 55460.060.001	M12		100 55460.120.001	M22		50 55460.220.001
M8		200 55460.080.001	M14		100 55460.140.001	M24		50 55460.240.001
M8 (#DIN)*		1000 55460.080.002	M16		100 55460.160.001	M27		50 55460.270.001
M8,2*		1000 55460.082.001	M18		100 55460.180.001	M30		25 55460.300.001
M10		100 55460.100.001	M20		100 55460.200.001			

- The austenitic steel type is at the manufacturer's discretion and can vary from the steel types stated in DIN 267-11.

53460 Serrated lock washer external teeth				R45A
Material	Stainless steel A5	DIN	≈6798 A	 
		NEN	≈2453	
		NF	≈E27-624	

For nom. size	☒	Art.number	For nom. size	☒	Art.number
M6*		1000 53460.060.001	M8*		1000 53460.080.001

50540 Serrated lock washer external teeth				M11F
Material	Phosphor bronze Cu4	DIN	≈6798 A	 
		NEN	≈2453	
		NF	≈E27-624	

For nom. size	☒	Art.number	For nom. size	☒	Art.number	For nom. size	☒	Art.number
M2		200 50540.020.001	M4		200 50540.040.001	M8		200 50540.080.001
M2,5		200 50540.025.001	M5		200 50540.050.001	M10		100 50540.100.001
M3		200 50540.030.001	M6		200 50540.060.001	M12		100 50540.120.001
M3,5		200 50540.035.001						

- Suitable for bolts and nuts with normal widths across flats.

Toothed lock washer internal teeth

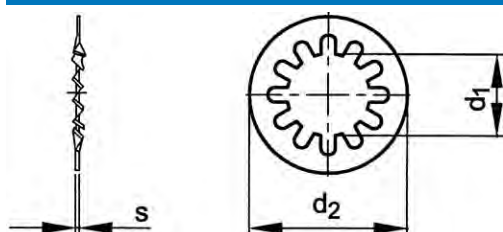

DIN 6797 J
NEN 2451



Technical Data

For nom.size	d ₁	d ₂	s	For nom.size	d ₁	d ₂	s
M2	2.2	4.5	0.3	M10	10.5	18	0.9
M2.3 (#DIN)	2.5	5	0.4	M12	13	20.5	1
M2.5	2.7	5.5	0.4	M14	15	24	1
M2.7	2.7	5.5	0.4	M16	17	26	1.2
M3	3.2	6	0.4	M18	19	30	1.4
M4	4.3	8	0.5	M20	21	33	1.4
M5	5.3	10	0.6	M22	23	36	1.5
M6	6.4	11	0.7	M24	25	38	1.5
M7	7.4	12.5	0.8	M27	28	44	1.6
M8	8.4	15	0.8	M30	31	48	1.6

- The main purpose of toothed lock washers is to permit the flow of electric current between components coated by varnish, anti-corrosive agents or similar materials, the bend ends of the washers piercing the coating when such components are joined. Where such washers are intended to keep fasteners of a low property class from working loose, their effectiveness shall be checked for the application concerned.
- Suitable for bolts and nuts with widths across flats smaller than normal and when due to the appearance the teeth are wanted on the internal side.



Article groups

Material	Code	Page
Spring steel 350-425 HV10	37320	7-80
St.St. A2	51458	7-80

37320	Toothed lock washer internal teeth	L07D
Material	Spring steel 350-425 HV10	
		

For nom. size	☒	Art.number	For nom. size	☒	Art.number	For nom. size	☒	Art.number
M3	500	37320.030.001	M6	250	37320.060.001	M12	200	37320.120.001
M4	500	37320.040.001	M8	200	37320.080.001	M16	100	37320.160.001
M5	250	37320.050.001	M10	200	37320.100.001	M20	100	37320.200.001

- Warning: electro-galvanizing of these products may cause hydrogen embrittlement.

51458	Toothed lock washer internal teeth	R09A
Material	Stainless steel A2	
	DIN ≈6797 J	
	NEN ≈2451	
		

For nom. size	☒	Art.number	For nom. size	☒	Art.number	For nom. size	☒	Art.number
M2*	1000	51458.020.001	M7*	1000	51458.070.001	M18*	200	51458.180.001
M2,3*	1000	51458.023.001	M8	200	51458.080.001	M20	100	51458.200.001
M3	200	51458.030.001	M8,2*	1000	51458.082.001	M22*	200	51458.220.001
M4	200	51458.040.001	M10	200	51458.100.001	M24*	200	51458.240.001
M5	200	51458.050.001	M12	100	51458.120.001	M27*	100	51458.270.001
M5,1*	1000	51458.051.001	M14	100	51458.140.001	M30*	100	51458.300.001
M6	200	51458.060.001	M16	100	51458.160.001			

- The austenitic steel type is at the manufacturer's discretion, and can vary from the steel types stated in DIN 267-11

Toothed lock washer external teeth

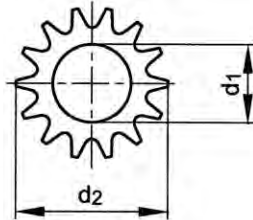
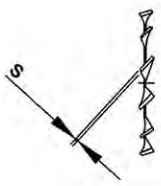

DIN 6797 A
NEN 2450

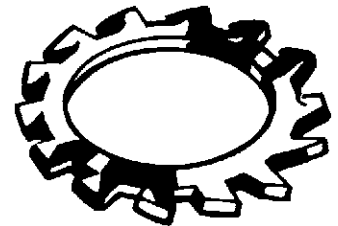

7



Technical Data

For nom.size	d ₁	d ₂	s	For nom.size	d ₁	d ₂	s
M2	2.2	4.5	0.3	M10	10.5	18	0.9
M2.3 (≠DIN)	2.5	5	0.4	M12	13	20.5	1
M2.5	2.7	5.5	0.4	M14	15	24	1
M3	3.2	6	0.4	M16	17	26	1.2
M3.5	3.7	7	0.5	M18	19	30	1.4
M4	4.3	8	0.5	M20	21	33	1.4
M5	5.3	10	0.6	M22	23	36	1.5
M6	6.4	11	0.7	M24	25	38	1.5
M7	7.4	12.5	0.8	M27	28	44	1.6
M8	8.4	15	0.8	M30	31	48	1.6

- The main purpose of toothed lock washers is to permit the flow of electric current between components coated by varnish, anti-corrosive agents or similar materials, the bend ends of the washers piercing the coating when such components are joined. Where such washers are intended to keep fasteners of a low property class from working loose, their effectiveness shall be checked for the application concerned.
- Suitable for bolts and nuts with normal widths across flats.

Article groups

Material	Surface treatment	Code	Page
Spring steel 350-425 HV10		37300	7-81
Spring steel 350-425 HV10	Zipl	37302	7-81
St.St. A2		51456	7-81



37300 Toothed lock washer external teeth		L07D	
Material	Spring steel 350-425 HV10		
			

For nom. size	☒	Art.number	For nom. size	☒	Art.number	For nom. size	☒	Art.number
M3	500	37300.030.001	M8	200	37300.080.001	M16	100	37300.160.001
M4	500	37300.040.001	M10	200	37300.100.001	M20	100	37300.200.001
M5	250	37300.050.001	M12	200	37300.120.001	M24	50	37300.240.001
M6	250	37300.060.001	M14	100	37300.140.001			

• Warning: electro-galvanizing of these products may cause hydrogen embrittlement.

37302 Toothed lock washer external teeth		L07D	
Material	Spring steel 350-425 HV10		
Surface treatment	Zinc plated		
			

For nom. size	☒	Art.number	For nom. size	☒	Art.number	For nom. size	☒	Art.number
M3	500	37302.030.001	M8	200	37302.080.001	M16	200	37302.160.001
M4	500	37302.040.001	M10	200	37302.100.001	M20	100	37302.200.001
M5	250	37302.050.001	M12	200	37302.120.001	M24	50	37302.240.001
M6	250	37302.060.001	M14	100	37302.140.001			

51456 Toothed lock washer external teeth		R09A	
Material	Stainless steel A2		DIN ≈6797A
			NEN ≈2450
			

For nom. size	☒	Art.number	For nom. size	☒	Art.number	For nom. size	☒	Art.number
M2*	1000	51456.020.001	M7*	1000	51456.070.001	M18*	200	51456.180.001
M2,3*	1000	51456.023.001	M8	200	51456.080.001	M20	100	51456.200.001
M3	200	51456.030.001	M10	200	51456.100.001	M22*	200	51456.220.001
M4	200	51456.040.001	M12	100	51456.120.001	M24*	200	51456.240.001
M5	200	51456.050.001	M14*	500	51456.140.001	M27*	100	51456.270.001
M6	200	51456.060.001	M16	100	51456.160.001	M30*	100	51456.300.001

• The austenitic steel type is at the manufacturer's discretion, and can vary from the steel types stated in DIN 267-11.

Contact spring washer for switchgear plants

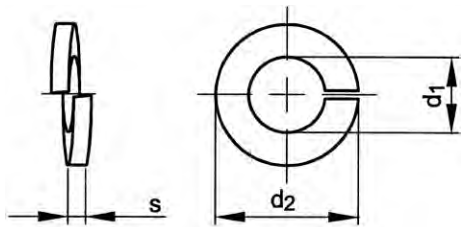

DIN 43699

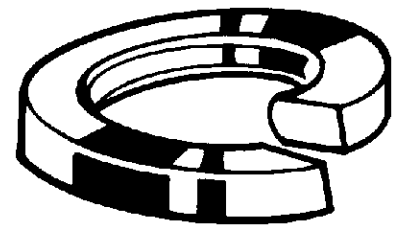

Technical Data

For nom.size	d ₁	d ₂	s	For nom.size	d ₁	d ₂	s
M6 (#DIN)	6.1	12.1	2	M12	12.2	22.2	3.5
M8	8.2	15.2	2.2	M16	16.2	28.2	4
M10	10.2	18.2	2.5	M20	20.2	34.2	5

- Depending on availability these articles can be supplied zinc electro plated as well as mechanical zinc plated.

37260 Contact spring washer for switchgear plants

L07D

Material Spring steel
Surface treatment Zinc plated

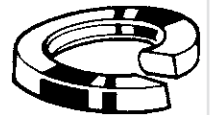

For nom. size	☒	Art.number	For nom. size	☒	Art.number	For nom. size	☒	Art.number
M6	250	37260.060.001	M10	200	37260.100.001	M16	100	37260.160.001
M8	200	37260.080.001	M12	150	37260.120.001	M20	100	37260.200.001

Disc spring for critical applications type A (heavy)

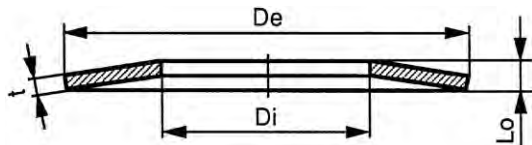

DIN 2093 A

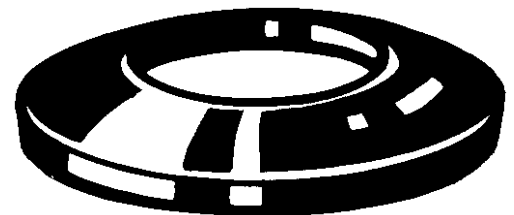

Technical Data

D _e (h12)	D _i (H12)	F	Lo	t	D _e (h12)	D _i (H12)	F	Lo	t
8	4.2	210	0.6	0.4	35.5	18.3	5190	2.8	2
10	5.2	329	0.75	0.5	40	20.4	6450	3.15	2.25
12.5	6.2	673	1	0.7	45	22.4	7720	3.5	2.5
14	7.2	813	1.1	0.8	50	25.4	12000	4.1	3
16	8.2	1000	1.25	0.9	56	28.5	11400	4.3	3
18	9.2	1250	1.4	1	63	31	15000	4.9	3.5
20	10.2	1530	1.55	1.1	71	36	20500	5.6	4
22.5	11.2	1950	1.75	1.25	80	41	33700	6.7	5
25	12.2	2910	2.05	1.5	90	46	31400	7	5
28	14.2	2850	2.15	1.5	100	51	48000	8.2	6
31.5	16.3	3900	2.45	1.75	112	57	43800	8.5	6

- Disc springs acc. to DIN 2093 are mostly used in critical applications with safety first. Similar applications can be found in for example safety torque limiter clutches, hinge stiffeners and applications of constant roll pressure. Because of the right combination c.q. stacking of the disc springs the elasticity and/or deflection can be dosed accurately. The technical specifications of the disc springs above meet the highest expectations with reference to the static and dynamic load. They exceed the requirements of DIN 2093.
- Material group 1: $t < 1,25$ from steel Ck 75.
- Material group 2: $1,25 \leq t \leq 6,0$ from steel 50 Cr V4 (fatigue fractures can be largely prevented because these disc springs have machined edges).
- F = spring force in Newton at a deflection $s \approx 0,75 h_0 (h_0 = L_0 - t)$.
- For the calculation of disc springs, see DIN 2092.
- Extensive technical data available on request.

36300	Disc spring for critical applications type A (heavy)	L07C
Material	Steel Ck 75 Werkstoffnr. 1.1248	
Surface treatment	Phosphated	

$D_e \times D_i \times t$	☒	Art.number	$D_e \times D_i \times t$	☒	Art.number	$D_e \times D_i \times t$	☒	Art.number
8X4,2X0,4MM	100	36300.084.004	25X12,2X1,5MM	50	36300.262.015	56X28,5X3MM	10	36300.588.030
10X5,2X0,5MM	100	36300.105.005	28X14,2X1,5MM	50	36300.294.015	63X31X3,5MM	5	36300.661.035
12,5X6,2X0,7MM	100	36300.131.007	31,5X16,3X1,75MM	50	36300.331.017	71X36X4MM	5	36300.746.040
14X7,2X0,8MM	100	36300.147.008	35,5X18,3X2MM	25	36300.373.020	80X41X5MM	1	36300.841.050
16X8,2X0,9MM	100	36300.168.009	40X20,4X2,25MM	25	36300.420.022	90X46X5MM	1	36300.946.050
18X9,2X1MM	100	36300.189.010	45X22,4X2,5MM	10	36300.472.025	100X51X6MM	1	36300.960.060
20X10,2X1,1MM	50	36300.210.011	50X25,4X3MM	10	36300.525.030	112X57X6MM	1	36300.968.060
22,5X11,2X1,25MM	50	36300.236.012						

Disc spring for critical applications type B (medium)

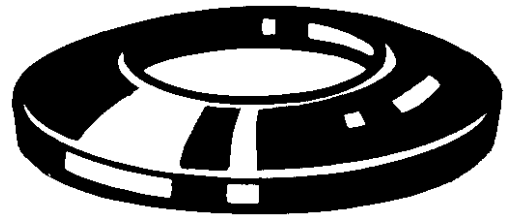
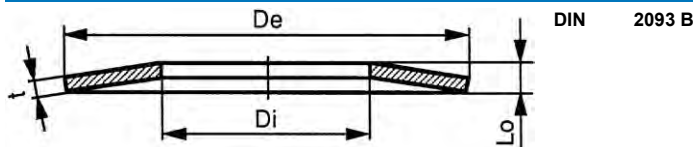

Technical Data

D_e (h12)	D_i (H12)	F	L_o	t	D_e (h12)	D_i (H12)	F	L_o	t
8	4.2	119	0.55	0.3	35.5	18.3	1700	2.25	1.25
10	5.2	213	0.7	0.4	40	20.4	2620	2.65	1.5
12.5	6.2	291	0.85	0.5	45	22.4	3660	3.05	1.75
14	7.2	279	0.9	0.5	50	25.4	4760	3.4	2
16	8.2	412	1.05	0.6	56	28.5	4440	3.6	2
18	9.2	572	1.2	0.7	63	31	7180	4.25	2.5
20	10.2	745	1.35	0.8	71	36	6730	4.5	2.5
22.5	11.2	710	1.45	0.8	80	41	10500	5.3	3
25	12.2	868	1.6	0.9	90	46	14200	6	3.5
28	14.2	1110	1.8	1	100	51	13100	6.3	3.5
31.5	16.3	1920	2.15	1.25	112	57	17800	7.2	4

- Disc springs acc. to DIN 2093 are mostly used in critical applications with safety first. Similar applications can be found in for example safety torque limiter clutches, hinge stiffeners and applications of constant roll pressure. Because of the right combination c.q. stacking of the disc springs the elasticity and/or deflection can be dosed accurately. The technical specifications of the disc springs above meet the highest expectations with reference to the static and dynamic load. They exceed the requirements of DIN 2093.
- Material group 1: $t < 1,25$ from steel C75S.
- Material group 2: $1,25 \leq t \leq 6,0$ from steel 51 Cr V4 (fatigue fractures can be largely prevented because these disc springs have machined edges).
- F = spring force in Newton at a deflection $s = 0,75 h_o$ ($h_o = L_o - t$).
- Nominal thickness. For the calculation of disc springs, see DIN 2092.

Example of application

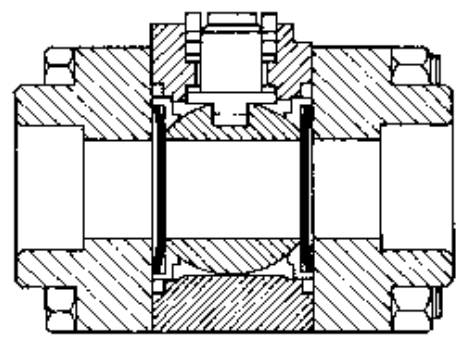

Ball valve

36302 Disc spring for critical applications type B (medium) L07C

Material Spring steel
Surface treatment Phosphated



$D_e \times D_i \times t$	☒	Art.number	$D_e \times D_i \times t$	☒	Art.number	$D_e \times D_i \times t$	☒	Art.number
8X4,2X0,3MM	100	36302.084.003	25X12,2X0,9MM	50	36302.262.009	56X28,5X2MM	10	36302.588.020
10X5,2X0,4MM	100	36302.105.004	28X14,2X1MM	50	36302.294.010	63X31X2,5MM	5	36302.661.025
12,5X6,2X0,5MM	100	36302.131.005	31,5X16,3X1,25MM	50	36302.331.012	71X36X2,5MM	5	36302.746.025
14X7,2X0,5MM	100	36302.147.005	35,5X18,3X1,25MM	25	36302.373.012	80X41X3MM	1	36302.841.030
16X8,2X0,6MM	100	36302.168.006	40X20,4X1,5MM	25	36302.420.015	90X46X3,5MM	1	36302.946.035
18X9,2X0,7MM	100	36302.189.007	45X22,4X1,75MM	10	36302.472.017	100X51X3,5MM	1	36302.960.035
20X10,2X0,8MM	50	36302.210.008	50X25,4X2MM	10	36302.525.020	112X57X4MM	1	36302.968.040
22,5X11,2X0,8MM	50	36302.236.008						

Disc spring for critical applications type C (light)

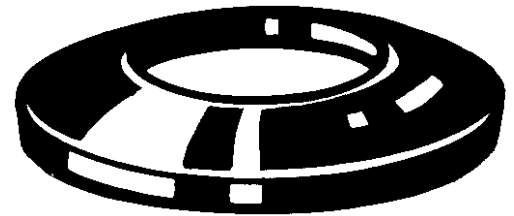
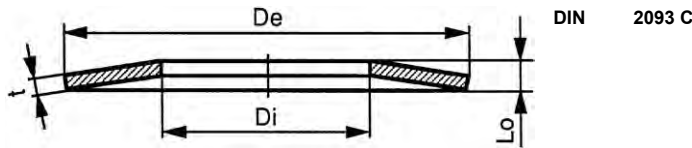

Technical Data

D_e (h12)	D_i (H12)	F	L_o	t	D_e (h12)	D_i (H12)	F	L_o	t
8	4.2	39	0.45	0.2	40	20.4	1020	2.3	1
10	5.2	58	0.55	0.25	45	22.4	1890	2.85	1.25
12.5	6.2	152	0.8	0.35	50	25.4	1550	2.85	1.25
14	7.2	123	0.8	0.35	56	28.5	2620	3.45	1.5
16	8.2	155	0.9	0.4	63	31	4240	4.15	1.8
18	9.2	214	1.05	0.45	71	36	5140	4.6	2
20	10.2	254	1.15	0.5	80	41	6610	5.2	2.25
22.5	11.2	425	1.4	0.6	90	46	7680	5.7	2.5
25	12.2	601	1.6	0.7	100	51	8610	6.2	2.7
28	14.2	801	1.8	0.8	112	57	10500	6.9	3
31.5	16.3	687	1.85	0.8	125	64	15400	8	3.5
35.5	18.3	831	2.05	0.9					

- Disc springs acc. to DIN 2093 are mostly used in critical applications with safety first. Similar applications can be found in for example safety torque limiter clutches, hinge stiffeners and applications of constant roll pressure. Because of the right combination c.q. stacking of the disc springs the elasticity and/or deflection can be dosed accurately. The technical specifications of the disc springs above meet the highest expectations with reference to the static and dynamic load. They exceed the requirements of DIN 2093.
- Material group 1: $t < 1,25$ from steel C75S.
- Material group 2: $1,25 \leq t \leq 6,0$ from steel 51 Cr V4 (fatigue fractures can be largely prevented because these disc springs have machined edges).
- F = spring force in Newton at a deflection $s \approx 0,75 h_o$ ($h_o = L_o - t$).
- For the calculation of disc springs, see DIN 2092.

Example of application

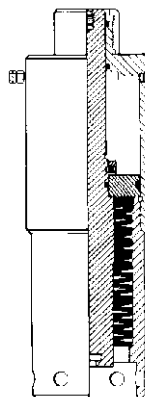

36303 Disc spring for critical applications type C (light) L07C

Material Spring steel
Surface treatment Phosphated

$D_e \times D_i \times t$	☒	Art.number	$D_e \times D_i \times t$	☒	Art.number	$D_e \times D_i \times t$	☒	Art.number
8X4,2X0,2MM	100	36303.084.002	25X12,2X0,7MM	50	36303.262.007	63X31X1,8MM	5	36303.661.018
10X5,2X0,25MM	100	36303.105.002	28X14,2X0,8MM	50	36303.294.008	71X36X2MM	5	36303.746.020
12,5X6,2X0,35MM	100	36303.131.003	31,5X16,3X0,8MM	50	36303.331.008	80X41X2,25MM	1	36303.841.022
14X7,2X0,35MM	100	36303.147.003	35,5X18,3X0,9MM	25	36303.373.009	90X46X2,5MM	1	36303.946.025
16X8,2X0,4MM	100	36303.168.004	40X20,4X1MM	25	36303.420.010	100X51X2,7MM	1	36303.960.027
18X9,2X0,45MM	100	36303.189.004	45X22,4X1,25MM	10	36303.472.012	112X57X3MM	1	36303.968.030
20X10,2X0,5MM	50	36303.210.005	50X25,4X1,25MM	10	36303.525.012	125X64X3,5MM	1	36303.970.035
22,5X11,2X0,6MM	50	36303.236.006	56X28,5X1,5MM	10	36303.588.015			

Disc spring

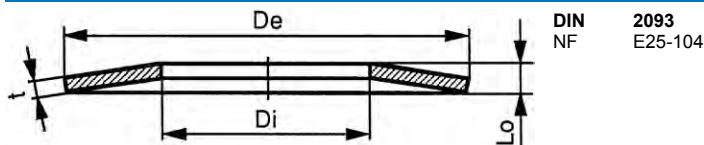

Technical Data

D_e (h12)	D_i (H12)	F	L_o	t	Type	D_e (h12)	D_i (H12)	F	L_o	t	Type
6	3.2	119	0.45	0.3	-	18	6.2	139	1	0.4	-
8	3.2	26	0.4	0.2	-	18	6.2	245	1.1	0.5	-
8	3.2	104	0.55	0.3	-	18	6.2	400	1.2	0.6	-
8	3.2	185	0.6	0.4	-	18	6.2	552	1.25	0.7	-
8	3.2	357	0.7	0.5	-	18	6.2	725	1.3	0.8	-
8	4.2	39	0.45	0.2	C	18	8.2	265	1.1	0.5	-
8	4.2	118	0.55	0.3	B	18	8.2	596	1.25	0.7	-
8	4.2	209	0.6	0.4	A	18	8.2	782	1.3	0.8	-
10	3.2	98	0.65	0.3	-	18	8.2	1501	1.5	1	-
10	3.2	179	0.7	0.4	-	18	9.2	214	1.05	0.45	C
10	3.2	278	0.75	0.5	-	18	9.2	566	1.2	0.7	B
10	4.2	189	0.7	0.4	-	18	9.2	1253	1.4	1	A
10	4.2	294	0.75	0.5	-	20	8.2	412	1.3	0.6	-
10	5.2	58	0.55	0.25	C	20	8.2	568	1.35	0.7	-
10	5.2	209	0.7	0.4	B	20	8.2	751	1.4	0.8	-
10	5.2	325	0.75	0.5	A	20	8.2	953	1.45	0.9	-
12	4.2	178	0.8	0.4	-	20	8.2	1294	1.55	1	-
12	4.2	284	0.85	0.5	-	20	10.2	254	1.15	0.5	C
12	5.2	349	0.9	0.5	-	20	10.2	748	1.35	0.8	B
12	5.2	506	0.95	0.6	-	20	10.2	1049	1.45	0.9	-
12	6.2	326	0.85	0.5	-	20	10.2	1424	1.55	1	-
12	6.2	551	0.95	0.6	-	20	10.2	1520	1.55	1.1	A
12.5	5.2	272	0.85	0.5	-	20	10.2	2475	1.75	1.25	-
12.5	6.2	151	0.8	0.35	C	20	10.2	4255	2	1.5	-
12.5	6.2	293	0.85	0.5	B	22.5	11.2	425	1.4	0.6	C
12.5	6.2	659	1	0.7	A	22.5	11.2	707	1.45	0.8	B
14	7.2	123	0.8	0.35	C	22.5	11.2	1928	1.75	1.25	A
14	7.2	279	0.9	0.5	B	23	8.2	543	1.5	0.7	-
14	7.2	796	1.1	0.8	A	23	8.2	718	1.55	0.8	-
15	5.2	278	1	0.5	-	23	8.2	918	1.6	0.9	-
15	5.2	407	1.05	0.6	-	23	8.2	1239	1.7	1	-
15	5.2	555	1.1	0.7	-	23	10.2	1057	1.65	0.9	-
15	6.2	289	1	0.5	-	23	10.2	1315	1.7	1	-
15	6.2	423	1.05	0.6	-	23	12.2	2330	1.85	1.25	-
15	6.2	577	1.1	0.7	-	23	12.2	3295	2	1.5	-
15	8.2	665	1.1	0.7	-	25	12.2	569	1.6	0.7	C
15	8.2	982	1.2	0.8	-	25	12.2	862	1.6	0.9	B
16	8.2	154	0.9	0.4	C	25	12.2	1358	1.8	1	-
16	8.2	410	1.05	0.6	B	25	12.2	2213	1.95	1.25	-
16	8.2	1012	1.25	0.9	A	25	12.2	2924	2.05	1.5	A

Technical Data						Technical Data					
D _e (h12)	D _i (H12)	F	Lo	t	Type	D _e (h12)	D _i (H12)	F	Lo	t	Type
28	10.2	661	1.75	0.8	-	50	22.4	8505	3.9	2.5	-
28	10.2	1129	1.9	1	-	50	25.4	1549	2.85	1.25	C
28	10.2	1852	2.05	1.25	-	50	25.4	4760	3.4	2	B
28	10.2	2721	2.2	1.5	-	50	25.4	9058	3.9	2.5	-
28	12.2	1267	1.95	1	-	50	25.4	11970	4.1	3	A
28	12.2	2081	2.1	1.25	-	56	28.5	2621	3.45	1.5	C
28	12.2	3075	2.25	1.5	-	56	28.5	4436	3.6	2	B
28	14.2	801	1.8	0.8	C	56	28.5	11382	4.3	3	A
28	14.2	1107	1.8	1	B	60	20.4	7293	4.3	2.5	-
28	14.2	2238	2.1	1.25	-	60	20.4	11569	4.7	3	-
28	14.2	2839	2.15	1.5	A	60	25.4	8159	4.4	2.5	-
31.5	12.2	1170	2.1	1	-	60	25.4	11762	4.65	3	-
31.5	12.2	1805	2.2	1.25	-	60	30.5	9430	4.5	2.5	-
31.5	12.2	2690	2.35	1.5	-	60	30.5	13219	4.7	3	-
31.5	16.3	687	1.85	0.8	C	60	30.5	18143	5	3.5	-
31.5	16.3	1912	2.15	1.25	B	63	31	4236	4.15	1.8	C
31.5	16.3	3228	2.4	1.5	-	63	31	7185	4.25	2.5	B
31.5	16.3	3859	2.45	1.75	A	63	31	15017	4.9	3.5	A
31.5	16.3	6170	2.75	2	-	70	25.5	4435	4.5	2	-
34	12.2	1172	2.25	1	-	70	30.5	11420	5.1	3	-
34	12.2	1814	2.35	1.25	-	70	35.5	12281	5.1	3	-
34	12.2	2719	2.5	1.5	-	70	35.5	23923	5.8	4	-
34	14.2	1988	2.4	1.25	-	70	40.5	23338	5.6	4	-
34	14.2	2982	2.55	1.5	-	70	40.5	33653	6.2	5	-
34	16.3	3153	2.55	1.5	-	71	36	5141	4.6	2	C
34	16.3	5779	2.85	2	-	71	36	6722	4.5	2.5	B
35.5	18.3	832	2.05	0.9	C	71	36	20524	5.6	4	A
35.5	18.3	1698	2.5	1.25	B	80	31	10346	5.5	3	-
35.5	18.3	5184	2.8	2	A	80	36	11912	5.7	3	-
40	14.2	1779	2.65	1.25	-	80	36	21388	6.2	4	-
40	14.3	2544	2.75	1.5	-	80	41	6609	5.2	2.25	C
40	14.2	4766	3.05	2	-	80	41	10512	5.3	3	B
40	16.3	2748	2.8	1.5	-	80	41	22861	6.2	4	-
40	16.3	5166	3.1	2	-	80	41	33541	6.7	5	A
40	20.4	1016	2.3	1	C	90	46	7680	5.7	2.5	C
40	20.4	2620	2.65	1.5	B	90	46	14153	6	3.5	B
40	20.4	5698	3.1	2	-	90	46	31337	7	5	A
40	20.4	6497	3.15	2.25	A	100	41	20240	7.2	4	-
40	20.4	9384	3.45	2.5	-	100	51	8604	6.2	2.7	C
45	22.4	1890	2.85	1.25	C	100	51	13063	6.3	3.5	B
45	22.4	3644	3.05	1.75	B	100	51	36319	7.8	5	-
45	22.4	7712	3.5	2.5	A	100	51	47995	8.2	6	A
50	18.4	4564	3.5	2	-	112	57	17743	7.2	4	B
50	20.4	4685	3.5	2	-	112	57	43683	8.5	6	A
50	22.4	5219	3.6	2	-						

7

- The disc springs mentioned above acc. to ≈ DIN 2093 are suitable for general use. For more critical applications it is advised to choose disc springs from the article groups 36300, 36302, 36303 and 36450.
- Group 1: $t < 1,25$ from steel C67S
- Group 2: $1,25 \leq t \leq 6,0$ from steel 51 Cr V4 (edges of these disc springs are not machined).
- F = spring force in Newton at a deflection $s \approx 0,75 h_0 (h_0 = L_0 - t)$.
- Type A: execution heavy ($D_e/t \approx 18$).
- Type B: execution medium ($D_e/t \approx 28$).
- Type C: execution light ($D_e/t \approx 40$).
- If the type is not mentioned, the concerning dimension is not DIN standardised.
- For the calculation of disc springs, see DIN 2092.

36307	Disc spring	L07C
Material	Spring steel	
Surface treatment	Phosphated	
		 

D _e x D _i x t	Art.number	D _e x D _i x t	Art.number	D _e x D _i x t	Art.number
6x3,2x0,3MM	100 36307.063.003	8x4,2x0,4MM	100 36307.084.004	10x5,2x0,5MM	100 36307.105.005
8x3,2x0,2MM	100 36307.083.002	10x3,2x0,4MM	100 36307.103.004	12x4,2x0,4MM	100 36307.124.004
8x3,2x0,3MM	100 36307.083.003	10x3,2x0,5MM	100 36307.103.005	12x4,2x0,5MM	100 36307.124.005
8x3,2x0,4MM	100 36307.083.004	10x4,2x0,4MM	100 36307.104.004	12x5,2x0,5MM	100 36307.125.005
8x3,2x0,5MM	100 36307.083.005	10x4,2x0,5MM	100 36307.104.005	12x5,2x0,6MM	100 36307.125.006
8x4,2x0,2MM	100 36307.084.002	10x5,2x0,25MM	100 36307.105.002	12x6,2x0,5MM	100 36307.126.005
8x4,2x0,3MM	100 36307.084.003	10x5,2x0,4MM	100 36307.105.004	12x6,2x0,6MM	100 36307.126.006

36307		Disc spring							
$D_e \times D_i \times t$	☒	Art.number	$D_e \times D_i \times t$	☒	Art.number	$D_e \times D_i \times t$	☒	Art.number	
12,5X5,2X0,5	100	36307.130.005	23x10,2x0,9MM	50	36307.240.009	45x22,4x2,5MM	10	36307.472.025	
12,5x6,2x0,35MM	100	36307.131.003	23x10,2x1MM	50	36307.240.010	50x18,4x2MM	10	36307.518.020	
12,5x6,2x0,5MM	100	36307.131.005	23x12,2x1,25MM	50	36307.242.012	50x20,4x2MM	10	36307.520.020	
12,5x6,2x0,7MM	100	36307.131.007	23x12,2x1,5MM	50	36307.242.015	50x22,4x2MM	10	36307.522.020	
14X7,2x0,35MM	100	36307.147.003	25x12,2x0,7MM	50	36307.262.007	50x22,4x2,5MM	10	36307.522.025	
14x7,2x0,5MM	100	36307.147.005	25x12,2x0,9MM	50	36307.262.009	50x25,4x1,25MM	10	36307.525.012	
14x7,2x0,8MM	100	36307.147.008	25x12,2x1,25MM	50	36307.262.012	50x25,4x2MM	10	36307.525.020	
15x5,2x0,5MM	100	36307.155.005	25x12,2x1,5MM	50	36307.262.015	50x25,4x2,5MM	10	36307.525.025	
15x5,2x0,6MM	100	36307.155.006	28x10,2x0,8MM	50	36307.290.008	50x25,4x3MM	10	36307.525.030	
15x5,2x0,7MM	100	36307.155.007	28x10,2x1MM	50	36307.290.010	56x28,5x1,5MM	10	36307.588.015	
15x6,2x0,5MM	100	36307.156.005	28x10,2x1,25MM	50	36307.290.012	56x28,5x2MM	10	36307.588.020	
15x6,2x0,6MM	100	36307.156.006	28x10,2x1,5MM	50	36307.290.015	56x28,5x3MM	10	36307.588.030	
15x6,2x0,7MM	100	36307.156.007	28x12,2x1MM	50	36307.292.010	60X20,5X2,5	5	36307.620.025	
15x8,2x0,7MM	100	36307.158.007	28x12,2x1,25MM	50	36307.292.012	60x25,4x2,5MM	5	36307.625.025	
15x8,2x0,8MM	100	36307.158.008	28x12,2x1,5MM	50	36307.292.015	60x25,4x3MM	5	36307.625.030	
16x8,2x0,4MM	100	36307.168.004	28x14,2x0,8MM	50	36307.294.008	60x30,5x2,5MM	5	36307.630.025	
16x8,2x0,6MM	100	36307.168.006	28x14,2x1MM	50	36307.294.010	60x30,5x3MM	5	36307.630.030	
16x8,2x0,9MM	100	36307.168.009	28x14,2x1,25MM	50	36307.294.012	60x30,5x3,5MM	5	36307.630.035	
18x6,2x0,4MM	100	36307.186.004	28x14,2x1,5MM	50	36307.294.015	63x31x1,8MM	5	36307.661.018	
18x6,2x0,5MM	100	36307.186.005	31,5x12,2x1MM	50	36307.327.010	63x31x2,5MM	5	36307.661.025	
18x6,2x0,6MM	100	36307.186.006	31,5x12,2x1,25MM	50	36307.327.012	63x31x3,5MM	5	36307.661.035	
18x6,2x0,7MM	100	36307.186.007	31,5x12,2x1,5MM	50	36307.327.015	70x25,5x2MM	5	36307.725.020	
18x6,2x0,8MM	100	36307.186.008	31,5x16,3x0,8MM	50	36307.331.008	70x30,5x3MM	5	36307.730.030	
18x8,2x0,5MM	100	36307.188.005	31,5x16,3x1,25MM	50	36307.331.012	70x35,5x3MM	5	36307.735.030	
18x8,2x0,7MM	100	36307.188.007	31,5x16,3x1,5MM	50	36307.331.015	70x35,5x4MM	5	36307.735.040	
18x8,2x0,8MM	100	36307.188.008	31,5x16,3x1,75MM	50	36307.331.017	70x40,5x4MM	5	36307.740.040	
18x8,2x1MM	100	36307.188.010	31,5x16,3x2MM	50	36307.331.020	70x40,5x5MM	5	36307.740.050	
18x9,2x0,45MM	100	36307.189.004	34x12,2x1MM	25	36307.352.010	71x36x2MM	5	36307.746.020	
18x9,2x0,7MM	100	36307.189.007	34x12,2x1,25MM	25	36307.352.012	71x36x2,5MM	5	36307.746.025	
18x9,2x1MM	100	36307.189.010	34x12,2x1,5MM	25	36307.352.015	71x36x4MM	5	36307.746.040	
20x8,2x0,6MM	50	36307.208.006	34X1x,2x1,25MM	25	36307.354.012	80x31x3MM	1	36307.831.030	
20x8,2x0,7MM	50	36307.208.007	34x14,2x1,5MM	25	36307.354.015	80x36x3MM	1	36307.836.030	
20x8,2x0,8MM	50	36307.208.008	34x16,3x1,5MM	25	36307.356.015	80x36x4MM	1	36307.836.040	
20x8,2x0,9MM	50	36307.208.009	34x16,3x2MM	25	36307.356.020	80x41x2,25MM	1	36307.841.022	
20x8,2x1MM	50	36307.208.010	35,5x18,3x0,9M	25	36307.373.009	80x41x3MM	1	36307.841.030	
20x10,2x0,5MM	50	36307.210.005	35,5x18,3x1,25MM	25	36307.373.012	80x41x4MM	1	36307.841.040	
20x10,2x0,8MM	50	36307.210.008	35,5x18,3x2MM	25	36307.373.020	80x41x5MM	1	36307.841.050	
20x10,2x0,9MM	50	36307.210.009	40x14,2x1,25MM	25	36307.414.012	90x46x2,5MM	1	36307.946.025	
20x10,2x1MM	50	36307.210.010	40x14,3x1,5MM	25	36307.414.015	90x46x3,5MM	1	36307.946.035	
20x10,2x1,1MM	50	36307.210.011	40x14,3x2MM	25	36307.414.020	90x46x5MM	1	36307.946.050	
20x10,2x1,25MM	50	36307.210.012	40x16,3x1,5MM	25	36307.416.015	100x41x4MM	1	36307.960.004	
20x10,2x1,5MM	50	36307.210.015	40x16,3x2MM	25	36307.416.020	100x51x2,7MM	1	36307.960.027	
22,5x11,2x0,6MM	50	36307.236.006	40x20,4x1MM	25	36307.420.010	100x51x3,5MM	1	36307.960.035	
22,5x11,2x0,8MM	50	36307.236.008	40x20,4x1,5MM	25	36307.420.015	100x51x5MM	1	36307.960.050	
22,5x11,2x1,25MM	50	36307.236.012	40x20,4x2MM	25	36307.420.020	100x51x6MM	1	36307.960.060	
23x8,2x0,7MM	50	36307.238.007	40x20,4x2,25MM	25	36307.420.022	112x57x4MM	1	36307.968.040	
23x8,2x0,8MM	50	36307.238.008	40x20,4x2,5MM	25	36307.420.025	112x57x6MM	1	36307.968.060	
23x8,2x0,9MM	50	36307.238.009	45x22,4x1,25MM	10	36307.472.012				
23x8,2x1MM	50	36307.238.010	45x22,4x1,75MM	10	36307.472.017				

Disc spring type A (heavy)

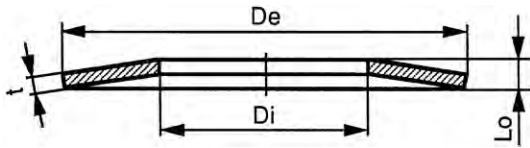

DIN ≈2093 A/C

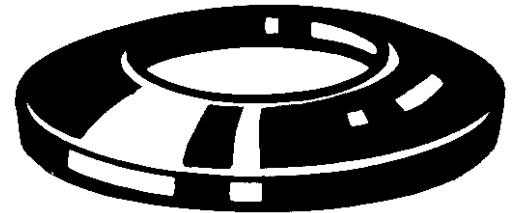

Technical Data

D _e (h12)	D _i (H12)	F	Lo	t	D _e (h12)	D _i (H12)	F	Lo	t
8	4.2	192	0.6	0.4	28	14.2	2004	2.15	1.5
10	5.2	298	0.75	0.5	31.5	16.3	2745	2.3	1.75
12	5.2	350	0.9	0.5	35.5	18.3	4200	2.65	2
12-1	6.2	547	0.95	0.6	40	20.4	932	2.3	1
12.5	6.2	499	0.95	0.7	40	20.4	4630	2.95	2.25
14	7.2	730	1.1	0.8	45	22.4	5719	3.3	2.5
15	8.2	-	1.25	0.8	50	25.4	9212	3.85	3
16	8.2	928	1.25	0.9	56	28.5	9134	4.05	3
18	9.2	1149	1.4	1	71	36	16626	5.6	4
20	10.2	1394	1.55	1.1	80	41	25845	6.7	5
22.5	11.2	1402	1.75	1.25	100	51	37336	8.2	6
25	12.2	1931	1.9	1.5					

- Disc springs acc. to » DIN 2093 A are mostly used in critical applications with safety first. Similar applications can be found in for example safety torque limiter clutches, hinge stiffeners and applications of constant roll pressure. Because of the right combination c.q. stacking of the disc springs the elasticity and/or deflection can be dosed accurately. The technical specifications of the disc springs above meet the highest expectations with reference to the static and dynamic load. Heat treatment gives a copper-bronze colour to this disc springs.
- D_e(h12) 8-10-12,5-14-16-18-20-22,5-25-28-31,5-40 X 12 CrNi 17 7 (Werkstoffnr. 1.4310).
- D_e(h12) 35,5-50-56-71 X 35 CrMo 17 (Werkstoffno. 1.4122).
- D_e(h12) 45 X 7 CrNiAl 17 7 (Werkstoffno. 1.4568).
- D_e(h12) 80-100 X 22 CrMoV 12 1 (Werkstoffno. 1.4923).
- F = spring force in Newton at a deflection s = 0,75 h₀ (h₀ = L₀ - t).
- D_e(h12)=40, t=1 ATTENTION: acc. to ≈ DIN 2993 C Standardised: execution "light".
- For the calculation of disc springs, see DIN 2092.

Examples of application

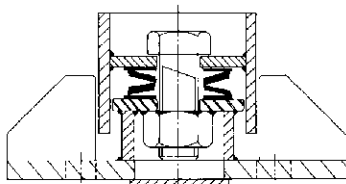

Shock absorption

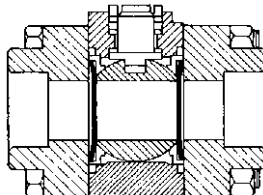

Ball valve

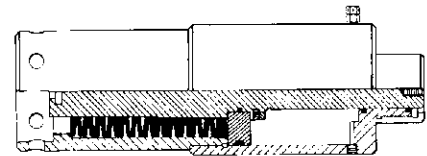

Power switch

7

51448	Disc spring type A (heavy)	R09A
Material	Stainless steel	
		

D _e x D _i x t	☒	Art.number	D _e x D _i x t	☒	Art.number	D _e x D _i x t	☒	Art.number
8X3,2X0,5MM*	200	51448.083.005	16X8,2X0,6MM*	100	51448.168.006	28X14,2X1,0MM*	50	51448.294.010
8X4,2X0,3MM*	200	51448.084.003	16X8,2X0,9MM	50	51448.168.009	28X14,2X1,5MM	25	51448.294.015
8X4,2X0,4MM	50	51448.084.004	18X6,2X0,4MM*	100	51448.186.004	31,5X16,3X1,25MM*	50	51448.331.012
10X5,2X0,4MM*	200	51448.105.004	18X9,2X0,7MM*	100	51448.189.007	31,5X16,3X1,75MM	25	51448.331.017
10X5,2X0,5MM	50	51448.105.005	18X9,2X1,0MM	50	51448.189.010	35,5X18,3X1,25MM*	50	51448.373.012
12X4,2X0,4MM*	200	51448.124.004	20X8,2X0,5MM*	100	51448.208.005	35,5X18,3X2,0MM	10	51448.373.020
12X4,2X0,5MM*	200	51448.124.005	20X10,2X0,6MM*	100	51448.210.006	40X20,4X1,0MM	10	51448.420.010
12X5,2X0,5MM	50	51448.125.005	20X10,2X0,8MM*	100	51448.210.008	40X20,4X1,5MM*	25	51448.420.015
12X6,2X0,5MM*	200	51448.126.005	20X10,2X0,9MM*	100	51448.210.009	40X20,4X2,0MM*	25	51448.420.020
12,5X6,2X0,5MM*	200	51448.131.005	20X10,2X1,0MM*	100	51448.210.010	40X20,4X2,25MM	10	51448.420.022
12,5X6,2X0,7MM	50	51448.131.007	20X10,2X1,1MM	25	51448.210.011	45X22,4X2,5MM	5	51448.472.025
14X7,2X0,8MM	50	51448.147.008	22,5X11,2X1,25MM	25	51448.236.012	50X25,4X3,0MM	5	51448.520.030
15X8,2X0,8MM*	100	51448.158.008	25X12,2X0,9MM*	50	51448.262.009	56X28,5X3,0MM	5	51448.588.030
16X8,2X0,4MM*	100	51448.168.004	25X12,2X1,5MM	25	51448.262.015	71X36,0X4,0MM	1	51448.746.040

Conical spring washer for bolted connections

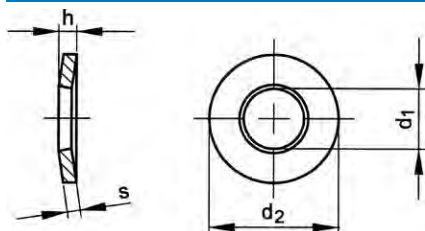

DIN 6796

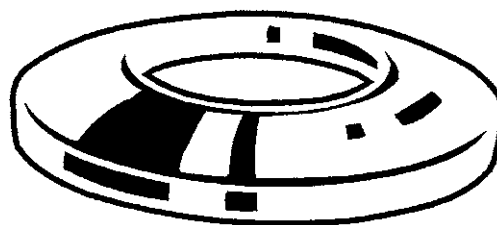

Technical Data

For nom.size	d ₁ (H14)	d ₂ (h14)	h (max.)	s
M3	3.2	7	0.85	0.6
M4	4.3	9	1.3	1
M5	5.3	11	1.55	1.2
M6	6.4	14	2	1.5
M8	8.4	18	2.6	2
M10	10.5	23	3.2	2.5
M12	13	29	3.95	3
M14	15	35	4.65	3.5
M16	17	39	5.25	4
M18	19	42	5.8	4.5
M20	21	45	6.4	5
M22	23	49	7.05	5.5
M24	25	56	7.75	6
M30	31	70	9.2	7

- Conical spring washers acc. to DIN 6796 should be used in combination with fasteners of property class 8.8 and 10.9, use under dynamic load is not allowed.
- For locking under dynamic load is referred to locking edge washers and NORD-LOCK vibration proof washers.

Article groups

Material	Surface treatment	Code	Page
Spring steel DIN267-26		36270	7-89
Spring steel DIN267-26	Mech.zipl. yell.p.	36273	7-89
St.St. A2		51447	7-90
St.St. A4		55447	7-90

7

36270 Conical spring washer for bolted connections

L07C

Material Spring steel DIN267-26



For nom. size	☒	Art.number	For nom. size	☒	Art.number	For nom. size	☒	Art.number
M4	100	36270.040.001	M10	100	36270.100.001	M20	50	36270.200.001
M5	100	36270.050.001	M12	100	36270.120.001	M22	25	36270.220.001
M6	100	36270.060.001	M14	50	36270.140.001	M24	25	36270.240.001
M8	100	36270.080.001	M16	50	36270.160.001			

- Warning: electro-galvanizing of these products may cause hydrogen embrittlement.

36273 Conical spring washer for bolted connections

L07C

Material Spring steel DIN267-26
Surface treatment Mechanical zinc plated yellow passivated



For nom. size	☒	Art.number	For nom. size	☒	Art.number	For nom. size	☒	Art.number
M3	100	36273.030.001	M8	100	36273.080.001	M16	50	36273.160.001
M4	100	36273.040.001	M10	100	36273.100.001	M20	50	36273.200.001
M5	100	36273.050.001	M12	100	36273.120.001	M24	25	36273.240.001
M6	100	36273.060.001	M14	50	36273.140.001			

51447 Conical spring washer for bolted connections R05A



Material: Stainless steel A2



For nom. size	☒	Art.number	For nom. size	☒	Art.number	For nom. size	☒	Art.number
M3*	500	51447.030.001	M10	200	51447.100.001	M18*	100	51447.180.001
M4	500	51447.040.001	M12	200	51447.120.001	M20*	100	51447.200.001
M5	500	51447.050.001	M14*	100	51447.140.001	M22*	50	51447.220.001
M6*	500	51447.060.001	M16*	100	51447.160.001	M24*	50	51447.240.001
M8	200	51447.080.001						

55447 Conical spring washer for bolted connections R45A

Material: Stainless steel A4

For nom. size	☒	Art.number	For nom. size	☒	Art.number	For nom. size	☒	Art.number
M3*	500	55447.030.001	M10*	200	55447.100.001	M18*	100	55447.180.001
M4*	500	55447.040.001	M12*	200	55447.120.001	M20*	100	55447.200.001
M5*	500	55447.050.001	M14*	100	55447.140.001	M22*	50	55447.220.001
M6	500	55447.060.001	M16*	100	55447.160.001	M24*	50	55447.240.001

Disc spring for critical applications

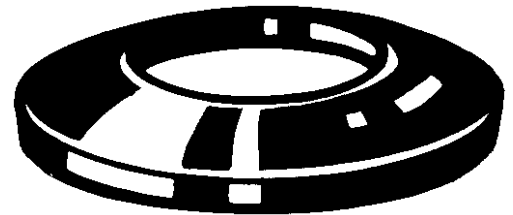
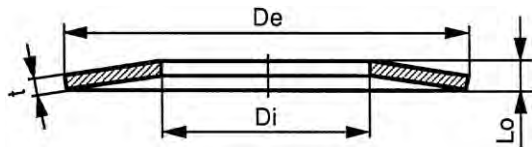

7

Technical Data

D _e (h12)	D _i (H12)	F	Lo	t	D _e (h12)	D _i (H12)	F	Lo	t
8	3.2	104	0.55	0.3	18	8.2	265	1.1	0.5
8	3.2	186	0.6	0.4	18	8.2	596	1.25	0.7
8	3.2	357	0.7	0.5	18	8.2	783	1.3	0.8
10	3.2	98	0.65	0.3	18	8.2	1181	1.4	1
10	3.2	179	0.7	0.4	20	8.2	412	1.3	0.6
10	3.2	279	0.75	0.5	20	8.2	569	1.35	0.7
10	4.2	189	0.7	0.4	20	8.2	751	1.4	0.8
10	4.2	294	0.75	0.5	20	8.2	954	1.45	0.9
12	4.2	178	0.8	0.4	20	8.2	1294	1.55	1
12	4.2	284	0.85	0.5	20	10.2	1050	1.45	0.9
12	5.2	350	0.9	0.5	20	10.2	1425	1.55	1
12	5.2	506	0.95	0.6	20	10.2	2477	1.75	1.25
12	6.2	326	0.85	0.5	20	10.2	2521	1.8	1.5
12	6.2	552	0.95	0.6	23	8.2	544	1.5	0.7
12	5.2	272	0.85	0.5	23	8.2	719	1.55	0.8
15	5.2	176	0.95	0.4	23	8.2	919	1.6	0.9
15	5.2	278	1	0.5	23	10.2	1058	1.65	0.9
15	5.2	407	1.05	0.6	23	10.2	1315	1.7	1
15	5.2	555	1.1	0.7	23	12.2	2331	1.85	1.25
15	6.2	289	1	0.5	23	12.2	3297	2	1.5
15	6.2	424	1.05	0.6	25	12.2	2214	1.95	1.25
15	6.2	578	1.1	0.7	28	10.2	662	1.75	0.8
15	8.2	666	1.1	0.7	28	10.2	1130	1.9	1
15	8.2	982	1.2	0.8	28	10.2	1853	2.05	1.25
18	6.2	139	1	0.4	28	10.2	2723	2.2	1.5
18	6.2	245	1.1	0.5	28	12.2	3077	2.25	1.5
18	6.2	400	1.2	0.6	28	14.2	2240	2.1	1.25
18	6.2	553	1.25	0.7	31.5	12.2	1170	2.1	1
18	6.2	726	1.3	0.8	31.5	12.2	1800	2.2	1.25

Technical Data					Technical Data				
D _o (h12)	D _i (H12)	F	Lo	t	D _o (h12)	D _i (H12)	F	Lo	t
31.5	12.2	2697	2.35	1.5	60	20.4	7297	4.3	2.5
31.5	16.3	3230	2.4	1.5	60	25.4	8164	4.4	2.5
31.5	16.3	6173	2.75	2	60	25.4	11768	4.65	3
34	12.2	1172	2.25	1	60	30.5	9430	4.5	2.5
34	12.2	1815	2.35	1.25	60	30.5	13226	4.7	3
34	12.2	2721	2.5	1.5	60	30.5	18153	5	3.5
34	14.2	1989	2.4	1.25	70	25.5	4437	4.5	2
34	14.2	2984	2.55	1.5	70	30.5	11426	5.1	3
34	16.3	5783	2.85	2	70	35.5	12287	5.1	3
40	14.2	1778	2.65	1.25	70	40.5	23351	5.6	4
40	14.2	2542	2.75	1.5	70	40.5	33672	6.2	5
40	14.2	4763	3.05	2	80	31	10352	5.5	3
40	16.3	2749	2.8	1.5	80	36	11919	5.7	3
40	16.3	5169	3.1	2	80	36	21400	6.2	4
40	18.3	5956	3.15	2	80	41	22874	6.2	4
40	20.4	5701	3.1	2	100	41	20251	7.2	4
40	20.4	9390	3.45	2.5	100	51	36339	7.8	5
50	18.4	2603	3.5	1.5	125	51	44307	9.4	6
50	18.3	4567	3.5	2	125	61	50722	9.6	6
50	20.4	4687	3.5	2	150	61	45456	10.8	6
50	22.4	5222	3.6	2	150	81	89532	11.7	8
50	22.4	7919	3.85	2.5	200	92	137688	15.6	10
50	25.4	2512	3.1	1.5	200	112	195830	16.2	12
50	25.4	9063	3.9	2.5	250	127	383017	21.8	16

- Disc springs are mostly used in critical applications with safety first. Similar applications can be found in for example safety torque limiter clutches, hinge stiffeners and applications of constant roll pressure. Because of the right combination c.q. stacking of the disc springs the elasticity and/or deflection can be dosed accurately. The technical specifications of these disc springs meet the highest expectations with reference to the static and dynamic load. They exceed the requirements of DIN 2093.
- Material group 1: $t < 1,25$ from steel Ck 67.
- Material group 2: $1,25 \leq t \leq 6,0$ from steel 50 Cr V4.
- Material group 3: $6,0 > t \leq 14,0$ from steel 50 Cr V4.
- Fatigue fractures can be largely prevented because the disc springs of material group 2 and 3 have machined edges.
- F = spring force in Newton at a deflection $s \approx 0,75 h_0 (h_0 = L_0 - t)$.
- For the calculation of disc springs, see DIN 2092.
- Extensive technical data available on request.

36450 Disc spring for critical applications
L07C

Material Steel Ck 67 Werkstoffnr. 1.1231
Surface treatment Phosphated



D _o x D _i x t	☒	Art.number	D _o x D _i x t	☒	Art.number	D _o x D _i x t	☒	Art.number
8X3,2X0,3MM	100	36450.083.003	20X8,2X0,6MM	50	36450.208.006	34X14,2X1,5MM	25	36450.354.015
8X3,2X0,4MM	100	36450.083.004	20X8,2X0,7MM	50	36450.208.007	34X16,3X2,0MM	25	36450.356.020
8X3,2X0,5MM	100	36450.083.005	20X8,2X0,8MM	50	36450.208.008	40X14,2X1,25MM	25	36450.414.012
10X3,2X0,3MM	100	36450.103.003	20X8,2X0,9MM	50	36450.208.009	40X14,2X1,5MM	25	36450.414.015
10X3,2X0,4MM	100	36450.103.004	20X8,2X1,0MM	50	36450.208.010	40x14,2x2,0MM	25	36450.414.020
10X3,2X0,5MM	100	36450.103.005	20X10,2X0,9MM	50	36450.210.009	40X16,3X1,5MM	25	36450.416.015
10X4,2X0,4MM	100	36450.104.004	20X10,2X1,0MM	50	36450.210.010	40X16,3X2,0MM	25	36450.416.020
10X4,2X0,5MM	100	36450.104.005	20X10,2X1,25MM	50	36450.210.012	40X18,3X2,0MM	25	36450.418.020
12X4,2X0,4MM	100	36450.124.004	20X10,2X1,5MM	50	36450.210.015	40X20,4X2,0MM	25	36450.420.020
12X4,2X0,5MM	100	36450.124.005	23X8,2X0,7MM	50	36450.238.007	40X20,4X2,5MM	25	36450.420.025
12X5,2X0,5MM	100	36450.125.005	23x8,2x0,8MM	50	36450.238.008	50X18,4X1,5MM	25	36450.518.015
12X5,2X0,6MM	100	36450.125.006	23X8,2X0,9MM	50	36450.238.009	50X18,3X2,0MM	10	36450.518.020
12X6,2X0,5MM	100	36450.126.005	23X10,2X0,9MM	50	36450.240.009	50X20,4X2,0MM	10	36450.520.020
12X6,2X0,6MM	100	36450.126.006	23X10,2X1,0MM	50	36450.240.010	50X22,4X2,0MM	10	36450.522.020
15X5,2X0,4MM	100	36450.155.004	23X12,2X1,25MM	50	36450.242.012	50X22,4X2,5MM	10	36450.522.025
15X5,2X0,5MM	100	36450.155.005	23X12,2X1,5MM	50	36450.242.015	50X25,4X1,5MM	10	36450.525.015
15X5,2X0,6MM	100	36450.155.006	25X12,2X1,25MM	50	36450.262.012	50X25,4X2,5MM	10	36450.525.025
15X5,2X0,7MM	100	36450.155.007	28X10,2X0,8MM	50	36450.290.008	60X20,4X2,5MM	5	36450.620.025
15X6,2X0,5MM	100	36450.156.005	28X10,2X1,0MM	50	36450.290.010	60X25,4X2,5MM	5	36450.625.025
15X6,2X0,6MM	100	36450.156.006	28X10,2X1,25MM	50	36450.290.012	60X25,4X3,0MM	5	36450.625.030
15X6,2X0,7MM	100	36450.156.007	28X10,2X1,5MM	50	36450.290.015	60X30,5X2,5MM	5	36450.630.025
15X8,2X0,7MM	100	36450.158.007	28X12,2X1,5MM	50	36450.292.015	60X30,5X3,0MM	5	36450.630.030
15X8,2X0,8MM	100	36450.158.008	28X14,2X1,25MM	50	36450.294.012	60X30,5X3,5MM	5	36450.630.035
18X6,2X0,4MM	100	36450.186.004	31,5X12,2X1,0MM	50	36450.327.010	70X25,5X2,0MM	5	36450.725.020
18X6,2X0,5MM	100	36450.186.005	31,5X12,2X1,25MM	50	36450.327.012	70X30,5X3,0MM	5	36450.730.030
18X6,2X0,6MM	100	36450.186.006	31,5X12,2X1,5MM	50	36450.327.015	70X35,5X3,0MM	5	36450.735.030
18X6,2X0,7MM	100	36450.186.007	31,5X16,3X1,5MM	50	36450.331.015	70X40,5X4,0MM	5	36450.740.040
18X6,2X0,8MM	100	36450.186.008	31,5X16,3X2,0MM	50	36450.331.020	70X40,5X5,0MM	5	36450.740.050
18X8,2X0,5MM	100	36450.188.005	34X12,2X1,0MM	25	36450.352.010	80X31,0X3,0MM	1	36450.831.030
18X8,2X0,7MM	100	36450.188.007	34X12,2X1,25MM	25	36450.352.012	80X36,0X3,0MM	1	36450.836.030
18X8,2X0,8MM	100	36450.188.008	34X12,2X1,5MM	25	36450.352.015	80x36,0x4,0MM	1	36450.836.040
18X8,2X1,0MM	100	36450.188.010	34X14,2X1,25MM	25	36450.354.012	80X41,0X4,0MM	1	36450.841.040

36450 Disc spring for critical applications								
$D_e \times D_i \times t$	☒	Art.number	$D_e \times D_i \times t$	☒	Art.number	$D_e \times D_i \times t$	☒	Art.number
100X41,0X4,0MM	1	36450.960.040	125X61,0X6,0MM	1	36450.987.065	200X92,0X10,0MM	1	36450.997.100
100X51,0X5,0MM	1	36450.982.050	150X61,0X6,0MM	1	36450.992.060	200X112,0X12,0MM	1	36450.997.120
125X51,0X6,0MM	1	36450.987.060	150X81,0X8,0MM	1	36450.992.080	250X127,0X16,0MM	1	36450.999.160

Ball bearing location disc spring

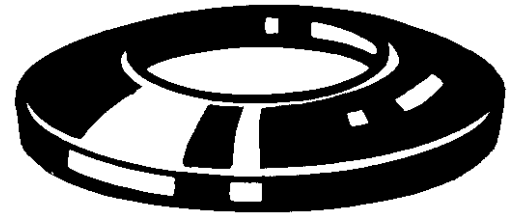
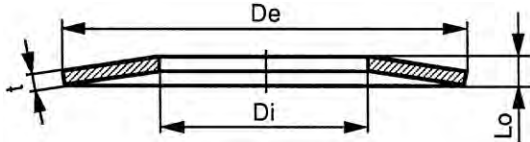

Technical Data

D_e (h12)	D_i (H12)	F	L_o	t	D_e (h12)	D_i (H12)	F	L_o	t
9.8	6.2	23	0.4	0.2	31.7	20.4	81	1.1	0.4
12.8	7.2	29	0.5	0.25	34.6	22.4	118	1.2	0.5
15.8	8.2	23	0.55	0.25	36.6	20.4	110	1.3	0.5
18.8	10.2	51	0.7	0.35	39.6	25.5	110	1.3	0.5
21.8	12.3	46	0.75	0.35	41.6	25.5	113	1.4	0.5
23.7	14.3	81	0.9	0.4	46.5	30.5	153	1.4	0.6
25.7	14.3	63	0.9	0.4	51.5	35.5	135	1.5	0.6
27.7	17.3	80	1	0.4	54.5	40.5	141	1.5	0.6
29.7	17.3	83	1.1	0.4	61.5	40.5	176	1.8	0.7

- F = spring force in Newton at a deflection $s \approx 0,75 h_o (h_o = L_o - t)$.
- Extensive technical data available on request.

Example of application

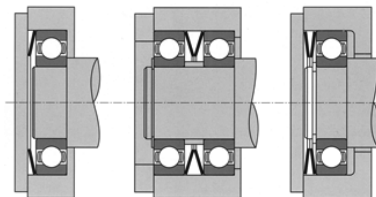

7

36460 Ball bearing location disc spring						L07C		
Material	Steel							
Surface treatment	Phosphated							



$D_e \times D_i \times t$	☒	Art.number	$D_e \times D_i \times t$	☒	Art.number	$D_e \times D_i \times t$	☒	Art.number
9,8X6,2X0,2MM	100	36460.104.002	25,7X14,3X0,4MM	50	36460.271.004	39,6X25,5X0,5MM	25	36460.421.005
12,8X7,2X0,25MM	100	36460.135.002	27,7X17,3X0,4MM	50	36460.294.004	41,6X25,5X0,5MM	25	36460.441.005
15,8X8,2X0,25MM	100	36460.166.002	29,7X17,3X0,4MM	50	36460.314.004	46,5X30,5X0,6MM	25	36460.495.006
18,8X10,2X0,35MM	50	36460.198.003	31,7X20,4X0,4MM	25	36460.337.004	51,5X35,5X0,6MM	10	36460.550.006
21,8X12,3X0,35MM	50	36460.230.003	34,6X22,4X0,5MM	25	36460.368.005	54,5X40,5X0,6MM	10	36460.585.006
23,7X14,3X0,4MM	50	36460.251.004	36,6X20,4X0,5MM	25	36460.386.005	61,5X40,5X0,7MM	10	36460.655.007

Locking disc spring type M

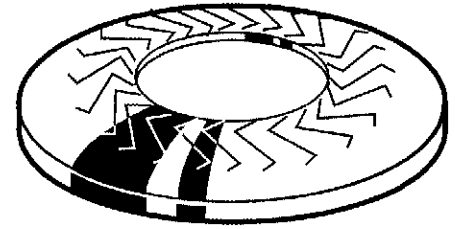
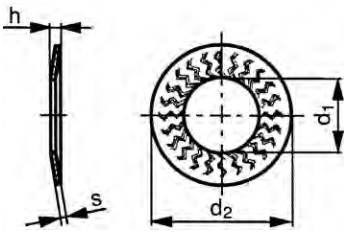

Technical Data

For nom.size	d ₁	d ₂	h	s
M4	4.1	10.2	1.5	1
M5	5.1	12.2	1.8	1.2
M6	6.1	14.2	2.2	1.4
M8	8.2	18.2	2.4	1.4
M10	10.2	22.25	2.75	1.6
M12	12.4	27.25	3.05	1.8
M14	14.4	30.25	3.5	2.4
M16	16.4	32.5	3.95	2.5

Article groups

Material	Surface treatment	Code	Page
Spring steel 420-510 HV10	FLZNNC-NC6	36325	7-93
St.St. A4		55443	7-93

36325 SK Locking disc spring type M		L07C
Material	Spring steel 420-510 HV10	
Surface treatment	Zinc flake Cr ⁶⁺ free - ISO 10683 flZnnc	

For nom. size	☒	Art.number	For nom. size	☒	Art.number	For nom. size	☒	Art.number
M5	250	36325.050.001	M10	200	36325.100.001	M14	100	36325.140.001
M6	250	36325.060.001	M12	150	36325.120.001	M16	100	36325.160.001
M8	200	36325.080.001						

- A ISO 10683 Zinc Flake surface coating eliminates the possibilities of damage which can arise due to hydrogen embrittlement.
- SK-locking disc springs, type M, can be used with fasteners class ≤ 10.9.

55443 SK Locking disc spring type M		R49A
Material	Stainless steel A4	

For nom. size	☒	Art.number	For nom. size	☒	Art.number	For nom. size	☒	Art.number
M4	250	55443.040.001	M8	200	55443.080.001	M12	100	55443.120.001
M5	250	55443.050.001	M10	200	55443.100.001	M16	100	55443.160.001
M6	250	55443.060.001						

- SK-locking disc springs, type M, can be used with stainless steel A2/A4 fasteners, up to and including class 80.

Locking disc spring type Z

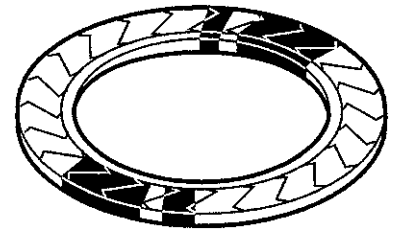
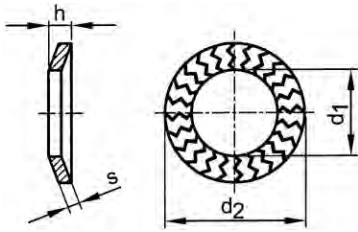

Technical Data

For nom.size	d ₁	d ₂	h	s
M6	6.1	9.9	1.6	1.4
M8	8.2	12.7	1.7	1.4
M10	10.2	16.1	2	1.6
M12	12.4	18.3	2.2	1.8
M16	16.4	24.6	3.1	2.5

- SK locking disc springs, type Z, can be used with hexagon socket head cap screws or cheese head screws, class ≤ 10.9.

36326	SK Locking disc spring type Z	L07C
Material	Spring steel 420-510 HV10	
Surface treatment	Zinc flake Cr ⁶⁺ free - ISO 10683 flZnnc	
		

For nom. size	☒	Art.number	For nom. size	☒	Art.number	For nom. size	☒	Art.number
M6	250	36326.060.001	M10	200	36326.100.001	M16	100	36326.160.001
M8	200	36326.080.001	M12	150	36326.120.001			

- A ISO 10683 Zinc Flake surface coating eliminates the possibilities of damage which can arise due to hydrogen embrittlement.

NORD-LOCK®

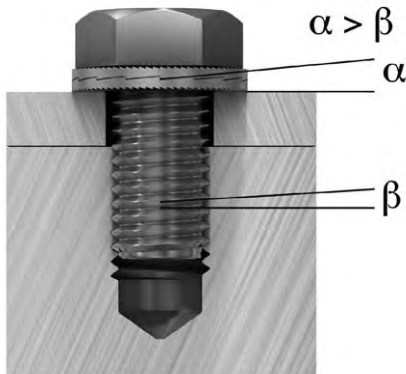

- Prevents loosening caused by vibration and dynamic loads
- Tension makes the bolt self locking
- Reusable
- No special tools required
- M3-M130 / UNC 1/4"-1" in steel Delta Protekt®
- M3-M80 / UNC 1/4"-1" in Stainless steel
- M3-M39 / UNC 1/4"-1" in 254 SMO®

Nord-Lock washers are available with standard and enlarged outer diameter (referred to as SP washers).

- SP washers are designed for use on large / slotted holes, painted / sensitive surfaces or soft materials.
- We advise to use Nord-Lock SP washers with flanged bolts or nuts for optimum load distribution.



7

Available in materials types:
Steel, Stainless Steel and 254 SMO®

Upon request:
INCONEL®/HASTELLOY® C-276 and INCONEL®718



- Prevents bolt loosening caused by vibration and dynamic loads.
- Compensates for loss of preload due to settlement and relaxation.
- One solution to cover multiple design challenges.
- M6-M20 in steel Delta Protekt®
- Standard and enlarged outer diameter (SP)

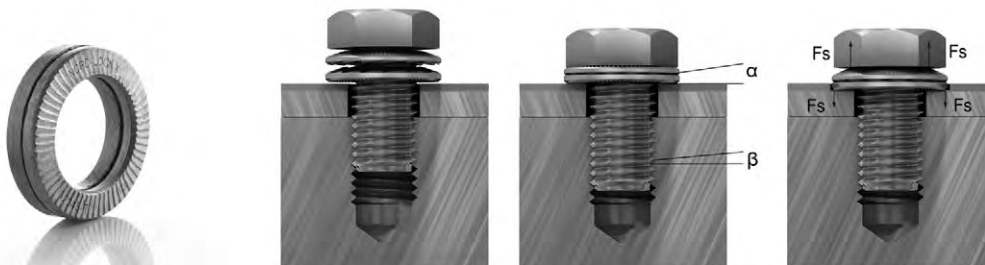

Nord-Lock washers are certified, approved and used in numerous industries worldwide such as: energy, transportation, offshore, mining and quarrying, construction and bridge building, manufacturing and processing, ship building, forestry and agriculture, heavy vehicles, and military.

Vibration proof washer flat

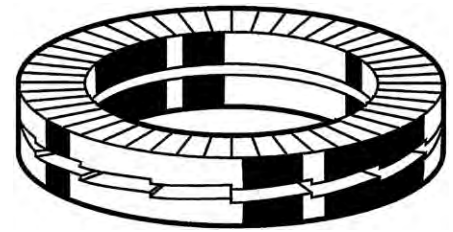
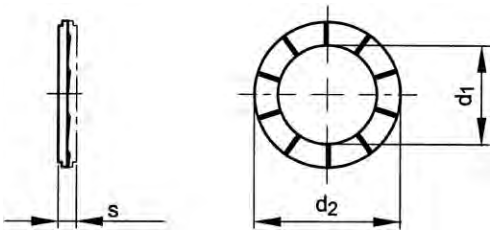

Technical Data

For nom.size	d ₁	d ₂	s (Set)	For nom.size	d ₁	d ₂	s (Set)
M3	3.4	7	2.2	M18	19.5	29	3.4
M3.5	3.9	7.6	2.2	M20	21.4	30.7	3.4
M4	4.4	7.6	2.2	M22	23.4	34.5	3.4
M5	5.4	9	2.2	M24	25.3	39	3.4
M6	6.5	10.8	2.2	M27	28.4	42	6.8
M8	8.7	13.5	2.5	M30	31.4	47	6.8
M10	10.7	16.6	2.5	M33	34.4	48.5	6.8
M11	11.4	18.5	2.5	M36	37.4	55	6.8
M12	13	19.5	2.5	M39	40.4	58.5	6.8
M14	15.2	23	3.4	M42	43.2	63	6.8
M16	17	25.4	3.4				

- For general information concerning NORD-LOCK vibration proof fasteners, see INFO-page.

Article groups

Material	Surface treatment		Code	Page
St	Delta Pro		37980	7-96
St	Delta Pro	Self service pack	37985	7-96
St.St. A4			55437	7-97
St.St. A4		Self service pack	55436	7-97
St.St. 254 SMO®			55463	7-97

7

37980 NORD-LOCK Vibration proof washer NL1A

Material: Steel
Surface treatment: Delta Protokt®

NORD-LOCK
Bolt securing system

For nom. size	☒	Art.number	For nom. size	☒	Art.number	For nom. size	☒	Art.number
M3	200	37980.030.001	M11	200	37980.110.001	M24	100	37980.240.001
M3,5	200	37980.035.001	M12	200	37980.120.001	M27	50	37980.270.001
M4	200	37980.040.001	M14	100	37980.140.001	M30	50	37980.300.001
M5	200	37980.050.001	M16	100	37980.160.001	M33	25	37980.330.001
M6	200	37980.060.001	M18	100	37980.180.001	M36	25	37980.360.001
M8	200	37980.080.001	M20	100	37980.200.001	M39	25	37980.390.001
M10	200	37980.100.001	M22	100	37980.220.001	M42	25	37980.420.001

37985 NORD-LOCK Vibration proof washer NL3A

Material: Steel
Surface treatment: Delta Protokt®

NORD-LOCK
Bolt securing system

For nom. size	☒	Art.number	For nom. size	☒	Art.number	For nom. size	☒	Art.number
M6 (20PC)	1	37985.060.001	M10 (20PC)	1	37985.100.001	M16 (8PC)	1	37985.160.001
M8 (20PC)	1	37985.080.001	M12 (10PC)	1	37985.120.001	M20 (4PC)	1	37985.200.001

55437 **NORD-LOCK Vibration proof washer** **NL1A**

Material Stainless steel A4

NORD-LOCK
Bolt securing system



For nom. size	☒	Art.number	For nom. size	☒	Art.number	For nom. size	☒	Art.number
M3	200	55437.030.001	M11	200	55437.110.001	M24	100	55437.240.001
M3,5	200	55437.035.001	M12	200	55437.120.001	M27	50	55437.270.001
M4	200	55437.040.001	M14	100	55437.140.001	M30	50	55437.300.001
M5	200	55437.050.001	M16	100	55437.160.001	M33	25	55437.330.001
M6	200	55437.060.001	M18	100	55437.180.001	M36	25	55437.360.001
M8	200	55437.080.001	M20	100	55437.200.001	M39	25	55437.390.001
M10	200	55437.100.001	M22	100	55437.220.001	M42	25	55437.420.001

55436 **NORD-LOCK Vibration proof washer** **NL3A**

Material Stainless steel A4

NORD-LOCK
Bolt securing system



For nom. size	☒	Art.number	For nom. size	☒	Art.number	For nom. size	☒	Art.number
M6 (10PC)	1	55436.060.001	M10 (10PC)	1	55436.100.001	M16 (4PC)	1	55436.160.001
M8 (10PC)	1	55436.080.001	M12 (6PC)	1	55436.120.001	M20 (3PC)	1	55436.200.001

55463 **NORD-LOCK Vibration proof washer** **NL1A**

Material Stainless steel 254 SMO®

NORD-LOCK
Bolt securing system



For nom. size	☒	Art.number	For nom. size	☒	Art.number	For nom. size	☒	Art.number
M3	200	55463.030.001	M11	200	55463.110.001	M24	100	55463.240.001
M3,5	200	55463.035.001	M12	200	55463.120.001	M27	50	55463.270.001
M4	200	55463.040.001	M14	100	55463.140.001	M30	50	55463.300.001
M5	200	55463.050.001	M16	100	55463.160.001	M33	25	55463.330.001
M6	200	55463.060.001	M18	100	55463.180.001	M36	25	55463.360.001
M8	200	55463.080.001	M20	100	55463.200.001	M39	25	55463.390.001
M10	200	55463.100.001	M22	100	55463.220.001			

Vibration proof washer flat imperial

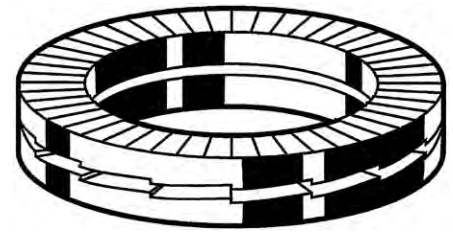
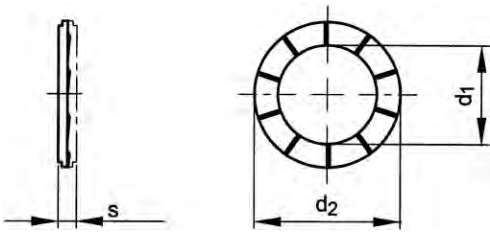

Technical Data

For nom. size	d ₁	d ₂	s (Set)
1/4	0.28	0.65	2.3
3/8	0.41	0.65	2.5
1/2	0.53	0.77	2.5
3/4	0.79	1.21	3.4
1 Inch	1.1	1.54	3.4

Article groups

Material	Surface treatment	Code	Page
St	Delta Pro	37979	7-98
St.St. A4		55438	7-98
St.St. 254 SMO®		55464	7-98

37979 NORD-LOCK Vibration proof washer flat imperial

NL1A

Material Steel
Surface treatment Delta Protekt®

NORD-LOCK
Bolt securing system



For nom. size	☒	Art.number	For nom. size	☒	Art.number	For nom. size	☒	Art.number
1/4	200	37979.063.001	1/2	200	37979.127.001	1 Inch	100	37979.254.001
3/8	200	37979.096.001	3/4	100	37979.191.001			

55438 NORD-LOCK Vibration proof washer flat imperial

NL1A

Material Stainless steel A4

NORD-LOCK
Bolt securing system

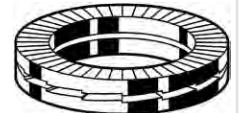

For nom. size	☒	Art.number	For nom. size	☒	Art.number	For nom. size	☒	Art.number
1/4	200	55438.063.001	1/2	200	55438.127.001	1 Inch	100	55438.254.001
3/8	200	55438.096.001	3/4	100	55438.191.001			

55464 NORD-LOCK Vibration proof washer

NL1A

Material Stainless steel 254 SMO®

NORD-LOCK
Bolt securing system



For nom. size	☒	Art.number	For nom. size	☒	Art.number	For nom. size	☒	Art.number
1/4	200	55464.063.001	1/2	200	55464.127.001	1 Inch	100	55464.254.001
3/8	200	55464.096.001	3/4	100	55464.191.001			

Vibration proof washer flat, large outside diameter

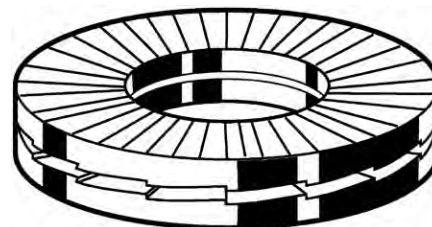
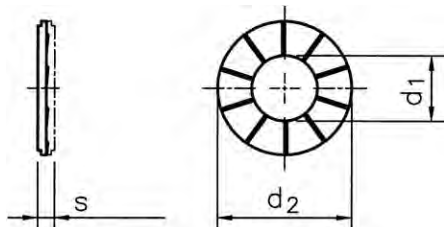

Technical Data

For nom.size	d ₁	d ₂	s (Set)	For nom.size	d ₁	d ₂	s (Set)
M3.5	3.9	9	2.2	M18	19.5	34.5	3.4
M4	4.4	9	2.2	M20	21.4	39	3.4
M5	5.4	10.8	2.2	M22	23.4	42	4.6
M6	6.5	13.5	2.5	M24	25.3	48.5	4.6
M8	8.7	16.6	2.5	M27	28.4	48.5	5.8
M10	10.7	21	2.5	M30	31.4	58.5	6.6
M12	13	25.4	3.4	M33	34.4	58.5	6.6
M14	15.2	30.7	3.4	M36	37.4	63	6.6
M16	17	30.7	3.4				

- For general information concerning NORD-LOCK vibration proof fasteners, see INFO-page.
- Vibration proof washers with large outside diameter are recommended for oversize and elongated holes, where a larger contact surface is required.

Article groups

Material	Surface treatment	Code	Page
St	Delta Pro	37982	7-99
St	Delta Pro	Self service pack	37986
St.St. A4		55453	7-100
St.St. A4		Self service pack	55456
St.St. 254 SMO®		55465	7-100

37982 NORD-LOCK Vibration proof washer large outside diameter

NL1A

Material Steel
Surface treatment Delta Protekt®

NORD-LOCK
Bolt securing system



For nom. size x d ₂	☒	Art.number	For nom. size x d ₂	☒	Art.number	For nom. size x d ₂	☒	Art.number
M3,5X9	200	37982.035.009	M12X25,4	100	37982.120.025	M24X48,5	50	37982.240.048
M4X9	200	37982.040.009	M14X30,7	100	37982.140.030	M27X48,5	25	37982.270.048
M5X10,8	200	37982.050.010	M16X30,7	100	37982.160.030	M30X58,5	25	37982.300.058
M6X13,5	200	37982.060.013	M18X34,5	100	37982.180.034	M33X58,5	25	37982.330.058
M8X16,6	200	37982.080.016	M20X39	100	37982.200.039	M36X63	25	37982.360.630
M10X21	200	37982.100.021	M22X42	50	37982.220.042			

- Warning: electro-galvanizing of these products may cause hydrogen embrittlement.

37986 NORD-LOCK Vibration proof washer large outside diameter

NL3A

Material Steel
Surface treatment Delta Protekt®

NORD-LOCK
Bolt securing system





For nom. size x d ₂	☒	Art.number	For nom. size x d ₂	☒	Art.number	For nom. size x d ₂	☒	Art.number
M6X13,5 (20PC)	1	37986.060.001	M10X21 (10PC)	1	37986.100.001	M16X30,7 (4PC)	1	37986.160.001
M8X16,6 (20PC)	1	37986.080.001	M12X25,4 (8PC)	1	37986.120.001	M20X39 (2PC)	1	37986.200.001

- Warning: electro-galvanizing of these products may cause hydrogen embrittlement.

55453 **NORD-LOCK Vibration proof washer large outside diameter** **NL1A**

Material Stainless steel A4

NORD-LOCK
Bolt securing system



 

For nom. size x d ₂	☒	Art.number	For nom. size x d ₂	☒	Art.number	For nom. size x d ₂	☒	Art.number
M3,5X9	200	55453.035.009	M10X21,0	200	55453.100.021	M20X39	100	55453.200.039
M4X9	200	55453.040.009	M12X25,4	100	55453.120.025	M22X42	50	55453.220.042
M5X10,8	200	55453.050.010	M14X30,7	100	55453.140.030	M24X48,5	50	55453.240.048
M6X13,5	200	55453.060.013	M16X30,7	100	55453.160.030	M27X48,5	25	55453.270.048
M8X16,6	200	55453.080.016	M18X34,5	100	55453.180.034	M30X58,5	25	55453.300.058

55456 **NORD-LOCK Vibration proof washer large outside diameter** **NL3A**

Material Stainless steel A4

NORD-LOCK
Bolt securing system



 

For nom. size x d ₂	☒	Art.number	For nom. size x d ₂	☒	Art.number	For nom. size x d ₂	☒	Art.number
M6X13,5 (10PC)	1	55456.060.001	M10X21 (6PC)	1	55456.100.001	M16X30,7 (2PC)	1	55456.160.001
M8X16,6 (10PC)	1	55456.080.001	M12X25,4 (4PC)	1	55456.120.001	M20X39 (2PC)	1	55456.200.001

55465 **NORD-LOCK Vibration proof washer large outside diameter** **NL1A**

Material Stainless steel 254 SMO®

NORD-LOCK
Bolt securing system

For nom. size x d ₂	☒	Art.number	For nom. size x d ₂	☒	Art.number	For nom. size x d ₂	☒	Art.number
M3,5X9	200	55465.035.009	M10X21,0	200	55465.100.021	M20X39,0	100	55465.200.039
M4X9	200	55465.040.009	M12X25,4	100	55465.120.025	M22X42,0	50	55465.220.042
M5X10,8	200	55465.050.010	M14X30,7	100	55465.140.030	M24X48,5	50	55465.240.048
M6X13,5	200	55465.060.013	M16X30,7	100	55465.160.030	M27X48,5	25	55465.270.048
M8X16,6	200	55465.080.016	M18X34,5	100	55465.180.034			

7

Vibration proof washer flat imperial large outside diameter

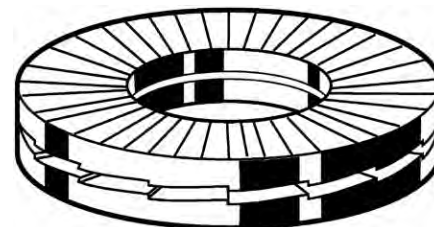
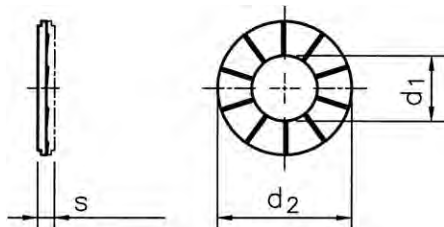

Technical Data

For nom.size	d ₁	d ₂	s (Set)
1/4	0.28	0.53	2.5
3/8	0.41	0.83	2.5
1/2	0.53	1.00	3.4
3/4	0.79	1.54	3.4
1 Inch	1.1	1.91	5.6

Article groups

Material	Surface treatment	Code	Page
St	Delta Pro	37984	7-101
St.St. A4		55454	7-101
St.St. 254 SMO®		55466	7-101

37984 NORD-LOCK Vibration proof washer flat imperial large outside diameter

NL1A

Material Steel
Surface treatment Delta Protekt®

NORD-LOCK
Bolt securing system



For nom. size x d ₂	☒	Art.number	For nom. size x d ₂	☒	Art.number	For nom. size x d ₂	☒	Art.number
1/4X13,5	200	37984.063.013	1/2X25,4	100	37984.127.025	1 InchX48,5	50	37984.254.048
3/8X21,0	200	37984.096.021	3/4X39,0	100	37984.191.039			

55454 NORD-LOCK Vibration proof washer flat imperial large outside diameter

NL1A

Material Stainless steel A4

NORD-LOCK
Bolt securing system



For nom. size x d ₂	☒	Art.number	For nom. size x d ₂	☒	Art.number	For nom. size x d ₂	☒	Art.number
1/4X13,5	200	55454.063.013	1/2X25,4	100	55454.127.025	1 InchX48,5	50	55454.254.048
3/8X21,0	200	55454.096.021	3/4X39,0	100	55454.191.039			

55466 NORD-LOCK Vibration proof washer flat imperial large outside diameter

NL1A

Material Stainless steel 254 SMO®

NORD-LOCK
Bolt securing system



For nom. size x d ₂	☒	Art.number	For nom. size x d ₂	☒	Art.number	For nom. size x d ₂	☒	Art.number
1/4X13,5	200	55466.063.013	1/2X25,4	100	55466.127.025	1 InchX48,5	50	55466.254.048
3/8X21,0	200	55466.096.021	3/4X39,0	100	55466.191.039			

Vibration proof washer conical

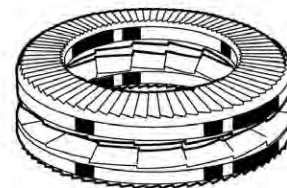
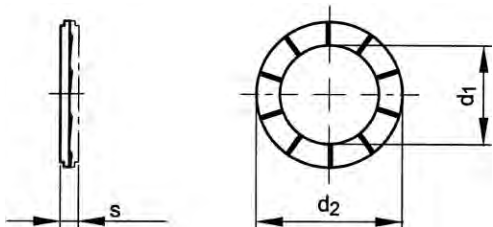

Technical Data

For nom.size	d ₁	d ₂	s (Set)
M6	6.3	10.8	2.2
M8	8.4	13.5	2.3
M10	10.5	16.6	3
M12	12.5	19.5	3.5
M14	14.6	23.0	4.05
M16	16.6	25.4	4.8
M20	20.7	30.7	6.1

37981 NORD-LOCK Vibration proof washer conical, X-series

NL1A

Material Steel
Surface treatment Delta Protokt®



For nom. size	☒	Art.number	For nom. size	☒	Art.number	For nom. size	☒	Art.number
M6	200	37981.060.001	M12	200	37981.120.001	M16	100	37981.160.001
M8	200	37981.080.001	M14	100	37981.140.001	M20	100	37981.200.001
M10	200	37981.100.001						

Vibration proof washer conical imperial

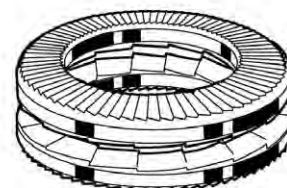
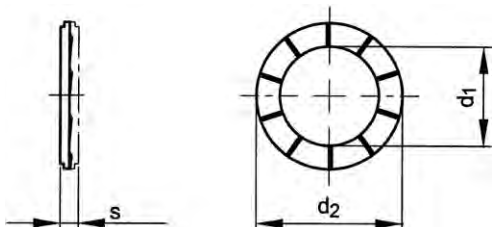

Technical Data

For nom.size	d ₁	d ₂	s (Set)
1/4	6.7	11.5	0.069
3/8	10.0	16.6	0.106
1/2	13.2	19.5	0.142

37987 NORD-LOCK Vibration proof washer conical imperial, X-series

NL1A

Material Steel
Surface treatment Delta Protokt®



For nom. size	☒	Art.number	For nom. size	☒	Art.number	For nom. size	☒	Art.number
1/4	200	37987.063.001	3/8	200	37987.096.001	1/2	200	37987.127.001

7

Vibration proof washer conical, large diameter, X-series

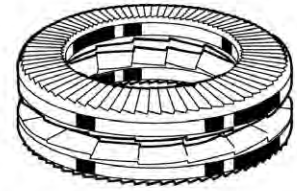
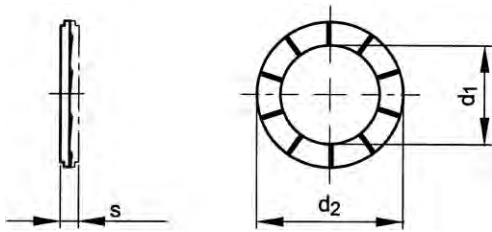

Technical Data

For nom.size	d ₁	d ₂	s (Set)
M6	6.3	13.5	1.74
M8	8.4	16.6	2.3
M10	10.5	21.0	3.5
M12	12.5	25.4	4.2
M16	16.6	30.7	4.8
M20	20.7	39.0	5.63

37983 NORD-LOCK Vibration proof washer conical, large diameter, X-series

NL1A

Material Steel
Surface treatment Delta Protekt®



For nom. size x d ₂	☒	Art.number	For nom. size x d ₂	☒	Art.number	For nom. size x d ₂	☒	Art.number
M6X13,5	200	37983.060.013	M10X21	200	37983.100.021	M16X30,7	100	37983.160.030
M8X16,6	200	37983.080.016	M12X25,4	100	37983.120.025	M20X39	100	37983.200.039

Vibration proof washer conical, large outside diameter inches, X-series

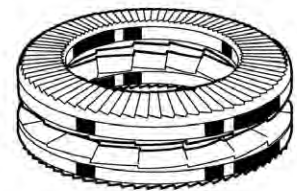
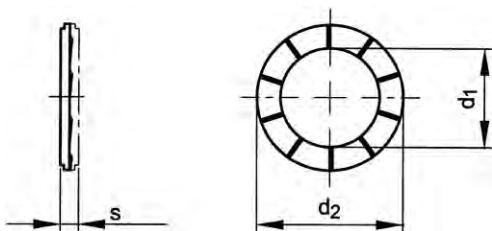

7

Technical Data

For nom.size	d ₁	d ₂	s (Set)
3/8	10.0	21.0	0.138
1/2	13.2	25.4	0.165

37988 NORD-LOCK Vibration proof washer conical, large outside diameter imperial, X-series

NL1A

Material Steel
Surface treatment Delta Protekt®



For nom. size x d ₂	☒	Art.number	For nom. size x d ₂	☒	Art.number
3/8X21	200	37988.096.021	1/2X25,4	100	37988.127.025

Locking disc spring type S

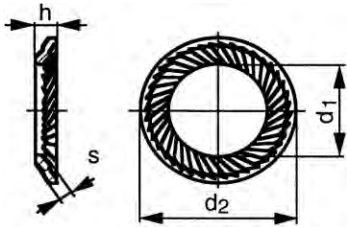

Technical Data

For nom.size	d ₁ (H14)	d ₂ (h14)	h (max.)	s
M2.5	2.7	4.8	0.9	0.45
M3	3.2	5.5	0.9	0.4 (0.45)
M4	4.3	7	1	0.5
M5	5.3	8.5 (9)	1.1	0.6
M6	6.4	10	1.2	0.7
M8	8.4	13	1.4	0.8
M10	10.5	16	1.6	1
M12	13	18	1.7	1 (1.1)
M14	15	21 (22)	2	1.2
M16	17	24	2.1	1.2 (1.3)
M18	19	27	2.3	1.5
M20	21	30	2.5	1.5
M22	23	33	2.7	1.5
M24	25.6	36	2.9	1.8
M27	28.6	39	3.1	2
M30	31.6	45	3.6	2

Special features of safety washers type S:

- contact first on the outside diameter, resulting in maximum leverage
- high vibration security due to the rib contact
- can be used with screws of property class ≤ 8.8

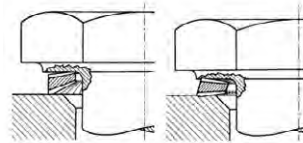

7

Article groups

Material	Surface treatment	Code	Page
Spring steel		36395	7-104
Spring steel		36390	7-105
Spring steel	large pack	36396	7-105
Spring steel	ZNTHP-NC6	36397	7-105
Spring steel	ZNTHP-NC6	36411	7-105
St.St. A2		51468	7-105

36395 Locking disc spring type S

L07A

Material Spring steel



For nom. size	⊗	Art.number	For nom. size	⊗	Art.number	For nom. size	⊗	Art.number
M3	500	36395.030.001	M6	500	36395.060.001	M12	250	36395.120.001
M4	500	36395.040.001	M8	250	36395.080.001	M14	100	36395.140.001
M5	500	36395.050.001	M10	250	36395.100.001	M16	100	36395.160.001

- Warning: electro-galvanizing of these products may cause hydrogen embrittlement.

36390 Safety washer type S		L07A	
Material	Spring steel	 	

For nom. size	☒	Art.number	For nom. size	☒	Art.number	For nom. size	☒	Art.number
M18	100	36390.180.001	M22	50	36390.220.001	M27	50	36390.270.001
M20	100	36390.200.001	M24	50	36390.240.001	M30	50	36390.300.001

• Warning: electro-galvanizing of these products may cause hydrogen embrittlement.

36396 Locking disc spring type S		L07A	
Material	Spring steel	 	

For nom. size	☒	Art.number	For nom. size	☒	Art.number	For nom. size	☒	Art.number
M3	2000	36396.030.001	M6	1000	36396.060.001	M12	500	36396.120.001
M4	1000	36396.040.001	M8	1000	36396.080.001	M14	500	36396.140.001
M5	1000	36396.050.001	M10	1000	36396.100.001	M16	500	36396.160.001

• Warning: electro-galvanizing of these products may cause hydrogen embrittlement.

36397 Locking disc spring type S		L07A	
Material	Spring steel	 	
Surface treatment	Galvanized thick Cr ³⁺ passivated		

For nom. size	☒	Art.number	For nom. size	☒	Art.number	For nom. size	☒	Art.number
M3	500	36397.030.001	M6	500	36397.060.001	M12	250	36397.120.001
M4	500	36397.040.001	M8	250	36397.080.001	M14	100	36397.140.001
M5	500	36397.050.001	M10	250	36397.100.001	M16	100	36397.160.001

• Warning: electro-galvanizing of these products may cause hydrogen embrittlement.

36411 Safety washer type S		L07A	
Material	Spring steel	 	
Surface treatment	Galvanized thick Cr ³⁺ passivated		

For nom. size	☒	Art.number	For nom. size	☒	Art.number	For nom. size	☒	Art.number
M18	100	36411.180.001	M22	50	36411.220.001	M27	50	36411.270.001
M20	100	36411.200.001	M24	50	36411.240.001	M30	50	36411.300.001

51468 Safety washer type S		R09A	
Material	Stainless steel A2	 	

For nom. size	☒	Art.number	For nom. size	☒	Art.number	For nom. size	☒	Art.number
M2,5	500	51468.025.001	M8	250	51468.080.001	M16	100	51468.160.001
M3	500	51468.030.001	M10	250	51468.100.001	M20	50	51468.200.001
M4	500	51468.040.001	M12	250	51468.120.001	M24	50	51468.240.001
M5	500	51468.050.001	M14	100	51468.140.001	M30	50	51468.300.001
M6	500	51468.060.001						

Locking disc spring type VS

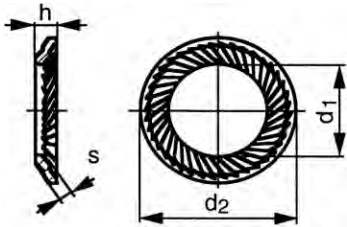

Technical Data

For nom.size	d ₁ (H14)	d ₂ (h14)	h (max.)	s
M5	5.3	9	1.3	1
M6	6.4	10	1.4	1
M8	8.4	13	1.7	1.2
M10	10.5	16	2	1.5
M12	13	18	2.1	1.5
M14	15	22	2.2	1.5
M16	17	24	2.6	2
M20	21	30	2.8	2
M24	25.6	36	3.4	2.5
M30	31.6	45	3.8	2.5

Special features of safety washers type VS:

- reinforced execution (increased metal thickness) resulting in considerably improved spring characteristics
- contact first on the outside diameter, resulting in maximum leverage
- high vibration security due to the rib contact
- can be used with screws of property class ≤ 10.9 and on hardened surface

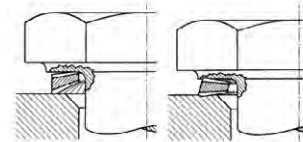



Article groups

Material	Surface treatment	Code	Page
Spring steel		36420	7-106
Spring steel	ZNTHP-NC6	36425	7-106

7

36420 Safety washer type VS		L07A
Material	Spring steel	
		
		

For nom. size	☒	Art.number	For nom. size	☒	Art.number	For nom. size	☒	Art.number
M5	500	36420.050.001	M12	250	36420.120.001	M20	100	36420.200.001
M6	500	36420.060.001	M14	100	36420.140.001	M24	50	36420.240.001
M8	250	36420.080.001	M16	100	36420.160.001	M30	50	36420.300.001
M10	250	36420.100.001						

36425 Safety washer type VS		L07A
Material	Spring steel	
Surface treatment	Galvanized thick Cr ³⁺ passivated	
		
		

For nom. size	☒	Art.number	For nom. size	☒	Art.number	For nom. size	☒	Art.number
M5	500	36425.050.001	M12	250	36425.120.001	M20	100	36425.200.001
M6	500	36425.060.001	M14	100	36425.140.001	M24	50	36425.240.001
M8	250	36425.080.001	M16	100	36425.160.001	M30	50	36425.300.001
M10	250	36425.100.001						

Contact-lock washer

NF E25-511

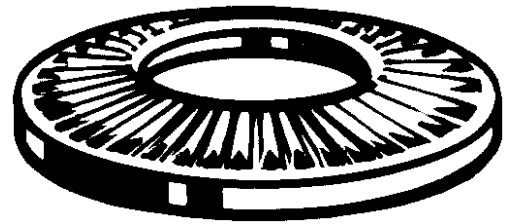
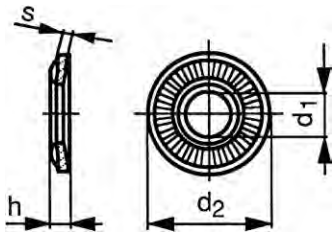

Technical Data

For nom.size	d ₁ (H14)	d ₂ (js 15)	h (max.)	s
M3	3.1	8	1	0.6
M4	4.1	10	1.4	0.9
M5	5.1	12	1.8	1.1
M6	6.1	14	2.1	1.3
M7 (≠NF)	7.2	18	2.4	1.4
M8	8.2	18	2.35	1.4
M10	10.2	22	2.75	1.6
M12	12.4	27	3.1	1.8
M16	16.4	32	4.1	2.8
M20	20.5	40	4.9	3.2

Special features FABORY contact-lock washers type medium:

- suitable for use simultaneously as lock washer and plain washer with oversize or elongated holes
- no damage to surface, exceptional locking action and high elasticity to compensate play or setting
- excellent contact in electrical appliances avoiding overheating
- applicable for bolts with a property class ≤ 10.9



37282 Contact-lock washer type medium

L07D

Material Spring steel
Surface treatment Galvanized thick Cr³⁺ passivated



For nom. size	☒	Art.number	For nom. size	☒	Art.number	For nom. size	☒	Art.number
M3	200	37282.030.001	M6	100	37282.060.001	M12	100	37282.120.001
M4	200	37282.040.001	M8	100	37282.080.001	M16	100	37282.160.001
M5	100	37282.050.001	M10	100	37282.100.001	M20	100	37282.200.001

Contact-lock washer type P

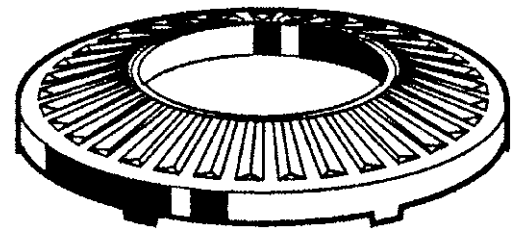
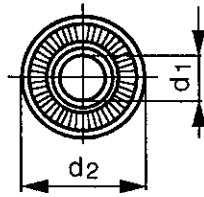
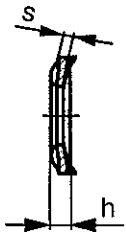

Technical Data

For nom.size	d ₁ (H14)	d ₂ (js 15)	h (max.)	s
M4	4.1	8	1.15	0.8
M5	5.1	10	1.5	1
M6	6.1	12	1.8	1.2
M8	8.2	16	2.4	1.4
M10	10.2	20	2.6	1.6
M12	12.4	24	2.6	1.6

- Special features of contact-lock washers type P:
- Suitable for use simultaneously as lock washer and plain washer with oversize or elongated holes
- No damage to surface, exceptional locking action and high elasticity to compensate play or setting
- Excellent contact in electrical appliances avoiding overheating
- Provided with six sharp points (height 0,3 mm), they penetrate the possible coat of laquer and will provide an excellent earthing
- Applicable for bolts with a property class ≤ 10.9

37265 Contact-lock washer type P

L07D

Material Spring steel
Surface treatment Galvanized thick Cr³⁺ passivated

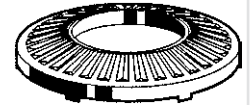

For nom. size	☒	Art.number	For nom. size	☒	Art.number	For nom. size	☒	Art.number
M4	200	37265.040.001	M6	100	37265.060.001	M10	100	37265.100.001
M5	100	37265.050.001	M8	100	37265.080.001	M12	100	37265.120.001

Retaining ring for hexagon bolt and nut



Technical Data

For nom.size	d	D	H	Type	V1 (min.)
M3	3.2	8	2.2	98/198	5
M4	4.15	9.5	2.6	99/199	6
M5	5.15	10.6	3	100/200	7
M6	6.2	12.7	3.5	101/201	8.5
M7	7.1	14.5	3.8	202	9
M8	8.1	16.2	4	102/203	10.5
M10	10.2	19.6	4.5	205	12.5
M12	12.2	23.6	5	207	14.5
M14	14.2	25.4	5.5	208	16.5
M16	16.2	29.4	6	211	19
M18	18.2	35.1	6.5	213	21.5
M20	20.3	35.7	7	215	23
M22	22.5	41.6	7.5	111/217	24.5
M24	24.3	41.6	8	219	26
M27	27.3	47.3	8.5	114/222	28.5
M30	30.2	53.1	8.5	115/225	30.5
M33	33.2	57.7	9	117/228	34
M36	36.2	63.5	10	119/231	38
M39	39.2	69.3	11	121/234	41
M45	45.2	80.8	16	125/240	51

Special features DUBO retaining rings:

- locks, because the retaining ring forms itself around the hexagon
- seals, because the ring is pressed into the thread and bolt hole
- reduces noise, because the plastic-elastic behaviour absorbs vibrations
- insulates against electrolytic contact corrosion by connection of different metals
- temperature resistant from -60°C to +120°C with static load and from -60°C to +80°C with dynamic load
- hexagon nuts and bolts from class 8.8 resp. 8 and above, DUBO retaining rings have to be used together with a steel DUBO toothed collar ring

Assembly date / Example of application

without toothed collar ring

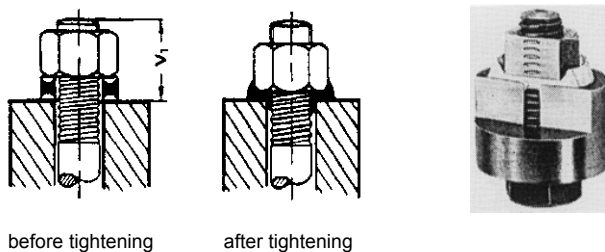

before tightening

after tightening

Article groups

Material	Class		Color	Code	Page
Plastic PA	6.6		White	37900	7-110
Plastic PA	6.6	large pack	White	37910	7-110

37900	DUBO Retaining ring for hexagon bolt and nut	W05C
Material	Plastic Polyamide (nylon)	 
Class	6.6	
Color	White	

For nom. size	☒	Art.number	For nom. size	☒	Art.number	For nom. size	☒	Art.number
M3	100	37900.030.001	M12	50	37900.120.001	M27	10	37900.270.001
M4	100	37900.040.001	M14	50	37900.140.001	M30	5	37900.300.001
M5	100	37900.050.001	M16	50	37900.160.001	M33	5	37900.330.001
M6	100	37900.060.001	M18	25	37900.180.001	M36	5	37900.360.001
M7	100	37900.070.001	M20	25	37900.200.001	M39	5	37900.390.001
M8	100	37900.080.001	M22	10	37900.220.001	M45	5	37900.450.001
M10	100	37900.100.001	M24	10	37900.240.001			

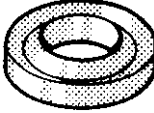
37910	DUBO Retaining ring for hexagon bolt and nut	W05C
Material	Plastic Polyamide (nylon)	 
Class	6.6	
Color	White	

For nom. size	☒	Art.number	For nom. size	☒	Art.number	For nom. size	☒	Art.number
M4	1000	37910.040.001	M8	1000	37910.080.001	M12	500	37910.120.001
M5	1000	37910.050.001	M10	1000	37910.100.001	M16	250	37910.160.001
M6	1000	37910.060.001						

Retaining ring for hexagon socket head cap screw

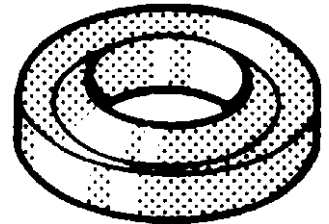
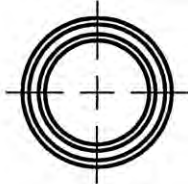
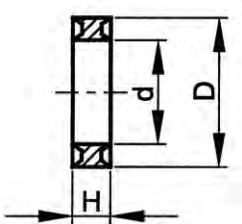

Technical Data

For nom.size	d	D	H
M4	4.1	7.7	2
M5	5.15	9.8	3
M6	6.5	10.5	2.5
M8	8.1	14	3.3
M10	10.2	17	3.8
M12	12.2	19	4.4
M14	14.2	23	5.2
M16	16.2	25	5.6
M20	20.2	31.5	6.5

7

Special features DUBO retaining rings:

- locks, because the retaining ring forms itself around the socket head
- seals, because the ring is pressed into the thread and bolt hole
- reduces noise, because the plastic-elastic behaviour absorbs vibrations
- insulates against electrolytic contactcorrosion by connection of different metals
- temperature resistant from -60°C to +120°C with static load and from -60°C to +80°C with dynamic load
- **overhead** hexagon socket head cap screws from class 8.8 and above, DUBO retaining rings have to be used together with a steel DUBO toothed collar ring

Example of application

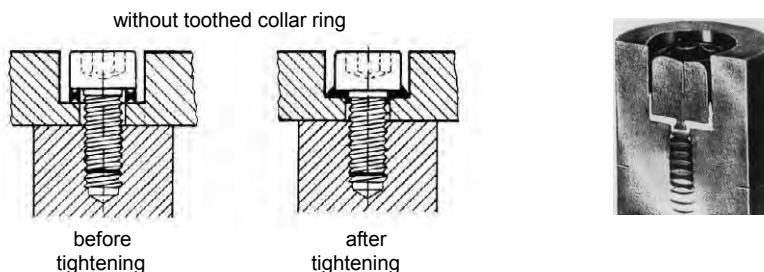

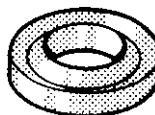
37901	DUBO Retaining ring for hexagon socket head cap screw			W05C
Material Class	Plastic Polyamide (nylon) 6			 

For nom. size	☒	Art.number	For nom. size	☒	Art.number	For nom. size	☒	Art.number
M4	100	37901.040.001	M8	100	37901.080.001	M14	50	37901.140.001
M5	100	37901.050.001	M10	100	37901.100.001	M16	50	37901.160.001
M6	100	37901.060.001	M12	50	37901.120.001	M20	25	37901.200.001

Toothed collar ring



Technical Data				
For nom.size	d	D	h	V2
M4-M5	6.8	11.2	3.15	3.15
M6	9	13.2	4.15	9.25
M8	12	17.2	4.8	11.5
M10	13.5	21.3	5.7	13.5
M12	15.5	24.5	6	16
M16	21	31.25	6.75	20.75
M18-M20	26	37.5	7.25	23.25-24.75
3/4	27	39.5	7.25	24.75
M22-M24	30.5	44	8	26.5-28
M27	35	50.5	9	30.5
M30	40	56	10	-
M33	45	61	10.5	-
M36	50	67	11.05	-

Assembly data

Hexagon bolts, - nuts and overhead hexagon socket head cap screws from class 8.8 resp. 8 and above, DUBO retaining rings have to be used together with a steel DUBO internal toothed collar ring.

Article number	Application with			
	Hexagon bolts and - nuts		Overhead hexagon socket head cap screws	
	Metric	Non metric	Metric	Non metric
37920.040.001	M4 - M5	5/32 - 3/16	M6	1/4
37920.060.001	M6	1/4	-	-
37920.080.001	M8	5/16	M10	3/8
37920.100.001	M10	3/8	M12	1/2
37920.120.001	M12	7/16	M14	-
37920.160.001	M16	-	M18	-
37920.180.001	M18 - M20	-	M22	7/8
37920.191.001	-	3/4	M24	-
37920.220.001	M22 - M24	7/8	-	-
37920.270.001	M27	1.IN. - 1.1/16	-	-
37920.300.001	M30	1.1/8	-	-
37920.330.001	M33	1.1/4	-	-
37920.360.001	M36	1.1/2	-	-

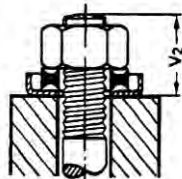

before tightening



after tightening

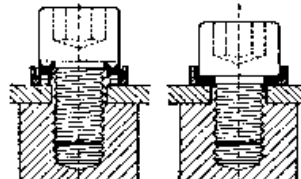

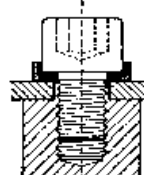

before tightening



after tightening

7

37920	DUBO Toothed collar ring	W05C
Material	Steel	
Surface treatment	Zinc plated	
	  	

For nom. size	☒	Art.number	For nom. size	☒	Art.number	For nom. size	☒	Art.number
M4/5	100	37920.040.001	M12	50	37920.120.001	M27	10	37920.270.001
M6	100	37920.060.001	M16	50	37920.160.001	M30	5	37920.300.001
M8	100	37920.080.001	M18/20	25	37920.180.001	M33	5	37920.330.001
M10	100	37920.100.001	M22/24	25	37920.220.001	M36	5	37920.360.001

Tab washer with long tab

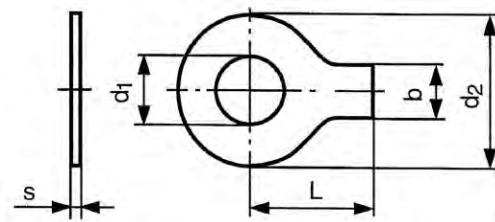

DIN 93
NEN 2277

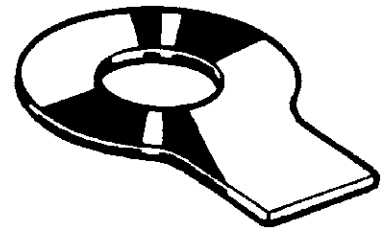

Technical Data

For nom.size	b	d ₁	d ₂	L	s
M4	5	4.3	14	14	0.38
M5	6	5.3	17	16	0.5
M6	7	6.4	19	18	0.5
M8	8	8.4	22	20	0.75
M10	10	10.5	26	22	0.75
M12	12	13	30	28	1
M14	12	15	33	28	1
M16	15	17	36	32	1
M18	18	19	40	36	1
M20	18	21	42	36	1
M22	20	23	50	42	1
M24	20	25	50	42	1
M27	23	28	58	48	1.6
M30	26	31	63	52	1.6
M33	28	34	68	56	1.6
M36	30	37	75	60	1.6
M39	32	40	82	64	1.6
M42	35	43	88	70	1.6
M45	38	46	95	75	1.6
M48	40	50	100	80	1.6
M52	44	54	108	85	1.6

Example of application

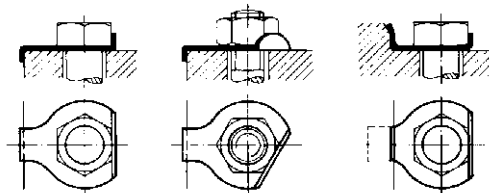

7

Article groups

Material	Code	Page
St	38650	7-113
St.St. A2	51540	7-114
St.St. A4	55540	7-114

38650 Tab washer with long tab

L07J

Material Steel



For nom. size	☒	Art.number	For nom. size	☒	Art.number	For nom. size	☒	Art.number
M6	100	38650.060.001	M20	50	38650.200.001	M36	10	38650.360.001
M8	100	38650.080.001	M22	50	38650.220.001	M39	10	38650.390.001
M10	100	38650.100.001	M24	25	38650.240.001	M42	10	38650.420.001
M12	100	38650.120.001	M27	25	38650.270.001	M45	10	38650.450.001
M14	100	38650.140.001	M30	10	38650.300.001	M48	10	38650.480.001
M16	100	38650.160.001	M33	10	38650.330.001	M52	10	38650.520.001
M18	50	38650.180.001						

51540 Tab washer with long tab R09A

Material: Stainless steel A2



For nom. size	☒	Art.number	For nom. size	☒	Art.number	For nom. size	☒	Art.number
M4*	500	51540.040.001	M14	100	51540.140.001	M27	25	51540.270.001
M5*	500	51540.050.001	M16	100	51540.160.001	M30	10	51540.300.001
M6	100	51540.060.001	M18*	200	51540.180.001	M36*	50	51540.360.001
M8	100	51540.080.001	M20	50	51540.200.001	M39*	25	51540.390.001
M10	100	51540.100.001	M22*	100	51540.220.001			
M12	100	51540.120.001	M24	25	51540.240.001			

55540 Tab washer with long tab R49A

Material: Stainless steel A4



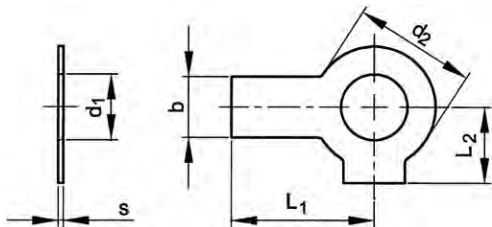

For nom. size	☒	Art.number	For nom. size	☒	Art.number	For nom. size	☒	Art.number
M4*	500	55540.040.001	M14	100	55540.140.001	M27	25	55540.270.001
M5*	500	55540.050.001	M16	100	55540.160.001	M30	10	55540.300.001
M6	100	55540.060.001	M18*	200	55540.180.001	M33	10	55540.330.001
M8	100	55540.080.001	M20	50	55540.200.001	M36*	50	55540.360.001
M10	100	55540.100.001	M22	25	55540.220.001	M39*	25	55540.390.001
M12	100	55540.120.001	M24	25	55540.240.001			

Tab washer with long tab and wing

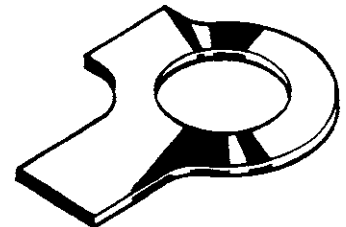

DIN 463
NEN 2278



Technical Data

For nom.size	b	d ₁	d ₂	L ₁	L ₂	s
M4	5	4.3	9	14	6.5	0.38
M5	6	5.3	10	16	8	0.5
M6	7	6.4	12.5	18	9	0.5
M8	8	8.4	17	20	11	0.75
M10	10	10.5	21	22	13	0.75
M12	12	13	24	28	15	1
M14	12	15	28	28	16	1
M16	15	17	30	32	18	1
M18	18	19	34	36	20	1
M20	18	21	37	36	21	1
M22	20	23	39	42	23	1
M24	20	25	44	42	25	1
M27	23	28	50	48	29	1.6
M30	26	31	56	52	32	1.6
M33	28	34	60	56	34	1.6
M36	30	37	66	60	38	1.6
M39	32	40	72	64	41	1.6
M42	35	43	78	70	44	1.6

Example of application

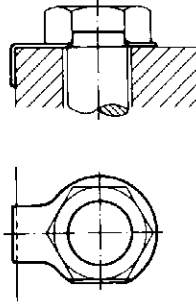

Article groups

Material	Code	Page
St	38690	7-115
St.St. A2	51910	7-115
St.St. A4	55910	7-115

38690 Tab washer with long tab and wing L07J

Material: Steel



For nom. size	☒	Art.number	For nom. size	☒	Art.number	For nom. size	☒	Art.number
M6	100	38690.060.001	M18	50	38690.180.001	M33	10	38690.330.001
M8	100	38690.080.001	M20	50	38690.200.001	M36	10	38690.360.001
M10	100	38690.100.001	M22	25	38690.220.001	M39	10	38690.390.001
M12	100	38690.120.001	M24	25	38690.240.001	M42	10	38690.420.001
M14	100	38690.140.001	M27	25	38690.270.001			
M16	100	38690.160.001	M30	10	38690.300.001			

51910 Tab washer with long tab and wing R09A



Material: Stainless steel A2



For nom. size	☒	Art.number	For nom. size	☒	Art.number	For nom. size	☒	Art.number
M5*	100	51910.050.001	M16	50	51910.160.001	M30	10	51910.300.001
M6	100	51910.060.001	M18*	50	51910.180.001	M33	10	51910.330.001
M8	50	51910.080.001	M20	50	51910.200.001	M36*	10	51910.360.001
M10	50	51910.100.001	M22*	25	51910.220.001	M39*	10	51910.390.001
M12	50	51910.120.001	M24	25	51910.240.001			
M14	50	51910.140.001	M27	25	51910.270.001			

55910 Tab washer with long tab and wing R49A

Material: Stainless steel A4

For nom. size	☒	Art.number	For nom. size	☒	Art.number	For nom. size	☒	Art.number
M4*	100	55910.040.001	M14	50	55910.140.001	M27	25	55910.270.001
M5*	100	55910.050.001	M16	50	55910.160.001	M30	10	55910.300.001
M6	100	55910.060.001	M18*	50	55910.180.001	M33	10	55910.330.001
M8	50	55910.080.001	M20	50	55910.200.001	M36*	10	55910.360.001
M10	50	55910.100.001	M22*	25	55910.220.001	M39*	10	55910.390.001
M12	50	55910.120.001	M24	25	55910.240.001			

Internal tab washer

DIN 462

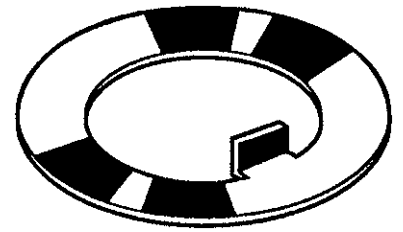
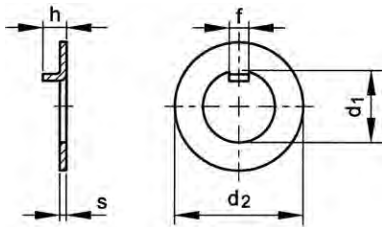

Technical Data

d ₁ (H11)	d ₂ (h11)	f (C11)	h	n (H11)	s	t (max.)
10	25	4	3	4	0.8	7.3
12	28	5	3	5	0.8	9.2
14	30	5	3	5	0.8	11.3
16	32	5	3	5	1	13.4
18	34	6	4	6	1	15.3
20	36	6	4	6	1	17.4
22	40	6	4	6	1	19.4
24	42	6	4	6	1	21.5
26	45	7	5	7	1	23.4
28	50	7	5	7	1	25.4
30	50	7	5	7	1.2	27.4
32	52	7	5	7	1.2	29.5
35	55	7	5	7	1.2	32.5
38	58	8	5	8	1.2	35.2
40	62	8	5	8	1.2	37.2
42	62	8	5	8	1.2	39.2
45	68	8	5	8	1.2	42.2
48	75	8	5	8	1.2	45.2
50	75	8	5	8	1.2	47.2
55	80	10	6	10	1.2	52.1
58	90	10	6	10	1.5	55.1
60	90	10	6	10	1.5	57.1
62	95	10	6	10	1.5	59.1
65	95	10	6	10	1.5	62.2
68	100	10	6	10	1.5	65.2
70	100	10	6	10	1.5	67.2
72	110	10	7	10	1.5	68.7
75	110	10	7	10	1.5	71.7
80	115	10	7	10	1.5	76.7
85	120	10	7	10	1.5	81.7
90	130	10	7	10	1.5	86.7
95	135	12	8	12	1.5	91.6
100	145	12	8	12	1.5	96.7

7

Example of application / Assembly data

slotted round nut for hookspanners acc. to DIN 1804W

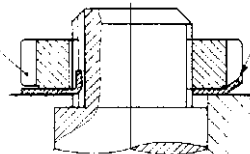

internal tab washer acc. to DIN 462

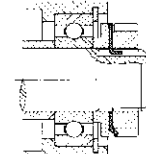
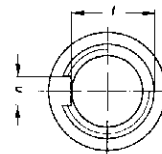

38684 Internal tab washer

L07J

Material Steel
Surface treatment Zinc plated



d ₁	☒	Art.number	d ₁	☒	Art.number	d ₁	☒	Art.number
10MM	100	38684.100.001	20MM	50	38684.200.001	30MM	25	38684.300.001
12MM	100	38684.120.001	22MM	50	38684.220.001	32MM	25	38684.320.001
14MM	50	38684.140.001	24MM	25	38684.240.001	35MM	25	38684.350.001
16MM	50	38684.160.001	26MM	25	38684.260.001	38MM	25	38684.380.001
18MM	50	38684.180.001	28MM	25	38684.280.001	40MM	25	38684.400.001

38684 Internal tab washer								
d_1	☒	Art.number	d_1	☒	Art.number	d_1	☒	Art.number
42MM	25	38684.420.001	60MM	5	38684.600.001	75MM	5	38684.750.001
45MM	25	38684.450.001	62MM	5	38684.620.001	80MM	5	38684.800.001
48MM	25	38684.480.001	65MM	5	38684.650.001	85MM	5	38684.850.001
50MM	25	38684.500.001	68MM	5	38684.680.001	90MM	5	38684.900.001
55MM	25	38684.550.001	70MM	5	38684.700.001	95MM	5	38684.950.001
58MM	25	38684.580.001	72MM	5	38684.720.001	100MM	5	38684.982.001

External tab washer

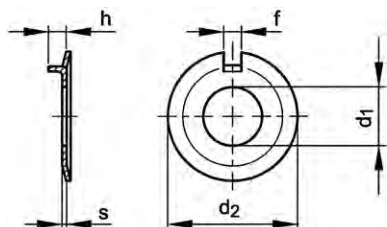

DIN 432
NEN 2279

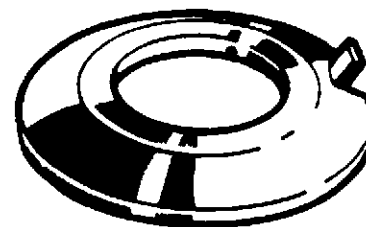

Technical Data

Nom.size shaft d_1	d_1	d_2	f	$h \approx$	s
M4	4.3	14	2.5	2	0.4
M5	5.3	17	3.5	2.5	0.75
M6	6.4	19	3.5	3	0.75
M8	8.4	22	3.5	4	1
M10	10.5	26	4.5	4	1
M12	13	30	4.5	4.5	1.2
M14	15	33	4.5	4.5	1.2
M16	17	36	5.5	4.5	1.2
M18	19	40	6.5	4.5	1.2
M20	21	42	6.5	4.5	1.6
M22	23	50	7.5	6.5	1.6
M24	25	50	7.5	6.5	1.6
M27	28	58	8.5	9.5	1.6
M30	31	63	8.5	9.5	1.6
M33	34	68	9.5	9.5	1.6
M36	37	75	11	9.5	2
M39	40	82	11	11	2
M42	43	88	11	11	2
M45	46	95	13	12	2
M48	50	100	13	13	2
M52	54	105	13	13	2
M56	58	112	16	14	2.5
M60	62	118	16	13.5	2.5
M64	66	125	18	13.5	2.5

Example of application

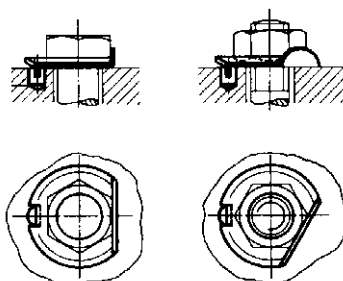

Article groups

Material	Code	Page
St	38670	7-118
St.St. A2	51914	7-118
St.St. A4	55914	7-118

38670 External tab washer L07J

Material: Steel



For nom. size	☒	Art.number	For nom. size	☒	Art.number	For nom. size	☒	Art.number
M6	100	38670.060.001	M22	50	38670.220.001	M42	10	38670.420.001
M8	100	38670.080.001	M24	25	38670.240.001	M45	10	38670.450.001
M10	100	38670.100.001	M27	25	38670.270.001	M48	10	38670.480.001
M12	100	38670.120.001	M30	10	38670.300.001	M52	10	38670.520.001
M14	100	38670.140.001	M33	10	38670.330.001	M56	5	38670.560.001
M16	100	38670.160.001	M36	10	38670.360.001	M60	5	38670.600.001
M18	50	38670.180.001	M39	10	38670.390.001	M64	5	38670.640.001
M20	50	38670.200.001						

51914 External tab washer R09A

Material: Stainless steel A2

For nom. size	☒	Art.number	For nom. size	☒	Art.number	For nom. size	☒	Art.number
M4*	100	51914.040.001	M14*	50	51914.140.001	M24*	25	51914.240.001
M5*	100	51914.050.001	M16*	50	51914.160.001	M27*	25	51914.270.001
M6*	100	51914.060.001	M18*	50	51914.180.001	M30*	25	51914.300.001
M8*	100	51914.080.001	M20*	50	51914.200.001	M33*	10	51914.330.001
M10*	100	51914.100.001	M22*	25	51914.220.001	M36*	10	51914.360.001

55914 External tab washer R49A

Material: Stainless steel A4

For nom. size	☒	Art.number	For nom. size	☒	Art.number	For nom. size	☒	Art.number
M5*	100	55914.050.001	M14*	50	55914.140.001	M22*	25	55914.220.001
M6*	100	55914.060.001	M16*	50	55914.160.001	M24*	25	55914.240.001
M8*	100	55914.080.001	M18*	50	55914.180.001	M27*	25	55914.270.001
M10*	100	55914.100.001	M20*	50	55914.200.001	M30*	25	55914.300.001
M12*	50	55914.120.001						

7

Retaining ring for shaft - normal type

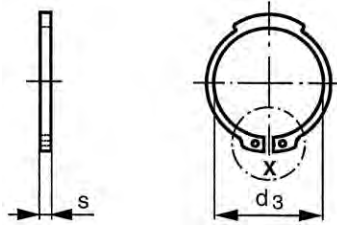

DIN 471
NF E22-163
BS 3673-4



Technical Data

Nom. size shaft d_1	Groove d_2	Groove m (H13)	Groove n (min.)	Ring d_3	Ring d_4	Ring s
3	2.8	0.5	0.3	2.7	7	0.4
4	3.8	0.5	0.3	3.7	8.6	0.4
5	4.8	0.7	0.3	4.7	10.3	0.6
6	5.7	0.8	0.5	5.6	11.7	0.7
7	6.7	0.9	0.5	6.5	13.5	0.8
8	7.6	0.9	0.6	7.4	14.7	0.8
9	8.6	1.1	0.6	8.4	16	1
10	9.6	1.1	0.6	9.3	17	1
11	10.5	1.1	0.8	10.2	18	1
12	11.5	1.1	0.8	11	19	1
13	12.4	1.1	0.9	11.9	20.2	1
14	13.4	1.1	0.9	12.9	21.4	1
15	14.3	1.1	1.1	13.8	22.6	1
16	15.2	1.1	1.2	14.7	23.8	1
17	16.2	1.1	1.2	15.7	25	1
18	17	1.3	1.5	16.5	26.2	1.2
19	18	1.3	1.5	17.5	27.2	1.2
20	19	1.3	1.5	18.5	28.4	1.2
21	20	1.3	1.5	19.5	29.6	1.2
22	21	1.3	1.5	20.5	30.8	1.2
23 (#DIN)	22	1.3	1.5	21.5	31	1.2
24	22.9	1.3	1.7	22.2	33.2	1.2
25	23.9	1.3	1.7	23.2	34.2	1.2
26	24.6	1.3	1.7	24.2	35.5	1.2
27 (#DIN)	25.9	1.3	2.1	24.9	35.4	1.2
28	26.6	1.6	2.1	25.9	37.9	1.5
29	27.6	1.6	2.1	26.9	39.1	1.5
30	28.6	1.6	2.1	27.9	40.5	1.5
31 (#DIN)	29.3	1.6	2.6	28.6	40.3	1.5
32	30.3	1.6	2.6	29.6	43	1.5
33 (#DIN)	31.3	1.6	2.6	30.5	43.4	1.5
34	32.3	1.6	2.6	31.5	45.4	1.5
35	33	1.6	3	32.2	46.8	1.5
36	34	1.85	3	33.2	47.8	1.75
37 (#DIN)	35	1.85	3	34.2	48	1.75
38	36	1.85	3	35.2	50.2	1.75
39 (#DIN)	37	1.85	3	36	50.2	1.75
40	37.5	1.85	3.8	36.5	52.6	1.75
42	39.5	1.85	3.8	38.5	55.7	1.75
44 (#DIN)	41.5	1.85	3.8	40.5	56	1.75
45	42.5	1.85	3.8	41.5	59.1	1.75
46	43.5	1.85	3.8	42.5	60.2	1.75
47 (#DIN)	44.5	1.85	3.8	43.5	61.3	1.75
48	45.5	1.85	3.8	44.5	62.5	1.75
50	47	2.15	4.5	45.8	64.5	2
52	49	2.15	4.5	47.8	66.7	2
54 (#DIN)	51	2.15	4.5	49.8	67	2
55	52	2.15	4.5	50.8	70.2	2
56	53	2.15	4.5	51.8	71.6	2
57 (#DIN)	54	2.15	4.5	52.8	70	2
58	55	2.15	4.5	53.8	73.6	2
60	57	2.15	4.5	55.8	75.6	2
62	59	2.15	4.5	57.8	77.8	2
63	60	2.15	4.5	58.8	79	2
65	62	2.65	4.5	60.8	81.4	2.5
67 (#DIN)	64	2.65	4.5	62.5	82	2.5
68	65	2.65	4.5	63.5	84.8	2.5

Technical Data						
Nom.size shaft d_1	Groove d_2	Groove m (H13)	Groove n (min.)	Ring d_3	Ring d_4	Ring s
70	67	2.65	4.5	65.5	87	2.5
72	69	2.65	4.5	67.5	89.2	2.5
75	72	2.65	4.5	70.5	92.7	2.5
77 (#DIN)	74	2.65	4.5	72.5	94	2.5
78	75	2.65	4.5	73.5	96.1	2.5
80	76.5	2.65	5.3	74.5	98.1	2.5
82	78.5	2.65	5.3	76.5	100.3	2.5
85	81.5	3.15	5.3	79.5	103.3	3
87 (#DIN)	83.5	3.15	5.3	81.5	104	3
88	84.5	3.15	5.3	82.5	106.5	3
90	86.5	3.15	5.3	84.5	108.5	3
92 (#DIN)	88.5	3.15	5.3	86.5	111	3
95	91.5	3.15	5.3	89.5	114.8	3
97 (#DIN)	93.5	3.15	5.3	91.5	116	3
98 (#DIN)	94.5	3.15	5.3	92.5	117	3
100	96.5	3.15	5.3	94.5	120.2	3
105	101	4.15	6	98	125.8	4
110	106	4.15	6	103	131.2	4
115	111	4.15	6	108	137.3	4
120	116	4.15	6	113	143.1	4
125	121	4.15	6	118	149	4
130	126	4.15	6	123	154.4	4
135	131	4.15	6	128	159.8	4
140	136	4.15	6	133	165.2	4
145	141	4.15	6	138	170.6	4
150	145	4.15	7.5	142	177.3	4
155	150	4.15	7.5	146	182.3	4
160	155	4.15	7.5	151	188	4
165	160	4.15	7.5	155.5	193.4	4
170	165	4.15	7.5	160.5	198.4	4
175	170	4.15	7.5	165.5	203.4	4
180	175	4.15	7.5	170.5	210	4
185	180	4.15	7.5	175.5	215	4
190	185	4.15	7.5	180.5	220	4
195	190	4.15	7.5	185.5	225	4
200	195	4.15	7.5	190.5	230	4
210	204	5.15	9	198	240	5
220	214	5.15	9	208	250	5
230	224	5.15	9	218	260	5
240	234	5.15	9	228	270	5
250	244	5.15	9	238	280	5
260	252	5.15	12	245	294	5
270	262	5.15	12	255	304	5
280	272	5.15	12	265	314	5
290	282	5.15	12	275	324	5
300	292	5.15	12	285	334	5

- Depending on availability the phosphated type can be supplied. The heavy type is only available on request.
- Warning: electro-galvanizing of these products may cause hydrogen embrittlement.

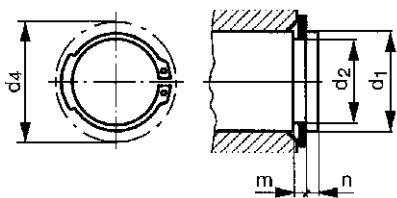

DETAIL X		
$d_1 \leq 9 \text{ mm.}$	$d_1 > 9 \leq 300 \text{ mm.} \textcircled{1}$	$d_1 \geq 170 \text{ mm.} \textcircled{1}$



① At the manufacturer's discretion

Article groups		
Material	Code	Page
Spring steel	36000	7-121
St.St.	51435	7-121

36000	Retaining ring for shaft - normal type	L07A
Material	Spring steel	
		

Nom. size shaft d ₁	☒	Art.number	Nom. size shaft d ₁	☒	Art.number	Nom. size shaft d ₁	☒	Art.number
3MM	500	36000.003.001	38MM	100	36000.038.001	97MM	5	36000.097.001
4MM	500	36000.004.001	39MM	100	36000.039.001	98MM	5	36000.098.001
5MM	500	36000.005.001	40MM	50	36000.040.001	100MM	5	36000.100.001
6MM	500	36000.006.001	42MM	50	36000.042.001	105MM	5	36000.105.001
7MM	500	36000.007.001	44MM	50	36000.044.001	110MM	5	36000.110.001
8MM	250	36000.008.001	45MM	50	36000.045.001	115MM	5	36000.115.001
9MM	250	36000.009.001	46MM	50	36000.046.001	120MM	5	36000.120.001
10MM	250	36000.010.001	47MM	50	36000.047.001	125MM	5	36000.125.001
11MM	250	36000.011.001	48MM	50	36000.048.001	130MM	5	36000.130.001
12MM	250	36000.012.001	50MM	50	36000.050.001	135MM	5	36000.135.001
13MM	100	36000.013.001	52MM	50	36000.052.001	140MM	5	36000.140.001
14MM	100	36000.014.001	54MM	25	36000.054.001	145MM	5	36000.145.001
15MM	100	36000.015.001	55MM	25	36000.055.001	150MM	3	36000.150.001
16MM	100	36000.016.001	56MM	25	36000.056.001	155MM	3	36000.155.001
17MM	100	36000.017.001	57MM	25	36000.057.001	160MM	3	36000.160.001
18MM	100	36000.018.001	58MM	25	36000.058.001	165MM	3	36000.165.001
19MM	100	36000.019.001	60MM	25	36000.060.001	170MM	3	36000.170.001
20MM	100	36000.020.001	62MM	25	36000.062.001	175MM	2	36000.175.001
21MM	100	36000.021.001	63MM	25	36000.063.001	180MM	2	36000.180.001
22MM	100	36000.022.001	65MM	10	36000.065.001	185MM	2	36000.185.001
23MM	100	36000.023.001	67MM	10	36000.067.001	190MM	2	36000.190.001
24MM	100	36000.024.001	68MM	10	36000.068.001	195MM	2	36000.195.001
25MM	100	36000.025.001	70MM	10	36000.070.001	200MM	2	36000.200.001
26MM	100	36000.026.001	72MM	10	36000.072.001	210MM	2	36000.210.001
27MM	100	36000.027.001	75MM	10	36000.075.001	220MM	2	36000.220.001
28MM	100	36000.028.001	77MM	10	36000.077.001	230MM	2	36000.230.001
29MM	100	36000.029.001	78MM	10	36000.078.001	240MM	2	36000.240.001
30MM	100	36000.030.001	80MM	10	36000.080.001	250MM	2	36000.250.001
31MM	100	36000.031.001	82MM	10	36000.082.001	260MM	2	36000.260.001
32MM	100	36000.032.001	85MM	5	36000.085.001	270MM	2	36000.270.001
33MM	100	36000.033.001	87MM	5	36000.087.001	280MM	2	36000.280.001
34MM	100	36000.034.001	88MM	5	36000.088.001	290MM	2	36000.290.001
35MM	100	36000.035.001	90MM	5	36000.090.001	300MM	2	36000.300.001
36MM	100	36000.036.001	92MM	5	36000.092.001			
37MM	100	36000.037.001	95MM	5	36000.095.001			

7

51435	Retaining ring for shaft - normal type	R09A
Material	Stainless steel	
	DIN ≈471	
		

Nom. size shaft d ₁	☒	Art.number	Nom. size shaft d ₁	☒	Art.number	Nom. size shaft d ₁	☒	Art.number
3MM*	200	51435.003.001	21MM	50	51435.021.001	45MM	10	51435.045.001
4MM	200	51435.004.001	22MM	50	51435.022.001	47MM	10	51435.047.001
5MM	200	51435.005.001	23MM	50	51435.023.001	48MM	10	51435.048.001
6MM	200	51435.006.001	24MM	50	51435.024.001	50MM	5	51435.050.001
7MM	200	51435.007.001	25MM	25	51435.025.001	52MM	5	51435.052.001
8MM	100	51435.008.001	26MM	25	51435.026.001	55MM	5	51435.055.001
9MM	100	51435.009.001	27MM	25	51435.027.001	60MM	5	51435.060.001
10MM	100	51435.010.001	28MM	25	51435.028.001	65MM	5	51435.065.001
11MM	100	51435.011.001	29MM*	50	51435.029.001	70MM	5	51435.070.001
12MM	100	51435.012.001	30MM	25	51435.030.001	75MM	5	51435.075.001
13MM	50	51435.013.001	32MM	25	51435.032.001	80MM	5	51435.080.001
14MM	50	51435.014.001	34MM	25	51435.034.001	85MM	1	51435.085.001
15MM	50	51435.015.001	35MM	25	51435.035.001	90MM	1	51435.090.001
16MM	50	51435.016.001	36MM	25	51435.036.001	95MM	1	51435.095.001
17MM	50	51435.017.001	38MM	25	51435.038.001	100MM	1	51435.100.001
18MM	50	51435.018.001	39MM*	25	51435.039.001	105MM*	10	51435.105.001
19MM	50	51435.019.001	40MM	10	51435.040.001	110MM*	10	51435.110.001
20MM	50	51435.020.001	42MM	10	51435.042.001	120MM*	10	51435.120.001

- Stainless steel circlips are made of martensitic stainless steel.
- In assemblies it is essential to use assembly pliers with a screw to limit the opening-closing of the ring.
- Furthermore it is advisable to apply a minimum on clamping on the shaft or housing if the application permits it.
- Also avoid contact with chloride containing liquids (cleaning) to reduce the risk of 'stress corrosion cracking'.

Retaining ring for bores - normal type

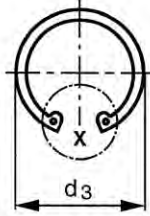
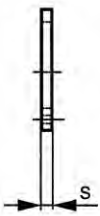

DIN 472
NF E22-165
BS 3673-4

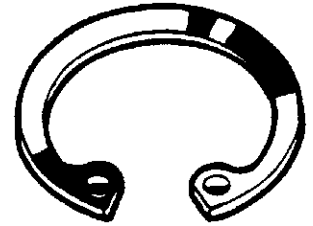

Technical Data

Nom.size bore d ₁	Groove d ₂	Groove m (H13)	Groove n (min.)	Ring d ₃	Ring d ₄	Ring s
8	8.4	0.9	0.6	8.7	3	0.8
9	9.4	0.9	0.6	9.8	3.7	0.8
10	10.4	1.1	0.6	10.8	3.3	1
11	11.4	1.1	0.6	11.8	4.1	1
12	12.5	1.1	0.8	13	4.9	1
13	13.6	1.1	0.9	14.1	5.4	1
14	14.6	1.1	0.9	15.1	6.2	1
15	15.7	1.1	1.1	16.2	7.2	1
16	16.8	1.1	1.2	17.3	8	1
17	17.8	1.1	1.2	18.3	8.8	1
18	19	1.1	1.5	19.5	9.4	1
19	20	1.1	1.5	20.5	10.4	1
20	21	1.1	1.5	21.5	11.2	1
21	22	1.1	1.5	22.5	12.2	1
22	23	1.1	1.5	23.5	13.2	1
23 (#DIN)	24.1	1.3	1.7	24.6	15.4	1.2
24	25.2	1.3	1.8	25.9	14.8	1.2
25	26.2	1.3	1.8	26.9	15.5	1.2
26	27.2	1.3	1.8	27.9	16.1	1.2
27 (#DIN)	28.4	1.3	2.1	29.1	18.2	1.2
28	29.4	1.3	2.1	30.1	17.9	1.2
29 (#DIN)	30.4	1.3	2.1	31.1	19.6	1.2
30	31.4	1.3	2.1	32.1	19.9	1.2
31	32.7	1.3	2.6	33.4	20	1.2
32	33.7	1.3	2.6	34.4	20.6	1.2
33 (#DIN)	34.7	1.3	2.6	35.5	22.2	1.2
34	35.7	1.6	2.6	36.5	22.6	1.5
35	37	1.6	3	37.8	23.6	1.5
36	38	1.6	3	38.8	24.6	1.5
37	39	1.6	3	39.8	25.4	1.5
38	40	1.6	3	40.8	26.4	1.5
39 (#DIN)	41	1.6	3	42	28.6	1.5
40	42.5	1.85	3.8	43.5	27.8	1.75
41 (#DIN)	43.5	1.85	3.8	44.5	29	1.75
42	44.5	1.85	3.8	45.5	29.6	1.75
43 (#DIN)	45.5	1.85	3.8	46.5	-	1.75
44 (#DIN)	46.5	1.85	3.8	47.5	32	1.75
45	47.5	1.85	3.8	48.5	32	1.75
46 (#DIN)	48.5	1.85	3.8	49.5	34.6	1.75
47	49.5	1.85	3.8	50.5	33.5	1.75
48	50.5	1.85	3.8	51.5	34.5	1.75
50	53	2.15	4.5	54.2	36.3	2
52	55	2.15	4.5	56.2	37.9	2
53 (#DIN)	56	2.15	4.5	57.2	40	2
54	57	2.15	4.5	58.2	41	2
55	58	2.15	4.5	59.2	40.7	2
56	59	2.15	4.5	60.2	41.7	2
57 (#DIN)	60	2.15	4.5	61.2	44	2
58	61	2.15	4.5	62.2	43.5	2
60	63	2.15	4.5	64.2	44.7	2
62	65	2.15	4.5	66.2	46.7	2
63	66	2.15	4.5	67.2	47.7	2
64 (#DIN)	67	2.65	4.5	68.2	48.7	2
65	68	2.65	4.5	69.2	49	2.5
67 (#DIN)	70	2.65	4.5	71.5	52	2.5
68	71	2.65	4.5	72.5	51.6	2.5
70	73	2.65	4.5	74.5	53.6	2.5

Technical Data

Nom. size bore d_1	Groove d_2	Groove m (H13)	Groove n (min.)	Ring d_3	Ring d_4	Ring s
72	75	2.65	4.5	76.5	55.6	2.5
75	78	2.65	4.5	79.5	58.6	2.5
77 (#DIN)	80	2.65	4.5	81.5	62	2.5
78	81	2.65	4.5	82.5	60.1	2.5
80	83.5	2.65	5.3	85.5	62.1	2.5
82	85.5	2.65	5.3	87.5	64.1	2.5
85	88.5	3.15	5.3	90.5	66.9	3
87 (#DIN)	90.5	3.15	5.3	92.5	69.8	3
88	91.5	3.15	5.3	93.5	69.9	3
90	93.5	3.15	5.3	95.5	71.9	3
92	95.5	3.15	5.3	97.5	73.3	3
95	98.5	3.15	5.3	100.5	76.5	3
97 (#DIN)	100.5	3.15	5.3	102.5	79.4	3
98	101.5	3.15	5.3	103.5	79	3
100	103.5	3.15	5.3	105.5	80.6	3
102	106	4.15	6	108	82	4
105	109	4.15	6	112	85	4
108	112	4.15	6	115	88	4
110	114	4.15	6	117	88.2	4
112	116	4.15	6	119	90	4
115	119	4.15	6	122	93	4
117 (#DIN)	121	4.15	6	124	97	4
120	124	4.15	6	127	96.9	4
125	129	4.15	6	132	101.9	4
130	134	4.15	6	137	106.9	4
135	139	4.15	6	142	111.5	4
140	144	4.15	6	147	116.5	4
145	149	4.15	6	152	121	4
150	155	4.15	7.5	158	124.8	4
155	160	4.15	7.5	164	129.8	4
160	165	4.15	7.5	169	132.7	4
165	170	4.15	7.5	174.5	137.7	4
170	175	4.15	7.5	179.5	141.6	4
172 (#DIN)	177	4.15	7.5	181.5	-	4
175	180	4.15	7.5	184.5	146.6	4
180	185	4.15	7.5	189.5	150.2	4
185	190	4.15	7.5	194.5	155.2	4
188 (#DIN)	193	4.15	7.5	197.5	-	4
190	195	4.15	7.5	199.5	160.2	4
195	200	4.15	7.5	204.5	165.2	4
200	205	4.15	7.5	209.5	170.2	4
210	216	5.15	9	222	180.2	5
215 (#DIN)	221	5.15	9	227	-	5
220	226	5.15	9	232	190.2	5
225 (#DIN)	231	5.15	9	237	-	5
230	236	5.15	9	242	200.2	5
240	246	5.15	9	252	210.2	5
250	256	5.15	9	262	220.2	5
260	268	5.15	12	275	226	5
270 (#DIN)	278	5.15	12	285	-	5
275 (#DIN)	283	5.15	12	290	241	5
280	288	5.15	12	295	246	5
290	298	5.15	12	305	256	5
300	308	5.15	12	315	266	5

7

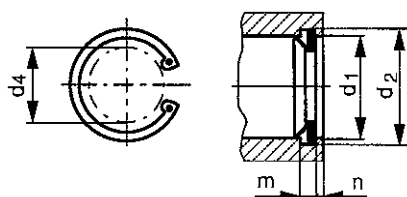

DETAIL X		
$d_1 \leq 300\text{mm.}$	$d_1 \geq 170\text{mm.}^{①}$	$d_1 \geq 25\text{mm.}^{①}$

① At the manufacturer's discretion

Article groups

Material	Code	Page
Spring steel EN 10132-4	36050	7-124
St.St.	51437	7-124

36050 Retaining ring for bores - normal type L07A

Material	Spring steel EN 10132-4	
		

Nom. size bore d ₁	☒	Art.number	Nom. size bore d ₁	☒	Art.number	Nom. size bore d ₁	☒	Art.number
8MM	250	36050.008.001	45MM	50	36050.045.001	108MM	5	36050.108.001
9MM	250	36050.009.001	46MM	50	36050.046.001	110MM	5	36050.110.001
10MM	250	36050.010.001	47MM	50	36050.047.001	112MM	5	36050.112.001
11MM	250	36050.011.001	48MM	50	36050.048.001	115MM	5	36050.115.001
12MM	250	36050.012.001	50MM	50	36050.050.001	117MM	5	36050.117.001
13MM	100	36050.013.001	52MM	50	36050.052.001	120MM	5	36050.120.001
14MM	100	36050.014.001	53MM	25	36050.053.001	125MM	5	36050.125.001
15MM	100	36050.015.001	54MM	25	36050.054.001	130MM	5	36050.130.001
16MM	100	36050.016.001	55MM	25	36050.055.001	135MM	5	36050.135.001
17MM	100	36050.017.001	56MM	25	36050.056.001	140MM	5	36050.140.001
18MM	100	36050.018.001	57MM	25	36050.057.001	145MM	5	36050.145.001
19MM	100	36050.019.001	58MM	25	36050.058.001	150MM	3	36050.150.001
20MM	100	36050.020.001	60MM	25	36050.060.001	155MM	3	36050.155.001
21MM	100	36050.021.001	62MM	25	36050.062.001	160MM	3	36050.160.001
22MM	100	36050.022.001	63MM	25	36050.063.001	165MM	3	36050.165.001
23MM	100	36050.023.001	64MM	25	36050.064.001	170MM	3	36050.170.001
24MM	100	36050.024.001	65MM	10	36050.065.001	172MM	3	36050.172.001
25MM	100	36050.025.001	67MM	10	36050.067.001	175MM	2	36050.175.001
26MM	100	36050.026.001	68MM	10	36050.068.001	180MM	2	36050.180.001
27MM	100	36050.027.001	70MM	10	36050.070.001	185MM	2	36050.185.001
28MM	100	36050.028.001	72MM	10	36050.072.001	190MM	2	36050.190.001
29MM	100	36050.029.001	75MM	10	36050.075.001	195MM	2	36050.195.001
30MM	100	36050.030.001	77MM	10	36050.077.001	200MM	2	36050.200.001
31MM	100	36050.031.001	78MM	10	36050.078.001	210MM	2	36050.210.001
32MM	100	36050.032.001	80MM	10	36050.080.001	215MM	2	36050.215.001
33MM	100	36050.033.001	82MM	10	36050.082.001	220MM	2	36050.220.001
34MM	100	36050.034.001	85MM	5	36050.085.001	225MM	2	36050.225.001
35MM	100	36050.035.001	87MM	5	36050.087.001	230MM	2	36050.230.001
36MM	100	36050.036.001	88MM	5	36050.088.001	240MM	2	36050.240.001
37MM	100	36050.037.001	90MM	5	36050.090.001	250MM	2	36050.250.001
38MM	100	36050.038.001	92MM	5	36050.092.001	260MM	2	36050.260.001
39MM	100	36050.039.001	95MM	5	36050.095.001	270MM	2	36050.270.001
40MM	50	36050.040.001	97MM	5	36050.097.001	275MM	2	36050.275.001
41MM	50	36050.041.001	98MM	5	36050.098.001	280MM	2	36050.280.001
42MM	50	36050.042.001	100MM	5	36050.100.001	290MM	2	36050.290.001
43MM	50	36050.043.001	102MM	5	36050.102.001	300MM	2	36050.300.001
44MM	50	36050.044.001	105MM	5	36050.105.001			

- Depending on availability the phosphated type can be supplied. The heavy type is only available on request.
- **Warning:** electro-galvanizing of these products may cause hydrogen embrittlement.

51437 Retaining ring for bores - normal type R09A

Material	Stainless steel	DIN	≈472	
				

Nom. size bore d ₁	☒	Art.number	Nom. size bore d ₁	☒	Art.number	Nom. size bore d ₁	☒	Art.number
8MM	100	51437.008.001	24MM	50	51437.024.001	40MM	10	51437.040.001
9MM	100	51437.009.001	25MM	25	51437.025.001	41MM*	25	51437.041.001
10MM	100	51437.010.001	26MM	25	51437.026.001	42MM	10	51437.042.001
11MM	100	51437.011.001	27MM	25	51437.027.001	43MM*	25	51437.043.001
12MM	100	51437.012.001	28MM	25	51437.028.001	44MM*	25	51437.044.001
13MM	50	51437.013.001	29MM	25	51437.029.001	45MM	10	51437.045.001
14MM	50	51437.014.001	30MM	25	51437.030.001	47MM	10	51437.047.001
15MM	50	51437.015.001	31MM*	25	51437.031.001	48MM	10	51437.048.001
16MM	50	51437.016.001	32MM	25	51437.032.001	50MM	5	51437.050.001
17MM	50	51437.017.001	33MM	25	51437.033.001	52MM	5	51437.052.001
18MM	50	51437.018.001	34MM	25	51437.034.001	55MM	5	51437.055.001
19MM	50	51437.019.001	35MM	25	51437.035.001	58MM	5	51437.058.001
20MM	50	51437.020.001	36MM	25	51437.036.001	60MM	5	51437.060.001
21MM	50	51437.021.001	37MM	25	51437.037.001	62MM	5	51437.062.001
22MM	50	51437.022.001	38MM	25	51437.038.001	65MM	5	51437.065.001
23MM	50	51437.023.001	39MM	25	51437.039.001	68MM	5	51437.068.001

51437 Retaining ring for bores - normal type								
Nom. size bore d_1	☒	Art.number	Nom. size bore d_1	☒	Art.number	Nom. size bore d_1	☒	Art.number
70MM	5	51437.070.001	85MM	1	51437.085.001	105MM*	10	51437.105.001
72MM	5	51437.072.001	90MM	1	51437.090.001	110MM*	10	51437.110.001
75MM	5	51437.075.001	95MM	1	51437.095.001	112MM*	10	51437.112.001
80MM	5	51437.080.001	100MM	1	51437.100.001	140MM*	10	51437.140.001

- Stainless steel circlips are made of martensitic stainless steel.
- In assemblies it is essential to use assembly pliers with a screw to limit the opening-closing of the ring.
- Furthermore it is advisable to apply a minimum on clamping on the shaft or housing if the application permits it.
- Also avoid contact with chloride containing liquids (cleaning) to reduce the risk of 'stress corrosion cracking'.

Retaining washer for shafts

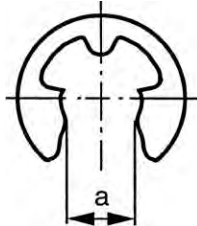
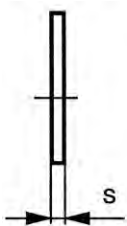

DIN 6799
BS 3673-2



Technical Data

Nom.size groove d_2 (h11)	Groove m	Groove n (min.)	Range d_1	Ring a	Ring d_3 (max.)	Ring s
1.2	0.34	0.6	1.4-2	1.01	3.25	0.3
1.5	0.44	0.8	2-2.5	1.28	4.25	0.4
1.9	0.54	1	2.5-3	1.61	4.8	0.5
2.3	0.64	1	3-4	1.94	6.3	0.6
3.2	0.64	1	4-5	2.7	7.3	0.6
4	0.74	1.2	5-7	3.34	9.3	0.7
5	0.74	1.2	6-8	4.11	11.3	0.7
6	0.74	1.2	7-9	5.26	12.3	0.7
7	0.94	1.5	8-11	5.84	14.3	0.9
8	1.05	1.8	9-12	6.52	16.3	1
9	1.15	2	10-14	7.63	18.8	1.1
10	1.25	2	11-15	8.32	20.4	1.2
12	1.35	2.5	13-18	10.45	23.4	1.3
15	1.55	3	16-24	12.61	29.4	1.5
19	1.8	3.5	20-31	15.92	37.6	1.75
24	2.05	4	25-38	21.88	44.6	2

- Depending on availability the phosphated type can be supplied.

Assembly data

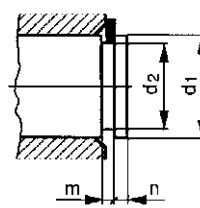
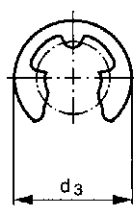
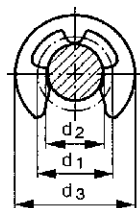

Article groups

Material	Code	Page
Spring steel 460-580 HV	36200	7-125
St.St.	51440	7-126

36200 Retaining washer for shafts L07A

Material Spring steel 460-580 HV



Nom. size groove d_2 (h11)	☒	Art.number	Nom. size groove d_2 (h11)	☒	Art.number	Nom. size groove d_2 (h11)	☒	Art.number
1,2MM	500	36200.012.001	2,3MM	500	36200.023.001	5MM	500	36200.050.001
1,5MM	500	36200.015.001	3,2MM	500	36200.032.001	6MM	500	36200.060.001
1,9MM	500	36200.019.001	4MM	500	36200.040.001	7MM	250	36200.070.001

36200 Retaining washer for shafts								
Nom. size groove d ₂ (h11)	☒	Art.number	Nom. size groove d ₂ (h11)	☒	Art.number	Nom. size groove d ₂ (h11)	☒	Art.number
8MM	250	36200.080.001	12MM	100	36200.120.001	24MM	100	36200.240.001
9MM	250	36200.090.001	15MM	100	36200.150.001			
10MM	250	36200.100.001	19MM	100	36200.190.001			

• Warning: electro-galvanizing of these products may cause hydrogen embrittlement.

51440 Retaining washer for shafts		R09A
Material	Stainless steel	
	 	

Nom. size groove d ₂ (h11)	☒	Art.number	Nom. size groove d ₂ (h11)	☒	Art.number	Nom. size groove d ₂ (h11)	☒	Art.number
1.2MM	500	51440.012.001	5MM	250	51440.050.001	10MM	100	51440.100.001
1.5MM	500	51440.015.001	6MM	250	51440.060.001	12MM	100	51440.120.001
1.9MM	500	51440.019.001	7MM	250	51440.070.001	15MM	100	51440.150.001
2.3MM	250	51440.023.001	8MM	250	51440.080.001	19MM	100	51440.190.001
3.2MM	250	51440.032.001	9MM	100	51440.090.001	24MM	100	51440.240.001
4MM	250	51440.040.001						

Snap ring for shafts

DIN 7993 A

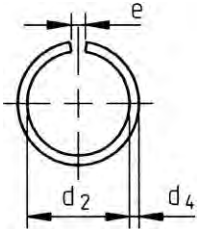

Technical Data

Nom.size shaft d ₁	d ₂	d ₃	d ₄	e ≈	r
6	5.1	5.2	0.8	1	0.5
8	7.1	7.2	0.8	2	0.5
10	9.1	9.2	0.8	2	0.5
12	10.8	11	1	3	0.6
14	12.8	13	1	3	0.6
16	14.2	14.4	1.6	3	0.9
20	17.7	18	2	3	1.1
22	19.7	20	2	3	1.1
24	21.7	22	2	3	1.1
25	22.7	23	2	3	1.1
26	23.7	24	2	3	1.1
28	25.7	26	2	3	1.1
30	27.7	28	2	3	1.1
32	29.1	29.5	2.5	4	1.4
35	32.1	32.5	2.5	4	1.4
38	35.1	35.5	2.5	4	1.4
40	37.1	37.5	2.5	4	1.4
45	42	42.5	2.5	4	1.4
48	45	45.5	2.5	4	1.4
50	47	47.5	2.5	4	1.4
55	51.1	51.8	3.2	4	1.8
60	56.1	56.8	3.2	4	1.8
65	61.1	61.8	3.2	4	1.8
70	66	66.8	3.2	5	1.8
75	71	71.8	3.2	5	1.8
80	76	76.8	3.2	5	1.8
85	81	81.8	3.2	5	1.8
90	86	86.8	3.2	5	1.8
105	100.8	101.8	3.2	5	1.8
110	105.8	106.8	3.2	5	1.8
120	115.8	116.8	3.2	5	1.8

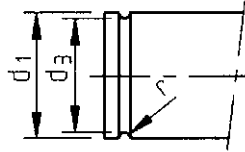
Assembly data

36215	Snap ring for shafts	L07A
Material	Spring steel	

Nom. size shaft d_1	☒	Art.number	Nom. size shaft d_1	☒	Art.number	Nom. size shaft d_1	☒	Art.number
6MM	250	36215.006.001	28MM	100	36215.028.001	60MM	25	36215.060.001
8MM	100	36215.008.001	30MM	100	36215.030.001	65MM	10	36215.065.001
10MM	250	36215.010.001	32MM	100	36215.032.001	70MM	10	36215.070.001
12MM	250	36215.012.001	35MM	100	36215.035.001	75MM	10	36215.075.001
14MM	100	36215.014.001	38MM	100	36215.038.001	80MM	10	36215.080.001
16MM	100	36215.016.001	40MM	50	36215.040.001	85MM	5	36215.085.001
20MM	100	36215.020.001	45MM	50	36215.045.001	90MM	5	36215.090.001
22MM	100	36215.022.001	48MM	50	36215.048.001	105MM	5	36215.105.001
24MM	100	36215.024.001	50MM	50	36215.050.001	110MM	5	36215.110.001
25MM	100	36215.025.001	55MM	25	36215.055.001	120MM	5	36215.120.001
26MM	100	36215.026.001						

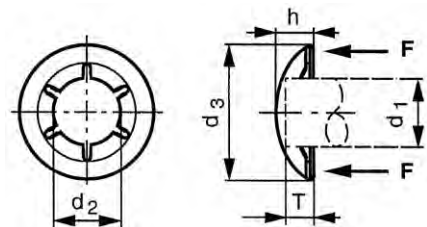

- Warning: electro-galvanizing of these products may cause hydrogen embrittlement.

Fixing washer for shafts with stainless steel cap type A

7



Technical Data					
For shaft d_1 (h11)	d_2 (max.)	d_3	F-1	h	T (max.)
2	1.84	10.6	200	3	2.5
3	2.81	10.6	200	3	2.5
4	3.8	12.4	400	3.8	3
5	4.74	12.4	400	3.8	3
6	5.7	16.2	800	5	4
8	7.66	16.2	800	5	4
10	9.74	19.7	1.000	5.9	4.5
12	11.62	26	2.500	7.5	6
13	12.64	26	2.500	7.5	6
14	13.65	29.4	2.500	9	7
15	14.68	39.4	2.500	9	7
16	15.53	29.4	2.500	9	7
17	16.78	29.4	2.500	9	7
19	18.68	38.2	3.500	11.7	8.7
20	19.63	38.2	3.500	11.7	8.7
25	24.63	43.4	3.850	13.75	9.5

- F-1 = allowable load in Newton (shaft St 37).

Article groups			
Material	Surface treatment	Code	Page
Spring steel	Bronze plated and varnished	36233	7-128
St.St.		51446	7-128

36233	Fixing washer for shafts with stainless steel cap type A	L07B
Material	Spring steel	
Surface treatment	Bronze plated and varnished	
		

For shaft d_1	☒	Art.number	For shaft d_1	☒	Art.number	For shaft d_1	☒	Art.number
3MM	250	36233.030.001	6MM	250	36233.060.001	12MM	250	36233.120.001
4MM	250	36233.040.001	8MM	250	36233.080.001	16MM	100	36233.160.001
5MM	250	36233.050.001	10MM	250	36233.100.001	20MM	100	36233.200.001

51446	Fixing washer for shafts with stainless steel cap type A	R09A
Material	Stainless steel	
		

For shaft d_1	☒	Art.number	For shaft d_1	☒	Art.number	For shaft d_1	☒	Art.number
3MM	100	51446.030.001	6MM	100	51446.060.001	12MM	100	51446.120.001
4MM	100	51446.040.001	8MM	100	51446.080.001	14MM	100	51446.140.001
5MM	100	51446.050.001	10MM	100	51446.100.001			

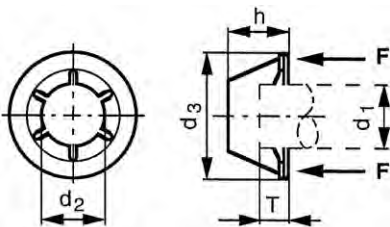

Fixing washer for shafts with steel zinc plated cap type 4A



7

Technical Data					
For shaft d_1 (h11)	d_2 (max.)	d_3	F-1	h	T (max.)
4	3.8	12.3	400	5.7	5.3
5	4.74	12.3	400	5.7	5.3
6	5.7	16.2	800	7.2	6.7
8	7.66	16.2	800	7.2	6.7
10	9.74	19.7	1.000	8.1	7.8

F-1 = allowable load in Newton (shaft St 37).

36239	Fixing washer for shafts with steel zinc plated cap type 4A	L07B
Material	Spring steel	
Surface treatment	Bronze plated and varnished	
		

For shaft d_1	☒	Art.number	For shaft d_1	☒	Art.number	For shaft d_1	☒	Art.number
4MM	250	36239.040.001	6MM	250	36239.060.001	10MM	250	36239.100.001
5MM	250	36239.050.001	8MM	250	36239.080.001			

Warning: electro-galvanizing of these products may cause hydrogen embrittlement.

Fixing washer installation tool



- Application with magnetic ferrules, article groups 36251 and 36252.

36250	Fixing washer universal handle	L07B

Type	☒	Art.number
HANDLE	1	36250.001.770

Magnetic ferrule



Article groups	
Code	Page
36251	7-129
36252	7-129

36251	Magnetic ferrule	L07B

Type	☒	Art.number	Type	☒	Art.number	Type	☒	Art.number
1,6-3,2MM	1	36251.016.032	9,0-11,0MM	1	36251.090.110	18,0-23,0MM	1	36251.180.230
4,0-5,0MM	1	36251.040.050	12,0-13,0MM	1	36251.120.130	24,0-25,0MM	1	36251.240.250
6,0-8,0MM	1	36251.060.080	14,0-17,0MM	1	36251.140.170			

- Suitable for the installation of fixing washers for shafts without cap, made of spring steel.
- Application with handle, article group 36250.
- Shaft 6,0-8,0MM: Also suitable for fixing washers for shafts with cap type 4A, made of spring steel and stainless steel: 4,0 mm - 5,0 mm.
- Shaft 9,0-11,0MM: Also suitable for fixing washers for shafts with cap type 4A, made of spring steel and stainless steel: 6,0 mm - 9,0 mm.
- Shaft 12,0-13,0MM: Also suitable for fixing washers for shafts with cap type 4A, made of spring steel and stainless steel: 10,0 mm - 11,0 mm.

36252	Magnetic ferrule	L07B

Type	☒	Art.number	Type	☒	Art.number	Type	☒	Art.number
1,6-3,2MM	1	36252.016.032	9,0-11,0MM	1	36252.090.110	14,0-17,0MM	1	36252.140.170
4,0-5,0MM	1	36252.040.050	12,0-13,0MM	1	36252.120.130	18,0-22,0MM	1	36252.180.220
6,0-8,0MM	1	36252.060.080						

- Suitable for the installation of fixing washers for shafts with cap type A, made of spring steel and/or stainless steel.
- Application with handle, article group 36250.

Fixing washer for shafts (without cap)

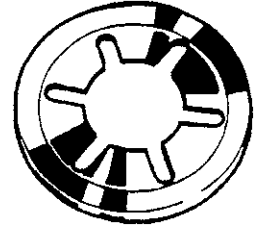
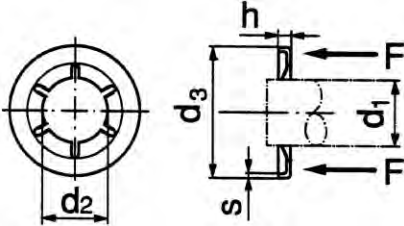

Technical Data

For shaft d_1 (h11)	d_2 (max.)	d_3	F-1	h	s
2	1.84	9.7	200	1.3	0.2
3	2.81	9.7	200	1.3	0.2
4	3.8	11.5	400	1.3	0.2
5	4.74	11.5	400	1.3	0.2
6	5.7	15.3	800	1.3	0.25
6.35	6.08	15.3	800	1.3	0.25
7	6.72	15.3	800	1.3	0.25
8	7.66	15.3	800	1.3	0.25
9	8.75	18.4	1.000	1.9	0.3
10	9.74	18.4	1.000	1.9	0.3
11	10.76	18.4	1.000	1.9	0.3
12	11.62	25	2.500	2.3	0.4
13	12.64	25	2.500	2.3	0.4
14	13.66	28.2	2.500	2.3	0.4
15	14.68	28.2	2.500	2.3	0.4
16	15.53	28.2	2.500	2.3	0.4
17	16.68	28.2	2.500	2.3	0.4
18	17.62	36.6	3.500	3	0.4
19	18.69	36.6	3.850	3	0.4
20	19.63	36.6	3.850	3	0.4
24	23.66	41.4	3.850	3.2	0.5
25	24.63	41.4	3.850	3.2	0.5

- F-1 = allowable load in Newton (shaft St 37).

Article groups

Material	Surface treatment	Code	Page
Spring steel	Bronze plated and varnished	36230	7-130
St.St.		51445	7-131

36230 Fixing washer for shafts (without cap)

L07B

Material Spring steel
Surface treatment Bronze plated and varnished



For shaft d_1	☒	Art.number	For shaft d_1	☒	Art.number	For shaft d_1	☒	Art.number
2MM	500	36230.020.001	9MM	250	36230.090.001	16MM	100	36230.160.001
3MM	500	36230.030.001	10MM	250	36230.100.001	17MM	100	36230.170.001
4MM	500	36230.040.001	11MM	250	36230.110.001	18MM	100	36230.180.001
5MM	500	36230.050.001	12MM	250	36230.120.001	19MM	100	36230.190.001
6MM	500	36230.060.001	13MM	100	36230.130.001	20MM	100	36230.200.001
6.35MM	500	36230.063.501	14MM	100	36230.140.001	24MM	50	36230.240.001
7MM	250	36230.070.001	15MM	100	36230.150.001	25MM	50	36230.250.001
8MM	250	36230.080.001						

- Warning: electro-galvanizing of these products may cause hydrogen embrittlement.

51445	Fixing washer for shafts (without cap)	R09A
Material	Stainless steel	
		

For shaft d_1	☒	Art.number	For shaft d_1	☒	Art.number	For shaft d_1	☒	Art.number
3MM	100	51445.030.001	6MM	100	51445.060.001	10MM	100	51445.100.001
4MM	100	51445.040.001	8MM	100	51445.080.001	12MM	100	51445.120.001
5MM	100	51445.050.001						

SL clip for bolts and shafts



Technical Data									
Nom.size shaft d_1	a	b	d_2 (h11)	h_1	h_2	m	n	s	z
4	2.2	7	3.2	8.5	4	0.64	2	0.3	0.5
5	2.7	9	4	10.8	5	0.74	2.5	0.35	0.5
6	3.2	11	5	14	6	0.74	3	0.4	0.75
8	3.7	14	6	17.5	8	0.94	3.5	0.45	1
10	4.7	18	8	22	10	1.05	4.5	0.5	1
12	5.5	22	9	26	12	11.5	5	0.5	1.25
14	5.7	25	10	30	13.5	1.25	5.5	0.6	1.5
16	6.8	28	12	34.5	16	1.35	6	0.6	1.5

Assembly data / Application data

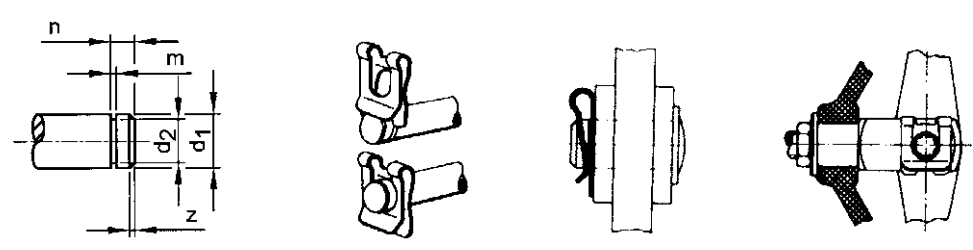

7

36265	SL clip for bolts and shafts	L07A
Material	Spring steel	
Surface treatment	Zinc plated	

Nom. size shaft d_1	☒	Art.number	Nom. size shaft d_1	☒	Art.number	Nom. size shaft d_1	☒	Art.number
4MM	500	36265.040.001	8MM	200	36265.080.001	14MM	100	36265.140.001
5MM	500	36265.050.001	10MM	200	36265.100.001	16MM	100	36265.160.001
6MM	500	36265.060.001	12MM	200	36265.120.001			

Clamp-adjusting ring with hexagon socket head cap screw

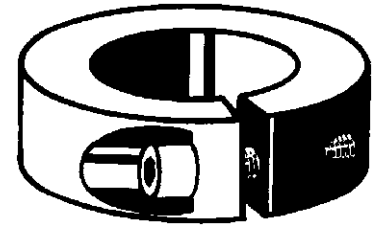
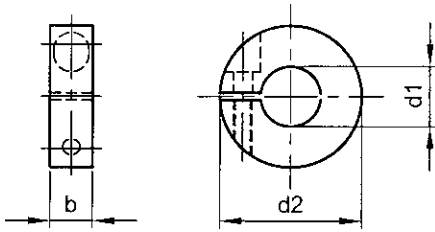

Technical Data

d ₁	b	d ₂	Screw size	d ₁	b	d ₂	Screw size
8	10	25	M4x15	25	12	50	M5x20
10	10	32	M4x15	30	12	56	M5x20
12	10	32	M4x15	35	12	63	M5x20
15	12	40	M5x20	40	14	70	M6x20
16	12	40	M5x20	45	14	80	M6x20
20	12	45	M5x20	50	14	80	M6x20

- Special features of clamp-adjusting rings:
- Simple installation, low loading of the shaft.
- Compensates tolerance variations of the shaft.
- Simple dis-assembly and precise moveable.
- The shaft remains undamaged due to no metal disformation during tightening.
- Equal division of clamping force over the circumference.

37840 Clamp-adjusting ring with hexagon socket head cap screw

L07F

Material Free-cutting steel

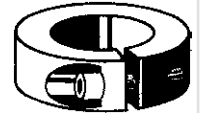

d ₁ x d ₂ x b	☒	Art.number	d ₁ x d ₂ x b	☒	Art.number	d ₁ x d ₂ x b	☒	Art.number
8X25X10MM	10	37840.080.001	16X40X12MM	5	37840.160.001	35X63X12MM	2	37840.350.001
10X32X10MM	10	37840.100.001	20X45X12MM	5	37840.200.001	40X70X14MM	2	37840.400.001
12X32X10MM	5	37840.120.001	25X50X12MM	5	37840.250.001	45X80X14MM	2	37840.450.001
15X40X12MM	5	37840.150.001	30X56X12MM	5	37840.300.001	50X80X14MM	2	37840.500.001

Clamp-adjusting ring with 2x hexagon socket

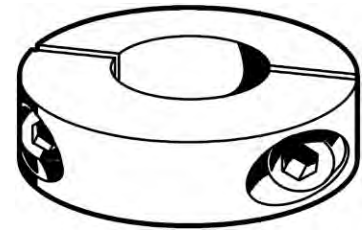
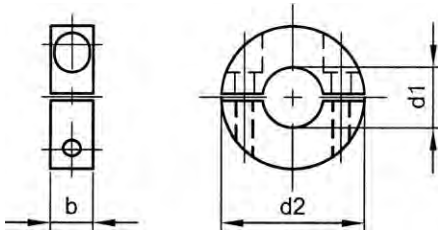

Technical Data

d ₁ (H8)	b (j14)	d ₂ (H13)	d ₁ (H8)	b (j14)	d ₂ (H13)
8	10	25	25	12	50
10	10	32	30	12	56
12	10	32	35	12	63
15	12	40	40	14	70
16	12	40	45	14	80
20	12	45	50	14	80

37845 Clamp-adjusting ring with 2x hexagon socket

L07F

Material Free-cutting steel



d ₁ x d ₂ x b	☒	Art.number	d ₁ x d ₂ x b	☒	Art.number	d ₁ x d ₂ x b	☒	Art.number
8X25X10MM	10	37845.080.001	16X40X12MM	5	37845.160.001	35X63X12MM	2	37845.350.001
10X32X10MM	10	37845.100.001	20X45X12MM	5	37845.200.001	40X70X14MM	2	37845.400.001
12X32X10MM	5	37845.120.001	25X50X12MM	5	37845.250.001	45X80X14MM	2	37845.450.001
15X40X12MM	5	37845.150.001	30X56X12MM	5	37845.300.001	50X80X14MM	2	37845.500.001

Adjusting ring with set screw

DIN 705A

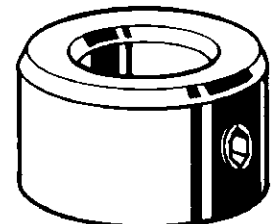
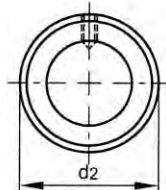
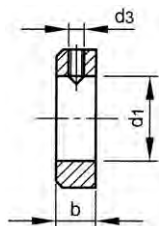

Technical Data

d ₁ (H8)	b (js14)	d ₂ (h13)	d ₃	d ₁ (H8)	b (js14)	d ₂ (h13)	d ₃
3	5	7	M2	30	16	45	M8
4	5	8	M2.5	32	16	50	M8
5	6	10	M3	34 (#DIN)	16	50	M8
6	8	12	M4	35	16	56	M8
7	8	12	M4	36	16	56	M8
8	8	16	M4	38 (#DIN)	16	56	M8
9 (#DIN)	10	18	M5	40	18	63	M10
10	10	20	M5	42 (#DIN)	18	63	M10
11 (#DIN)	10	20	M5	45	18	70	M10
12	12	22	M6	48 (#DIN)	18	70	M10
13 (#DIN)	12	22	M6	50	18	80	M10
14	12	25	M6	55	18	80	M10
15	12	25	M6	56	18	80	M10
16	12	28	M6	58 (#DIN)	20	90	M10
18	14	32	M6	60	20	90	M10
20	14	32	M6	63	20	90	M10
22	14	36	M6	65	20	100	M10
24	16	40	M8	70	20	100	M10
25	16	40	M8	75	22	110	M12
26	16	40	M8	80	22	110	M12
28	16	45	M8				

Article groups

Material	Surface treatment		Code	Page
Free-cutting steel		with ISO 4029	37810	7-134
Free-cutting steel		with EN 27434	37815	7-134
Free-cutting steel	Zipl	with ISO 4029	37820	7-134
St.St. A1		with ISO 4029	51370	7-135
St.St. A1		with EN 27434	51372	7-135
St.St. A2		with ISO 4027	51371	7-135

37810 Adjusting ring with hexagon socket set screw DIN 705A/ISO 4029 (DIN 916) L07F

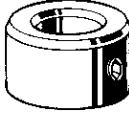
Material	Free-cutting steel	DIN	705A/4029	
		NEN	- /2343	 
		NF	- /E27-183	
		BS	- /4168-5	

$d_1 \times d_2 \times b$	☒	Art.number	$d_1 \times d_2 \times b$	☒	Art.number	$d_1 \times d_2 \times b$	☒	Art.number
3X7X5MM	50	37810.030.001	18X32X14MM	10	37810.180.001	42X63X18MM	5	37810.420.001
4X8X5MM	50	37810.040.001	20X32X14MM	10	37810.200.001	45X70X18MM	5	37810.450.001
5X10X6MM	50	37810.050.001	22X36X14MM	10	37810.220.001	48X70X18MM	5	37810.480.001
6X12X8MM	50	37810.060.001	24X40X16MM	10	37810.240.001	50X80X18MM	5	37810.500.001
7X12X8MM	50	37810.070.001	25X40X16MM	10	37810.250.001	55X80X18MM	1	37810.550.001
8X16X8MM	50	37810.080.001	26X40X16MM	10	37810.260.001	56X80X18MM	1	37810.560.001
9X18X10MM	25	37810.090.001	28X45X16MM	10	37810.280.001	58X90X20MM	1	37810.580.001
10X20X10MM	25	37810.100.001	30X45X16MM	10	37810.300.001	60X90X20MM	1	37810.600.001
11X20X10MM	25	37810.110.001	32X50X16MM	10	37810.320.001	63X90X20MM	1	37810.630.001
12X22X12MM	10	37810.120.001	34X50X16MM	5	37810.340.001	65X100X20MM	1	37810.650.001
13X22X12MM	10	37810.130.001	35X56X16MM	5	37810.350.001	70X100X20MM	1	37810.700.001
14X25X12MM	10	37810.140.001	36X56X16MM	5	37810.360.001	75X110X22MM	1	37810.750.001
15X25X12MM	10	37810.150.001	38X56X16MM	5	37810.380.001	80X110X22MM	1	37810.800.001
16X28X12MM	10	37810.160.001	40X63X18MM	5	37810.400.001			

37815 Adjusting ring with slotted set screw DIN 705A/EN 27434 (DIN 553) L07F

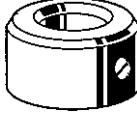

Material	Free-cutting steel	DIN	705A/27434	
				 

$d_1 \times d_2 \times b$	☒	Art.number	$d_1 \times d_2 \times b$	☒	Art.number	$d_1 \times d_2 \times b$	☒	Art.number
3X7X5MM	50	37815.030.001	18X32X14MM	10	37815.180.001	40X63X18MM	5	37815.400.001
4X8X5MM	50	37815.040.001	20X32X14MM	10	37815.200.001	42X63X18MM	5	37815.420.001
5X10X6MM	50	37815.050.001	22X36X14MM	10	37815.220.001	45X70X18MM	5	37815.450.001
6X12X8MM	50	37815.060.001	24X40X16MM	10	37815.240.001	48X70X18MM	5	37815.480.001
7X12X8MM	50	37815.070.001	25X40X16MM	10	37815.250.001	50X80X18MM	5	37815.500.001
8X16X8MM	50	37815.080.001	26X40X16MM	10	37815.260.001	55X80X18MM	1	37815.550.001
9X18X10MM	25	37815.090.001	28X45X16MM	10	37815.280.001	58X90X20MM	1	37815.580.001
10X20X10MM	25	37815.100.001	30X45X16MM	10	37815.300.001	60X90X20MM	1	37815.600.001
11X20X10MM	25	37815.110.001	32X50X16MM	10	37815.320.001	63X90X20MM	1	37815.630.001
12X22X12MM	10	37815.120.001	34X50X16MM	5	37815.340.001	65X100X20MM	1	37815.650.001
14X25X12MM	10	37815.140.001	35X56X16MM	5	37815.350.001	70X100X20MM	1	37815.700.001
15X25X12MM	10	37815.150.001	36X56X16MM	5	37815.360.001	75X110X22MM	1	37815.750.001
16X28X12MM	10	37815.160.001	38X56X16MM	5	37815.380.001	80X110X22MM	1	37815.800.001

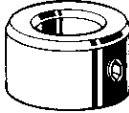

37820 Adjusting ring with hexagon socket set screw DIN 705A/ISO 4029 (DIN 916) L07F

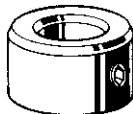
Material	Free-cutting steel	DIN	705A/4029	
Surface treatment	Zinc plated	NEN	- /2343	 
		NF	- /E27-183	
		BS	- /4168-5	

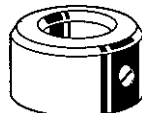

$d_1 \times d_2 \times b$	☒	Art.number	$d_1 \times d_2 \times b$	☒	Art.number	$d_1 \times d_2 \times b$	☒	Art.number
5X10X6MM	50	37820.050.001	16X28X12MM	10	37820.160.001	30X45X16MM	10	37820.300.001
6X12X8MM	50	37820.060.001	18X32X14MM	10	37820.180.001	35X56X16MM	5	37820.350.001
8X16X8MM	50	37820.080.001	20X32X14MM	10	37820.200.001	40X63X18MM	5	37820.400.001
10X20X10MM	25	37820.100.001	22X36X14MM	10	37820.220.001	45X70X18MM	5	37820.450.001
12X22X12MM	10	37820.120.001	25X40X16MM	10	37820.250.001	50X80X18MM	5	37820.500.001
14X25X12MM	10	37820.140.001	26X40X16MM	10	37820.260.001	60X90X20MM	1	37820.600.001
15X25X12MM	10	37820.150.001	28X45X16MM	10	37820.280.001	70X100X20MM	1	37820.700.001

51370 Adjusting ring with hexagon socket set screw DIN 705A/ISO 4029 (DIN 916)				R09A
Material	Stainless steel A1		DIN 705A/4029 NEN - /2343 NF - /E27-183 BS - /4168-5	
				

$d_1 \times d_2 \times b$	☒	Art.number	$d_1 \times d_2 \times b$	☒	Art.number	$d_1 \times d_2 \times b$	☒	Art.number
5X10X6MM	25	51370.050.001	16X28X12MM	5	51370.160.001	35X56X16MM	2	51370.350.001
6X12X8MM	25	51370.060.001	18X32X14MM	5	51370.180.001	36X56X16MM	1	51370.360.001
8X16X8MM	25	51370.080.001	20X32X14MM	5	51370.200.001	40X63X18MM	1	51370.400.001
10X20X10MM	10	51370.100.001	22X36X14MM	5	51370.220.001	45X70X18MM	1	51370.450.001
12X22X12MM	10	51370.120.001	25X40X16MM	5	51370.250.001	50X80X18MM	1	51370.500.001
14X25X12MM	10	51370.140.001	28X45X16MM	2	51370.280.001	60X90X20MM	1	51370.600.001
15X25X12MM	10	51370.150.001	30X45X16MM	2	51370.300.001			

51372 Adjusting ring with slotted set screw DIN ≈705A/EN 27434 (DIN 553)				R09A
Material	Stainless steel A1		DIN ≈705A/27434	
				

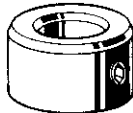
$d_1 \times d_2 \times b$	☒	Art.number	$d_1 \times d_2 \times b$	☒	Art.number	$d_1 \times d_2 \times b$	☒	Art.number
5X10X6MM	25	51372.050.001	16X28X12MM	5	51372.160.001	34X50X16MM	2	51372.340.001
6X12X8MM	25	51372.060.001	20X32X14MM	5	51372.200.001	35X56X16MM	2	51372.350.001
8X16X8MM	25	51372.080.001	24X40X16MM	5	51372.240.001	36X56X16MM	1	51372.360.001
9X18X10MM	10	51372.090.001	25X40X16MM	5	51372.250.001	38X56X16MM	1	51372.380.001
10X20X10MM	10	51372.100.001	26X40X16MM	5	51372.260.001	40X63X18MM	1	51372.400.001
11X20X10MM	10	51372.110.001	28X45X16MM	2	51372.280.001	45X70X18MM	1	51372.450.001
12X22X12MM	10	51372.120.001	30X45X16MM	2	51372.300.001	50X80X18MM	1	51372.500.001
15X25X12MM	10	51372.150.001	32X50X16MM	2	51372.320.001			

51371 Adjusting ring with hexagon socket set screw DIN ≈705A/ISO 4027 (DIN 914)				R09A
Material	Stainless steel A2		DIN ≈705A/4027	
				

$d_1 \times d_2 \times b$	☒	Art.number	$d_1 \times d_2 \times b$	☒	Art.number	$d_1 \times d_2 \times b$	☒	Art.number
5X10X6MM*	100	51371.050.001	18X32X14MM*	25	51371.180.001	35X56X16MM*	10	51371.350.001
6X12X8MM*	100	51371.060.001	20X32X14MM*	25	51371.200.001	36X56X16MM*	10	51371.360.001
8X16X8MM*	100	51371.080.001	22X36X14MM*	25	51371.220.001	38X56X16MM*	10	51371.380.001
9X16X8MM*	100	51371.090.001	24X40X16MM*	25	51371.240.001	40X63X18MM*	10	51371.400.001
10X20X10MM*	50	51371.100.001	25X40X16MM*	25	51371.250.001	45X70X18MM*	5	51371.450.001
11X20X10MM*	50	51371.110.001	26X40X16MM*	25	51371.260.001	50X80X18MM*	5	51371.500.001
12X22X12MM*	50	51371.120.001	28X45X16MM*	25	51371.280.001	55X80X18MM*	5	51371.550.001
13X22X12MM*	50	51371.130.001	30X45X16MM*	25	51371.300.001	60X90X20MM*	5	51371.600.001
14X25X12MM*	50	51371.140.001	32X16X50MM*	10	51371.320.001	65X100X20MM*	5	51371.650.001
15X25X12MM*	50	51371.150.001	34X50X16MM*	10	51371.340.001	70X100X20MM*	5	51371.700.001
16X28X12MM	50	51371.160.001						

Adjusting ring with 2 set screws DIN 705A/2 x ISO 4027 (DIN 914)

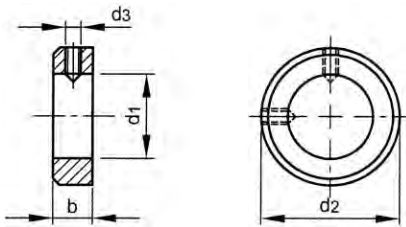

DIN 705A/4027 (914)

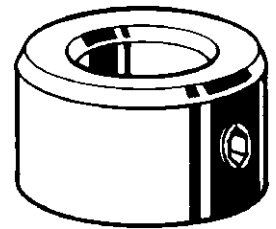

Technical Data

d ₁ (H8)	b	d ₁	d ₂	d ₃
75	22	75	110	12
80	22	80	110	12
90	22	90	125	12

51373 Adjusting rings with 2 hexagon socket set screw

R09A

Material Class Stainless steel A2
50

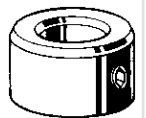

d ₁ x d ₂ x b	Art.number	d ₁ x d ₂ x b	Art.number	d ₁ x d ₂ x b	Art.number
75X110X22MM*	5 51373.750.001	80X110X22MM*	5 51373.800.001	90X125X22MM*	5 51373.900.001

Shim ring

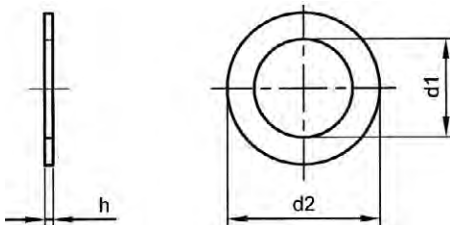

DIN 988

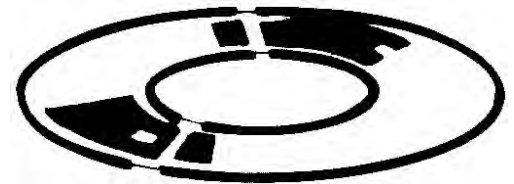

Technical Data

d ₁ x d ₂	d ₁ (max.)	d ₁ (min.)	d ₂ (max.)	d ₂ (min.)
3x6	3.12	3.02	5.97	5.85
4x8	4.15	4.03	7.96	7.81
5x10	5.15	5.03	9.96	9.81
6x12	6.15	6.03	11.95	11.77
6x18 (#DIN)	6.15	6.03	17.95	17.77
7x13	7.15	7.04	12.95	12.77
8x14	8.19	8.04	13.95	13.77
8x20 (#DIN)	8.16	8.04	19.95	19.77
9x15	9.19	9.04	14.95	14.77
10x16	10.19	10.04	15.95	15.77
10x18 (#DIN)	10.19	10.04	15.95	17.77
10x22 (#DIN)	10.19	10.04	21.935	21.725
11x17	11.23	11.05	16.95	16.77
12x18	12.23	12.05	17.95	17.77
12x20 (#DIN)	12.23	12.05	19.935	19.725
12x24 (#DIN)	12.23	12.05	23.935	23.725
13x19	13.23	13.05	17.95	17.77
14x20	14.23	14.05	19.935	19.725
14x26 (#DIN)	14.23	14.03	25.935	25.725
15x21	15.23	15.05	20.935	20.725
16x22	16.23	16.05	21.935	21.725
16x26 (#DIN)	16.23	16.05	25.935	25.275
16x28 (#DIN)	16.23	16.05	27.935	27.275
17x24	17.23	17.05	23.935	23.725
18x25	18.23	18.05	24.935	24.725
18x30 (#DIN)	18.23	18.05	29.735	29.725
19x26	19.275	19.065	25.935	25.725
20x28	20.275	20.065	27.935	27.725



Technical Data				
d₁ x d₂	d₁ (max.)	d₁ (min.)	d₂ (max.)	d₂ (min.)
20x32 (#DIN)	20.275	20.065	31.92	31.67
22x30	22.275	22.065	29.935	29.725
22x32	22.275	22.065	31.92	31.67
22x34 (#DIN)	22.275	22.065	33.92	33.67
24x36 (#DIN)	24.275	24.065	35.92	35.67
25x35	25.275	25.065	34.92	34.67
25x36	25.275	25.065	35.92	35.67
26x37	26.275	26.065	36.92	36.67
26x38 (#DIN)	26.275	26.065	37.92	37.67
28x40	28.275	28.065	39.92	39.67
30x35 (#DIN)	30.275	30.065	34.92	34.67
30x40 (#DIN)	30.275	30.065	39.92	39.67
30x42	30.275	30.065	41.92	41.67
32x44 (#DIN)	32.33	32.08	43.92	43.67
32x45	32.33	32.08	44.92	44.67
34x46 (#DIN)	34.33	34.08	45.92	45.67
35x45	35.33	35.08	44.92	44.67
36x45	36.33	36.08	44.92	44.67
36x48 (#DIN)	36.33	36.08	47.92	47.67
37x47	37.33	37.08	46.92	46.67
38x50 (#DIN)	38.33	38.08	49.92	49.67
40x50	40.33	40.08	49.92	49.67
40x52 (#DIN)	40.33	40.08	51.9	51.6
42x52	42.33	42.08	51.9	51.6
42x54 (#DIN)	43.33	42.08	53.9	53.6
44x56 (#DIN)	44.33	44.08	55.9	55.6
45x55	45.33	45.08	54.9	54.6
45x56	45.33	45.08	55.9	55.6
46x58 (#DIN)	46.33	46.08	57.9	57.6
48x60	48.33	48.08	59.9	59.6
50x62	50.33	50.08	61.9	61.6
50x63	50.33	50.08	62.9	62.6
52x65	52.4	52.1	64.9	64.6
55x68	55.4	55.1	67.9	67.6
56x68 (#DIN)	56.4	56.1	67.9	67.6
56x70	56.4	56.1	69.9	69.6
56x72	56.4	56.1	71.9	71.6
60x72 (#DIN)	60.4	60.1	71.9	71.6
60x75	60.4	60.1	74.9	74.6
63x80	63.4	63.1	79.9	79.6
65x80 (#DIN)	65.4	65.1	79.9	79.6
65x85	65.4	65.1	84.88	84.53
70x85 (#DIN)	70.4	70.1	84.88	84.53
70x90	70.4	70.1	89.88	89.53
75x90 (#DIN)	75.4	75.1	89.88	89.53
75x95	75.4	75.1	94.88	94.53
80x100	80.4	80.1	99.88	99.53
85x105	85.47	85.12	104.88	104.53
90x110	90.47	90.12	109.88	109.53
95x110 (#DIN)	95.47	95.12	109.88	109.53
100x120	100.47	100.12	119.88	119.53
100x125	100.47	100.12	124.855	124.455
105x125 (#DIN)	105.47	105.12	124.855	124.455
105x130	105.47	105.12	129.855	129.455
110x130 (#DIN)	110.47	110.12	129.855	129.455
110x140	110.47	110.12	139.855	139.455
120x140 (#DIN)	120.47	120.12	139.855	139.455
120x150	120.47	120.12	149.855	149.455
130x150 (#DIN)	130.545	130.145	149.855	149.455
130x160	130.545	130.145	159.855	159.455
140x170	140.545	140.145	169.855	169.455
150x180	150.545	150.145	179.855	179.455
160x180 (#DIN)	160.545	160.145	179.855	179.455
160x190	160.545	160.145	189.83	189.37
170x200	170.545	170.145	199.83	199.37
185x215 (#DIN)	185.47	185.12	214.83	214.37

Article groups



Material		Code	Page
St 2 K 50 vlgs DIN1624	h=0,1mm	38600	7-138
St.St. A2	h=0,1mm	51552	7-138
St.St. A2	h=0,2mm	51554	7-138
St 2 K 50 vlgs DIN1624	h=0,25mm	38602	7-139
St 2 K 50 vlgs DIN1624	h=0,3mm	38583	7-139
St.St. A2	h=0,3mm	51556	7-139
St 2 K 50 vlgs DIN1624	h=0,5mm	38585	7-139
St.St. A2	h=0,5mm	51555	7-140
St 2 K 50 vlgs DIN1624	h=1,0mm	38590	7-140
St.St. A2	h=1,0mm	51557	7-140

38600	Shim ring thickness h=0,1mm	L07H
Material	Steel 2 K 50 vlgs DIN1624	
		

d ₁ x d ₂	☒	Art.number	d ₁ x d ₂	☒	Art.number	d ₁ x d ₂	☒	Art.number
8X14MM	100	38600.080.014	22X34MM	50	38600.220.034	42X52MM	25	38600.420.052
8X20MM	100	38600.080.020	24X36MM	50	38600.240.036	50X62MM	25	38600.500.062
10X16MM	100	38600.100.016	25X35MM	50	38600.250.035	56X70MM	25	38600.560.070
10X22MM	100	38600.100.022	26X38MM	50	38600.260.038	56X72MM	10	38600.560.072
12X18MM	100	38600.120.018	28X40MM	50	38600.280.040	63X80MM	25	38600.630.080
12X24MM	100	38600.120.024	30X35MM	50	38600.300.035	75X90MM	10	38600.750.090
14X26MM	100	38600.140.026	30X42MM	50	38600.300.042	80X100MM	10	38600.800.100
16X28MM	50	38600.160.028	32X44MM	25	38600.320.044	90X110MM	10	38600.900.110
17X24MM	50	38600.170.024	34X46MM	25	38600.340.046	105X125MM	10	38600.983.125
18X25MM	50	38600.180.025	36X48MM	25	38600.360.048	110X140MM	5	38600.984.140
18X30MM	50	38600.180.030	37X47MM	50	38600.370.047	120X140MM	10	38600.986.140
20X28MM	50	38600.200.028	38X50MM	25	38600.380.050	140X170MM	5	38600.990.170
20X32MM	50	38600.200.032	40X50MM	25	38600.400.050			

51552	Shim ring thickness h=0,1mm	R05A
Material	Stainless steel A2	
		

d ₁ x d ₂	☒	Art.number	d ₁ x d ₂	☒	Art.number	d ₁ x d ₂	☒	Art.number
5X10MM*	100	51552.050.010	16X22MM*	100	51552.160.022	28X40MM*	100	51552.280.040
6X12MM	100	51552.060.012	20X28MM*	100	51552.200.028	30X42MM*	100	51552.300.042
10X16MM	100	51552.100.016	25X35MM*	100	51552.250.035	40X50MM*	100	51552.400.050
12X18MM	100	51552.120.018						

51554	Shim ring thickness h=0,2mm	R05A
Material	Stainless steel A2	
		

d ₁ x d ₂	☒	Art.number	d ₁ x d ₂	☒	Art.number	d ₁ x d ₂	☒	Art.number
4X8MM	100	51554.040.008	11X17MM*	100	51554.110.017	15X21MM	100	51554.150.021
5X10MM*	100	51554.050.010	12X18MM*	100	51554.120.018	16X22MM*	100	51554.160.022
6X12MM	100	51554.060.012	13X19MM*	100	51554.130.019	20X28MM*	100	51554.200.028
8X14MM*	100	51554.080.014	14X20MM*	100	51554.140.020	25X35MM*	100	51554.250.035
10X16MM	100	51554.100.016						

38602	Shim ring thickness h=0,25mm	L07H
Material	Steel 2 K 50 vlgS DIN1624	
		

$d_1 \times d_2$	☒	Art.number	$d_1 \times d_2$	☒	Art.number	$d_1 \times d_2$	☒	Art.number
8X20MM	100	38602.080.020	18X30MM	50	38602.180.030	38X50MM	25	38602.380.050
10X16MM	100	38602.100.016	20X32MM	50	38602.200.032	42X54MM	25	38602.420.054
10X22MM	100	38602.100.022	22X34MM	50	38602.220.034	44X56MM	25	38602.440.056
12X20MM	100	38602.120.020	24X36MM	50	38602.240.036	46X58MM	25	38602.460.058
12X24MM	100	38602.120.024	26X38MM	50	38602.260.038	48X60MM	25	38602.480.060
14X26MM	100	38602.140.026	32X44MM	25	38602.320.044	50X62MM	25	38602.500.062
16X26MM	100	38602.160.026	34X46MM	25	38602.340.046	56X68MM	25	38602.560.068
16X28MM	50	38602.160.028	36X48MM	25	38602.360.048	60X72MM	25	38602.600.072

38583	Shim ring thickness h=0,3mm	L07H
Material	Steel 2 K 50 vlgS DIN1624	
		

$d_1 \times d_2$	☒	Art.number	$d_1 \times d_2$	☒	Art.number	$d_1 \times d_2$	☒	Art.number
3X6MM	100	38583.030.006	25X35MM	50	38583.250.035	65X80MM	10	38583.650.080
4X8MM	100	38583.040.008	25X36MM	50	38583.250.036	65X85MM	10	38583.650.085
5X10MM	100	38583.050.010	26X37MM	50	38583.260.037	70X90MM	10	38583.700.090
6X12MM	100	38583.060.012	28X40MM	50	38583.280.040	75X90MM	10	38583.750.090
8X14MM	100	38583.080.014	30X35MM	50	38583.300.035	80X100MM	10	38583.800.100
10X16MM	100	38583.100.016	30X42MM	50	38583.300.042	85X105MM	10	38583.850.105
12X18MM	100	38583.120.018	32X45MM	25	38583.320.045	90X110MM	10	38583.900.110
14X20MM	100	38583.140.020	35X45MM	25	38583.350.045	95X110MM	10	38583.950.110
15X21MM	100	38583.150.021	36X45MM	25	38583.360.045	100X120MM	10	38583.982.120
16X22MM	50	38583.160.022	37X47MM	25	38583.370.047	105X125MM	10	38583.983.125
17X24MM	50	38583.170.024	40X50MM	25	38583.400.050	110X130MM	10	38583.984.130
18X25MM	50	38583.180.025	42X52MM	25	38583.420.052	110X140MM	10	38583.984.140
19X26MM	50	38583.190.026	45X55MM	25	38583.450.055	130X160MM	10	38583.988.160
20X28MM	50	38583.200.028	50X62MM	25	38583.500.062	140X170MM	10	38583.990.170
22X30MM	50	38583.220.030	56X72MM	25	38583.560.072	160X180MM	10	38583.993.180
22X32MM	50	38583.220.032	60X75MM	25	38583.600.075	185X215MM	10	38583.996.215
24X36MM	50	38583.240.036	63X80MM	10	38583.630.080			

7

51556	Shim ring thickness h=0,3mm	R05A
Material	Stainless steel A2	
		

$d_1 \times d_2$	☒	Art.number	$d_1 \times d_2$	☒	Art.number	$d_1 \times d_2$	☒	Art.number
5X10MM*	100	51556.050.010	14X20MM*	100	51556.140.020	17X24MM*	100	51556.170.024
6X12MM*	100	51556.060.012	16X22MM*	100	51556.160.022	20X28MM*	100	51556.200.028
12X18MM*	100	51556.120.018						



38585	Shim ring thickness h=0,5mm	L07H
Material	Steel 2 K 50 vlgS DIN1624	
		

$d_1 \times d_2$	☒	Art.number	$d_1 \times d_2$	☒	Art.number	$d_1 \times d_2$	☒	Art.number
3X6MM	100	38585.030.006	19X26MM	50	38585.190.026	40X50MM	25	38585.400.050
4X8MM	100	38585.040.008	20X28MM	50	38585.200.028	42X52MM	25	38585.420.052
5X10MM	100	38585.050.010	22X32MM	50	38585.220.032	45X55MM	10	38585.450.055
6X12MM	100	38585.060.012	25X35MM	50	38585.250.035	50X62MM	10	38585.500.062
8X14MM	100	38585.080.014	26X37MM	50	38585.260.037	56X72MM	10	38585.560.072
10X16MM	100	38585.100.016	28X40MM	50	38585.280.040	60X75MM	10	38585.600.075
12X18MM	100	38585.120.018	30X42MM	50	38585.300.042	63X80MM	10	38585.630.080
14X20MM	100	38585.140.020	32X45MM	25	38585.320.045	65X80MM	10	38585.650.080
16X22MM	50	38585.160.022	35X45MM	25	38585.350.045	70X85MM	10	38585.700.085
17X24MM	50	38585.170.024	36X45MM	25	38585.360.045	70X90MM	10	38585.700.090
18X25MM	50	38585.180.025	37X47MM	25	38585.370.047	75X90MM	10	38585.750.090



38585 Shim ring thickness h=0,5mm								
d ₁ x d ₂	☒	Art.number	d ₁ x d ₂	☒	Art.number	d ₁ x d ₂	☒	Art.number
80X100MM	10	38585.800.100	110X130MM	10	38585.984.130	140X170MM	5	38585.990.170
90X110MM	10	38585.900.110	110X140MM	10	38585.984.140	150X180MM	5	38585.992.180
100X120MM	10	38585.981.120	130X150MM	5	38585.988.150	160X180MM	5	38585.993.180
105X125MM	10	38585.983.125	130X160MM	5	38585.988.160			

51555 Shim ring thickness h=0,5mm		R05A
Material	Stainless steel A2	
		

d ₁ x d ₂	☒	Art.number	d ₁ x d ₂	☒	Art.number	d ₁ x d ₂	☒	Art.number
4X8MM*	100	51555.040.008	14X20MM*	100	51555.140.020	25X35MM*	100	51555.250.035
5X10MM	100	51555.050.010	15X21MM	100	51555.150.021	28X40MM*	100	51555.280.040
6X12MM	100	51555.060.012	16X22MM*	100	51555.160.022	30X42MM*	100	51555.300.042
8X14MM	100	51555.080.014	17X24MM*	100	51555.170.024	35X45MM*	100	51555.350.045
10X16MM	100	51555.100.016	20X28MM*	100	51555.200.028	40X50MM*	100	51555.400.050
12X18MM	100	51555.120.018	22X30MM*	100	51555.220.030			

38590 Shim ring thickness h=1,0mm		L07H
Material	Steel 2 K 50 vlgS DIN1624	
		

d ₁ x d ₂	☒	Art.number	d ₁ x d ₂	☒	Art.number	d ₁ x d ₂	☒	Art.number
3X6MM	100	38590.030.006	16X22MM	50	38590.160.022	30X42MM	50	38590.300.042
4X8MM	100	38590.040.008	18X25MM	50	38590.180.025	32X45MM	25	38590.320.045
5X10MM	100	38590.050.010	20X28MM	50	38590.200.028	35X45MM	25	38590.350.045
6X12MM	100	38590.060.012	20X32MM	50	38590.200.032	36X45MM	25	38590.360.045
8X14MM	100	38590.080.014	22X32MM	50	38590.220.032	37X47MM	25	38590.370.047
10X16MM	100	38590.100.016	25X35MM	50	38590.250.035	40X50MM	25	38590.400.050
12X18MM	100	38590.120.018	26X37MM	50	38590.260.037	45X55MM	10	38590.450.055
12X24MM	100	38590.120.024	26X38MM	50	38590.260.038	50X62MM	10	38590.500.062
14X20MM	100	38590.140.020	28X40MM	50	38590.280.040	60X75MM	10	38590.600.075

51557 Shim ring thickness h=1,0mm		R05A
Material	Stainless steel A2	
		

d ₁ x d ₂	☒	Art.number	d ₁ x d ₂	☒	Art.number	d ₁ x d ₂	☒	Art.number
6X12MM*	100	51557.060.012	13X19MM*	100	51557.130.019	20X28MM	100	51557.200.028
8X14MM	100	51557.080.014	14X20MM*	100	51557.140.020	25X35MM*	100	51557.250.035
10X16MM	100	51557.100.016	15X21MM	100	51557.150.021	30X42MM*	100	51557.300.042
11X17MM*	100	51557.110.017	16X22MM	100	51557.160.022	35X45MM*	100	51557.350.045
12X18MM	100	51557.120.018	17X24MM*	100	51557.170.024			

Square washer

DIN 436

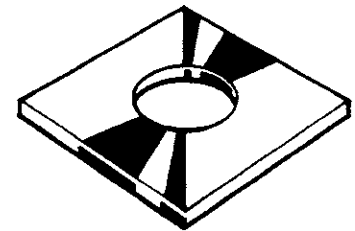
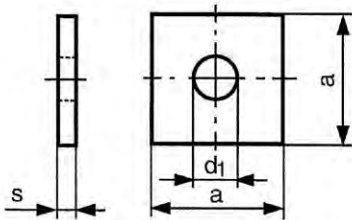

Technical Data

For nom.size	a	d ₁	s	For nom.size	a	d ₁	s
M8 (#DIN)	30	9	3	M22	70	24	6
M10	30	11	3	M24	80	26	6
M12	40	13.5	4	M27	90	30	6
M16	50	17.5	5	M30	95	33	6
M20	60	22	5				

Article groups

Material	Surface treatment	Code	Page
St		38300	7-141
St	Zipl	38310	7-141
St	Hot d.g.	38320	7-141
St.St. A2		51908	7-142
St.St. A4		55908	7-142

38300 Square washer L07G

Material: Steel

For nom. size	☒	Art.number	For nom. size	☒	Art.number	For nom. size	☒	Art.number
M8	100	38300.080.001	M16	100	38300.160.001	M22	50	38300.220.001
M10	100	38300.100.001	M20	50	38300.200.001	M24	25	38300.240.001
M12	100	38300.120.001						

38310 Square washer L07G



Material: Steel
Surface treatment: Zinc plated

For nom. size	☒	Art.number	For nom. size	☒	Art.number	For nom. size	☒	Art.number
M8	100	38310.080.001	M16	100	38310.160.001	M24	25	38310.240.001
M10	100	38310.100.001	M20	50	38310.200.001	M27	25	38310.270.001
M12	100	38310.120.001	M22	50	38310.220.001	M30	25	38310.300.001

38320 Square washer A08G

Material: Steel
Surface treatment: Hot dip galvanized

For nom. size	☒	Art.number	For nom. size	☒	Art.number	For nom. size	☒	Art.number
M8	100	38320.080.001	M16	100	38320.160.001	M24	25	38320.240.001
M10	100	38320.100.001	M20	50	38320.200.001	M27	25	38320.270.001
M12	100	38320.120.001	M22	50	38320.220.001	M30	10	38320.300.001

51908	Square washer			R09A
Material	Stainless steel A2	DIN	≈436	
				

For nom. size	☒	Art.number	For nom. size	☒	Art.number	For nom. size	☒	Art.number
M10	100	51908.100.001	M16	100	51908.160.001	M24	25	51908.240.001
M12	100	51908.120.001	M20	50	51908.200.001			

55908	Square washer			R49A
Material	Stainless steel A4	DIN	≈436	
				

For nom. size	☒	Art.number	For nom. size	☒	Art.number	For nom. size	☒	Art.number
M10	100	55908.100.001	M16	100	55908.160.001	M24	25	55908.240.001
M12	100	55908.120.001	M20	50	55908.200.001			

Square taper washer 14% for I-sections

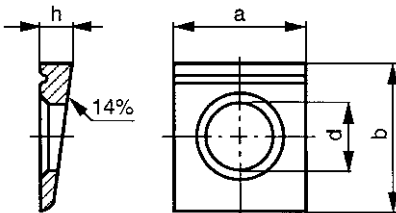

DIN 435
NEN 2273

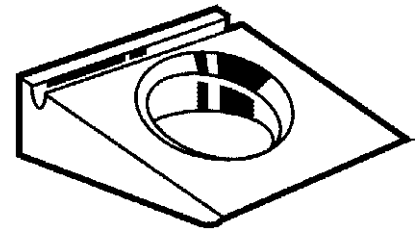

Technical Data

For nom.size	a	b	d	h	For nom.size	a	b	d	h
M8	22	22	9	4.6	M22	44	50	24	10
M10	22	22	11	4.6	M24	56	56	26	10.8
M12	26	30	13.5	6.2	M27	56	56	30	10.8
M16	32	36	17.5	7.5	M30 (#DIN)	62	62	33	11.7
M20	40	44	22	9.2	M33 (#DIN)	68	68	36	11.7

Article groups



Material	Surface treatment	Code	Page
St 100-250 HV10		38520	7-142
St 100-250 HV10	Hot d.g.	38540	7-143
St.St. A2		51922	7-143
St.St. A4		55922	7-143

38520	Square taper washer 14% for I-sections			L07G
Material	Steel 100-250 HV10			
				

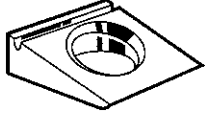

For nom. size	☒	Art.number	For nom. size	☒	Art.number	For nom. size	☒	Art.number
M8	100	38520.080.001	M16	100	38520.160.001	M22	50	38520.220.001
M10	100	38520.100.001	M20	50	38520.200.001	M24	25	38520.240.001
M12	100	38520.120.001						

38540	Square taper washer 14% for I-sections		A08G
Material	Steel 100-250 HV10		
Surface treatment	Hot dip galvanized		
			

For nom. size	☒	Art.number	For nom. size	☒	Art.number	For nom. size	☒	Art.number
M8	100	38540.080.001	M20	50	38540.200.001	M27	25	38540.270.001
M10	100	38540.100.001	M22	50	38540.220.001	M30	10	38540.300.001
M12	100	38540.120.001	M24	25	38540.240.001	M33	10	38540.330.001
M16	100	38540.160.001						

51922	Square taper washer 14% for I-sections		R09A
Material	Stainless steel A2		
		DIN ≈435 NEN ≈2273	
			

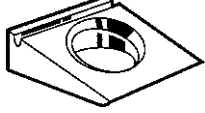
For nom. size	☒	Art.number	For nom. size	☒	Art.number	For nom. size	☒	Art.number
M8	50	51922.080.001	M16	50	51922.160.001	M22*	10	51922.220.001
M10	50	51922.100.001	M20*	25	51922.200.001	M24*	10	51922.240.001
M12	50	51922.120.001						

55922	Square taper washer 14% for I-sections		R49A
Material	Stainless steel A4		
		DIN ≈435 NEN ≈2273	
			

For nom. size	☒	Art.number	For nom. size	☒	Art.number	For nom. size	☒	Art.number
M8*	50	55922.080.001	M16	50	55922.160.001	M22*	10	55922.220.001
M10	50	55922.100.001	M20*	25	55922.200.001	M24*	10	55922.240.001
M12	50	55922.120.001						

Square taper washer 8% for U-sections

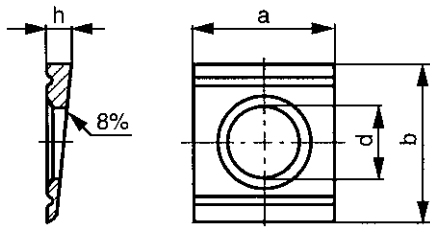

DIN 434
NEN 2272

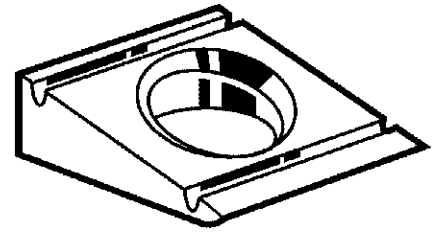

Technical Data

For nom.size	a	b	d	h	For nom.size	a	b	d	h
M8	22	22	9	3.8	M22	44	50	24	8
M10	22	22	11	3.8	M24	56	56	26	8.5
M12	26	30	13.5	4.9	M27	56	56	30	8.5
M14 (#DIN)	26.2	30.1	16.3	5.5	M30 (#DIN)	56	56	33	8.5
M16	32	36	17.5	5.9	M33 (#DIN)	56	56	36	8.5
M20	40	44	22	7					

Article groups

Material	Surface treatment	Code	Page
St 100-250 HV10		38500	7-144
St 100-250 HV10	Zipl	38495	7-144
St 100-250 HV10	Hot d.g.	38490	7-144
St.St. A2		51920	7-145
St.St. A4		55920	7-145

38500 Square taper washer 8% for U-sections L07G

Material Steel 100-250 HV10



For nom. size	Art.number	For nom. size	Art.number	For nom. size	Art.number
M8	100 38500.080.001	M16	100 38500.160.001	M27	25 38500.270.001
M10	100 38500.100.001	M20	50 38500.200.001	M30	10 38500.300.001
M12	100 38500.120.001	M22	50 38500.220.001	M33	10 38500.330.001
M14	100 38500.140.001	M24	25 38500.240.001		

38495 Square taper washer 8% for U-sections L07G

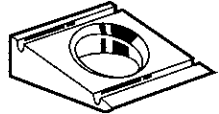

Material Steel 100-250 HV10
Surface treatment Zinc plated

For nom. size	Art.number	For nom. size	Art.number	For nom. size	Art.number
M8	200 38495.080.001	M12	100 38495.120.001	M20	50 38495.200.001
M10	200 38495.100.001	M16	100 38495.160.001	M24	50 38495.240.001

38490 Square taper washer 8% for U-sections A08G

Material Steel 100-250 HV10
Surface treatment Hot dip galvanized





For nom. size	Art.number	For nom. size	Art.number	For nom. size	Art.number
M8	100 38490.080.001	M20	50 38490.200.001	M27	25 38490.270.001
M10	100 38490.100.001	M22	50 38490.220.001	M30	10 38490.300.001
M12	100 38490.120.001	M24	25 38490.240.001	M33	10 38490.330.001
M16	100 38490.160.001				

51920 Square taper washer 8% for U-sections						R09A		
Material		Stainless steel A2		DIN	≈434			
				NEN	≈2272			
For nom. size	☒	Art.number	For nom. size	☒	Art.number	For nom. size	☒	Art.number
M8	50	51920.080.001	M16	50	51920.160.001	M22*	10	51920.220.001
M10	50	51920.100.001	M20	25	51920.200.001	M24*	10	51920.240.001
M12	50	51920.120.001						

55920 Square taper washer 8% for U-sections						R49A		
Material		Stainless steel A4		DIN	≈434			
				NEN	≈2272			
For nom. size	☒	Art.number	For nom. size	☒	Art.number	For nom. size	☒	Art.number
M8	50	55920.080.001	M16	50	55920.160.001	M24*	10	55920.240.001
M10	50	55920.100.001	M20	25	55920.200.001	M30*	10	55920.300.001
M12	50	55920.120.001	M22*	10	55920.220.001			

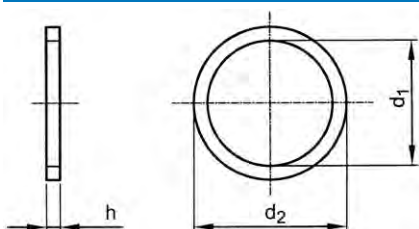
Sealing ring



DIN 7603 A/C

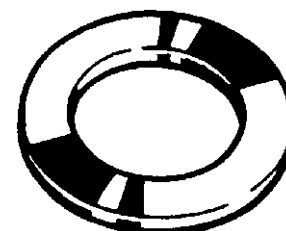

Technical Data

$d_1 \times d_2 \times h$	d_1	d_2	$d_1 \times d_2 \times h$	d_1	d_2
4x8x1	4.2	7.9	12x15.5x1.5	12.2	15.4
5x7.5x1	5.2	7.9	12x16x1 (#DIN)	12.2	15.9
5x9x1	5.2	8.9	12x16x1.5	12.2	15.9
5x9x1.5	5.2	8.9	12x16x2	12.2	15.9
5x10x1 (#DIN)	5.2	9.9	12x17x1.5	12.2	16.9
6x10x1	6.2	9.9	12x18x1.5	12.2	17.9
6x10x1.5	6.2	9.9	12x18x2	12.2	17.9
6x12x1 (#DIN)	6.2	11.9	12x20x1.5 (#DIN)	12.2	19.9
6x12x1.5 (#DIN)	6.2	11.9	12.5x20x1.5 (#DIN)	12.7	19.9
6.5x9.5x1	6.7	9.4	13x18x1.5 (#DIN)	13.2	17.9
7x10x1 (#DIN)	7.2	9.9	13x18x2 (#DIN)	13.2	17.9
7x15x2 (#DIN)	7.1	14.9	14x18x1 (#DIN)	14.2	17.9
8x11.5x1	8.2	11.4	14x18x1.5	14.2	17.9
8x11.5x1.5	8.2	11.4	14x18x2	14.2	17.9
8x12x1	8.2	11.9	14x18x2 (#DIN)	14.2	17.9
8x12x1.5	8.2	11.9	14x20x1 (#DIN)	14.2	19.9
8x13x1	8.2	12.9	14x20x1.5	14.2	19.9
8x14x1	8.2	13.9	14x20x2	14.2	19.9
8x14x1.5	8.2	13.9	14x20x2 (#DIN)	14.2	19.9
9x14x1 (#DIN)	9.2	13.9	14x22x1.5 (#DIN)	14.2	21.9
9x14x1.5 (#DIN)	9.2	13.9	15x19x1.5	15.2	18.9
10x13.5x1	10.2	13.4	15x20x1 (#DIN)	15.2	19.9
10x13.5x1.5	10.2	13.4	15x20x1.5 (#DIN)	15.2	19.9
10x14x1	10.2	13.9	15x20x2 (#DIN)	15.2	19.9
10x14x1.5	10.2	13.9	16x20x1.5	16.2	19.9
10x15x1	10.2	14.9	16x20x2	16.2	19.9
10x16x1	10.2	15.9	16x20x2 (#DIN)	16.2	19.9
10x16x1.5	10.2	15.9	16x21x2 (#DIN)	16.2	20.9
10x19x2 (#DIN)	10.2	18.9	16x22x1.5	16.2	21.9
10x20x1.5 (#DIN)	10.2	19.9	16x22x2	16.2	21.9
10.5x17x1.5 (#DIN)	10.7	16.9	16x22x2 (#DIN)	16.2	21.9
11x17x1.5 (#DIN)	11.2	16.9	16.5x24x2 (#DIN)	16.7	23.9

Technical Data			Technical Data		
d ₁ x d ₂ x h	d ₁	d ₂	d ₁ x d ₂ x h	d ₁	d ₂
17x21x1.5	17.2	20.9	26x32x2.5	26.3	31.9
17x21x2	17.2	20.9	26x33x2 (#DIN)	26.3	32.9
17x22x1.5 (#DIN)	17.2	21.9	26x34x2	26.3	33.9
17x23x1.5	17.2	22.9	26x34x2.5	26.3	33.9
17x23x2	17.2	22.9	27x32x2	27.3	31.9
17x24x2 (#DIN)	17.2	23.9	27x32x2.5	27.3	31.9
17.5x25x2 (#DIN)	17.7	24.9	28x33x1 (#DIN)	28.3	32.9
18x22x1.5	18.2	21.9	28x34x2 (#DIN)	28.3	33.9
18x22x2	18.2	21.9	28x34x2.5 (#DIN)	28.3	33.9
18x24x1.5	18.2	23.9	30x36x2	30.3	35.9
18x24x2	18.2	23.9	30x36x2.5	30.3	35.9
18x24x2 (#DIN)	18.2	23.9	30x38x2	30.3	37.9
19x26x2 (#DIN)	19.2	25.9	30x38x2.5	30.3	37.9
20x24x1.5	20.2	23.9	32x38x2	32.3	37.9
20x24x2	20.2	23.9	32x38x2.5	32.3	37.9
20x24x2 (#DIN)	20.2	23.9	32x40x2	32.3	39.9
20x26x1.5	20.2	25.9	33x39x2	33.3	38.9
20x26x2	20.2	25.9	33x39x2.5	33.3	38.9
21x26x1.5	21.2	25.9	35x41x2	35.3	40.9
21x26x2	21.2	25.9	35x41x2.5	35.3	40.9
21x26x2 (#DIN)	21.2	25.9	35x45x2 (#DIN)	35.3	44.9
21x28x1.5 (#DIN)	21.2	27.9	36x42x2	36.3	41.9
21x28x2 (#DIN)	21.2	27.9	36x42x2.5	36.3	41.9
22x26x2 (#DIN)	22.2	25.9	38x44x2	38.3	43.9
22x27x1.5	22.2	26.9	38x44x2.5	38.3	43.9
22x27x2	22.2	26.9	40x47x2	40.3	46.9
22x29x1.5	22.2	28.9	40x47x2.5	40.3	46.9
22x29x2	22.2	28.9	42x49x2	42.3	48.9
22x29x2 (#DIN)	22.2	28.9	42x49x2.5	42.3	48.9
24x29x2	24.3	28.9	45x52x2	44.3	51.9
24x29x2.5	24.3	28.9	45x52x2.5 (#DIN)	45.3	51.9
24x30x2 (#DIN)	24.3	29.9	48x55x2	48.3	54.9
24x30x2.5 (#DIN)	24.3	29.9	48x55x2.5	48.3	54.9
24x32x2	24.3	31.9	50x57x2	50.2	56.9
24x32x2.5	24.3	31.9	60x68x2.5	60.5	67.8
26x31x2	26.3	30.9	75x84x2.5	75.5	83.8
26x32x2	26.3	31.9	90x100x2.5	90.5	99.8

7

Article groups			
Material		Code	Page
Al 99F11	h=1,0mm	45191	7-146
Al 99F11	h=1,5mm	45192	7-147
Al 99F11	h=2,0mm	45193	7-147
Cu	h=1,0mm	50300	7-147
Cu	h=1,5mm	50301	7-147
Cu	h=2,0mm	50302	7-148
Cu	h=2,5mm	50303	7-148
Cu/FESTAPLAN	h=1,5mm	50332	7-148
Cu/FESTAPLAN	h=2,0mm	50333	7-148
Cu/FESTAPLAN	h=2,5mm	50334	7-149

45191 Sealing ring annealed hardness HB 32-45 h=1mm				W01D
Material	Aluminium 99F11	DIN	7603 A	
				

d ₁ x d ₂	Art.number	d ₁ x d ₂	Art.number	d ₁ x d ₂	Art.number
4X8MM	100 45191.040.008	6,5X9,5MM	100 45191.065.009	8X14MM	100 45191.080.014
5X7,5MM	100 45191.050.007	8X11,5MM	100 45191.080.011	10X13,5MM	100 45191.100.013
5X9MM	100 45191.050.009	8X12MM	100 45191.080.012	10X14MM	100 45191.100.014
6X10MM	100 45191.060.010	8X13MM	100 45191.080.013	10X16MM	100 45191.100.016
6X12MM (#DIN)	100 45191.060.012				

- Applicable for pipe-connections and screw plugs.

45192 Sealing ring annealed hardness HB 32-45 h=1,5mm				W01D
Material	Aluminium 99F11	DIN	7603 A	

d ₁ x d ₂	☒	Art.number	d ₁ x d ₂	☒	Art.number	d ₁ x d ₂	☒	Art.number
12X15,5MM	100	45192.120.015	15X19MM	100	45192.150.019	18X24MM	100	45192.180.024
12X16MM	100	45192.120.016	16X20MM	100	45192.160.020	20X24MM	50	45192.200.024
12X17MM	100	45192.120.017	16X22MM	100	45192.160.022	20X26MM	50	45192.200.026
12X18MM	100	45192.120.018	17X21MM	100	45192.170.021	21X28MM (≠DIN)	50	45192.210.028
13X18MM (≠DIN)	100	45192.130.018	17X23MM	100	45192.170.023	22X27MM	50	45192.220.027
14X18MM	100	45192.140.018	18X22MM	100	45192.180.022	22X29MM	50	45192.220.029
14X20MM	100	45192.140.020						

• Applicable for pipe-connections and screw plugs.

45193 Sealing ring annealed hardness HB 32-45 h=2mm				W01D
Material	Aluminium 99F11	DIN	7603 A	

d ₁ x d ₂	☒	Art.number	d ₁ x d ₂	☒	Art.number	d ₁ x d ₂	☒	Art.number
24X29MM	50	45193.240.029	28X34MM (≠DIN)	10	45193.280.034	40X47MM	10	45193.400.047
24X30MM (≠DIN)	50	45193.240.030	30X36MM	10	45193.300.036	42X49MM	10	45193.420.049
26X31MM	50	45193.260.031	30X38MM	10	45193.300.038	48X55MM	10	45193.480.055
26X32MM	50	45193.260.032	32X38MM	10	45193.320.038	50X57MM	10	45193.500.057
26X34MM	10	45193.260.034	33X39MM	10	45193.330.039			
27X32MM	10	45193.270.032	35X41MM	10	45193.350.041			

• Applicable for pipe-connections and screw plugs.

50300 Sealing ring annealed h=1mm				M03A
Material	Copper	DIN	7603 A	



d ₁ x d ₂	☒	Art.number	d ₁ x d ₂	☒	Art.number	d ₁ x d ₂	☒	Art.number
5X10MM (≠DIN)	100	50300.050.010	8X14MM	100	50300.080.014	14X18MM (≠DIN)	50	50300.140.018
6X10MM	100	50300.060.010	9X14MM (≠DIN)	100	50300.090.014	14X20MM (≠DIN)	50	50300.140.020
6X12MM	100	50300.060.012	10X14MM	100	50300.100.014	15X20MM (≠DIN)	50	50300.150.020
6,5X9,5MM	100	50300.065.009	10X15MM	100	50300.100.015	28X33MM	100	50300.280.033
7X10MM (≠DIN)	100	50300.070.010	10X16MM	100	50300.100.016			
8X12MM	100	50300.080.012	12X16MM (≠DIN)	50	50300.120.016			



• Applicable for pipe-connections and screw plugs.

50301 Sealing ring annealed h=1,5mm				M03A
Material	Copper	DIN	7603 A	





d ₁ x d ₂	☒	Art.number	d ₁ x d ₂	☒	Art.number	d ₁ x d ₂	☒	Art.number
6X10MM	100	50301.060.010	12X18MM	50	50301.120.018	17X21MM	50	50301.170.021
8X14MM	100	50301.080.014	12X20MM (≠DIN)	50	50301.120.020	17X22MM (≠DIN)	50	50301.170.022
9X14MM (≠DIN)	100	50301.090.014	12,5X20MM (≠DIN)	50	50301.125.020	18X22MM	25	50301.180.022
10X14MM	100	50301.100.014	13X18MM (≠DIN)	50	50301.130.018	18X24MM	25	50301.180.024
10X16MM	100	50301.100.016	14X18MM	50	50301.140.018	20X24MM	25	50301.200.024
10X20MM (≠DIN)	100	50301.100.020	14X20MM	50	50301.140.020	20X26MM	25	50301.200.026
10,5X17MM (≠DIN)	100	50301.105.017	14X22MM (≠DIN)	50	50301.140.022	21X26MM	25	50301.210.026
11X17MM (≠DIN)	100	50301.110.017	15X20MM (≠DIN)	50	50301.150.020	21X28MM (≠DIN)	25	50301.210.028
12X16MM	50	50301.120.016	16X20MM	50	50301.160.020	22X27MM	25	50301.220.027
12X17MM	50	50301.120.017	16X22MM	50	50301.160.022	22X29MM	25	50301.220.029

• Applicable for pipe-connections and screw plugs.

50302	Sealing ring annealed h=2mm	M03A
Material	Copper	DIN 7603 A
		 

$d_1 \times d_2$	☒	Art.number	$d_1 \times d_2$	☒	Art.number	$d_1 \times d_2$	☒	Art.number
7,1X15MM (#DIN)	100	50302.071.015	19X26MM (#DIN)	25	50302.190.026	28X34MM (#DIN)	10	50302.280.034
10X19MM (#DIN)	100	50302.100.019	20X24MM (#DIN)	25	50302.200.024	30X36MM	10	50302.300.036
13X18MM (#DIN)	50	50302.130.018	21X26MM (#DIN)	25	50302.210.026	30X38MM	10	50302.300.038
14X18MM (#DIN)	50	50302.140.018	21X28MM (#DIN)	25	50302.210.028	32X38MM	10	50302.320.038
14X20MM (#DIN)	50	50302.140.020	22X26MM (#DIN)	25	50302.220.026	32X40MM	10	50302.320.040
15X20MM (#DIN)	50	50302.150.020	22X29MM (#DIN)	25	50302.220.029	33X39MM	10	50302.330.039
16X20MM (#DIN)	50	50302.160.020	24X30MM (#DIN)	25	50302.240.030	35X45MM (#DIN)	10	50302.350.045
16X21MM (#DIN)	50	50302.160.021	24X32MM	25	50302.240.032	36X42MM	10	50302.360.042
16X22MM (#DIN)	50	50302.160.022	26X31MM	10	50302.260.031	38X44MM	10	50302.380.044
16,5X24MM (#DIN)	25	50302.165.024	26X32MM	10	50302.260.032	40X47MM	10	50302.400.047
17X24MM (#DIN)	25	50302.170.024	26X33MM (#DIN)	10	50302.260.033	45X52MM	10	50302.450.052
17,5X25MM (#DIN)	25	50302.175.025	26X34MM	10	50302.260.034	50X57MM	10	50302.500.057
18X24MM (#DIN)	25	50302.180.024						



- Applicable for pipe-connections and screw plugs.

50303	Sealing ring annealed h=2,5mm	M03A
Material	Copper	DIN 7603 A
		 

$d_1 \times d_2$	☒	Art.number	$d_1 \times d_2$	☒	Art.number	$d_1 \times d_2$	☒	Art.number
60X68MM	10	50303.600.068	75X84MM	10	50303.750.084	90X100MM	10	50303.900.100



- Applicable for pipe-connections and screw plugs.

7

50332	Sealing ring filled h=1,5mm	M03A
Material	Copper/FESTAPLAN	DIN 7603 C
		 



$d_1 \times d_2$	☒	Art.number	$d_1 \times d_2$	☒	Art.number	$d_1 \times d_2$	☒	Art.number
5X9MM	100	50332.050.009	8X11,5MM	100	50332.080.011	10X13,5MM	100	50332.100.013
6X10MM	100	50332.060.010	8X12MM	100	50332.080.012	10X14MM	100	50332.100.014
6X12MM (#DIN)	100	50332.060.012	8X14MM	100	50332.080.014	10X16MM	100	50332.100.016

- Mineral fibres with the tradename FESTAPLAN.
- Suitable for applications with a temperature of max. 180°C.

50333	Sealing ring filled h=2mm	M03A
Material	Copper/FESTAPLAN	DIN 7603 C
		 

$d_1 \times d_2$	☒	Art.number	$d_1 \times d_2$	☒	Art.number	$d_1 \times d_2$	☒	Art.number
12X16MM	100	50333.120.016	16X22MM	100	50333.160.022	20X26MM	50	50333.200.026
12X18MM	100	50333.120.018	17X21MM	100	50333.170.021	21X26MM	50	50333.210.026
13X18MM (#DIN)	100	50333.130.018	17X23MM	100	50333.170.023	22X27MM	50	50333.220.027
14X18MM	100	50333.140.018	18X22MM	100	50333.180.022	22X29MM	50	50333.220.029
14X20MM	100	50333.140.020	18X24MM	50	50333.180.024			
16X20MM	100	50333.160.020	20X24MM	50	50333.200.024			

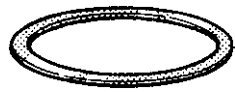
- Mineral fibres with the tradename FESTAPLAN.
- Suitable for applications with a temperature of max. 180°C.

50334	Sealing ring filled h=2,5mm	M03A
Material	Copper/FESTAPLAN	DIN 7603 C
		
		

$d_1 \times d_2$	☒	Art.number	$d_1 \times d_2$	☒	Art.number	$d_1 \times d_2$	☒	Art.number
24X29MM	25	50334.240.029	28X34MM (#DIN)	25	50334.280.034	36X42MM	25	50334.360.042
24X30MM (#DIN)	25	50334.240.030	30X36MM	25	50334.300.036	38X44MM	25	50334.380.044
24X32MM	25	50334.240.032	30X38MM	25	50334.300.038	40X47MM	25	50334.400.047
26X32MM	25	50334.260.032	32X38MM	25	50334.320.038	42X49MM	25	50334.420.049
26X34MM	25	50334.260.034	33X39MM	25	50334.330.039	45X52MM (#DIN)	10	50334.450.052
27X32MM	25	50334.270.032	35X41MM	25	50334.350.041	48X55MM	10	50334.480.055

- Mineral fibres with the tradename FESTAPLAN.
- Suitable for applications with a temperature of max. 180°C.

Packing ring (Jointing ring)

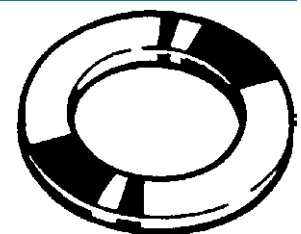
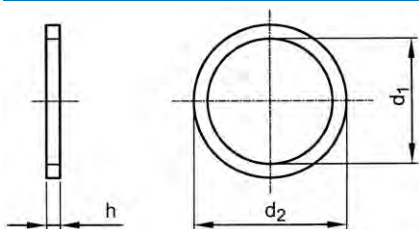

50900	Packing ring (Jointing ring) h=1mm	W05C
Material	Vulcanized fibre Vf3110 DIN 737	
		

$d_1 \times d_2$	☒	Art.number	$d_1 \times d_2$	☒	Art.number	$d_1 \times d_2$	☒	Art.number
3X5MM	200	50900.030.005	8,5X14MM	200	50900.085.014	18X24MM	100	50900.180.024
3,5X6MM	200	50900.035.006	9X14MM	200	50900.090.014	19X23MM	100	50900.190.023
4X6,5MM	200	50900.040.006	9,5X14MM	200	50900.095.014	20X24MM	100	50900.200.024
4,5X8MM	200	50900.045.008	10X14MM	200	50900.100.014	22X26MM	50	50900.220.026
5X8MM	200	50900.050.008	10,5X17MM	200	50900.105.017	24X28MM	50	50900.240.028
5X10MM	200	50900.050.010	11X17MM	200	50900.110.017	25X34MM	50	50900.250.034
5,5X9MM	200	50900.055.009	12X16MM	200	50900.120.016	26X33MM	50	50900.260.033
6X9MM	200	50900.060.009	12,5X18MM	100	50900.125.018	28X40MM	50	50900.280.040
6X10MM	200	50900.060.010	13X18MM	100	50900.130.018	30X42MM	50	50900.300.042
6X12MM	200	50900.060.012	14X18MM	100	50900.140.018	32X44MM	25	50900.320.044
6,5X10MM	200	50900.065.010	15X19MM	100	50900.150.019	34X46MM	25	50900.340.046
7X10MM	200	50900.070.010	16X20MM	100	50900.160.020	36X48MM	25	50900.360.048
8X12MM	200	50900.080.012	16X21MM	100	50900.160.021	38X50MM	25	50900.380.050
8X16MM	200	50900.080.016	17X22MM	100	50900.170.022	40X52MM	25	50900.400.052

Flat washer for Toyota

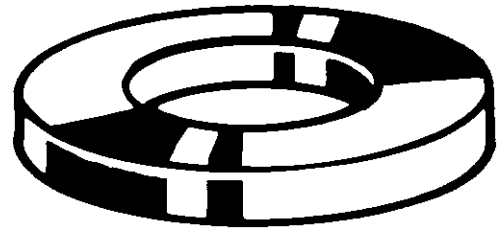
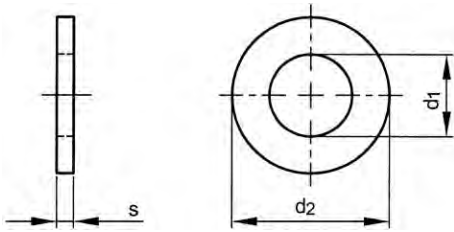

72037	Flat washer Special for Toyota	Y92E
Material	Vulcanized fibre	

$d_1 \times d_2 \times s$	☒	Art.number	$d_1 \times d_2 \times s$	☒	Art.number
12X24X2MM	25	72037.120.020	18X28X2MM	25	72037.180.020

Bonded seal with rubber

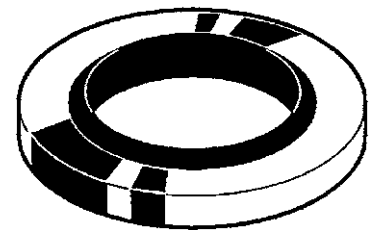
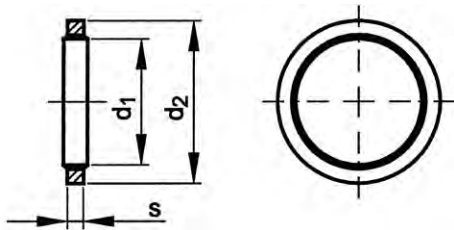

- Special features of bonded seals:
- Are particularly suitable for screw connections, pipe joints, hose couplings etc.
- The sealing lip of NBR (nitrile rubber) is resistant to mineral oil, water, gas and numerous other media.

Article groups

Material	Surface treatment	Code	Page
St	Zipl	38793	7-150
St	Zipl	38796	7-150

38793	Bonded seal with rubber	L07G
Material	Steel	
Surface treatment	Zinc plated	

$d_1 \times d_2 \times s$	☒	Art.number	$d_1 \times d_2 \times s$	☒	Art.number	$d_1 \times d_2 \times s$	☒	Art.number
4,5X7X1MM	100	38793.052.100	12,7X18X1,5MM	100	38793.145.150	22,7X30X2MM	25	38793.257.200
5,7X10X1MM	100	38793.067.100	12,7X20X1,5MM	100	38793.147.150	24,7X32X2MM	25	38793.279.200
6,7X11X1MM	100	38793.078.100	14,7X22X1,5MM	50	38793.169.150	26,7X35X2MM	25	38793.302.200
7,1X12X1MM	100	38793.083.100	16,7X24X1,5MM	50	38793.191.150	27,2X36X2MM	25	38793.308.200
8,7X16X1MM	100	38793.103.100	18,7X26X1,5MM	50	38793.213.150	28,7X37X2MM	25	38793.324.200
10,7X18X1,5MM	100	38793.125.150	20,7X28X1,5MM	50	38793.235.150	31X39X2MM	10	38793.349.200

38796	Bonded seal with rubber, self centering	L07G
Material	Steel	
Surface treatment	Zinc plated	

$d_1 \times d_2 \times s$	☒	Art.number	$d_1 \times d_2 \times s$	☒	Art.number	$d_1 \times d_2 \times s$	☒	Art.number
13,34X6,99X1,22	50	38796.000.010	26,92X19,69X2,34	25	38796.000.017	42,8X33,89X3,25	10	38796.000.023
13,34X8,31X1,22	50	38796.000.011	28,58X21,54X2,34	10	38796.000.018	47,75X38,96X3,25	10	38796.000.025
15,88X10,37X2,03	50	38796.000.012	31,75X23,49X2,34	10	38796.000.019	52,38X42,93X3,25	10	38796.000.026
20,57X13,74X2,03	50	38796.000.014	34,93X27,05X2,34	10	38796.000.020	69,85X54,89X3,25	10	38796.000.027
25,4X16,51X2,03	25	38796.000.015	36,58X29,33X2,34	10	38796.000.021	15,9X10,5X2,1	10	38796.000.221
23,8X17,28X2,03	25	38796.000.016	41,4X32,64X3,25	10	38796.000.022			

O-ring

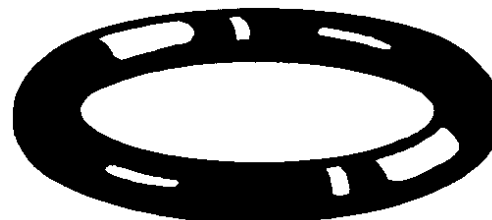
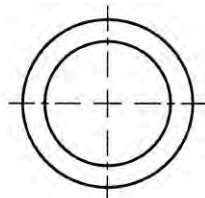
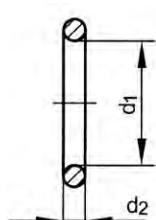

• d_1 = Inside diameter.

Article groups

Material		Color	Code	Page
Rubber NBR 70° Shore A	d2=1,5mm	Black	38801	7-151
Rubber NBR 70° Shore A	d2=1,6mm	Black	38802	7-151
Rubber NBR 70° Shore A	d2=1,78mm	Black	38803	7-152
Rubber NBR 70° Shore A	d2=2,0mm	Black	38805	7-152
Rubber NBR 70° Shore A	d2=2,4mm	Black	38806	7-152
Rubber NBR 70° Shore A	d2=2,5mm	Black	38807	7-152
Rubber NBR 70° Shore A	d2=2,62mm	Black	38808	7-153
Rubber NBR 70° Shore A	d2=3,0mm	Black	38810	7-153
Rubber NBR 70° Shore A	d2=3,53mm	Black	38812	7-154
Rubber NBR 70° Shore A	d2=4,0mm	Black	38814	7-154
Rubber NBR 70° Shore A	d2=5,0mm	Black	38816	7-154
Rubber FPM 80° Shore	d2=1,6mm	Black	38869	7-155
Rubber FPM 80° Shore	d2=1,78mm	Black	38871	7-155
Rubber FPM 80° Shore	d2=1,9mm	Black	38873	7-155
Rubber FPM 80° Shore	d2=2,0mm	Black	38874	7-155
Rubber FPM 80° Shore	d2=2,4mm	Black	38875	7-155
Rubber FPM 80° Shore	d2=2,62mm	Black	38877	7-156
Rubber FPM 80° Shore	d2=3,53mm	Black	38883	7-156
Rubber FPM 80° Shore	d2=4,0mm	Black	38885	7-156
Rubber FPM 80° Shore	d2=5,0mm	Black	38887	7-156

38801 O-ring, d2=1,5MM

W05A

Material Rubber NBR 70° Shore A
Color Black



d_1	☒	Art.number	d_1	☒	Art.number	d_1	☒	Art.number
3,0MM	50	38801.003.001	7,0MM	50	38801.007.001	9,0MM	50	38801.009.001
5,0MM	50	38801.005.001	7,5MM	50	38801.007.501	35,0MM	10	38801.035.001
6,0MM	50	38801.006.001	8,0MM	50	38801.008.001			

38802 O-ring, d2=1,6MM

W05A

Material Rubber NBR 70° Shore A
Color Black



d_1	☒	Art.number	d_1	☒	Art.number	d_1	☒	Art.number
3,1MM	50	38802.003.101	12,1MM	25	38802.012.101	21,1MM	25	38802.021.101
4,1MM	50	38802.004.101	13,1MM	25	38802.013.101	22,1MM	10	38802.022.101
5,1MM	50	38802.005.101	14,1MM	25	38802.014.101	25,1MM	10	38802.025.101
6,1MM	50	38802.006.101	15,1MM	25	38802.015.101	27,1MM	10	38802.027.101
7,1MM	50	38802.007.101	16,1MM	25	38802.016.101	29,1MM	10	38802.029.101
8,1MM	50	38802.008.101	17,1MM	25	38802.017.101	32,1MM	10	38802.032.101
9,1MM	50	38802.009.101	18,1MM	25	38802.018.101	35,1MM	10	38802.035.101
10,1MM	25	38802.010.101	19,1MM	25	38802.019.101	37,1MM	10	38802.037.101
11,1MM	25	38802.011.101	20,1MM	25	38802.020.101			

38803 O-ring, AS 568A d2=1,78MM W05A

Material Rubber NBR 70° Shore A
Color Black



d ₁	☒	Art.number	d ₁	☒	Art.number	d ₁	☒	Art.number
1,78-AS 004	50	38803.001.781	10,82-AS 013	50	38803.010.821	34,65-AS 028	10	38803.034.651
2,57-AS 005	50	38803.002.571	11,11MM	50	38803.011.111	36,27MM	10	38803.036.271
2,90-AS 006	50	38803.002.901	12,42-AS 014	50	38803.012.421	37,82-AS 029	10	38803.037.821
3,17MM	50	38803.003.171	14,00-AS 015	50	38803.014.001	41,00-AS 030	10	38803.041.001
3,68-AS 007	50	38803.003.681	15,60-AS 016	25	38803.015.601	44,17-AS 031	10	38803.044.171
3,69-AS 007	50	38803.003.691	17,16-AS 017	25	38803.017.161	47,37-AS 032	10	38803.047.371
4,48-AS 008	50	38803.004.481	18,77-AS 018	25	38803.018.771	50,52-AS 033	10	38803.050.521
4,76MM	50	38803.004.761	20,35-AS 019	25	38803.020.351	53,67-AS 034	5	38803.053.671
5,28-AS 009	50	38803.005.281	21,95-AS 020	25	38803.021.951	56,87-AS 035	5	38803.056.871
6,07-AS 010	50	38803.006.071	25,12-AS 022	10	38803.025.121	60,04MM	5	38803.060.041
6,35MM	50	38803.006.351	26,70-AS 023	10	38803.026.701	63,22-AS 037	5	38803.063.221
6,75MM	50	38803.006.751	28,30-AS 024	10	38803.028.301	66,40-AS 038	5	38803.066.401
7,66-AS 011	50	38803.007.661	29,87-AS 025	10	38803.029.871	69,57-AS 039	5	38803.069.571
7,94MM	50	38803.007.941	31,47-AS 026	10	38803.031.471	72,76-AS 040	5	38803.072.761
8,73MM	50	38803.008.731	33,05-AS 027	10	38803.033.051	82,28-AS 042	5	38803.082.281
9,25-AS 012	50	38803.009.251						

38805 O-ring, d2=2,0MM W05A

Material Rubber NBR 70° Shore A
Color Black



d ₁	☒	Art.number	d ₁	☒	Art.number	d ₁	☒	Art.number
4,0MM	50	38805.004.001	18,0MM	25	38805.018.001	36,0MM	10	38805.036.001
5,0MM	50	38805.005.001	19,0MM	25	38805.019.001	37,0MM	10	38805.037.001
5,5MM	50	38805.005.501	20,0MM	10	38805.020.001	38,0MM	10	38805.038.001
6,0MM	50	38805.006.001	21,0MM	10	38805.021.001	40,0MM	10	38805.040.001
7,0MM	50	38805.007.001	22,0MM	10	38805.022.001	42,0MM	10	38805.042.001
8,0MM	50	38805.008.001	23,0MM	10	38805.023.001	43,0MM	10	38805.043.001
9,0MM	50	38805.009.001	24,0MM	10	38805.024.001	45,0MM	10	38805.045.001
10,0MM	50	38805.010.001	25,0MM	10	38805.025.001	46,0MM	10	38805.046.001
11,0MM	50	38805.011.001	26,0MM	10	38805.026.001	47,0MM	10	38805.047.001
12,0MM	50	38805.012.001	27,0MM	10	38805.027.001	50,0MM	10	38805.050.001
13,0MM	25	38805.013.001	28,0MM	10	38805.028.001	53,0MM	5	38805.053.001
14,0MM	25	38805.014.001	30,0MM	10	38805.030.001	55,0MM	5	38805.055.001
15,0MM	25	38805.015.001	32,0MM	10	38805.032.001	56,0MM	5	38805.056.001
16,0MM	25	38805.016.001	33,0MM	10	38805.033.001	58,0MM	5	38805.058.001
17,0MM	25	38805.017.001	35,0MM	10	38805.035.001			

38806 O-ring, d2=2,4mm W05A

Material Rubber NBR 70° Shore A
Color Black



d ₁	☒	Art.number	d ₁	☒	Art.number	d ₁	☒	Art.number
5,3MM	50	38806.005.301	9,3MM	50	38806.009.301	14,3MM	25	38806.014.301
6,3MM	50	38806.006.301	10,3MM	50	38806.010.301	16,3MM	25	38806.016.301
7,3MM	50	38806.007.301	11,3MM	50	38806.011.301	17,3MM	25	38806.017.301
8,0MM	50	38806.008.001	12,3MM	50	38806.012.301	20,3MM	25	38806.020.301
8,3MM	50	38806.008.301	13,3MM	50	38806.013.301	25,3MM	25	38806.025.301

38807 O-ring, d2=2,5mm W05A

Material Rubber NBR 70° Shore A
Color Black



d ₁	☒	Art.number	d ₁	☒	Art.number	d ₁	☒	Art.number
5,0MM	50	38807.005.001	8,0MM	50	38807.008.001	11,0MM	50	38807.011.001
6,0MM	50	38807.006.001	9,0MM	50	38807.009.001	12,0MM	50	38807.012.001
7,0MM	50	38807.007.001	10,0MM	50	38807.010.001	13,0MM	50	38807.013.001

38807 O-ring, d2=2,5mm								
d ₁	☒	Art.number	d ₁	☒	Art.number	d ₁	☒	Art.number
14,0MM	25	38807.014.001	23,0MM	10	38807.023.001	32,0MM	10	38807.032.001
15,0MM	25	38807.015.001	24,0MM	10	38807.024.001	35,0MM	10	38807.035.001
16,0MM	25	38807.016.001	25,0MM	10	38807.025.001	36,0MM	10	38807.036.001
17,0MM	25	38807.017.001	26,0MM	10	38807.026.001	38,0MM	10	38807.038.001
18,0MM	10	38807.018.001	27,0MM	10	38807.027.001	39,0MM	10	38807.039.001
19,0MM	10	38807.019.001	28,0MM	10	38807.028.001	40,0MM	10	38807.040.001
20,0MM	10	38807.020.001	29,0MM	10	38807.029.001	44,0MM	10	38807.044.001
21,0MM	10	38807.021.001	30,0MM	10	38807.030.001			
22,0MM	10	38807.022.001	31,0MM	10	38807.031.001			

38808 O-ring, AS 568A d2=2,62mm		W05A
Material	Rubber NBR 70° Shore A	
Color	Black	

d ₁	☒	Art.number	d ₁	☒	Art.number	d ₁	☒	Art.number
9,19-AS 110	50	38808.009.191	22,22MM	10	38808.022.221	50,47-AS 136	5	38808.050.471
9,92MM	50	38808.009.921	23,47-AS 119	10	38808.023.471	52,07-AS 137	5	38808.052.071
10,78-AS 111	50	38808.010.781	23,81MM	10	38808.023.811	55,25-AS 139	5	38808.055.251
11,91MM	50	38808.011.911	25,07-AS 120	10	38808.025.071	56,82-AS 140	5	38808.056.821
12,37-AS 112	50	38808.012.371	26,64MM	10	38808.026.641	58,42-AS 141	5	38808.058.421
12,70MM	50	38808.012.701	29,82-AS 123	10	38808.029.821	60,00-AS 142	5	38808.060.001
13,10MM	25	38808.013.101	31,42-AS 124	10	38808.031.421	61,60-AS 143	5	38808.061.601
13,95-AS 113	25	38808.013.951	33,00-AS 125	10	38808.033.001	63,17-AS 144	5	38808.063.171
15,08MM	25	38808.015.081	34,59-AS 126	10	38808.034.591	64,77-AS 145	5	38808.064.771
15,54-AS 114	25	38808.015.541	36,17-AS 127	10	38808.036.171	67,95-AS 147	5	38808.067.951
15,88MM	25	38808.015.881	37,77-AS 128	10	38808.037.771	69,52-AS 148	5	38808.069.521
17,13-AS 115	25	38808.017.131	39,34-AS 129	10	38808.039.341	71,12-AS 149	5	38808.071.121
17,86MM	25	38808.017.861	40,95-AS 130	10	38808.040.951	74,30MM	5	38808.074.301
18,72-AS 116	25	38808.018.721	44,12-AS 132	10	38808.044.121	80,60MM	5	38808.080.601
20,29-AS 117	10	38808.020.291	45,69-AS 133	10	38808.045.691	82,22-AS 152	5	38808.082.221
20,63MM	10	38808.020.631	47,29-AS 134	10	38808.047.291	83,80MM	5	38808.083.801
21,89-AS 118	10	38808.021.891	48,90-AS 135	10	38808.048.901	94,93MM	5	38808.094.931

38810 O-ring, d2=3,0mm		W05A
Material	Rubber NBR 70° Shore A	
Color	Black	

d ₁	☒	Art.number	d ₁	☒	Art.number	d ₁	☒	Art.number
5,0MM	50	38810.005.001	26,0MM	10	38810.026.001	52,0MM	5	38810.052.001
6,0MM	50	38810.006.001	26,2MM	10	38810.026.201	54,5MM	5	38810.054.501
7,0MM	50	38810.007.001	27,0MM	10	38810.027.001	56,0MM	5	38810.056.001
8,0MM	50	38810.008.001	28,0MM	10	38810.028.001	58,0MM	5	38810.058.001
9,0MM	50	38810.009.001	29,0MM	10	38810.029.001	59,0MM	5	38810.059.001
10,0MM	50	38810.010.001	30,0MM	10	38810.030.001	62,0MM	5	38810.062.001
11,0MM	50	38810.011.001	31,0MM	10	38810.031.001	64,5MM	5	38810.064.501
12,0MM	50	38810.012.001	32,0MM	10	38810.032.001	66,0MM	5	38810.066.001
13,0MM	50	38810.013.001	33,0MM	10	38810.033.001	72,0MM	5	38810.072.001
14,0MM	25	38810.014.001	34,0MM	10	38810.034.001	74,5MM	5	38810.074.501
15,0MM	25	38810.015.001	35,0MM	10	38810.035.001	78,0MM	5	38810.078.001
16,0MM	25	38810.016.001	36,0MM	10	38810.036.001	79,5MM	5	38810.079.501
17,0MM	25	38810.017.001	37,0MM	10	38810.037.001	84,5MM	5	38810.084.501
18,0MM	25	38810.018.001	38,0MM	10	38810.038.001	89,5MM	5	38810.089.501
19,0MM	25	38810.019.001	39,0MM	10	38810.039.001	108,0MM	5	38810.108.001
20,0MM	25	38810.020.001	40,0MM	10	38810.040.001	119,5MM	5	38810.119.501
20,2MM	10	38810.020.201	41,0MM	10	38810.041.001	175,0MM	5	38810.175.001
21,0MM	10	38810.021.001	42,0MM	10	38810.042.001	180,0MM	5	38810.180.001
22,0MM	10	38810.022.001	43,0MM	10	38810.043.001	195,0MM	5	38810.195.001
22,2MM	10	38810.022.201	44,0MM	10	38810.044.001	210,0MM	5	38810.210.001
23,0MM	10	38810.023.001	45,0MM	10	38810.045.001	220,0MM	5	38810.220.001
24,0MM	10	38810.024.001	46,0MM	10	38810.046.001	245,0MM	5	38810.245.001
24,2MM	10	38810.024.201	47,0MM	10	38810.047.001	250,0MM	5	38810.250.001
25,0MM	10	38810.025.001	48,0MM	10	38810.048.001	300,0MM	5	38810.300.001

38812	O-ring, AS 568A d2=3,53mm	W05A
Material Color	Rubber NBR 70° Shore A Black	

d ₁	☒	Art.number	d ₁	☒	Art.number	d ₁	☒	Art.number
18,64-AS 210	25	38812.018.641	44,45MM	10	38812.044.451	72,62-AS 233	5	38812.072.621
20,22-AS 211	10	38812.020.221	46,04MM	10	38812.046.041	74,60MM	5	38812.074.601
21,82-AS 212	10	38812.021.821	47,22-AS 225	10	38812.047.221	78,97-AS 235	5	38812.078.971
23,40-AS 213	10	38812.023.401	49,21MM	10	38812.049.211	82,14-AS 236	5	38812.082.141
24,99-AS 214	10	38812.024.991	50,40MM	5	38812.050.401	85,32-AS 237	5	38812.085.321
25,80MM	10	38812.025.801	50,80-AS 226	5	38812.050.801	91,67-AS 238	5	38812.091.671
26,58-AS 215	10	38812.026.581	52,39MM	5	38812.052.391	94,84-AS 240	5	38812.094.841
28,17-AS 216	10	38812.028.171	53,57-AS 227	5	38812.053.571	98,02-AS 241	5	38812.098.021
29,75-AS 217	10	38812.029.751	53,98MM	5	38812.053.981	101,20-AS 242	5	38812.101.201
31,34-AS 218	10	38812.031.341	55,56MM	5	38812.055.561	104,37-AS 243	5	38812.104.371
32,92-AS 219	10	38812.032.941	57,15MM	5	38812.057.151	107,54-AS 244	5	38812.107.541
34,52-AS 220	10	38812.034.521	58,74MM	5	38812.058.741	110,72-AS 245	5	38812.110.721
36,10-AS 221	10	38812.036.101	59,92-AS 229	5	38812.059.921	117,07-AS 247	5	38812.117.071
37,69-AS 222	10	38812.037.691	60,33MM	5	38812.060.331	123,42-AS 249	5	38812.123.421
39,69MM	10	38812.039.691	66,27-AS 231	5	38812.066.271	132,94-AS 252	5	38812.132.941
40,87-AS 223	10	38812.040.871	68,26MM	5	38812.068.261	136,12-AS 253	5	38812.136.121
41,28MM	10	38812.041.281	69,44-AS 232	5	38812.069.441	142,47-AS 255	5	38812.142.471
42,86MM	10	38812.042.861	69,85MM	5	38812.069.851	151,99-AS 258	5	38812.151.991
44,04-AS 224	10	38812.044.041	71,44MM	5	38812.071.441			

38814	O-ring, d2=4,0mm	W05A
Material Color	Rubber NBR 70° Shore A Black	

d ₁	☒	Art.number	d ₁	☒	Art.number	d ₁	☒	Art.number
9,0MM	50	38814.009.001	30,0MM	10	38814.030.001	55,0MM	5	38814.055.001
10,0MM	50	38814.010.001	32,0MM	10	38814.032.001	58,0MM	5	38814.058.001
12,0MM	25	38814.012.001	34,0MM	10	38814.034.001	59,0MM	5	38814.059.001
14,0MM	25	38814.014.001	35,0MM	10	38814.035.001	60,0MM	5	38814.060.001
16,0MM	25	38814.016.001	36,0MM	10	38814.036.001	64,0MM	5	38814.064.001
18,0MM	25	38814.018.001	38,0MM	10	38814.038.001	65,0MM	5	38814.065.001
19,0MM	25	38814.019.001	40,0MM	10	38814.040.001	66,0MM	5	38814.066.001
20,0MM	25	38814.020.001	42,0MM	10	38814.042.001	70,0MM	5	38814.070.001
21,0MM	25	38814.021.001	43,0MM	10	38814.043.001	72,0MM	5	38814.072.001
22,0MM	25	38814.022.001	44,0MM	10	38814.044.001	75,0MM	5	38814.075.001
23,0MM	25	38814.023.001	48,0MM	10	38814.048.001	78,0MM	5	38814.078.001
24,0MM	25	38814.024.001	49,0MM	10	38814.049.001	80,0MM	5	38814.080.001
25,0MM	10	38814.025.001	50,0MM	10	38814.050.001	87,0MM	5	38814.087.001
26,0MM	10	38814.026.001	52,0MM	5	38814.052.001	125,0MM	5	38814.125.001
28,0MM	10	38814.028.001						

38816	O-ring, d2=5,0mm	W05A
Material Color	Rubber NBR 70° Shore A Black	

d ₁	☒	Art.number	d ₁	☒	Art.number	d ₁	☒	Art.number
12,0MM	25	38816.012.001	22,0MM	10	38816.022.001	45,0MM	10	38816.045.001
15,0MM	25	38816.015.001	23,0MM	10	38816.023.001	48,0MM	10	38816.048.001
16,0MM	25	38816.016.001	25,0MM	10	38816.025.001	50,0MM	10	38816.050.001
17,0MM	25	38816.017.001	27,0MM	10	38816.027.001	55,0MM	5	38816.055.001
18,0MM	25	38816.018.001	30,0MM	10	38816.030.001	65,0MM	5	38816.065.001
19,0MM	25	38816.019.001	35,0MM	10	38816.035.001	70,0MM	5	38816.070.001
20,0MM	10	38816.020.001	40,0MM	10	38816.040.001	75,0MM	5	38816.075.001
21,0MM	10	38816.021.001						

7

38869 O-ring (Viton), d2=1,6mm W07A

Material Rubber FPM 80° Shore
Color Black



d ₁	☒	Art.number	d ₁	☒	Art.number	d ₁	☒	Art.number
2,2MM	50	38869.002.201	4,7MM	50	38869.004.701	10,1MM	25	38869.010.101
2,8MM	50	38869.002.801	5,1MM	50	38869.005.101	11,1MM	25	38869.011.101
3,1MM	50	38869.003.101	6,1MM	50	38869.006.101	12,1MM	25	38869.012.101
3,7MM	50	38869.003.701	7,1MM	50	38869.007.101	13,1MM	25	38869.013.101
4,1MM	50	38869.004.101	9,1MM	50	38869.009.101			

38871 O-ring (Viton), AS 568A d2=1,78mm W07A

Material Rubber FPM 80° Shore
Color Black



d ₁	☒	Art.number	d ₁	☒	Art.number	d ₁	☒	Art.number
2,90-AS 006	50	38871.002.901	6,07-AS 010	50	38871.006.071	12,42-AS 014	25	38871.012.421
3,69-AS 007	50	38871.003.691	7,65MM	50	38871.007.651	14,00MM	25	38871.014.001
4,48-AS 008	50	38871.004.481	9,25-AS 012	50	38871.009.251	15,60-AS 016	25	38871.015.601
5,28-AS 009	50	38871.005.281	10,82-AS 013	25	38871.010.821	17,17MM	25	38871.017.171

38873 O-ring (Viton), d2=1,9mm W07A

Material Rubber FPM 80° Shore
Color Black



d ₁	☒	Art.number	d ₁	☒	Art.number	d ₁	☒	Art.number
2,4MM	50	38873.002.401	4,2MM	50	38873.004.201	7,2MM	50	38873.007.201
2,6MM	50	38873.002.601	4,9MM	50	38873.004.901	8,9MM	50	38873.008.901
3,4MM	50	38873.003.401	5,7MM	50	38873.005.701			

38874 O-ring (Viton), d2=2,0mm W07A

Material Rubber FPM 80° Shore
Color Black



d ₁	☒	Art.number	d ₁	☒	Art.number	d ₁	☒	Art.number
4,0MM	50	38874.004.001	10,0MM	25	38874.010.001	16,0MM	25	38874.016.001
6,0MM	50	38874.006.001	12,0MM	25	38874.012.001	18,0MM	25	38874.018.001
8,0MM	50	38874.008.001	14,0MM	25	38874.014.001	20,0MM	10	38874.020.001

38875 O-ring (Viton), d2=2,4mm W07A

Material Rubber FPM 80° Shore
Color Black



d ₁	☒	Art.number	d ₁	☒	Art.number	d ₁	☒	Art.number
3,3MM	50	38875.003.301	8,3MM	50	38875.008.301	12,3MM	50	38875.012.301
4,3MM	50	38875.004.301	9,3MM	50	38875.009.301	13,3MM	25	38875.013.301
5,3MM	50	38875.005.301	10,3MM	25	38875.010.301	14,3MM	25	38875.014.301
6,3MM	50	38875.006.301	11,3MM	25	38875.011.301	15,3MM	25	38875.015.301
7,3MM	50	38875.007.301						

38877	O-ring (Viton), AS 568A d2=2,62mm		W07A
Material Color	Rubber FPM 80° Shore Black		

d₁	☒	Art.number	d₁	☒	Art.number	d₁	☒	Art.number
9,20MM	50	38877.009.201	15,54-AS 114	25	38877.015.541	20,30MM	10	38877.020.301
10,78-AS 111	25	38877.010.781	17,12MM	25	38877.017.121	21,90MM	10	38877.021.901
12,37-AS 112	25	38877.012.371	18,72-AS 116	25	38877.018.721	23,47-AS 119	10	38877.023.471
13,95-AS 113	25	38877.013.951						

38883	O-ring (Viton), AS 568A d2=3,53mm		W07A
Material Color	Rubber FPM 80° Shore Black		

d₁	☒	Art.number	d₁	☒	Art.number	d₁	☒	Art.number
18,64-AS 210	25	38883.018.641	26,57MM	10	38883.026.571	34,52-AS 220	10	38883.034.521
20,22-AS 211	10	38883.020.221	28,17-AS 216	10	38883.028.171	36,09MM	10	38883.036.091
21,82-AS 212	10	38883.021.821	29,74MM	10	38883.029.741	37,69MM	10	38883.037.691
23,39MM	10	38883.023.391	31,34-AS 218	10	38883.031.341	40,87-AS 223	10	38883.040.871
24,99-AS 214	10	38883.024.991	32,92MM	10	38883.032.921			

38885	O-ring (Viton), d2=4,0mm		W07A
Material Color	Rubber FPM 80° Shore Black		

d₁	☒	Art.number	d₁	☒	Art.number	d₁	☒	Art.number
30,0MM	10	38885.030.001	34,0MM	10	38885.034.001	38,0MM	10	38885.038.001
32,0MM	10	38885.032.001	35,0MM	10	38885.035.001	40,0MM	10	38885.040.001

38887	O-ring (Viton), d2=5,0mm		W07A
Material Color	Rubber FPM 80° Shore Black		

d₁	☒	Art.number	d₁	☒	Art.number	d₁	☒	Art.number
35,0MM	10	38887.035.001	45,0MM	10	38887.045.001	50,0MM	10	38887.050.001
40,0MM	10	38887.040.001						

7

O-ring wire

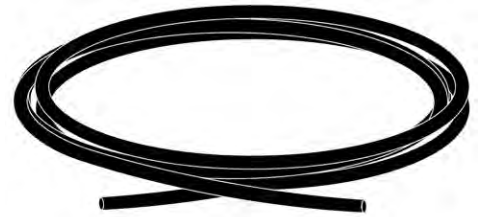
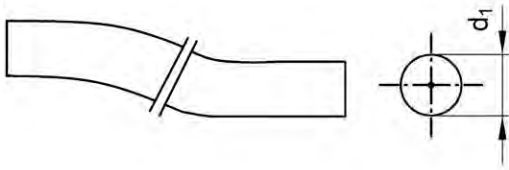

38840 NBR 70SH O-RING A 2 MTR W05A

Material Rubber NBR 70° Shore A
Color Black



d_1	☒	Art.number	d_1	☒	Art.number	d_1	☒	Art.number
1,78	1	38840.001.781	3,53	1	38840.003.531	5,7	1	38840.005.701
2,0	1	38840.002.001	4,0	1	38840.004.001	6,0	1	38840.006.001
2,40	1	38840.002.401	5,0	1	38840.005.001	6,99	1	38840.006.991
3,0	1	38840.003.001	5,34	1	38840.005.341	8,0	1	38840.008.001

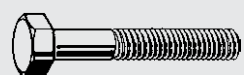

1 Bolts



2 Hexagon socket products



3 Nuts, rivet nuts & inserts



4 Threaded rods & studbolts



5 Hook & eye products



6 Screws

I Index



7 Washers & O-rings



8 Anchoring products

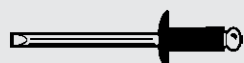

9 Rivets, pins & keys



10 Systems, furniture & security fasteners



11 Assortments & storage systems

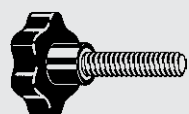

12 Engineering parts & machine parts

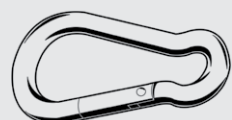































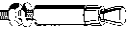



13 Maritime products

T Fastening technology

Anchoring products **8**

 Page 8-4 MAXXFAST UniFast	 Page 8-5 Nylon	 Page 8-7 FISCHER Type S	 Page 8-8 FISCHER Assortment	 Page 8-9 FISCHER Type MS
 Page 8-10 MAXXFAST MultiFast	 Page 8-10 FISCHER Type SX	 Page 8-12 MAXXFAST 4Fast	 Page 8-13 FISCHER Type UX/UX-R	 Page 8-14 FISCHER Universal type FU
 Page 8-15 Cavity fixing	 Page 8-16 FISCHER Type HM/HMS	 Page 8-17 Installation tools	 Page 8-18 MAXXFAST Plasterboard fixing	 Page 8-19 SPIT Driva
 Page 8-20 FISCHER Type GK/GKS	 Page 8-21 FISCHER Type GB	 Page 8-22 FISCHER Type FTP Steel	 Page 8-23 FISCHER Type FTP Plastic	 Page 8-24 FISCHER Installation tool FTP
 Page 8-25 Toggle plug	 Page 8-26 SPIT Type SDA	 Page 8-27 FISCHER Type FNH	 Page 8-28 MAXXFAST HammerFast	 Page 8-29 FISCHER Type N-Z
 Page 8-30 FISCHER Type N-FZ	 Page 8-31 FISCHER Type N-D	 Page 8-32 FISCHER Type SXS	 Page 8-33 MAXXFAST Frame anchor	 Page 8-34 MAXXFAST Frame anchor nylon
 Page 8-35 FISCHER Type F-S	 Page 8-36 FISCHER Type F-M	 Page 8-37 FISCHER Type FUR-T	 Page 8-38 FISCHER Type FUR-SS	 Page 8-39 FISCHER Type SXR
 Page 8-40 Frame screw	 Page 8-41 FISCHER Cover cap	 Page 8-42 FISCHER Type JS	 Page 8-43 FISCHER Type S/J/S	 Page 8-44 MAXXFAST Expanding plug
 Page 8-44 Expanding plug	 Page 8-45 Expansion shield anchor	 Page 8-46 Expansion shield Stainless steel	 Page 8-46 Expansion shield anchor, bolt projecting	 Page 8-47 Expansion shield anchor, loose bolt
 Page 8-48 FISCHER Type M	 Page 8-49 FISCHER Type PA 4	 Page 8-50 FISCHER Type FSA-S	 Page 8-51 RAWLPLUG	 Page 8-52 MAXXFAST Hammerset anchor

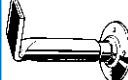
Anchoring products **8**

 Page 8-53 Hammerset anchor	 Page 8-55 Installation tool	 Page 8-56 Installation tool SA	 Page 8-56 FISCHER Type FHY	 Page 8-57 Anchoring screw WALLDOG
 Page 8-58 Anchoring screw WALLDOG	 Page 8-59 Anchoring screw TAPH	 Page 8-60 Anchoring screw TAPC	 Page 8-61 Concrete anchoring screw BT	 Page 8-62 Concrete anchoring screw A4 hexagon BT
 Page 8-63 Concrete anchoring screw BT	 Page 8-63 Concrete anchoring screw BT	 Page 8-64 Concrete anchoring screw BT	 Page 8-65 MAXXFAST ThruFast-ThruMaxx	 Page 8-67 Anchor bolt EXA
 Page 8-68 FISCHER Type FBN II	 Page 8-70 SPIT Type FIX 3	 Page 8-71 MAXXFAST High performance anchor Promaxx	 Page 8-73 FISCHER Type FAZ II	 Page 8-74 FISCHER Type FH II-B
 Page 8-76 FISCHER Type FH II-S	 Page 8-77 FISCHER Type FZA	 Page 8-78 FISCHER Tool	 Page 8-80 MAXXFAST Chemical fixing	 Page 8-81 FISCHER Type RGM
 Page 8-82 Rod	 Page 8-82 SPIT Type Maxima	 Page 8-83 FISCHER Setting tool	 Page 8-84 Capsule	 Page 8-85 Injection cartridge
 Page 8-87 Injection tool	 Page 8-88 MAXXFAST Anchoring	 Page 8-89 FISCHER Injection anchor sleeve	 Page 8-90 FISCHER Type RG MI	 Page 8-91 DIN 529 A Type A
 Page 8-92 DIN 529 E Type E	 Page 8-92 Hook anchor	 Page 8-95 Shuttering	 Page 8-95 Shuttering	 Page 8-97 VEMO Type 1550
 Page 8-97 VEMO Type 1551	 Page 8-98 VEMO Type 1140	 Page 8-98 VEMO Type 1130	 Page 8-99 VEMO Type 995G	 Page 8-100 VEMO Type 1036
 Page 8-101 VEMO Type 2244				

MaxxFast - A great range of quality anchors

MaxxFast introduces a whole range of high quality anchoring products. This range consists of nylon plugs, hammerplugs and throughbolts. These high quality products will answer your needs for the most demanding applications.

Plugs & anchors

Our UniFast nylon plug features a small flange to prevent it from going through the support.

The MultiFast nylon plug can be used in almost every construction material. The 4Fast 4-way expansion plug creates a very strong anchoring. The HammerFast hammer plug is very easy to use and reduces your installation time.

- Gypsum board plug
- Screw anchor and tool
- Expansion plug
- Frame anchor
- Drop-in anchor and tool

Throughbolts

The ThruFast throughbolts, available in zinc plated steel, and A2 stainless steel are excellent for regular anchoring applications. The ThruMaxx ETA7 approved throughbolts comply with the "European Organization for Technical Approval" and are available in zinc plated steel and A4 stainless steel. They offer both strength and reliability for the best possible results.

Also: ProMaxx ETA option 1. These high quality products will answer your needs for the most demanding applications.

- THRUFast zinc plated steel
- THRUFast A2 stainless steel
- THRUMAXX ETA7 zpl steel
- THRUMAXX ETA7 A4 stainless steel
- PROMAXX ETA1 zinc plated steel



Wall plug UniFast

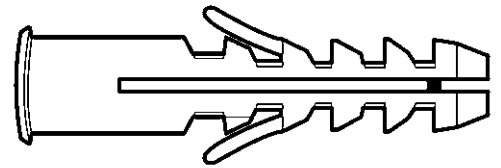
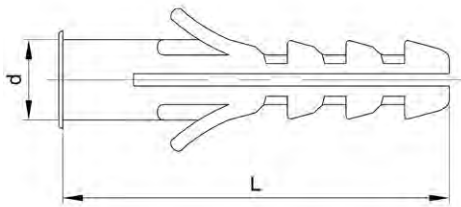

Technical Data

d	5	6	7	8	10	12
Drill depth (min.)	35	40	40	50	60	70
Drill ø	5	6	7	8	10	12
L	25	30	30	40	50	60
Application in combination with:						
Chipboard screws	2.5-4	3.5-4	4-4.5	4.5-6	6-8	8-10
Pull-out force for wood screw (kN)						
Brick ≥ Mz12	0.36	0.50	0.64	0.80	0.88	0.90
Concrete ≥ C20/25	0.42	0.64	0.76	0.90	1.80	2.10

30500	MAXXFAST Wall plug UniFast	MF40
Material	Plastic Nylon (polyamide)	 
Color	Grey	

d	☒	Art.number	d	☒	Art.number	d	☒	Art.number
5MM	100	30500.050.001	7MM	100	30500.070.001	10MM	50	30500.100.001
6MM	100	30500.060.001	8MM	100	30500.080.001	12MM	25	30500.120.001

• Full boxes only.

Wall plug

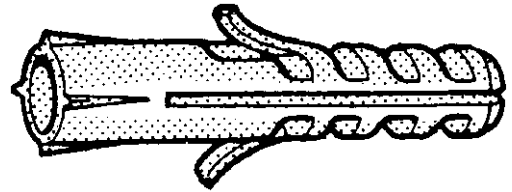
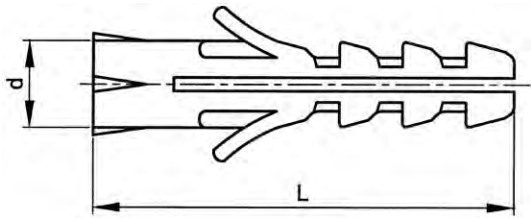

Technical Data

d	4	5	6	7	8	10	12	14
Drill depth (min.)	25	35	40	45	55	70	80	100
Drill \varnothing	4	5	6	7	8	10	12	14
L	20	25	30	37	40	50	60	80
Application in combination with:								
Wood-/Hexagon head wood screws \varnothing	2-3	3-4.5	4.5-5	4.5-5.5	5-6	6-8	8-10	10-12

Assembly sequence

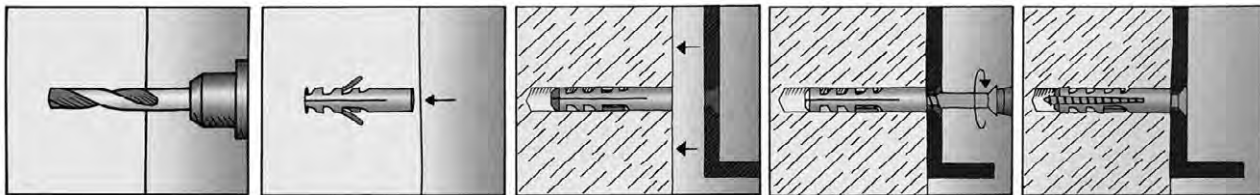

Article groups

Material	Color	Code	Page	
Plastic Nylon	Grey	63158	8-5	
Plastic Nylon	large pack	Grey	63159	8-5

63158 Wall plug

N05A

Material Plastic Nylon (polyamide)
Color Grey



d	☒	Art.number	d	☒	Art.number	d	☒	Art.number
4MM	200	63158.040.001	7MM	100	63158.070.001	12MM	25	63158.120.001
5MM	100	63158.050.001	8MM	100	63158.080.001	14MM	20	63158.140.001
6MM	100	63158.060.001	10MM	50	63158.100.001			

63159 Wall plug

N05A

Material Plastic Nylon (polyamide)
Color Grey



d	☒	Art.number	d	☒	Art.number	d	☒	Art.number
5MM	1000	63159.050.001	8MM	250	63159.080.001	12MM	100	63159.120.001
6MM	500	63159.060.001	10MM	200	63159.100.001			



fischer

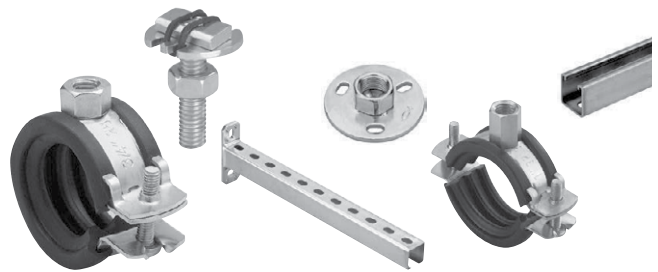

8

Wall plug type S

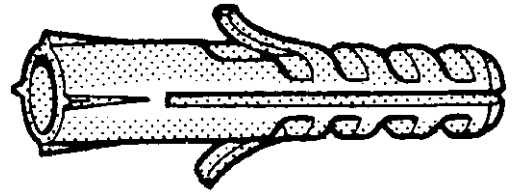
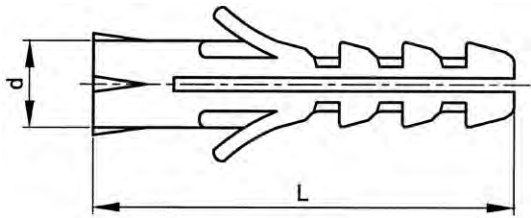

Technical Data

Type	S4	S5	S6	S7	S8	S10	S12	S14	S16	S20
d	4	5	6	7	8	10	12	14	16	20
Drill depth (min.)	25	35	40	40	55	70	80	90	100	120
Drill ø	4	5	6	7	8	10	12	14	16	20
L	20	25	30	30	40	50	60	75	80	90
Application in combination with:										
Wood or Chipboard screws	2-3	3-4	4-5	4-5.5	4.5-6	6-8	8-10	10-12	12 -1/2"	16
Allowable load (kN)										
Brick ≥ Mz12	0.14	0.24	0.28	.	0.50	-	-	-	-	-
Cellular concrete ≥ PB4. PP4 (G4)	-	-	0.05	-	0.07	0.16	0.28	0.40	-	-
Concrete ≥ C20/25	0.16	0.28	0.40	-	0.60	1.10	1.50	1.85	2.26	3.88
Sandlime brick ≥ KS12	0.14	0.24	0.28	-	0.55	-	-	-	-	-

- Allowable load in kN at the largest possible screw diameter, (values in bold print), and a correct mounting of the wall plug in a supporting surface.
- Allowable load includes the safety factor 7.

Assembly sequence

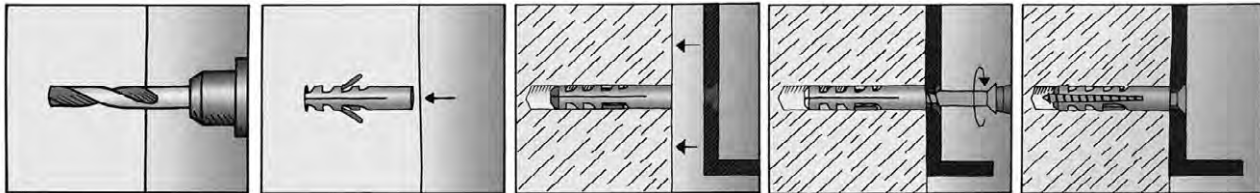

Article groups

Material	Color	Code	Page	
Plastic Nylon	Grey	63100	8-7	
Plastic Nylon	large pack	Grey	63110	8-7

63100 FISCHER Wall plug type S		N01A
Material	Plastic Nylon (polyamide)	
Color	Grey	

Type	☒	Art.number	Type	☒	Art.number	Type	☒	Art.number
S 4	200	63100.040.001	S 8	100	63100.080.001	S 14	20	63100.140.001
S 5	100	63100.050.001	S 10	50	63100.100.001	S 16	10	63100.160.001
S 6	100	63100.060.001	S 12	25	63100.120.001	S 20	5	63100.200.001
S 7	100	63100.070.001						

63110 FISCHER Wall plug type S		N01A
Material	Plastic Nylon (polyamide)	
Color	Grey	

Type	☒	Art.number	Type	☒	Art.number	Type	☒	Art.number
S 5	1000	63110.050.001	S 6	500	63110.060.001	S 8	250	63110.080.001

Assortment box wall plugs



Assembly sequence

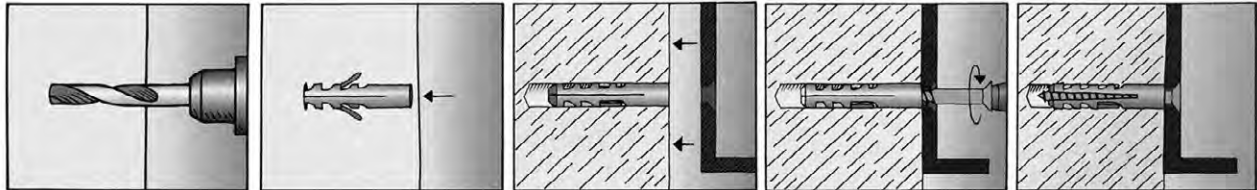

63150 FISCHER Assortment box wall plugs type S

N03B



Type

BOX S-5/6/8



Art.number

1

[63150.568.001](#)

- Packed in a red plastic box with transparent window
- Contents:
- 100 nylon wall plugs type S 5
- 100 nylon wall plugs type S 6
- 100 nylon wall plugs type S 8



Wall plug type MS

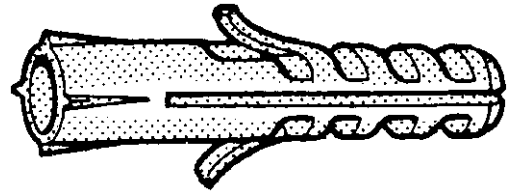
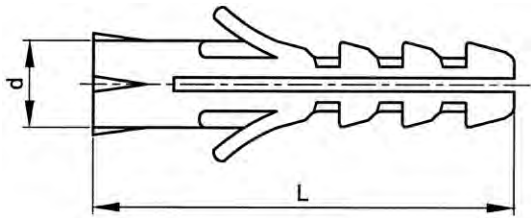

Technical Data

Type	M6-S	M8-S	M10-S	M12-S
d	8	10	14	16
Drill depth (min.)	55	70	90	100
Drill ø	8	10	14	16
L	40	50	70	80
Allowable load (kN)				
Brick Mz12	0.24	0.33	0.46	0.79
Concrete ≥ C20/25	0.30	0.54	0.66	1.06
Sandlime brick ≥ KS12	0.24	0.33	0.43	0.71

- Wall plug type MS is applicable with metric threaded fasteners.
- Allowable load includes the safety factor 7.

Assembly sequence

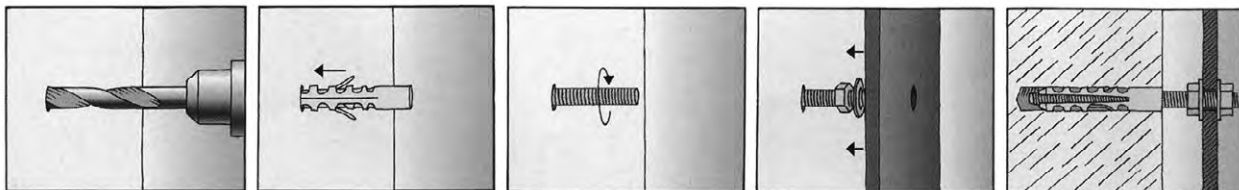

63160 FISCHER Wall plug type MS

N03B

Thread Metric thread
Material Plastic Nylon (polyamide)
Color Beige

fischer
innovative solutions

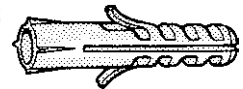

Type	☒	Art.number	Type	☒	Art.number	Type	☒	Art.number
M6 S	100	63160.060.001	M10 S	20	63160.100.001	M12 S	10	63160.120.001
M8 S	50	63160.080.001						

Wall plug MultiFast

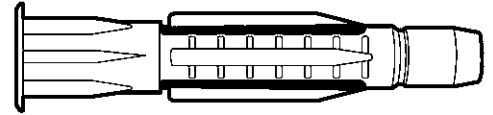
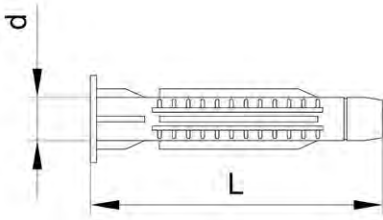

Technical Data

d	6	8	10
Drill depth (min.)	45	60	70
Drill ø	6	8	10
L	35	50	60
Application in combination with:			
Chipboard screws	4	4.5	5
Pull-out force for wood screw (kN)			
Brick ≥ Mz12	0.20	0.32	0.38
Concrete ≥ C20/25	0.65	0.80	0.95

30502 MAXXFAST Wall plug MultiFast

MF50

Material Plastic Nylon (polyamide)
Color Grey

MAXXFAST
PROFESSIONAL HARDWARE



d	☒	Art.number	d	☒	Art.number	d	☒	Art.number
6MM	100	30502.060.001	8MM	100	30502.080.001	10MM	50	30502.100.001

- Full boxes only.

Wall plug type SX

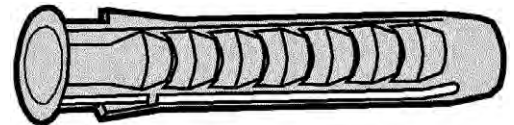
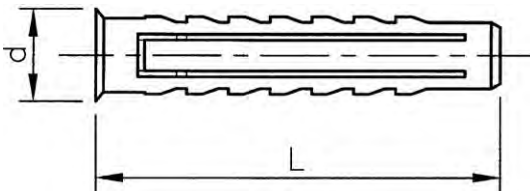

8

Technical Data

Type	SX 4	SX 5	SX 6	SX 6-L	SX 8	SX 8-L	SX 10	SX 12	SX 14	SX 16
d	4	5	6	6	8	8	10	12	14	16
Drill depth (min.)	25	35	40	60	50	75	70	80	90	100
Drill ø	4	5	6	6	8	8	10	12	14	16
L	20	25	30	50	40	65	50	60	70	80
Application in combination with:										
Chipboard screws	2-3	3-4	4-5	4-5	4.5-6	4.5-6	6-8	8-10	10-12	12-1/2"
Allowable load (kN)										
Brick ≥ Mz12	-	0.23	0.31	0.31	0.59	0.59	0.64	0.71	0.8	0.8
Cellular concrete ≥ G2	-	0.03	0.03	0.03	0.04	0.04	0.09	0.14	0.31	0.31
Cellular concrete ≥ G4	-	0.09	0.09	0.09	0.14	0.14	0.29	0.44	0.49	0.49
Concrete ≥ C20/25	-	0.29	0.7	0.7	0.71	0.71	1.21	1.71	2.01	2.01
Hollow sandlime brick KSL12	-	0.17	0.3	0.3	0.33	0.33	0.29	0.35	0.31	0.31
Sandlime brick ≥ KS12	-	0.29	0.5	0.5	0.6	0.6	1.21	1.71	2.01	2.01
Ventilation stone ≥ Hlz12. ρ ≥ 1.0 kg/dm ³	-	0.07	0.07	0.07	0.17	0.17	0.17	0.26	0.44	0.44

- Allowable load in kN at the largest possible screw diameter, (values in bold print), and a correct mounting of the wall plug in a supporting surface.
- When using chipboard screws, the values should be reduced by 30%.
- Because of the possible variation in joint quality, the values apply only to fixing operations in brick.

Assembly sequence

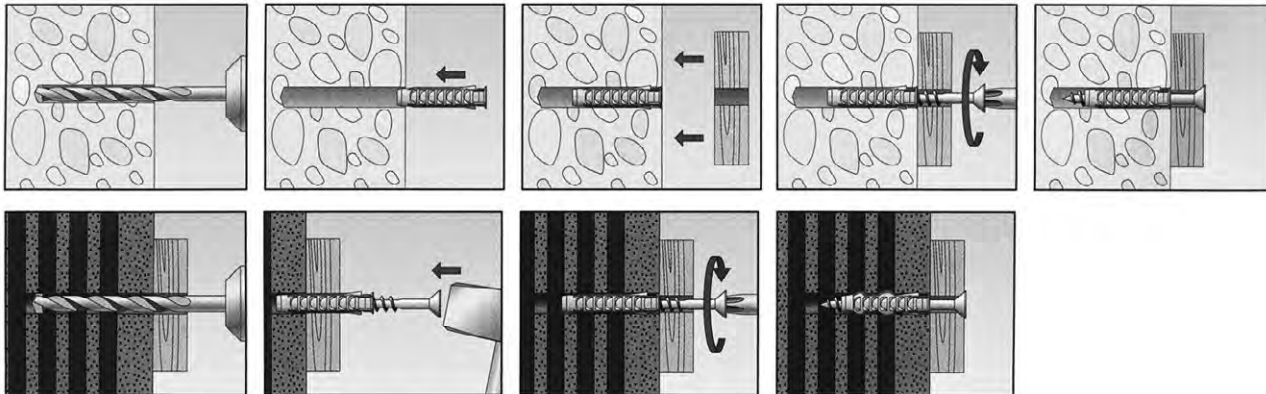

Article groups

Material		Color	Code	Page
Plastic Nylon	SX	Grey	63120	8-11
Plastic Nylon	SX-L	Grey	63121	8-11

63120 FISCHER Wall plug type SX N01A

Material Plastic Nylon (polyamide)
Color Grey

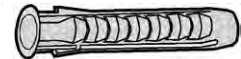

Type	☒	Art.number	Type	☒	Art.number	Type	☒	Art.number
SX4	200	63120.040.001	SX8	100	63120.080.001	SX14	20	63120.140.001
SX5	100	63120.050.001	SX10	50	63120.100.001	SX16	10	63120.160.001
SX6	100	63120.060.001	SX12	25	63120.120.001			

63121 FISCHER Wall plug type SX-L N01A

Material Plastic Nylon (polyamide)
Color Grey

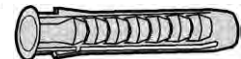

Type	☒	Art.number	Type	☒	Art.number
SXL6	100	63121.060.002	SXL8	50	63121.080.002

Wall plug 4Fast

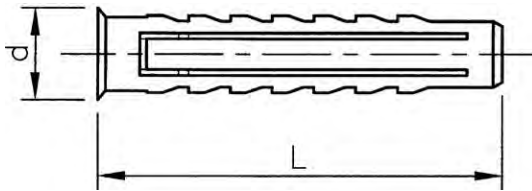

Technical Data

d	5	6	8	10	12
Drill depth (min.)	30	50	50	60	70
Drill ø	5	6	8	10	12
L	25	30	40	50	60
Application in combination with:					
Chipboard screws	4	4.5	5	6	10
Pull-out force for wood screw (kN)					
Brick ≥ Mz12	0.46	0.90	1.00	1.10	1.20
Concrete ≥ C20/25	0.80	1.10	1.20	1.86	2.60

30505		MAXXFAST Wall plug 4Fast			MF40
Material	Plastic Nylon (polyamide)				 
Color	Grey				

d	☒	Art.number	d	☒	Art.number	d	☒	Art.number
5MM	100	30505.050.001	8MM	100	30505.080.001	12MM	25	30505.120.001
6MM	100	30505.060.001	10MM	50	30505.100.001			

• Full boxes only.

Plug universal UX/UX-R

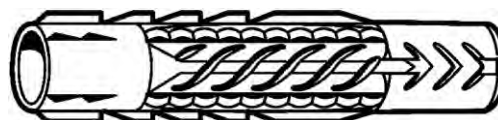
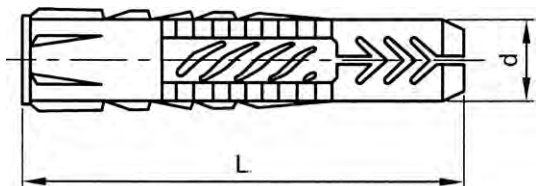



Technical Data

Type	UX (R) 6	UX (R) 8	UX (R) 10	UX 12	UX 14
Drill depth (min.)	45	60	75	85	95
Drill ϕ	6	8	10	12	14
L	35	50	60	70	75
Material thickness (min.)	9.5	9.5	12.5	-	-
Application in combination with:					
Wood or Chipboard screws	4-5	4.5-6	6-8	8-10	10-12
Allowable load (kN)					
Brick \geq Mz12	0.2	0.3	0.5	0.7	0.8
Cellular concrete \geq PB4. PP4 (G4)	0.2	0.3	0.4	0.6	0.7
Hollow sandlime brick KSL12	0.4	0.5	0.6	0.8	0.8
Plasterboard 12.5mm	0.1	0.1	0.1	-	-
Plasterboard \geq 2x12.5mm	0.15	0.15	0.15	-	-
Ventilation stone Hiz12	0.2	0.2	0.2	0.3	4

- Allowable load in kN at the largest possible screw diameter, (values in bold print), and a correct mounting of the wall plug in a supporting surface.
- Allowable load includes the safety factor 7.

Article groups

Material		Code	Page
Plastic	UX	63276	8-13
Plastic	UX-R	63277	8-13

63276 FISCHER Plug universal UX		N03A
Material	Plastic	 

Type	☒	Art.number	Type	☒	Art.number	Type	☒	Art.number
UX 6	100	63276.060.001	UX 10	50	63276.100.001	UX 14	20	63276.140.001
UX 8	100	63276.080.001	UX 12	25	63276.120.001			

63277 FISCHER Plug universal UX-R		N03A
Material	Plastic	 

Type	☒	Art.number	Type	☒	Art.number	Type	☒	Art.number
6 UX-R	100	63277.060.001	8 UX-R	100	63277.080.001	10 UX-R	50	63277.100.001

Universal fixing

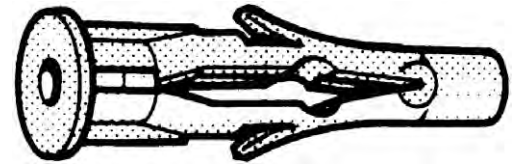
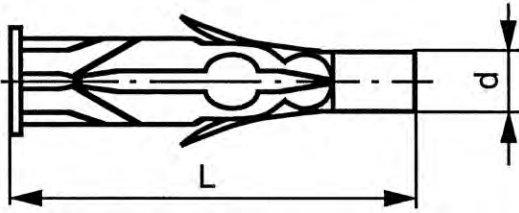

Technical Data

Type	FU 6x35	FU 6x45	FU 8x50	FU 10x60
d	6	6	8	10
Drill depth (min.)	45	55	60	70
Drill ø	6	6	8	10
L	35	45	50	60
Material thickness (min.)	6	6	6	6
Application in combination with:				
Wood or Chipboard screws	3-3.5	3-3.5	4-4.5	5-6
Pull-out force for wood screw/				
Brick Mz12	0.26	0.26	0.50	0.78
Cellular concrete PB2. PP2 (G2)	0.03	0.03	0.09	0.13
Cellular concrete PB4. PP4 (G4)	0.13	0.13	0.22	0.27
Chipboard 10mm	-	-	-	-
Concrete C20/25	0.28	0.28	0.57	0.86
Hollow sandlime brick KSL6	-	-	-	-
Plasterboard 10mm	-0.4	-0.4	-0.45	-0.45
Pumice grit V2	0.10	0.10	0.21	0.22
Sandlime brick KS12	0.25	0.25	0.50	0.78
Ventilation stone Hlz12	-	-	-	-

- Allowable load in kN at the largest possible screw diameter, (values in bold print), and a correct mounting of the wall plug in a supporting surface.
- Allowable load includes the safety factor 7.

Assembly sequence

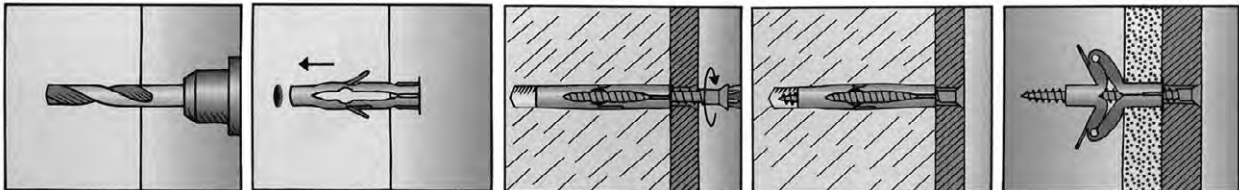

8

63270 **FISCHER Universal fixing type FU** N03A

Material Plastic Nylon (polyamide)
Color Grey

fischer innovative solutions

Type	☒	Art.number	Type	☒	Art.number	Type	☒	Art.number
FU 6X35	50	63270.060.035	FU 8X50	50	63270.080.050	FU 10X60	25	63270.100.060
FU 6X45	50	63270.060.045						

MAXXFAST Cavity fixing

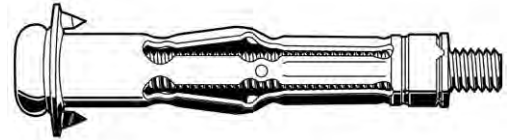
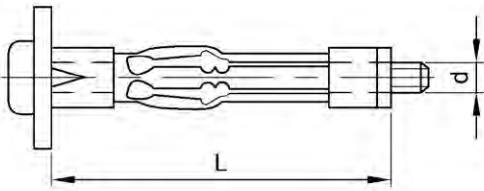

Technical Data

d x L	Cavity depth (min.)	Drill ø	Pull-out force (N)	Screw length	Thickness of the fixture
M4x21	26	8	-	28	1-4
M4x34	39	8	-	41	3-9
M4x40	46	8	300	47	8-15
M4x47	53	8	300	54	16-21
M4x60	66	8	500	67	32-38
M5x37	46	10	250	43.5	5-13
M5x53	59	10	500	60	5-16
M5x66	72	10	900	74	16-32
M5x81	89	10	900	89	32-45
M6x37	46	12	200	45	5-13
M6x53	59	12	300	60	5-16
M6x66	72	12	800	74	16-32
M6x81	89	12	800	88	32-45

- Pull-out force for maximum plasterboard thickness.

30537 MAXXFAST H-Fast cavity fixing Pozidriv

MF4A

Thread Metric thread
Material Steel
Surface treatment Zinc plated

MAXXFAST
PROFESSIONAL HARDWARE



d x L	☒	Art.number	d x L	☒	Art.number	d x L	☒	Art.number
M4X21	50	30537.040.021	M5X37	50	30537.050.037	M6X37	50	30537.060.037
M4X34	50	30537.040.032	M5X53	50	30537.050.052	M6X53	50	30537.060.052
M4X40	50	30537.040.038	M5X66	50	30537.050.065	M6X66	50	30537.060.065
M4X47	50	30537.040.046	M5X81	50	30537.050.080	M6X81	50	30537.060.080
M4X60	50	30537.040.059						

Cavity fixing

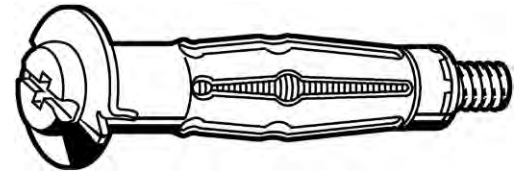
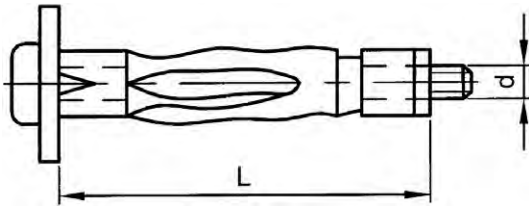

Technical Data

Type	d	Drill depth (min.)	Drill ø	L	Material thickness (max.)	Screw size	Structural part thickness (max.)
HM 4x32	M4	42	8	32	3-13	M4	-
HM 4x32 S	M4	40	8	32	3-13	M4X40	15-25
HM 4x45 S	M4	55	8	45	16-23	M4x52	12-21
HM 4x46 S	M4	56	8	46	5-18	M4x52	23
HM 4x60 S	M4	60	8	60	31-40	M4X65	12-21
HM 5x37 S	M5	45	10	37	6-15	M5X45	8-17
HM 5x52 S	M5	58	10	52	7-21	M5X58	10-24
HM 5x65 S	M5	71	10	65	20-34	M5X71	12-26
HM 6x37	M6	47	12	37	6-15	M6	-
HM 6x37 S	M6	45	12	37	6-15	M6X45	12-21
HM 6x52 S	M6	58	12	52	7-21	M6X58	14-28
HM 6x65 S	M6	70	12	65	20-34	M6X70	≤ 24
HM 6x80	M6	90	12	80	38-50	M6	-
HM 6x80 S	M6	88	12	80	32-50	M6X88	16-34
HM 8x55 SS	M8	60	12	55	10-21	M8X60	≤ 24

- HM4x32/ HM5x37/ HM6x37/ HM6x80 delivered without screw.
- HM8x55SS With hexagon head screw. Assembly only by using professional nippers HM Z 1.

Assembly sequence

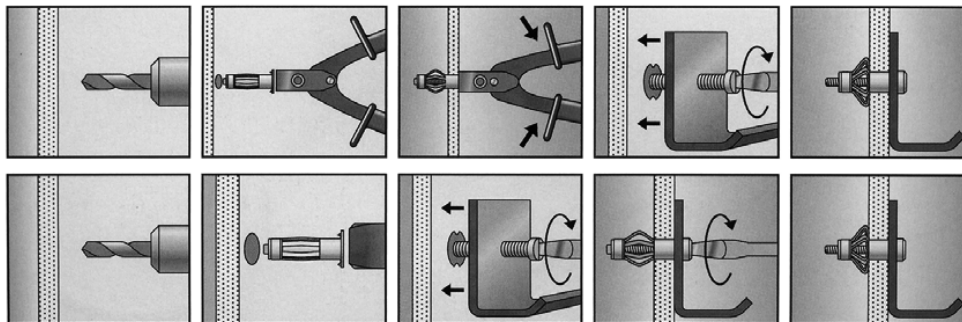

8

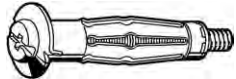
63240 FISCHER Cavity fixing type HM/HM-S		N03A
Thread	Metric thread	 
Material	Steel	
Surface treatment	Zinc plated	
		

Type	⊗	Art.number	Type	⊗	Art.number	Type	⊗	Art.number
HM4X32S	50	63240.040.132	HM5X37S	50	63240.050.137	HM6X52S	50	63240.060.152
HM4X45S	50	63240.040.145	HM5X52S	50	63240.050.152	HM6X65S	50	63240.060.165
HM4X54S	50	63240.040.154	HM5X65S	50	63240.050.165	HM6X80S	50	63240.060.180
HM4X60S	50	63240.040.160	HM6X37S	50	63240.060.137	HM8X55S	50	63240.080.155

Cavity fixing installation tool

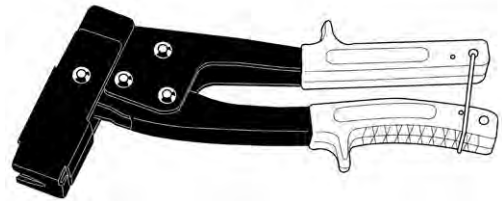

Article groups	
Code	Page
30539	8-17
63248	8-17

30539	MAXXFAST Installation tool	MFNA
 		

Type	Art.number
HA-FAST	1 30539.000.005

63248	FISCHER Installation tool	N03A
 		

Type	Art.number	Description
HMZ 2	1 63248.000.100	<ul style="list-style-type: none"> DIY nipper Suitable for the installation of FISCHER cavity fixings
HMZ 1	1 63248.000.105	<ul style="list-style-type: none"> Professional nipper Suitable for the installation of FISCHER cavity fixings

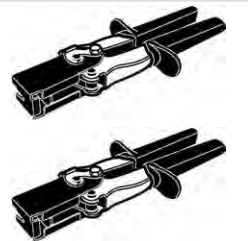

Plasterboard fixing

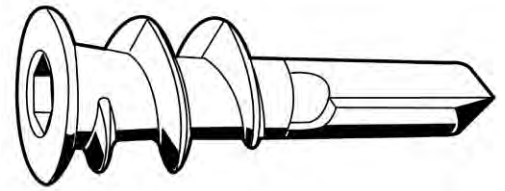
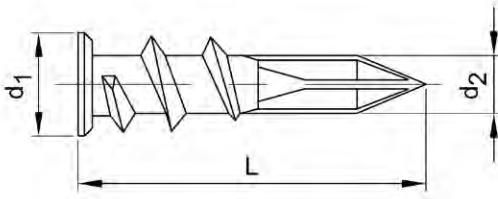

Technical Data

d ₁ x L	Cavity depth (min.)	d ₂	Material thickness	No. cross recess	Screw size
15x33	30	6	9-16	2	4.5x35
13x29	25	6	9-16	2	4.2x30
13x37	25	6	9-16	2	4.2x50

Article groups

Driving features	Material	Surface treatment	Code	Page
Phillips	Plastic Nylon		30530	8-18
Phillips	St	Zipl	30531	8-18
Phillips	Zamac 3		30532	8-18

30530 MAXXFAST Plasterboard fixing MF4A

Material Plastic Nylon (polyamide)

MAXXFAST
PROFESSIONAL HARDWARE

d ₁ x L	Art.number
15X33MM	30530.120.001

30531 MAXXFAST Plasterboard fixing MF4A

Material Steel
Surface treatment Zinc plated

MAXXFAST
PROFESSIONAL HARDWARE

RoHS

d ₁ x L	Art.number
13X29MM	30531.015.029

30532 MAXXFAST Plasterboard fixing MF4A

Material Zamac 3

MAXXFAST
PROFESSIONAL HARDWARE

RoHS

d ₁ x L	Art.number
13X37MM	30532.060.037

Self-drilling anchor for plasterboard

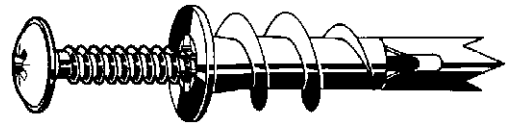
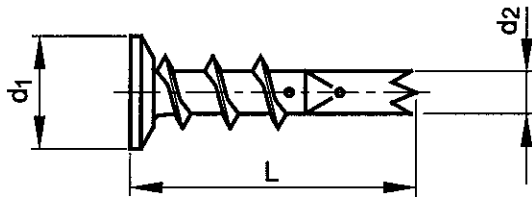

Technical Data

Type	TP 12	TP 12-PLUS	TF 27
Shear strength min. (kN)	0.18	0.28	0.18
d ₁	14	16	14
d ₂	8	15.5	8
Grip range	0-12	0-12	12-27
L	31	39	31
Material thickness (min.)	10	10-13	10
No. Pozidriv (Z)	2	2	2
Screw size	4.5x35	4.5x45	4.5x50

Assembly sequence

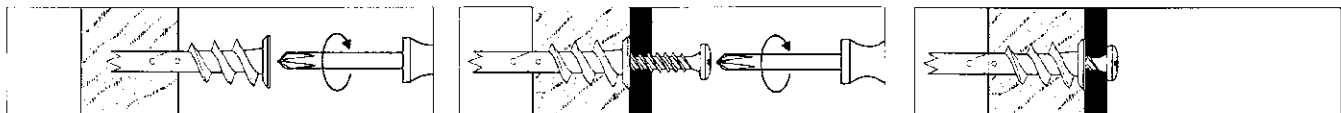

Article groups

Material	Surface treatment	Code	Page
Zamac 3	Zipl	70880	8-19
Zamac 3	Zipl PLUS	70882	8-19

70880 DRIVA Self-drilling anchor for plasterboard		N05A
Material	Zamac 3	
Surface treatment	Zinc plated	

Type	Art.number	Type	Art.number
TP 12	100 70880.120.001	TF 27	100 70880.270.001

- DRIVA self-drilling anchors are made of Zamac 3 (zinc alloy), type TP 12 with zinc plated screws for back panels and type TF 27 with zinc plated countersunk screw.
- The named values are successively applicable for plasterboard 10 mm, plasterboard 13 mm and cellular concrete (6 mm pre-drill).
- The Allowable load (Nrec/Vrec) Includes the safety factor of 5 on the ultimate load.

70882 DRIVA PLUS Self-drilling anchor for plasterboard		N05A
Material	Zamac 3	
Surface treatment	Zinc plated	

Type	Art.number
TP 12-PLUS	100 70882.120.001

- DRIVA PLUS self-drilling self-setting toggle anchors are made of Zamac 3 (zinc alloy). Delivered with zinc plated screws, specially developed for DRIVA PLUS self-drilling anchors.
- The Allowable load (Nrec/Vrec) Includes the safety factor of 5 on the ultimate load.

Plasterboard fixing

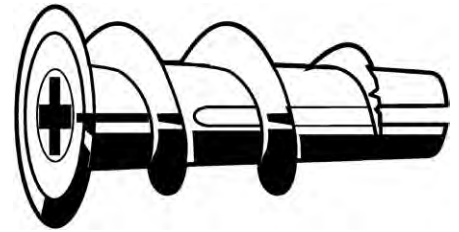
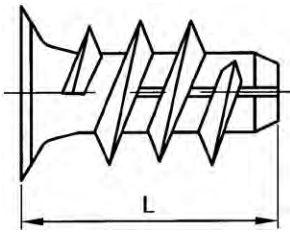

Technical Data

Type	GK	GKS
Cavity depth (min.)	25	25
L	22	22
Useful length	-	13
Screw ø	4-5	4.5x35
Allowable load (kN)		
Plasterboard 9.5mm	0.07	0.07
Plasterboard 12.5mm	0.08	0.08
Plasterboard ≥ 2x12.5mm	0.11	0.11

- GKS Supplied with installation tool and plasterboard screws.
- GK Min. screw length = length of plug 22 mm + thickness of building component.
- Allowable loads in kN are valid for chipboard screws with specified diameters.

Assembly sequence

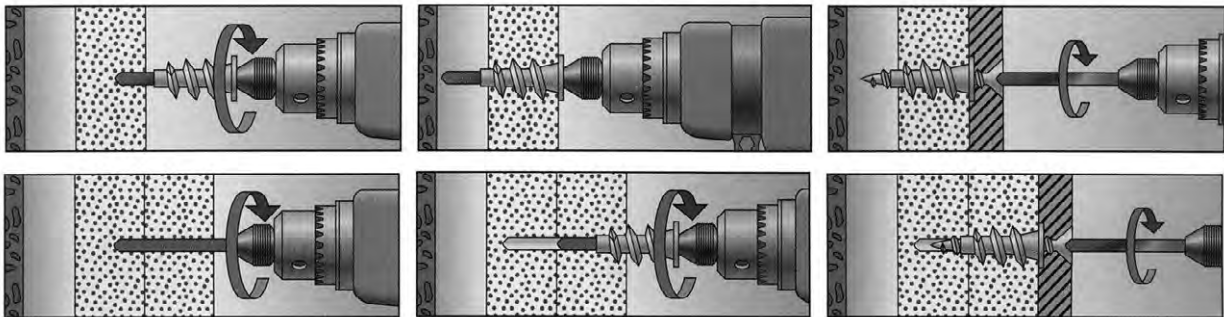

8

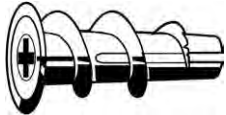
63261 FISCHER Plasterboard fixing type GK/GKS		N03A
Material	Plastic Nylon (polyamide)	 
Color	Grey	

Type	☒	Art.number	Type	☒	Art.number
GK 4,0X35	100	63261.040.035	GKS 4,5X35	50	63261.045.035

Aircrete anchor

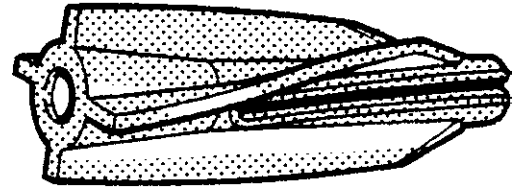
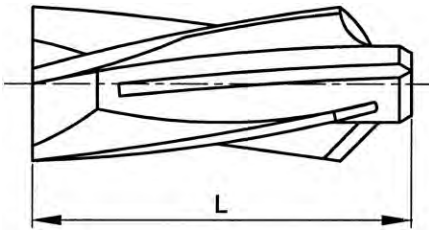

Technical Data

Type	GB8	GB10	GB14
Drill depth (min.)	60	65	90
Drill ϕ	8	10	14
L	50	55	75
Application in combination with:			
Screw ϕ	5	7	10
Allowable load (kN)			
Cellular concrete \geq P3.3 (GB3.3)	0.3	0.5	0.8
Cellular concrete \geq P4.4 (GB4.4)	0.4	0.6	0.9
Cellular concrete \geq PB2. PP2 (G2)	0.20	0.25	0.40
Cellular concrete \geq PB3.3 (GB3.3)*	0.3	0.5	0.3
Cellular concrete \geq PB4. PP4 (G4)	0.4	0.6	0.9

- Allowable loads are valid for Fischer safety screws.
- For the design the complete approval has to be considered.
- * Tensile zone of cellular concrete roof- and ceiling panels acc. DIN 4223

Assembly sequence

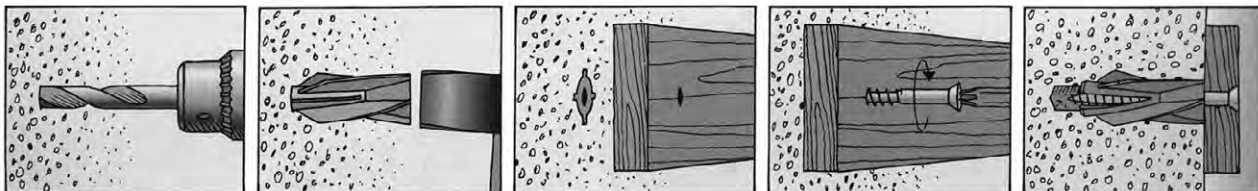

63300 FISCHER Aircrete anchor type GB		N03B
Material	Plastic Nylon (polyamide)	
Color	Grey	

Type	☒	Art.number	Type	☒	Art.number	Type	☒	Art.number
GB 8	25	63300.080.001	GB 10	20	63300.100.001	GB 14	10	63300.140.001

Turbo anchor FTP steel



Technical Data

Type	M6	M8	M10
Depth of drilled hole to deepest point	60	70	80
Drill ϕ	8 - (10)	10 - (12)	12 - (14)
L	50	60	70
Screw-in depth (max.)	20	25	30
Application in combination with:			
Screw ϕ	M6	M8	M10
Allowable load (kN)			
Cellular concrete PB2. PP2 ($\geq 2.5 \text{ N/mm}_2$)	0.30	0.45	0.60
Cellular concrete PB4. PP4 ($\geq 5.0 \text{ N/mm}_2$)	0.50	0.65	0.70
Cellular concrete PB6. PP6 ($\geq 7.5 \text{ N/mm}_2$)	0.7	0.8	0.9
Plasterboard	-	0.45	0.65

- Allowable loads in kN are valid for screws with specified diameters.
- Allowable load includes the safety factor 5.
- Drill ϕ ; values between brackets applied to cellular concrete class $\geq 5,0 \text{ N/mm}^2$.

63309	FISCHER Turbo anchor FTP steel	N03A
Material	Steel	
		 
		

Type	☒	Art.number	Type	☒	Art.number	Type	☒	Art.number
M6	25	63309.060.001	M8	25	63309.080.001	M10	25	63309.100.001

- Tools, see following pages.

Turbo anchor FTP plastic



Technical Data

Type	K4	K6	K8	K10
Depth of drilled hole to deepest point	60	60	70	80
Drill \varnothing	8 - (10)	8 - (10)	10 - (12)	12 - (14)
L	50	50	60	70
Screw-in depth (max.)	35	40	45	50
Wood screws \varnothing	4-4.5	5-6	7-8	9-10
Application in combination with:				
Screw \varnothing	M4	M5-6	M8	M8-10
Allowable load (kN)				
Cellular concrete PB2. PP2 ($\geq 2.5 \text{ N/mm}_2$)	0.15	0.20	0.30	0.40
Cellular concrete PB4. PP4 ($\geq 5.0 \text{ N/mm}_2$)	0.25	0.30	0.40	0.50
Plasterboard	-	-	0.29	0.54

- Allowable loads in kN are valid for screws with specified diameters.
- Allowable load includes the safety factor 5.
- Drill \varnothing ; values between brackets applied to cellular concrete class $\geq 5,0 \text{ N/mm}^2$.

63310 FISCHER Turbo anchor FTP plastic

N03A

Material Plastic

fischer
innovative solutions



Type	☒	Art.number	Type	☒	Art.number	Type	☒	Art.number
K4	25	63310.040.001	K8	25	63310.080.001	K10	10	63310.100.001
K6	25	63310.060.001						

- Tools, see following pages.

Installation tool FTP



Article groups

Material	Code	Page
St	63312	8-24
Plastic	63313	8-24

63312 FISCHER Installation tool FTP steel N03A

Material Steel



Type	Art.number	Type	Art.number	Type	Art.number
EM6	1 63312.060.001	EM8	1 63312.080.001	EM10	1 63312.100.001

63313 FISCHER Installation tool FTP plastic N03A

Material Plastic



Type	Art.number	Type	Art.number	Type	Art.number
EK4/6	1 63313.040.001	EK8	1 63313.080.001	EK10	1 63313.100.001

Toggle plug

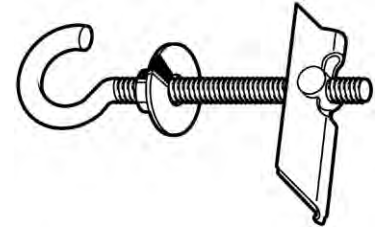

Technical Data

Type	Cavity depth (min.)	Drill ø	For screw	L	Material thickness (min.)	N _{rec}
K 54	58	10	4MM	125	65	-
KD 3	27	12	M3X90	95	65	0.45
KD 4	34	14	M4X100	105	69	0.90
KD 5	70	16	M5X100	100	63	2.20
KD 6	70	16	M6X100	100	63	2.80
KD 8	75	20	M8X100	100	55	4.30
KDH 3	27	12	M3X80	105	51	0.07
KDH 4	34	14	M4X80	95	35	0.13
KDH 5	70	16	M5X90	130	60	0.30
KDH 8	75	20	M8X100	130	55	1.40

- N_{rec} = Recommended load in kN.
- Includes the safety factor 2,25.
- Steel failure/bending of the hook decisive.

63260 FISCHER Toggle type K

N03B

Surface treatment Zinc plated

fischer
innovative solutions

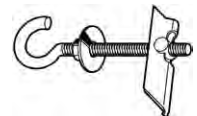

Type	☒	Art.number
K-54	25	63260.000.054
KD-3	50	63260.001.003
KD-4	25	63260.001.004
KD-5	25	63260.001.005
KD-6	25	63260.001.006
KD-8	20	63260.001.008
KDH-3	25	63260.002.003

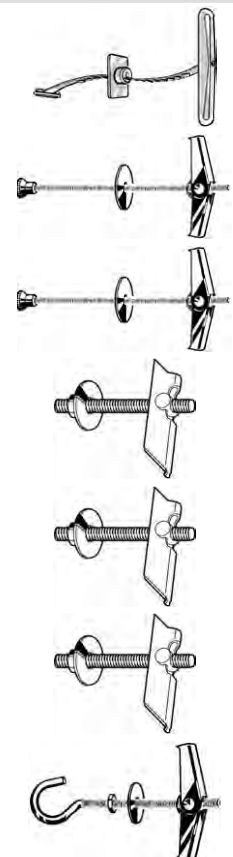

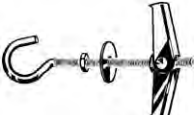
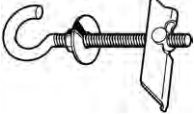
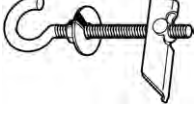
63260 FISCHER Toggle type K		←
Type	<input checked="" type="checkbox"/> Art.number	
KDH-4	25 63260.002.004	
KDH-5	20 63260.002.005	
KDH-8	20 63260.002.008	

- KD & KDH= Steel.
- K= Plastic.

Hammer-in anchor



Technical Data

Type	SDA 6
d ₁	5.8
d ₂	15
Drill depth (min.)	40
Drill ø	6
Grip range (max.)	4.5
k	2.5
L	35
Allowable load (kN)	
Concrete ≥ C20/25	0.5

- Loads are valid in the pressure zone.

Assembly sequence

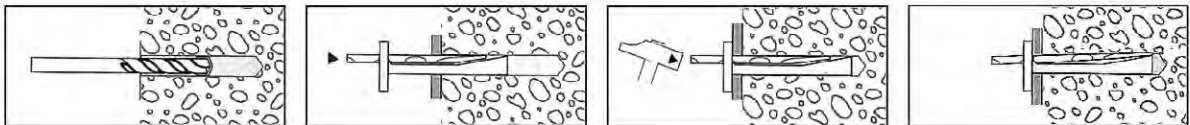

70665 SPIT Hammer-in anchor type SDA		P03A
Material	Steel	
Surface treatment	Zinc plated yellow passivated	
		

Type	<input checked="" type="checkbox"/> Art.number
SDA 6	100 70665.060.001

Nail sleeve

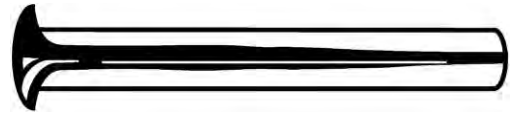
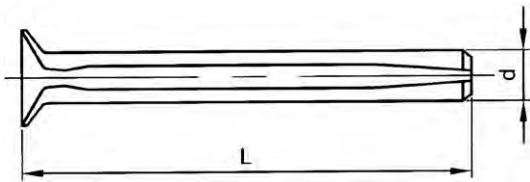

Technical Data

Type	FNH 5/50	FNH 6/40	FNH 6/50	FNH 6/60	FNH 6/80	FNH 8/70	FNH 8/90	FNH 8/110	FNH 8/130	FNH 8/150
d	5	6	6	6	6	8	8	8	8	8
Drill depth (min.)	60	50	60	70	90	80	100	120	140	160
Drill ø	5	6	6	6	6	8	8	8	8	8
Effective anchorage depth (h _{ef})	20	30	30	30	30	40	40	40	40	40
Grip range (max.)	30	10	20	30	50	30	50	70	90	110
L	50	40	50	60	80	70	90	110	130	150
Allowable load (kN)										
Concrete ≥ C20/25	0.10	0.35	0.35	0.35	0.35	0.60	0.60	0.60	0.60	0.60

- A DACROMET® surface coating eliminates the possibilities of damage which can arise due to hydrogen embrittlement.
- Drill depth (min.) For through fixing.
- Allowable loads in kN are valid for non-structural applications.
- Allowable load includes the safety factor 4.

Assembly sequence

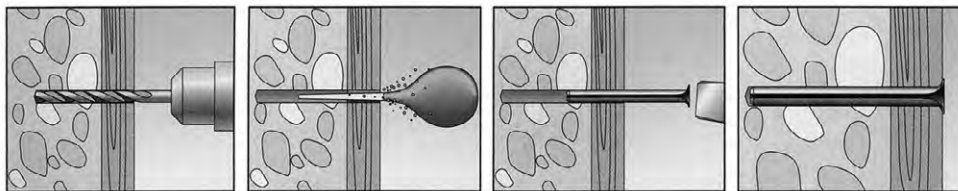

63223 FISCHER Nail sleeve type FNH

N03A

Material Steel
Surface treatment Dacromet 500 LC Grade A

fischer
innovative solutions



Type	☒	Art.number	Type	☒	Art.number	Type	☒	Art.number
FNH 5/50	100	63223.050.050	FNH 6/80	100	63223.060.080	FNH 8/110	50	63223.080.110
FNH 6/40	100	63223.060.040	FNH 8/70	100	63223.080.070	FNH 8/130	100	63223.080.130
FNH 6/50	100	63223.060.050	FNH 8/90	50	63223.080.090	FNH 8/150	50	63223.080.150
FNH 6/60	100	63223.060.060						

Wall plug HammerFast

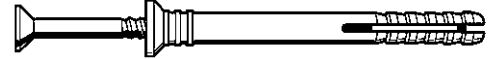
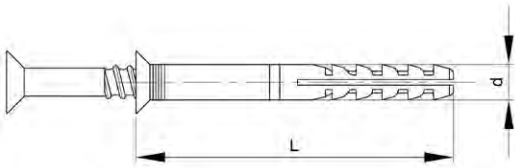

Technical Data

d x L	5x30	5x35	5x50	6x40	6x50	6x60	8x60	8x80	8x100	8x120
Drill depth (min.)	50	55	70	60	70	80	80	100	120	140
Drill ø	5	5	5	6	6	6	8	8	8	8
Grip range	5	10	25	10	20	30	20	40	60	80
Allowable load (kN)										
Brick ≥ Mz12	0.20	0.20	0.20	0.28	0.28	0.28	0.36	0.36	0.36	0.36
Concrete ≥ C20/25	0.32	0.32	0.32	0.36	0.36	0.36	0.44	0.44	0.44	0.44

- Allowable loads in kN are valid for screw nails with specified diameters.
- Allowable load includes the safety factor 5.

30510	MAXXFAST Wall plug HammerFast	MF50
Material	Plastic Nylon (polyamide)	 
Surface treatment	Zinc plated	
Color	Grey	

d x L	☒	Art.number	d x L	☒	Art.number	d x L	☒	Art.number
5X30MM	100	30510.050.030	6X50MM	100	30510.060.050	8X80MM	50	30510.080.080
5X35MM	100	30510.050.035	6X60MM	100	30510.060.060	8X100MM	50	30510.080.100
5X50MM	100	30510.050.050	8X60MM	100	30510.080.060	8X120MM	50	30510.080.120
6X40MM	100	30510.060.040						

- Full boxes only.

Hammerfix type N-Z

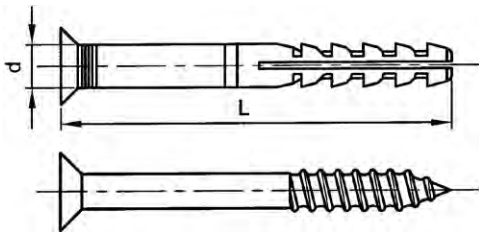

Technical Data

Type	N5x 30 Z	N5x 40 Z	N5x 50 Z	N6x 40 Z	N6x 60 Z	N6x 80 Z	N8x 60 Z	N8x 80 Z	N8x 100 Z	N8x 120 Z	N10x 100 Z	N10x 135 Z	N10x 160 Z
d	5	5	5	6	6	6	8	8	8	8	10	10	10
Drill depth (min.)	45	55	65	55	75	95	75	95	115	135	115	150	175
Drill ø	5	5	5	6	6	6	8	8	8	8	10	10	10
Grip range (max.)	5	15	25	10	30	50	20	40	60	80	50	85	110
L	30	40	50	40	60	80	60	80	100	120	100	135	160
Nail dimension	3.5x38	3.5x48	3.5x58	4x48	4x64	4x88	5x65	5x85	5x105	5x120	7x110	7x145	7x170
Allowable load (kN)													
Brick Mz12	0.14	0.14	0.14	0.18	0.18	0.18	0.24	0.24	0.24	0.24	0.3	0.3	0.3
Cellular concrete ≥ PB2. PP2 (G2)	0.03	0.03	0.03	0.04	0.04	0.04	0.05	0.05	0.05	0.05	0.1	0.1	0.1
Cellular concrete ≥ PB4. PP4 (G4)	0.5	0.5	0.5	0.65	0.65	0.65	0.8	0.8	0.8	0.8	1.2	1.2	1.2
Concrete C20/25	0.16	0.16	0.16	0.2	0.2	0.2	0.27	0.27	0.27	0.27	0.33	0.33	0.33
Pumice grit V4	0.05	0.05	0.05	0.12	0.12	0.12	0.15	0.15	0.15	0.15	0.16	0.16	0.16
Sandlime brick KS12	0.14	0.14	0.14	0.17	0.17	0.17	0.24	0.24	0.24	0.24	0.33	0.33	0.33

- Allowable loads in kN are valid for screw nails with specified diameters.
- Allowable load includes the safety factor 4.
- With pre-assembled steel zinc plated or stainless steel A2 nail with Pozidriv (Z) cross recessed head.

Assembly sequence

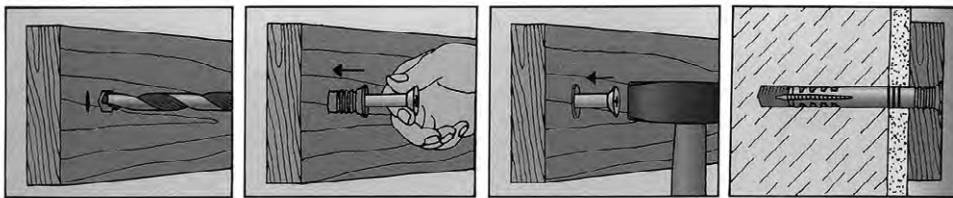

Article groups

Material	Surface treatment	Color	Code	Page
Plastic Nylon	Zipl	Assorted	63611	8-29
Plastic Nylon		Grey	63616	8-30

63611 FISCHER Hammerfix type N-Z		N03C
Material	Plastic Nylon (polyamide)	
Surface treatment	Zinc plated	
Color	Assorted	

Type	☒	Art.number	Type	☒	Art.number	Type	☒	Art.number
N5X30MM	100	63611.050.030	N5X50MM White	100	63611.050.511	N8X100MM	50	63611.080.100
N5X30MM Brown	100	63611.050.031	N6X40MM	50	63611.060.040	N8X120MM	50	63611.080.120
N5X40MM Brown	100	63611.050.040	N6X60MM	50	63611.060.060	N10X100MM	50	63611.100.100
N5X40MM	100	63611.050.041	N6X80MM	50	63611.060.080	N10X135MM	50	63611.100.135
N5X50MM	100	63611.050.050	N8X60MM	50	63611.080.060	N10X160MM	50	63611.100.160
N5X40MM White	100	63611.050.411	N8X80MM	50	63611.080.080			

63616	FISCHER Hammerfix type N-Z St.st. A2	N03C
Material	Plastic Nylon (polyamide)	 
Color	Grey	

Type	☒	Art.number	Type	☒	Art.number	Type	☒	Art.number
5X30MM	100	63616.050.030	6X60MM	50	63616.060.060	8X80MM	50	63616.080.080
6X40MM	50	63616.060.040	8X60MM	50	63616.080.060	8X100MM	50	63616.080.100

Hammerfix type N-FZ

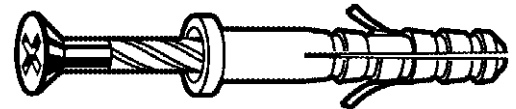
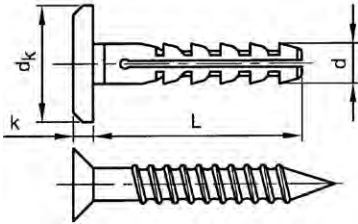

Technical Data

Type	N6x40 FZ	N8x40 FZ
d	6	8
d_k	13	20
Drill depth (min.)	55	55
Drill ø	6	8
Grip range (max.)	7	0.5
L	40	40
Nail dimension	4x48	5x45
Allowable load (kN)		
Brick Mz12	0.18	0.24
Cellular concrete G2	0.04	0.05
Cellular concrete G4	0.10	0.13
Concrete C20/25	0.20	0.27
Pumice grit V4	0.12	0.15
Sandlime brick KS12	0.17	0.24

- Allowable loads in kN are valid for screw nails with specified diameters.
- Allowable load includes the safety factor 4.

8

Assembly sequence

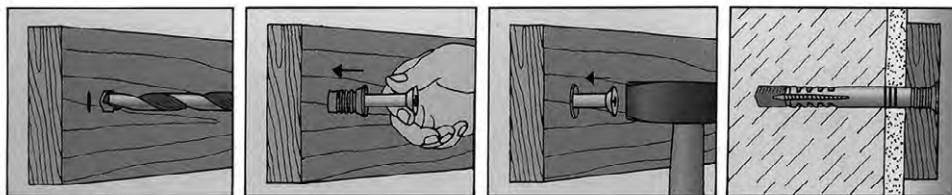

63615	FISCHER Hammerfix type N-FZ	N03C
Material	Plastic Nylon (polyamide)	 
Color	Grey	

Type	☒	Art.number	Type	☒	Art.number
N 6X40 FZ	50	63615.060.040	N 8X40 FZ	50	63615.080.040

Hammerfix with isolating washer

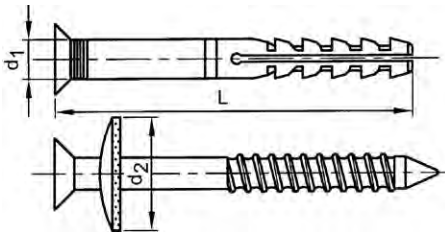

Technical Data

Type	N6x40 D	N6x60 D
d ₁	6	6
d ₂	19	19
Drill depth (min.)	55	75
Drill ø	6	6
Effective anchorage depth (h _{ef})	30	30
Grip range (max.)	10	30
L	40	60
Nail dimension	4x48	4x64
Allowable load (kN)		
Brick Mz12	0.18	0.18
Cellular concrete ≥ PB2	0.04	0.04
Cellular concrete ≥ PB4	0.1	0.1
Concrete C20/25	0.2	0.2
Pumice grit V4	0.12	0.12
Sandlime brick KS12	0.17	0.17

- Allowable loads in kN are valid for screw nails with specified diameters.
- Allowable load includes the safety factor 4.

63617 FISCHER Hammerfix with isolating washer type N-D

N03C

Material Plastic Nylon (polyamide)
Color Grey

fischer 
innovative solutions



Type	☒	Art.number	Type	☒	Art.number
6X40MM	50	63617.060.040	6X60MM	50	63617.060.060

- With pre-assembled stainless steel A2 nail with Pozidriv (Z) cross recess and with stainless steel A2/elastomer isolating washer.

Long-shaft fixing

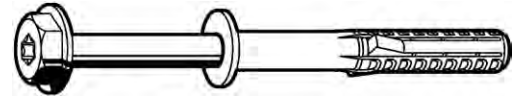
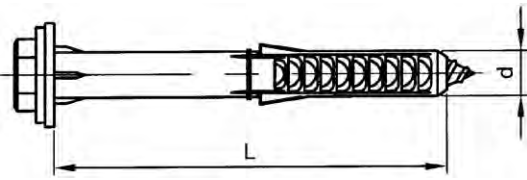

Technical Data										
Type	SX10x80 T	SX10x100 T	SX10x140 T	SX10x160 T	SXS 10x60 F US A4	SXS 10x80 F US A4	SXS 10x100 F US A4	SXS 10x120 F US A4	SXS 10x140 F US A4	SXS 10x160 F US A4
d	10	10	10	10	10	10	10	10	10	10
Drill depth (min.)	90	110	150	170	70	90	110	130	150	170
Drill ø	10	10	10	10	10	10	10	10	10	10
Grip range (max.)	30	50	90	110	10	30	50	70	90	110
L	80	100	140	160	60	80	100	120	140	160
Screw size	7x87	7X107	7X147	7x167	7x69	7x89	7x109	7x129	7x149	7x169
Socket	No.40	No.40	No.40	No.40	No.40	No.40	No.40	No.40	No.40	No.40
Allowable load (kN)										
Concrete ≥ C16/20	2	2	2	2	2	2	2	2	2	2

- Allowable load (kN) for a single anchor for multiple fixings of non-structural applications in normal concrete.
- For combinations of tensile loads, shear loads, bending moments as well as reduced edge distances or spacings (anchor groups) see approval.

Assembly sequence

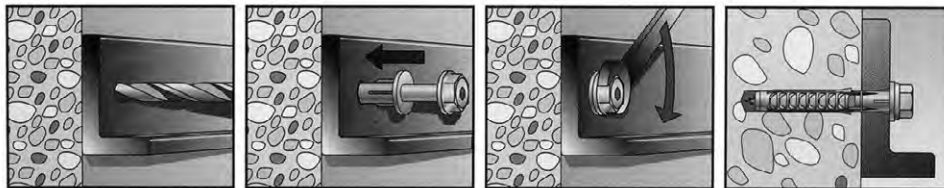

Article groups				
Material		Color	Code	Page
Plastic	SXS-T	Grey	63298	8-32
Plastic	SXS-F US A4	Grey	63174	8-33

8

63298	FISCHER Long-shaft fixing type SXS-T	N03A
Material	Plastic	 
Color	Grey	

Assembly sequence

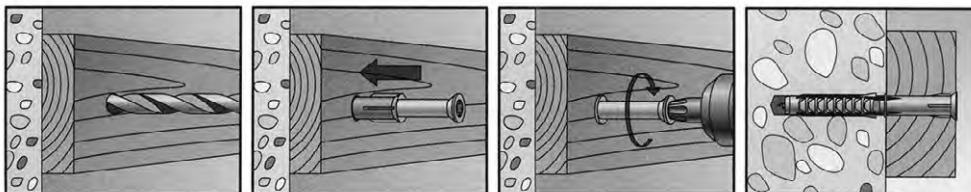

Type	☒	Art.number	Type	☒	Art.number	Type	☒	Art.number
SXS 10X80T	50	63298.100.080	SXS 10X140T	50	63298.100.140	SXS 10X160T	50	63298.100.160
SXS 10X100T	50	63298.100.100						

- With pre-assembled steel zinc plated countersunk head screw with hexalobular.

63174	FISCHER Long-shaft fixing type SXS-F US A4	N03A
Material	Plastic	
Color	Grey	

Type	☒	Art.number	Type	☒	Art.number	Type	☒	Art.number
10X60	50	63174.100.060	10X100	50	63174.100.100	10X140	50	63174.100.140
10X80	50	63174.100.080	10X120	50	63174.100.120	10X160	50	63174.100.160

- Fixing with collar \varnothing 18 x 2 mm, with pre-assembled stainless steel A4 hexagon head screw with hexalobular and with integrated washer.

Frame anchor



Technical Data						
d x L	10x72	10x92	10x112	10x132	10x152	10x182
Drill depth (min.)	60	60	60	60	60	60
Drill \varnothing	10	10	10	10	10	10
Effective anchorage depth (h_{ef})	40	40	40	40	40	40
Thickness of the fixture ($t_{fix,max.}$)	40	60	80	100	120	150
Pull-out force (kN)	1.7	1.7	1.7	1.7	1.7	1.7
Rivet head \varnothing	13	13	13	13	13	13
Shear load (N)	500	500	500	500	500	500
Screw \varnothing	M6	M6	M6	M6	M6	M6

30569	MAXXFAST Frame anchor	MF4A
Material	Steel	
Surface treatment	Zinc plated	

d x L	☒	Art.number	d x L	☒	Art.number	d x L	☒	Art.number
10X72	50	30569.060.072	10X112	50	30569.060.112	10X152	50	30569.060.152
10X92	50	30569.060.092	10X132	50	30569.060.132	10X182	50	30569.060.182

Frame anchor nylon

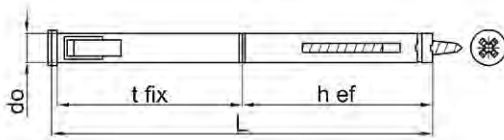

Technical Data

d _o x L	8x80	8x100	8x120	8x140	10x100	10x120	10x140	10x165
Drill depth (min.)	55	55	55	55	55	55	55	55
Drill ø	8	8	8	8	10	10	10	10
Effective anchorage depth (h _{ef})	40	40	40	40	50	50	50	50
Thickness of the fixture (t _{fix,max.})	30	50	70	90	40	60	80	105
Pull-out force (N)	560	560	560	560	960	960	960	960
Rivet head ø	10	10	10	10	12	12	12	12
Shear load (N)	160	160	160	160	240	240	240	240
T _{inst}	4	4	4	4	4	4	4	4

• T_{inst} = Tightening torque in Nm.

30509	MAXXFAST Frame anchor nylon	MF5A
Material	Plastic Nylon (polyamide)	 

Drill ø x L	☒	Art.number	Drill ø x L	☒	Art.number	Drill ø x L	☒	Art.number
8X80	50	30509.080.080	8X140	50	30509.080.140	10X120	50	30509.100.120
8X100	50	30509.080.100				10X140	50	30509.100.140
8X120	50	30509.080.120	10X100	50	30509.100.100	10X165	50	30509.100.165

Frame fixing type F-S

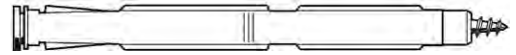
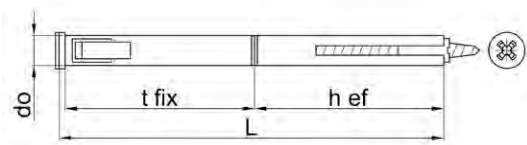

Technical Data

Type	d_o	h_{ef}	L	Min. t_d	t_{fix}
F 10 S 75	10	50	75	90	15
F 10 S 100	10	50	100	115	40
F 10 S 120	10	50	120	135	60
F 10 S 140	10	50	140	155	80
F 10 S 165	10	50	165	180	105

- d_o = Nominal diameter of drill bit
- Min. t_d = Recommended drilling depth
- h_{ef} = Effective anchorage depth
- t_{fix} = Grip range

Assembly sequence

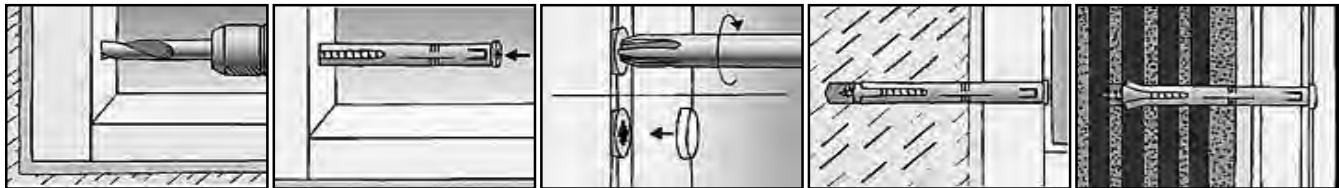

63191 FISCHER Frame fixing type F-S

N03A

Material Plastic Nylon (polyamide)
Color Grey

fischer
innovative solutions



Type	☒	Art.number	Type	☒	Art.number	Type	☒	Art.number
F 10 S 75	50	63191.100.075	F 10 S 120	50	63191.100.120	F 10 S 165	50	63191.100.165
F 10 S 100	50	63191.100.100	F 10 S 140	50	63191.100.140			

Frame fixing type F-M

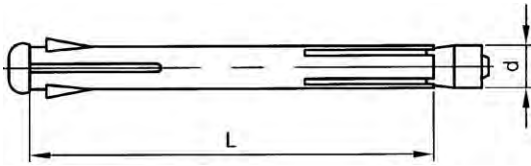

Technical Data

Type	F 8 M 72	F 8 M 92	F 8 M 112	F 8 M 132	F 10 M 72	F 10 M 92	F 10 M 112	F 10 M 132	F 10 M 152	F 10 M 182	F 10 M 202
d	8	8	8	8	10	10	10	10	10	10	10
Drill depth (min.)	90	110	130	150	90	110	130	150	170	200	220
Drill ø	8	8	8	8	10	10	10	10	10	10	10
Effective anchorage depth (h_{ef})	30	30	30	30	30	30	30	30	30	30	30
Grip range (max.)	42	62	82	102	42	62	82	102	122	152	172
L	72	92	112	132	72	92	112	132	152	182	202
Allowable load (kN)											
Brick ≥ Mz12	-	-	-	-	1.28	1.28	1.28	1.28	1.28	1.28	1.28
Concrete ≥ C20/25	-	-	-	-	1.38	1.38	1.38	1.38	1.38	1.38	1.38
Hollow sandlime brick ≥ KSL6	-	-	-	-	0.55	0.55	0.55	0.55	0.55	0.55	0.55
Pumice grit ≥ V2	-	-	-	-	0.48	0.48	0.48	0.48	0.48	0.48	0.48
Sandlime brick ≥ KS12	-	-	-	-	1.28	1.28	1.28	1.28	1.28	1.28	1.28

- Allowable load (kN) for a single anchor for multiple use for non-structural applications.
- Allowable load includes the safety factor 4.
- Fixing sleeve aluminium-zinc coated with steel zinc plated screw with Pozidriv (Z) cross recessed head.

Assembly sequence

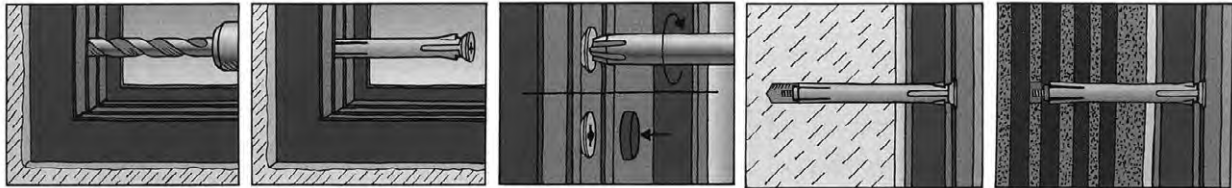

8

63190 FISCHER Frame fixing type F-M N03A

Material: Steel

fischer innovative solutions

RoHS

Type	☒	Art.number	Type	☒	Art.number	Type	☒	Art.number
F 8 M 72	100	63190.080.072	F 10 M 72	100	63190.100.072	F 10 M 152	100	63190.100.152
F 8 M 92	100	63190.080.092	F 10 M 92	100	63190.100.092	F 10 M 182	50	63190.100.182
F 8 M 112	100	63190.080.112	F 10 M 112	100	63190.100.112	F 10 M 202	50	63190.100.202
F 8 M 132	100	63190.080.132	F 10 M 132	100	63190.100.132			

- F 8 M: Mushroom head
- F 10M: Countersunk head

Frame fixing type FUR-T

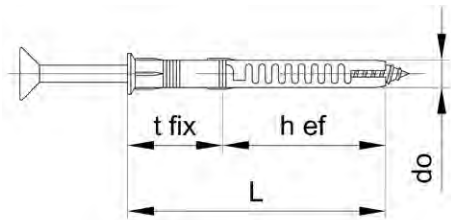

Technical Data

$d_o \times L$	8x100	8x120	10x100	10x115	10x135
h_{ef}	70	70	70	70	70
Min. t_d	110	130	110	125	145
S	10	10	13	13	13
Socket	T30	T30	T40	T40	T40
t_{fix}	30	50	30	45	65
Allowable load (kN)					
Concrete \geq C12/15	-	-	1.8	1.8	1.8

- d_o = Nominal diameter of drill bit
- Min. t_d = Recommended drilling depth
- h_{ef} = Effective anchorage depth
- t_{fix} = Grip range
- Allowable load (kN) for a single anchor for multiple fixings of non-structural applications in normal concret.
- For combinations of tensile loads, shear loads, bending moments as well as reduced edge distances or spacings (anchor groups) see approval.

Assembly sequence

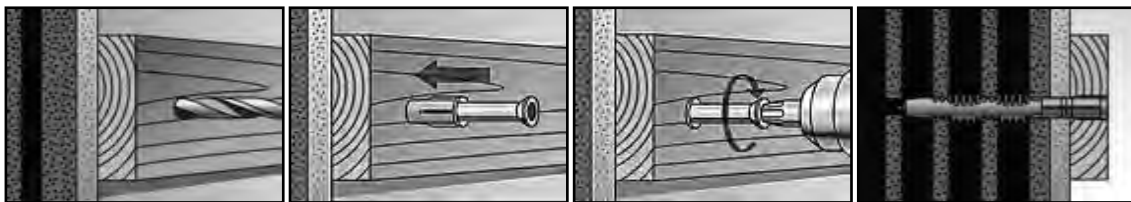

63195 FISCHER Frame fixing type FUR-T

N03A

Material Plastic Nylon (polyamide)
Color Grey

fischer
innovative solutions



Drill $\phi \times L$	☒	Art.number	Drill $\phi \times L$	☒	Art.number	Drill $\phi \times L$	☒	Art.number
8X100MM	50	63195.080.100	10X100MM	50	63195.100.100	10X135MM	50	63195.100.135
8X120MM	50	63195.080.120	10X115MM	50	63195.100.115			

Frame fixing type FUR-SS

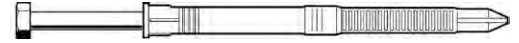
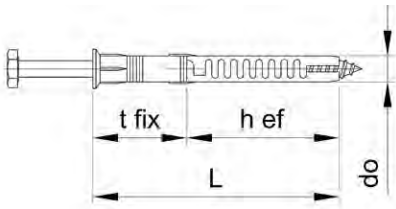

Technical Data

$d_0 \times L$	h_{ef}	Min. t_d	t_{fix}
8x80	70	90	10
8x100	70	110	30
8x120	70	130	50
10x80	70	90	10
10x100	70	110	30
10x115	70	125	45
10x135	70	145	65
10x160	70	170	90
10x185	70	195	115
10x200	70	210	130
10x230	70	240	160

- d_0 = Nominal diameter of drill bit
- Min. t_d = Recommended drilling depth
- h_{ef} = Effective anchorage depth
- t_{fix} = Grip range

Assembly sequence

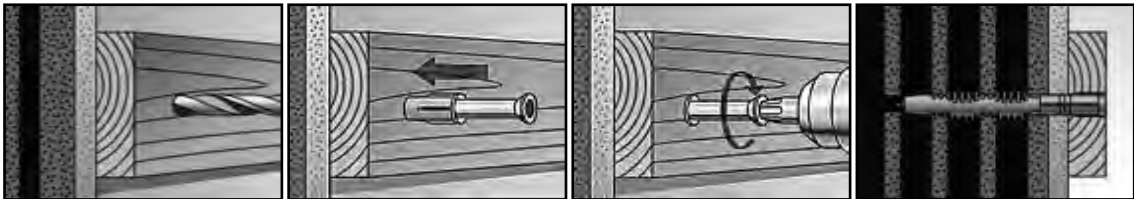

8

63196 FISCHER Frame fixing type FUR-SS		N03A
Material	Plastic Nylon (polyamide)	
Color	Grey	

$d_0 \times L$	☒	Art.number	$d_0 \times L$	☒	Art.number	$d_0 \times L$	☒	Art.number
8X80MM	50	63196.080.080	10X80MM	50	63196.100.080	10X160MM	50	63196.100.160
8X100MM	50	63196.080.100	10X100MM	50	63196.100.100	10X185MM	50	63196.100.185
8X120MM	50	63196.080.120	10X115MM	50	63196.100.115	10X200MM	50	63196.100.200
			10X135MM	50	63196.100.135	10X230MM	50	63196.100.230

Frame fixing type SXR

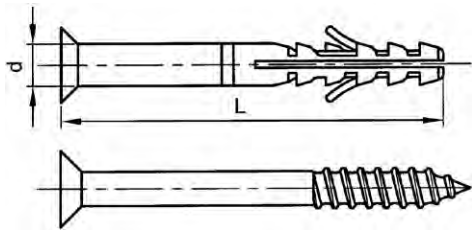

Technical Data

$d_o \times L$	8x60	8x80	8x100	8x120	10x80	10x100	10x120	10x140	10x160
h_{ef}	50	50	50	50	50	50	50	50	50
Min. t_d	70	90	110	130	90	110	130	150	170
Socket	T30	T30	T30	T30	T40	T40	T40	T40	T40
t_{fix}	10	30	50	70	30	50	70	90	110
Allowable load (kN)									
Brick \geq Mz12	0.57	0.57	0.57	0.57	0.57	0.57	0.57	0.57	0.57
Concrete \geq C12/15	1.20	1.20	1.20	1.20	1.98	1.98	1.98	1.98	1.98
Hollow sandlime brick KSL12	0.57	0.57	0.57	0.57	0.57	0.57	0.57	0.57	0.57
Pumice grit \geq V2	-	-	-	-	0.71	0.71	0.71	0.71	0.71
Sandlime brick \geq KS12	0.71	0.71	0.71	0.71	0.86	0.86	0.86	0.86	0.86
Ventilation stone Hlz12	0.17	0.17	0.17	0.17	0.26	0.26	0.26	0.26	0.26

- d = Nominal diameter of drill bit.
- Min. t_d = Recommended drilling depth.
- h_{ef} = Effective anchorage depth.
- t_{fix} = Grip range.
- Allowable load (kN) for a single anchor for multiple fixings of non-structural applications.
- Allowable load includes the safety factor 1,4.
- For combinations of tensile loads, shear loads, bending moments as well as reduced edge distances or spacings (anchor groups) see approval.

Assembly sequence

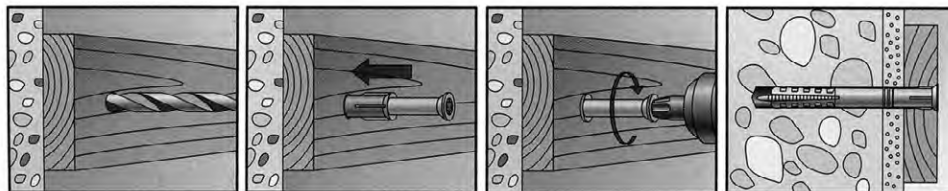

63192 FISCHER Frame fixing type SXR

N03A

Material Plastic Nylon (polyamide)
Color Grey

fischer
innovative solutions



Drill $\phi \times L$	☒	Art.number	Drill $\phi \times L$	☒	Art.number	Drill $\phi \times L$	☒	Art.number
8X60MM	50	63192.080.060	8X120MM	50	63192.080.120	10X120MM	50	63192.100.120
8X80MM	50	63192.080.080	10X80MM	50	63192.100.080	10X140MM	50	63192.100.140
8X100MM	50	63192.080.100	10X100MM	50	63192.100.100	10X160MM	50	63192.100.160

Frame screw

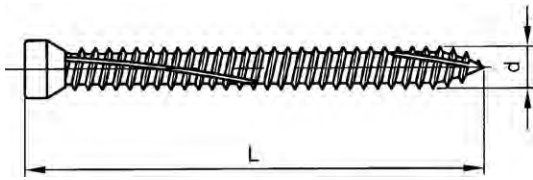

Technical Data

Type	Drill ø	L
7.5x72	6	72
7.5x92	6	92
7.5x112	6	112
7.5X132	6	132
7.5X152	6	152
7.5X182	6	182
7.5X212	6	212

- Suitable for concrete, solid brick, sand lime solid bricks, perforated bricks, sand lime perforated bricks, hollow blocks, solid pumice, aircrete, natural stone etc.

Assembly sequence

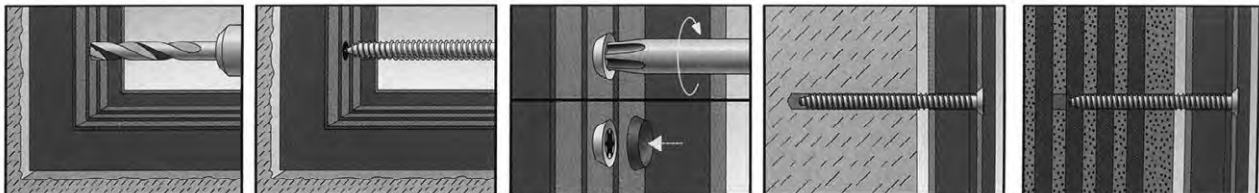

Article groups

Driving features	Material	Surface treatment		Code	Page
Hexalobular	St	Zipl		30564	8-40
Hexalobular	St	Zipl		30565	8-40
Torx®	St	Zipl	FFSZ	63560	8-41
Torx®	St	Zipl	FFS	63562	8-41

8

30564 MAXXFAST Window frame screw - Head 11,5/ Hexalobular 30 MF4A

Material: Steel
Surface treatment: Zinc plated

MAXXFAST
PROFESSIONAL HARDWARE

RoHS

d x L	⊗	Art.number	d x L	⊗	Art.number	d x L	⊗	Art.number
7,5X72MM	100	30564.075.072	7,5X132MM	100	30564.075.132	7,5X182MM	100	30564.075.182
7,5X92MM	100	30564.075.092	7,5X152MM	100	30564.075.152	7,5X212MM	100	30564.075.212
7,5X112MM	100	30564.075.112						

30565 MAXXFAST Window frame screw - Head 7,5/Hexalobular 25 MF5A

Material: Steel
Surface treatment: Zinc plated

MAXXFAST
PROFESSIONAL HARDWARE

RoHS

d x L	⊗	Art.number	d x L	⊗	Art.number	d x L	⊗	Art.number
7,5X72MM	100	30565.075.072	7,5X112MM	100	30565.075.112	7,5X132MM	100	30565.075.132
7,5X92MM	100	30565.075.092						

63560 FISCHER Window frame screw type FFSZ - Head 7,5/TX 25 N03A

Material: Steel
Surface treatment: Zinc plated

fischer innovative solutions

Type	☒	Art.number	Type	☒	Art.number	Type	☒	Art.number
FFSZ 7,5X72	100	63560.075.072	FFSZ 7,5X112	100	63560.075.112	FFSZ 7,5X152	100	63560.075.152
FFSZ 7,5X92	100	63560.075.092	FFSZ 7,5X132	100	63560.075.132	FFSZ 7,5X212	100	63560.075.212

63562 FISCHER Window frame screw type FFS - Head 11,5/TX 30 N03A

Material: Steel
Surface treatment: Zinc plated

fischer innovative solutions

Type	☒	Art.number	Type	☒	Art.number	Type	☒	Art.number
FFS 7,5X72	100	63562.075.072	FFS 7,5X132	100	63562.075.132	FFS 7,5X182	100	63562.075.182
FFS 7,5X92	100	63562.075.092	FFS 7,5X152	100	63562.075.152	FFS 7,5X212	100	63562.075.212
FFS 7,5X112	100	63562.075.112						

Cover cap for window frame screws

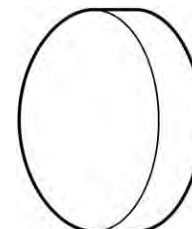
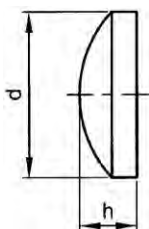

Technical Data

Type	d	h
FSS A-W	15	4
FSS A-BR	15	4

63590 FISCHER Cover cap for window frame screws type FSS A N03A

Material: Plastic Polyamide (nylon)
Class: 6
Color: Assorted

fischer innovative solutions

Type	☒	Art.number	Type	☒	Art.number
White	100	63590.000.011	Dark brown	100	63590.000.019

Adjustable screw

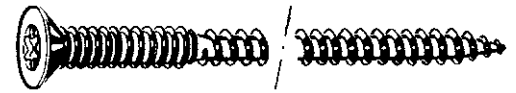

Technical Data	
Type	JS 6x110
Assembly depth (min.)	30
Drill depth (min.)	50-110
Drill ø	5
Socket	T40
Stepless adjustment	0-55
Wood thickness (max.)	25

Assembly sequence

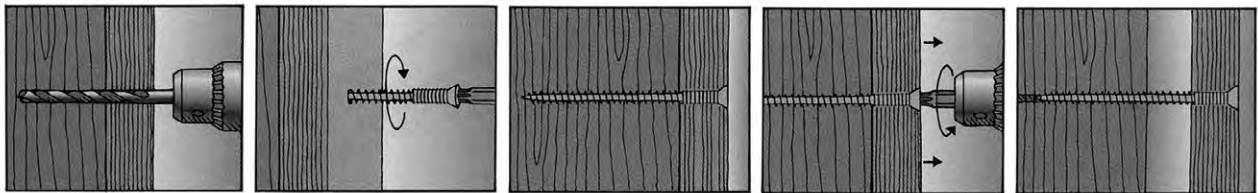

63601 FISCHER Adjustable screw type JS		N03B
Material	Steel	
Surface treatment	Zinc plated	
		 

Type	⊗	Art.number
JS 6X110MM	50	63601.060.110

8

Adjustable fixing



Technical Data	
Type	S10J75S
Assembly depth (min.)	50
Drill depth (min.)	115
Drill ø	10
Plug length	75
Socket	T40
Stepless adjustment	0-30
Wood thickness (max.)	25

- Adjustable fixing type S10J75S for assembly for wood on stone.
- With adjustable screw type JS 6 x 110, steel zinc plated.

Assembly sequence

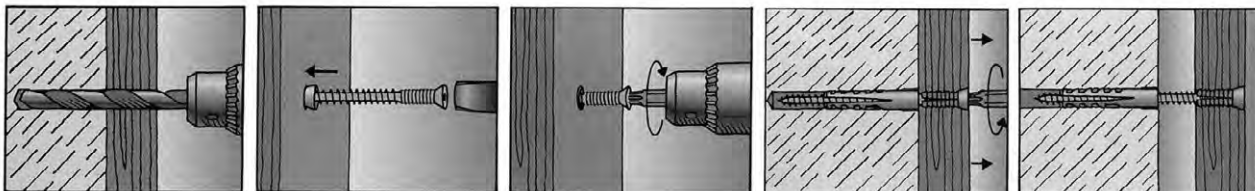

63600	FISCHER Adjustable fixing type S10J75S	N03A
Material	Plastic Nylon (polyamide)	
Color	Grey	

Type	☒	Art.number
S 10-J 75 S	50	63600.060.110

Expanding plug

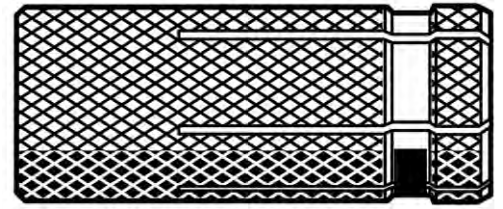
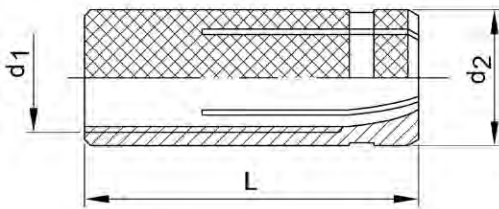

Technical Data

d_1	M4	M5	M6	M8	M10	M12
d_2	5	6	8	10	12	15
Drill depth (min.)	20	22	28	33	40	45
h_{ef}	16	18	23	28	34	38
L	16	18	23	28	34	38
Minimal thickness of concrete element ($h_{min.}$)	25	30	35	40	45	50
Pull-out force (N)	600	700	1000	1500	2100	3200

- h_{ef} = Effective anchorage depth.

30570 MAXXFAST Expanding plug

MF5A

Thread Metric thread
Material Brass

MAXXFAST
PROFESSIONAL HARDWARE

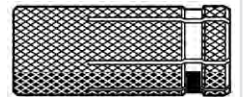

d_1	☒	Art.number	d_1	☒	Art.number	d_1	☒	Art.number
M4	50	30570.040.001	M6	50	30570.060.001	M10	25	30570.100.001
M5	50	30570.050.001	M8	25	30570.080.001	M12	25	30570.120.001

Expanding plug

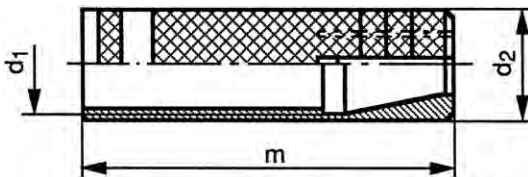

8

Technical Data

d_1	M4	M5	M6	M8	M10	M12
d_2	5	6	7.5	10	12	15.5
Drill \varnothing	5.5	6.5	8	11	13	18
m	16	20	24	30	34	40
P	0.7	0.8	1	1.25	1.5	1.75
Pull-out force (kN)						
Concrete \geq C20/25	0.25	0.4	0.65	1.1	1.6	2.2
Stone \geq 15 N/mm ²	0.2	3.35	0.55	0.9	1.3	1.6

- Drilling depth = fixing part + coating layer + length of plug + 10 mm.
- Length of screw = fixing part + coating layer + length of plug.
- It is advised to take a safetyfactor.

Special features of expanding plugs:

- provided with a conical inner side, expanding equally against the wall of the hole during tightening
- application for installation through the fixture hole
- they can be applied in concrete, stone, bricks, tiles and massive wood
- resistant against corrosion
- resistant against temperatures up to 200°C

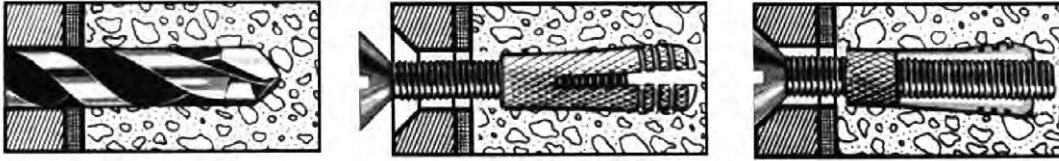

09610 Expanding plug		N07A	
Thread	Metric thread		
Material	Brass		

$d_1 \times m$	☒	Art.number	$d_1 \times m$	☒	Art.number	$d_1 \times m$	☒	Art.number
M4X16	50	09610.040.016	M6X24	50	09610.060.024	M10X34	25	09610.100.034
M5X20	50	09610.050.020	M8X30	25	09610.080.030	M12X40	25	09610.120.040

Expansion shield anchor

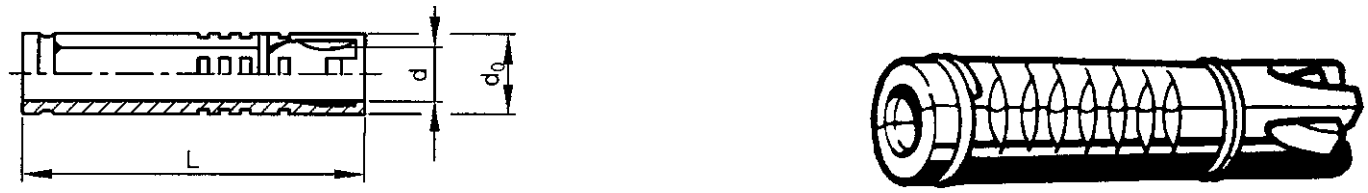

Technical Data

	M6	M8	M10	M12	M16
C_{min}	53	60	75	90	143
d_f	6.5	9	11	13	17
d_o	12	14	16	20	25
f_s	-	-	-	-	-
h_{ef}	45	50	60	75	115
h_{min}	100	100	100	100	142.5
h_o	50	55	65	85	125
k_N	3.33	4.17	6.67	8.89	22.2
L	45	50	60	75	115
S_{min}	35	40	50	60	95
$t_{fix} (max.)$	-	-	-	-	-
T_{inst}	6.5	15	27	50	120

- d_o = Nominal
- T_{inst} = Tightening torque in Nm.
- d_f = Anchor diameter.
- h_{min} = Minimal thickness of concrete member.
- h_o = Recommended drilling depth.
- k_N = Designload is k_N . Non-cracked concrete.
- h_{ef} = Effective anchorage depth.
- S_{min} = Minimal spacing.
- C_{min} = Minimal edge distance.

65450 Expansion shield anchor		N61A	
Thread	Metric thread		
Material	Steel		
Class	5.8		
Surface treatment	Zinc plated		

d	☒	Art.number	d	☒	Art.number	d	☒	Art.number
M6	100	65450.060.001	M10	100	65450.100.001	M16	25	65450.160.001
M8	100	65450.080.001	M12	50	65450.120.001			

Expansion shield

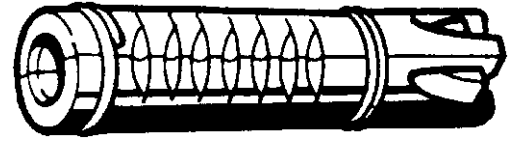
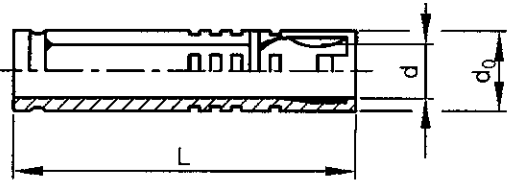

Technical Data

Type	d	d _d	d _o	k _N	L	T _{inst}
M6 (rvs)	M6	40	10	5.7	40	10
M8 (rvs)	M8	50	14	9.3	50	25
M10 (rvs)	M10	60	16	21.5	60	50
M12 (rvs)	M12	80	20	28.4	80	85

- d_n = Nominal diameter of drill bit.
- d_o = Embedment depth.
- d_f = Anchor diameter.
- k_N = Designload is k_N, Non-cracked concrete.
- T_{inst} = Tightening torque in Nm.

09561 Expansion shield

P01A

Thread Metric thread
Material Stainless steel A4



d x L	☒	Art.number	d x L	☒	Art.number	d x L	☒	Art.number
M6X40	50	09561.060.040	M10X60	25	09561.100.060	M12X80	10	09561.120.080
M8X50	50	09561.080.050						

Expansion shield anchor bolt projecting version

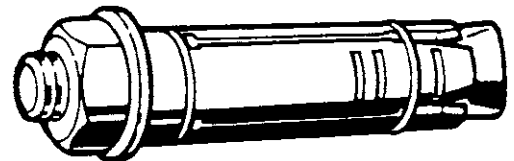
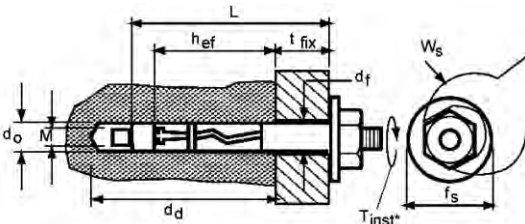

Technical Data

d x t _{fix}	M6x10	M6x25	M6x60	M8x10	M8x25	M8x60	M10x15	M10x30	M10x60	M12x15	M12x30	M12x75	M16x15	M16x35
C _{min.}	53	53	53	60	60	60	75	75	75	90	90	90	143	143
d	M6	M6	M6	M8	M8	M8	M10	M10	M10	M12	M12	M12	M16	M16
d _f	6.5	6.5	6.5	9	9	9	11	11	11	13	13	13	17	17
d _o	12	12	12	14	14	14	16	16	16	20	20	20	25	25
f _s	12.5	12.5	12.5	17	17	17	21	21	21	24	24	24	30	30
h _{ef}	45	45	45	50	50	50	60	60	60	80	80	80	120	120
h _{min.}	100	100	100	100	100	100	100	100	100	100	100	100	142.5	142.5
h _o	50	50	50	55	55	55	65	65	65	85	85	85	125	125
k _N	3.33	3.33	3.33	4.17	4.17	4.17	6.67	6.67	6.67	8.89	8.89	8.89	22.2	22.2
L	65	80	115	75	90	125	90	105	135	110	125	170	150	170
s	10	10	10	13	13	13	17	17	17	19	19	19	24	24
S _{min.}	35	35	35	40	40	40	50	50	50	60	60	60	95	95
t _{fix} (max.)	10	25	60	10	25	60	15	30	60	15	30	75	15	35
T _{inst}	6.5	6.5	6.5	15	15	15	27	27	27	50	50	50	120	120

- d_n = Nominal diameter of drill bit.
- f_s = Washer outside diameter.
- s (W_s) = Width across flats.
- T_{inst} = Tightening torque in Nm.
- d_f = Anchor diameter.
- h_{min.} = Minimal thickness of concrete member.
- d_o (h_o) = Recommended drilling depth.
- t_{fix} = Grip range.
- h_{ef} = Effective anchorage depth.
- S_{min.} = Minimal spacing.
- C_{min.} = Minimal edge distance.

65435	Expansion shield anchor bolt projecting version	N61A
Thread	Metric thread	
Material	Steel	
Class	5.8	
Surface treatment	Zinc plated	



Final calculations should comply with the complete European Technical Approval (ETA), this approval is also available on request.

$d \times t_{fix}$	☒	Art.number	$d \times t_{fix}$	☒	Art.number	$d \times t_{fix}$	☒	Art.number
M6X10	50	65435.060.010	M8X60	50	65435.080.060	M12X15	25	65435.120.015
M6X25	50	65435.060.025	M10X15	50	65435.100.015	M12X30	25	65435.120.030
M6X60	50	65435.060.060	M10X30	50	65435.100.030	M12X75	25	65435.120.075
M8X10	50	65435.080.010	M10X60	50	65435.100.060	M16X15	10	65435.160.015
M8X25	50	65435.080.025				M16X35	10	65435.160.035

Expansion shield anchor loose bolt version

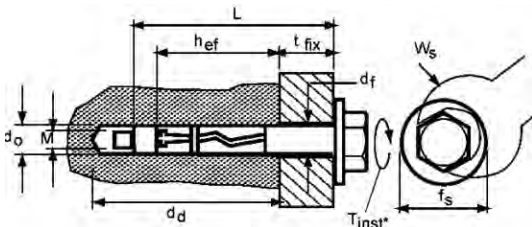

Technical Data																
$d \times t_{fix}$	M6x10	M6x25	M6x40	M8x10	M8x25	M8x40	M10x10	M10x25	M10x50	M10x75	M12x10	M12x40	M12x60	M16x15	M16x30	M16x60
C_{min}	53	53	53	60	60	60	75	75	75	75	90	90	90	143	143	143
d	M6	M6	M6	M8	M8	M8	M10	M10	M10	M10	M12	M12	M12	M16	M16	M16
d_f	6.5	6.5	6.5	9	9	9	11	11	11	11	13	13	13	17	17	17
d_o	12	12	12	14	14	14	16	16	16	16	20	20	20	25	25	25
f_s	12.5	12.5	12.5	17	17	17	21	21	21	21	24	24	24	30	30	30
h_{ef}	45	45	45	50	50	50	60	60	60	60	80	80	80	120	120	120
h_{min}	100	100	100	100	100	100	100	100	100	100	100	100	100	142.5	142.5	142.5
h_o	50	50	50	55	55	55	65	65	65	65	85	85	85	125	125	125
k_N	3.33	3.33	3.33	4.17	4.17	4.17	6.67	6.67	6.67	6.67	8.89	8.89	8.89	22.2	22.2	22.2
L	55	70	85	65	80	95	75	90	115	140	90	120	140	135	150	180
s	10	10	10	13	13	13	17	17	17	17	19	19	19	24	24	24
S_{min}	35	35	35	40	40	40	50	50	50	50	60	60	60	95	95	95
$t_{fix} (max.)$	10	25	40	10	25	40	10	25	50	75	10	40	60	15	30	60
T_{inst}	6.5	6.5	6.5	15	15	15	27	27	27	27	50	50	50	120	120	120

- d_o = Nominal diameter of drill bit.
- f_o = Head diameter.
- W_s = Width across flats.
- T_{inst} = Tightening torque in Nm.
- d_f = Anchor diameter.
- h_{min} = Minimal thickness of concrete member.
- h_o = Recommended drilling depth.
- k_N = Designload is k_N , Non-cracked concrete.
- t_{fix} = Grip range.
- h_{ef} = Effective anchorage depth.
- S_{min} = Minimal spacing.
- C_{min} = Minimal edge distance.

65445 Expansion shield anchor loose bolt version N61A

Thread: Metric thread
Material: Steel
Class: 5.8

RAWL FIXINGS

RoHS



Final calculations should comply with the complete European Technical Approval (ETA), this approval is also available on request.

d x t _{fix}	☒	Art.number	d x t _{fix}	☒	Art.number	d x t _{fix}	☒	Art.number
M6X10	50	65445.060.010	M10X10	50	65445.100.010	M12X40	25	65445.120.040
M6X25	50	65445.060.025	M10X25	50	65445.100.025	M12X60	25	65445.120.060
M6X40	50	65445.060.040	M10X50	50	65445.100.050	M16X15	10	65445.160.015
M8X10	50	65445.080.010	M10X75	50	65445.100.075	M16X30	10	65445.160.030
M8X25	50	65445.080.025	M12X10	25	65445.120.010	M16X60	10	65445.160.060
M8X40	50	65445.080.040						

Expansion anchor with brass cone

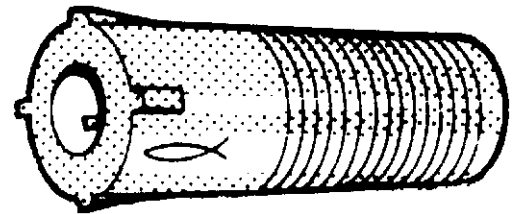
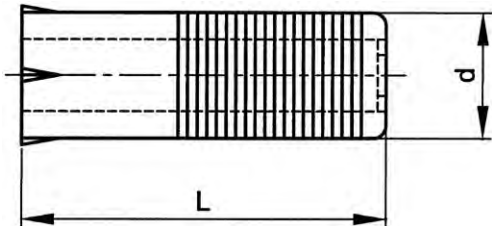

Technical Data

Type	M5	M6	M8	M10	M12
d	10	12	16	20	24
Drill depth (min.)	45	50	65	80	90
Drill ø	10	12	16	20	24
L	35	40	50	60	70
T _{inst}	4	7	16	32	54
Pull-out force (kN)					
Concrete ≥ C20/25	1.1	1.8	2.6	4.4	5.0

- T_{inst} = Tightening torque in Nm.
- Allowable load (kN) for a single anchor, valid for machine screws with the specified thread size.
- Allowable load includes the safety factor 5.

Assembly sequence

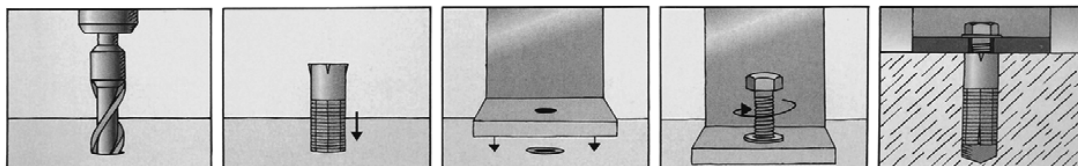

63400 FISCHER Expansion anchor with brass cone type M N03B

Thread: Metric thread
Material: Glass-fibre reinforced plastic

fischer innovative solutions



Type	☒	Art.number	Type	☒	Art.number	Type	☒	Art.number
M5	50	63400.050.001	M8	20	63400.080.001	M12	5	63400.120.001
M6	50	63400.060.001	M10	10	63400.100.001			

Anchor

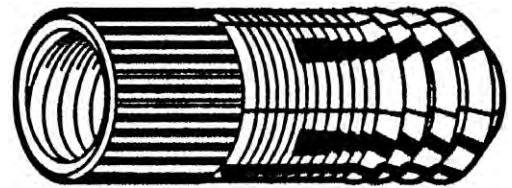
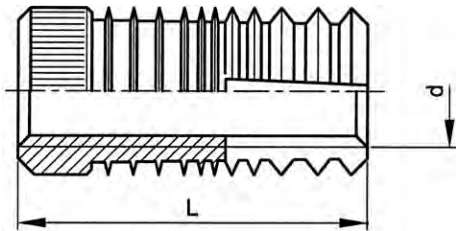

Technical Data

Type	PA 4 M6/7,5	PA 4 M6/13,5	PA 4 M8/25	PA 4 M10/25
Assembly depth (min.)	7.5	13.5	25.0	25.0
d	M6	M6	M8	M10
Drill depth (min.)	7.5	13.5	25.0	25.0
Drill ø	8	8	10	12
Drill ø in construction	7.5	7.5	9.5	11.5
L	7.5	13.5	25	25
P	1.00	1.00	1.25	1.50
Allowable load (kN)				
Beech wood	0.5	1.0	-	-
Brick Mz12	-	0.80	1.95	2.30
Chipboard	0.2	0.4	-	-
Pine wood	0.18	0.38	-	-
Plastic	0.75	2.00	-	-

- Length of screw min. = length of plug + thickness of fixing part.
- Allowable load (kN) for a single anchor, valid for machine screws with the specified thread size.
- Allowable load includes the safety factor 4.

Assembly sequence

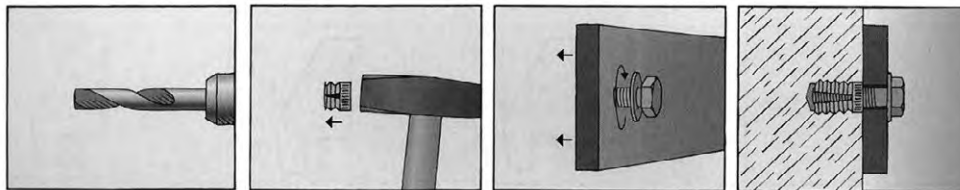

63410 FISCHER Anchor type PA 4

N03A

Thread Metric thread
Material Brass

fischer
innovative solutions

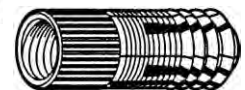

Type	☒	Art.number	Type	☒	Art.number	Type	☒	Art.number
PA4 M6X7,5	200	63410.060.007	PA4 M8X25	50	63410.080.025	PA4 M10X25	25	63410.100.025
PA4 M6X13,5	100	63410.060.013						

Sleeve anchor FSA-S

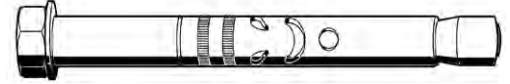
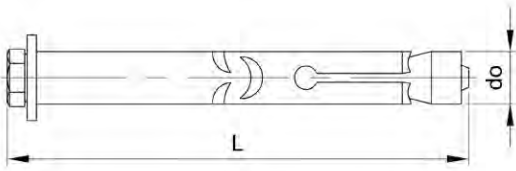

Technical Data

Type	FSA 8/15 S	FSA 8/40 S	FSA 8/65 S	FSA 10/10 S	FSA 10/35 S	FSA 10/60 S	FSA 12/10 S	FSA 12/25 S	FSA 12/50 S
d_o	8	8	8	10	10	10	12	12	12
h_{ef}	35	35	35	40	40	40	50	50	50
L	59	84	109	60	86	110	70	85	110
Min. t_d	65	90	115	65	90	115	75	90	115
t_{fix}	15	40	65	10	35	60	10	25	50
Allowable load (kN)									
Concrete ≥ C20/25	5.2	5.2	5.2	12.9	12.9	12.9	25.7	25.7	25.7

- **d_o** = Nominal diameter of drill bit
- **t_{fix}** = Grip range
- **h_{ef}** = Effective anchorage depth
- **Min. t** = Recommended drilling depth
- The allowable load is valid for one single anchor, at cracked concrete (tensile zone) with concrete class ≥ C20/25.

Assembly sequence

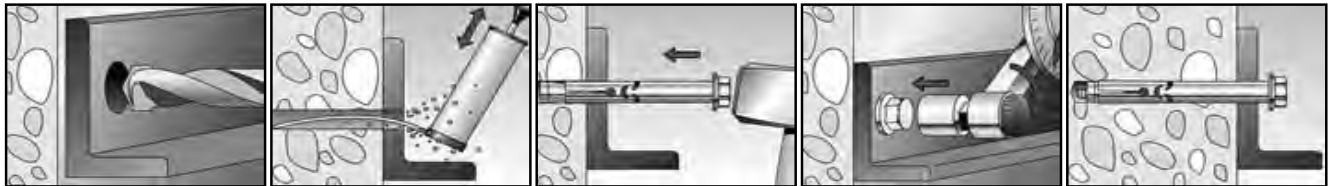

63226 FISCHER Sleeve anchor FSA-S

N03A

Thread Metric thread
Material Steel
Surface treatment Zinc plated



8

Type	⊗	Art.number	Type	⊗	Art.number	Type	⊗	Art.number
FSA 8/15 S	50	63226.080.015	FSA 10/10 S	20	63226.100.010	FSA 12/10 S	20	63226.120.010
FSA 8/40 S	50	63226.080.040	FSA 10/35 S	20	63226.100.035	FSA 12/25 S	20	63226.120.025
FSA 8/65 S	50	63226.080.065	FSA 10/60 S	20	63226.100.060	FSA 12/50 S	20	63226.120.050

Rawlnut rubber with brass threaded bush

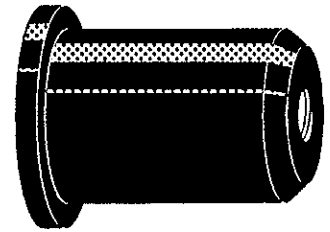
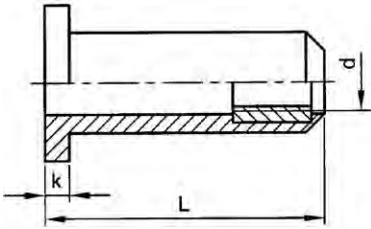

Technical Data

d x L	Drill ø	Grip range (max.)	k
M4x12.6	8	0 - 4	1.4
M4x24	8	6 - 14	1.4
M5x14	10	0 - 5	1.3
M5x25	10	8 - 16	1.3
M5x38	10	20 - 30	1.3
M6x15	13	0 - 3	1.3
M6x25	13	6 - 13	2
M6x35	13	11 - 23	1.3
M8x27.9	16	4 - 10	5
M8x30	18	6 - 15	1.2
M8x50	18	15 - 39	2
M10x55	20	20 - 36	1.3
M12x75	24	30 - 50	1.3

65421 RAWLNUT rubber with brass threaded bush

N61B

Thread Metric thread
Material Rubber

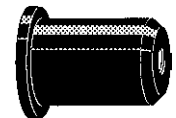

d x L	☒	Art.number	d x L	☒	Art.number	d x L	☒	Art.number
M4X12,6	50	65421.040.011	M6X15	50	65421.060.015	M8X30	50	65421.080.031
M4X24	50	65421.040.024	M6X25	50	65421.060.025	M8X50	50	65421.080.050
M5X14	50	65421.050.014	M6X35	50	65421.060.035	M10X55	25	65421.100.055
M5X25	50	65421.050.025	M8X27,9	50	65421.080.030	M12X75	20	65421.120.075
M5X38	50	65421.050.038						

Hammerset anchor

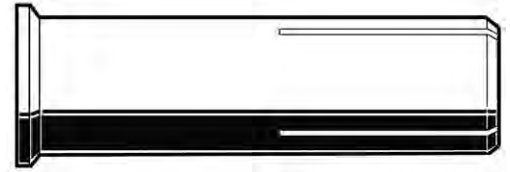
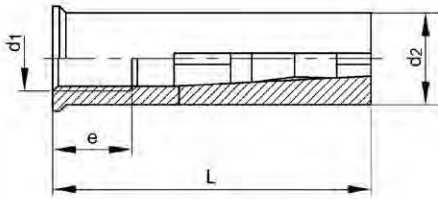

Technical Data

	M6	M8	M10	M12	M16	M20
d_1	M6	M8	M10	M12	M16	M20
$C_{min.}$	105	105	140	175	230	280
d_o	8	10	12	15	20	25
d_w	7	9	12	14	18	22
e (max.)	10	13	17	21	27	34
e (min.)	6	8	10	12	16	20
h_1	27	33	43	54	70	86
h_c	100	100	100	100	130	160
L	25	30	40	50	65	80
N_{rec}	2.08	2.74	3.57	5.87	8.73	11.94
$S_{min.}$	60	90	80	100	130	160
T_{inst}	4	11	17	38	60	120

- d_1 = Nominal diameter of drill bit
- d_o = Diameter of clearance hole in the fixture
- h_1 = Depth of drilled hole to deepest point
- h_c = Minimal thickness of concrete element
- e = Bolt length to be threaded
- $S_{min.}$ = Minimal spacing
- $C_{min.}$ = Minimal edge distance
- N_{rec} = Recommended load in kN
- T_{inst} = Tightening torque in Nm
- The allowable load (N_{rec}) is valid for one single anchor, at non-cracked concrete (pressure zone) with concrete class C20/25, incl. partial safety factor $\gamma_f = 1,4$ and if the $S_{min.}$ and $C_{min.}$ are taken in to account.

Article groups

Thread	Material	Surface treatment	Code	Page
M	St	Zipl	30577	8-52
M	St	Zipl yell.p.	30575	8-52
M	St.St. A4		30576	8-53

8

30577 MAXXFAST Hammerset anchor DC-MAXX MF5A

Thread	Metric thread		
Material	Steel		
Surface treatment	Zinc plated		

d_1	☒	Art.number	d_1	☒	Art.number	d_1	☒	Art.number
M6	100	30577.060.001	M10	50	30577.100.001	M12 Diamond cut*	10	30577.120.002
M8	100	30577.080.001	M12	25	30577.120.001	M16	25	30577.160.001

*Special for diamond drilling machines.

30575 MAXXFAST Hammerset anchor D-MAXX MF5A

Thread	Metric thread		
Material	Steel		
Surface treatment	Zinc plated yellow passivated		

d_1	☒	Art.number	d_1	☒	Art.number	d_1	☒	Art.number
M6	100	30575.060.001	M10	50	30575.100.001	M16	25	30575.160.001
M8	100	30575.080.001	M12	25	30575.120.001	M20	10	30575.200.001

30576 MAXXFAST Hammerset anchor D-MAXX		MF5A
Thread	Metric thread	
Material	Stainless steel A4	

d_1	☒	Art.number	d_1	☒	Art.number	d_1	☒	Art.number
M6	100	30576.060.001	M10	50	30576.100.001	M16	25	30576.160.001
M8	100	30576.080.001	M12	25	30576.120.001	M20	10	30576.200.001

Hammerset anchor

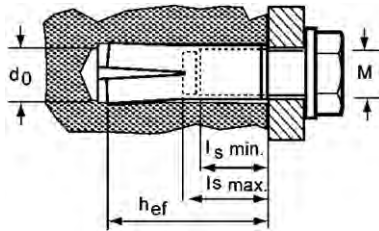

Technical Data

Type	d	d _o	h _{ef}	k _N	L	l _s (max.)	l _s min.	t	T _{inst}
EA II M6	M6	8	30	4	30	13	6	32	4
EA II M8	M8	10	30	4	30	13	8	33	8
EA II M10	M10	12	40	6.1	40	17	10	43	15
EA II M12	M12	15	50	8.5	50	22	12	54	35
EA II M16	M16	20	65	12.6	65	28	16	70	60
EA II M20	M20	25	80	17.2	80	34	20	85	120

- d = Nominal diameter of drill bit.
- t = Recommended drilling depth.
- L (h_{ef}) = Effective anchorage depth.
- l_{s min.} = Screw-in depth min.
- l_{s max.} = Screw-in depth max.
- k_N = Load in kN in combination with 8.8 & A4-70 bolts.
- T_{inst} = Tightening torque in Nm.
- The cone must be installed with setting tool type EAW H (narrow end) into the anchor body (article group 63322).
- Only part of the approval for light suspended ceilings.
- For further technical data the approval is available on request.

Assembly sequence

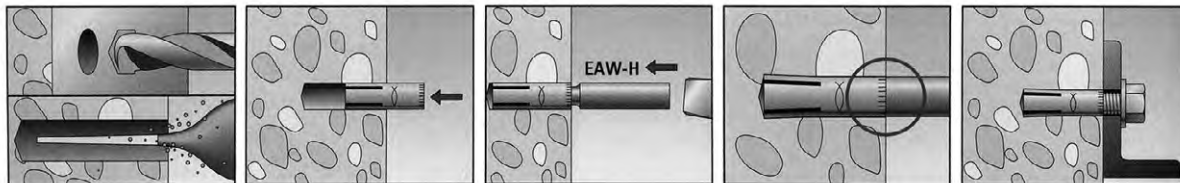

Article groups

Thread	Material	Surface treatment	Code	Page
M	St	Zipl	63320	8-54
M	St.St. A4		63321	8-54

63320 FISCHER Hammerset anchor type EA II N03A

Thread	Metric thread		
Material	Steel		
Surface treatment	Zinc plated		





Final calculations should comply with the complete European Technical Approval (ETA), this approval is also available on request.

Type	☒	Art.number	Type	☒	Art.number	Type	☒	Art.number
EA II M6 (EV)	100	63320.060.001	EA II M12 (EV)	25	63320.120.001	EA II M16 (EV)	20	63320.160.001
EA II M8 (EV)	100	63320.080.001	EA II M12 D (EV)	25	63320.120.005	EA II M20 (EV)	10	63320.200.001
EA II M10 (EV)	50	63320.100.001						

63321 FISCHER Hammerset anchor type EA II N03A

Thread	Metric thread		
Material	Stainless steel A4		





Final calculations should comply with the complete European Technical Approval (ETA), this approval is also available on request.

Type	☒	Art.number	Type	☒	Art.number	Type	☒	Art.number
EA II M6 A4	100	63321.060.001	EA II M10 A4	50	63321.100.001	EA II M16 A4	20	63321.160.001
EA II M8 A4	100	63321.080.001	EA II M12 A4	25	63321.120.001	EA II M20 A4	20	63321.200.001

Setting tool

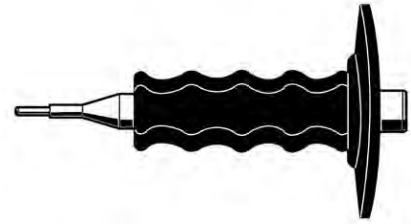

Article groups

Material	Surface treatment	Code	Page
St		30579	8-55
St	Zipl	63322	8-55

30579 MAXXFAST Setting tool MF5A

Material	Steel		
----------	-------	---	---

Size	☒	Art.number	Size	☒	Art.number	Size	☒	Art.number
M6	1	30579.060.001	M10	1	30579.100.001	M16	1	30579.160.001
M8	1	30579.080.001	M12	1	30579.120.001	M20	1	30579.200.001

63322 Setting tool N03A

Material	Steel		
Surface treatment	Zinc plated	<i>innovative solutions</i>	

Type	☒	Art.number	Type	☒	Art.number	Type	☒	Art.number
EAW H 6 PLUS	1	63322.060.001	EAW H 10 PLUS	1	63322.100.001	EAW H 16 PLUS	1	63322.160.001
EAW H 8 PLUS	1	63322.080.001	EAW H 12 PLUS	1	63322.120.001	EAW H 20 PLUS	1	63322.200.001

Setting tool SA



70967	SPIT Setting tool	P03C
Material	Steel	



Type	☒	Art.number	Type	☒	Art.number	Type	☒	Art.number
S 6	1	70967.000.006	S 10	1	70967.000.010	S 12	1	70967.000.012
S 8	1	70967.000.008						

Hollow-ceiling anchor type FHY

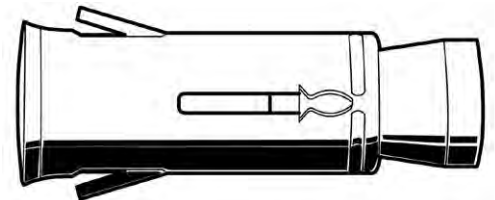
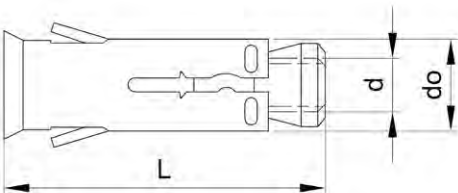



Technical Data

Type / d	FHY M6	FHY M8	FHY M10
d_o	10	12	16
h_{ef}	30	35	40
L	37	43	52
Min. t_d	50	60	65
Structural part thickness (min.)	40	40	40
T_{inst}	10	10	20
Allowable load (kN)			
Concrete \geq C45/55	2	2	3

- d_n = Nominal diameter of drill bit
- Min. t_d = Recommended drilling depth
- h_{ef} = Effective anchorage depth
- T_{inst} = Tightening torque in Nm. (screws for class 5.8 or A4-70).
- Allowable load (kN) for a single anchor in pre-stressed hollow-core concrete panels.
- For combinations of tensile loads, shear loads, bending moments as well as reduced edge distances or spacings (anchor groups) see approval.

Assembly sequence



63428	FISCHER Hollow-ceiling anchor type FHY	N03A
Thread	Metric thread	
Material	Steel	<i>innovative solutions</i>
Surface treatment	Zinc plated	
		

8

Type / d	☒	Art.number	Type / d	☒	Art.number	Type / d	☒	Art.number
FHY M6	50	63428.060.001	FHY M8	25	63428.080.001	FHY M10	20	63428.100.001

Anchoring screw countersunk

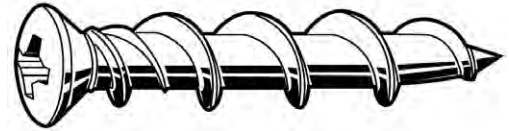
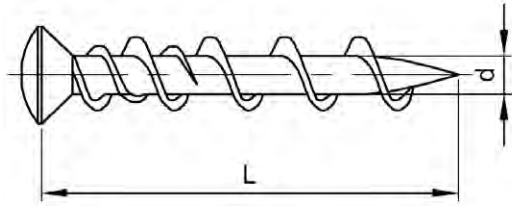

Technical Data

d x L	d _o	h _o	L	No. cross recess	No. Torx®	N _{rec}	t _{fix}
5x32	5	35	32	2	-	0.3	3
5x50	5	35	50	-	25	0.3	21
5x70	5	35	70	-	25	0.3	41

- d_o = Nominal diameter of drill bit.
- h_o = Drilling depth.
- N_{rec} = Recommended load in kN for concrete.
- t_{fix} = Grip range.

Article groups

Driving features	Material	Surface treatment	Code	Page	
Phillips	St	Zipl	70527	8-57	
Phillips	St	Zipl	white head	70528	8-57
Torx®	St	Zipl	70529	8-57	

70527 Anchoring screw countersunk Phillips type WALLDOG

P05A

Material Steel
Surface treatment Zinc plated



d x L	☒	Art.number
5X32MM	100	70527.050.032

- Full boxes only.

70528 Anchoring screw countersunk Phillips type WALLDOG white head

P05A

Material Steel
Surface treatment Zinc plated



d x L	☒	Art.number
5X32MM	100	70528.050.032

- Full boxes only.

70529 Anchoring screw countersunk Torx® type WALLDOG

P05A

Material Steel
Surface treatment Zinc plated



d x L	☒	Art.number	d x L	☒	Art.number
5X50MM	100	70529.050.050	5X70MM	100	70529.050.070

- Full boxes only.

Anchoring screw round head

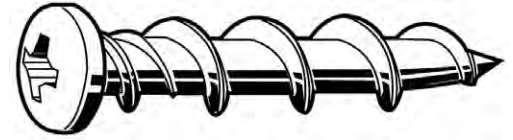
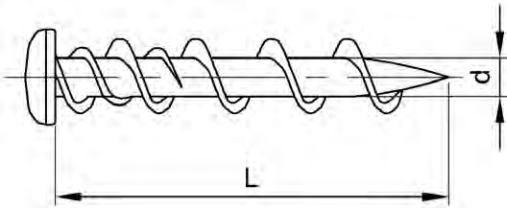

Technical Data

d x L	d	L	No. cross recess	No. Torx®	N _{rec}	t _{fix}
5x32	5	32	2	-	0.3	3
5x50	5	50	-	25	0.3	21
5x70	5	70	-	25	0.3	41

- N_{rec} = Recommended load in kN
- t_{fix} = Grip range

Article groups

Driving features	Material	Surface treatment	Code	Page	
Phillips	St	Zipl	70530	8-58	
Phillips	St	Zipl	white head	70531	8-58
Torx®	St	Zipl	70532	8-58	

70530 Anchoring screw round head Phillips type WALLDOG P05A

Material Steel
Surface treatment Zinc plated



d x L	Art.number
5X32MM	70530.050.032

- Full boxes only.

70531 Anchoring screw round head Phillips type WALLDOG white head P05A

Material Steel
Surface treatment Zinc plated



d x L	Art.number
5X32MM	70531.050.032

- Full boxes only.

70532 Anchoring screw round head Torx® type WALLDOG P05A

Material Steel
Surface treatment Zinc plated



d x L	Art.number	d x L	Art.number
5X50MM	70532.050.050	5X70MM	70532.050.070

- Full boxes only.

Anchoring screw hexagon type TAPH

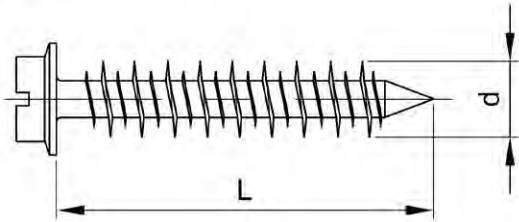

Technical Data

d x L	d _o	L	N _{rec}	s	t _{fix}
4.8x32	4.0	32	0.5	1/4	7
4.8x45	4.0	45	0.5	1/4	20
4.8x57	4.0	57	0.5	1/4	32
6.3x32	4.8	32	0.5	5/16-8MM	7
6.3x45	4.8	45	0.5	5/16-8MM	20
6.3x57	4.8	57	0.5	5/16-8MM	32
6.3x70	4.8	70	0.5	5/16-8MM	45
6.3x82	4.8	82	0.5	5/16-8MM	57

- d_o = Nominal diameter of drill bit.
- h_o = Drilling depth.
- N_{rec} = Recommended load in kN for concrete.
- t_{fix} = Grip range.

70525 Anchoring screw hexagon type TAPH

P05A

Material Steel
Surface treatment Perma-Seal



d x L	☒	Art.number	d x L	☒	Art.number	d x L	☒	Art.number
4,8X32MM	100	70525.048.032	6,3X32MM	100	70525.063.032	6,3X57MM	100	70525.063.057
4,8X45MM	100	70525.048.045	6,3X45MM	100	70525.063.045	6,3X70MM	100	70525.063.070
4,8X57MM	100	70525.048.057				6,3X82MM	100	70525.063.082

Anchoring screw countersunk type TAPC

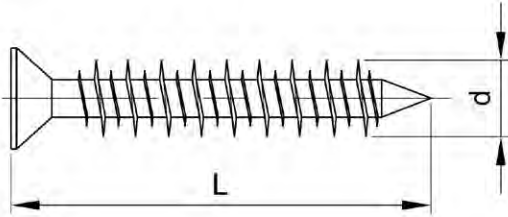

Technical Data

d x L	d _o	L	No. cross recess	N _{rec}	t _{fix}
4.8x32	4.0	32	2	0.5	7
4.8x45	4.0	45	2	0.5	20
4.8x57	4.0	57	2	0.5	32
4.8x70	4.0	70	2	0.5	45
4.8x82	4.0	82	2	0.5	57
4.8x100	4.0	100	2	0.5	75
6.3x32	4.8	32	3	0.5	7
6.3x45	4.8	45	3	0.5	20
6.3x57	4.8	57	3	0.5	32
6.3x70	4.8	70	3	0.5	45
6.3x82	4.8	82	3	0.5	57
6.3x100	4.8	100	3	0.5	75
6.3x125	4.8	125	3	0.5	100

- d_o = Nominal diameter of drill bit.
- N_{rec} = Recommended load in kN.
- t_{fix} = Grip range.

70526 Anchoring screw countersunk type TAPC P05A

Material: Steel
Surface treatment: Perma-Seal

d x L	☒	Art.number	d x L	☒	Art.number	d x L	☒	Art.number
4,8X32MM	100	70526.048.032	4,8X100MM	100	70526.048.100	6,3X70MM	100	70526.063.070
4,8X45MM	100	70526.048.045	6,3X32MM	100	70526.063.032	6,3X82MM	100	70526.063.082
4,8X57MM	100	70526.048.057	6,3X45MM	100	70526.063.045	6,3X100MM	100	70526.063.100
4,8X82MM	100	70526.048.082	6,3X57MM	100	70526.063.057	6,3X125MM	100	70526.063.125

Concrete anchoring screw hexagon type BT

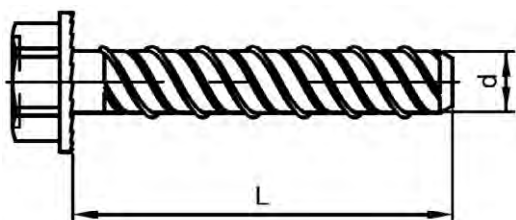

Technical Data

Type	d	L	N _{rec}	s	t _{fix}
BT550	5	50	1.5	7	15
BT650	6	50	1.5	10	15
BT680	6	80	1.9	10	35
BT6100	6	100	1.9	10	55
BT6120	6	120	1.9	10	75
BT6140	6	140	1.9	10	95
BT850	8	50	1.9	13	5
BT875	8	75	3.3	13	10
BT8100	8	100	3.3	13	35
BT1060	10	60	2.6	17	5
BT1075	10	75	2.6	17	20
BT10100	10	100	2.6/4.1	17	45/25
BT10110	10	110	2.6/4.1	17	55/35
BT10120	10	120	2.6/4.1	17	65/45
BT10140	10	140	2.6/4.1	17	85/65
BT10160	10	160	2.6/4.1	17	105/85
BT10200	10	200	2.6/4.1	17	145/125
BT10240	10	240	2.6/4.1	17	185/165
BT10280	10	280	2.6/4.1	17	225/205
BT10320	10	320	2.6/4.1	17	265/245
BT1275	12	75	4.1	19	5
BT12100	12	100	4.1/5.4	19	30/15
BT12150	12	150	4.1/5.4	19	80/65
BT12200	12	200	4.1/5.4	19	130/115
BT16100	16	100	6.3	23	20
BT16150	16	150	6.3/9.9	23	70/40
BT16200	16	200	6.3/9.9	23	120/90
BT16240	16	240	6.3/9.9	23	160/130
BT16280	16	280	6.3/9.9	23	200/170
BT16320	16	320	6.3/9.9	23	240/120

- d = Nominal diameter of drill bit.
- N_{rec} = Recommended load in kN.
- s = Width across flats.
- t_{fix} = Grip range.

70520 Concrete anchoring screw hexagon type BT

P05A

Material Steel
Surface treatment Zinc plated

Powers
FASTENING INNOVATIONS



Final calculations should comply with the complete European Technical Approval (ETA), this approval is also available on request.

d x L	☒	Art.number	d x L	☒	Art.number	d x L	☒	Art.number
BT 5X50	100	70520.050.050	BT 6X140	50	70520.060.140	BT 10X75	50	70520.100.075
BT 6X50	100	70520.060.050	BT 8X50	50	70520.080.050	BT 10X100	50	70520.100.100
BT 6X80	50	70520.060.080	BT 8X75	50	70520.080.075	BT 10X110	25	70520.100.110
BT 6X100	100	70520.060.100	BT 8X100	50	70520.080.100	BT 10X120	25	70520.100.120
BT 6X120	100	70520.060.120	BT 10X60	50	70520.100.060	BT 10X140	25	70520.100.140

70520 Concrete anchoring screw hexagon type BT ←

d x L	☒	Art.number	d x L	☒	Art.number	d x L	☒	Art.number
BT 10X160	20	70520.100.160	BT 12X100	25	70520.120.100	BT 16X200	10	70520.160.200
BT 10X200	20	70520.100.200	BT 12X150	20	70520.120.150	BT 16X240	10	70520.160.240
BT 10X240	20	70520.100.240	BT 12X200	20	70520.120.200	BT 16X280	10	70520.160.280
BT 10X280	20	70520.100.280	BT 16X100	20	70520.160.100	BT 16X320	10	70520.160.320
BT 12X75	25	70520.120.075	BT 16X150	10	70520.160.150			

• ETA1=BT10/BT12/BT16

Concrete anchoring screw A4 hexagon type BT

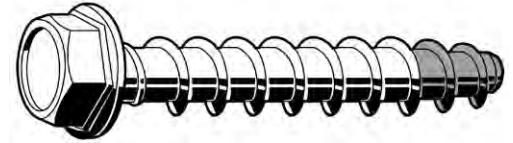
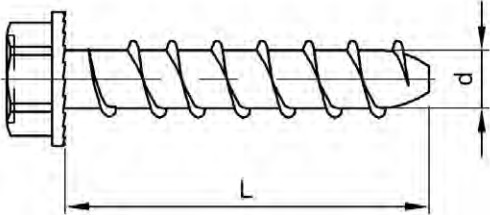

Technical Data

Type	d	L	N _{rec}	s	t _{fix}
BT645	6	45	1.7	10	1
BT660	6	60	2	10	5
BT875	8	75	2.3	13	10
BT895	8	95	2.3	13	30
BT1085	10	85	4.1	17	5
BT10100	10	100	4.1	17	20

- d = Nominal diameter of drill bit.
- N_{rec} = Recommended load in kN for Non-cracked concrete.
- s = Width across flats.
- t_{fix} = Grip range.

70521 Concrete anchoring screw A4 hexagon type BT P05A

Material: Stainless steel A4



d x L	☒	Art.number	d x L	☒	Art.number	d x L	☒	Art.number
6X45MM	100	70521.060.045	8/10X75MM	50	70521.080.075	10/5X85MM	50	70521.100.085
6/5X60MM	100	70521.060.060	8/30X95MM	50	70521.080.095	10/20X100MM	50	70521.100.100

Concrete anchoring screw round head type BT

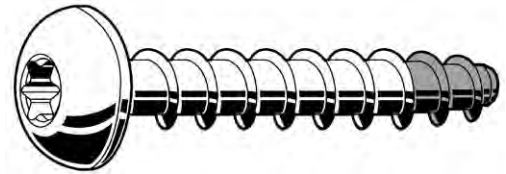
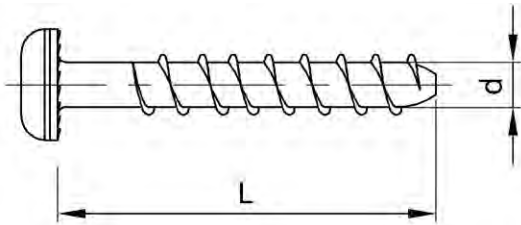

Technical Data

Type	L	No. Torx®	N _{rec}	t _{fix}
BT645	45	40	1.5	10
BT650	50	40	1.5	15

- d = Nominal diameter of drill bit.
- N_{rec} = Recommended load in kN.
- t_{fix} = Grip range.

70522 Concrete anchoring screw round head type BT

P05A

Material Steel
Surface treatment Zinc plated



d x L	Art.number	d x L	Art.number
6X45MM	100 70522.060.045	6X50MM	100 70522.060.050

Concrete anchoring screw mushroom head type BT

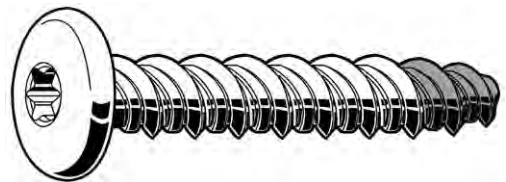
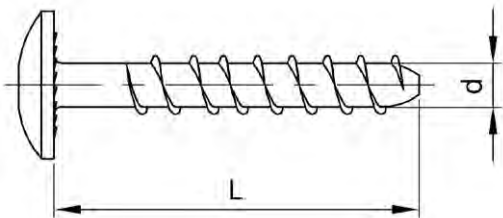

Technical Data

Type	d	L	No. Torx®	N _{rec}	t _{fix}
BT640	6	40	30	1.2	10
BT650	6	50	30	1.5	15
BT665	6	65	30	1.9	20

- N_{rec} = Recommended load in kN for Non-cracked concrete
- t_{fix} = Grip range

70523 Concrete anchoring screw mushroom head type BT

P05A

Material Steel
Surface treatment Zinc plated



d x L	Art.number	d x L	Art.number	d x L	Art.number
6X40MM	100 70523.060.040	6X50MM	100 70523.060.050	6X65MM	100 70523.060.065

Concrete anchoring screw countersunk type BT

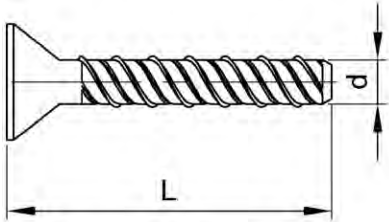

Technical Data

Type	d	L	N _{rec}	s	Socket	t _{fix}
BT650	6	50	1.5	-	T40	15
BT675	6	75	1.5	-	T40	40
BT850	8	50	1.9	-	T40	5
BT875	8	75	3.3	6	-	10
BT8100	8	100	3.3	6	-	35
BT1060	10	60	2.6	6	-	5
BT1075	10	75	2.6	8	-	20
BT10100	10	100	2.6/4.1	8	-	45/25
BT1275	12	75	4.1	10	-	5
BT12100	12	100	4.1/5.4	10	-	30/15
BT12150	12	150	4.1/5.4	10	-	80/65

- d = Nominal diameter of drill bit.
- N_{rec} = Recommended load in kN for Non-cracked concrete.
- s = Width across flats.
- t_{fix} = Grip range.

70524 Concrete anchoring screw countersunk type BT

P05A

Material Steel
Surface treatment Zinc plated

Powers
FASTENING INNOVATIONS



Final calculations should comply with the complete European Technical Approval (ETA), this approval is also available on request.

d x L	☒	Art.number	d x L	☒	Art.number	d x L	☒	Art.number
6X50MM	100	70524.060.050	8X100MM	50	70524.080.100	12X75MM	25	70524.120.075
6X75MM	50	70524.060.075	10X60MM	50	70524.100.060	12X100MM	25	70524.120.100
8X50MM	50	70524.080.050	10X75MM	50	70524.100.075	12X150MM	20	70524.120.150
8X75MM	50	70524.080.075	10X100MM	50	70524.100.100			

- ETA1=BT10/BT12

Anchor bolt ThruFast - ThruMaxx

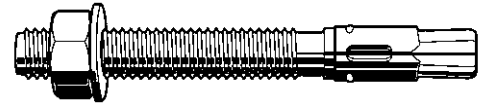
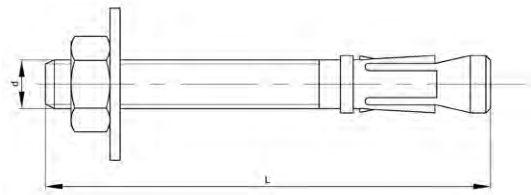

Technical Data

Type	C _{cr} N	d	d _f	d _o	h (nom.)	h ₁	h _{ef}	L	N _{rec}	Ring ø	s	S _{cr} N	t _{fix} (max.)	T _{inst}
6x60	60	M6	7	6	49.5	55	40	60	4.29	12	10	120	2	7
6x70	60	M6	7	6	49.5	55	40	70	3.93	12	10	120	12	7
6x80	60	M6	7	6	49.5	55	40	80	3.93	12	10	120	22	7
6x80 (A2-A4)	60	M6	7	6	49.5	55	40	80	4.29	12	10	120	22	7
6x90	60	M6	7	6	49.5	55	40	90	3.93	12	10	120	32	7
6x100	60	M6	7	6	49.5	55	40	100	3.93	12	10	120	42	7
6x120	60	M6	7	6	49.5	55	40	120	3.93	12	10	120	62	7
6x140	60	M6	7	6	49.5	55	40	140	3.93	12	10	120	82	7
8x75	72	M8	9	8	59.5	65	48	75	5.71	16	13	144	5	20
8x90	72	M8	9	8	59.5	65	48	90	5.71	16	13	144	20	20
8x115	72	M8	9	8	59.5	65	48	115	5.71	16	13	144	45	20
8x130	72	M8	9	8	59.5	65	48	130	5.71	16	13	144	60	20
8x155	72	M8	9	8	59.5	65	48	155	5.71	16	13	144	85	20
10x70	83	M10	12	10	53.5	60	42	70	5.43	20	17	165	5	35
10x90	83	M10	12	10	66.5	75	55	90	6.35	20	17	165	10	35
10x120	83	M10	12	10	66.5	75	55	120	6.35	20	17	165	40	35
10x150	83	M10	12	10	66.5	75	55	150	6.35	20	17	165	70	35
10x170	83	M10	12	10	66.5	75	55	170	6.35	20	17	165	90	35
12x75	98	M12	14	12	55	60	43	75	5.64	24	19	195	5	60
12x90	98	M12	14	12	77	85	65	90	8.84	24	19	195	5	60
12x110	98	M12	14	12	77	85	65	110	9.92	24	19	195	18	60
12x140	98	M12	14	12	77	85	65	140	9.92	24	19	195	48	60
12x160	98	M12	14	12	77	85	65	160	9.92	24	19	195	68	60
12x180	98	M12	14	12	77	85	65	180	9.92	24	19	195	88	60
14x120	113	M14	16	14	91	100	75	120	11.91	28	22	225	12	90
14x145	113	M14	16	14	91	100	75	145	11.91	28	22	225	37	90
14x170	113	M14	16	14	91	100	75	170	11.91	28	22	225	62	90
16x90	126	M16	18	16	69	75	49	90	6.86	30	24	252	4	120
16x125	126	M16	18	16	103.5	110	84	125	13.89	30	24	252	3	120
16x145	126	M16	18	16	103.5	110	84	145	13.89	30	24	252	23	120
16x170	126	M16	18	16	103.5	110	84	170	13.89	30	24	252	48	120
16x220	126	M16	18	16	103.5	110	84	220	13.89	30	24	252	98	120
20x120	155	M20	22	20	93	105	71	120	11.96	37	30	309	5	240
20x170	155	M20	22	20	125	135	103	170	19.84	37	30	309	23	240
20x220	155	M20	22	20	125	135	103	220	19.84	37	30	309	73	240

- d = Nominal diameter of drill bit
- s = Width across flats
- ring ø = Washer diameter
- d_f = Diameter of clearance hole in the fixture
- h₁ = Recommended drilling depth
- h(nom) = Minimum hole depth
- h_{ef} = Effective anchorage depth
- S_{cr} N = Spacing characteristic
- C_{cr} N = Edge distance characteristic
- t_{fix} (max) = Grip range
- T_{inst} = Tightening torque in Nm
- N_{rec} = Recommended load in kN
- The allowable load is valid for one single anchor, at non-cracked concrete (pressure zone) with concrete class C20/25, incl. partial safety factor γ_f = 1,4 and if the S_{cr} N and C_{cr} N are taken in to account.

Assembly sequence



Article groups

Thread	Material	Surface treatment	Code	Page
M	St	Zipl	30550	8-66
M	St.St. A2		30552	8-66
M	St	Zipl	ETA-7 30551	8-66
M	St.St. A4		ETA-7 30553	8-67

30550 MAXXFAST Anchor bolt ThruFast MF50

Thread	Metric thread	
Material	Steel	
Surface treatment	Zinc plated	

Type	☒	Art.number	Type	☒	Art.number	Type	☒	Art.number
6X70	200	30550.060.070	8X155	50	30550.080.155	12X180	25	30550.120.180
6X80	200	30550.060.080	10X70	100	30550.100.070	14X120	25	30550.140.120
6X90	200	30550.060.090	10X90	100	30550.100.090	14X145	25	30550.140.145
6X100	200	30550.060.100	10X120	50	30550.100.120	14X170	20	30550.140.170
6X120	100	30550.060.120	10X150	50	30550.100.150	16X125	25	30550.160.125
6X140	100	30550.060.140	12X75	50	30550.120.075	16X145	25	30550.160.145
8X75	100	30550.080.075	12X110	50	30550.120.110	16X170	10	30550.160.170
8X90	100	30550.080.090	12X140	25	30550.120.140	16X220	10	30550.160.220
8X115	100	30550.080.115	12X160	25	30550.120.160	20X170	10	30550.200.170
8X130	100	30550.080.130						

• Full boxes only.

30552 MAXXFAST Anchor bolt ThruFast MF50

Thread	Metric thread	
Material	Stainless steel A2	

Type	☒	Art.number	Type	☒	Art.number	Type	☒	Art.number
6X60	200	30552.060.060	10X120	50	30552.100.120	16X145	25	30552.160.145
6X80	200	30552.060.080	10X150	50	30552.100.150	16X170	10	30552.160.170
6X75	100	30552.080.075	12X90	50	30552.120.090	20X120	10	30552.200.120
8X90	100	30552.080.090	12X110	50	30552.120.110	20X170	10	30552.200.170
8X115	100	30552.080.115	12X140	25	30552.120.140	20X220	10	30552.200.220
10X90	100	30552.100.090	16X90	25	30552.160.090			

• Full boxes only.

30551 MAXXFAST Anchor bolt ThruMaxx MF50

Thread	Metric thread	
Material	Steel	
Surface treatment	Zinc plated	



Final calculations should comply with the complete European Technical Approval (ETA), this approval is also available on request.

Type	☒	Art.number	Type	☒	Art.number	Type	☒	Art.number
6X70	200	30551.060.070	8X130	100	30551.080.130	12X180	25	30551.120.180
6X80	200	30551.060.080	8X155	50	30551.080.155	14X120	25	30551.140.120
6X90	200	30551.060.090	10X90	100	30551.100.090	14X145	25	30551.140.145
6X100	200	30551.060.100	10X120	50	30551.100.120	14X170	20	30551.140.170
6X120	100	30551.060.120	10X150	50	30551.100.150	16X125	25	30551.160.125
6X140	100	30551.060.140	10X170	50	30551.100.170	16X145	25	30551.160.145
8X75	100	30551.080.075	12X110	50	30551.120.110	16X170	10	30551.160.170
8X90	100	30551.080.090	12X140	25	30551.120.140	20X170	10	30551.200.170
8X115	100	30551.080.115	12X160	25	30551.120.160			

30551 MAXXFAST Anchor bolt ThruMaxx

- Full boxes only.

30553 MAXXFAST Anchor bolt ThruMaxx
MF50

Thread Metric thread
Material Stainless steel A4

MAXXFAST
 PROFESSIONAL HARDWARE

Final calculations should comply with the complete European Technical Approval (ETA), this approval is also available on request.

Type	☒	Art.number	Type	☒	Art.number	Type	☒	Art.number
6X60	200	30553.060.060	10X90	100	30553.100.090	12X140	25	30553.120.140
6X80	200	30553.060.080	10X120	50	30553.100.120	16X145	25	30553.160.145
8X75	100	30553.080.075	10X150	50	30553.100.150	16X170	10	30553.160.170
8X90	100	30553.080.090	12X90	50	30553.120.090	20X170	10	30553.200.170
8X115	100	30553.080.115	12X110	50	30553.120.110	20X220	10	30553.200.220

- Full boxes only.

Ancher bolt EXA

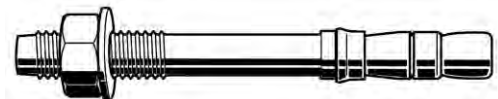
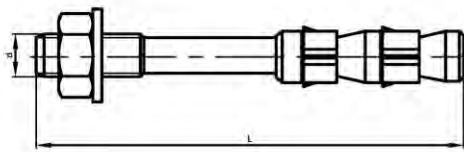

Technical Data

d	d	d _o	h _{ef}	k _N	L	Min. t _d	s	t _{fix}
8/5	M8	8	47	4.1	60	60	13	5
8/15	M8	8	47	4.1	65	60	13	15
10/5	M10	10	49	6.3	70	65	17	5
10/15	M10	10	49	6.3	92	65	17	15
10/45	M10	10	49	6.3	122	65	17	45
12/5	M12	12	67	9.9	80	85	19	5
12/15	M12	12	67	9.9	116	85	19	15
12/55	M12	12	67	9.9	156	85	19	55
16/10	M16	16	85	16.7	110	110	24	10
16/30	M16	16	85	16.7	153	110	24	30

- **d** = Nominal diameter of drill bit.
- **Min. t_d** = Advised drilling depth.
- **h_{ef}** = Effective anchorage depth.
- **s** = Grip range.
- **k_N** = Recommended load in kN.
- The allowable load is valid for 1 separate anchor, for cracked concrete (tensile zone) in the class C20/25, incl. partial safety factor γ_f = 1,4 and when the Scr, N and Ccr, N are not exceeded.
- For the final calculations, it is mandatory to take into account the entire European Technical Approval (ETA), which is available on request.

Assembly sequence

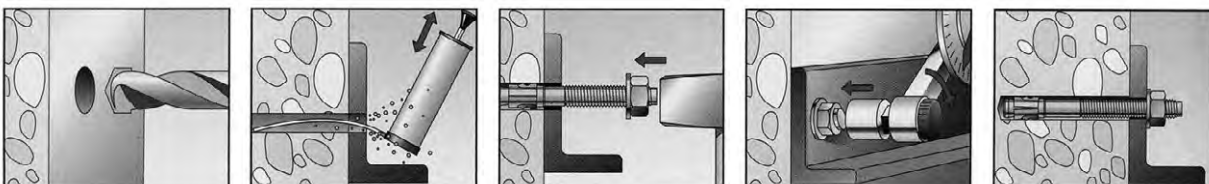

Material Steel
Surface treatment Zinc plated

fischer
innovative solutions



Type	☒	Art.number	Type	☒	Art.number	Type	☒	Art.number
8/5 (8X60)	50	63328.008.005	10/45 (10X122)	50	63328.010.045	12/55 (12X156)	25	63328.012.055
8/15 (8X65)	50	63328.008.015	12/5 (12X80)	25	63328.012.005	16/10 (16X110)	20	63328.016.010
10/5 (10X70)	50	63328.010.005	12/15 (12X116)	25	63328.012.015	16/30 (16X153)	10	63328.016.030
10/15 (10X92)	50	63328.010.015						

Bolt type FBN II

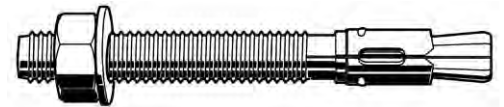
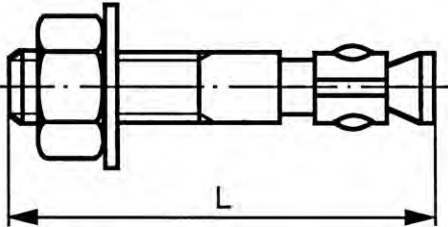

Technical Data

Type	d	d _o	h _{ef}	k _N	L	Min. t _d	Ring ø	t _{fix}
FBN II 6/5	M6	6	30	1.5	50	45	12X1.6	5
FBN II 6/10	M6	6	30	1.5	55	50	12X1.6	10
FBN II 6/30	M6	6	30	1.5	75	70	12X1.6	30
FBN II 8/5	M8	8	40	2.9-6.1	66	61	16X1.6	5
FBN II 8/10	M8	8	40	2.9-6.1	71	66	16X1.6	10
FBN II 8/20	M8	8	40	2.9-6.1	81	76	16X1.6	20
FBN II 8/30	M8	8	40	2.9-6.1	91	86	16X1.6	30
FBN II 8/50	M8	8	40	2.9-6.1	111	106	16X1.6	50
FBN II 8/70	M8	8	40	2.9-6.1	131	126	16X1.6	70
FBN II 8/100	M8	8	40	2.9-6.1	161	156	16X1.6	100
FBN II 8/5 K	M8	8	30	2.9-6.1	56	51	16X1.6	5
FBN II 8/10 K	M8	8	30	2.9-6.1	61	56	16X1.6	10
FBN II 8/30 K	M8	8	30	2.9-6.1	81	76	16X1.6	30
FBN II 10/10	M10	10	50	6.1-8.5	86	78	20X2	10
FBN II 10/20	M10	10	50	6.1-8.5	96	88	20X2	20
FBN II 10/30	M10	10	50	6.1-8.5	106	98	20X2	30
FBN II 10/50	M10	10	50	6.1-8.5	126	118	20X2	50
FBN II 10/70	M10	10	50	6.1-8.5	146	138	20X2	70
FBN II 10/100	M10	10	50	6.1-8.5	176	168	20X2	100
FBN II 10/140	M10	10	50	6.1-8.5	216	208	20X2	140
FBN II 10/160	M10	10	50	6.1-8.5	236	228	20X2	160
FBN II 10/5 K	M10	10	40	6.1-8.5	71	63	20X2	5
FBN II 10/10 K	M10	10	40	6.1-8.5	76	68	20X2	10
FBN II 10/30 K	M10	10	40	6.1-8.5	96	88	20X2	30
FBN II 12/10	M12	12	65	8.5-12.6	106	95	24X2.5	10
FBN II 12/20	M12	12	65	8.5-12.6	116	105	24X2.5	20
FBN II 12/30	M12	12	65	8.5-12.6	126	115	24X2.5	30
FBN II 12/50	M12	12	65	8.5-12.6	146	135	24X2.5	50
FBN II 12/80	M12	12	65	8.5-12.6	176	165	24X2.5	80
FBN II 12/100	M12	12	65	8.5-12.6	196	185	24X2.5	100
FBN II 12/120	M12	12	65	8.5-12.6	216	205	24X2.5	120
FBN II 12/140	M12	12	65	8.5-12.6	236	225	24X2.5	140
FBN II 12/160	M12	12	65	8.5-12.6	256	245	24X2.5	160
FBN II 12/5 K	M12	12	50	8.5-12.6	86	75	24X2.5	5
FBN II 12/10 K	M12	12	50	8.5-12.6	91	80	24X2.5	10
FBN II 12/30 K	M12	12	50	8.5-12.6	111	100	24X2.5	30
FBN II 16/10	M16	16	80	12.6-17.2	130	114	30X3	10
FBN II 16/25	M16	16	80	12.6-17.2	145	129	30X3	25
FBN II 16/50	M16	16	80	12.6-17.2	170	154	30X3	50
FBN II 16/80	M16	16	80	12.6-17.2	200	184	30X3	80
FBN II 16/100	M16	16	80	12.6-17.2	220	204	30X3	100
FBN II 16/140	M16	16	80	12.6-17.2	260	244	30X3	140
FBN II 16/160	M16	16	80	12.6-17.2	280	264	30X3	160
FBN II 16/200	M16	16	80	12.6-17.2	320	304	30X3	200

Technical Data								
Type	d	d _o	h _{ef}	k _N	L	Min. t _d	Ring ø	t _{fix}
FBN II 16/15 K	M16	16	65	12.6-17.2	120	104	30X3	15
FBN II 16/25 K	M16	16	65	12.6-17.2	130	114	30X3	25
FBN II 20/30	M20	20	105	17.2-25.8	184	165	37X3	30
FBN II 20/60	M20	20	105	17.2-25.8	214	195	37X3	60
FBN II 20/80	M20	20	105	17.2-25.8	234	215	37X3	80
FBN II 20/120	M20	20	105	17.2-25.8	274	255	37X3	120
FBN II 20/10 K	M20	20	80	17.2-25.8	139	120	37X3	10

- d_n = Nominal diameter of drill bit.
- t_o = Grip range.
- h_{ef} = Effective anchorage depth.
- Min. t_d = Recommended drilling depth.
- k_N = Load in kN.
- The allowable load is valid for one single anchor, at cracked concrete (tensile zone) with concrete class C20/25, incl. partial safety factor γ_r = 1,4 and if the S_{cr} N and C_{cr} N are taken in to account.
- When reduction on spacing and edge distance take place a re-calculation of forces should be carried out by making use of the technical guide or calculation software, they are available on request.
- Final calculations should comply with the complete European Technical Approval (ETA), this approval is also available on request.

Assembly sequence

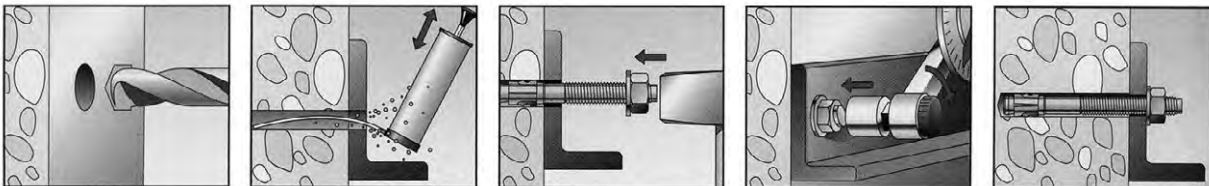

Article groups				
Thread	Material	Surface treatment	Code	Page
M	St	Zipl	63324	8-69
M	St.St. A4		63325	8-70

63324 FISCHER Bolt type FBN II		N03A
Thread	Metric thread	
Material	Steel	
Surface treatment	Zinc plated	



Final calculations should comply with the complete European Technical Approval (ETA), this approval is also available on request.

Type	☒	Art.number	Type	☒	Art.number	Type	☒	Art.number
6/5 (6x50)	100	63324.060.005	10/70 (10X146)	20	63324.100.070	12/10 K (12X91)	20	63324.121.010
6/10 (6x55)	100	63324.060.010	10/100 (10X176)	20	63324.100.100	12/30 K (12X111)	20	63324.121.030
6/30 (6x75)	100	63324.060.030	10/140 (10X216)	20	63324.100.140	16/25 (16X145)	10	63324.160.025
8/5 (8X66)	50	63324.080.005	10/160 (10X236)	20	63324.100.160	16/50 (16X170)	10	63324.160.050
8/10 (8X71)	50	63324.080.010	10/5 K (10X71)	50	63324.101.005	16/80 (16X200)	10	63324.160.080
8/20 (8X81)	50	63324.080.020	10/10 K (10X76)	50	63324.101.010	16/100 (16X220)	10	63324.160.100
8/30 (8X91)	50	63324.080.030	12/10 (12X106)	20	63324.120.010	16/140 (16X260)	10	63324.160.140
8/50 (8X111)	50	63324.080.050	12/20 (12X116)	20	63324.120.020	16/160 (16X280)	10	63324.160.160
8/70 (8X131)	20	63324.080.070	12/30 (12X126)	20	63324.120.030	16/200 (16X320)	10	63324.160.200
8/100 (8X161)	20	63324.080.100	12/50 (12X146)	20	63324.120.050	16/15 K (16X120)	10	63324.161.015
8/5 K (8X56)	50	63324.081.005	12/80 (12X176)	20	63324.120.080	16/25 K (16X130)	10	63324.161.025
8/10 K (8X61)	50	63324.081.010	12/100 (12X196)	20	63324.120.100	20/30 (20X184)	10	63324.200.030
10/10 (10X86)	50	63324.100.010	12/120 (12X216)	20	63324.120.120	20/60 (20X214)	10	63324.200.060
10/20 (10X96)	50	63324.100.020	12/140 (12X236)	20	63324.120.140	20/80 (20X234)	10	63324.200.080
10/30 (10X106)	50	63324.100.030	12/160 (12X256)	20	63324.120.160	20/120 (20X274)	10	63324.200.120
10/50 (10X126)	20	63324.100.050	12/5 K (12X86)	20	63324.121.005	20/10 K (20X139)	10	63324.201.010

63325	FISCHER Bolt type FBN II	N03A
Thread	Metric thread	
Material	Stainless steel A4	



Final calculations should comply with the complete European Technical Approval (ETA), this approval is also available on request.

Type	☒	Art.number	Type	☒	Art.number	Type	☒	Art.number
6/10 (6X55)	100	63325.060.010	10/30 (10X106)	50	63325.100.030	12/100 (12X196)	20	63325.120.100
6/30 (6X75)	100	63325.060.030	10/50 (10X126)	20	63325.100.050	16/10 (16X130)	10	63325.160.010
8/10 (8X71)	50	63325.080.010	10/100 (10X176)	20	63325.100.100	16/25 (16X145)	10	63325.160.025
8/30 (8X91)	50	63325.080.030	12/20 (12X116)	20	63325.120.020	16/50 (16X170)	10	63325.160.050
8/50 (8X111)	50	63325.080.050	12/30 (12X126)	20	63325.120.030			
10/20 (10X96)	50	63325.100.020	12/50 (12X146)	20	63325.120.050			

Through bolt anchor

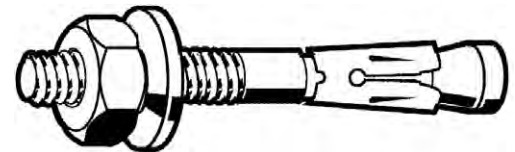
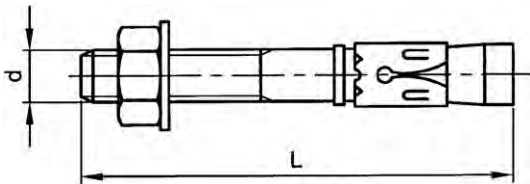

Technical Data

Type	C _{cr} N	C _{min.}	Code	d	d _f	d _o	h _{ef}	h _{min}	h _o	L	N	S _{cr} N	S _{min.}	t _{fix}	T _{inst}
8-20	72-55	60-55	C	M8	9	8	48-35	100	65-52	70	3.0-2.0	144-155	50-45	7-20	15
8-40	72-55	60-55	E	M8	9	8	48-35	100	65-52	90	3.0-2.0	144-105	50-45	27-40	15
8-80	72-55	60-55	H	M8	9	8	48-35	100	65-52	130	3.0-2.0	144-105	50-45	67-80	15
10-15	78-75	75-65	C	M10	12	10	52-42	104-100	72-62	76.2	4.0-3.0	156-125	65-55	5-15	30
10-35	78-75	75-65	E	M10	12	10	52-42	104-100	72-62	96.2	4.0-3.0	156-126	65-55	25-35	30
10-80	78-75	75-65	I	M10	12	10	52-42	104-100	72-62	141.2	4.0-3.0	156-126	65-55	70-80	30
12-25	102-100	100-90	E	M12	14	12	68-50	136-100	93-75	100	6.6-5.3	204-150	100-75	8-25	50
12-65	102-100	100-90	I	M12	14	12	68-50	136-100	93-75	140	6.6-5.3	204-105	100-75	48-65	50
12-105	102-100	100-90	L	M12	14	12	68-50	136-100	93-75	180	6.6-5.3	204-150	100-75	88-105	50
12-145	102-100	100-90	O	M12	14	12	68-50	136-100	93-75	220	6.6-5.3	204-150	100-75	128-145	50
16-30	129-100	100-105	G	M16	18	16	86-64	172-128	117-95	125	13.2-8.3	258-192	100-90	8-30	100
16-75	129-100	100-105	K	M16	18	16	86-64	172-128	117-95	170	13.2-8.3	258-192	100-90	53-75	100
20-50	150-115	115-125	J	M20	22	20	100-74	200-148	136-110	160	9.9-9.9	300-222	100-105	25-50	160
20-105	150-115	115-125	J	M20	22	20	100-74	200-148	136-110	215	9.9-9.9	300-222	100-105	80-105	160

- Code = Letter code marking.
- d = Nominal diameter of drill bit.
- T_{inst} = Tightening torque in Nm.
- d_f = Diameter of clearance hole in the fixture.
- h_{min} = Minimal thickness of concrete member.
- h_o = Recommended drilling depth
- t_{fix} = Thickness of the fixture.
- h_{ef} = Effective anchorage depth.
- S_{cr} N = Spacing characteristic.
- C_{cr} N = Edge distance characteristic.
- S_{min.} = Minimal spacing.
- C_{min.} = Minimal edge distance.
- N = Allowable load in kN.
- The allowable load is valid for one single anchor, at non-cracked concrete (pressure zone) with concrete class C20/25, incl. partial safety factor γ_f = 1,4 and if the S_{cr} N and C_{cr} N are taken in to account.
- When reduction on spacing and edge distance take place a re-calculation of forces should be carried out by making use of the technical guide or calculation software, they are available on request.
- Final calculations should comply with the complete European Technical Approval (ETA), this approval is also available on request.

Assembly sequence

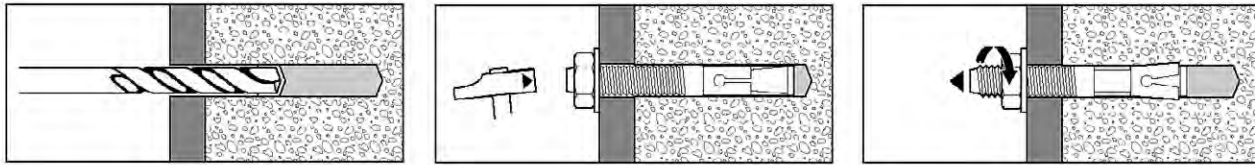

70927 Spit FIX 3 through bolt anchor

P03A

Material Steel
Surface treatment Zinc plated

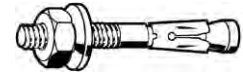

Type	☒	Art.number	Type	☒	Art.number	Type	☒	Art.number
M8X20	100	70927.080.020	M12X25	25	70927.120.025	M16X30	20	70927.160.030
M8X40	50	70927.080.040	M12X65	25	70927.120.065	M16X75	10	70927.160.075
M10X15	50	70927.100.015	M12X105	25	70927.120.105	M20X50	10	70927.200.050
M10X35	50	70927.100.035	M12X145	20	70927.120.145	M20X105	10	70927.200.105
M10X80	25	70927.100.080						

Through bolt anchor

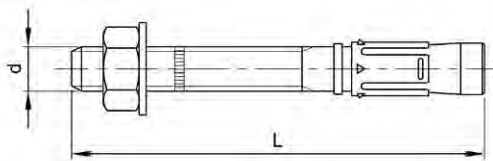

Technical Data

d x L	C _{cr} N	C _{min.}	Code	d _f	d _o	h (nom.)	h ₁	h _{ef}	N _{rec}	Ring ø	s	S _{cr} N	S _{min.}	t _{fix} (max.)	T _{inst}
M8x75	72	75	C	9	8	55	60	48	3.57	16	13	144	75	9	20
M8x95	72	75	E	9	8	55	60	48	3.57	16	13	144	75	29	20
M8x115	72	75	G	9	8	55	60	48	3.57	16	13	144	75	49	20
M10x90	90	90	E	12	10	68	75	60	4.76	20	17	150	90	10	40
M10x105	90	90	F	12	10	68	75	60	4.76	20	17	150	90	25	40
M10x115	90	90	G	12	10	68	75	60	4.76	20	17	150	90	35	40
M10x135	90	90	H	12	10	68	75	60	4.76	20	17	150	90	55	40
M10x165	90	90	J	12	10	68	75	60	4.76	20	17	150	90	85	40
M10x185	90	90	L	12	10	68	75	60	4.76	20	17	150	90	105	40
M12x110	105	105	F	14	12	80	85	70	6.35	24	19	175	105	14	60
M12x120	105	105	G	14	12	80	85	70	6.35	24	19	175	105	24	60
M12x130	105	105	H	14	12	80	85	70	6.35	24	19	175	105	34	60
M12x150	105	105	I	14	12	80	85	70	6.35	24	19	175	105	54	60
M12x180	105	105	L	14	12	80	85	70	6.35	24	19	175	105	84	60
M12x200	105	105	M	14	12	80	85	70	6.35	24	19	175	105	104	60
M16x145	128	130	I	18	16	97	105	85	13.89	30	24	213	130	28	100
M16x175	128	130	K	18	16	97	105	85	13.89	30	24	213	130	58	100
M16x220	128	130	O	18	16	97	105	85	13.89	30	24	213	130	103	100
M16x250	128	130	Q	18	16	97	105	85	13.89	30	24	213	130	133	100
M20x170	150	150	K	22	20	114	125	100	15.87	37	30	250	150	32	200
M20x200	150	150	O	22	20	114	125	100	15.87	37	30	250	150	82	200

- Code = Letter code marking
- d_o = Nominal diameter of drill bit
- d_c = Diameter of clearance hole in the fixture
- h_d = Depth of drilled hole to deepest point
- h_{nom} = Minimum hole depth
- h_{ef} = Effective anchorage depth
- $t_{gr}(max)$ = Grip range
- s = Width across flats
- ring ϕ = Washer diameter
- $S_{cr,N}$ = Spacing characteristic
- $C_{cr,N}$ = Edge distance characteristic
- S_{min} = Minimal spacing
- C_{min} = Minimal edge distance
- N_{rec} = Recommended load in kN
- T_{inst} = Tightening torque in Nm
- The allowable load (N_{rec}) is valid for one single anchor, at non-cracked concrete (pressure zone) with concrete class C20/25, incl. partial safety factor $\gamma_f = 1,4$ and if the $S_{cr,N}$ and $C_{cr,N}$ are taken in to account.
- When reduction on spacing and edge distance take place a re-calculation of forces should be carried out by making use of the technical guide, they are available on request.
- Final calculations should comply with the complete European Technical Approval (ETA), this approval is also available on request.



Final calculations should comply with the complete European Technical Approval (ETA), this approval is also available on request.

30554 MAXXFAST Through bolt anchor Promaxx		MF4A
Thread	Metric thread	
Material	Steel	
Surface treatment	Zinc plated	

d x L	☒	Art.number	d x L	☒	Art.number	d x L	☒	Art.number
M8X75	50	30554.080.075	M10X165	25	30554.100.165	M12X200	25	30554.120.200
M8X95	50	30554.080.095	M10X185	25	30554.100.185	M16X145	10	30554.160.145
M8X115	50	30554.080.115	M12X110	25	30554.120.110	M16X175	10	30554.160.175
M10X90	50	30554.100.090	M12X120	25	30554.120.120	M16X220	10	30554.160.220
M10X105	25	30554.100.105	M12X130	25	30554.120.130	M16X250	10	30554.160.250
M10X115	25	30554.100.115	M12X150	25	30554.120.150	M20X170	10	30554.200.170
M10X135	25	30554.100.135	M12X180	25	30554.120.180	M20X200	10	30554.200.200

Anchor bolt

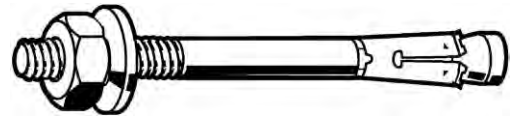
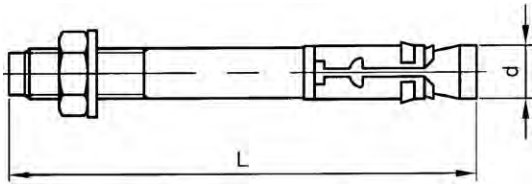

Technical Data

Type	d	d _o	h _{ef}	k _N	L	Min. t _d	Ring ø	s	t _{fix}
FAZ II 8/10	M8	8	45	2.4	77	75	16X1.6	13	10
FAZ II 8/30	M8	8	45	2.4	97	95	16X1.6	13	30
FAZ II 8/50	M8	8	45	2.4	117	115	16X1.6	13	50
FAZ II 8/100	M8	8	45	2.4	167	165	16X1.6	13	100
FAZ II 8/150	M8	8	45	2.4	217	215	16X1.6	13	150
FAZ II 10/10	M10	10	60	4.3	95	90	20X2	17	10
FAZ II 10/20	M10	10	60	4.3	105	100	20X2	17	20
FAZ II 10/30	M10	10	60	4.3	115	110	20X2	17	30
FAZ II 10/50	M10	10	60	4.3	135	130	20X2	17	50
FAZ II 10/80	M10	10	60	4.3	165	160	20X2	17	80
FAZ II 10/100	M10	10	60	4.3	185	180	20X2	17	100
FAZ II 10/150	M10	10	60	4.3	235	230	20X2	17	150
FAZ II 12/10	M12	12	70	7.6	110	105	24X2.5	19	10
FAZ II 12/20	M12	12	70	7.6	120	115	24X2.5	19	20
FAZ II 12/30	M12	12	70	7.6	130	125	24X2.5	19	30
FAZ II 12/50	M12	12	70	7.6	180	145	24X2.5	19	50
FAZ II 12/80	M12	12	70	7.6	180	175	24X2.5	19	80
FAZ II 12/100	M12	12	70	7.6	200	195	24X2.5	19	100
FAZ II 12/150	M12	12	70	7.6	250	245	24X2.5	19	150
FAZ II 12/200	M12	12	70	7.6	300	295	24X2.5	19	200
FAZ II 16/25	M16	16	85	13.4	150	140	30X3	24	25
FAZ II 16/50	M16	16	85	13.4	175	165	30X3	24	50
FAZ II 16/100	M16	16	85	13.4	225	215	30X3	24	100
FAZ II 16/150	M16	16	85	13.4	275	265	30X3	24	150
FAZ II 16/200	M16	16	85	13.4	325	315	30X3	24	200
FAZ II 16/250	M16	16	85	13.4	375	365	30X3	24	250
FAZ II 16/300	M16	16	85	13.4	425	415	30X3	24	300
FAZ II 20/30	M20	20	100	17.1	170	155	37X3	30	30
FAZ II 20/60	M20	20	100	17.1	200	185	37X3	30	60
FAZ II 20/150	M20	20	100	17.1	290	275	37X3	30	150
FAZ II 24/30	M24	24	125	24.0	204	185	44X4	36	30
FAZ II 24/60	M24	24	125	24.0	234	215	44X4	36	60

- d_n = Nominal diameter of drill bit.
- Min. t_d = Recommended drilling depth.
- h_{ef} = Effective anchorage depth.
- t_{gr} = Grip range.
- s = Width across flats.
- k_N = Load in kN.
- The allowable load is valid for one single anchor, at cracked concrete (tensile zone) with concrete class C20/25, incl. partial safety factor $\gamma_F = 1.4$ and if the S_{cr}, N and C_{cr}, N are taken in to account.
- Final calculations should comply with the complete European Technical Approval (ETA), this approval is also available on request.

Assembly sequence

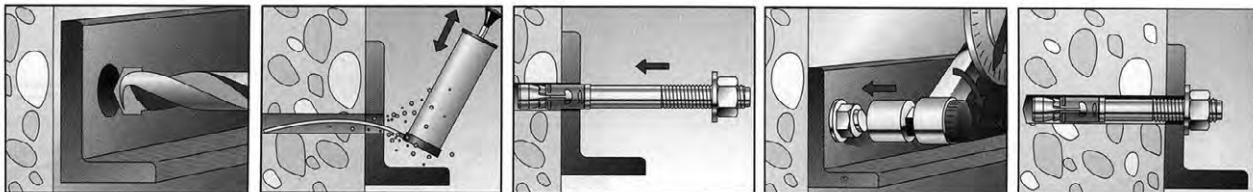

63323	FISCHER Anchor bolt type FAZ II	N03A
Thread	Metric thread	  
Material	Steel	
Surface treatment	Zinc plated	



Final calculations should comply with the complete European Technical Approval (ETA), this approval is also available on request.

Type	☒	Art.number	Type	☒	Art.number	Type	☒	Art.number
FAZII8/10	50	63323.080.010	FAZII10/100	20	63323.100.100	FAZII16/50	10	63323.160.050
FAZII8/30	50	63323.080.030	FAZII12/10	20	63323.120.010	FAZII16/100	10	63323.160.100
FAZII8/50	50	63323.080.050	FAZII12/20	20	63323.120.020	FAZII16/200	10	63323.160.200
FAZII8/100	25	63323.080.100	FAZII12/30	20	63323.120.030	FAZII16/250	10	63323.160.250
FAZII10/10	50	63323.100.010	FAZII12/50	20	63323.120.050	FAZII16/300	10	63323.160.300
FAZII10/20	25	63323.100.020	FAZII12/80	20	63323.120.080	FAZII20/30	5	63323.200.030
FAZII10/30	25	63323.100.030	FAZII12/100	20	63323.120.100	FAZII20/60	5	63323.200.060
FAZII10/50	20	63323.100.050	FAZII12/200	10	63323.120.200	FAZII24/30	5	63323.240.030
FAZII10/80	20	63323.100.080	FAZII16/25	10	63323.160.025	FAZII24/60	5	63323.240.060

High performance anchor type FH II-B

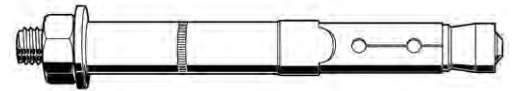
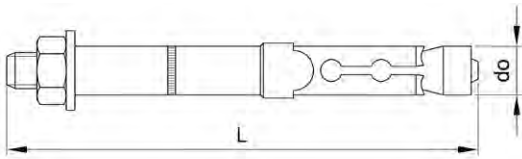

Technical Data

Type	d	d _o	h _{ef}	k _N	L	Min. t _d	Ring ø	s	t _{fix}
FH II 10/10 B	M6	10	50	2.0	85	80	18X1.6	10	10
FH II 10/25 B	M6	10	50	2.0	100	95	18X1.6	10	25
FH II 10/50 B	M6	10	50	2.0	125	120	18X1.6	10	50
FH II 12/10 B	M8	12	60	5.7	90	90	22X2.5	12	10
FH II 12/25 B	M8	12	60	5.7	105	105	22X2.5	13	25
FH II 12/50 B	M8	12	60	5.7	130	130	22X2.5	13	50
FH II 12/100 B	M8	12	60	5.7	184	190	22X2.5	13	100
FH II 15/10 B	M10	15	70	7.6	110	100	25X3	17	10
FH II 15/25 B	M10	15	70	7.6	125	115	25X3	17	25
FH II 15/50 B	M10	15	70	7.6	150	140	25X3	17	50
FH II 15/100 B	M10	15	70	7.6	200	190	25X3	17	100
FH II 18/25 B	M12	18	80	11.9	135	130	30X3	19	25
FH II 18/50 B	M12	18	80	11.9	160	155	30X3	19	50
FH II 18/100 B	M12	18	80	11.9	214	205	30X3	19	100
FH II 24/25 B	M16	24	100	17.1	167	150	40X5	24	25
FH II 24/50 B	M16	24	100	17.1	195	175	40X5	24	50
FH II 24/100 B	M16	24	100	17.1	242	225	40X5	24	100

- **d** = Nominal diameter of drill bit.
- **Min. t_d** = Recommended drilling depth.
- **h_{ef}** = Effective anchorage depth.
- **t_{fix}** = Grip range.
- **s** = Width across flats.
- **k_N** = Load in kN.
- The allowable load is valid for one single anchor, at cracked concrete (tensile zone) with concrete class C20/25, incl. partial safety factor $\gamma_f = 1,4$ and if the S_{cr} , N and C_{cr} , N are taken in to account.
- When reduction on spacing and edge distance take place a re-calculation of forces should be carried out by making use of the technical guide or calculation software, they are available on request.
- Final calculations should comply with the complete European Technical Approval (ETA), this approval is also available on request.

Assembly sequence

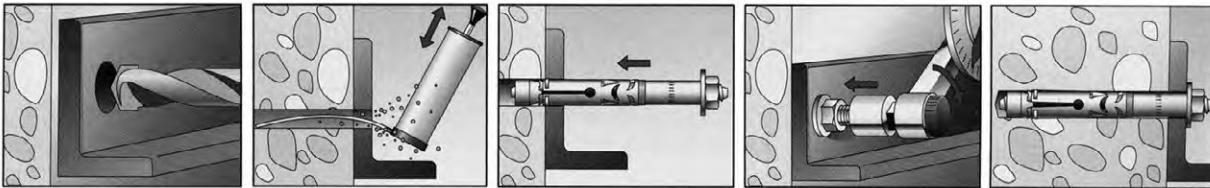

63421 FISCHER High performance anchor type FH II-B		N03A
Thread	Metric thread	
Material	Steel	
Surface treatment	Zinc plated	



Final calculations should comply with the complete European Technical Approval (ETA), this approval is also available on request.

Type	☒	Art.number	Type	☒	Art.number	Type	☒	Art.number
FH II 10/10 B	50	63421.100.011	FH II 12/100 B	25	63421.120.100	FH II 18/50 B	20	63421.180.050
FH II 10/25 B	50	63421.100.026	FH II 15/10 B	25	63421.150.010	FH II 18/100 B	10	63421.180.100
FH II 10/50 B	50	63421.100.051	FH II 15/25 B	25	63421.150.025	FH II 24/25 B	10	63421.240.025
FH II 12/10 B	50	63421.120.010	FH II 15/50 B	25	63421.150.050	FH II 24/50 B	10	63421.240.050
FH II 12/25 B	50	63421.120.025	FH II 15/100 B	20	63421.150.100	FH II 24/100 B	5	63421.240.100
FH II 12/50 B	25	63421.120.050	FH II 18/25 B	20	63421.180.025			

High performance anchor type FH II-S

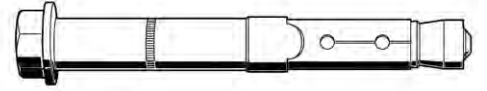
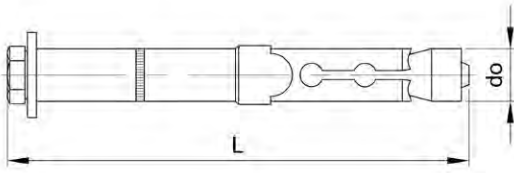

Technical Data

Type	d	d _o	h _{ef}	k _N	L	Min. t _d	Ring ø	s	t _{fix}
FH II 10/10 S	M6	10	50	2.0	84	85	18X1.6	10	10
FH II 10/25 S	M6	10	50	2.0	99	100	18X1.6	10	25
FH II 10/50 S	M6	10	50	2.0	124	125	18X1.6	10	50
FH II 12/10 S	M8	12	60	5.7	90	90	22X2.5	13	10
FH II 12/25 S	M8	12	60	5.7	105	105	22X2.5	13	25
FH II 12/50 S	M8	12	60	5.7	130	130	22X2.5	13	50
FH II 15/10 S	M10	15	70	7.6	106	100	25X3	17	10
FH II 15/25 S	M10	15	70	7.6	121	115	25X3	17	25
FH II 15/50 S	M10	15	70	7.6	146	140	25X3	17	50
FH II 18/10 S	M12	18	80	11.9	118	115	30X3	19	10
FH II 18/25 S	M12	18	80	11.9	132	130	30X3	19	25
FH II 18/50 S	M12	18	80	11.9	157	155	30X3	19	50
FH II 24/25 S	M16	24	100	17.1	160	150	40X5	24	25
FH II 24/50 S	M16	24	100	17.1	185	175	40X5	24	50

- d = Nominal diameter of drill bit.
- Min. t_d = Recommended drilling depth.
- h_{ef} = Effective anchorage depth.
- t_{fix} = Grip range.
- s = Width across flats.
- k_N = Load in kN.
- The allowable load is valid for one single anchor, at cracked concrete (tensile zone) with concrete class C20/25, incl. partial safety factor γ_r = 1,4 and if the S_{cr}, N and C_{cr}, N are taken in to account.
- When reduction on spacing and edge distance take place a re-calculation of forces should be carried out by making use of the technical guide or calculation software, they are available on request.
- Final calculations should comply with the complete European Technical Approval (ETA), this approval is also available on request.

Assembly sequence

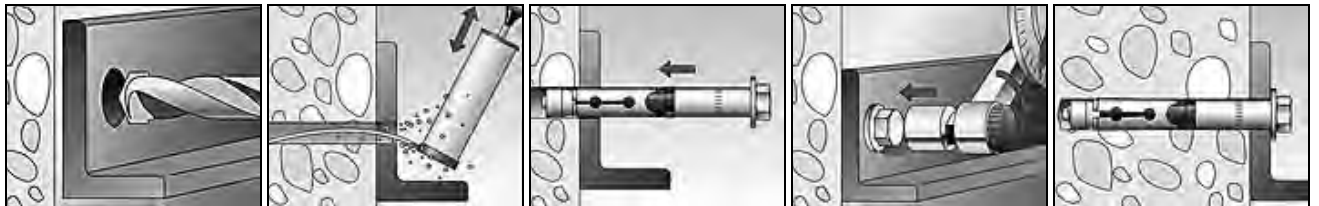

63422 FISCHER High performance anchor type FH II-S		N03A
Thread	Metric thread	
Material	Steel	
Surface treatment	Zinc plated	



Final calculations should comply with the complete European Technical Approval (ETA), this approval is also available on request.

Type	☒	Art.number	Type	☒	Art.number	Type	☒	Art.number
FH II 10/10 S	50	63422.100.011	FH II 12/50 S	25	63422.120.050	FH II 18/25 S	20	63422.180.025
FH II 10/25 S	50	63422.100.026	FH II 15/10 S	25	63422.150.010	FH II 18/50 S	20	63422.180.050
FH II 10/50 S	50	63422.100.051	FH II 15/25 S	25	63422.150.025	FH II 24/25 S	10	63422.240.025
FH II 12/10 S	50	63422.120.010	FH II 15/50 S	25	63422.150.050	FH II 24/50 S	10	63422.240.050
FH II 12/25 S	50	63422.120.025	FH II 18/10 S	20	63422.180.010			

Bolt anchor

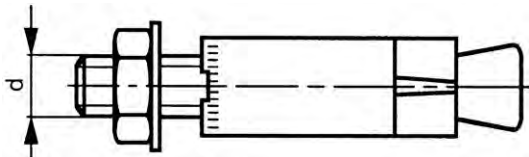

Technical Data					
Type	FZA 12x40 M8/15	FZA 12x50 M8/15	FZA 14x40 M10/25	FZA 14x60 M10/25	FZA 18x80 M12/25
d	M8	M8	M10	M10	M12
Drill depth	40	50	40	60	80
Drill ø (type FZUB)	12x40	12x50	14x40	14x60	18x80
Grip range (max.)	15	15	25	25	25
T _{inst}	20	20	40	40	60
Allowable load (kN)					
Concrete ≥ C20/25	2.4	4.3	2.4	5.7	9.5

- High permissible for assembly in tension zones!
- The allowable load is valid for one single anchor, at cracked concrete (tensile zone) with concrete class C20/25, incl. partial safety factor $\gamma_f = 1.4$.
- When reduction on spacing and edge distance take place a re-calculation of forces should be carried out by making use of the technical guide or calculation software, they are available on request.
- Final calculations should comply with the complete European Technical Approval (ETA), this approval is also available on request.

Assembly sequence

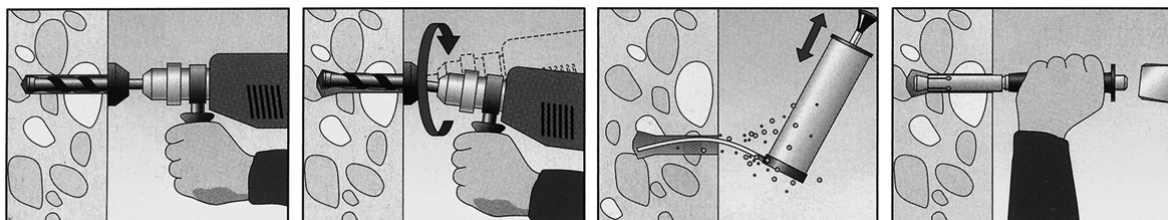

63445	FISCHER-ZYKON Bolt anchor type FZA	N03B
Thread	Metric thread	 
Material	Steel	
Surface treatment	Zinc plated	
		





Final calculations should comply with the complete European Technical Approval (ETA), this approval is also available on request.



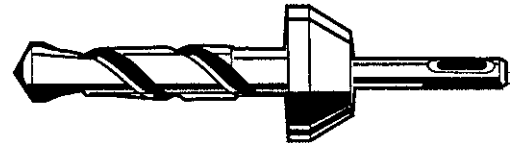



Type	☒	Art.number	Type	☒	Art.number	Type	☒	Art.number
FZA 12X40 M8/15	25	63445.120.040	FZA 14X40 M10/25	25	63445.140.040	FZA 18X80 M12/25	10	63445.180.080
FZA 12X50 M8/15	20	63445.120.050	FZA 14X60 M10/25	10	63445.140.060			

Bolt anchor installation tool



63690	FISCHER-ZYKON Bolt anchor installation tool type FZA	N03A
		 

8

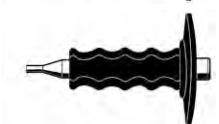
Type	☒	Art.number		
FZUB 12X40	1	63690.100.005	<ul style="list-style-type: none"> • Conical, correct drill-hole geometry • Drilling and undercutting in one single operation • With elastic depth stop • SDS-plus drive end 	
FZUB 14X40	1	63690.100.010	<ul style="list-style-type: none"> • Conical, correct drill-hole geometry • Drilling and undercutting in one single operation • With elastic depth stop • SDS-plus drive end 	
FZUB 12X50	1	63690.100.015	<ul style="list-style-type: none"> • Conical, correct drill-hole geometry • Drilling and undercutting in one single operation • With elastic depth stop • SDS-plus drive end 	
FZUB 14X60	1	63690.100.020	<ul style="list-style-type: none"> • Conical, correct drill-hole geometry • Drilling and undercutting in one single operation • With elastic depth stop • SDS-plus drive end 	
FZUB 18X80	1	63690.100.025	<ul style="list-style-type: none"> • Conical, correct drill-hole geometry • Drilling and undercutting in one single operation • With elastic depth stop • SDS-plus drive end 	
FZE 12 PLUS	1	63690.100.030		
FZE 14 PLUS	1	63690.100.035		
FZE 18 PLUS	1	63690.100.040		

MaxxFast Chemical Anchoring

MaxxFast introduces a range of high quality chemical anchoring products. This range consists of two types of chemical mortars (standard duty & heavy duty), zinc plated anchor studs, plastic sleeves and all the required accessories. These high quality products will answer your needs for the most demanding applications. VinyMaxx is our standard duty chemical mortar. It can be used for plain or hollow material. It gives great results for all none critical applications. AcryMaxx is our heavy duty chemical mortar. It can be used in concrete or high density stone. It is the best solution for high demanding applications. Our chemical anchoring products offer both strength and reliability for the best possible results.

VinyMaxx standard duty

For standard duty applications

- For solid and hollow substrates
- Automatic opening
- Non extruded resin can be used later
- Odourless (Styren free resin)
- Can be installed in wet concrete
- Can be installed in flooded holes

Application examples:

- Balustrading
- Handrails
- Canopies
- Shutter hinges
- Antennas

AcryMaxx ETA 1 heavy duty

Approved for use with threaded rods for use in cracked and non-cracked concrete (ETAG001 Option 1)

For heavy duty applications

- For solid substrates
- Automatic opening
- Odourless (Styren free resin)
- Can be installed in wet concrete
- Can be installed in flooded holes

Application examples:

- Safety barriers
- Storage racks
- Overhead cranes
- Machines
- Metal structures



Chemical fixing threaded rod

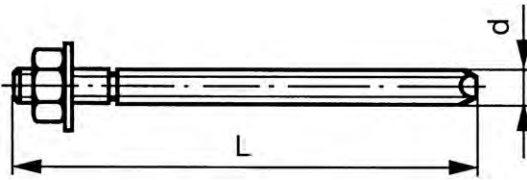

Technical Data

Type	M8x110	M10x130	M12x160	M12x220	M16x190	M16x220	M20x260
C_{cr} N	90 - 105	105 - 132	120 - 158	120 - 158	150 - 188	150 - 188	180 - 225
C_{min}	0.5*hef ≥ 40mm	0.5*hef ≥ 40mm	0.5*hef ≥ 40mm	0.5*hef ≥ 40mm	0.5*hef ≥ 40mm	0.5*hef ≥ 40mm	0.5*hef ≥ 40mm
d	8	10	12	12	16	16	20
d_f	9	12	14	14	18	18	22
d_o	10	12	14	14	18	18	24
h_{ef}	60-100	70-120	80-145	80-146	100-190	100-191	120-240
h_{min}	hef + 30mm; ≥100mm	hef + 30mm; ≥100mm	hef + 30mm; ≥100mm	hef + 30mm; ≥100mm	hef + 30mm; ≥100mm	hef + 30mm; ≥100mm	hef + 48mm
h_o	hef + 5mm	hef + 5mm	hef + 5mm	hef + 5mm	hef + 5mm	hef + 5mm	hef + 5mm
L	110	130	160	220	190	220	260
S_{cr} N	180 - 211	210 - 263	240 - 316	240 - 316	300 - 375	300 - 375	360 - 450
S_{min}	0.5*hef ≥ 40mm	0.5*hef ≥ 40mm	0.5*hef ≥ 40mm	0.5*hef ≥ 40mm	0.5*hef ≥ 40mm	0.5*hef ≥ 40mm	0.5*hef ≥ 40mm
Allowable load (kN)							
Concrete	7.78	11.35	15.56	15.56	21.94	21.94	28.41

- **C_{cr} N** = Characteristic Edge distance (tensile).
- **C_{min}** = Minimum edge distance (tensile).
- **d_f** = Hole diameter in fixture.
- **d_o** = Hole diameter in substrate.
- **h_{ef}** = Effective embedment depth.
- **h_{min}** = Minimum substrate thickness.
- **h_o** = Minimum hole depth.
- **S_{cr} N** = Characteristic spacing.
- **Concrete C20/25; recommended load for non-cracked concrete.**
- The allowable load is only valid for AcryMaxx Chemical Mortar in combination with Anchor studs, steel grade 5.8.
- The allowable load is valid for one single anchor, at cracked concrete (tensile zone) with concrete class C20/25, incl. partial safety factor $\gamma_f = 1,4$ and if the **S_{cr} N** and **C_{cr} N** are taken in to account.
- Final calculations should comply with the complete European Technical Approval (ETA), this approval is also available on request.



Final calculations should comply with the complete European Technical Approval (ETA), this approval is also available on request.

30585 MAXXFAST Chemical fixing threaded rod			MF40		
Thread	Metric thread				
Material	Steel				
Surface treatment	Zinc plated				

Type	☒	Art.number	Type	☒	Art.number	Type	☒	Art.number
M8X110	10	30585.080.110	M12X220	10	30585.120.220	M16X220	10	30585.160.220
M10X130	10	30585.100.130	M16X190	10	30585.160.190	M20X260	6	30585.200.260
M12X160	10	30585.120.160						

Chemical fixing threaded rod

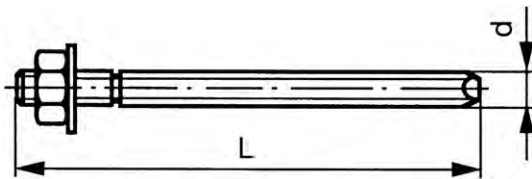

Technical Data

Type	M8x 110	M10x 130	M10x 165	M10x 190	M12x 160	M12x 220	M12x 250	M12x 300	M16x 190	M16x 250	M16x 300	M20x 260	M20x 350	M24x 300	M30x 380
d	M8	M10	M10	M10	M12	M12	M12	M12	M16	M16	M16	M20	M20	M24	M30
L	110	130	165	190	160	220	250	300	190	250	300	260	350	300	380
t _{fix} (max.)	13	20	57	82	25	90	120	170	35	98	148	65	155	65	65
Allowable load (kN)															
Concrete	6.3	7.9	7.9	7.9	11.9	11.9	11.9	11.9	19.8	19.8	19.8	29.8	29.8	37.7	67.5

- t_{fix} (max.) = Grip range (max.)
- Concrete C20/25 to C50/65; recommended load for non-cracked concrete.

Article groups

Thread	Material	Surface treatment	Code	Page
M	St	Zipl	63187	8-81
M	St.St. A4		63188	8-81

63187 FISCHER Chemical fixing threaded rod type RG M

N03B

Thread	Metric thread
Material	Steel
Surface treatment	Zinc plated

fischer
innovative solutions



Type	☒	Art.number	Type	☒	Art.number	Type	☒	Art.number
M8X110	10	63187.080.110	M12X250	10	63187.120.250	M20X260	10	63187.200.260
M10X130	10	63187.100.130	M12X300	10	63187.120.300	M20X350	10	63187.200.350
M10X165	10	63187.100.165	M16X165	10	63187.160.165	M24X300	10	63187.240.300
M10X190	10	63187.100.190	M16X190	10	63187.160.190	M30X380	5	63187.300.380
M12X160	10	63187.120.160	M16X250	10	63187.160.250			
M12X220	10	63187.120.220	M16X300	10	63187.160.300			

63188 FISCHER Chemical fixing threaded rod type RG M

N03B

Thread	Metric thread
Material	Stainless steel A4

fischer
innovative solutions

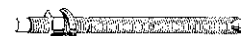

Type	☒	Art.number	Type	☒	Art.number	Type	☒	Art.number
M8X110	10	63188.080.110	M12X160	10	63188.120.160	M20X260	10	63188.200.260
M10X130	10	63188.100.130	M16X190	10	63188.160.190	M24X300	10	63188.240.300
M10X165	10	63188.100.165						

Chemical fixing threaded rod

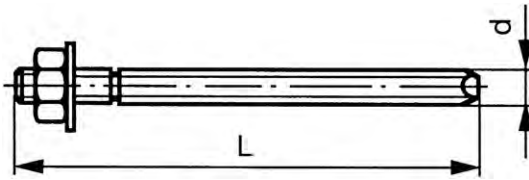

20663 Chemical fixing threaded rod

G06A

Thread	Metric thread
Material	Steel
Class	5.8
Surface treatment	Hot dip galvanized



d x L	☒	Art.number	d x L	☒	Art.number	d x L	☒	Art.number
M10X130	10	20663.100.130	M16X190	10	20663.160.190	M20X260	1	20663.200.260
M12X160	10	20663.120.160						

- Full boxes only.

Chemical fixing threaded rod

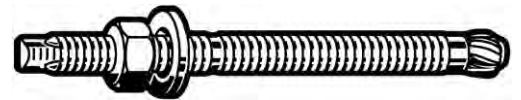
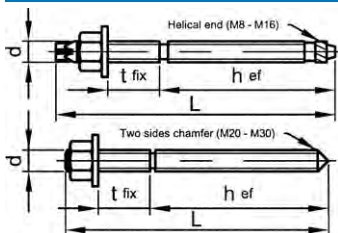



Technical Data

Type	M8	M10	M12	M16	M20	M24	M30
Allowable load (kN)	5.3	8.3	13.2	19.8	36.9	38	46.3
D	M8	M10	M12	M16	M20	M24	M30
Depth of drilled hole to deepest point ($h_{omin.}-h_{omax.}$)	80	90	110	125	170	210	280
Diameter of clearance hole in the fixture (d_f)	9	12	14	18	22	26	33
Edge distance ($C_{cr. N}$). characteristic	80	90	110	125	170	210	280
Effective anchorage depth ($h_{ef,min.}-h_{ef,max.}$)	80	90	110	125	170	210	280
L	105	128	155	183	260	300	380
Minimal edge distance ($C_{min.}$)	40	45	55	65	85	105	140
Minimal spacing ($S_{min.}$)	40	45	55	65	85	105	140
Minimal thickness of concrete element ($h_{min.}$)	110	120	150	160	220	300	350
Nominal diameter of drill bit (d_o)	10	12	14	18	25	28	35
Spacing ($S_{cr. N}$). characteristic	160	180	220	250	340	420	560
Thickness of the fixture	15	25	30	40	68	64	70
Tightening torque (Nm)	10	20	30	60	120	200	400

- M8 - M16 are supplied including setting tool
- For a complete chemical anchor, the capsule and threaded stud (incl. nut and washer), have to be ordered separately.
- For further technical data the approval is available on request.

Article groups

Thread	Material	Surface treatment	Code	Page
M	St	Zipl	70636	8-83
M	St.St. A4		70646	8-83



70636 SPIT chemical fixing threaded rod Maxima		P03A
Thread	Metric thread	  
Material	Steel	
Surface treatment	Zinc plated	



Final calculations should comply with the complete European Technical Approval (ETA), this approval is also available on request.

Type	☒	Art.number	Type	☒	Art.number	Type	☒	Art.number
M8	10	70636.080.001	M16	10	70636.160.001	M24	10	70636.240.001
M10	10	70636.100.001	M20	10	70636.200.001	M30	5	70636.300.001
M12	10	70636.120.001						

• Full boxes only.

70646 SPIT chemical fixing threaded rod Maxima		P03B
Thread	Metric thread	  
Material	Stainless steel A4	

Type	☒	Art.number	Type	☒	Art.number	Type	☒	Art.number
M8	10	70646.080.001	M12	10	70646.120.001	M20	10	70646.200.001
M10	10	70646.100.001	M16	10	70646.160.001	M24	10	70646.240.001

Setting tool



8

Assembly sequence

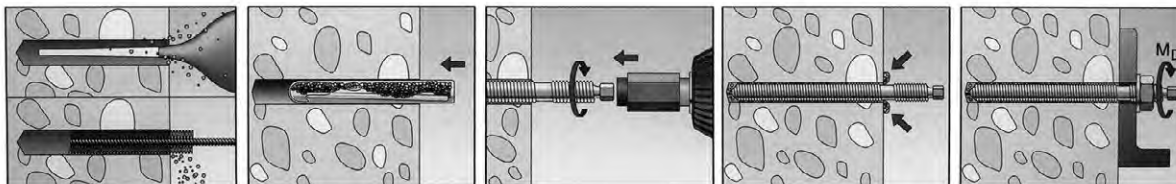

63189 FISCHER Setting tool		N03B
		 <i>innovative solutions</i> 

Type	☒	Art.number	Type	☒	Art.number	Type	☒	Art.number
M8	1	63189.080.001	M12	1	63189.120.001	M20	1	63189.200.001
M10	1	63189.100.001	M16	1	63189.160.001			

Chemical anchor capsule

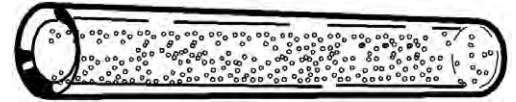
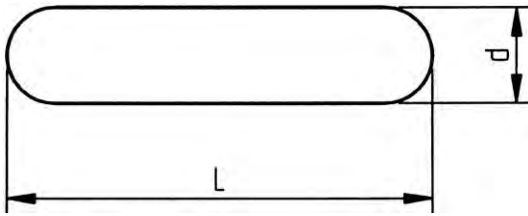

Technical Data

Type	d	Drill depth (min.)	Drill ø	L
M8	9	80	10	80
M10	10.5	90	12	85
M12	12.5	110	14	95
M16	16.5	125	18	95
M20	23	170	25	160
M24	23	210	28	190
M30	27.5	280	35	260

- For a complete chemical anchor, the capsule and threaded stud (incl. nut and washer), have to be ordered separately.

Article groups

Material	Code	Page
Glass	63186	8-84
Glass	70615	8-85

63186 FISCHER Chemical fixing resin capsule type RM

N03A

Material Glass

fischer
innovative solutions



Final calculations should comply with the complete European Technical Approval (ETA), this approval is also available on request.

Type	☒	Art.number	Type	☒	Art.number	Type	☒	Art.number
R M8	10	63186.080.001	R M16	10	63186.160.001	R M24	5	63186.240.001
R M10	10	63186.100.001	R M20	10	63186.200.001	R M30	5	63186.300.001
R M12	10	63186.120.001						

- Full boxes only.

70615	SPIT Chemical fixing resin capsule type EA	P03A
Material	Glass	 



Final calculations should comply with the complete European Technical Approval (ETA), this approval is also available on request.

Type	☒	Art.number	Type	☒	Art.number	Type	☒	Art.number
M8	10	70615.080.001	M16	10	70615.160.001	M24	10	70615.240.001
M10	10	70615.100.001	M20	10	70615.200.001	M30	5	70615.300.001
M12	10	70615.120.001						

- Full boxes only.

Injection cartridge



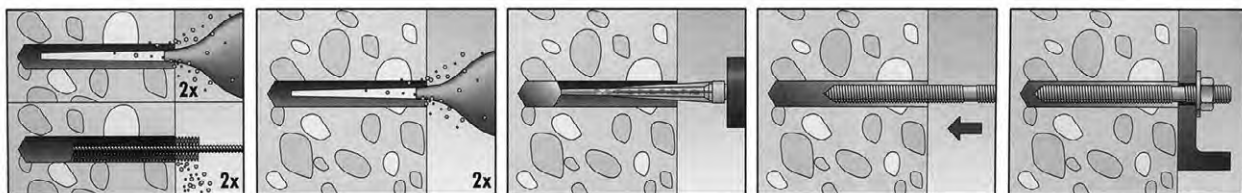

Assembly data



Article groups

	Code	Page
VinyMaxx	30581	8-85
AcryMaxx	30580	8-86
FIS VS	63252	8-86
FIS V	63051	8-86
FIS VS	63060	8-86

30581	MAXXFAST Injection cartridge VinyMaxx	MF40
		 

Type	☒	Art.number	
VinyMaxx	1	30581.000.310	<ul style="list-style-type: none"> • Styrene free high performance resin for solid and hollow substrates. 310 ml. 

30580 MAXXFAST Injection cartridge Acrymaxx MF40







Final calculations should comply with the complete European Technical Approval (ETA), this approval is also available on request.

Type	☒	Art.number	
AcryMaxx	1	30580.000.310	<ul style="list-style-type: none"> • High performance two component styrene free resin for anchoring threaded rod and internally threaded sockets in concrete. • European Technical Approval and CE marking. • Resistant to extreme temperatures (from -40°C to +80°C) after polymerisation. • 310 ml.



63252 FISCHER Injection cartridge N03A

Type	☒	Art.number	Type	☒	Art.number	Type	☒	Art.number
FIS VS 300 T	1	63252.000.300	FIS P 300 T	12	63252.441.030	FIS VT300T	1	63252.520.020

- FIS VS300 T= ETA1
- FIS P300T ≠ ETA
- FIS VT300T= ETA7



63051 FISCHER Injection cartridge N03A



Type	☒	Art.number	Type	☒	Art.number
V360S=FIS	1	63051.000.360	VT380C=FIS	1	63051.000.380

- V360S=FIS= ETA1
- VT380C=FIS= ETA7

63060 FISCHER Injection cartridge N03A





Type	☒	Art.number
VS150C	6	63060.000.150

VS150C= ETA1

8

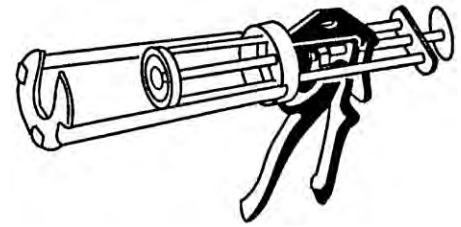
Injection tool



Article groups

Code	Page
30595	8-87
63691	8-87
63243	8-87

30595	MAXXFAST Injection tool	MFN0

Type	Art.number
Gun	1 30595.000.100

63691	FISCHER Injection tool	N03C

Type	Art.number	Description	Image
FIS AM	1 63691.100.015	• Suitable for injection cartridge type FIS V 360 S, FIS HB 345 S, FIS EM 390 S, FIS VS 150C & PU foam.	
FIS AC	1 63691.100.020	• Suitable for injection cartridge type FIS P 380 C, FIS VT 380 C, FIS V410 C.	
KP M 2	1 63691.100.035	• Suitable for injection cartridge type FIS V410 C, FIS V T 380 C, FIP C 700 HO, PE 410 SF.	

63243	FISCHER Injection tool	N03A

Type	Art.number
14/20 MM	1 63243.014.020

Anchoring accessories

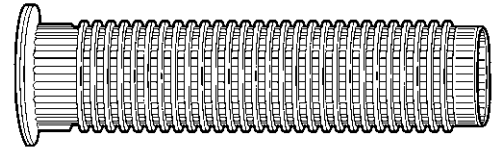
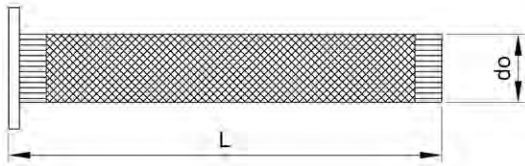

Technical Data				
Type	12x50	15x85	15x130	20x85
Assembly depth (min.)	50	85	130	85
d _o	12	15	15	20
Drill depth (min.)	60	95	140	95
Drill ø	12	15	15	20
L	50	85	130	85
Threaded rod size	M6	M8-M10-M12	M8-M10-M12	M12-M16

30596 MAXXFAST Anchoring accessories MFNO

MAXXFAST
PROFESSIONAL HARDWARE

Type	☒	Art.number		
Blow pump	1	30596.000.001	• Plastic	
Mixing nozzle	5	30596.000.005	• Plastic	
Brush white	1	30596.008.012	• 8-12mm	
Brush Blue	1	30596.010.018	• 10-18mm	
Brush Red	1	30596.012.028	• 12-28mm	
Anchor sleeve	10	30596.012.050	• Plastic Nylon (polyamide) • 12x50	
Anchor sleeve	10	30596.015.085	• Plastic Nylon (polyamide) • 15x85	
Anchor sleeve	10	30596.015.130	• Plastic Nylon (polyamide) • 15x130	
Anchor sleeve	10	30596.020.085	• Plastic Nylon (polyamide) • 20x85	

Injection system injection anchor sleeve

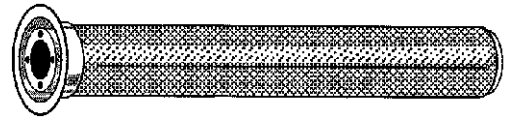

Technical Data

Type	FIS H16 x 85N	FIS H18 x 85N	FIS H20 x 85N	FIS H12 X 1000	FIS H16 X 1000	FIS H22 X 1000
Assembly depth (min.)	85	85	85	-	-	-
d	16	18	20	12	16	22
Drill depth (min.)	95	95	95	-	-	-
Drill ø	16	18	20	12	16	22
L	85	85	85	1000	1000	1000
Threaded rod size	M8	M10	M12	M6-M8	M10-M12	M12-M16

Assembly sequence

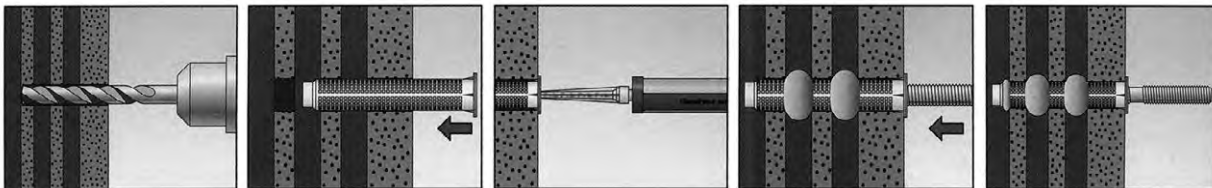

Article groups

Material	Surface treatment	Code	Page
Plastic PA		63052	8-89
St	Zipl	63050	8-89

63052 FISCHER Injection system injection anchor sleeve type FIS H N		N03A
Material	Plastic Polyamide (nylon)	

Type	Art.number	Type	Art.number	Type	Art.number
FIS16X85MM	20 63052.160.085	FIS18X85MM	20 63052.180.085	FIS20X85MM	20 63052.200.085

63050 FISCHER Injection system injection anchor sleeve type FIS H L		N03A
Material	Steel	
Surface treatment	Zinc plated	

d x L	Art.number	d x L	Art.number	d x L	Art.number
12X1000MM	10 63050.120.001	16X1000MM	10 63050.160.001	22X1000MM	6 63050.220.001

Chemical fixing internal threaded anchor

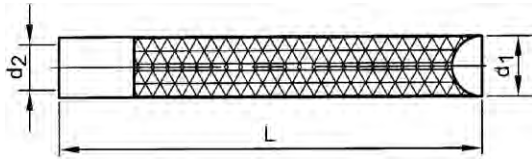

Technical Data



Type	RG 8x75 M5 I	RG 10x75 M6 I	RG 12x90 M8 I	RG 16x90 M10 I	RG 18x125 M12 I
d ₁	8	10	12	16	18
d ₂	M5	M6	M8	M10	M12
Depth of drilled hole to deepest point (h _o)	75	75	90	90	125
Diameter of clearance hole in the fixture (d _f)	6	7	9	12	14
Edge distance (C _{cr, N}) characteristic	55	70	145	195	210
Effective anchorage depth (h _{ef})	75	75	90	90	125
L	75	75	75	75	75
Minimal edge distance (C _{min})	40	45	45	45	60
Minimal spacing (S _{min})	40	45	45	45	60
Minimal thickness of concrete element (h _{min})	120	120	120	120	170
N = Allowable load (kN)	3.4	4.8	9.1	14.4	21.1
Nominal diameter of drill bit (d _o)	10	12	14	18	18

- The allowable load is valid for one single anchor, at non-cracked concrete (pressure zone) with concrete class C20/25, in combination with bolt class 5.8 and if the S_{cr, N} and C_{cr, N} are taken in to account. When reduction on spacing and edge distance take place a re-calculation of forces should be carried out.
- For a complete chemical fixing, the resin capsule and internal threaded anchor have to be ordered separately. Setting tool is enclosed in each packing.

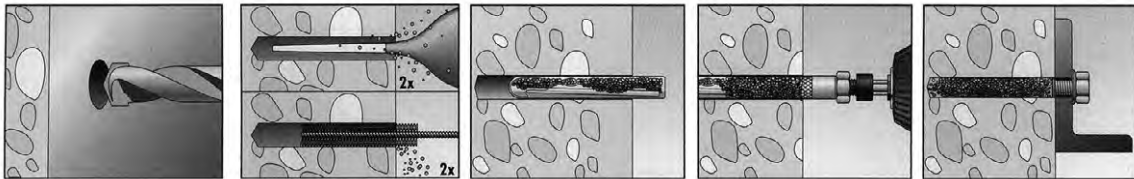
Assembly sequence

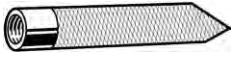

8

63227 FISCHER Chemical fixing internal threaded anchor type RG MI		N03A
Thread	Metric thread	  
Material	Steel	
Surface treatment	Zinc plated	

Type	☒	Art.number	Type	☒	Art.number	Type	☒	Art.number
RG 8X75 M5 I	10	63227.050.001	RG 12X90 M8 I	10	63227.080.090	RG 18X125 M12 I	10	63227.120.100
RG 10X75 M6 I	10	63227.060.001	RG 16X90 M10 I	10	63227.100.090			

Masonry bolt type A

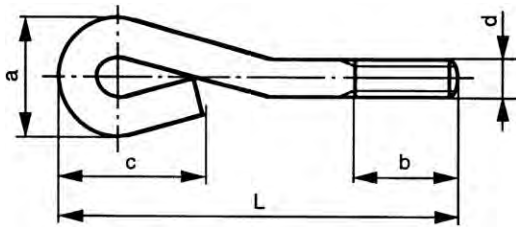

DIN 529 A
NEN 2328 A



Technical Data

d	a	b	c	P
M12	36	30	65	1.75
M16	48	40	85	2
M20	60	50	105	2.5
M24	75	60	125	3
M30	95	75	155	3.5

20710 Masonry bolt type A

G06D

Thread Metric thread
Material Steel
Class 4.6



d x L	☒	Art.number	d x L	☒	Art.number	d x L	☒	Art.number
M12X160	25	20710.120.160	M16X400	10	20710.160.400	M24X250	3	20710.240.250
M12X200	25	20710.120.200	M20X200	5	20710.200.200	M24X320	3	20710.240.320
M12X250	25	20710.120.250	M20X250	5	20710.200.250	M24X400	3	20710.240.400
M16X160	10	20710.160.160	M20X320	5	20710.200.320	M24X500	3	20710.240.500
M16X200	10	20710.160.200	M20X400	5	20710.200.400	M30X400	2	20710.300.400
M16X250	10	20710.160.250	M20X500	5	20710.200.500	M30X500	2	20710.300.500
M16X320	10	20710.160.320				M30X630	2	20710.300.630

Masonry bolt type E

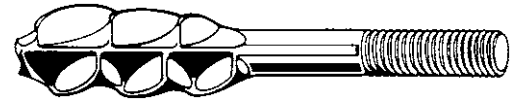
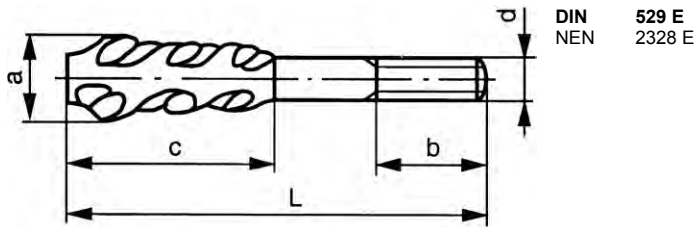

Technical Data

d	a	b	c	P
M10	20	25	55	1.5
M12	24	30	70	1.75
M16	32	40	90	2
M20	40	50	100	2.5
M24	48	60	135	3
M30	60	75	150	3.5

20750 Masonry bolt type E

G06D

Thread Metric thread
 Material Steel
 Class 3.6
 Surface treatment Zinc plated



d x L	☒	Art.number	d x L	☒	Art.number	d x L	☒	Art.number
M10X125	25	20750.100.125	M20X200	5	20750.200.200	M24X320	3	20750.240.320
M12X125	25	20750.120.125	M20X320	5	20750.200.320	M30X320	2	20750.300.320
M16X160	10	20750.160.160	M24X250	3	20750.240.250	M30X630	2	20750.300.630

Hook anchor

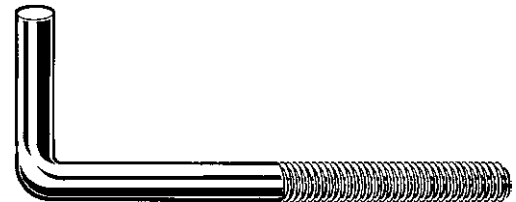
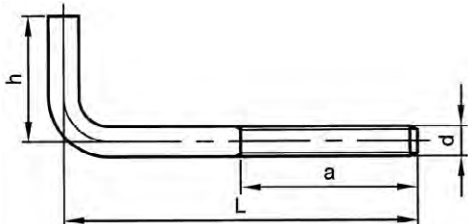

Technical Data

d	a	P
M10	150	1.5
M12	150	1.75
M16	150	2
M20	150	2.5
M24	150	3
M30	150	3.5

• Steel with a tensile strength of min. 400 N/mm² and a lower yield stress of min. 240 N/mm².

Article groups

Thread	Material	Class	Surface treatment	Code	Page
M	St			50mm hook 20610	8-93
M	St		Zipl	50mm hook 20630	8-93
M	St		Hot d.g.	50mm hook 20650	8-93
M	St			100mm hook 20620	8-93
M	St		Zipl	100mm hook 20640	8-93
M	St		Hot d.g.	100mm hook 20660	8-94
M	St	8.8	Hot d.g.	100mm hook 20661	8-94

20610 Hook anchor with 50mm hook G06D

Thread: Metric thread
Material: Steel

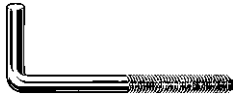
d x L	Art.number	d x L	Art.number	d x L	Art.number
M10X200	1 20610.100.200	M16X250	1 20610.160.250	M16X450	1 20610.160.450
M10X300	1 20610.100.300	M16X300	1 20610.160.300	M20X400	1 20610.200.400
M12X300	1 20610.120.300	M16X350	1 20610.160.350	M20X450	1 20610.200.450
M12X400	1 20610.120.400	M16X400	1 20610.160.400		

20630 Hook anchor with 50mm hook G06D

Thread: Metric thread
Material: Steel
Surface treatment: Zinc plated



d x L	Art.number	d x L	Art.number	d x L	Art.number
M10X200	1 20630.100.200	M16X300	1 20630.160.300	M20X350	1 20630.200.350
M12X250	1 20630.120.250	M16X350	1 20630.160.350	M20X400	1 20630.200.400
M16X250	1 20630.160.250	M16X400	1 20630.160.400	M20X450	1 20630.200.450
		M16X450	1 20630.160.450		
		M16X500	1 20630.160.500		

20650 Hook anchor with 50mm hook oversized thread G06D

Thread: Metric thread
Material: Steel
Surface treatment: Hot dip galvanized



d x L	Art.number	d x L	Art.number	d x L	Art.number
M12X300	1 20650.120.300	M16X350	1 20650.160.350	M20X350	1 20650.200.350
M12X400	1 20650.120.400	M16X400	1 20650.160.400	M20X400	1 20650.200.400
M16X300	1 20650.160.300	M16X450	1 20650.160.450	M20X450	1 20650.200.450
		M16X500	1 20650.160.500		

20620 Hook anchor with 100mm hook G06D

Thread: Metric thread
Material: Steel



d x L	Art.number	d x L	Art.number	d x L	Art.number
M16X300	1 20620.160.300	M20X400	1 20620.200.400	M24X600	1 20620.240.600
M16X400	1 20620.160.400	M20X500	1 20620.200.500	M24X700	1 20620.240.700
M16X500	1 20620.160.500	M20X600	1 20620.200.600	M24X800	1 20620.240.800
M16X600	1 20620.160.600	M20X700	1 20620.200.700		
M16X700	1 20620.160.700	M20X800	1 20620.200.800	M30X500	1 20620.300.500
M16X800	1 20620.160.800			M30X600	1 20620.300.600
M20X300	1 20620.200.300	M24X400	1 20620.240.400	M30X700	1 20620.300.700
		M24X500	1 20620.240.500		

20640 Hook anchor with 100mm hook G06D

Thread: Metric thread
Material: Steel
Surface treatment: Zinc plated





d x L	Art.number	d x L	Art.number	d x L	Art.number
M12X300	1 20640.120.300	M16X300	1 20640.160.300	M16X800	1 20640.160.800
M12X400	1 20640.120.400	M16X400	1 20640.160.400	M20X300	1 20640.200.300
M12X500	1 20640.120.500	M16X500	1 20640.160.500	M20X400	1 20640.200.400
M12X600	1 20640.120.600	M16X600	1 20640.160.600	M20X500	1 20640.200.500
		M16X700	1 20640.160.700		

20640 Hook anchor with 100mm hook								
d x L	☒	Art.number	d x L	☒	Art.number	d x L	☒	Art.number
M20X600	1	20640.200.600	M24X500	1	20640.240.500	M30X500	1	20640.300.500
M20X700	1	20640.200.700	M24X600	1	20640.240.600	M30X600	1	20640.300.600
M20X800	1	20640.200.800	M24X700	1	20640.240.700	M30X700	1	20640.300.700
M24X400	1	20640.240.400	M24X800	1	20640.240.800	M30X800	1	20640.300.800

20660 Hook anchor with 100mm hook oversized thread		G06D
Thread	Metric thread	 
Material	Steel	
Surface treatment	Hot dip galvanized	

d x L	☒	Art.number	d x L	☒	Art.number	d x L	☒	Art.number
M12X300	1	20660.120.300	M16X800	1	20660.160.800	M24X500	1	20660.240.500
M12X400	1	20660.120.400	M20X300	1	20660.200.300	M24X600	1	20660.240.600
M12X500	1	20660.120.500	M20X400	1	20660.200.400	M24X700	1	20660.240.700
M12X600	1	20660.120.600	M20X500	1	20660.200.500	M24X800	1	20660.240.800
M16X300	1	20660.160.300	M20X600	1	20660.200.600	M30X500	1	20660.300.500
M16X400	1	20660.160.400	M20X700	1	20660.200.700	M30X600	1	20660.300.600
M16X500	1	20660.160.500	M20X800	1	20660.200.800	M30X700	1	20660.300.700
M16X600	1	20660.160.600	M24X400	1	20660.240.400	M30X800	1	20660.300.800
M16X700	1	20660.160.700						

20661 Hook anchor with 100mm hook oversized thread		G06A
Thread	Metric thread	 
Material	Steel	
Class	8.8	
Surface treatment	Hot dip galvanized	

d x L	☒	Art.number	d x L	☒	Art.number	d x L	☒	Art.number
M16X400	1	20661.160.400	M20X400	1	20661.200.400	M24X400	1	20661.240.400
M16X500	1	20661.160.500	M20X500	1	20661.200.500	M24X500	1	20661.240.500
M16X600	1	20661.160.600	M20X600	1	20661.200.600	M24X600	1	20661.240.600

Threaded rod for shuttering knuckle thread

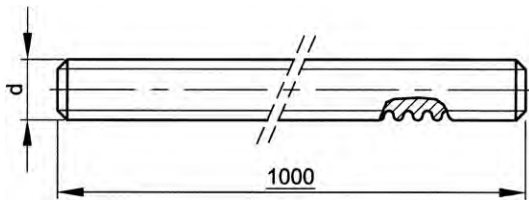

- Special features of threaded rods for shuttering:
- Are poured in concrete without using plastic sleeves or similar.
- After starching of the concrete the threaded rod can be loosened by hammering and turned out.
- Concrete does not adhere well on the threaded profile, so cleaning of the rods is not necessary and they can be re-used.
- The mortar to cover the hole afterwards attaches very well (contra-profile of the thread in the concrete).

20420 Threaded rod length 1 meter for shuttering knuckle thread		G05B	
Material Class	Steel ≥4.8	 	
d	☒ Art.number	d	☒ Art.number
20MM	4 20420.200.001	24MM	4 20420.240.001
		30MM	2 20420.300.001

Hexagon nut for threaded rods for shuttering knuckle thread

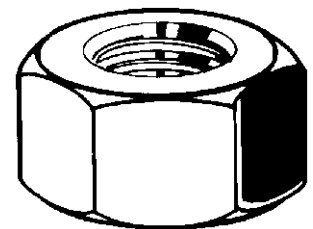
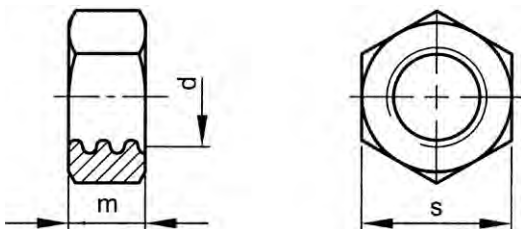

Technical Data			
d	m	P	s
20	16	5	30
24	19	5	36
30	24	5	46

- Special features of threaded rods for shuttering:
- Are poured in concrete without using plastic sleeves or similar.
- After starching of the concrete the threaded rod can be loosened by hammering and turned out.
- Concrete does not adhere well on the threaded profile, so cleaning of the rods is not necessary and they can be re-used.
- The mortar to cover the hole afterwards attaches very well (contra-profile of the thread in the concrete).

20430 Hexagon nut for threaded rods for shuttering knuckle thread		G05B	
Material Class	Steel 5	 	
d	☒ Art.number	d	☒ Art.number
20MM	8 20430.200.001	24MM	8 20430.240.001
		30MM	4 20430.300.001

DEMU Fixing anchors – systematic fixing solutions

DEMU Fixing anchors with internal thread are intended to be used for permanent anchorages under predominantly static actions or quasi-static actions in reinforced and unreinforced normal weight concrete from strength class C20/25 to C90/105. They may be used in cracked or non-cracked concrete for transmission of tensile loads, shear loads or a combination of both.

VEMO Socket anchors

General information:

The VEMO Socket anchors are light duty fixing anchors with low load capacities, mainly used for temporary fixings and applications without structural significance. There is currently no calculation method to calculate the load capacity of the majority of the socket anchors.

Corrosion protection:

- Zinc galvanisation (GV) - The surface of the socket anchors is zinc galvanised (chromium VI free) with a coating thickness of approximately 5–8 μm , providing protection against insignificant corrosion exposure (dry interior rooms).
- Stainless steel (A4) - The socket anchors in A4 are manufactured from stainless steel, providing high protection against medium corrosion exposure (external atmosphere).

Different types:

995-GB GV, 995 A4, 995-G GV / A4, 995-DG GV, 1036-G GV / A4, 1130 GV, 1140 GV / A4

Available thread sizes:

M6, M8, M10, M12, M16, M20, M24 and M30

Application examples:

Fixing of push pull props on precast elements, fixing of windows, fixing of machines on foundation (without dynamic loading), temporary bracing of precast elements, etc.



Bar connector

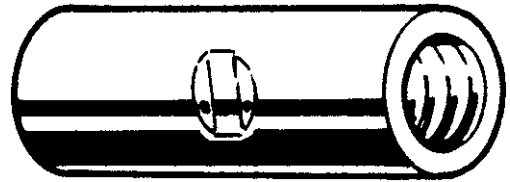
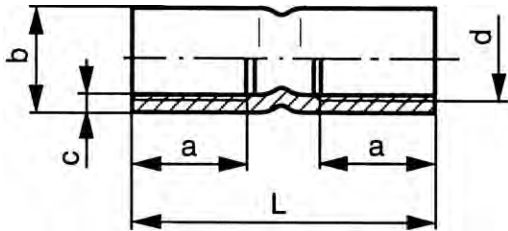

Technical Data

d	a	b	c	P	Tensile load (kN)
M12	18	15.5	2.5	1.75	39
M16	24	21	3.4	2	75
M20	30	26	4.2	2.5	115

18550 VEMO Bar connector No. 1550

P07A

Thread Metric thread
Material Steel
Surface treatment Zinc plated



d x L	Art.number	d x L	Art.number	d x L	Art.number
M12X35	200 18550.120.035	M16X45	200 18550.160.045	M20X55	100 18550.200.055

Bush

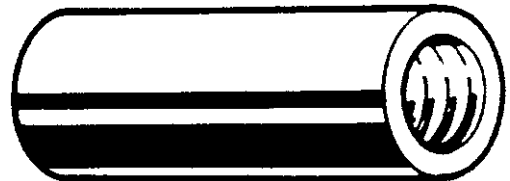
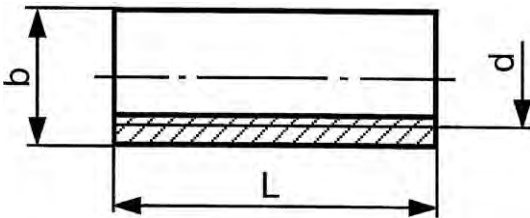

Technical Data

d	b	P	Tensile load (kN)
M6	10	1	13
M8	12	1.25	16
M10	13	1.5	14
M12	15.5	1.75	39
M16	21	2	75
M20	26	2.5	115
M24	32	3	181
M30	40	3.5	284

18570 VEMO Bush No. 1551

P07A

Thread Metric thread
Material Steel
Surface treatment Zinc plated

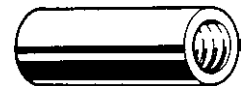

d x L	Art.number	d x L	Art.number	d x L	Art.number
M6X15	200 18570.060.015	M12X35	200 18570.120.035	M24X70	50 18570.240.070
M8X20	200 18570.080.020	M16X45	200 18570.160.045	M30X90	25 18570.300.090
M10X25	200 18570.100.025	M20X55	100 18570.200.055		

Tube insert No. 1140

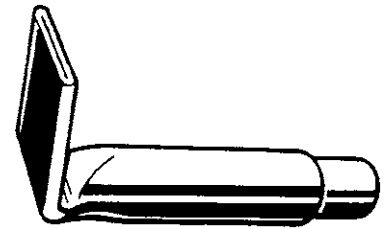
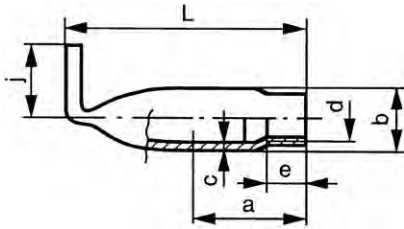

Technical Data

	M10	M12	M16
d	M10	M12	M16
a	35	40	32
b	13.5	17	21.3
c	1.5	2	3.2
e	10	12	16
j	25	30	35
Pull-out force (kN)			
Concrete	24	32	52

- Pull-out force in kN.
- It is advised to take a safety factor 4.

18120 VEMO Tube insert No. 1140		P07A	
Thread	Metric thread		
Material	Steel		
Surface treatment	Zinc plated		

d x L	☒	Art.number	d x L	☒	Art.number	d x L	☒	Art.number
M10X60	400	18120.100.060	M12X70	200	18120.120.070	M16X100	100	18120.160.100

Insert with nailing plate No. 1130

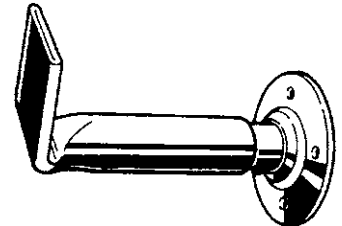
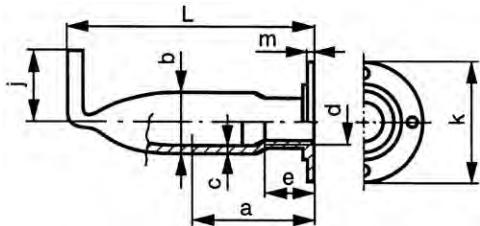

Technical Data

	M10	M12	M16	M20
d	M10	M12	M16	M20
a	35	40	32	40
b	13.5	17	21.3	26.9
c	1.5	2	2.6	2.6
e	10	12	16	20
j	25	30	35	35
k	34	40	44	48
m	1	1	1.5	1.5
Pull-out force (kN)				
Concrete	24	32	52	64

- It is advised to take a safety factor 4.

18140 VEMO Insert with nailing plate No. 1130		P07A	
Thread	Metric thread		
Material	Steel		
Surface treatment	Zinc plated		

d x L	☒	Art.number	d x L	☒	Art.number	d x L	☒	Art.number
M10X60	400	18140.100.060	M12X70	200	18140.120.070	M16X100	100	18140.160.100

Tube insert No. 995G

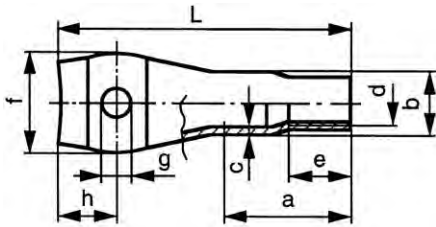

Technical Data

d	M6	M8	M10	M12	M16	M16	M20	M24	M30
a	20	25	20	23	25	32	40	50	70
b	8.5	10.5	13.5	17	21.3	21.3	26.9	33.7	42
c	1	1	1.5	2	3.2	3.2	3.2	4	4
e	6	8	10	12	16	16	20	24	30
f	12.5	16	20	25	30	30	39	48	64
g	6.0	8.1	6.2	7.2	9.2	9.2	12.2	14.2	15.2
h	7	8	12	15	17	22	22	25	25
L	40	50	50	60	70	100	100	120	150

Pull-out force (kN)

Concrete	6	10	14	20	28	40	50	72	110
----------	---	----	----	----	----	----	----	----	-----

- It is advised to take a safety factor 4.

18040 VEMO Tube insert No. 995 G

P07A

Thread Metric thread
Material Steel
Surface treatment Zinc plated



d x L	☒	Art.number	d x L	☒	Art.number	d x L	☒	Art.number
M6X40	500	18040.060.040	M12X60	400	18040.120.060	M20X100	100	18040.200.100
M8X50	500	18040.080.050	M16X70	200	18040.160.070	M24X120	50	18040.240.120
M10X50	500	18040.100.050	M16X100	100	18040.160.100	M30X150	25	18040.300.150

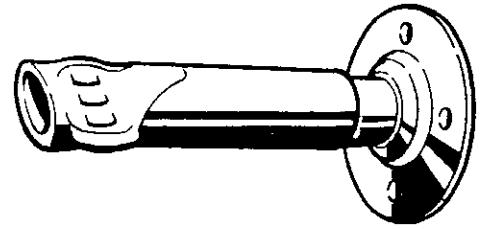
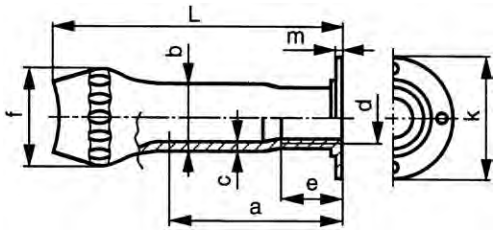

Insert with nailing plate No. 1036



Technical Data

d	M10	M12	M16	M20	M24
a	30	40	32	50	40
b	13.5	17	21.3	26.9	33.7
c	1.5	2	2.6	2.6	4
e	10	12	16	20	24
f	20	25	31	39	48
k	34	40	44	48	57
m	1	1	1.5	1.5	1.5
Pull-out force (kN)					
Concrete	16	24	40	50	64

• It is advised to take a safety factor 4.

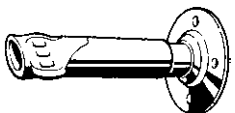
18060 VEMO Insert with nailing plate No. 1036		P07A
Thread	Metric thread	  
Material	Steel	
Surface treatment	Zinc plated	

d x L	☒	Art.number	d x L	☒	Art.number	d x L	☒	Art.number
M10X50	200	18060.100.050	M16X100	100	18060.160.100	M24X120	50	18060.240.120
M12X70	200	18060.120.070	M20X100	100	18060.200.100			

Pipe plug

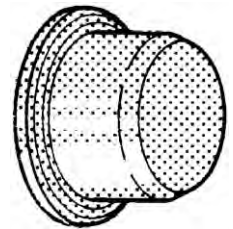
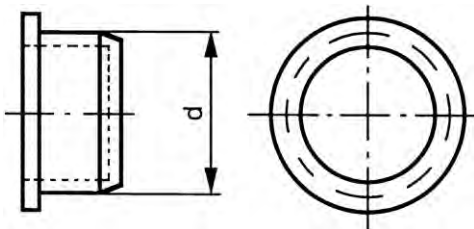

18600 VEMO Pipe plug No. 2244		P07A
Material	Plastic Polyethylene	 

d = For nom. size.	☒	Art.number	d = For nom. size.	☒	Art.number	d = For nom. size.	☒	Art.number
M6-Red	100	18600.060.001	M12-Red	100	18600.120.001	M20-Blue	100	18600.200.001
M8-Red	100	18600.080.001	M16-Black	100	18600.160.001	M24-Red	100	18600.240.001
M10-Red	100	18600.100.001						

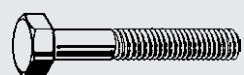

1 Bolts



2 Hexagon socket products



3 Nuts, rivet nuts & inserts



4 Threaded rods & studbolts



5 Hook & eye products



6 Screws

I Index



7 Washers & O-rings



8 Anchoring products

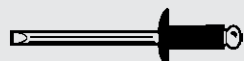

9 Rivets, pins & keys



10 Systems, furniture & security fasteners



11 Assortments & storage systems

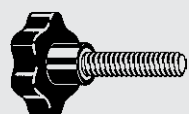











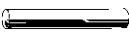
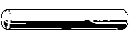
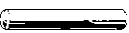
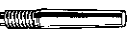
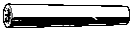
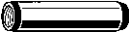
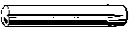



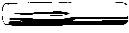
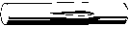
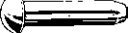









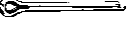











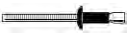

12 Engineering parts & machine parts



13 Maritime products

T Fastening technology

Rivets, pins & keys 9

 Page 9-3 DIN 1 B Conical	 Page 9-5 DIN 7 Parallel	 Page 9-8 DIN 6325 Parallel tolerance m6	 Page 9-10 DIN ≈6325 Parallel tolerance h6	 Page 9-11 DIN 7977 Conical with external thread
 Page 9-12 DIN 7978 A Conical with internal thread	 Page 9-13 DIN 7979 D Parallel with internal thread	 Page 9-14 DIN 1470 Parallel grooved with pin	 Page 9-15 DIN 1471 Taper grooved	 Page 9-16 DIN 1472 Half length taper grooved
 Page 9-18 DIN 1473 Parallel grooved	 Page 9-19 DIN 1474 Parallel grooved	 Page 9-21 DIN 1475 Center grooved	 Page 9-22 DIN 1476 Grooved pin	 Page 9-23 Drive screw
 Page 9-24 ISO 8750 Standard duty	 Page 9-25 ISO ≈8750 Stainless steel	 Page 9-26 ISO 8748 Heavy	 Page 9-27 ISO 8752 Heavy	 Page 9-29 ISO 13337 Light
 Page 9-30 DIN ≈1481 Heavy stainless steel	 Page 9-32 DIN 660/124 Round head	 Page 9-34 DIN 661/302 Countersunk	 Page 9-36 DIN 1434 Clevis pin with pin hole	 Page 9-37 DIN 94 Split pin
 Page 9-42 DIN ≈11024 Single	 Page 9-43 DIN ≈11024 Double	 Page 9-44 DIN 11024 Double A4	 Page 9-45 Pipe pin	 Page 9-46 Linch pin
 Page 9-47 DIN 6885 A Parallel key high type	 Page 9-50 DIN 6880 Length 1 meter	 Page 9-51 DIN 6888 Woodruff key	 Page 9-52 DIN 6887 Gib head	 Page 9-55 Domed head blind rivet
 Page 9-61 Large domed head blind rivet	 Page 9-63 Countersunk blind rivet	 Page 9-65 Domed head blind rivet PLUS BULB Steel	 Page 9-66 Domed head blind rivet PLUS BULB	 Page 9-67 Domed head blind rivet P-LOCK
 Page 9-68 Countersunk blind rivet PLUS BULB	 Page 9-69 For license plates	 Page 9-69 DIN ≈7337 A Domed head blind rivet	 Page 9-70 Multigrip blind rivet domed head, Type B	 Page 9-71 Domed head multigrip blind rivet
 Page 9-72 Extra large domed head blind rivet multigrip	 Page 9-73 Countersunk head blind rivet multigrip	 Page 9-74 Sealed domed head rivet	 Page 9-77 Sealed countersunk rivet	 Page 9-78 Domed head expanding blind rivet

<p>Page 9-79</p>  <p>Domed head expanding blind rivet</p>	<p>Page 9-80</p>  <p>Blind rivet tool</p>	<p>Page 9-81</p>  <p>Blind rivet tool set</p>
--	--	--

Taper pin turned

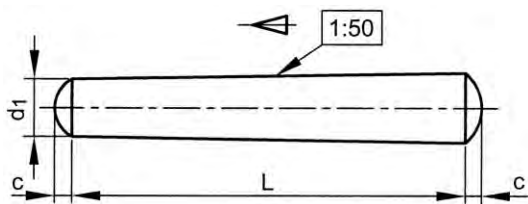

DIN 1 B
ISO 2339 B
NEN 10 B



Technical Data

d_1 (h10)	c (max.)	$d_2 >$	$d_2 \leq$	W (min.)
0.6	0.1	1	2	2
0.8	0.12	2	3	2.5
1	0.15	3	4	3
1.5	0.23	4/5	5/6	3.5/4
2	0.3	6	8	4.5
2.5	0.4	8	9	5
3	0.45	8	11	5
4	0.6	11	17	6
5	0.75	17	23	7.5
6	0.9	23	30	9
6.5 (#DIN)	1	25	33	10
7 (#DIN)	1.2	33	40	12
8	1.2	30/38	38/45	10/11
10	1.5	45/50	50/75	11.5/13
12	1.8	75	110	15
13 (#DIN)	1.8	75	110	15
14	2	75	110	15
16	2.5	110	160	18

- Taper pins are designed for the friction type fastening and/or locking together of two or more individual elements. The tapered shape allows the connection to be disconnected repeatedly, and when the elements are joined together again, their location remains as accurate as it was previously, and the frictional connection remains as strong as before.
- The nominal length (L) does not include the rounded ends (tolerance js15).

Assembly data

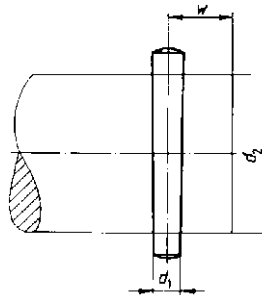

Article groups

Material	Code	Page
Free-cutting steel	39000	9-3
St.St. A1	51560	9-4

39000 Taper pin turned L11A

Material: Free-cutting steel

d_1 x L	Art.number	d_1 x L	Art.number	d_1 x L	Art.number
1X14MM	200 39000.010.014	1,5X20MM	200 39000.015.020	2X14MM	200 39000.020.014
1X18MM	200 39000.010.018	1,5X24MM	200 39000.015.024	2X16MM	200 39000.020.016
1X20MM	200 39000.010.020	1,5X30MM	200 39000.015.030	2X20MM	100 39000.020.020
				2X24MM	100 39000.020.024
1,5X10MM	200 39000.015.010	2X10MM	200 39000.020.010	2X30MM	100 39000.020.030
1,5X14MM	200 39000.015.014	2X12MM	200 39000.020.012	2X40MM	100 39000.020.040

39000 Taper pin turned								
d ₁ x L	☒	Art.number	d ₁ x L	☒	Art.number	d ₁ x L	☒	Art.number
2X50MM	50	39000.020.050	5X50MM	50	39000.050.050	10X30MM	25	39000.100.030
2.5X12MM	200	39000.025.012	5X60MM	25	39000.050.060	10X40MM	25	39000.100.040
2.5X16MM	200	39000.025.016	5X70MM	25	39000.050.070	10X50MM	25	39000.100.050
2.5X20MM	100	39000.025.020	5X80MM	25	39000.050.080	10X60MM	25	39000.100.060
2.5X24MM	100	39000.025.024	5X100MM	25	39000.050.100	10X70MM	10	39000.100.070
2.5X26MM	100	39000.025.026	6X20MM	50	39000.060.020	10X80MM	10	39000.100.080
2.5X30MM	100	39000.025.030	6X24MM	50	39000.060.024	10X100MM	10	39000.100.100
2.5X36MM	50	39000.025.036	6X30MM	50	39000.060.030	10X110MM	10	39000.100.110
2.5X40MM	50	39000.025.040	6X40MM	25	39000.060.040	10X120MM	10	39000.100.120
2.5X50MM	50	39000.025.050	6X50MM	25	39000.060.050	10X140MM	10	39000.100.140
3X12MM	100	39000.030.012	6X60MM	25	39000.060.060	10X150MM	10	39000.100.150
3X14MM	100	39000.030.014	6X70MM	25	39000.060.070	10X160MM	10	39000.100.160
3X16MM	100	39000.030.016	6X80MM	25	39000.060.080	12X40MM	10	39000.120.040
3X20MM	100	39000.030.020	6X100MM	10	39000.060.100	12X50MM	10	39000.120.050
3X24MM	100	39000.030.024	6X120MM	10	39000.060.120	12X60MM	10	39000.120.060
3X30MM	100	39000.030.030	6X140MM	10	39000.060.140	12X70MM	10	39000.120.070
3X36MM	50	39000.030.036	6,5X50MM	25	39000.065.050	12X80MM	10	39000.120.080
3X40MM	50	39000.030.040	6,5X60MM	25	39000.065.060	12X100MM	10	39000.120.100
3X50MM	50	39000.030.050	6,5X80MM	25	39000.065.080	12X120MM	10	39000.120.120
3X60MM	25	39000.030.060	6,5X100MM	10	39000.065.100	12X140MM	10	39000.120.140
4X16MM	100	39000.040.016	7X50MM	25	39000.070.050	12X160MM	10	39000.120.160
4X20MM	100	39000.040.020	7X60MM	25	39000.070.060	13X100MM	10	39000.130.100
4X24MM	100	39000.040.024	7X70MM	25	39000.070.070	13X120MM	10	39000.130.120
4X26MM	50	39000.040.026	7X80MM	10	39000.070.080	13X150MM	10	39000.130.150
4X30MM	50	39000.040.030	7X100MM	10	39000.070.100	14X90MM	10	39000.140.090
4X36MM	50	39000.040.036	8X30MM	25	39000.080.030	16X50MM	5	39000.160.050
4X40MM	50	39000.040.040	8X36MM	25	39000.080.036	16X60MM	5	39000.160.060
4X50MM	50	39000.040.050	8X40MM	25	39000.080.040	16X70MM	5	39000.160.070
4X60MM	25	39000.040.060	8X50MM	25	39000.080.050	16X80MM	5	39000.160.080
4X70MM	25	39000.040.070	8X60MM	25	39000.080.060	16X100MM	5	39000.160.100
4X80MM	25	39000.040.080	8X70MM	25	39000.080.070	16X120MM	5	39000.160.120
4X100MM	25	39000.040.100	8X80MM	10	39000.080.080	16X150MM	5	39000.160.150
5X20MM	100	39000.050.020	8X90MM	10	39000.080.090	16X180MM	5	39000.160.180
5X24MM	50	39000.050.024	8X100MM	10	39000.080.100	16X200MM	5	39000.160.200
5X26MM	50	39000.050.026	8X120MM	10	39000.080.120			
5X30MM	50	39000.050.030	8X140MM	10	39000.080.140			
5X40MM	50	39000.050.040	8X160MM	10	39000.080.160			

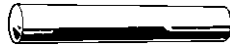
51560 Taper pin turned		R09A
Material	Stainless steel A1	
		
		

d ₁ x L	☒	Art.number	d ₁ x L	☒	Art.number	d ₁ x L	☒	Art.number
1X10MM	100	51560.010.010	3X20MM	100	51560.030.020	5X30MM	100	51560.050.030
1X12MM	100	51560.010.012	3X22MM*	100	51560.030.022	5X32MM*	100	51560.050.032
1.5X10MM*	200	51560.015.010	3X24MM	100	51560.030.024	5X36MM	100	51560.050.036
1.5X12MM*	200	51560.015.012	3X26MM*	100	51560.030.026	5X40MM	100	51560.050.040
2X8MM	100	51560.020.008	3X30MM	100	51560.030.030	5X45MM*	100	51560.050.045
2X10MM	100	51560.020.010	3X32MM*	100	51560.030.032	5X50MM*	100	51560.050.050
2X12MM	100	51560.020.012	3X40MM*	100	51560.030.040	5X55MM*	100	51560.050.055
2X16MM*	200	51560.020.016	3X45MM*	100	51560.030.045	5X60MM*	100	51560.050.060
2X20MM*	200	51560.020.020	3X50MM*	100	51560.030.050	5X70MM*	100	51560.050.070
2X24MM*	200	51560.020.024	4X10MM	100	51560.040.010	6X12MM	100	51560.060.012
2X26MM*	200	51560.020.026	4X12MM	100	51560.040.012	6X16MM	100	51560.060.016
2X30MM*	200	51560.020.030	4X16MM	100	51560.040.016	6X20MM	100	51560.060.020
2X36MM*	200	51560.020.036	4X20MM	100	51560.040.020	6X24MM	100	51560.060.024
2.5X10MM	100	51560.025.010	4X24MM	100	51560.040.024	6X25MM*	100	51560.060.025
2.5X16MM	100	51560.025.016	4X25MM*	100	51560.040.025	6X26MM*	100	51560.060.026
2.5X20MM	100	51560.025.020	4X26MM*	100	51560.040.026	6X30MM	50	51560.060.030
2.5X24MM	100	51560.025.024	4X28MM*	100	51560.040.028	6X32MM*	100	51560.060.032
2.5X36MM*	200	51560.025.036	4X30MM	100	51560.040.030	6X40MM	50	51560.060.040
3X6MM	100	51560.030.006	4X36MM	100	51560.040.036	6X45MM*	100	51560.060.045
3X8MM	100	51560.030.008	4X40MM*	100	51560.040.040	6X50MM	50	51560.060.050
3X10MM	100	51560.030.010	4X45MM*	100	51560.040.045	6X55MM*	100	51560.060.055
3X12MM	100	51560.030.012	4X50MM*	100	51560.040.050	6X60MM*	100	51560.060.060
3X14MM*	100	51560.030.014	4X60MM*	100	51560.040.060	6X70MM*	100	51560.060.070
3X16MM	100	51560.030.016	5X16MM	100	51560.050.016	6X80MM*	100	51560.060.080
3X18MM*	100	51560.030.018	5X20MM	100	51560.050.020	6X100MM*	100	51560.060.100
			5X24MM	100	51560.050.024	8X16MM	50	51560.080.016
			5X26MM*	100	51560.050.026	8X24MM	50	51560.080.024

51560		Taper pin turned							
d ₁ x L	☒	Art.number	d ₁ x L	☒	Art.number	d ₁ x L	☒	Art.number	
8X30MM	50	51560.080.030	8X80MM*	50	51560.080.080	10X45MM*	25	51560.100.045	
8X36MM	50	51560.080.036	8X90MM*	50	51560.080.090	10X50MM	25	51560.100.050	
8X40MM	50	51560.080.040	8X100MM*	50	51560.080.100	10X55MM*	25	51560.100.055	
8X45MM*	50	51560.080.045				10X60MM	25	51560.100.060	
8X50MM	25	51560.080.050	10X24MM	50	51560.100.024	10X70MM	25	51560.100.070	
8X55MM*	50	51560.080.055	10X30MM	50	51560.100.030	10X80MM	25	51560.100.080	
8X60MM	25	51560.080.060	10X36MM*	25	51560.100.036	10X100MM*	25	51560.100.100	
8X70MM*	50	51560.080.070	10X40MM	25	51560.100.040				

Parallel pin (dowel pin)

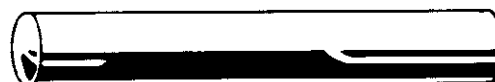
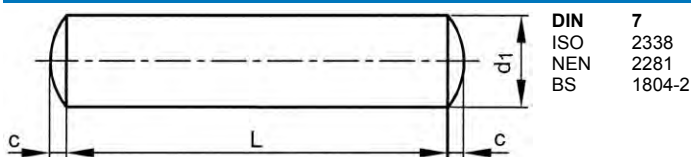

Technical Data

d ₁ (m6)	c (max.)	d ₁ (m6)	c (max.)
1	0.15	6	0.9
1.5	0.23	8	1.2
2	0.3	10	1.5
2.5	0.4	12	1.8
3	0.45	14	2
4	0.6	16	2.5
5	0.75	20	3

- Parallel pins are designed for the fastening of two or more individual elements. A friction type connection can be achieved by the selection of suitable fits. If such connection is meant to be disconnected repeatedly, then it becomes preferable to use taper pins in accordance with DIN 1.
- d x L: The nominal length (L) does not include the rounded ends.

Article groups

Material	Code	Page
Free-cutting steel	39070	9-5
St.St. A1/A2	51580	9-6
St.St. A4	55580	9-7

39070		Parallel pin (dowel pin)				L11A	
Material	Free-cutting steel						

d ₁ x L	☒	Art.number	d ₁ x L	☒	Art.number	d ₁ x L	☒	Art.number
2X10MM	200	39070.020.010	3X28MM	100	39070.030.028	5X18MM	100	39070.050.018
2X12MM	200	39070.020.012	3X30MM	100	39070.030.030	5X20MM	100	39070.050.020
2X14MM	200	39070.020.014				5X22MM	100	39070.050.022
2X16MM	200	39070.020.016	4X8MM	100	39070.040.008	5X24MM	100	39070.050.024
2X18MM	200	39070.020.018	4X10MM	100	39070.040.010	5X28MM	100	39070.050.028
2X20MM	200	39070.020.020	4X12MM	100	39070.040.012	5X30MM	100	39070.050.030
2X24MM	200	39070.020.024	4X14MM	100	39070.040.014	5X32MM	100	39070.050.032
			4X16MM	100	39070.040.016	5X36MM	100	39070.050.036
2.5X10MM	200	39070.025.010	4X18MM	100	39070.040.018	5X40MM	50	39070.050.040
2.5X12MM	200	39070.025.012	4X20MM	100	39070.040.020	5X45MM	50	39070.050.045
2.5X14MM	200	39070.025.014	4X24MM	100	39070.040.024	5X50MM	50	39070.050.050
2.5X16MM	200	39070.025.016	4X28MM	100	39070.040.028	5X60MM	50	39070.050.060
2.5X20MM	200	39070.025.020	4X30MM	100	39070.040.030	5X70MM	50	39070.050.070
			4X36MM	100	39070.040.036			
3X10MM	200	39070.030.010	4X40MM	100	39070.040.040	6X10MM	100	39070.060.010
3X12MM	200	39070.030.012	4X50MM	100	39070.040.050	6X12MM	100	39070.060.012
3X14MM	200	39070.030.014	4X60MM	100	39070.040.060	6X14MM	100	39070.060.014
3X16MM	200	39070.030.016				6X16MM	100	39070.060.016
3X18MM	200	39070.030.018	5X10MM	100	39070.050.010	6X18MM	100	39070.060.018
3X20MM	200	39070.030.020	5X12MM	100	39070.050.012	6X20MM	100	39070.060.020
3X24MM	100	39070.030.024	5X14MM	100	39070.050.014	6X24MM	50	39070.060.024
3X26MM	100	39070.030.026	5X16MM	100	39070.050.016	6X28MM	50	39070.060.028

39070 Parallel pin (dowel pin) ←								
d ₁ x L	☒	Art.number	d ₁ x L	☒	Art.number	d ₁ x L	☒	Art.number
6X30MM	50	39070.060.030	8X36MM	50	39070.080.036	10X70MM	25	39070.100.070
6X32MM	50	39070.060.032	8X40MM	25	39070.080.040	10X80MM	25	39070.100.080
6X36MM	50	39070.060.036	8X50MM	25	39070.080.050	10X100MM	25	39070.100.100
6X40MM	50	39070.060.040	8X60MM	25	39070.080.060	10X120MM	25	39070.100.120
6X45MM	50	39070.060.045	8X70MM	25	39070.080.070			
6X50MM	50	39070.060.050	8X80MM	25	39070.080.080	12X24MM	25	39070.120.024
6X60MM	25	39070.060.060	8X100MM	25	39070.080.100	12X30MM	25	39070.120.030
6X70MM	25	39070.060.070	8X120MM	25	39070.080.120	12X32MM	25	39070.120.032
6X80MM	25	39070.060.080				12X36MM	25	39070.120.036
			10X16MM	25	39070.100.016	12X40MM	25	39070.120.040
8X10MM	50	39070.080.010	10X18MM	25	39070.100.018	12X45MM	25	39070.120.045
8X12MM	50	39070.080.012	10X20MM	25	39070.100.020	12X50MM	10	39070.120.050
8X14MM	50	39070.080.014	10X24MM	25	39070.100.024	12X60MM	10	39070.120.060
8X16MM	50	39070.080.016	10X28MM	25	39070.100.028	12X70MM	10	39070.120.070
8X18MM	50	39070.080.018	10X30MM	25	39070.100.030	12X80MM	10	39070.120.080
8X20MM	50	39070.080.020	10X32MM	25	39070.100.032	12X100MM	10	39070.120.100
8X24MM	50	39070.080.024	10X36MM	25	39070.100.036	12X120MM	10	39070.120.120
8X28MM	50	39070.080.028	10X40MM	25	39070.100.040			
8X30MM	50	39070.080.030	10X50MM	25	39070.100.050	16X50MM	10	39070.160.050
8X32MM	50	39070.080.032	10X60MM	25	39070.100.060			

51580 Parallel pin (dowel pin)		R09A
Material	Stainless steel A1/A2	
		

d ₁ x L	☒	Art.number	d ₁ x L	☒	Art.number	d ₁ x L	☒	Art.number
1X3MM*	500	51580.010.003				5X36MM	100	51580.050.036
1X4MM	100	51580.010.004	3X4MM*	200	51580.030.004	5X40MM	100	51580.050.040
1X5MM	100	51580.010.005	3X5mm*	200	51580.030.005	5X45MM	50	51580.050.045
1X6MM	100	51580.010.006	3X6MM	100	51580.030.006	5X50MM	50	51580.050.050
1X8MM	100	51580.010.008	3X8MM	100	51580.030.008	5X60MM	50	51580.050.060
1X10MM	100	51580.010.010	3X10MM	100	51580.030.010			
1X12MM	100	51580.010.012	3X12MM	100	51580.030.012	6X6MM*	100	51580.060.006
1X14MM*	500	51580.010.014	3X14MM	100	51580.030.014	6X8MM*	100	51580.060.008
1X16MM*	500	51580.010.016	3X16MM	100	51580.030.016	6X10MM	100	51580.060.010
1X20MM*	500	51580.010.020	3X18MM	100	51580.030.018	6X12MM	100	51580.060.012
			3X20MM	100	51580.030.020	6X14MM	100	51580.060.014
1.5X3MM*	500	51580.015.003	3X24MM	100	51580.030.024	6X16MM	100	51580.060.016
1.5X4MM	100	51580.015.004	3X28MM	100	51580.030.028	6X18MM	100	51580.060.018
1.5X5MM	100	51580.015.005	3X30MM	100	51580.030.030	6X20MM	100	51580.060.020
1.5X6MM	100	51580.015.006	3X32MM	100	51580.030.032	6X24MM	100	51580.060.024
1.5X8MM	100	51580.015.008	3X36MM	100	51580.030.036	6X28MM	50	51580.060.028
1.5X10MM	100	51580.015.010	3X40MM	100	51580.030.040	6X30MM	50	51580.060.030
1.5X12MM	100	51580.015.012	3X65MM*	500	51580.030.065	6X32MM	50	51580.060.032
1.5X14MM	100	51580.015.014				6X36MM	50	51580.060.036
1.5X16MM	100	51580.015.016	4X5MM*	200	51580.040.005	6X40MM	50	51580.060.040
1.5X18MM	100	51580.015.018	4X6MM	100	51580.040.006	6X45MM	50	51580.060.045
1.5X20MM	100	51580.015.020	4X8MM	100	51580.040.008	6X50MM	50	51580.060.050
			4X10MM	100	51580.040.010	6X55MM*	100	51580.060.055
2X4MM*	500	51580.020.004	4X12MM	100	51580.040.012	6X60MM	50	51580.060.060
2X5MM	100	51580.020.005	4X14MM	100	51580.040.014	6X70MM	25	51580.060.070
2X6MM	100	51580.020.006	4X16MM	100	51580.040.016	6X80MM	25	51580.060.080
2X8MM	100	51580.020.008	4X18MM	100	51580.040.018	6X90MM*	100	51580.060.090
2X10MM	100	51580.020.010	4X20MM	100	51580.040.020			
2X12MM	100	51580.020.012	4X24MM	100	51580.040.024	8X8MM	100	51580.080.008
2X14MM	100	51580.020.014	4X28MM	100	51580.040.028	8X10MM	100	51580.080.010
2X16MM	100	51580.020.016	4X30MM	100	51580.040.030	8X12MM	100	51580.080.012
2X18MM	100	51580.020.018	4X32MM	100	51580.040.032	8X14MM	100	51580.080.014
2X20MM	100	51580.020.020	4X36MM	100	51580.040.036	8X16MM	100	51580.080.016
2X24MM	100	51580.020.024	4X40MM	100	51580.040.040	8X18MM	50	51580.080.018
2X28MM	100	51580.020.028	4X50MM	100	51580.040.050	8X20MM	100	51580.080.020
2X32MM	100	51580.020.032	4X60MM*	200	51580.040.060	8X24MM	50	51580.080.024
						8X28MM	50	51580.080.028
2.5X4MM*	500	51580.025.004	5X5MM*	100	51580.050.005	8X30MM	50	51580.080.030
2.5X5MM	100	51580.025.005	5X6MM	100	51580.050.006	8X32MM	50	51580.080.032
2.5X6MM	100	51580.025.006	5X8MM	100	51580.050.008	8X36MM	50	51580.080.036
2.5X8MM	100	51580.025.008	5X10MM	100	51580.050.010	8X40MM	50	51580.080.040
2.5X10MM	100	51580.025.010	5X12MM	100	51580.050.012	8X45MM	25	51580.080.045
2.5X12MM	100	51580.025.012	5X14MM	100	51580.050.014	8X50MM	25	51580.080.050
2.5X14MM	100	51580.025.014	5X16MM	100	51580.050.016	8X55MM	25	51580.080.055
2.5X16MM	100	51580.025.016	5X18MM	100	51580.050.018	8X60MM	25	51580.080.060
2.5X18MM*	500	51580.025.018	5X20MM	100	51580.050.020	8X70MM	25	51580.080.070
2.5X20MM	100	51580.025.020	5X24MM	100	51580.050.024	8X80MM	25	51580.080.080
2.5X24MM	100	51580.025.024	5X28MM	100	51580.050.028	8X90MM*	100	51580.080.090
2.5X28MM*	500	51580.025.028	5X30MM	100	51580.050.030			
2.5X32MM*	500	51580.025.032	5X32MM	100	51580.050.032	10X10MM*	50	51580.100.010

51580 Parallel pin (dowel pin) ←								
d ₁ x L	☒	Art.number	d ₁ x L	☒	Art.number	d ₁ x L	☒	Art.number
10X12MM	25	51580.100.012	12X32MM	25	51580.120.032	16X36MM	25	51580.160.036
10X14MM	25	51580.100.014	12X36MM	25	51580.120.036	16X40MM	25	51580.160.040
10X16MM	50	51580.100.016	12X40MM	25	51580.120.040	16X45MM	10	51580.160.045
10X18MM	25	51580.100.018	12X45MM	10	51580.120.045	16X50MM	10	51580.160.050
10X20MM	50	51580.100.020	12X50MM	10	51580.120.050	16X55MM	10	51580.160.055
10X24MM	50	51580.100.024	12X55MM	10	51580.120.055	16X60MM	10	51580.160.060
10X28MM	25	51580.100.028	12X60MM	10	51580.120.060	16X70MM	10	51580.160.070
10X30MM	50	51580.100.030	12X70MM	10	51580.120.070	16X80MM	10	51580.160.080
10X32MM	25	51580.100.032	12X80MM	10	51580.120.080	16X90MM*	25	51580.160.090
10X36MM	25	51580.100.036	12X90MM	10	51580.120.090	16X100MM*	25	51580.160.100
10X40MM	25	51580.100.040	12X100MM	10	51580.120.100			
10X45MM	25	51580.100.045				20X20MM*	10	51580.200.020
10X50MM	25	51580.100.050	14X20MM	25	51580.140.020	20X24MM*	10	51580.200.024
10X55MM	25	51580.100.055	14X24MM	25	51580.140.024	20X30MM*	10	51580.200.030
10X60MM	25	51580.100.060	14X28MM	25	51580.140.028	20X32MM*	10	51580.200.032
10X70MM	25	51580.100.070	14X32MM	25	51580.140.032	20X36MM*	10	51580.200.036
10X80MM	25	51580.100.080	14X36MM	25	51580.140.036	20X40MM*	10	51580.200.040
10X90MM	25	51580.100.090	14X40MM	25	51580.140.040	20X45MM*	10	51580.200.045
10X100MM	25	51580.100.100	14X50MM	10	51580.140.050	20X50MM*	10	51580.200.050
			14X100MM	10	51580.140.100	20X55MM*	10	51580.200.055
12X16MM*	25	51580.120.016				20X60MM*	10	51580.200.060
12X18MM*	25	51580.120.018	16X20MM*	25	51580.160.020	20X70MM*	10	51580.200.070
12X20MM	25	51580.120.020	16X24MM	25	51580.160.024	20X80MM*	10	51580.200.080
12X24MM*	25	51580.120.024	16X28MM	25	51580.160.028	20X90MM*	10	51580.200.090
12X28MM*	25	51580.120.028	16X30MM*	25	51580.160.030	20X100MM*	10	51580.200.100
12X30MM*	25	51580.120.030	16X32MM	25	51580.160.032			

* Depending on availability A1 can be supplied as well as A2.

55580 Parallel pin (dowel pin)		R49A
Material	Stainless steel A4	
		 

d ₁ x L	☒	Art.number	d ₁ x L	☒	Art.number	d ₁ x L	☒	Art.number
1X3MM*	500	55580.010.003	2,5X32MM*	500	55580.025.032	5X16MM	100	55580.050.016
1X4MM*	500	55580.010.004				5X18MM	100	55580.050.018
1X5MM	100	55580.010.005	3X4MM*	200	55580.030.004	5X20MM	100	55580.050.020
1X6MM*	500	55580.010.006	3X5MM*	200	55580.030.005	5X24MM	100	55580.050.024
1X8MM	100	55580.010.008	3X6MM*	200	55580.030.006	5X28MM	100	55580.050.028
1X10MM*	500	55580.010.010	3X8MM	100	55580.030.008	5X30MM	100	55580.050.030
1X16MM*	500	55580.010.016	3X10MM	100	55580.030.010	5X32MM	100	55580.050.032
			3X12MM	100	55580.030.012	5X36MM	100	55580.050.036
1,5X3MM*	500	55580.015.003	3X14MM	100	55580.030.014	5X40MM	100	55580.050.040
1,5X4MM*	500	55580.015.004	3X16MM	100	55580.030.016	5X45MM	50	55580.050.045
1,5X5MM	100	55580.015.005	3X18MM	100	55580.030.018	5X50MM	50	55580.050.050
1,5X6MM	100	55580.015.006	3X20MM	100	55580.030.020	5X60MM	50	55580.050.060
1,5X8MM	100	55580.015.008	3X24MM	100	55580.030.024			
1,5X10MM	100	55580.015.010	3X28MM	100	55580.030.028	6X6MM*	100	55580.060.006
1,5X12MM	100	55580.015.012	3X30MM	100	55580.030.030	6X8MM*	100	55580.060.008
1,5X14MM	100	55580.015.014	3X32MM	100	55580.030.032	6X10MM	100	55580.060.010
1,5X16MM	100	55580.015.016	3X36MM	100	55580.030.036	6X12MM	100	55580.060.012
			3X40MM	100	55580.030.040	6X14MM	100	55580.060.014
2X4MM*	500	55580.020.004				6X16MM	100	55580.060.016
2X5MM*	500	55580.020.005	4X5MM*	200	55580.040.005	6X18MM	100	55580.060.018
2X6MM	100	55580.020.006	4X6MM*	200	55580.040.006	6X20MM	100	55580.060.020
2X8MM	100	55580.020.008	4X8MM	100	55580.040.008	6X24MM	100	55580.060.024
2X10MM	100	55580.020.010	4X10MM	100	55580.040.010	6X28MM	50	55580.060.028
2X12MM	100	55580.020.012	4X12MM	100	55580.040.012	6X30MM	50	55580.060.030
2X14MM	100	55580.020.014	4X14MM	100	55580.040.014	6X32MM	50	55580.060.032
2X16MM	100	55580.020.016	4X16MM	100	55580.040.016	6X36MM	50	55580.060.036
2X18MM	100	55580.020.018	4X18MM	100	55580.040.018	6X40MM	50	55580.060.040
2X20MM	100	55580.020.020	4X20MM	100	55580.040.020	6X45MM	50	55580.060.045
2X24MM*	500	55580.020.024	4X24MM	100	55580.040.024	6X50MM	50	55580.060.050
2X32MM*	500	55580.020.032	4X28MM	100	55580.040.028	6X55MM*	100	55580.060.055
			4X30MM	100	55580.040.030	6X60MM	50	55580.060.060
2,5X4MM*	500	55580.025.004	4X32MM	100	55580.040.032	6X70MM*	100	55580.060.070
2,5X5MM*	500	55580.025.005	4X36MM	100	55580.040.036			
2,5X6MM	100	55580.025.006	4X40MM	100	55580.040.040	8X8MM*	100	55580.080.008
2,5X8MM	100	55580.025.008	4X50MM	100	55580.040.050	8X10MM	100	55580.080.010
2,5X10MM	100	55580.025.010				8X12MM	100	55580.080.012
2,5X12MM	100	55580.025.012	5X5MM*	100	55580.050.005	8X14MM	100	55580.080.014
2,5X14MM	100	55580.025.014	5X6MM*	100	55580.050.006	8X16MM	100	55580.080.016
2,5X16MM	100	55580.025.016	5X8MM	100	55580.050.008	8X18MM	50	55580.080.018
2,5X20MM	100	55580.025.020	5X10MM	100	55580.050.010	8X20MM	100	55580.080.020
2,5X24MM*	500	55580.025.024	5X12MM	100	55580.050.012	8X24MM	50	55580.080.024
2,5X28MM*	500	55580.025.028	5X14MM	100	55580.050.014	8X28MM	50	55580.080.028

55580 Parallel pin (dowel pin) ←								
$d_1 \times L$	☒	Art.number	$d_1 \times L$	☒	Art.number	$d_1 \times L$	☒	Art.number
8X30MM	50	55580.080.030	10X40MM	25	55580.100.040	12X60MM	10	55580.120.060
8X32MM	50	55580.080.032	10X45MM	25	55580.100.045	12X70MM*	25	55580.120.070
8X36MM	50	55580.080.036	10X50MM	25	55580.100.050	12X80MM	10	55580.120.080
8X40MM	50	55580.080.040	10X55MM	25	55580.100.055	12X90MM	10	55580.120.090
8X45MM	25	55580.080.045	10X60MM	25	55580.100.060	12X100MM	10	55580.120.100
8X50MM	25	55580.080.050	10X70MM	25	55580.100.070			
8X55MM*	100	55580.080.055	10X80MM	25	55580.100.080	16X24MM*	25	55580.160.024
8X60MM	25	55580.080.060	10X90MM	25	55580.100.090	16X28MM*	25	55580.160.028
8X70MM	25	55580.080.070	10X100MM	25	55580.100.100	16X32MM*	25	55580.160.032
8X80MM	25	55580.080.080				16X36MM*	25	55580.160.036
			12X16MM	25	55580.120.016	16X40MM*	25	55580.160.040
10X12MM*	50	55580.100.012	12X18MM	25	55580.120.018	16X45MM*	25	55580.160.045
10X14MM	25	55580.100.014	12X20MM	25	55580.120.020	16X50MM*	25	55580.160.050
10X16MM	50	55580.100.016	12X24MM*	25	55580.120.024	16X55MM*	25	55580.160.055
10X18MM	25	55580.100.018	12X28MM*	25	55580.120.028	16X60MM*	25	55580.160.060
10X20MM	50	55580.100.020	12X32MM	25	55580.120.032	16X70MM*	25	55580.160.070
10X24MM	50	55580.100.024	12X36MM	25	55580.120.036	16X80MM*	25	55580.160.080
10X28MM	25	55580.100.028	12X40MM	25	55580.120.040	16X90MM*	25	55580.160.090
10X30MM	50	55580.100.030	12X45MM	10	55580.120.045	16X100MM*	25	55580.160.100
10X32MM	25	55580.100.032	12X50MM	10	55580.120.050			
10X36MM	25	55580.100.036	12X55MM	10	55580.120.055	20X100MM*	10	55580.200.100

Parallel pin (dowel pin) hardened tolerance zone m6

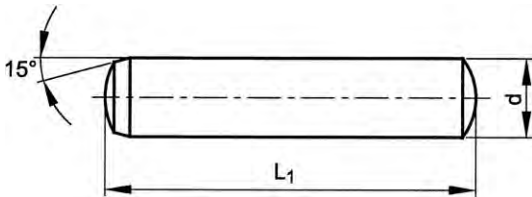

DIN 6325
ISO 8734 A
NEN 2282
NF E27-475



- Parallel pins are used mainly as dowels for tools, clamping devices and measuring devices.
- The nominal length (L_1) is inclusive the rounded ends (tolerance js14).

39080 Parallel pin (dowel pin) hardened tolerance zone m6		L11A
Material	Steel 60 ± 2HRc	

$d \times L_1$	☒	Art.number	$d \times L_1$	☒	Art.number	$d \times L_1$	☒	Art.number
1X4MM	100	39080.010.004	2X36MM	100	39080.020.036	3X40MM	100	39080.030.040
1X5MM	100	39080.010.005	2X40MM	100	39080.020.040	3X50MM	100	39080.030.050
1X6MM	100	39080.010.006				3X60MM	100	39080.030.060
1X8MM	100	39080.010.008	2,5X6MM	100	39080.025.006			
1X10MM	100	39080.010.010	2,5X8MM	100	39080.025.008	4X6MM	100	39080.040.006
1X12MM	100	39080.010.012	2,5X10MM	100	39080.025.010	4X8MM	100	39080.040.008
			2,5X12MM	100	39080.025.012	4X10MM	100	39080.040.010
1,5X5MM	100	39080.015.005	2,5X14MM	100	39080.025.014	4X12MM	100	39080.040.012
1,5X6MM	100	39080.015.006	2,5X16MM	100	39080.025.016	4X14MM	100	39080.040.014
1,5X8MM	100	39080.015.008	2,5X18MM	100	39080.025.018	4X16MM	100	39080.040.016
1,5X10MM	100	39080.015.010	2,5X20MM	100	39080.025.020	4X18MM	100	39080.040.018
1,5X12MM	100	39080.015.012	2,5X24MM	100	39080.025.024	4X20MM	100	39080.040.020
1,5X14MM	100	39080.015.014	2,5X28MM	100	39080.025.028	4X24MM	100	39080.040.024
1,5X16MM	100	39080.015.016	2,5X32MM	100	39080.025.032	4X26MM	100	39080.040.026
1,5X18MM	100	39080.015.018	2,5X36MM	100	39080.025.036	4X28MM	100	39080.040.028
1,5X20MM	100	39080.015.020	2,5X40MM	100	39080.025.040	4X30MM	100	39080.040.030
1,5X24MM	100	39080.015.024	2,5X45MM	100	39080.025.045	4X32MM	100	39080.040.032
1,5X28MM	100	39080.015.028	2,5X50MM	100	39080.025.050	4X36MM	100	39080.040.036
1,5X32MM	100	39080.015.032				4X40MM	100	39080.040.040
			3X6MM	100	39080.030.006	4X45MM	100	39080.040.045
2X5MM	100	39080.020.005	3X8MM	100	39080.030.008	4X50MM	100	39080.040.050
2X6MM	100	39080.020.006	3X10MM	100	39080.030.010	4X60MM	100	39080.040.060
2X8MM	100	39080.020.008	3X12MM	100	39080.030.012			
2X10MM	100	39080.020.010	3X14MM	100	39080.030.014	5X8MM	100	39080.050.008
2X12MM	100	39080.020.012	3X16MM	100	39080.030.016	5X10MM	100	39080.050.010
2X14MM	100	39080.020.014	3X18MM	100	39080.030.018	5X12MM	100	39080.050.012
2X16MM	100	39080.020.016	3X20MM	100	39080.030.020	5X14MM	100	39080.050.014
2X20MM	100	39080.020.020	3X24MM	100	39080.030.024	5X16MM	100	39080.050.016
2X24MM	100	39080.020.024	3X28MM	100	39080.030.028	5X18MM	100	39080.050.018
2X28MM	100	39080.020.028	3X30MM	100	39080.030.030	5X20MM	100	39080.050.020
2X30MM	100	39080.020.030	3X32MM	100	39080.030.032	5X24MM	100	39080.050.024
2X32MM	100	39080.020.032	3X36MM	100	39080.030.036	5X26MM	100	39080.050.026

39080 Parallel pin (dowel pin) hardened tolerance zone m6 ←								
d x L ₁	☒	Art.number	d x L ₁	☒	Art.number	d x L ₁	☒	Art.number
5X28MM	100	39080.050.028	8X30MM	50	39080.080.030	12X40MM	25	39080.120.040
5X30MM	100	39080.050.030	8X32MM	50	39080.080.032	12X45MM	25	39080.120.045
5X32MM	100	39080.050.032	8X36MM	50	39080.080.036	12X50MM	25	39080.120.050
5X36MM	100	39080.050.036	8X40MM	50	39080.080.040	12X55MM	25	39080.120.055
5X40MM	100	39080.050.040	8X45MM	50	39080.080.045	12X60MM	25	39080.120.060
5X45MM	50	39080.050.045	8X50MM	25	39080.080.050	12X70MM	25	39080.120.070
5X50MM	50	39080.050.050	8X55MM	25	39080.080.055	12X80MM	10	39080.120.080
5X55MM	50	39080.050.055	8X60MM	25	39080.080.060	12X90MM	10	39080.120.090
5X60MM	50	39080.050.060	8X70MM	25	39080.080.070	12X100MM	10	39080.120.100
			8X80MM	25	39080.080.080	12X120MM	10	39080.120.120
			8X90MM	25	39080.080.090			
6X8MM	100	39080.060.008	8X100MM	25	39080.080.100	14X32MM	25	39080.140.032
6X10MM	100	39080.060.010				14X36MM	25	39080.140.036
6X12MM	100	39080.060.012	10X12MM	50	39080.100.012	14X40MM	25	39080.140.040
6X14MM	100	39080.060.014	10X14MM	50	39080.100.014	14X50MM	25	39080.140.050
6X16MM	100	39080.060.016	10X16MM	50	39080.100.016	14X60MM	10	39080.140.060
6X18MM	100	39080.060.018	10X20MM	50	39080.100.020	14X80MM	10	39080.140.080
6X20MM	100	39080.060.020	10X24MM	50	39080.100.024	14X100MM	10	39080.140.100
6X24MM	100	39080.060.024	10X28MM	50	39080.100.028	14X120MM	10	39080.140.120
6X26MM	100	39080.060.026	10X30MM	50	39080.100.030			
6X28MM	100	39080.060.028	10X32MM	50	39080.100.032	16X36MM	10	39080.160.036
6X30MM	100	39080.060.030	10X36MM	25	39080.100.036	16X40MM	10	39080.160.040
6X32MM	50	39080.060.032	10X40MM	25	39080.100.040	16X50MM	10	39080.160.050
6X36MM	50	39080.060.036	10X45MM	25	39080.100.045	16X60MM	10	39080.160.060
6X40MM	50	39080.060.040	10X50MM	25	39080.100.050	16X80MM	10	39080.160.080
6X45MM	50	39080.060.045	10X55MM	25	39080.100.055	16X100MM	10	39080.160.100
6X50MM	50	39080.060.050	10X60MM	25	39080.100.060	16X120MM	10	39080.160.120
6X55MM	50	39080.060.055	10X70MM	25	39080.100.070			
6X60MM	50	39080.060.060	10X80MM	25	39080.100.080	20X30MM	100	39080.200.030
6X70MM	25	39080.060.070	10X90MM	25	39080.100.090	20X32MM	10	39080.200.032
6X80MM	25	39080.060.080	10X100MM	25	39080.100.100	20X36MM	10	39080.200.036
						20X40MM	10	39080.200.040
8X10MM	100	39080.080.010	12X16MM	25	39080.120.016	20X50MM	10	39080.200.050
8X12MM	100	39080.080.012	12X20MM	25	39080.120.020	20X60MM	10	39080.200.060
8X14MM	100	39080.080.014	12X24MM	25	39080.120.024	20X70MM	10	39080.200.070
8X16MM	100	39080.080.016	12X26MM	25	39080.120.026	20X80MM	10	39080.200.080
8X18MM	100	39080.080.018	12X28MM	25	39080.120.028	20X100MM	10	39080.200.100
8X20MM	100	39080.080.020	12X30MM	25	39080.120.030	20X120MM	10	39080.200.120
8X24MM	50	39080.080.024	12X32MM	25	39080.120.032			
8X26MM	50	39080.080.026	12X36MM	25	39080.120.036			
8X28MM	50	39080.080.028						

Parallel pin (dowel pin) hardened tolerance zone h6

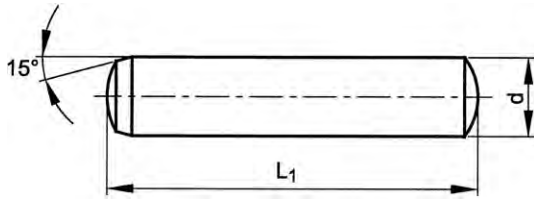

DIN ≈6325
 ISO ≈8734 A
 NEN ≈2282
 NF ≈E27-475



- Parallel pins are used mainly as dowels for tools, clamping devices and measuring devices.
- $d \times L_1$: The nominal length (L_1) is inclusive the rounded ends (tolerance js14).

39078	Parallel pin (dowel pin) hardened tolerance zone h6	L11A
Material	Steel 60 ± 2HRc	
		

$d \times L_1$	☒	Art.number	$d \times L_1$	☒	Art.number	$d \times L_1$	☒	Art.number
2X5MM	100	39078.020.005	4X40MM	100	39078.040.040	8X32MM	50	39078.080.032
2X6MM	100	39078.020.006	4X50MM	100	39078.040.050	8X36MM	50	39078.080.036
2X8MM	100	39078.020.008				8X40MM	50	39078.080.040
2X10MM	100	39078.020.010	5X8MM	100	39078.050.008	8X50MM	25	39078.080.050
2X12MM	100	39078.020.012	5X10MM	100	39078.050.010	8X60MM	25	39078.080.060
2X14MM	100	39078.020.014	5X12MM	100	39078.050.012	8X70MM	25	39078.080.070
2X16MM	100	39078.020.016	5X14MM	100	39078.050.014	8X80MM	25	39078.080.080
2X20MM	100	39078.020.020	5X16MM	100	39078.050.016			
2X24MM	100	39078.020.024	5X20MM	100	39078.050.020	10X20MM	50	39078.100.020
2X28MM	100	39078.020.028	5X24MM	100	39078.050.024	10X24MM	50	39078.100.024
			5X26MM	100	39078.050.026	10X28MM	50	39078.100.028
2.5X6MM	100	39078.025.006	5X28MM	100	39078.050.028	10X30MM	50	39078.100.030
2.5X8MM	100	39078.025.008	5X30MM	100	39078.050.030	10X32MM	50	39078.100.032
2.5X10MM	100	39078.025.010	5X32MM	100	39078.050.032	10X36MM	25	39078.100.036
2.5X16MM	100	39078.025.016	5X36MM	100	39078.050.036	10X40MM	25	39078.100.040
2.5X24MM	100	39078.025.024	5X40MM	100	39078.050.040	10X50MM	25	39078.100.050
			5X50MM	100	39078.050.050	10X60MM	25	39078.100.060
			5X60MM	100	39078.050.060	10X80MM	25	39078.100.080
3X6MM	100	39078.030.006				10X100MM	25	39078.100.100
3X8MM	100	39078.030.008						
3X10MM	100	39078.030.010	6X10MM	100	39078.060.010			
3X12MM	100	39078.030.012	6X12MM	100	39078.060.012	12X24MM	25	39078.120.024
3X14MM	100	39078.030.014	6X14MM	100	39078.060.014	12X32MM	25	39078.120.032
3X16MM	100	39078.030.016	6X16MM	100	39078.060.016	12X36MM	25	39078.120.036
3X20MM	100	39078.030.020	6X18MM	100	39078.060.018	12X40MM	25	39078.120.040
3X24MM	100	39078.030.024	6X20MM	100	39078.060.020	12X45MM	25	39078.120.045
3X28MM	100	39078.030.028	6X24MM	100	39078.060.024	12X50MM	25	39078.120.050
3X30MM	100	39078.030.030	6X26MM	100	39078.060.026	12X60MM	25	39078.120.060
3X32MM	100	39078.030.032	6X28MM	100	39078.060.028	12X80MM	10	39078.120.080
3X40MM	100	39078.030.040	6X30MM	100	39078.060.030	12X100MM	10	39078.120.100
			6X32MM	50	39078.060.032			
4X8MM	100	39078.040.008	6X36MM	50	39078.060.036	16X40MM	10	39078.160.040
4X10MM	100	39078.040.010	6X40MM	50	39078.060.040	16X50MM	10	39078.160.050
4X12MM	100	39078.040.012	6X45MM	50	39078.060.045	16X60MM	10	39078.160.060
4X14MM	100	39078.040.014	6X50MM	50	39078.060.050	16X80MM	10	39078.160.080
4X16MM	100	39078.040.016	6X60MM	50	39078.060.060	16X100MM	10	39078.160.100
4X18MM	100	39078.040.018						
4X20MM	100	39078.040.020	8X16MM	100	39078.080.016	20X40MM	10	39078.200.040
4X24MM	100	39078.040.024	8X20MM	100	39078.080.020	20X50MM	10	39078.200.050
4X28MM	100	39078.040.028	8X24MM	50	39078.080.024	20X60MM	10	39078.200.060
4X30MM	100	39078.040.030	8X28MM	50	39078.080.028	20X80MM	10	39078.200.080
4X32MM	100	39078.040.032	8X30MM	50	39078.080.030			

Taper pin with external thread

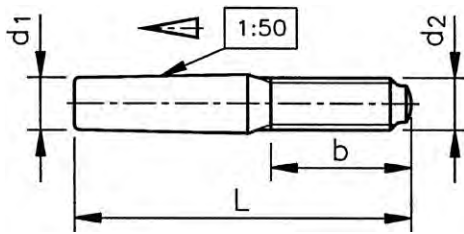

DIN 7977
ISO 8737
NEN 2462



Technical Data

d_1	b	d_2	d_1	b	d_2
5	14	M5	12	27	M12
6	18	M6	16	35	M16
8	22	M8	20	35	M16
10	24	M10			

- $d_1 \times L$: The nominal length (L) is inclusive the rounded ends (tolerance js15).

39011 Taper pin with external thread

L11A

Material Free-cutting steel

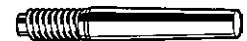

$d_1 \times L$	☒	Art.number	$d_1 \times L$	☒	Art.number	$d_1 \times L$	☒	Art.number
5X40MM	50	39011.050.040	8X75MM	10	39011.080.075	16X85MM	5	39011.160.085
5X45MM	50	39011.050.045	10X60MM	10	39011.100.060	16X100MM	5	39011.160.100
5X50MM	50	39011.050.050	10X65MM	10	39011.100.065	16X120MM	5	39011.160.120
6X45MM	25	39011.060.045	10X75MM	10	39011.100.075	16X140MM	5	39011.160.140
6X50MM	25	39011.060.050	10X85MM	10	39011.100.085	16X160MM	5	39011.160.160
6X55MM	25	39011.060.055	10X100MM	10	39011.100.100	20X100MM	5	39011.200.100
6X60MM	25	39011.060.060	12X75MM	5	39011.120.075	20X120MM	5	39011.200.120
8X55MM	10	39011.080.055	12X85MM	5	39011.120.085	20X140MM	5	39011.200.140
8X60MM	10	39011.080.060	12X100MM	5	39011.120.100	20X160MM	5	39011.200.160
8X65MM	10	39011.080.065	12X120MM	5	39011.120.120			

Taper pin with internal thread ground

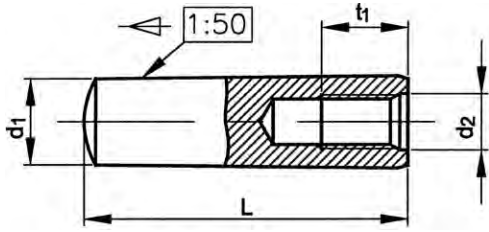

DIN 7978 A
 ISO 8736 A
 NEN 2463
 NF E27-479

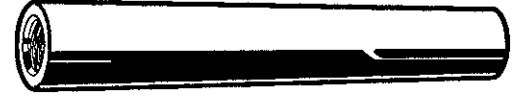

Technical Data

d ₁	d ₂	t ₁	d ₁	d ₂	t ₁
6	M4	6	12	M8	12
8	M5	8	16	M10	16
10	M6	10	20	M12	18

• d₁x L: The nominal length (L) is inclusive the rounded ends (tolerance js15).

39012 Taper pin with internal thread ground L11A

Material Free-cutting steel



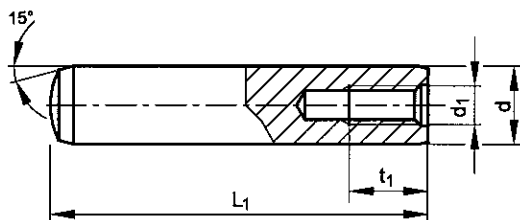

d ₁ x L	☒	Art.number	d ₁ x L	☒	Art.number	d ₁ x L	☒	Art.number
6X16MM	50	39012.060.016	8X50MM	10	39012.080.050	12X60MM	10	39012.120.060
6X24MM	50	39012.060.024	8X60MM	10	39012.080.060	12X70MM	10	39012.120.070
6X28MM	50	39012.060.028	8X70MM	10	39012.080.070	12X80MM	5	39012.120.080
6X30MM	50	39012.060.030				12X100MM	5	39012.120.100
6X32MM	25	39012.060.032	10X24MM	25	39012.100.024			
6X36MM	25	39012.060.036	10X28MM	25	39012.100.028	16X40MM	5	39012.160.040
6X40MM	25	39012.060.040	10X32MM	25	39012.100.032	16X50MM	5	39012.160.050
6X50MM	25	39012.060.050	10X40MM	10	39012.100.040	16X60MM	5	39012.160.060
6X60MM	25	39012.060.060	10X50MM	10	39012.100.050	16X80MM	5	39012.160.080
			10X60MM	10	39012.100.060	16X90MM	5	39012.160.090
8X20MM	50	39012.080.020	10X70MM	10	39012.100.070	16X100MM	5	39012.160.100
8X24MM	25	39012.080.024	10X80MM	10	39012.100.080	16X120MM	5	39012.160.120
8X28MM	25	39012.080.028	10X100MM	10	39012.100.100			
8X30MM	25	39012.080.030				20X60MM	5	39012.200.060
8X32MM	25	39012.080.032	12X32MM	10	39012.120.032	20X80MM	5	39012.200.080
8X36MM	25	39012.080.036	12X40MM	10	39012.120.040	20X100MM	5	39012.200.100
8X40MM	25	39012.080.040	12X50MM	10	39012.120.050	20X120MM	5	39012.200.120

Parallel pin with internal thread hardened

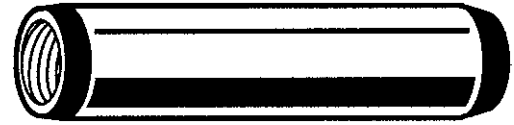

DIN 7979 D
ISO 8735 A
NEN 2464
NF E27-475



Technical Data

d (m6)	d ₁	t ₁	d (m6)	d ₁	t ₁
5 (#DIN)	M3	4	14	M8	12
6	M4	6	16	M8	12
8	M5	8	20	M10	16
10	M6	10	25	M16	24
12	M6	10	30	M20	30

- d x L₁: The nominal length (L₁) is inclusive the rounded ends (tolerance js15).

39090 Parallel pin with internal thread hardened

L11A

Material Steel 60 ± 2HRc



d x L ₁	☒	Art.number	d x L ₁	☒	Art.number	d x L ₁	☒	Art.number
5X12MM	100	39090.050.012	8X40MM	25	39090.080.040	12X50MM	10	39090.120.050
5X16MM	50	39090.050.016	8X45MM	25	39090.080.045	12X60MM	10	39090.120.060
5X20MM	50	39090.050.020	8X50MM	10	39090.080.050	12X70MM	10	39090.120.070
5X24MM	50	39090.050.024	8X60MM	10	39090.080.060	12X80MM	5	39090.120.080
5X28MM	50	39090.050.028	8X70MM	10	39090.080.070	12X100MM	5	39090.120.100
5X30MM	25	39090.050.030	8X80MM	50	39090.080.080			
5X32MM	25	39090.050.032				14X60MM	5	39090.140.060
5X36MM	25	39090.050.036	10X20MM	25	39090.100.020	16X32MM	5	39090.160.032
5X40MM	25	39090.050.040	10X24MM	25	39090.100.024	16X40MM	5	39090.160.040
			10X28MM	25	39090.100.028	16X50MM	5	39090.160.050
6X16MM	50	39090.060.016	10X30MM	25	39090.100.030	16X60MM	5	39090.160.060
6X20MM	50	39090.060.020	10X32MM	25	39090.100.032	16X70MM	5	39090.160.070
6X24MM	50	39090.060.024	10X36MM	10	39090.100.036	16X80MM	5	39090.160.080
6X28MM	50	39090.060.028	10X40MM	10	39090.100.040	16X90MM	5	39090.160.090
6X30MM	50	39090.060.030	10X45MM	10	39090.100.045	16X100MM	5	39090.160.100
6X32MM	25	39090.060.032	10X50MM	10	39090.100.050	16X120MM	5	39090.160.120
6X40MM	25	39090.060.040	10X60MM	10	39090.100.060			
6X45MM	25	39090.060.045	10X70MM	10	39090.100.070	20X50MM	5	39090.200.050
6X50MM	25	39090.060.050	10X80MM	10	39090.100.080	20X60MM	5	39090.200.060
6X60MM	25	39090.060.060	10X100MM	10	39090.100.100	20X70MM	5	39090.200.070
						20X80MM	5	39090.200.080
8X16MM	50	39090.080.016	12X24MM	10	39090.120.024	20X100MM	5	39090.200.100
8X20MM	50	39090.080.020	12X28MM	10	39090.120.028	20X120MM	5	39090.200.120
8X24MM	25	39090.080.024	12X30MM	10	39090.120.030			
8X28MM	25	39090.080.028	12X32MM	10	39090.120.032	25X60MM	5	39090.250.060
8X30MM	25	39090.080.030	12X36MM	10	39090.120.036	25X70MM	5	39090.250.070
8X32MM	25	39090.080.032	12X40MM	10	39090.120.040			
8X36MM	25	39090.080.036	12X45MM	10	39090.120.045			

Grooved pin, full length parallel grooved with pilot

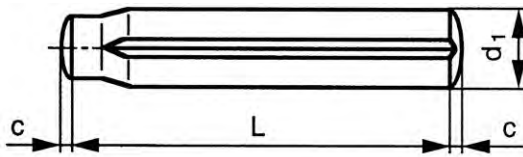

DIN 1470
ISO 8739
NEN 2601



Technical Data

d_1	$c \approx$	Tolerance	V	d_1	$c \approx$	Tolerance	V
1.5	0.2	h9	1.6	4	0.5	h11	10.6
2	0.25	h9	2.85	5	0.6	h11	16.5
2.5	0.3	h9	4.25	6	0.8	h11	22.8
3	0.4	h9	6.15	8	1	h11	40.5

- V = Shear strength double min. in kN.
- For the hole diameter d_1 (nom.) with tolerance field H11 is recommended.
- The nominal length (L) does not include the rounded ends (tolerance js15).

Examples of application

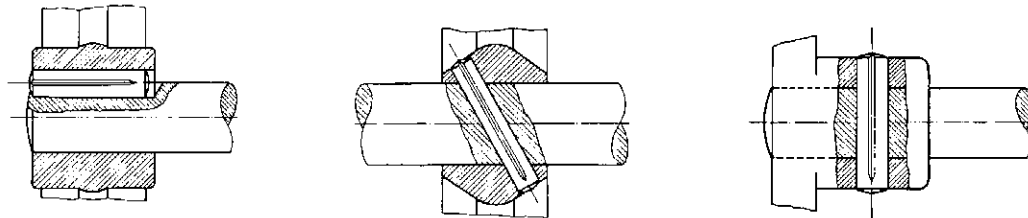

39700 Grooved pin, full length parallel grooved with pilot

L11F

Material Free-cutting steel

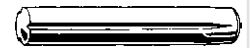

$d_1 \times L$	☒	Art.number	$d_1 \times L$	☒	Art.number	$d_1 \times L$	☒	Art.number
1,5X4MM	200	39700.015.004	3X20MM	200	39700.030.020	6X16MM	100	39700.060.016
1,5X6MM	200	39700.015.006	3X30MM	200	39700.030.030	6X20MM	100	39700.060.020
1,5X8MM	200	39700.015.008				6X24MM	100	39700.060.024
1,5X10MM	200	39700.015.010	4X8MM	200	39700.040.008	6X30MM	100	39700.060.030
1,5X16MM	200	39700.015.016	4X10MM	200	39700.040.010	6X36MM	100	39700.060.036
			4X12MM	200	39700.040.012	6X40MM	100	39700.060.040
2X5MM	200	39700.020.005	4X16MM	200	39700.040.016	6X45MM	100	39700.060.045
2X6MM	200	39700.020.006	4X20MM	200	39700.040.020	6X50MM	100	39700.060.050
2X8MM	200	39700.020.008	4X24MM	200	39700.040.024	6X60MM	100	39700.060.060
2X10MM	200	39700.020.010	4X30MM	200	39700.040.030			
2X16MM	200	39700.020.016	4X36MM	100	39700.040.036	8X12MM	100	39700.080.012
2X20MM	200	39700.020.020	4X40MM	100	39700.040.040	8X16MM	100	39700.080.016
2X24MM	200	39700.020.024				8X20MM	100	39700.080.020
			5X12MM	200	39700.050.012	8X24MM	100	39700.080.024
2,5X10MM	200	39700.025.010	5X16MM	200	39700.050.016	8X30MM	100	39700.080.030
2,5X12MM	200	39700.025.012	5X20MM	100	39700.050.020	8X36MM	50	39700.080.036
2,5X16MM	200	39700.025.016	5X24MM	100	39700.050.024	8X40MM	50	39700.080.040
2,5X20MM	200	39700.025.020	5X30MM	100	39700.050.030	8X45MM	50	39700.080.045
			5X36MM	100	39700.050.036	8X50MM	50	39700.080.050
			5X40MM	100	39700.050.040	8X60MM	50	39700.080.060
3X10MM	200	39700.030.010				8X70MM	50	39700.080.070
3X12MM	200	39700.030.012						
3X16MM	200	39700.030.016	6X10MM	100	39700.060.010			

Grooved pin, full length taper grooved

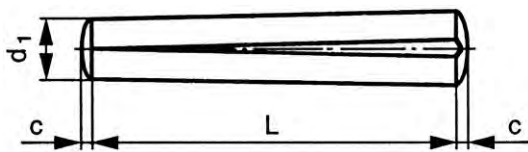

DIN 1471
ISO 8744
NEN 2602

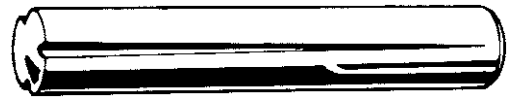

Technical Data

d ₁	c ≈	Tolerance	V	d ₁	c ≈	Tolerance	V
1.5	0.2	h9	1.6	4	0.5	h11	10.6
2	0.25	h9	2.85	5	0.63	h11	16.5
2.5	0.3	h9	4.25	6	0.8	h11	22.8
3	0.4	h9	6.15	8	1	h11	40.5

- V = Shear strength double min. in kN.
- For the hole diameter d₁ (nom.) with tolerance field H11 is recommended.
- The nominal length (L) does not include the rounded ends (tolerance js15).

Examples of application

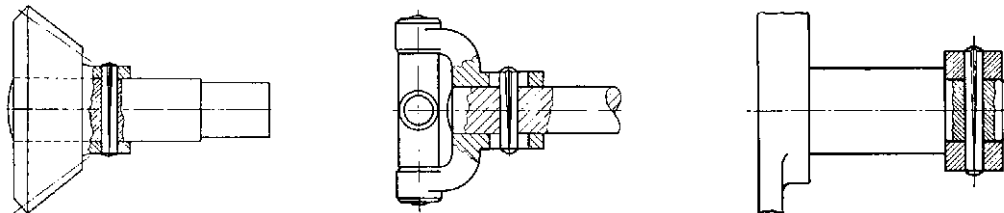

Article groups

Material	Code	Page
Free-cutting steel	39710	9-15
St.St. A1	51585	9-16

39710	Grooved pin, full length taper grooved	L11F
Material	Free-cutting steel	

d ₁ x L	Art.number	d ₁ x L	Art.number	d ₁ x L	Art.number
1,5X4MM	200 39710.015.004	3X6MM	200 39710.030.006	5X30MM	100 39710.050.030
1,5X5MM	200 39710.015.005	3X8MM	200 39710.030.008	5X36MM	100 39710.050.036
1,5X8MM	200 39710.015.008	3X10MM	200 39710.030.010	5X40MM	100 39710.050.040
1,5X10MM	200 39710.015.010	3X12MM	200 39710.030.012	6X10MM	100 39710.060.010
1,5X16MM	200 39710.015.016	3X16MM	200 39710.030.016	6X12MM	100 39710.060.012
1,5X20MM	200 39710.015.020	3X20MM	200 39710.030.020	6X16MM	100 39710.060.016
2X5MM	200 39710.020.005	3X24MM	200 39710.030.024	6X20MM	100 39710.060.020
2X6MM	200 39710.020.006	4X8MM	200 39710.040.008	6X24MM	100 39710.060.024
2X8MM	200 39710.020.008	4X10MM	200 39710.040.010	6X30MM	100 39710.060.030
2X10MM	200 39710.020.010	4X12MM	200 39710.040.012	6X40MM	100 39710.060.040
2X12MM	200 39710.020.012	4X16MM	200 39710.040.016	6X45MM	100 39710.060.045
2X16MM	200 39710.020.016	4X20MM	200 39710.040.020	6X50MM	100 39710.060.050
2X20MM	200 39710.020.020	4X24MM	200 39710.040.024	6X60MM	100 39710.060.060
2X24MM	200 39710.020.024	4X30MM	200 39710.040.030	8X12MM	100 39710.080.012
2X30MM	200 39710.020.030	4X36MM	100 39710.040.036	8X16MM	100 39710.080.016
2,5X6MM	200 39710.025.006	4X40MM	100 39710.040.040	8X20MM	100 39710.080.020
2,5X8MM	200 39710.025.008	5X10MM	200 39710.050.010	8X24MM	100 39710.080.024
2,5X10MM	200 39710.025.010	5X12MM	200 39710.050.012	8X30MM	100 39710.080.030
2,5X12MM	200 39710.025.012	5X16MM	200 39710.050.016	8X40MM	50 39710.080.040
2,5X16MM	200 39710.025.016	5X20MM	100 39710.050.020	8X50MM	50 39710.080.050
2,5X20MM	200 39710.025.020	5X24MM	100 39710.050.024	8X60MM	50 39710.080.060
2,5X30MM	200 39710.025.030			8X70MM	50 39710.080.070

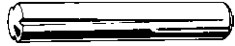
51585	Grooved pin, full length taper grooved	R09A
Material	Stainless steel A1	
		
		

$d_1 \times L$	☒	Art.number	$d_1 \times L$	☒	Art.number	$d_1 \times L$	☒	Art.number
2X8MM*	500	51585.020.008	4X8MM*	200	51585.040.008	5X35MM*	200	51585.050.035
2X10MM*	500	51585.020.010	4X12MM*	200	51585.040.012	5X40MM*	200	51585.050.040
2X12MM*	500	51585.020.012	4X16MM*	200	51585.040.016	6X10MM*	100	51585.060.010
2X16MM*	500	51585.020.016	4X20MM*	200	51585.040.020	6X12MM*	100	51585.060.012
2X20MM*	500	51585.020.020	4X25MM*	200	51585.040.025	6X16MM*	100	51585.060.016
2.5X20MM*	500	51585.025.020	4X40MM*	200	51585.040.040	6X20MM*	100	51585.060.020
3X8MM*	500	51585.030.008	5X8MM*	200	51585.050.008	6X25MM*	100	51585.060.025
3X10MM*	500	51585.030.010	5X10MM*	200	51585.050.010	6X30MM*	100	51585.060.030
3X12MM*	500	51585.030.012	5X12MM*	200	51585.050.012	6X40MM*	100	51585.060.040
3X16MM*	500	51585.030.016	5X16MM*	200	51585.050.016	8X30MM*	50	51585.080.030
3X18MM*	500	51585.030.018	5X20MM*	200	51585.050.020	8X40MM*	50	51585.080.040
3X20MM*	500	51585.030.020	5X25MM*	200	51585.050.025	8X60MM*	50	51585.080.060
3X25MM*	500	51585.030.025	5X30MM*	200	51585.050.030			

Grooved pin, half length taper grooved

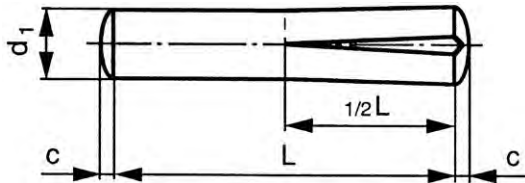

DIN 1472
ISO 8745
NEN 2603

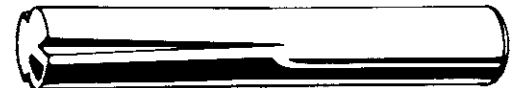

Technical Data

d_1	$c \approx$	Tolerance	V	d_1	$c \approx$	Tolerance	V
1.5	0.2	h9	1.6	4	0.5	h11	10.6
2	0.25	h9	2.85	5	0.6	h11	16.5
2.5	0.3	h9	4.25	6	0.8	h11	22.8
3	0.4	h9	6.15	8	1	h11	40.5

- V = Shear strength double min. in kN.
- For the hole diameter d_1 (nom.) with tolerance field H11 is recommended.
- The nominal length (L) does not include the rounded ends (tolerance js15).

Examples of application

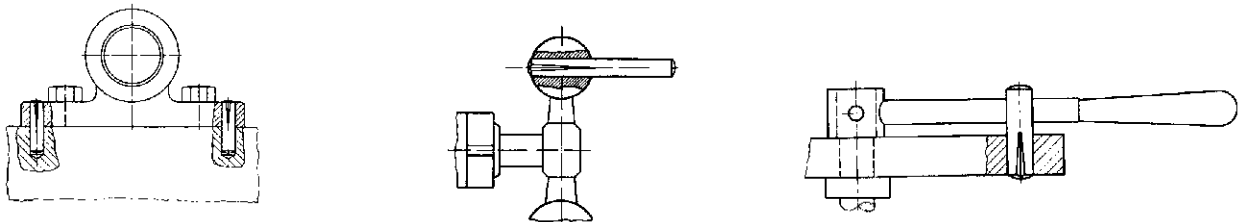

Article groups

Material	Code	Page
Free-cutting steel	39720	9-17
St.St. A1	51586	9-17

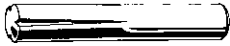
39720	Grooved pin, half length taper grooved	L11F
Material	Free-cutting steel	
		

d₁ x L	☒	Art.number	d₁ x L	☒	Art.number	d₁ x L	☒	Art.number
1,5X4MM	200	39720.015.004	3X20MM	200	39720.030.020	6X10MM	100	39720.060.010
1,5X6MM	200	39720.015.006	3X24MM	200	39720.030.024	6X12MM	100	39720.060.012
1,5X8MM	200	39720.015.008	3X30MM	200	39720.030.030	6X16MM	100	39720.060.016
1,5X12MM	200	39720.015.012				6X20MM	100	39720.060.020
1,5X16MM	200	39720.015.016	4X8MM	200	39720.040.008	6X24MM	100	39720.060.024
			4X10MM	200	39720.040.010	6X30MM	100	39720.060.030
2X6MM	200	39720.020.006	4X12MM	200	39720.040.012	6X36MM	100	39720.060.036
2X8MM	200	39720.020.008	4X16MM	200	39720.040.016	6X40MM	100	39720.060.040
2X10MM	200	39720.020.010	4X20MM	200	39720.040.020	6X50MM	100	39720.060.050
2X12MM	200	39720.020.012	4X24MM	200	39720.040.024	6X60MM	100	39720.060.060
2X16MM	200	39720.020.016	4X28MM	200	39720.040.028			
2X20MM	200	39720.020.020	4X30MM	200	39720.040.030	8X12MM	100	39720.080.012
			4X36MM	100	39720.040.036	8X16MM	100	39720.080.016
2,5X6MM	200	39720.025.006				8X20MM	100	39720.080.020
2,5X10MM	200	39720.025.010	5X8MM	200	39720.050.008	8X24MM	100	39720.080.024
2,5X12MM	200	39720.025.012	5X10MM	200	39720.050.010	8X30MM	100	39720.080.030
2,5X16MM	200	39720.025.016	5X12MM	200	39720.050.012	8X36MM	50	39720.080.036
2,5X20MM	250	39720.025.020	5X16MM	200	39720.050.016	8X40MM	50	39720.080.040
			5X20MM	100	39720.050.020	8X45MM	50	39720.080.045
3X8MM	200	39720.030.008	5X24MM	100	39720.050.024	8X50MM	50	39720.080.050
3X10MM	200	39720.030.010	5X30MM	100	39720.050.030	8X60MM	50	39720.080.060
3X12MM	200	39720.030.012	5X40MM	100	39720.050.040	8X70MM	50	39720.080.070
3X16MM	200	39720.030.016						

51586	Grooved pin, half length taper grooved	R09A
Material	Stainless steel A1	
		

d₁ x L	☒	Art.number	d₁ x L	☒	Art.number	d₁ x L	☒	Art.number
2X6MM*	500	51586.020.006	4X16MM*	200	51586.040.016	6X16MM*	100	51586.060.016
2X8MM*	500	51586.020.008	4X18MM*	200	51586.040.018	6X18MM*	100	51586.060.018
2X10MM*	500	51586.020.010	4X20MM*	200	51586.040.020	6X20MM*	100	51586.060.020
2X12MM*	500	51586.020.012	4X25MM*	200	51586.040.025	6X25MM*	100	51586.060.025
2X16MM*	500	51586.020.016	4X30MM*	200	51586.040.030	6X30MM*	100	51586.060.030
			4X35MM*	200	51586.040.035	6X35MM*	100	51586.060.035
3X6MM*	500	51586.030.006	4X40MM*	200	51586.040.040	6X40MM*	100	51586.060.040
3X8MM*	500	51586.030.008				6X50MM*	100	51586.060.050
3X10MM*	500	51586.030.010	5X10MM*	200	51586.050.010			
3X12MM*	500	51586.030.012	5X12MM*	200	51586.050.012	8X12MM*	50	51586.080.012
3X16MM*	500	51586.030.016	5X16MM*	200	51586.050.016	8X16MM*	50	51586.080.016
3X18MM*	500	51586.030.018	5X18MM*	200	51586.050.018	8X20MM*	50	51586.080.020
3X20MM*	500	51586.030.020	5X20MM*	200	51586.050.020	8X25MM*	50	51586.080.025
3X25MM*	500	51586.030.025	5X25MM*	200	51586.050.025	8X30MM*	50	51586.080.030
			5X30MM*	200	51586.050.030	8X35MM*	50	51586.080.035
4X8MM*	200	51586.040.008	5X40MM*	200	51586.050.040	8X40MM*	50	51586.080.040
4X10MM*	200	51586.040.010				8X60MM*	50	51586.080.060
4X12MM*	200	51586.040.012	6X12MM*	100	51586.060.012			

Grooved pin, full length parallel with chamfer

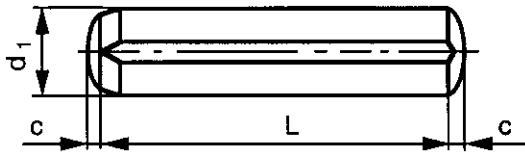

DIN 1473
ISO 8740
NEN 2604

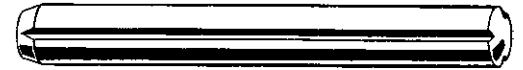

Technical Data

d ₁	c ≈	Tolerance	V	d ₁	c ≈	Tolerance	V
1.5	0.2	h9	1.6	4	0.4	h11	10.6
2	0.25	h9	2.85	5	0.6	h11	16.5
2.5	0.3	h9	4.25	6	0.8	h11	22.8
3	0.4	h9	6.15	8	1	h11	40.5

- V = Shear strength double min. in kN.
- For the hole diameter d, (nom.) with tolerance field H11 is recommended.
- The nominal length (L) does not include the rounded ends (tolerance js15).

Examples of application

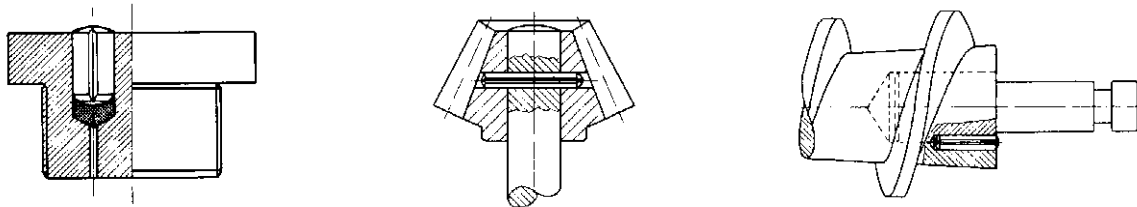

Article groups

Material	Code	Page
Free-cutting steel	39730	9-18
St.St. A1	51582	9-19

39730 Grooved pin, full length parallel with chamfer L11F

Material: Free-cutting steel

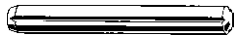
9

d ₁ x L	Art.number	d ₁ x L	Art.number	d ₁ x L	Art.number
1,5X5MM	200 39730.015.005	3X10MM	200 39730.030.010	5X40MM	100 39730.050.040
1,5X6MM	200 39730.015.006	3X12MM	200 39730.030.012	6X10MM	100 39730.060.010
1,5X8MM	200 39730.015.008	3X16MM	200 39730.030.016	6X12MM	100 39730.060.012
1,5X10MM	200 39730.015.010	3X20MM	200 39730.030.020	6X16MM	100 39730.060.016
1,5X12MM	200 39730.015.012	3X24MM	200 39730.030.024	6X20MM	100 39730.060.020
1,5X16MM	200 39730.015.016	3X30MM	200 39730.030.030	6X24MM	100 39730.060.024
2X5MM	200 39730.020.005	4X8MM	200 39730.040.008	6X30MM	100 39730.060.030
2X6MM	200 39730.020.006	4X10MM	200 39730.040.010	6X36MM	100 39730.060.036
2X8MM	200 39730.020.008	4X12MM	200 39730.040.012	6X40MM	100 39730.060.040
2X10MM	200 39730.020.010	4X16MM	200 39730.040.016	6X45MM	100 39730.060.045
2X12MM	200 39730.020.012	4X20MM	200 39730.040.020	6X50MM	100 39730.060.050
2X16MM	200 39730.020.016	4X24MM	200 39730.040.024	6X60MM	100 39730.060.060
2X20MM	200 39730.020.020	4X30MM	200 39730.040.030	8X12MM	100 39730.080.012
2X24MM	200 39730.020.024	4X36MM	100 39730.040.036	8X16MM	100 39730.080.016
2X30MM	200 39730.020.030	4X40MM	100 39730.040.040	8X20MM	100 39730.080.020
2,5X10MM	200 39730.025.010	5X8MM	200 39730.050.008	8X24MM	100 39730.080.024
2,5X12MM	200 39730.025.012	5X10MM	200 39730.050.010	8X30MM	100 39730.080.030
2,5X16MM	200 39730.025.016	5X12MM	200 39730.050.012	8X36MM	50 39730.080.036
2,5X20MM	200 39730.025.020	5X16MM	200 39730.050.016	8X40MM	50 39730.080.040
2,5X24MM	200 39730.025.024	5X20MM	100 39730.050.020	8X45MM	50 39730.080.045
		5X24MM	100 39730.050.024	8X50MM	50 39730.080.050
		5X30MM	100 39730.050.030	8X60MM	50 39730.080.060
3X6MM	200 39730.030.006	5X36MM	100 39730.050.036	8X70MM	50 39730.080.070
3X8MM	200 39730.030.008				

51582	Grooved pin, full length parallel with chamfer	R09A
Material	Stainless steel A1	

$d_1 \times L$	☒	Art.number	$d_1 \times L$	☒	Art.number	$d_1 \times L$	☒	Art.number
2X8MM*	500	51582.020.008	4X20MM*	200	51582.040.020	6X18MM*	100	51582.060.018
2X10MM*	500	51582.020.010	4X25MM*	200	51582.040.025	6X20MM*	100	51582.060.020
2X12MM*	500	51582.020.012	4X30MM*	200	51582.040.030	6X25MM*	100	51582.060.025
2X16MM*	500	51582.020.016	4X35MM*	200	51582.040.035	6X30MM*	100	51582.060.030
2X20MM*	500	51582.020.020	4X40MM*	200	51582.040.040	6X35MM*	100	51582.060.035
3X8MM*	500	51582.030.008	5X10MM*	200	51582.050.010	6X40MM*	100	51582.060.040
3X10MM*	500	51582.030.010	5X12MM*	200	51582.050.012	6X45MM*	100	51582.060.045
3X12MM*	500	51582.030.012	5X16MM*	200	51582.050.016	6X50MM*	100	51582.060.050
3X16MM*	500	51582.030.016	5X20MM*	200	51582.050.020	6X60MM*	100	51582.060.060
3X18MM*	500	51582.030.018	5X25MM*	200	51582.050.025	8X12MM*	50	51582.080.012
3X20MM*	500	51582.030.020	5X30MM*	200	51582.050.030	8X16MM*	50	51582.080.016
3X25MM*	500	51582.030.025	5X35MM*	200	51582.050.035	8X20MM*	50	51582.080.020
4X8MM*	200	51582.040.008	5X40MM*	200	51582.050.040	8X25MM*	50	51582.080.025
4X10MM*	200	51582.040.010	6X10MM*	100	51582.060.010	8X30MM*	50	51582.080.030
4X12MM*	200	51582.040.012	6X12MM*	100	51582.060.012	8X35MM*	50	51582.080.035
4X16MM*	200	51582.040.016	6X16MM*	100	51582.060.016	8X40MM*	50	51582.080.040
4X18MM*	200	51582.040.018				8X50MM*	50	51582.080.050

Grooved pin, half length reverse

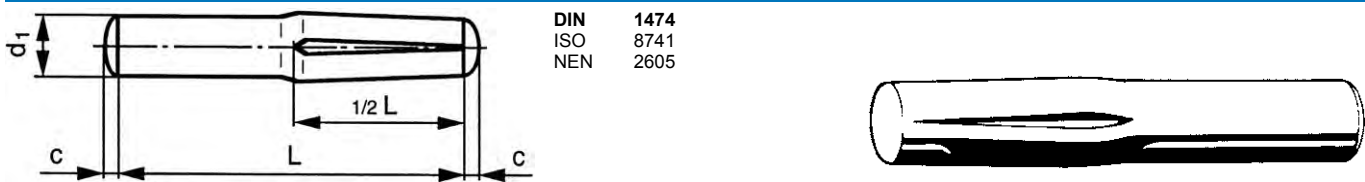

Technical Data

d_1	$c \approx$	Tolerance	V	d_1	$c \approx$	Tolerance	V
1.5	0.2	h9	1.6	4	0.5	h11	10.6
2	0.25	h9	2.85	5	0.63	h11	16.5
2.5	0.3	h9	4.25	6	0.8	h11	22.8
3	0.4	h9	6.15	8	1	h11	40.5

- V = Shear strength double min. in kN.
- For the hole diameter d_1 (nom.) with tolerance field H11 is recommended.
- The nominal length (L) does not include the rounded ends (tolerance js15).

Examples of application

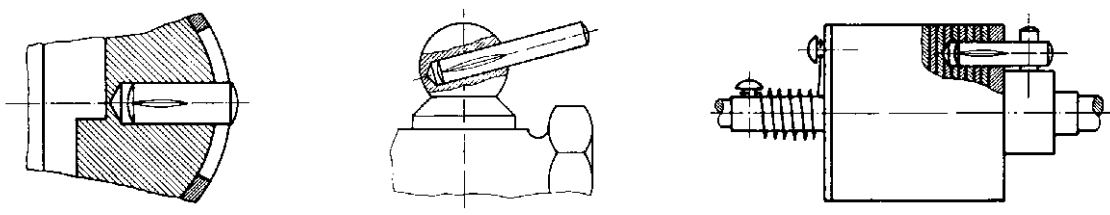

Article groups

Material	Code	Page
Free-cutting steel	39740	9-20
St.St. A1	51583	9-20

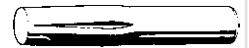
39740 Grooved pin, half length reverse
L11F
Material Free-cutting steel

$d_1 \times L$	☒	Art.number	$d_1 \times L$	☒	Art.number	$d_1 \times L$	☒	Art.number
1,5X5MM	200	39740.015.005	3X16MM	200	39740.030.016	6X12MM	100	39740.060.012
1,5X6MM	200	39740.015.006	3X20MM	200	39740.030.020	6X16MM	100	39740.060.016
1,5X8MM	200	39740.015.008	3X24MM	200	39740.030.024	6X20MM	100	39740.060.020
1,5X10MM	200	39740.015.010	3X30MM	200	39740.030.030	6X24MM	100	39740.060.024
1,5X12MM	200	39740.015.012				6X30MM	100	39740.060.030
			4X8MM	200	39740.040.008	6X40MM	100	39740.060.040
2X5MM	200	39740.020.005	4X10MM	200	39740.040.010	6X45MM	100	39740.060.045
2X6MM	200	39740.020.006	4X12MM	200	39740.040.012	6X50MM	100	39740.060.050
2X8MM	200	39740.020.008	4X16MM	200	39740.040.016	6X60MM	100	39740.060.060
2X10MM	200	39740.020.010	4X20MM	200	39740.040.020			
2X12MM	200	39740.020.012	4X24MM	200	39740.040.024	8X12MM	100	39740.080.012
2X16MM	200	39740.020.016	4X30MM	200	39740.040.030	8X16MM	100	39740.080.016
			4X36MM	100	39740.040.036	8X20MM	100	39740.080.020
2,5X6MM	200	39740.025.006				8X24MM	100	39740.080.024
2,5X8MM	200	39740.025.008	5X8MM	200	39740.050.008	8X30MM	100	39740.080.030
2,5X10MM	200	39740.025.010	5X10MM	200	39740.050.010	8X36MM	50	39740.080.036
2,5X12MM	200	39740.025.012	5X12MM	200	39740.050.012	8X40MM	50	39740.080.040
2,5X16MM	200	39740.025.016	5X16MM	200	39740.050.016	8X45MM	50	39740.080.045
			5X20MM	100	39740.050.020	8X50MM	50	39740.080.050
3X6MM	200	39740.030.006	5X24MM	100	39740.050.024	8X60MM	50	39740.080.060
3X8MM	200	39740.030.008	5X30MM	100	39740.050.030	8X70MM	50	39740.080.070
3X10MM	200	39740.030.010	5X36MM	100	39740.050.036			
3X12MM	200	39740.030.012						

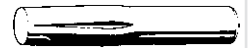
51583 Grooved pin, half length reverse
R09A
Material Stainless steel A1

$d_1 \times L$	☒	Art.number	$d_1 \times L$	☒	Art.number	$d_1 \times L$	☒	Art.number
2X8MM*	500	51583.020.008	4X10MM*	200	51583.040.010	5X25MM*	200	51583.050.025
2X10MM*	500	51583.020.010	4X12MM*	200	51583.040.012	5X35MM*	200	51583.050.035
2X12MM*	500	51583.020.012	4X16MM*	200	51583.040.016			
2X16MM*	500	51583.020.016	4X20MM*	200	51583.040.020	6X16MM*	100	51583.060.016
			4X25MM*	200	51583.040.025	6X20MM*	100	51583.060.020
3X8MM*	500	51583.030.008				6X30MM*	100	51583.060.030
3X10MM*	500	51583.030.010	5X12MM*	200	51583.050.012	6X40MM*	100	51583.060.040
3X12MM*	500	51583.030.012	5X16MM*	200	51583.050.016			
3X16MM*	500	51583.030.016	5X18MM*	200	51583.050.018	8X40MM*	100	51583.080.040
			5X20MM*	200	51583.050.020			

Grooved pin, third length center

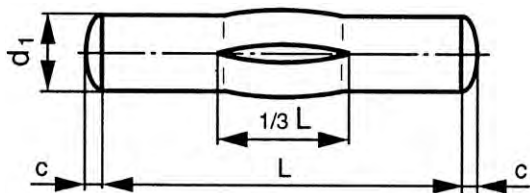

DIN 1475
ISO 8742
NEN 2606



Technical Data

d_1	$c \approx$	Tolerance	V	d_1	$c \approx$	Tolerance	V
1.5	0.2	h9	1.6	4	0.5	h11	10.6
2	0.25	h9	2.85	5	0.6	h11	16.5
2.5	0.3	h9	4.25	6	0.8	h11	22.8
3	0.4	h11	6.15	8	1	h11	40.5

- V = Shear strength double min. in kN.
- For the hole diameter d_1 (nom.) with tolerance field H11 is recommended.
- The nominal length (L) does not include the rounded ends (tolerance js15).

Examples of application

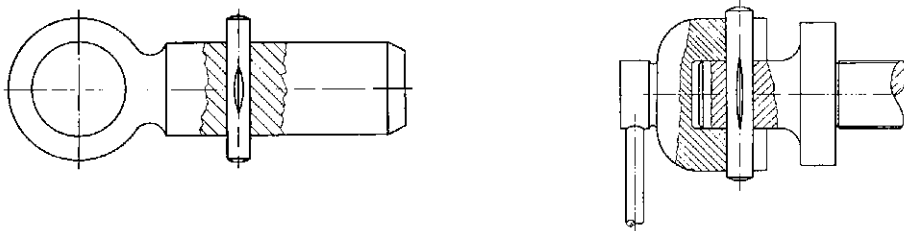

39750 Grooved pin, third length center

L11F

Material Free-cutting steel



$d_1 \times L$	☒	Art.number	$d_1 \times L$	☒	Art.number	$d_1 \times L$	☒	Art.number
1,5X8MM	200	39750.015.008	3X12MM	200	39750.030.012	5X40MM	100	39750.050.040
1,5X10MM	200	39750.015.010	3X16MM	200	39750.030.016	6X12MM	100	39750.060.012
1,5X16MM	200	39750.015.016	3X20MM	200	39750.030.020	6X16MM	100	39750.060.016
2X6MM	200	39750.020.006	3X24MM	200	39750.030.024	6X20MM	100	39750.060.020
2X10MM	200	39750.020.010	3X30MM	200	39750.030.030	6X24MM	100	39750.060.024
2X12MM	200	39750.020.012	4X12MM	200	39750.040.012	6X30MM	100	39750.060.030
2X16MM	200	39750.020.016	4X16MM	200	39750.040.016	6X36MM	100	39750.060.036
2X20MM	200	39750.020.020	4X20MM	200	39750.040.020	6X40MM	100	39750.060.040
2X24MM	200	39750.020.024	4X24MM	200	39750.040.024	6X45MM	100	39750.060.045
2,5X8MM	200	39750.025.008	4X30MM	200	39750.040.030	6X50MM	100	39750.060.050
2,5X10MM	200	39750.025.010	4X36MM	100	39750.040.036	6X60MM	100	39750.060.060
2,5X12MM	200	39750.025.012	4X40MM	100	39750.040.040	8X20MM	100	39750.080.020
2,5X16MM	200	39750.025.016	5X10MM	200	39750.050.010	8X24MM	100	39750.080.024
2,5X20MM	200	39750.025.020	5X12MM	200	39750.050.012	8X30MM	100	39750.080.030
2,5X24MM	200	39750.025.024	5X16MM	200	39750.050.016	8X36MM	50	39750.080.036
2,5X30MM	200	39750.025.030	5X20MM	100	39750.050.020	8X40MM	50	39750.080.040
3X6MM	200	39750.030.006	5X24MM	100	39750.050.024	8X45MM	50	39750.080.045
3X8MM	200	39750.030.008	5X30MM	100	39750.050.030	8X50MM	50	39750.080.050
3X10MM	200	39750.030.010	5X36MM	100	39750.050.036	8X60MM	50	39750.080.060

Round head grooved pin

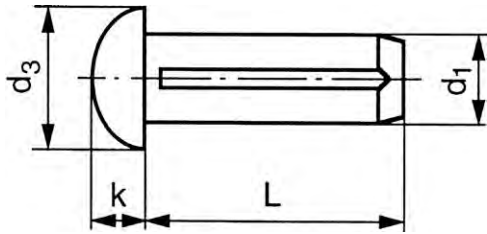

DIN 1476
ISO 8746
NEN 2460

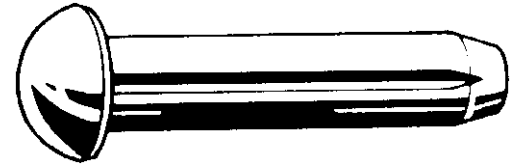

Technical Data

d_1	d_3	k	Tolerance
1.4	2.4	0.8	0/ - 0.05
1.7 (#DIN)	3	1	0/ - 0.05
2	3.5	1.2	0/ - 0.05
2.5	4.4	1.4	0/ - 0.05
2.6 (#DIN)	4.5	1.6	0/ - 0.075
3	5.2	1.8	0/ - 0.075
4	7	2.4	0/ - 0.1
5	8.8	3	0/ - 0.1
6	10.5	3.6	0/ - 0.1

- For the hole diameter d_1 (nom.) with tolerance field H11 is recommended.
- The nominal length (L) is with tolerance js15.

Article groups

Material	Code	Page
St UTS 36-2	39760	9-22
St.St. A2	51589	9-22

39760	Round head grooved pin	L11F
Material	Steel Ust 36-2	
		
		

$d_1 \times L$	☒	Art.number	$d_1 \times L$	☒	Art.number	$d_1 \times L$	☒	Art.number
1,4X3MM	200	39760.014.003	2,6X4MM	200	39760.026.004	4X10MM	200	39760.040.010
1,4X4MM	200	39760.014.004	2,6X5MM	200	39760.026.005	4X12MM	200	39760.040.012
1,4X6MM	200	39760.014.006	2,6X6MM	200	39760.026.006	4X15MM	200	39760.040.015
			2,6X8MM	200	39760.026.008			
			2,6X10MM	200	39760.026.010			
1,7X3MM	200	39760.017.003				5X8MM	200	39760.050.008
1,7X4MM	200	39760.017.004				5X10MM	200	39760.050.010
1,7X5MM	200	39760.017.005	3X4MM	200	39760.030.004	5X12MM	200	39760.050.012
1,7X6MM	200	39760.017.006	3X5MM	200	39760.030.005	5X15MM	200	39760.050.015
			3X6MM	200	39760.030.006	5X20MM	200	39760.050.020
2X3MM	200	39760.020.003	3X8MM	200	39760.030.008	5X25MM	200	39760.050.025
2X4MM	200	39760.020.004	3X10MM	200	39760.030.010			
2X5MM	200	39760.020.005	3X12MM	200	39760.030.012	6X10MM	200	39760.060.010
2X6MM	200	39760.020.006	3X15MM	200	39760.030.015	6X12MM	200	39760.060.012
2X8MM	200	39760.020.008	4X6MM	200	39760.040.006	6X15MM	200	39760.060.015
2X10MM	200	39760.020.010	4X8MM	200	39760.040.008	6X20MM	200	39760.060.020
2,6X3MM	200	39760.026.003				6X25MM	200	39760.060.025

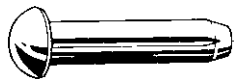
51589	Round head grooved pin	R09A
Material	Stainless steel A2	
		
		

$d_1 \times L$	☒	Art.number	$d_1 \times L$	☒	Art.number	$d_1 \times L$	☒	Art.number
2X3MM*	500	51589.020.003	2,5X3MM*	500	51589.025.003	3X4MM*	500	51589.030.004
2X4MM*	500	51589.020.004	2,5X4MM*	500	51589.025.004	3X5MM	500	51589.030.005
2X5MM*	500	51589.020.005	2,5X5MM*	500	51589.025.005	3X6MM*	500	51589.030.006
2X6MM*	500	51589.020.006	2,5X6MM*	500	51589.025.006	3X8MM*	500	51589.030.008
2X8MM*	500	51589.020.008	2,5X8MM*	500	51589.025.008	3X10MM*	500	51589.030.010
2X10MM*	500	51589.020.010	2,5X10MM*	500	51589.025.010	3X12MM*	500	51589.030.012
						3X16MM*	500	51589.030.016

51589 Round head grooved pin								
$d_1 \times L$	☒	Art.number	$d_1 \times L$	☒	Art.number	$d_1 \times L$	☒	Art.number
4X5MM*	200	51589.040.005	4X10MM*	200	51589.040.010	5X8MM*	200	51589.050.008
4X6MM*	200	51589.040.006	4X12MM*	200	51589.040.012	5X10MM*	200	51589.050.010
4X8MM*	200	51589.040.008	5X6MM*	200	51589.050.006	5X12MM*	200	51589.050.012
						5X16MM*	200	51589.050.016

Drive screw

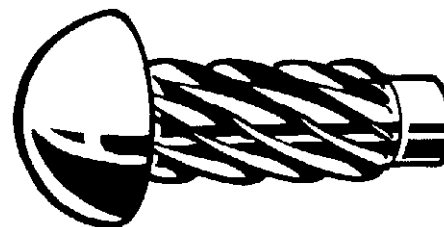
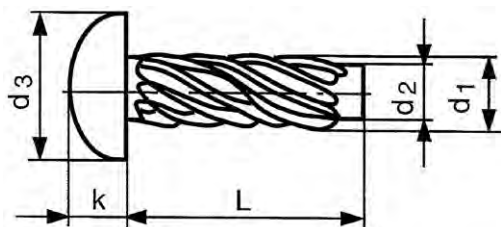

Technical Data					
d_1	d_2	d_3	Hole $\phi \approx$	k	
1.5	1.35	2.5	1.4	0.8	
1.9	1.7	3.2	1.7	1.2	
2.5	2.15	4.1	2.2	1.7	
2.9	2.65	5.3	2.6	2.1	
3.5	3.1	6.6	3.1	2.6	

27410 Drive screw		J04A
Material	Steel	
Surface treatment	Nickel plated	
		

$d_1 \times L$	☒	Art.number	$d_1 \times L$	☒	Art.number	$d_1 \times L$	☒	Art.number
1,5X3,2MM	500	27410.015.003	2,5X3,2MM	500	27410.025.003	2,9X6,5MM	500	27410.029.006
1,5X4,7MM	500	27410.015.004	2,5X4,7MM	500	27410.025.004	2,9X8MM	500	27410.029.008
1,5X6,5MM	500	27410.015.006	2,5X6,5MM	500	27410.025.006	3,5X6,5MM	500	27410.035.006
1,9X3,2MM	500	27410.019.003	2,9X4,7MM	500	27410.029.004	3,5X8MM	500	27410.035.008
1,9X4,7MM	500	27410.019.004				3,5X9,5MM	500	27410.035.009
1,9X6,5MM	500	27410.019.006						

Spring-type straight pin (spiral pin) coiled, standard duty

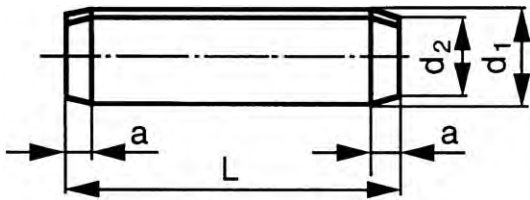

ISO 8750
DIN 7343
NEN 2553



Technical Data

d (nom.)	a ≈	d ₁ (max.)	d ₁ (min.)	d ₂	V
1	0.3	1.15	1.05	0.95	0.6
1.5	0.5	1.73	1.62	1.4	1.45
2	0.7	2.25	2.13	1.9	2.5
2.5	0.7	2.78	2.65	2.4	3.9
3	0.9	3.3	3.15	2.9	5.5
4	1.1	4.4	4.2	3.9	9.6
5	1.3	5.5	5.25	4.85	15
6	1.5	6.5	6.25	5.85	22
8	2	8.63	8.3	7.8	39
10	2.5	10.8	10.35	9.75	62
12	3	12.85	12.4	11.7	89
14	3.5	14.95	14.45	13.6	120
16	4	17	16.45	15.6	155

- V = Shear strength double min. in kN.
- Special features of spring-type straight pins (spiral pins):
- Are used for the dismantlable connection (positioning) of two or more parts and can also be applied as shafts and hinge-, stop- or carrierpins.
- Due to the spiral shaped cross section (approx. 2.1/4 coils) the spring-type straight pins (spiral pins) are very flexible and suitable to be used more times for dynamic loads. Equal stress distribution throughout its cross section against the hole wall produces a good press fit, which can absorb shear forces unaffected by the direction.
- Swaged chamfer at both ends, so they can easily be inserted and installed automatically.
- For the hole diameter d (nom.) the tolerance H12 is recommended except for d (nom.)1mm, the tolerance H10 is recommended.

Examples of application

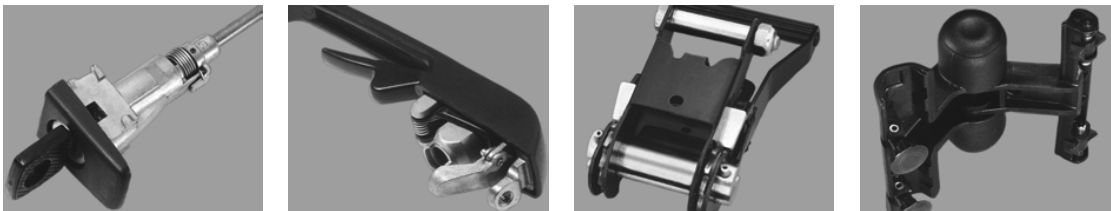

9

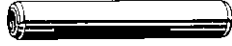
39140	Spring-type straight pin (spiral pin) coiled, standard duty	L09A
Material	Spring steel 420-560 HV30	
		 

d (nom.) x L	☒	Art.number	d (nom.) x L	☒	Art.number	d (nom.) x L	☒	Art.number
1,5X4MM	200	39140.015.004	2,5X12MM	200	39140.025.012	4X10MM	200	39140.040.010
1,5X6MM	200	39140.015.006	2,5X14MM	200	39140.025.014	4X12MM	200	39140.040.012
1,5X8MM	200	39140.015.008	2,5X16MM	200	39140.025.016	4X16MM	200	39140.040.016
1,5X10MM	200	39140.015.010	2,5X18MM	200	39140.025.018	4X18MM	200	39140.040.018
1,5X12MM	200	39140.015.012	2,5X20MM	200	39140.025.020	4X20MM	200	39140.040.020
1,5X14MM	200	39140.015.014	2,5X24MM	200	39140.025.024	4X22MM	200	39140.040.022
1,5X16MM	200	39140.015.016				4X24MM	200	39140.040.024
2X6MM	200	39140.020.006	3X8MM	200	39140.030.008	4X26MM	200	39140.040.026
2X8MM	200	39140.020.008	3X10MM	200	39140.030.010	4X28MM	200	39140.040.028
2X10MM	200	39140.020.010	3X12MM	200	39140.030.012	4X30MM	200	39140.040.030
2X12MM	200	39140.020.012	3X14MM	200	39140.030.014	4X32MM	100	39140.040.032
2X14MM	200	39140.020.014	3X16MM	200	39140.030.016	4X35MM	100	39140.040.035
2X16MM	200	39140.020.016	3X20MM	200	39140.030.020	4X40MM	100	39140.040.040
2X20MM	200	39140.020.020	3X22MM	200	39140.030.022			
			3X24MM	200	39140.030.024			
			3X26MM	200	39140.030.026	5X12MM	200	39140.050.012
2,5X8MM	200	39140.025.008	3X28MM	200	39140.030.028	5X16MM	200	39140.050.016
2,5X10MM	200	39140.025.010	3X30MM	200	39140.030.030	5X20MM	100	39140.050.020

39140 Spring-type straight pin (spiral pin) coiled, standard duty

d (nom.) x L	☒	Art.number	d (nom.) x L	☒	Art.number	d (nom.) x L	☒	Art.number
5X22MM	100	39140.050.022				10X80MM	10	39140.100.080
5X24MM	100	39140.050.024	8X20MM	100	39140.080.020	12X30MM	25	39140.120.030
5X26MM	100	39140.050.026	8X24MM	100	39140.080.024	12X35MM	25	39140.120.035
5X28MM	100	39140.050.028	8X30MM	50	39140.080.030	12X40MM	25	39140.120.040
5X30MM	100	39140.050.030	8X32MM	50	39140.080.032	12X50MM	10	39140.120.050
5X32MM	100	39140.050.032	8X35MM	50	39140.080.035	12X55MM	10	39140.120.055
5X35MM	100	39140.050.035	8X40MM	50	39140.080.040	12X60MM	10	39140.120.060
5X40MM	100	39140.050.040	8X50MM	50	39140.080.050	12X70MM	10	39140.120.070
5X45MM	100	39140.050.045	8X60MM	50	39140.080.060	12X80MM	10	39140.120.080
			8X70MM	25	39140.080.070	12X85MM	10	39140.120.085
6X12MM	200	39140.060.012				12X90MM	10	39140.120.090
6X16MM	200	39140.060.016	10X20MM	50	39140.100.020	12X100MM	10	39140.120.100
6X20MM	100	39140.060.020	10X22MM	50	39140.100.022	12X120MM	10	39140.120.120
6X24MM	100	39140.060.024	10X24MM	50	39140.100.024			
6X26MM	100	39140.060.026	10X28MM	50	39140.100.028	16X40MM	5	39140.160.040
6X28MM	100	39140.060.028	10X30MM	50	39140.100.030	16X50MM	5	39140.160.050
6X30MM	100	39140.060.030	10X35MM	25	39140.100.035	16X60MM	5	39140.160.060
6X32MM	100	39140.060.032	10X40MM	25	39140.100.040	16X80MM	5	39140.160.080
6X35MM	100	39140.060.035	10X45MM	25	39140.100.045	16X90MM	5	39140.160.090
6X40MM	100	39140.060.040	10X50MM	25	39140.100.050	16X100MM	5	39140.160.100
6X45MM	50	39140.060.045	10X60MM	25	39140.100.060	16X120MM	5	39140.160.120
6X50MM	50	39140.060.050	10X70MM	25	39140.100.070			

• Warning: electro-galvanizing of these products may cause hydrogen embrittlement.

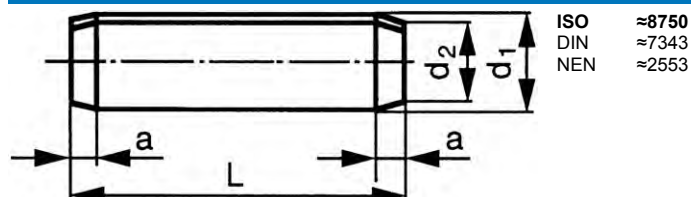
Spring-type straight pin (spiral pin) coiled, standard duty A2

Technical Data

d (nom.)	a ≈	d ₁ (max.)	d ₁ (min.)	d ₂	V
1	0.3	1.15	1.05	0.95	0.45
1.5	0.5	1.73	1.62	1.4	1.05
2	0.7	2.25	2.13	1.9	1.9
2.5	0.7	2.78	2.65	2.4	2.9
3	0.9	3.3	3.15	2.9	4.2
4	1.1	4.4	4.2	3.9	7.6
5	1.3	5.5	5.25	4.85	11.5
6	1.5	6.5	6.25	5.85	16.8
8	2	8.63	8.3	7.8	30

- V = Shear strength double min. in kN.
- Special features of spring-type straight pins (spiral pins):
- Are used for the dismountable connection (positioning) of two or more parts and can also be applied as shafts and hinge-, stop- or carrierpins.
- Due to the spiral shaped cross section (approx. 2.1/4 coils) the spring-type straight pins (spiral pins) are very flexible and suitable to be used more times for dynamic loads.
- Equal stress distribution throughout its cross section against the hole wall produces a good press fit, which can absorb shear forces unaffected by the direction.
- Swaged chamfer at both ends, so they can easily be inserted and installed automatically.
- The austenetic steel type is at the manufacturer's discretion, and can vary from the steel types stated in ISO 3506
- For the hole diameter d (nom.) with tolerance H12 is recommended except for d (nom.) 1mm the tolerance H10 is recommended.

51430 Spring-type straight pin (spiral pin) coiled, standard duty R09A

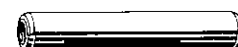
Material Stainless steel A2



d (nom.) x L	☒	Art.number	d (nom.) x L	☒	Art.number	d (nom.) x L	☒	Art.number
1X4MM	200	51430.010.004	1,5X6MM*	1000	51430.015.006	2X6MM	200	51430.020.006
1X6MM	200	51430.010.006	1,5X8MM	200	51430.015.008	2X8MM	200	51430.020.008
1X8MM	200	51430.010.008	1,5X10MM	200	51430.015.010	2X10MM	200	51430.020.010
1X10MM	200	51430.010.010	1,5X12MM	200	51430.015.012	2X12MM	200	51430.020.012
1X12MM	200	51430.010.012	1,5X14MM	200	51430.015.014	2X14MM	200	51430.020.014
			1,5X16MM	200	51430.015.016	2X16MM	200	51430.020.016
1,5X4MM	200	51430.015.004				2X18MM	200	51430.020.018
1,5X5MM	200	51430.015.005	2X5MM*	1000	51430.020.005	2X20MM	200	51430.020.020

51430 Spring-type straight pin (spiral pin) coiled, standard duty

d (nom.) x L	Art.number	d (nom.) x L	Art.number	d (nom.) x L	Art.number
2,5X6MM*	1000 51430.025.006	4X16MM	200 51430.040.016	5X50MM	100 51430.050.050
2,5X8MM	200 51430.025.008	4X18MM	200 51430.040.018	6X12MM	200 51430.060.012
2,5X10MM	200 51430.025.010	4X20MM	200 51430.040.020	6X14MM	200 51430.060.014
2,5X12MM	200 51430.025.012	4X22MM	200 51430.040.022	6X16MM	200 51430.060.016
2,5X14MM	200 51430.025.014	4X24MM	200 51430.040.024	6X18MM	100 51430.060.018
2,5X16MM	200 51430.025.016	4X26MM	200 51430.040.026	6X20MM	100 51430.060.020
2,5X18MM	200 51430.025.018	4X28MM	200 51430.040.028	6X22MM	100 51430.060.022
2,5X20MM	200 51430.025.020	4X30MM	200 51430.040.030	6X24MM	100 51430.060.024
2,5X24MM	200 51430.025.024	4X32MM*	500 51430.040.032	6X26MM	100 51430.060.026
3X8MM	200 51430.030.008	4X35MM	100 51430.040.035	6X28MM	100 51430.060.028
3X10MM	200 51430.030.010	4X40MM	100 51430.040.040	6X30MM	100 51430.060.030
3X12MM	200 51430.030.012	4X45MM*	500 51430.040.045	6X32MM	100 51430.060.032
3X14MM	200 51430.030.014	4X50MM*	500 51430.040.050	6X35MM	100 51430.060.035
3X16MM	200 51430.030.016	5X10MM*	500 51430.050.010	6X40MM	100 51430.060.040
3X18MM	200 51430.030.018	5X12MM	200 51430.050.012	6X45MM	100 51430.060.045
3X20MM	200 51430.030.020	5X14MM	200 51430.050.014	6X50MM	100 51430.060.050
3X22MM	200 51430.030.022	5X16MM	200 51430.050.016	8X16MM	100 51430.080.016
3X24MM	200 51430.030.024	5X18MM	100 51430.050.018	8X20MM	100 51430.080.020
3X26MM	200 51430.030.026	5X20MM	100 51430.050.020	8X24MM	100 51430.080.024
3X28MM	200 51430.030.028	5X22MM*	500 51430.050.022	8X26MM	50 51430.080.026
3X30MM	200 51430.030.030	5X24MM	100 51430.050.024	8X28MM	50 51430.080.028
3X32MM*	500 51430.030.032	5X26MM	100 51430.050.026	8X30MM	50 51430.080.030
4X8MM	200 51430.040.008	5X28MM	100 51430.050.028	8X32MM	50 51430.080.032
4X10MM	200 51430.040.010	5X30MM	100 51430.050.030	8X35MM	50 51430.080.035
4X12MM	200 51430.040.012	5X32MM	100 51430.050.032	8X40MM	50 51430.080.040
4X14MM	200 51430.040.014	5X35MM	100 51430.050.035	8X45MM	50 51430.080.045
		5X40MM	100 51430.050.040	8X50MM	50 51430.080.050
		5X45MM	100 51430.050.045		

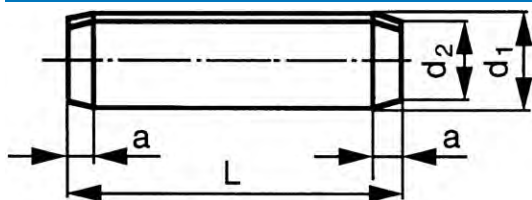
Spring-type straight pin (spiral pin) coiled, heavy duty

ISO 8748
DIN 7344
NEN 2554



Technical Data

d (nom.)	a ≈	d ₁ (max.)	d ₁ (min.)	d ₂	V
1.5	0.5	1.71	1.61	1.4	1.9
2	0.7	2.21	2.11	1.9	3.5
2.5	0.7	2.73	2.62	2.4	5.5
3	0.9	3.25	3.12	2.9	7.6
4	1.1	4.3	4.15	3.9	13.5
5	1.3	5.35	5.15	4.85	20
6	1.5	6.4	6.18	5.85	30

- V = Shear strength double min. in kN.
- Special features of spring-type straight pins (spiral pins):
- Are used for the dismantlable connection (positioning) of two or more parts and can also be applied as shafts and hinge-, stop- or carrierpins.
- Due to the spiral shaped cross section (approx. 2.1/4 coils) the spring-type straight pins (spiral pins) are very flexible and suitable to be used more times for dynamic loads. Equal stress distribution throughout its cross section against the hole wall produces a good press fit, which can.
- Absorb shear forces unaffected by the direction.
- Swaged chamfer at both ends, so they can easily be inserted and installed automatically.
- For the hole diameter d (nom.) the tolerance H12 is recommended except for d (nom.) 1mm, the tolerance H10 is recommended.

39150 Spring-type straight pin (spiral pin) coiled, heavy duty
L09A

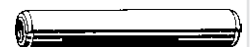
Material Spring steel 420-560 HV30



d (nom.) x L	Art.number	d (nom.) x L	Art.number	d (nom.) x L	Art.number
1,5X4MM	200 39150.015.004	1,5X14MM	200 39150.015.014	2X12MM	200 39150.020.012
1,5X5MM	200 39150.015.005	1,5X16MM	200 39150.015.016	2X14MM	200 39150.020.014
1,5X6MM	200 39150.015.006			2X16MM	200 39150.020.016
1,5X8MM	200 39150.015.008	2X6MM	200 39150.020.006	2X20MM	200 39150.020.020
1,5X10MM	200 39150.015.010	2X8MM	200 39150.020.008		
1,5X12MM	200 39150.015.012	2X10MM	200 39150.020.010	2,5X10MM	200 39150.025.010

39150 Spring-type straight pin (spiral pin) coiled, heavy duty

d (nom.) x L	☒	Art.number	d (nom.) x L	☒	Art.number	d (nom.) x L	☒	Art.number
2,5X12MM	200	39150.025.012	4X14MM	200	39150.040.014	5X28MM	100	39150.050.028
2,5X14MM	200	39150.025.014	4X16MM	200	39150.040.016	5X30MM	100	39150.050.030
2,5X16MM	200	39150.025.016	4X18MM	200	39150.040.018	5X32MM	100	39150.050.032
2,5X18MM	200	39150.025.018	4X20MM	200	39150.040.020	5X35MM	100	39150.050.035
2,5X20MM	200	39150.025.020	4X22MM	200	39150.040.022	5X40MM	100	39150.050.040
2,5X22MM	200	39150.025.022	4X24MM	200	39150.040.024	5X45MM	100	39150.050.045
2,5X24MM	200	39150.025.024	4X26MM	200	39150.040.026			
			4X28MM	200	39150.040.028	6X14MM	100	39150.060.014
3X8MM	200	39150.030.008	4X30MM	200	39150.040.030	6X16MM	100	39150.060.016
3X10MM	200	39150.030.010	4X32MM	100	39150.040.032	6X18MM	100	39150.060.018
3X12MM	200	39150.030.012	4X35MM	100	39150.040.035	6X20MM	100	39150.060.020
3X14MM	200	39150.030.014	4X40MM	100	39150.040.040	6X22MM	100	39150.060.022
3X16MM	200	39150.030.016				6X24MM	100	39150.060.024
3X20MM	200	39150.030.020	5X12MM	200	39150.050.012	6X26MM	100	39150.060.026
3X22MM	200	39150.030.022	5X14MM	200	39150.050.014	6X28MM	100	39150.060.028
3X24MM	200	39150.030.024	5X16MM	200	39150.050.016	6X30MM	100	39150.060.030
3X28MM	200	39150.030.028	5X18MM	100	39150.050.018	6X32MM	100	39150.060.032
3X30MM	200	39150.030.030	5X20MM	100	39150.050.020	6X35MM	100	39150.060.035
			5X22MM	100	39150.050.022	6X40MM	100	39150.060.040
4X10MM	200	39150.040.010	5X24MM	100	39150.050.024	6X50MM	100	39150.060.050
4X12MM	200	39150.040.012	5X26MM	100	39150.050.026			

• Warning: electro-galvanizing of these products may cause hydrogen embrittlement.

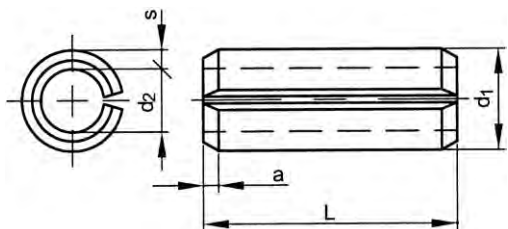
Spring-type straight pin slotted, heavy duty

ISO 8752
DIN 1481
NEN 2458
BS 7060

Technical Data

d (nom.)	a (min.)	d ₁ (max.)	d ₁ (min.)	d ₂ ≈	s	V
1.5	0.25	1.8	1.7	1.1	0.3	1.58
2	0.35	2.4	2.3	1.5	0.4	2.82
2.5	0.4	2.9	2.8	1.8	0.5	4.38
3	0.5	3.5	3.3	2.1	0.6	6.32
3.5	0.6	4	3.8	2.3	0.75	9.06
4	0.65	4.6	4.4	2.8	0.8	11.24
4.5	0.8	5.1	4.9	2.9	1	15.36
5	0.9	5.6	5.4	3.4	1	17.54
6	1.2	6.7	6.4	3.9	1.25	26.04
7 (#DIN)	2	7.8	7.5	4.5	1.5	31.4
8	1.6	8.8	8.5	5.5	1.5	42.76
9 (#DIN)	2	9.8	9.5	5.5	2	60.66
10	2	10.8	10.5	6.5	2	70.16
12	2	12.8	12.5	7.5	2.5	104.1
13	2	13.8	13.5	8.5	2.5	115.1
14	2	14.8	14.4	8.5	3	144.7
16	2	16.8	16.5	10.5	3	171
18	2	18.9	18.5	11.5	3.5	222.5
20	3	20.9	20.5	12.5	4	280.6

• V = Shear strength double min. in kN.
• For the hole diameter d(nom.) with tolerance field H12 is recommended.

Special features spring-type straight pins:

- are used to connect two or more construction elements to each other
- highly suitable to absorb shear forces
- to avoid movements in light bolt connections spring-type straight pins can be used accordingly to information stated below:

d (nom.) spring-type straight pin	6	8	10	12	16	18
intended for bolt size	M3	M4	M5	M6	M8	M10
associated washers acc. to DIN 7349	3,2	4,3	5,3	6,4	8,4	10,5

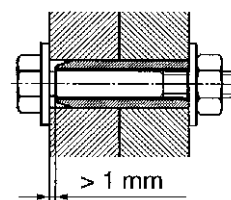

39100 Spring-type straight pin slotted, heavy duty

L09A

Material Spring steel 420-560 HV30



d (nom.) x L	☒	Art.number	d (nom.) x L	☒	Art.number	d (nom.) x L	☒	Art.number
1,5X6MM	200	39100.015.006	4X12MM	200	39100.040.012	8X16MM	500	39100.080.016
1,5X8MM	200	39100.015.008	4X14MM	200	39100.040.014	8X20MM	50	39100.080.020
1,5X10MM	200	39100.015.010	4X16MM	200	39100.040.016	8X24MM	50	39100.080.024
1,5X12MM	200	39100.015.012	4X18MM	200	39100.040.018	8X26MM	50	39100.080.026
1,5X16MM	200	39100.015.016	4X20MM	200	39100.040.020	8X30MM	50	39100.080.030
1,5X20MM	200	39100.015.020	4X22MM	200	39100.040.022	8X32MM	50	39100.080.032
			4X24MM	200	39100.040.024	8X35MM	50	39100.080.035
2X4MM	200	39100.020.004	4X26MM	200	39100.040.026	8X40MM	50	39100.080.040
2X8MM	200	39100.020.008	4X28MM	200	39100.040.028	8X45MM	50	39100.080.045
2X10MM	200	39100.020.010	4X30MM	200	39100.040.030	8X50MM	50	39100.080.050
2X12MM	200	39100.020.012	4X32MM	100	39100.040.032	8X55MM	50	39100.080.055
2X14MM	200	39100.020.014	4X35MM	100	39100.040.035	8X60MM	50	39100.080.060
2X16MM	200	39100.020.016	4X40MM	100	39100.040.040	8X70MM	25	39100.080.070
2X20MM	200	39100.020.020	4X45MM	100	39100.040.045	8X80MM	25	39100.080.080
2X24MM	200	39100.020.024	4X50MM	100	39100.040.050	8X100MM	10	39100.080.100
2X26MM	200	39100.020.026	4X60MM	100	39100.040.060			
2X30MM	200	39100.020.030				10X20MM	50	39100.100.020
2X40MM	200	39100.020.040	4,5X10MM	200	39100.045.010	10X22MM	50	39100.100.022
			4,5X12MM	200	39100.045.012	10X24MM	50	39100.100.024
2,5X6MM	1	39100.025.006	4,5X14MM	200	39100.045.014	10X26MM	50	39100.100.026
2,5X8MM	200	39100.025.008	4,5X16MM	200	39100.045.016	10X30MM	50	39100.100.030
2,5X10MM	200	39100.025.010	4,5X20MM	200	39100.045.020	10X35MM	50	39100.100.035
2,5X12MM	200	39100.025.012	4,5X30MM	100	39100.045.030	10X40MM	25	39100.100.040
2,5X16MM	200	39100.025.016	4,5X40MM	200	39100.045.040	10X45MM	25	39100.100.045
2,5X18MM	200	39100.025.018	4,5X45MM	100	39100.045.045	10X50MM	25	39100.100.050
2,5X20MM	200	39100.025.020	4,5X50MM	200	39100.045.050	10X55MM	25	39100.100.055
2,5X24MM	200	39100.025.024	4,5X60MM	200	39100.045.060	10X60MM	25	39100.100.060
2,5X26MM	200	39100.025.026				10X70MM	25	39100.100.070
2,5X28MM	200	39100.025.028	5X10MM	200	39100.050.010	10X75MM	25	39100.100.075
2,5X30MM	200	39100.025.030	5X12MM	200	39100.050.012	10X80MM	10	39100.100.080
2,5X35MM	200	39100.025.035	5X16MM	100	39100.050.016	10X90MM	10	39100.100.090
2,5X40MM	200	39100.025.040	5X18MM	100	39100.050.018	10X100MM	10	39100.100.100
			5X20MM	100	39100.050.020			
3X6MM	200	39100.030.006	5X24MM	100	39100.050.024	12X24MM	25	39100.120.024
3X8MM	200	39100.030.008	5X26MM	100	39100.050.026	12X30MM	25	39100.120.030
3X10MM	200	39100.030.010	5X28MM	100	39100.050.028	12X36MM	25	39100.120.036
3X12MM	200	39100.030.012	5X30MM	100	39100.050.030	12X40MM	25	39100.120.040
3X14MM	200	39100.030.014	5X32MM	100	39100.050.032	12X45MM	100	39100.120.045
3X16MM	200	39100.030.016	5X35MM	100	39100.050.035	12X50MM	10	39100.120.050
3X18MM	200	39100.030.018	5X40MM	100	39100.050.040	12X60MM	10	39100.120.060
3X20MM	200	39100.030.020	5X45MM	100	39100.050.045	12X65MM	10	39100.120.065
3X22MM	200	39100.030.022	5X50MM	100	39100.050.050	12X70MM	10	39100.120.070
3X24MM	200	39100.030.024	5X55MM	100	39100.050.055	12X80MM	10	39100.120.080
3X26MM	200	39100.030.026	5X60MM	100	39100.050.060	12X90MM	10	39100.120.090
3X28MM	200	39100.030.028	5X70MM	50	39100.050.070	12X100MM	10	39100.120.100
3X30MM	200	39100.030.030	5X80MM	50	39100.050.080	12X120MM	10	39100.120.120
3X32MM	200	39100.030.032						
3X35MM	200	39100.030.035	6X12MM	200	39100.060.012	16X36MM	5	39100.160.036
3X40MM	200	39100.030.040	6X16MM	100	39100.060.016	16X40MM	5	39100.160.040
3X45MM	200	39100.030.045	6X18MM	100	39100.060.018	16X50MM	5	39100.160.050
3X50MM	200	39100.030.050	6X20MM	100	39100.060.020	16X60MM	5	39100.160.060
			6X22MM	100	39100.060.022	16X70MM	5	39100.160.070
3,5X10MM	200	39100.035.010	6X24MM	100	39100.060.024	16X75MM	5	39100.160.075
3,5X12MM	200	39100.035.012	6X26MM	100	39100.060.026	16X80MM	5	39100.160.080
3,5X16MM	200	39100.035.016	6X28MM	100	39100.060.028	16X90MM	5	39100.160.090
3,5X18MM	200	39100.035.018	6X30MM	100	39100.060.030	16X100MM	5	39100.160.100
3,5X20MM	200	39100.035.020	6X32MM	100	39100.060.032	16X120MM	5	39100.160.120
3,5X22MM	200	39100.035.022	6X35MM	100	39100.060.035			
3,5X24MM	200	39100.035.024	6X40MM	100	39100.060.040	18X50MM	5	39100.180.050
3,5X26MM	200	39100.035.026	6X45MM	50	39100.060.045			
3,5X30MM	200	39100.035.030	6X50MM	50	39100.060.050	20X60MM	5	39100.200.060
3,5X32MM	200	39100.035.032	6X55MM	50	39100.060.055	20X70MM	5	39100.200.070
3,5X35MM	200	39100.035.035	6X60MM	50	39100.060.060	20X80MM	5	39100.200.080
3,5X40MM	200	39100.035.040	6X65MM	50	39100.060.065	20X85MM	5	39100.200.085
3,5X45MM	200	39100.035.045	6X70MM	50	39100.060.070	20X90MM	5	39100.200.090
3,5X50MM	200	39100.035.050	6X80MM	50	39100.060.080	20X95MM	5	39100.200.095
			6X90MM	50	39100.060.090	20X100MM	5	39100.200.100
4X8MM	200	39100.040.008	6X100MM	50	39100.060.100	20X120MM	5	39100.200.120
4X10MM	200	39100.040.010						

• Warning: electro-galvanizing of these products may cause hydrogen embrittlement.

Spring-type straight pin slotted, light duty

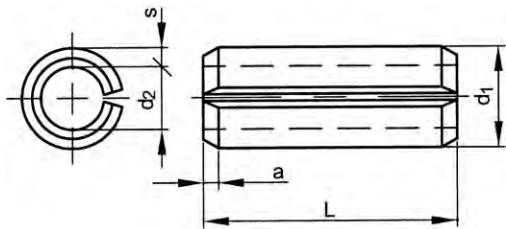

ISO 13337
DIN 7346
NEN 2459



Technical Data

d (nom.)	a	d ₁ (max.)	d ₁ (min.)	d ₂ ≈	s	V
2	0.2	2.4	2.3	1.9	0.2	1.5
2.5	0.25	2.9	2.8	2.3	0.25	2.4
3	0.25	3.5	3.3	2.7	0.3	3.5
4	0.5	4.6	4.4	3.4	0.5	8
5	0.5	5.6	5.4	4.4	0.5	10.4
6	0.7	6.7	6.4	4.9	0.75	18
8	1.5	8.8	8.5	7	0.75	24
10	2	10.8	10.5	8.5	1	40
13	2	13.8	13.5	11	1.25	66

- V = Shear strength double min. in kN.
- For the hole diameter d(nom.) with tolerance field H12 is recommended.
- a: pins over 10mm have a single bevelled edge.

Special features spring type straight pins:

- are used to connect two or more construction elements to each other
- highly suitable to absorb shear forces
- to avoid movements in light bolt connections spring type straight pins can be used acc. to information below

d (nom.) spring type straight pin slotted	6	7	8	11	13	16	18
intended for bolt size	M4	M5	M6	M8	M10	M12	M14
associated washers acc. to DIN 125-1A	4,3	5,3	6,4	8,4	10,5	13	15

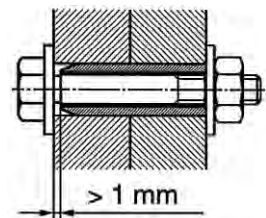

39060 Spring-type straight pin slotted, light duty

L09A

Material Spring steel 420-560 HV30



d (nom.) x L	☒	Art.number	d (nom.) x L	☒	Art.number	d (nom.) x L	☒	Art.number
2X8MM	200	39060.020.008	4X10MM	200	39060.040.010	6X20MM	100	39060.060.020
2X10MM	200	39060.020.010	4X12MM	200	39060.040.012	6X24MM	100	39060.060.024
2X12MM	200	39060.020.012	4X14MM	200	39060.040.014	6X28MM	100	39060.060.028
2X14MM	200	39060.020.014	4X16MM	200	39060.040.016	6X30MM	100	39060.060.030
2X16MM	200	39060.020.016	4X20MM	200	39060.040.020	6X32MM	100	39060.060.032
2X18MM	200	39060.020.018	4X22MM	200	39060.040.022	6X36MM	100	39060.060.036
2X20MM	200	39060.020.020	4X24MM	200	39060.040.024	6X40MM	100	39060.060.040
2X24MM	200	39060.020.024	4X28MM	200	39060.040.028	6X50MM	50	39060.060.050
2X28MM	200	39060.020.028	4X30MM	200	39060.040.030	8X10MM	100	39060.080.010
2,5X6MM	200	39060.025.006	4X36MM	100	39060.040.036	8X12MM	100	39060.080.012
2,5X8MM	200	39060.025.008	4X40MM	100	39060.040.040	8X16MM	100	39060.080.016
2,5X10MM	200	39060.025.010	4X45MM	100	39060.040.045	8X20MM	100	39060.080.020
2,5X12MM	200	39060.025.012	4X50MM	100	39060.040.050	8X22MM	100	39060.080.022
2,5X14MM	200	39060.025.014	5X6MM	200	39060.050.006	8X24MM	100	39060.080.024
2,5X16MM	200	39060.025.016	5X8MM	200	39060.050.008	8X26MM	100	39060.080.026
2,5X20MM	200	39060.025.020	5X10MM	200	39060.050.010	8X30MM	50	39060.080.030
2,5X24MM	200	39060.025.024	5X12MM	200	39060.050.012	8X32MM	50	39060.080.032
2,5X30MM	200	39060.025.030	5X16MM	200	39060.050.016	8X36MM	50	39060.080.036
3X8MM	200	39060.030.008	5X20MM	100	39060.050.020	8X40MM	50	39060.080.040
3X10MM	200	39060.030.010	5X28MM	100	39060.050.028	8X45MM	50	39060.080.045
3X12MM	200	39060.030.012	5X30MM	100	39060.050.030	8X50MM	50	39060.080.050
3X16MM	200	39060.030.016	5X36MM	100	39060.050.036	10X12MM	50	39060.100.012
3X20MM	200	39060.030.020	5X40MM	100	39060.050.040	10X16MM	50	39060.100.016
3X22MM	200	39060.030.022	6X10MM	200	39060.060.010	10X20MM	50	39060.100.020
3X24MM	200	39060.030.024	6X12MM	200	39060.060.012	10X24MM	50	39060.100.024
3X30MM	200	39060.030.030	6X16MM	200	39060.060.016	10X30MM	50	39060.100.030
3X36MM	200	39060.030.036				10X40MM	25	39060.100.040
3X40MM	200	39060.030.040						

39060 Spring-type straight pin slotted, light duty ←

d (nom.) x L	☒	Art.number	d (nom.) x L	☒	Art.number
10X50MM	25	39060.100.050	10X60MM	25	39060.100.060

• Warning: electro-galvanizing of these products may cause hydrogen embrittlement.

Spring-type straight pin heavy type A2

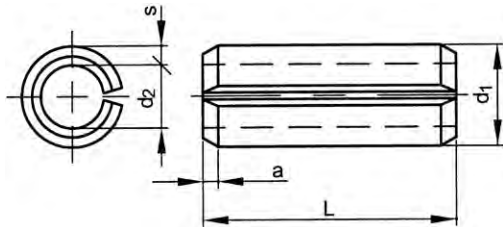

DIN	≈1481
ISO	≈8752
NEN	≈2458
BS	≈7060



Technical Data

d (nom.)	a	d ₁ (max.)	d ₁ (min.)	d ₂ ≈	s	V
1	0.15	1.3	1.2	0.8	0.2	0.44
1.5	0.25	1.8	1.7	1.1	0.3	0.98
2	0.35	2.4	2.3	1.5	0.4	1.8
2.5	0.4	2.9	2.8	1.8	0.5	2.84
3	0.5	3.5	3.3	2.1	0.6	4.06
3.5	0.6	4	3.8	2.3	0.75	9.06
4	0.65	4.6	4.4	2.8	0.8	7.24
4.5	0.8	5.1	4.9	2.9	1	15.36
5	0.9	5.6	5.4	3.4	1	10.74
6	1.2	6.7	6.4	3.9	1.25	16.16
8	2	8.8	8.5	5.5	1.5	26.46
10	2	10.8	10.5	6.5	2	42.14
12	2	12.8	12.5	7.5	2.5	-

- V = Shear strength double min. in kN.
- The austenetic steel type is at the manufacturer's discretion, and can vary from the steel types stated in DIN 267-11.
- For the hole diameter d(nom.) with tolerance field H12 is recommended.
- a: Bevelled edges of 30° on both sides for sizes up to and including 6mm, pins over 6mm have a single bevelled edge of 15°.

Special features spring-type straight pins:

- are used to connect two or more construction elements to each other
- highly suitable to absorb shear forces
- to avoid movements in light bolt connections, spring-type straight pins can be used according to information stated below:

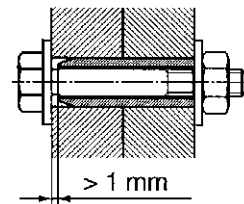

d (nom.) spring-type straight pin slotted	6	8	10	12	16	18
intended for bolt size	M3	M4	M5	M6	M8	M10
associated washers acc. to DIN 7349	3,2	4,3	5,3	6,4	8,4	10,5

9

51428 Spring-type straight pin heavy type A2 R09A

Material Stainless steel A2



d (nom.) x L	☒	Art.number	d (nom.) x L	☒	Art.number	d (nom.) x L	☒	Art.number
1X4MM*	1000	51428.010.004	1,5X20MM	200	51428.015.020	2,5X4MM*	1000	51428.025.004
1X5MM*	1000	51428.010.005				2,5X5MM*	1000	51428.025.005
1X10MM*	1000	51428.010.010	2X4MM*	1000	51428.020.004	2,5X6MM*	1000	51428.025.006
1X12MM*	1000	51428.010.012	2X5MM*	1000	51428.020.005	2,5X8MM*	1000	51428.025.008
1X14MM*	1000	51428.010.014	2X6MM	200	51428.020.006	2,5X10MM*	1000	51428.025.010
1X16MM*	1000	51428.010.016	2X8MM	200	51428.020.008	2,5X12MM	200	51428.025.012
1X18MM*	1000	51428.010.018	2X10MM	200	51428.020.010	2,5X14MM	200	51428.025.014
			2X12MM	200	51428.020.012	2,5X16MM	200	51428.025.016
1,5X4MM*	1000	51428.015.004	2X14MM*	1000	51428.020.014	2,5X18MM*	1000	51428.025.018
1,5X5MM*	1000	51428.015.005	2X16MM	200	51428.020.016	2,5X20MM	200	51428.025.020
1,5X6MM	200	51428.015.006	2X18MM*	1000	51428.020.018	2,5X22MM*	1000	51428.025.022
1,5X8MM	200	51428.015.008	2X20MM	200	51428.020.020	2,5X24MM	200	51428.025.024
1,5X10MM	200	51428.015.010	2X22MM*	1000	51428.020.022	2,5X26MM	200	51428.025.026
1,5X12MM	200	51428.015.012	2X24MM	200	51428.020.024	2,5X28MM	200	51428.025.028
1,5X14MM*	1000	51428.015.014	2X26MM*	1000	51428.020.026	2,5X30MM	200	51428.025.030
1,5X16MM	200	51428.015.016	2X30MM	200	51428.020.030			
1,5X18MM*	1000	51428.015.018				3X4MM*	1000	51428.030.004

51428 Spring-type straight pin heavy type A2

d (nom.) x L	☒	Art.number	d (nom.) x L	☒	Art.number	d (nom.) x L	☒	Art.number
3X5MM*	1000	51428.030.005	4,5X16MM*	500	51428.045.016	8X10MM*	500	51428.080.010
3X6MM*	1000	51428.030.006	4,5X18MM*	500	51428.045.018	8X12MM*	500	51428.080.012
3X8MM	200	51428.030.008	4,5X20MM*	500	51428.045.020	8X14MM*	500	51428.080.014
3X10MM	200	51428.030.010	4,5X24MM*	500	51428.045.024	8X16MM*	500	51428.080.016
3X12MM	200	51428.030.012	4,5X26MM*	500	51428.045.026	8X18MM*	500	51428.080.018
3X14MM	200	51428.030.014	4,5X28MM*	500	51428.045.028	8X20MM*	500	51428.080.020
3X16MM	200	51428.030.016	4,5X30MM*	500	51428.045.030	8X22MM*	500	51428.080.022
3X18MM	200	51428.030.018	4,5X32MM*	500	51428.045.032	8X24MM*	500	51428.080.024
3X20MM	200	51428.030.020	4,5X36MM*	500	51428.045.036	8X26MM*	250	51428.080.026
3X22MM*	1000	51428.030.022	4,5X40MM*	500	51428.045.040	8X28MM*	250	51428.080.028
3X24MM	200	51428.030.024	4,5X45MM*	500	51428.045.045	8X30MM	50	51428.080.030
3X26 MM	200	51428.030.026	4,5X50MM*	500	51428.045.050	8X32MM*	250	51428.080.032
3X28MM*	1000	51428.030.028				8X35MM	50	51428.080.035
3X30MM	200	51428.030.030	5X6MM*	500	51428.050.006	8X40MM	50	51428.080.040
3X32MM	200	51428.030.032	5X8MM*	500	51428.050.008	8X45MM*	250	51428.080.045
3X35MM	200	51428.030.035	5X10MM*	500	51428.050.010	8X50MM	50	51428.080.050
3X40MM	200	51428.030.040	5X12MM*	500	51428.050.012	8X55MM*	250	51428.080.055
			5X14MM*	500	51428.050.014	8X60MM	50	51428.080.060
3,5X8MM*	1000	51428.035.008	5X16MM	100	51428.050.016	8X65MM*	250	51428.080.065
3,5X10MM*	1000	51428.035.010	5X18MM*	500	51428.050.018	8X70MM	50	51428.080.070
3,5X12MM*	1000	51428.035.012	5X20MM	100	51428.050.020	8X75MM*	250	51428.080.075
3,5X14MM*	1000	51428.035.014	5X22MM*	500	51428.050.022	8X80MM	50	51428.080.080
3,5X16MM*	1000	51428.035.016	5X24MM	100	51428.050.024	8X85MM*	200	51428.080.085
3,5X18MM*	1000	51428.035.018	5X26MM	100	51428.050.026	8X90MM*	100	51428.080.090
3,5X20MM*	1000	51428.035.020	5X30MM	100	51428.050.030	8X100MM	50	51428.080.100
3,5X22MM*	1000	51428.035.022	5X32MM*	500	51428.050.032			
3,5X24MM*	1000	51428.035.024	5X35MM	100	51428.050.035	10X12MM*	500	51428.100.012
3,5X26MM*	1000	51428.035.026	5X36 MM	100	51428.050.036	10X14MM*	500	51428.100.014
3,5X28MM*	1000	51428.035.028	5X40MM	100	51428.050.040	10X16MM*	500	51428.100.016
3,5X30MM*	1000	51428.035.030	5X45MM	100	51428.050.045	10X18MM*	500	51428.100.018
3,5X32MM*	1000	51428.035.032	5X50MM	100	51428.050.050	10X20MM	50	51428.100.020
3,5X36MM*	1000	51428.035.036	5X55MM*	250	51428.050.055	10X22MM*	500	51428.100.022
3,5X40MM*	1000	51428.035.040	5X60MM	100	51428.050.060	10X25MM*	500	51428.100.025
			5X65MM*	250	51428.050.065	10X26MM*	500	51428.100.026
4X4MM*	500	51428.040.004	5X70MM	100	51428.050.070	10X28MM*	500	51428.100.028
4X5MM*	500	51428.040.005				10X30MM	50	51428.100.030
4X6MM*	500	51428.040.006	6X12MM	100	51428.060.012	10X32MM*	500	51428.100.032
4X8MM*	500	51428.040.008	6X14MM*	500	51428.060.014	10X35MM	25	51428.100.035
4X10MM*	500	51428.040.010	6X16MM	100	51428.060.016	10X36MM*	250	51428.100.036
4X12MM	200	51428.040.012	6X18MM*	500	51428.060.018	10X40MM	25	51428.100.040
4X14MM	200	51428.040.014	6X20MM	500	51428.060.020	10X45MM*	250	51428.100.045
4X16MM	200	51428.040.016	6X22MM*	500	51428.060.022	10X50MM	25	51428.100.050
4X18MM*	500	51428.040.018	6X24MM	100	51428.060.024	10X55MM*	200	51428.100.055
4X20MM	200	51428.040.020	6X26MM	100	51428.060.026	10X60MM	25	51428.100.060
4X22MM*	500	51428.040.022	6X28MM*	500	51428.060.028	10X65MM*	200	51428.100.065
4X24MM	200	51428.040.024	6X30MM	100	51428.060.030	10X70MM	25	51428.100.070
4X26MM	200	51428.040.026	6X32MM	100	51428.060.032	10X75MM*	100	51428.100.075
4X28MM*	500	51428.040.028	6X35MM	50	51428.060.035	10X80MM	10	51428.100.080
4X30MM	200	51428.040.030	6X36MM	100	51428.060.036	10X85MM*	100	51428.100.085
4X32MM	100	51428.040.032	6X40MM	100	51428.060.040	10X90MM*	100	51428.100.090
4X35MM	50	51428.040.035	6X45MM*	250	51428.060.045	10X95MM*	100	51428.100.095
4X40MM	100	51428.040.040	6X50MM	50	51428.060.050	10X100MM	10	51428.100.100
4X45MM*	500	51428.040.045	6X55MM*	250	51428.060.055	10X120MM*	50	51428.100.120
4X50MM	100	51428.040.050	6X60MM	50	51428.060.060			
			6X65MM*	250	51428.060.065			
4,5X10MM*	500	51428.045.010	6X70MM	50	51428.060.070	12X30MM	200	51428.120.030
4,5X12MM*	500	51428.045.012	6X75MM*	250	51428.060.075			
4,5X14MM*	500	51428.045.014	6X80MM	50	51428.060.080			

Round head rivet

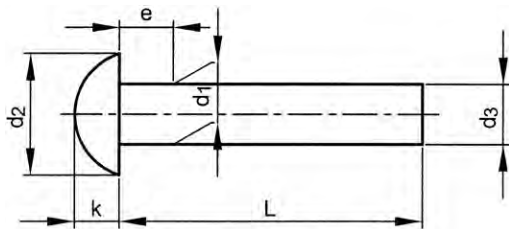

DIN 660/124
ISO 1051
BS 4620

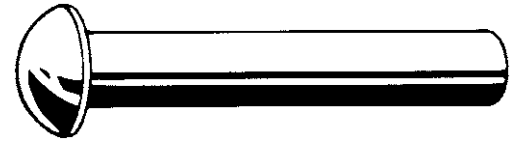

Technical Data

d_1	d_2	d_3 (min.)	e (max.)	k (js14)
2	3.5	1.87	1	1.2
2.5	4.4	2.37	1.25	1.5
3	5.2	2.87	1.5	1.8
4	7	3.87	2	2.4
5	8.8	4.82	2.5	3
6	10.5	5.82	3	3.6
8	14	7.76	4	4.8
10 (DIN124)	16	9.4	5	6.5

Article groups

Material	Code	Page
St EN 10263-2	39400	9-32
St.St. A2	51490	9-32
St.St. A4	55490	9-33
Al 99,5 EN1301-2	50670	9-33
Cu EN 10263-5	50370	9-34

39400 Round head rivet

L11C

Material Steel EN 10263-2

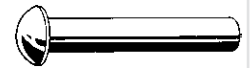

d_1 x L	☒	Art.number	d_1 x L	☒	Art.number	d_1 x L	☒	Art.number
2X6MM	1000	39400.020.006	4X25MM	500	39400.040.025	6X40MM	250	39400.060.040
2X8MM	1000	39400.020.008	4X30MM	500	39400.040.030	6X50MM	250	39400.060.050
2X10MM	1000	39400.020.010	4X40MM	250	39400.040.040	6X60MM	100	39400.060.060
2X12MM	1000	39400.020.012						
2X16MM	1000	39400.020.016	5X8MM	1000	39400.050.008	8X10MM	250	39400.080.010
			5X10MM	1000	39400.050.010	8X12MM	250	39400.080.012
3X6MM	1000	39400.030.006	5X12MM	1000	39400.050.012	8X16MM	250	39400.080.016
3X8MM	1000	39400.030.008	5X16MM	1000	39400.050.016	8X20MM	250	39400.080.020
3X10MM	1000	39400.030.010	5X20MM	500	39400.050.020	8X25MM	250	39400.080.025
3X12MM	1000	39400.030.012	5X25MM	500	39400.050.025	8X30MM	250	39400.080.030
3X16MM	1000	39400.030.016	5X30MM	500	39400.050.030	8X35MM	100	39400.080.035
3X20MM	1000	39400.030.020	5X40MM	250	39400.050.040	8X40MM	100	39400.080.040
3X25MM	1000	39400.030.025	5X50MM	250	39400.050.050	8X50MM	100	39400.080.050
3X30MM	1000	39400.030.030				8X60MM	100	39400.080.060
			6X10MM	500	39400.060.010			
4X6MM	1000	39400.040.006	6X12MM	500	39400.060.012	10X20MM	100	39400.100.020
4X8MM	1000	39400.040.008	6X16MM	500	39400.060.016	10X25MM	100	39400.100.025
4X10MM	1000	39400.040.010	6X20MM	500	39400.060.020	10X30MM	100	39400.100.030
4X12MM	1000	39400.040.012	6X25MM	250	39400.060.025	10X35MM	100	39400.100.035
4X16MM	1000	39400.040.016	6X30MM	250	39400.060.030	10X40MM	100	39400.100.040
4X20MM	1000	39400.040.020	6X35MM	250	39400.060.035	10X50MM	100	39400.100.050

51490 Round head rivet

R09A

Material Stainless steel A2

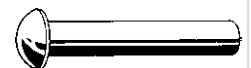

d_1 x L	☒	Art.number	d_1 x L	☒	Art.number	d_1 x L	☒	Art.number
2X6MM*	500	51490.020.006	2X12MM*	500	51490.020.012	2,5X6MM*	500	51490.025.006
2X8MM*	500	51490.020.008	2X16MM*	500	51490.020.016	2,5X8MM*	500	51490.025.008
2X10MM*	500	51490.020.010	2X20MM*	500	51490.020.020			

51490 Round head rivet								
d ₁ x L	☒	Art.number	d ₁ x L	☒	Art.number	d ₁ x L	☒	Art.number
2,5X10MM*	500	51490.025.010	4X16MM	100	51490.040.016	5X28MM*	200	51490.050.028
2,5X12MM*	500	51490.025.012	4X18MM*	200	51490.040.018	5X30MM	100	51490.050.030
2,5X35MM*	500	51490.025.035	4X20MM	100	51490.040.020	5X35MM*	200	51490.050.035
3X6MM	200	51490.030.006	4X25MM	100	51490.040.025	5X40MM*	200	51490.050.040
3X8MM	200	51490.030.008	4X28MM*	200	51490.040.028	6X10MM	100	51490.060.010
3X10MM	200	51490.030.010	4X30MM	100	51490.040.030	6X12MM	100	51490.060.012
3X12MM	200	51490.030.012	4X35MM*	200	51490.040.035	6X14MM*	100	51490.060.014
3X14MM*	500	51490.030.014	4X40MM	100	51490.040.040	6X16MM	100	51490.060.016
3X16MM	200	51490.030.016	4X45MM*	200	51490.040.045	6X18MM*	100	51490.060.018
3X18MM*	500	51490.030.018	4X50MM	100	51490.040.050	6X20MM	100	51490.060.020
3X20MM	200	51490.030.020	4X60MM	100	51490.040.060	6X22MM*	100	51490.060.022
3X22MM*	500	51490.030.022	5X8MM	100	51490.050.008	6X25MM	100	51490.060.025
3X25MM*	500	51490.030.025	5X10MM	100	51490.050.010	6X28MM*	100	51490.060.028
4X6MM*	200	51490.040.006	5X12MM	100	51490.050.012	6X30MM	100	51490.060.030
4X8MM	200	51490.040.008	5X14MM*	200	51490.050.014	6X35MM	100	51490.060.035
4X10MM	200	51490.040.010	5X16MM	100	51490.050.016	6X40MM*	100	51490.060.040
4X12MM	200	51490.040.012	5X18MM*	200	51490.050.018	6X45MM*	100	51490.060.045
4X14MM*	200	51490.040.014	5X20MM	100	51490.050.020	6X50MM*	100	51490.060.050
			5X25MM	100	51490.050.025			

55490 Round head rivet		R49A
Material	Stainless steel A4	
		

d ₁ x L	☒	Art.number	d ₁ x L	☒	Art.number	d ₁ x L	☒	Art.number
3X6MM*	500	55490.030.006	4X12MM*	200	55490.040.012	5X12MM*	200	55490.050.012
3X8MM*	500	55490.030.008	4X16MM*	200	55490.040.016	5X20MM*	200	55490.050.020
3X10MM*	500	55490.030.010	4X25MM*	200	55490.040.025	6X10MM*	100	55490.060.010
3X20MM*	500	55490.030.020	4X35MM*	200	55490.040.035	6X12MM*	100	55490.060.012
4X6MM*	200	55490.040.006	4X40MM*	200	55490.040.040	6X20MM*	100	55490.060.020
4X8MM*	200	55490.040.008	5X8MM*	200	55490.050.008	6X30MM*	100	55490.060.030
4X10MM*	200	55490.040.010	5X10MM*	200	55490.050.010	6X35MM*	100	55490.060.035

50670 Round head rivet		W01A
Material	Aluminium 99,5 EN1301-2	
		

d ₁ x L	☒	Art.number	d ₁ x L	☒	Art.number	d ₁ x L	☒	Art.number
2X4MM	1000	50670.020.004	4X6MM	1000	50670.040.006	6X10MM	500	50670.060.010
2X6MM	1000	50670.020.006	4X8MM	1000	50670.040.008	6X12MM	500	50670.060.012
2X8MM	1000	50670.020.008	4X10MM	1000	50670.040.010	6X16MM	500	50670.060.016
2X10MM	1000	50670.020.010	4X12MM	1000	50670.040.012	6X20MM	500	50670.060.020
2X12MM	1000	50670.020.012	4X16MM	1000	50670.040.016	6X25MM	250	50670.060.025
2X16MM	1000	50670.020.016	4X20MM	1000	50670.040.020	6X30MM	250	50670.060.030
3X4MM	1000	50670.030.004	4X25MM	500	50670.040.025	6X35MM	250	50670.060.035
3X6MM	1000	50670.030.006	4X30MM	500	50670.040.030	6X40MM	250	50670.060.040
3X7MM	1000	50670.030.007	4X40MM	250	50670.040.040	6X50MM	250	50670.060.050
3X8MM	1000	50670.030.008	5X8MM	1000	50670.050.008	8X16MM	250	50670.080.016
3X10MM	1000	50670.030.010	5X10MM	1000	50670.050.010	8X20MM	250	50670.080.020
3X12MM	1000	50670.030.012	5X12MM	1000	50670.050.012	8X25MM	250	50670.080.025
3X16MM	1000	50670.030.016	5X16MM	1000	50670.050.016	8X30MM	250	50670.080.030
3X20MM	1000	50670.030.020	5X20MM	500	50670.050.020	8X35MM	100	50670.080.035
3X25MM	1000	50670.030.025	5X25MM	500	50670.050.025	8X40MM	100	50670.080.040
3X30MM	1000	50670.030.030	5X30MM	500	50670.050.030			
			5X40MM	250	50670.050.040			

50370	Round head rivet	M11F
Material	Copper EN 10263-5	
		 

$d_1 \times L$	☒	Art.number	$d_1 \times L$	☒	Art.number	$d_1 \times L$	☒	Art.number
2X4MM	1000	50370.020.004	4X6MM	1000	50370.040.006	6X10MM	500	50370.060.010
2X6MM	1000	50370.020.006	4X8MM	1000	50370.040.008	6X12MM	500	50370.060.012
2X8MM	1000	50370.020.008	4X10MM	1000	50370.040.010	6X16MM	500	50370.060.016
2X10MM	1000	50370.020.010	4X12MM	1000	50370.040.012	6X20MM	500	50370.060.020
2X12MM	1000	50370.020.012	4X16MM	1000	50370.040.016	6X25MM	250	50370.060.025
2X16MM	1000	50370.020.016	4X20MM	1000	50370.040.020	6X30MM	250	50370.060.030
			4X25MM	500	50370.040.025	6X35MM	250	50370.060.035
2.5X6MM	1000	50370.025.006	4X30MM	500	50370.040.030	6X40MM	250	50370.060.040
2.5X8MM	1000	50370.025.008	4X40MM	250	50370.040.040	6X50MM	250	50370.060.050
2.5X10MM	1000	50370.025.010						
			5X8MM	1000	50370.050.008	8X16MM	250	50370.080.016
3X4MM	1000	50370.030.004	5X10MM	1000	50370.050.010	8X20MM	250	50370.080.020
3X6MM	1000	50370.030.006	5X12MM	1000	50370.050.012	8X25MM	250	50370.080.025
3X8MM	1000	50370.030.008	5X16MM	1000	50370.050.016	8X30MM	250	50370.080.030
3X10MM	1000	50370.030.010	5X20MM	500	50370.050.020	8X40MM	100	50370.080.040
3X12MM	1000	50370.030.012	5X25MM	500	50370.050.025	8X50MM	100	50370.080.050
3X16MM	1000	50370.030.016	5X30MM	500	50370.050.030			
3X20MM	1000	50370.030.020	5X40MM	250	50370.050.040	10X30MM	100	50370.100.030
3X25MM	1000	50370.030.025	5X50MM	250	50370.050.050	10X40MM	100	50370.100.040
3X30MM	1000	50370.030.030				10X50MM	100	50370.100.050

Countersunk head rivet

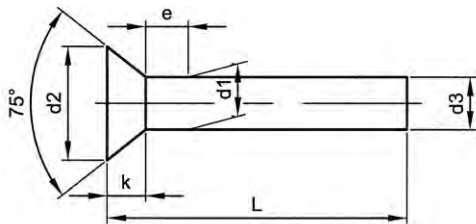

DIN 661/302
ISO 1051
BS 4620

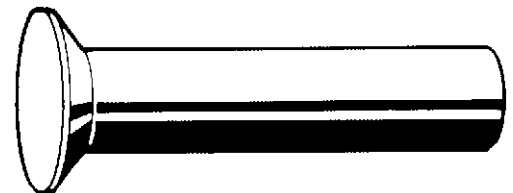

Technical Data

d_1	d_2	d_3 (min.)	e (max.)	$k \approx$
2	3.5	1.87	1	1
2.5	4.4	2.37	1.25	1.2
3	5.2	2.87	1.5	1.4
4	7	3.87	2	2
5	8.8	4.82	2.5	2.5
6	10.5	5.82	3	3
8	14	7.76	4	4
10 (DIN302)	14.5	9.4	5	3

Article groups

Material	Code	Page
St EN 10263-2	39410	9-34
St.St. A2	51480	9-35
Al 99,5 EN1301-2	50680	9-35
Cu EN 12166	50380	9-36

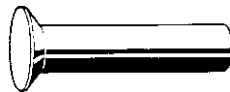
39410	Countersunk head rivet	L11C
Material	Steel EN 10263-2	
		 

$d_1 \times L$	☒	Art.number	$d_1 \times L$	☒	Art.number	$d_1 \times L$	☒	Art.number
2X6MM	1000	39410.020.006	3X6MM	1000	39410.030.006	3X16MM	1000	39410.030.016
2X8MM	1000	39410.020.008	3X8MM	1000	39410.030.008	3X20MM	1000	39410.030.020
2X10MM	1000	39410.020.010	3X10MM	1000	39410.030.010	3X25MM	1000	39410.030.025
2X12MM	1000	39410.020.012	3X12MM	1000	39410.030.012	3X30MM	1000	39410.030.030
2X16MM	1000	39410.020.016						

39410 Countersunk head rivet								
d ₁ x L	☒	Art.number	d ₁ x L	☒	Art.number	d ₁ x L	☒	Art.number
4X6MM	1000	39410.040.006	5X25MM	500	39410.050.025	8X16MM	250	39410.080.016
4X8MM	1000	39410.040.008	5X30MM	500	39410.050.030	8X20MM	250	39410.080.020
4X10MM	1000	39410.040.010	5X40MM	250	39410.050.040	8X25MM	250	39410.080.025
4X12MM	1000	39410.040.012	5X50MM	250	39410.050.050	8X30MM	250	39410.080.030
4X16MM	1000	39410.040.016	6X10MM	500	39410.060.010	8X35MM	100	39410.080.035
4X20MM	1000	39410.040.020	6X12MM	500	39410.060.012	8X40MM	100	39410.080.040
4X25MM	500	39410.040.025	6X16MM	500	39410.060.016	8X50MM	100	39410.080.050
4X30MM	500	39410.040.030	6X20MM	500	39410.060.020	8X60MM	100	39410.080.060
5X8MM	1000	39410.050.008	6X25MM	250	39410.060.025	10X30MM	100	39410.100.030
5X10MM	1000	39410.050.010	6X30MM	250	39410.060.030	10X40MM	100	39410.100.040
5X12MM	1000	39410.050.012	6X35MM	250	39410.060.035	10X50MM	100	39410.100.050
5X16MM	1000	39410.050.016	6X40MM	250	39410.060.040			
5X20MM	500	39410.050.020	6X50MM	250	39410.060.050			

51480 Countersunk head rivet		R09A
Material	Stainless steel A2	
		
		

d ₁ x L	☒	Art.number	d ₁ x L	☒	Art.number	d ₁ x L	☒	Art.number
2X6MM*	500	51480.020.006	4X4MM*	200	51480.040.004	5X18MM*	200	51480.050.018
2X8MM*	500	51480.020.008	4X6MM*	200	51480.040.006	5X20MM	100	51480.050.020
2X10MM*	500	51480.020.010	4X8MM	200	51480.040.008	5X22MM*	200	51480.050.022
2X12MM*	500	51480.020.012	4X10MM	200	51480.040.010	5X25MM	100	51480.050.025
2X16MM*	500	51480.020.016	4X12MM	200	51480.040.012	5X30MM	100	51480.050.030
2X20MM*	500	51480.020.020	4X16MM	100	51480.040.016	5X35MM*	200	51480.050.035
3X6MM	200	51480.030.006	4X18MM*	200	51480.040.018	5X40MM*	200	51480.050.040
3X8MM	200	51480.030.008	4X20MM	100	51480.040.020	6X10MM	100	51480.060.010
3X10MM	200	51480.030.010	4X22MM*	200	51480.040.022	6X12MM	100	51480.060.012
3X12MM	200	51480.030.012	4X25MM	100	51480.040.025	6X16MM	100	51480.060.016
3X16MM	200	51480.030.016	4X30MM	100	51480.040.030	6X18MM*	100	51480.060.018
3X18MM*	500	51480.030.018	5X8MM	100	51480.050.008	6X20MM	100	51480.060.020
3X20MM*	500	51480.030.020	5X10MM	100	51480.050.010	6X25MM	100	51480.060.025
3X22MM*	500	51480.030.022	5X12MM	100	51480.050.012	6X30MM	100	51480.060.030
3X25MM*	500	51480.030.025	5X14MM*	200	51480.050.014	6X40MM*	100	51480.060.040
			5X16MM	100	51480.050.016	6X50MM*	100	51480.060.050

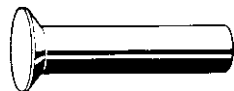
50680 Countersunk head rivet		W01A
Material	Aluminium 99,5 EN1301-2	
		
		

d ₁ x L	☒	Art.number	d ₁ x L	☒	Art.number	d ₁ x L	☒	Art.number
2X6MM	1000	50680.020.006	4X10MM	1000	50680.040.010	6X12MM	500	50680.060.012
2X8MM	1000	50680.020.008	4X12MM	1000	50680.040.012	6X16MM	500	50680.060.016
2X10MM	1000	50680.020.010	4X16MM	1000	50680.040.016	6X20MM	500	50680.060.020
2X12MM	1000	50680.020.012	4X20MM	1000	50680.040.020	6X25MM	250	50680.060.025
2X16MM	1000	50680.020.016	4X25MM	500	50680.040.025	6X30MM	250	50680.060.030
3X6MM	1000	50680.030.006	4X30MM	500	50680.040.030	6X35MM	250	50680.060.035
3X8MM	1000	50680.030.008	5X8MM	1000	50680.050.008	6X40MM	250	50680.060.040
3X10MM	1000	50680.030.010	5X10MM	1000	50680.050.010	6X50MM	250	50680.060.050
3X12MM	1000	50680.030.012	5X12MM	1000	50680.050.012	8X16MM	250	50680.080.016
3X16MM	1000	50680.030.016	5X16MM	1000	50680.050.016	8X20MM	250	50680.080.020
3X20MM	1000	50680.030.020	5X20MM	500	50680.050.020	8X25MM	250	50680.080.025
3X25MM	1000	50680.030.025	5X25MM	500	50680.050.025	8X30MM	250	50680.080.030
3X30MM	1000	50680.030.030	5X30MM	500	50680.050.030	8X35MM	100	50680.080.035
4X6MM	1000	50680.040.006	5X40MM	250	50680.050.040	8X40MM	100	50680.080.040
4X8MM	1000	50680.040.008	6X10MM	500	50680.060.010	8X50MM	100	50680.080.050

50380 Countersunk head rivet M11F

Material Copper EN 12166



$d_1 \times L$	☒	Art.number	$d_1 \times L$	☒	Art.number	$d_1 \times L$	☒	Art.number
2X6MM	1000	50380.020.006	4X12MM	1000	50380.040.012	6X10MM	500	50380.060.010
2X8MM	1000	50380.020.008	4X16MM	1000	50380.040.016	6X16MM	500	50380.060.016
2X10MM	1000	50380.020.010	4X20MM	1000	50380.040.020	6X20MM	500	50380.060.020
			4X25MM	500	50380.040.025	6X25MM	250	50380.060.025
3X6MM	1000	50380.030.006	4X30MM	500	50380.040.030	6X30MM	250	50380.060.030
3X8MM	1000	50380.030.008				6X40MM	250	50380.060.040
3X10MM	1000	50380.030.010	5X10MM	1000	50380.050.010	6X50MM	250	50380.060.050
3X12MM	1000	50380.030.012	5X12MM	1000	50380.050.012			
3X16MM	1000	50380.030.016	5X16MM	1000	50380.050.016	8X16MM	250	50380.080.016
3X20MM	1000	50380.030.020	5X20MM	500	50380.050.020	8X20MM	250	50380.080.020
3X25MM	1000	50380.030.025	5X25MM	500	50380.050.025	8X25MM	250	50380.080.025
			5X30MM	500	50380.050.030	8X30MM	250	50380.080.030
4X8MM	1000	50380.040.008	5X40MM	250	50380.050.040	8X40MM	100	50380.080.040
4X10MM	1000	50380.040.010	5X50MM	250	50380.050.050			

Clevis pin with head and split pin hole

DIN 1434

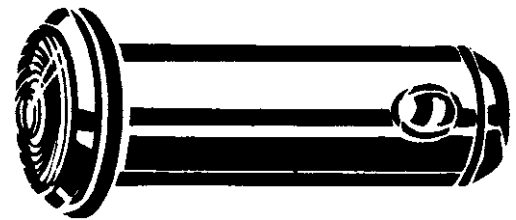
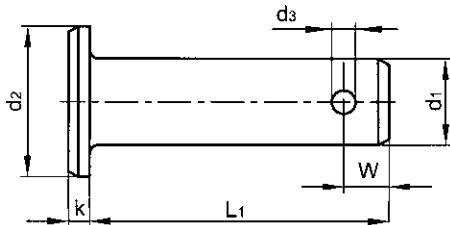

Technical Data

d_1 (h11)	d_2 (h14)	d_3 (H14)	k (js14)	W (min.)
4	6	1	1	1.8
5	8	1.6	1.5	2
6	9	1.6	1.5	2.5
8	12	2	2	3
10	14	3.2	2	4
12	17	4	3	5
14	19	4	3	5
16	21	4	3	5

39797 Clevis pin with head and split pin hole L11F

Material Steel
Surface treatment Zinc plated



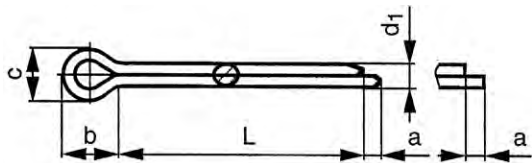

$d_1 \times L_1$	☒	Art.number	$d_1 \times L_1$	☒	Art.number	$d_1 \times L_1$	☒	Art.number
4X12MM	100	39797.040.012	8X22MM	100	39797.080.022	14X40MM	25	39797.140.040
5X14MM	100	39797.050.014	10X28MM	50	39797.100.028	16X45MM	10	39797.160.045
6X18MM	100	39797.060.018	12X35MM	25	39797.120.035			

Split pin (cotter pin)

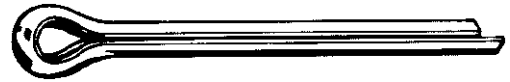

DIN 94
ISO 1234
NEN 182
NF E25-774



Technical Data

d (nom.)	a (max.)	b ≈	c (max.)	c (min.)	d ₁ (max.)	d ₁ (min.)
1	1.6	3	1.8	1.6	0.9	0.8
1.2	2.5	3	2	1.7	1	0.9
1.6	2.5	3.2	2.8	2.4	1.4	1.3
2	2.5	4	3.6	3.2	1.8	1.7
2.5	2.5	5	4.6	4	2.3	2.1
3.2	3.2	6.4	5.8	5.1	2.9	2.7
3.5 (#DIN)	3.5	7	6.8	6.1	3.2	3
4	4	8	7.4	6.5	3.7	3.5
4.5 (#DIN)	4	8.5	8.2	7.6	4.2	4
5	4	10	9.2	8	4.6	4.4
6.3	4	12.6	11.8	10.3	5.9	5.7
7 (#DIN)	4.7	12.3	12.5	12.45	6.5	6.7
8	4	16	15	13.1	7.5	7.3
10	6.3	20	19	16.6	9.5	9.3
13	6.3	26	24.8	21.7	12.4	12.1

- For the split pin hole, tolerance H13 is recommended for d (nom.) ≤ 1,2 mm and tolerance H14 for d (nom.) ≥ 1,6 mm and above.
- Shape of the split pin ends at the manufacturer's discretion.
- The nominal length (L) is with tolerance js17.

Table-choice of split pins

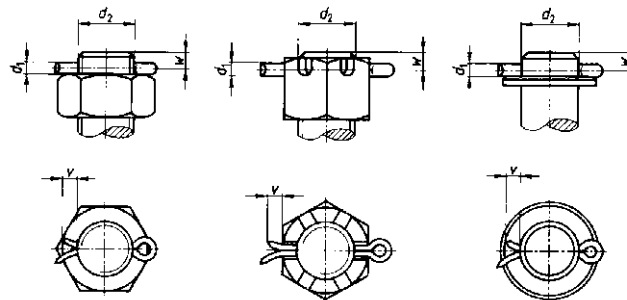

d (nom.)		1	1,6	2	2,5	3,2	4	5	6,3	8	10	13	
d2	parts with thread*	above	3,5	5,5	7	9	11	14	20	27	39	56	80
		up to incl.	4,5	7	9	11	14	20	27	39	56	80	120
	parts without thread**	above	3	5	6	8	9	12	17	23	29	44	69
		up to incl.	4	6	8	9	12	17	23	29	44	69	110
v	min.	4	5	6	6	8	8	10	12	14	16	20	

* For application in parts with external thread the major diameter of the thread or the diameter of the plain part has to be used.

** For railways and constructions subjecting to alternating transverse forces, it is recommended to use the following larger split pin size.

The hole distance W depends on the construction part in which the split pin is inserted. If necessary see the standard of that particular part.

Article groups

Material	Surface treatment	Code	Page
St		39310	9-38
St	Zipl	39350	9-38
St	Zipl yell.p.	39360	9-39
St.St. A2		51700	9-39
St.St. A4		55700	9-40
Br		50210	9-41
Cu		50390	9-41

39310 Split pin (cotter pin)
L09B
Material Steel

d (nom.) x L	☒	Art.number	d (nom.) x L	☒	Art.number	d (nom.) x L	☒	Art.number
1X12MM	250	39310.010.012	3,2X32MM	250	39310.032.032	6,3X40MM	100	39310.063.040
1X16MM	250	39310.010.016	3,2X40MM	250	39310.032.040	6,3X50MM	100	39310.063.050
1X20MM	250	39310.010.020	3,2X50MM	250	39310.032.050	6,3X63MM	100	39310.063.063
1X25MM	250	39310.010.025	3,2X63MM	250	39310.032.063	6,3X71MM	100	39310.063.071
1X32MM	250	39310.010.032				6,3X80MM	100	39310.063.080
			3,5X25MM	250	39310.035.025	6,3X100MM	100	39310.063.100
1,6X10MM	250	39310.016.010	3,5X30MM	250	39310.035.030			
1,6X12MM	250	39310.016.012	3,5X35MM	250	39310.035.035	7X63MM	100	39310.070.063
1,6X16MM	250	39310.016.016	3,5X40MM	250	39310.035.040	7X80MM	100	39310.070.080
1,6X20MM	250	39310.016.020	3,5X50MM	250	39310.035.050			
1,6X25MM	250	39310.016.025	3,5X60MM	250	39310.035.060	8X40MM	100	39310.080.040
1,6X32MM	250	39310.016.032	3,5X70MM	250	39310.035.070	8X45MM	100	39310.080.045
1,6X40MM	250	39310.016.040	3,5X80MM	250	39310.035.080	8X50MM	100	39310.080.050
1,6X50MM	250	39310.016.050				8X63MM	50	39310.080.063
			4X20MM	250	39310.040.020	8X80MM	50	39310.080.080
2X16MM	250	39310.020.016	4X25MM	250	39310.040.025	8X90MM	50	39310.080.090
2X20MM	250	39310.020.020	4X28MM	250	39310.040.028	8X100MM	50	39310.080.100
2X25MM	250	39310.020.025	4X32MM	250	39310.040.032	8X125MM	50	39310.080.125
2X32MM	250	39310.020.032	4X40MM	250	39310.040.040			
2X40MM	250	39310.020.040	4X50MM	200	39310.040.050	10X63MM	50	39310.100.063
2X50MM	250	39310.020.050	4X63MM	200	39310.040.063	10X71MM	50	39310.100.071
2X63MM	250	39310.020.063	4X80MM	200	39310.040.080	10X80MM	50	39310.100.080
						10X90MM	25	39310.100.090
2,5X16MM	250	39310.025.016	5X25MM	200	39310.050.025	10X100MM	25	39310.100.100
2,5X20MM	250	39310.025.020	5X32MM	200	39310.050.032	10X125MM	25	39310.100.125
2,5X25MM	250	39310.025.025	5X36MM	200	39310.050.036	10X160MM	25	39310.100.160
2,5X32MM	250	39310.025.032	5X40MM	200	39310.050.040			
2,5X40MM	250	39310.025.040	5X50MM	200	39310.050.050	13X63MM	25	39310.130.063
2,5X50MM	250	39310.025.050	5X63MM	100	39310.050.063	13X80MM	25	39310.130.080
2,5X63MM	250	39310.025.063	5X80MM	100	39310.050.080	13X100MM	25	39310.130.100
			5X100MM	100	39310.050.100	13X125MM	25	39310.130.125
3,2X16MM	250	39310.032.016				13X140MM	25	39310.130.140
3,2X20MM	250	39310.032.020	6,3X25MM	100	39310.063.025	13X160MM	25	39310.130.160
3,2X25MM	250	39310.032.025	6,3X32MM	100	39310.063.032			

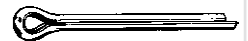
39350 Split pin (cotter pin)
L09B
Material Steel
Surface treatment Zinc plated

d (nom.) x L	☒	Art.number	d (nom.) x L	☒	Art.number	d (nom.) x L	☒	Art.number
1X25MM	250	39350.010.025	2,5X50MM	250	39350.025.050	4X28MM	250	39350.040.028
1X32MM	250	39350.010.032	2,5X63MM	250	39350.025.063	4X32MM	250	39350.040.032
						4X36MM	250	39350.040.036
1,6X10MM	250	39350.016.010	3,2X16MM	250	39350.032.016	4X40MM	250	39350.040.040
1,6X12MM	250	39350.016.012	3,2X20MM	250	39350.032.020	4X45MM	250	39350.040.045
1,6X16MM	250	39350.016.016	3,2X25MM	250	39350.032.025	4X50MM	200	39350.040.050
1,6X20MM	250	39350.016.020	3,2X28MM	250	39350.032.028	4X63MM	200	39350.040.063
1,6X25MM	250	39350.016.025	3,2X32MM	250	39350.032.032	4X71MM	200	39350.040.071
1,6X32MM	250	39350.016.032	3,2X36MM	250	39350.032.036	4X80MM	200	39350.040.080
1,6X40MM	250	39350.016.040	3,2X40MM	250	39350.032.040	4X100MM	200	39350.040.100
1,6X50MM	250	39350.016.050	3,2X45MM	250	39350.032.045			
			3,2X50MM	250	39350.032.050	4,5X40MM	200	39350.045.040
2X16MM	250	39350.020.016	3,2X63MM	250	39350.032.063	4,5X50MM	200	39350.045.050
2X18MM	250	39350.020.018				4,5X63MM	200	39350.045.063
2X20MM	250	39350.020.020	3,5X20MM	250	39350.035.020	4,5X71MM	200	39350.045.071
2X25MM	250	39350.020.025	3,5X25MM	250	39350.035.025			
2X32MM	250	39350.020.032	3,5X30MM	250	39350.035.030	5X25MM	200	39350.050.025
2X36MM	250	39350.020.036	3,5X32MM	250	39350.035.032	5X32MM	200	39350.050.032
2X40MM	250	39350.020.040	3,5X35MM	250	39350.035.035	5X36MM	200	39350.050.036
2X50MM	250	39350.020.050	3,5X36MM	250	39350.035.036	5X40MM	200	39350.050.040
2X63MM	250	39350.020.063	3,5X40MM	250	39350.035.040	5X45MM	200	39350.050.045
			3,5X50MM	250	39350.035.050	5X50MM	200	39350.050.050
2,5X16MM	250	39350.025.016	3,5X60MM	250	39350.035.060	5X56MM	200	39350.050.056
2,5X20MM	250	39350.025.020	3,5X63MM	250	39350.035.063	5X63MM	100	39350.050.063
2,5X25MM	250	39350.025.025	3,5X70MM	250	39350.035.070	5X71MM	100	39350.050.071
2,5X32MM	250	39350.025.032	3,5X80MM	250	39350.035.080	5X80MM	100	39350.050.080
2,5X36MM	250	39350.025.036				5X90MM	100	39350.050.090
2,5X40MM	250	39350.025.040	4X20MM	250	39350.040.020	5X100MM	100	39350.050.100
2,5X45MM	250	39350.025.045	4X25MM	250	39350.040.025			

39350 Split pin (cotter pin) ←								
d (nom.) x L	☒	Art.number	d (nom.) x L	☒	Art.number	d (nom.) x L	☒	Art.number
6,3X32MM	100	39350.063.032	8X40MM	100	39350.080.040	10X90MM	25	39350.100.090
6,3X36MM	100	39350.063.036	8X45MM	100	39350.080.045	10X100MM	25	39350.100.100
6,3X40MM	100	39350.063.040	8X50MM	100	39350.080.050	10X112MM	25	39350.100.112
6,3X45MM	100	39350.063.045	8X63MM	50	39350.080.063	10X125MM	25	39350.100.125
6,3X50MM	100	39350.063.050	8X71MM	50	39350.080.071	10X140MM	25	39350.100.140
6,3X56MM	100	39350.063.056	8X80MM	50	39350.080.080	10X160MM	25	39350.100.160
6,3X63MM	100	39350.063.063	8X90MM	50	39350.080.090	10X180MM	25	39350.100.180
6,3X71MM	100	39350.063.071	8X100MM	50	39350.080.100	10X200MM	25	39350.100.200
6,3X80MM	100	39350.063.080	8X112MM	50	39350.080.112			
6,3X90MM	100	39350.063.090	8X125MM	50	39350.080.125	13X71MM	25	39350.130.071
6,3X100MM	100	39350.063.100	8X140MM	50	39350.080.140	13X100MM	25	39350.130.100
6,3X125MM	100	39350.063.125				13X112MM	25	39350.130.112
			10X56MM	100	39350.100.056	13X125MM	25	39350.130.125
7X71MM	100	39350.070.071	10X63MM	50	39350.100.063	13X140MM	25	39350.130.140
			10X71MM	50	39350.100.071	13X160MM	25	39350.130.160
8X32MM	100	39350.080.032	10X80MM	50	39350.100.080			

39360 Split pin (cotter pin)		L09B
Material	Steel	
Surface treatment	Zinc plated yellow passivated	

d (nom.) x L	☒	Art.number	d (nom.) x L	☒	Art.number	d (nom.) x L	☒	Art.number
2X16MM	250	39360.020.016	3,2X32MM	250	39360.032.032	4X40MM	250	39360.040.040
2X20MM	250	39360.020.020	3,2X40MM	250	39360.032.040	4X50MM	250	39360.040.050
2X25MM	250	39360.020.025						
2X32MM	250	39360.020.032	4X20MM	250	39360.040.020	5X32MM	200	39360.050.032
			4X25MM	250	39360.040.025	5X40MM	200	39360.050.040
3,2X20MM	250	39360.032.020	4X32MM	250	39360.040.032	5X50MM	200	39360.050.050
3,2X25MM	250	39360.032.025						

51700 Split pin (cotter pin)		R09A
Material	Stainless steel A2	

d (nom.) x L	☒	Art.number	d (nom.) x L	☒	Art.number	d (nom.) x L	☒	Art.number
1X6MM*	1000	51700.010.006	1,6X20MM	250	51700.016.020	2,5X36MM*	1000	51700.025.036
1X8MM*	1000	51700.010.008	1,6X22MM*	1000	51700.016.022	2,5X40MM	100	51700.025.040
1X10MM	250	51700.010.010	1,6X25MM	250	51700.016.025	2,5X45MM*	1000	51700.025.045
1X12MM	250	51700.010.012	1,6X28MM*	1000	51700.016.028	2,5X50MM	100	51700.025.050
1X14MM*	1000	51700.010.014	1,6X32MM	250	51700.016.032			
1X16MM	250	51700.010.016	1,6X36MM*	1000	51700.016.036	3,2X16MM	100	51700.032.016
1X18MM*	1000	51700.010.018	1,6X40MM	250	51700.016.040	3,2X18MM*	500	51700.032.018
1X20MM	250	51700.010.020	1,6X45MM*	1000	51700.016.045	3,2X20MM	100	51700.032.020
1X22MM*	1000	51700.010.022				3,2X22MM*	500	51700.032.022
1X25MM	250	51700.010.025	2X6MM*	1000	51700.020.006	3,2X25MM	100	51700.032.025
1X28MM*	1000	51700.010.028	2X10MM	250	51700.020.010	3,2X28MM*	500	51700.032.028
1X32MM	250	51700.010.032	2X12MM*	1000	51700.020.012	3,2X32MM	100	51700.032.032
1X36MM*	1000	51700.010.036	2X14MM*	1000	51700.020.014	3,2X36MM	100	51700.032.036
1X40MM	250	51700.010.040	2X16MM	250	51700.020.016	3,2X40MM	100	51700.032.040
1X45MM*	1000	51700.010.045	2X18MM	250	51700.020.018	3,2X45MM	100	51700.032.045
			2X20MM	250	51700.020.020	3,2X50MM	100	51700.032.050
1,2X8MM*	1000	51700.012.008	2X22MM*	1000	51700.020.022	3,2X56MM*	500	51700.032.056
1,2X10MM*	1000	51700.012.010	2X25MM	250	51700.020.025	3,2X63MM	100	51700.032.063
1,2X12MM*	1000	51700.012.012	2X28MM*	1000	51700.020.028	3,2X71MM*	500	51700.032.071
1,2X14MM*	1000	51700.012.014	2X32MM	250	51700.020.032	3,2X80MM*	500	51700.032.080
1,2X16MM*	1000	51700.012.016	2X36MM*	1000	51700.020.036			
1,2X18MM*	1000	51700.012.018	2X40MM	250	51700.020.040	4X16MM*	500	51700.040.016
1,2X20MM*	1000	51700.012.020	2X45MM*	1000	51700.020.045	4X18MM*	500	51700.040.018
1,2X22MM*	1000	51700.012.022	2X50MM	250	51700.020.050	4X20MM	100	51700.040.020
1,2X25MM*	1000	51700.012.025				4X22MM*	500	51700.040.022
1,2X32MM*	1000	51700.012.032	2,5X10MM	100	51700.025.010	4X25MM	100	51700.040.025
1,2X40MM*	1000	51700.012.040	2,5X12MM*	1000	51700.025.012	4X28MM	100	51700.040.028
			2,5X14MM*	1000	51700.025.014	4X32MM	100	51700.040.032
1,6X6MM*	1000	51700.016.006	2,5X16MM	100	51700.025.016	4X36MM	100	51700.040.036
1,6X8MM*	1000	51700.016.008	2,5X18MM*	1000	51700.025.018	4X40MM	100	51700.040.040
1,6X10MM	250	51700.016.010	2,5X20MM	100	51700.025.020	4X45MM	100	51700.040.045
1,6X12MM	250	51700.016.012	2,5X22MM*	1000	51700.025.022	4X50MM	100	51700.040.050
1,6X14MM*	1000	51700.016.014	2,5X25MM	100	51700.025.025	4X56MM*	500	51700.040.056
1,6X16MM	250	51700.016.016	2,5X28MM*	1000	51700.025.028	4X63MM	100	51700.040.063
1,6X18MM*	1000	51700.016.018	2,5X32MM	100	51700.025.032	4X71MM*	500	51700.040.071

51700 Split pin (cotter pin) ←								
d (nom.) x L	☒	Art.number	d (nom.) x L	☒	Art.number	d (nom.) x L	☒	Art.number
4X80MM	100	51700.040.080	5X100MM	50	51700.050.100	8X50MM	25	51700.080.050
4X90MM*	500	51700.040.090	6,3X20MM*	250	51700.063.020	8X56MM*	100	51700.080.056
4X100MM*	500	51700.040.100	6,3X25MM	50	51700.063.025	8X63MM	25	51700.080.063
5X20MM*	250	51700.050.020	6,3X32MM	50	51700.063.032	8X71MM*	100	51700.080.071
5X22MM*	250	51700.050.022	6,3X36MM*	250	51700.063.036	8X80MM	25	51700.080.080
5X25MM	50	51700.050.025	6,3X40MM	50	51700.063.040	8X90MM*	100	51700.080.090
5X28MM*	250	51700.050.028	6,3X45MM*	250	51700.063.045	8X100MM	25	51700.080.100
5X32MM	50	51700.050.032	6,3X50MM	50	51700.063.050	10X32MM*	100	51700.100.032
5X35MM	50	51700.050.035	6,3X56MM*	250	51700.063.056	10X40MM*	100	51700.100.040
5X36MM	50	51700.050.036	6,3X63MM	50	51700.063.063	10X50MM*	100	51700.100.050
5X40MM	50	51700.050.040	6,3X71MM	50	51700.063.071	10X56MM*	100	51700.100.056
5X45MM*	250	51700.050.045	6,3X80MM	50	51700.063.080	10X63MM	25	51700.100.063
5X50MM	50	51700.050.050	6,3X90MM*	250	51700.063.090	10X71MM*	100	51700.100.071
5X56MM*	250	51700.050.056	6,3X100MM	50	51700.063.100	10X80MM	25	51700.100.080
5X63MM	50	51700.050.063	8X32MM*	100	51700.080.032	10X90MM*	100	51700.100.090
5X71MM	50	51700.050.071	8X40MM	25	51700.080.040	10X100MM	25	51700.100.100
5X80MM	50	51700.050.080	8X45MM*	100	51700.080.045	10X125MM	25	51700.100.125
5X90MM*	250	51700.050.090				10X180MM	25	51700.100.180

* The austenitic steel type is at the manufacturer's discretion, and can vary from the steel types stated in ISO 3506.

55700 Split pin (cotter pin)		R49A
Material	Stainless steel A4	
		

d (nom.) x L	☒	Art.number	d (nom.) x L	☒	Art.number	d (nom.) x L	☒	Art.number
1X8MM*	1000	55700.010.008	2,5X20MM	100	55700.025.020	5X36MM*	250	55700.050.036
1X10MM	250	55700.010.010	2,5X22MM*	1000	55700.025.022	5X40MM	50	55700.050.040
1X12MM	250	55700.010.012	2,5X25MM	100	55700.025.025	5X45MM*	250	55700.050.045
1X16MM	250	55700.010.016	2,5X28MM*	1000	55700.025.028	5X50MM	50	55700.050.050
1X18MM*	1000	55700.010.018	2,5X32MM	100	55700.025.032	5X56MM*	250	55700.050.056
1X20MM	250	55700.010.020	2,5X36MM*	1000	55700.025.036	5X63MM	50	55700.050.063
1X25MM	250	55700.010.025	2,5X40MM	100	55700.025.040	5X71MM*	250	55700.050.071
1,2X8MM*	1000	55700.012.008	2,5X45MM*	1000	55700.025.045	5X80MM	50	55700.050.080
1,2X10MM*	1000	55700.012.010	2,5X50MM	100	55700.025.050	5X90MM*	250	55700.050.090
1,2X12MM*	1000	55700.012.012	3,2X16MM	100	55700.032.016	5X100MM	50	55700.050.100
1,2X16MM*	1000	55700.012.016	3,2X18MM*	500	55700.032.018	6,3X25MM	50	55700.063.025
1,2X20MM*	1000	55700.012.020	3,2X20MM	100	55700.032.020	6,3X32MM	50	55700.063.032
1,2X25MM*	1000	55700.012.025	3,2X22MM*	500	55700.032.022	6,3X36MM*	250	55700.063.036
1,2X32MM*	1000	55700.012.032	3,2X25MM	100	55700.032.025	6,3X40MM	50	55700.063.040
1,6X8MM*	1000	55700.016.008	3,2X28MM*	500	55700.032.028	6,3X45MM*	250	55700.063.045
1,6X10MM	250	55700.016.010	3,2X32MM	100	55700.032.032	6,3X50MM*	50	55700.063.050
1,6X12MM	250	55700.016.012	3,2X36MM*	500	55700.032.036	6,3X56MM*	250	55700.063.056
1,6X16MM	250	55700.016.016	3,2X40MM	100	55700.032.040	6,3X63MM	50	55700.063.063
1,6X18MM*	1000	55700.016.018	3,2X45MM*	500	55700.032.045	6,3X71MM*	250	55700.063.071
1,6X20MM	250	55700.016.020	3,2X50MM	100	55700.032.050	6,3X80MM	50	55700.063.080
1,6X22MM*	1000	55700.016.022	3,2X56MM*	500	55700.032.056	6,3X90MM*	250	55700.063.090
1,6X25MM	250	55700.016.025	3,2X63MM	100	55700.032.063	6,3X100MM	50	55700.063.100
1,6X28MM*	1000	55700.016.028	4X16MM*	500	55700.040.016	8X32MM*	100	55700.080.032
1,6X32MM	250	55700.016.032	4X20MM	100	55700.040.020	8X36MM*	100	55700.080.036
1,6X40MM*	1000	55700.016.040	4X22MM*	500	55700.040.022	8X40MM	25	55700.080.040
2X10MM	250	55700.020.010	4X25MM	100	55700.040.025	8X45MM*	100	55700.080.045
2X12MM*	1000	55700.020.012	4X28MM*	500	55700.040.028	8X50MM	25	55700.080.050
2X16MM	250	55700.020.016	4X32MM	100	55700.040.032	8X56MM*	100	55700.080.056
2X18MM	250	55700.020.018	4X36MM*	500	55700.040.036	8X63MM	25	55700.080.063
2X20MM	250	55700.020.020	4X40MM	100	55700.040.040	8X71MM*	100	55700.080.071
2X22MM*	1000	55700.020.022	4X45MM*	500	55700.040.045	8X80MM	25	55700.080.080
2X25MM	250	55700.020.025	4X50MM	100	55700.040.050	8X90MM*	100	55700.080.090
2X28MM*	1000	55700.020.028	4X56MM*	500	55700.040.056	8X100MM	25	55700.080.100
2X32MM	250	55700.020.032	4X63MM	100	55700.040.063	10X40MM*	100	55700.100.040
2X36MM*	1000	55700.020.036	4X71MM*	500	55700.040.071	10X63MM	25	55700.100.063
2X40MM	250	55700.020.040	4X80MM	100	55700.040.080	10X71MM*	100	55700.100.071
2X45MM*	1000	55700.020.045	4X100MM*	500	55700.040.100	10X80MM	25	55700.100.080
2X50MM	250	55700.020.050	5X18MM*	250	55700.050.018	10X90MM*	100	55700.100.090
2,5X10MM	100	55700.025.010	5X20MM*	250	55700.050.020	10X100MM	25	55700.100.100
2,5X12MM*	1000	55700.025.012	5X22MM*	250	55700.050.022	10X125MM	25	55700.100.125
2,5X16MM	100	55700.025.016	5X25MM	50	55700.050.025	13 X 90 MM	25	55700.130.090
2,5X18MM*	1000	55700.025.018	5X28MM*	250	55700.050.028			
			5X32MM	50	55700.050.032			

* The austenitic steel type is at the manufacturer's discretion, and can vary from the steel types stated in ISO 3506.

50210	Split pin (cotter pin)	M11F
Material	Brass	
		 

d (nom.) x L	☒	Art.number	d (nom.) x L	☒	Art.number	d (nom.) x L	☒	Art.number
1,6X20MM	500	50210.016.020	2,5X50MM	500	50210.025.050	4X50MM	250	50210.040.050
1,6X25MM	500	50210.016.025	2,5X63MM	500	50210.025.063	4X63MM	250	50210.040.063
1,6X32MM	500	50210.016.032				4X80MM	250	50210.040.080
1,6X40MM	500	50210.016.040	3,2X25MM	250	50210.032.025			
			3,2X32MM	250	50210.032.032	5X40MM	100	50210.050.040
2X25MM	500	50210.020.025	3,2X40MM	250	50210.032.040	5X50MM	100	50210.050.050
2X32MM	500	50210.020.032	3,2X50MM	250	50210.032.050	5X63MM	100	50210.050.063
2X40MM	500	50210.020.040	3,2X63MM	250	50210.032.063	5X80MM	100	50210.050.080
2X50MM	500	50210.020.050						
			4X25MM	250	50210.040.025	6,3X63MM	100	50210.063.063
2,5X25MM	500	50210.025.025	4X32MM	250	50210.040.032	6,3X80MM	100	50210.063.080
2,5X32MM	500	50210.025.032	4X40MM	250	50210.040.040	6,3X100MM	100	50210.063.100
2,5X40MM	500	50210.025.040						

50390	Split pin (cotter pin)	M11F
Material	Copper	
		 

d (nom.) x L	☒	Art.number	d (nom.) x L	☒	Art.number	d (nom.) x L	☒	Art.number
1,6X20MM	500	50390.016.020	3,2X40MM	250	50390.032.040	5X40MM	100	50390.050.040
1,6X32MM	500	50390.016.032	3,2X50MM	250	50390.032.050	5X50MM	100	50390.050.050
			3,2X63MM	250	50390.032.063	5X63MM	100	50390.050.063
2X32MM	500	50390.020.032				5X80MM	100	50390.050.080
2X40MM	500	50390.020.040	4X32MM	250	50390.040.032			
			4X40MM	250	50390.040.040			
2,5X32MM	500	50390.025.032	4X50MM	250	50390.040.050	6,3X63MM	100	50390.063.063
2,5X40MM	500	50390.025.040	4X63MM	250	50390.040.063	6,3X80MM	100	50390.063.080
			4X80MM	250	50390.040.080	6,3X100MM	100	50390.063.100
3,2X32MM	250	50390.032.032						

Spring cotter of a bolt, single

DIN ≈11024

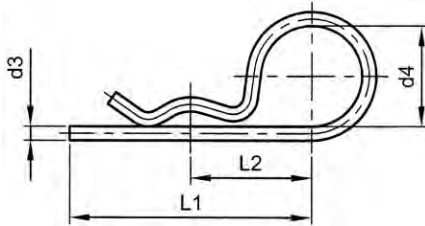

Technical Data

d ₁ (nom.) = hole ø	For shaft ø d ₂ >	For shaft ø d ₂ ≤	d ₃	d ₄	L ₁	L ₂
2.5	9	14	2	10	50	25
3.5	10	16	3	18	60	28
4.5	16	20	4	20	60	30
6	20	28	5	24	85	40
7	28	40	6	30	105	50
8	28	45	7	30	105	50
9	30	45	8	28	110	55

Assembly data

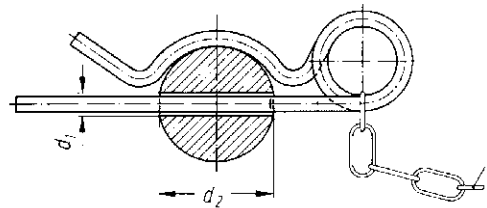

For the hole diameter, d₁ (nom.) with tolerance field H13 is recommended.
It is also recommended to connect the spring cotter of a bolt with the unit to be locked so that it cannot be lost.

Article groups

Material	Surface treatment	Code	Page
Spring steel	Zipl yell.p.	39610	9-42
St.St. A2		51970	9-42

39610 Spring cotter of a bolt, single L11E

Material Spring steel
Surface treatment Zinc plated yellow passivated



d ₁ (=d ₃)	⊗	Art.number	d ₁ (=d ₃)	⊗	Art.number	d ₁ (=d ₃)	⊗	Art.number
2,5 (=2 MM)	50	39610.020.001	6 (=5 MM)	25	39610.050.001	8 (=7 MM)	10	39610.070.001
3,5 (=3 MM)	50	39610.030.001	7 (=6 MM)	25	39610.060.001	9 (=8 MM)	10	39610.080.001
4,5 (=4 MM)	25	39610.040.001						

• Warning: electro-galvanizing of these products may cause hydrogen embrittlement.

51970 Spring cotter of a bolt, single R09A

Material Stainless steel A2



d ₁ (=d ₃)	⊗	Art.number	d ₁ (=d ₃)	⊗	Art.number	d ₁ (=d ₃)	⊗	Art.number
2,5 (=2 MM)	50	51970.020.001	4,5 (=4 MM)	25	51970.040.001	7 (=6 MM)	25	51970.060.001
3,5 (=3 MM)	50	51970.030.001	6 (=5 MM)	25	51970.050.001			

Spring cotter of a bolt, double

DIN ≈11024

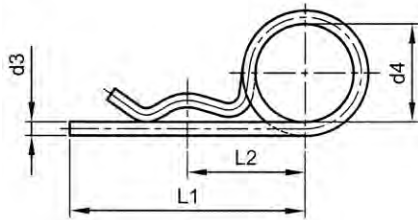

Technical Data

d_1 (nom.) = hole \varnothing	For shaft $\varnothing d_2 >$	For shaft $\varnothing d_2 \leq$	d_3	d_4	L_1	L_2
3.5	14	20	3	16	62	32
4.5	17	24	4	23	78	44
5.5	18	30	5	26	92	50
6.5	24	36	6	30	120	70
8	26	40	7	30	130	72
9	24	40	8	30	130	76

Assembly data

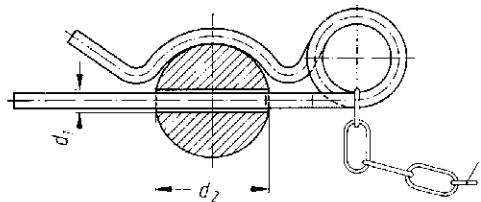

For the hole diameter, d_1 (nom.) with tolerance field H13 is recommended.

It is also recommended to connect the spring cotter of a bolt with the unit to be locked so that it cannot be lost.

39630 Spring cotter of a bolt, double

L11E

Material Spring steel
Surface treatment Zinc plated yellow passivated



d_1 (= d_3)	☒	Art.number	d_1 (= d_3)	☒	Art.number	d_1 (= d_3)	☒	Art.number
3,5 (=3 MM)	50	39630.030.001	5,5 (=5 MM)	25	39630.050.001	8 (=7 MM)	10	39630.070.001
4,5 (=4 MM)	25	39630.040.001	6,5 (=6 MM)	25	39630.060.001	9 (=8MM)	10	39630.080.001

- Warning: electro-galvanizing of these products may cause hydrogen embrittlement.

Spring cotter of a bolt, double, A4

DIN 11024

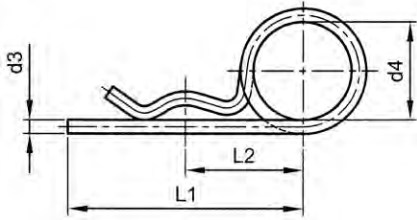

Technical Data

d_1 (nom.) = hole \emptyset	For shaft $\emptyset d_2 >$	For shaft $\emptyset d_2 \leq$	d_3	d_4	L_1	L_2
3.2	11.2	14	2.8	20	48	26
4	14	20	3.6	20	64	32
5	20	26	4.5	25	80	39
7	34	45	6.3	30	125	56
8	45	56	7	30	150	63

Assembly data

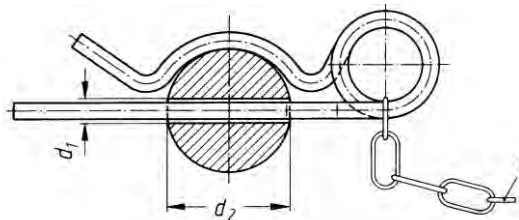

For the hole diameter, d_1 (nom.) with tolerance field H13 is recommended.
It is also recommended to connect the spring cotter of a bolt with the unit to be locked so that it cannot be lost.

55970	Spring cotter of a bolt, double, A4	R09A
Material	Stainless steel A4	
		

d_1 (= d_3)	☒	Art.number	d_1 (= d_3)	☒	Art.number	d_1 (= d_3)	☒	Art.number
3,2 (=2,8MM)	50	55970.032.001	5 (=4,5MM)	50	55970.050.001	8 (=7MM)	10	55970.080.001
4 (=3,6MM)	50	55970.040.001	7 (=6,3MM)	10	55970.070.001			

Pipe pin

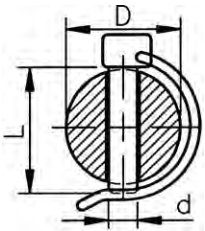

Technical Data

d x L	For nom. size D (inch)	For nom. size D (mm)
6x40	1.13/32	36
6x45	1.9/16	40
8x40	1.13/32	36
8x45	1.9/16	40
8x50	1.3/4	45
10x40	1.13/32	36
10x50	1.3/4	45
10x60	2.11/64	55

Assembly data

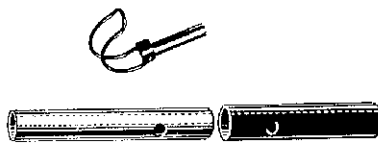

39680 Pipe pin

L11G

Material Spring steel
Surface treatment Zinc plated yellow passivated



d x L	☒	Art.number	d x L	☒	Art.number	d x L	☒	Art.number
6X40MM	25	39680.060.040	8X45MM	25	39680.080.045	10X40MM	10	39680.100.040
6X45MM	25	39680.060.045	8X50MM	25	39680.080.050	10X50MM	10	39680.100.050
8X40MM	25	39680.080.040				10X60MM	10	39680.100.060

- Warning: electro-galvanizing of these products may cause hydrogen embrittlement.

Linch pin

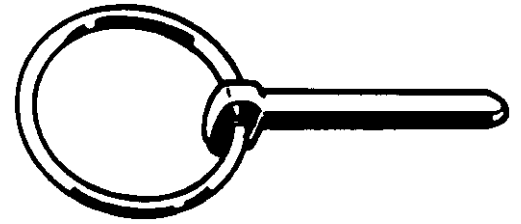
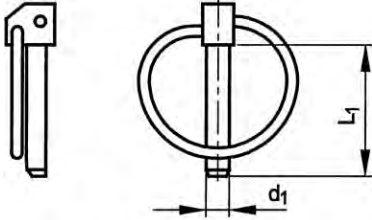

Technical Data

d_1	d_3 (H11)	d_4 (max.)	Form of shaft	L_2
4.5	5	25	a	8
6	6.2	32	a	10
7	8	32	b	12
8	8.5	32	b	12
9.5	10	32	b	14
10	10.5	32	b	14
11	12	32	b	14

- Form of shaft a = round, b = flattened on one side.

Assembly data

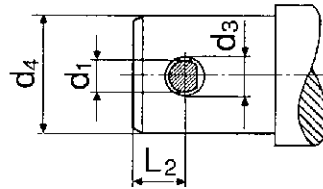

39660 Linch pin		L11E
Material	Spring steel	
Surface treatment	Zinc plated yellow passivated	

$d_1 \times L_1$	☒	Art.number	$d_1 \times L_1$	☒	Art.number	$d_1 \times L_1$	☒	Art.number
4,5x40MM	25	39660.045.001	8x40MM	25	39660.080.001	10x40MM	10	39660.100.001
6x40MM	25	39660.060.001	9,5x40MM	25	39660.095.001	11x40MM	10	39660.110.001
7x40MM	25	39660.070.001						

- Warning: electro-galvanizing of these products may cause hydrogen embrittlement.

Parallel key high type

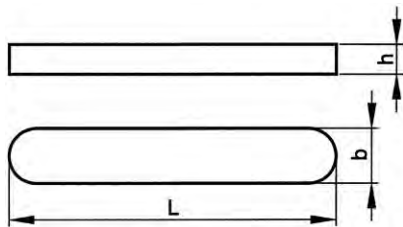

DIN 6885 A
ISO 773
NEN 2430
BS 4235-1

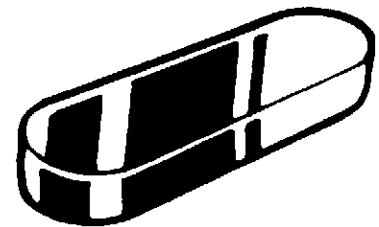

Technical Data

b	For shaft $\phi >$	For shaft $\phi \leq$	h	b	For shaft $\phi >$	For shaft $\phi \leq$	h
2	6	8	2	18	50	58	11
3	8	10	3	20	75	85	12
4	10	12	4	22	75	80	14
5	12	17	5	25	85	95	14
6	17	22	6	28	95	110	16
8	22	30	7	32	110	130	18
10	30	38	8	36	130	150	20
12	38	44	8	40	150	170	22
14	44	50	9	45	170	200	25
16	50	58	10	50	200	230	28

Article groups

Material	Code	Page
St C45K	39250	9-47
St.St. A4	55510	9-49

39250 Parallel key high type

L11B

Material Steel C45K



b x h x L	☒	Art.number	b x h x L	☒	Art.number	b x h x L	☒	Art.number
2X2X6MM	50	39250.022.006	4X4X15MM	50	39250.044.015	5X5X80MM	50	39250.055.080
2X2X8MM	50	39250.022.008	4X4X16MM	50	39250.044.016	6X6X10MM	50	39250.066.010
2X2X10MM	50	39250.022.010	4X4X18MM	50	39250.044.018	6X6X12MM	50	39250.066.012
2X2X12MM	50	39250.022.012	4X4X20MM	50	39250.044.020	6X6X14MM	50	39250.066.014
2X2X14MM	50	39250.022.014	4X4X22MM	50	39250.044.022	6X6X15MM	50	39250.066.015
2X2X16MM	50	39250.022.016	4X4X25MM	50	39250.044.025	6X6X16MM	50	39250.066.016
2X2X18MM	50	39250.022.018	4X4X28MM	50	39250.044.028	6X6X18MM	50	39250.066.018
2X2X20MM	50	39250.022.020	4X4X30MM	50	39250.044.030	6X6X20MM	50	39250.066.020
2X2X22MM	50	39250.022.022	4X4X32MM	50	39250.044.032	6X6X22MM	50	39250.066.022
2X2X25MM	50	39250.022.025	4X4X35MM	50	39250.044.035	6X6X25MM	50	39250.066.025
2X2X28MM	50	39250.022.028	4X4X36MM	50	39250.044.036	6X6X28MM	50	39250.066.028
2X2X30MM	50	39250.022.030	4X4X40MM	50	39250.044.040	6X6X30MM	50	39250.066.030
2X2X36MM	50	39250.022.036	4X4X45MM	50	39250.044.045	6X6X32MM	50	39250.066.032
2X2X40MM	50	39250.022.040	4X4X50MM	50	39250.044.050	6X6X35MM	50	39250.066.035
3X3X6MM	50	39250.033.006	5X5X10MM	50	39250.055.010	6X6X36MM	50	39250.066.036
3X3X8MM	50	39250.033.008	5X5X12MM	50	39250.055.012	6X6X40MM	50	39250.066.040
3X3X10MM	50	39250.033.010	5X5X14MM	50	39250.055.014	6X6X45MM	50	39250.066.045
3X3X12MM	50	39250.033.012	5X5X15MM	50	39250.055.015	6X6X50MM	50	39250.066.050
3X3X14MM	50	39250.033.014	5X5X16MM	50	39250.055.016	6X6X55MM	50	39250.066.055
3X3X15MM	50	39250.033.015	5X5X18MM	50	39250.055.018	6X6X56MM	50	39250.066.056
3X3X16MM	50	39250.033.016	5X5X20MM	50	39250.055.020	6X6X60MM	50	39250.066.060
3X3X18MM	50	39250.033.018	5X5X22MM	50	39250.055.022	6X6X63MM	50	39250.066.063
3X3X20MM	50	39250.033.020	5X5X25MM	50	39250.055.025	6X6X65MM	50	39250.066.065
3X3X22MM	50	39250.033.022	5X5X28MM	50	39250.055.028	6X6X70MM	50	39250.066.070
3X3X25MM	50	39250.033.025	5X5X30MM	50	39250.055.030	6X6X75MM	50	39250.066.075
3X3X28MM	50	39250.033.028	5X5X32MM	50	39250.055.032	6X6X80MM	50	39250.066.080
3X3X30MM	50	39250.033.030	5X5X35MM	50	39250.055.035	6X6X90MM	50	39250.066.090
3X3X32MM	50	39250.033.032	5X5X36MM	50	39250.055.036	6X6X100MM	50	39250.066.100
3X3X35MM	50	39250.033.035	5X5X40MM	50	39250.055.040	8X7X10MM	50	39250.087.010
3X3X40MM	50	39250.033.040	5X5X45MM	50	39250.055.045	8X7X12MM	50	39250.087.012
4X4X6MM	50	39250.044.006	5X5X50MM	50	39250.055.050	8X7X15MM	50	39250.087.015
4X4X8MM	50	39250.044.008	5X5X55MM	50	39250.055.055	8X7X16MM	50	39250.087.016
4X4X10MM	50	39250.044.010	5X5X60MM	50	39250.055.060	8X7X18MM	50	39250.087.018
4X4X12MM	50	39250.044.012	5X5X63MM	50	39250.055.063	8X7X20MM	50	39250.087.020
4X4X14MM	50	39250.044.014	5X5X70MM	50	39250.055.070	8X7X22MM	50	39250.087.022

39250 Parallel key high type								
b x h x L	☒	Art.number	b x h x L	☒	Art.number	b x h x L	☒	Art.number
36X20X220MM	5	39250.380.220	40X22X220MM	5	39250.422.220	45X25X280MM	5	39250.475.280
36X20X250MM	5	39250.380.250	40X22X250MM	5	39250.422.250	45X25X320MM	5	39250.475.320
36X20X280MM	5	39250.380.280	40X22X280MM	5	39250.422.280	45X25X360MM	5	39250.475.360
36X20X320MM	5	39250.380.320	40X22X320MM	5	39250.422.320	45X25X400MM	5	39250.475.400
36X20X360MM	5	39250.380.360	40X22X360MM	5	39250.422.360			
36X20X400MM	5	39250.380.400	40X22X400MM	5	39250.422.400	50X28X125MM	3	39250.528.125
						50X28X140MM	3	39250.528.140
40X22X80MM	5	39250.422.080	45X25X100MM	5	39250.475.100	50X28X160MM	3	39250.528.160
40X22X90MM	5	39250.422.090	45X25X110MM	5	39250.475.110	50X28X180MM	3	39250.528.180
40X22X100MM	5	39250.422.100	45X25X125MM	5	39250.475.125	50X28X200MM	3	39250.528.200
40X22X110MM	5	39250.422.110	45X25X140MM	5	39250.475.140	50X28X220MM	3	39250.528.220
40X22X125MM	5	39250.422.125	45X25X160MM	5	39250.475.160	50X28X250MM	3	39250.528.250
40X22X140MM	5	39250.422.140	45X25X180MM	5	39250.475.180	50X28X280MM	3	39250.528.280
40X22X160MM	5	39250.422.160	45X25X200MM	5	39250.475.200	50X28X320MM	3	39250.528.320
40X22X180MM	5	39250.422.180	45X25X220MM	5	39250.475.220	50X28X360MM	3	39250.528.360
40X22X200MM	5	39250.422.200	45X25X250MM	5	39250.475.250	50X28X400MM	3	39250.528.400

• Steel for keys acc. to DIN 1652 and DIN 6880.

55510 Parallel key high type		R49A
Material	Stainless steel A4	

b x h x L	☒	Art.number	b x h x L	☒	Art.number	b x h x L	☒	Art.number
3X3X16MM	50	55510.033.016	6X6X63MM	25	55510.066.063	12X8X50MM	10	55510.128.050
3X3X25MM	50	55510.033.025	6X6X70MM	25	55510.066.070	12X8X56MM	50	55510.128.056
						12X8X60MM	50	55510.128.060
4X4X10MM*	200	55510.044.010	8X7X14MM*	100	55510.087.014	12X8X63MM	5	55510.128.063
4X4X12MM	25	55510.044.012	8X7X16MM	25	55510.087.016	12X8X70MM	5	55510.128.070
4X4X14MM*	200	55510.044.014	8X7X18MM	25	55510.087.018	12X8X80MM	5	55510.128.080
4X4X16MM	25	55510.044.016	8X7X20MM	25	55510.087.020	12X8X90MM*	50	55510.128.090
4X4X18MM*	200	55510.044.018	8X7X25MM	25	55510.087.025	12X8X100MM	5	55510.128.100
4X4X20MM	25	55510.044.020	8X7X28MM*	100	55510.087.028			
4X4X22MM	25	55510.044.022	8X7X30MM	25	55510.087.030	14X9X28MM	5	55510.149.028
4X4X25MM	25	55510.044.025	8X7X32MM	25	55510.087.032	14X9X30MM*	50	55510.149.030
4X4X30MM*	200	55510.044.030	8X7X35MM*	100	55510.087.035	14X9X32MM*	50	55510.149.032
4X4X32MM	25	55510.044.032	8X7X36MM	25	55510.087.036	14X9X36MM*	50	55510.149.036
4X4X36MM*	200	55510.044.036	8X7X40MM	10	55510.087.040	14X9X40MM	5	55510.149.040
4X4X40MM	25	55510.044.040	8X7X45MM	100	55510.087.045	14X9X45MM	5	55510.149.045
4X4X50MM*	200	55510.044.050	8X7X50MM	10	55510.087.050	14X9X50MM	5	55510.149.050
			8X7X60MM	10	55510.087.060	14X9X56MM	5	55510.149.056
5X5X10MM*	200	55510.055.010	8X7X63MM	10	55510.087.063	14X9X60MM	5	55510.149.060
5X5X12MM	25	55510.055.012	8X7X70MM	10	55510.087.070	14X9X63MM	5	55510.149.063
5X5X14MM*	200	55510.055.014	8X7X80MM	10	55510.087.080	14X9X70MM	5	55510.149.070
5X5X16MM	25	55510.055.016	8X7X90MM	10	55510.087.090	14X9X80MM	5	55510.149.080
5X5X18MM*	200	55510.055.018	8X7X100MM	10	55510.087.100	14X9X90MM	50	55510.149.090
5X5X20MM	25	55510.055.020	8X7X125MM	5	55510.087.125	14X9X100MM	5	55510.149.100
5X5X22MM*	200	55510.055.022						
5X5X25MM	25	55510.055.025	10X8X16MM	10	55510.108.016	16X10X50MM	5	55510.170.050
5X5X30MM*	200	55510.055.030	10X8X25MM	10	55510.108.025	16X10X63MM	5	55510.170.063
5X5X32MM	25	55510.055.032	10X8X28MM*	100	55510.108.028	16X10X70MM	5	55510.170.070
5X5X36MM*	200	55510.055.036	10X8X30MM*	100	55510.108.030	16X10X80MM	5	55510.170.080
5X5X40MM	25	55510.055.040	10X8X32MM	10	55510.108.032	16X10X100MM	5	55510.170.100
5X5X50MM	25	55510.055.050	10X8X36MM*	100	55510.108.036			
			10X8X40MM	10	55510.108.040	18X11X50MM	5	55510.191.050
6X6X12MM*	200	55510.066.012	10X8X45MM*	100	55510.108.045	18X11X60MM	5	55510.191.060
6X6X14MM*	200	55510.066.014	10X8X50MM	10	55510.108.050	18X11X63MM	5	55510.191.063
6X6X16MM	25	55510.066.016	10X8X56MM*	100	55510.108.056	18X11X70MM	5	55510.191.070
6X6X18MM*	200	55510.066.018	10X8X60MM	10	55510.108.060	18X11X80MM	5	55510.191.080
6X6X20MM	25	55510.066.020	10X8X63MM	10	55510.108.063	18X11X90MM	5	55510.191.090
6X6X22MM	25	55510.066.022	10X8X70MM	10	55510.108.070	18X11X100MM	5	55510.191.100
6X6X25MM	25	55510.066.025	10X8X80MM	10	55510.108.080	18X11X110MM	5	55510.191.110
6X6X28MM*	200	55510.066.028	10X8X90MM	10	55510.108.090	18X11X140MM	5	55510.191.140
6X6X30MM	200	55510.066.030	10X8X100MM	10	55510.108.100			
6X6X32MM	25	55510.066.032	10X8X125MM	5	55510.108.125	20X12X50MM	5	55510.212.050
6X6X35MM	25	55510.066.035				20X12X70MM	5	55510.212.070
6X6X36MM*	200	55510.066.036	12X8X30MM*	50	55510.128.030	20X12X80MM	5	55510.212.080
6X6X40MM	25	55510.066.040	12X8X32MM	10	55510.128.032	20X12X90MM	5	55510.212.090
6X6X45MM	25	55510.066.045	12X8X36MM*	50	55510.128.036	20X12X100MM	5	55510.212.100
6X6X50MM	25	55510.066.050	12X8X40MM	10	55510.128.040	20X12X110MM	5	55510.212.110
6X6X60MM*	200	55510.066.060	12X8X45MM*	50	55510.128.045	20X12X140MM	5	55510.212.140

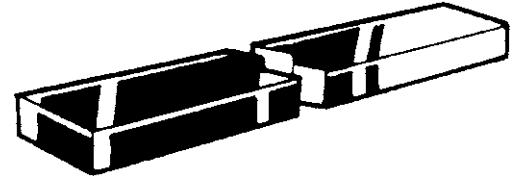
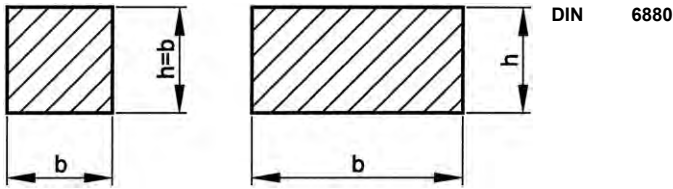

Bright key steel length 1 meter





- Bright key steel is cold drawn with a rather smooth and bright surface and corresponding to a high accuracy of dimensions. Usable for the manufacturing of parallel keys and taper keys with gip head.
- For b is the tolerance h9 and for h tolerance h11 (except the size 12 x 8 and square key steel having for b as well as h tolerance h9).

Article groups

Material	Code	Page
St C45K	39270	9-50
St.St. A4	55512	9-50

39270	Bright key steel length 1 meter	L11B
Material	Steel C45K	
		 

b x h	☒	Art.number	b x h	☒	Art.number	b x h	☒	Art.number
3X3MM	2	39270.033.001	12X8MM	2	39270.128.001	20X20MM	1	39270.220.001
4X4MM	2	39270.044.001	12X12MM	2	39270.132.001	22X14MM	1	39270.234.001
5X5MM	2	39270.055.001	14X9MM	1	39270.149.001	22X22MM	1	39270.242.001
6X6MM	2	39270.066.001	14X14MM	1	39270.154.001	25X14MM	1	39270.264.001
7X7MM	2	39270.077.001	16X10MM	1	39270.170.001	28X16MM	1	39270.296.001
8X7MM	2	39270.087.001	16X16MM	1	39270.176.001	32X18MM	1	39270.338.001
8X8MM	2	39270.088.001	18X11MM	1	39270.191.001	36X20MM	1	39270.380.001
10X8MM	2	39270.108.001	18X18MM	1	39270.198.001	40X22MM	1	39270.422.001
10X10MM	2	39270.110.001	20X12MM	1	39270.212.001	45X25MM	1	39270.475.001

55512	Bright key steel length 1 meter	R49A
Material	Stainless steel A4	DIN ≈6880
		 

b x h	☒	Art.number	b x h	☒	Art.number	b x h	☒	Art.number
4X4MM	2	55512.044.001	12X8MM	2	55512.128.001	20X12MM	1	55512.212.001
5X5MM	2	55512.055.001	14X9MM	1	55512.149.001	22X14MM	1	55512.234.001
6X6MM	2	55512.066.001	16X10MM	1	55512.170.001	25X14MM	1	55512.264.001
8X7MM	2	55512.087.001	18X11MM	1	55512.191.001	28X16MM	1	55512.296.001
10X8MM	2	55512.108.001						

Woodruff key

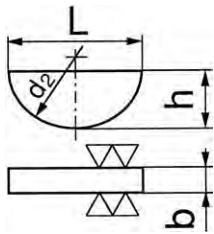

DIN 6888
ISO 3912
BS 4235-2



Technical Data

b (h9) x h (h12)	For shaft (1.) $\varnothing >$	For shaft (1.) $\varnothing \leq$	For shaft (2.) $\varnothing >$	For shaft (2.) $\varnothing \leq$	d_2	$L \approx$
2x2.6	6	8	10	12	7	6.76
2x3.7	6	8	10	12	10	9.66
2x5 (#DIN)	8	10	12	17	-	12.65
2.5x3.7	8	10	12	17	10	9.66
3x3.7	8	10	12	17	10	9.66
3x5	8	10	12	17	13	12.65
3x6.5	-	-	12	17	16	15.72
3x7.5 (#DIN)	10	12	17	22	-	18.57
4x5	10	12	17	22	13	12.65
4x6.5 (#DIN)	10	12	17	22	16	15.72
4x7.5	10	12	17	22	16	15.72
4x9	12	17	22	30	16	15.72
5x6.5	12	17	22	30	16	15.72
5x7.5	12	17	22	30	19	18.57
5x9	-	-	22	30	22	21.63
6x9	17	22	30	38	22	21.63
6x11	-	-	30	38	28	27.35
6x13 (#DIN)	22	30	38	-	-	31.43
6x15 (#DIN)	-	-	-	-	-	37.14
8x11	22	30	38	-	28	27.35
8x13	-	-	38	-	32	31.43
10x13	30	38	38	-	32	31.43

- (1.) Application is valid for keys, which are used as a fitting key transmitting the whole turning moment.
- (2.) Application is valid for keys, which are used only for the positioning of the driving element, while for the transmission of the turning moment other articles e.g. parallel keys or taper pins are used.

Article groups

Material	Class	Code	Page
St DIN6882	60	39200	9-51
St.St. A4		55516	9-52

39200 Woodruff key

L11B

Material Steel DIN6882
Class 60



b x h	Art.number	b x h	Art.number	b x h	Art.number
2X2,6MM	100 39200.020.002			6X9MM	50 39200.060.009
2X3,7MM	100 39200.020.003	4X5MM	50 39200.040.005	6X11MM	25 39200.060.011
2X5MM	100 39200.020.005	4X6,5MM	50 39200.040.006	6X13MM	25 39200.060.013
		4X7,5MM	50 39200.040.007	6X15MM	25 39200.060.015
2,5X3,7MM	100 39200.025.003	4X9MM	50 39200.040.009		
				8X11MM	10 39200.080.011
3X3,7MM	100 39200.030.003	5X6,5MM	50 39200.050.006	8X13MM	10 39200.080.013
3X5MM	100 39200.030.005	5X7,5MM	50 39200.050.007		
3X6,5MM	100 39200.030.006	5X9MM	50 39200.050.009	10X13MM	10 39200.100.013
3X7,5MM	50 39200.030.007				

55516 Woodruff key R49A

Material Stainless steel A4



b x h	☒	Art.number	b x h	☒	Art.number	b x h	☒	Art.number
3X3,7MM	50	55516.030.003	4X5MM	25	55516.040.005	5X9MM	25	55516.050.009
3X5MM	50	55516.030.005	4X6,5MM	25	55516.040.006			
3X6,5MM	50	55516.030.006	4X7,5MM	25	55516.040.007	6X9MM	25	55516.060.009

Taper key with gib head

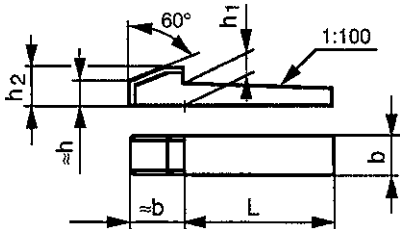

DIN 6887
ISO 774
BS 4235-1





Technical Data

b (h9)	For shaft ø >	For shaft ø ≤	h (nom.)	h ₁	h ₂
6	17	22	6	6.1	10
8	22	30	7	7.2	11
10	30	38	8	8.2	12
12	38	44	8	8.2	12
14	44	50	9	9.2	14
16	50	58	10	10.2	16
18	58	65	11	11.2	18
32	110	130	18	18.3	28
36	130	150	20	20.4	32
40	150	170	22	22.4	36

• b(h9) For the width of the keyway, tolerance D10 is recommended.

39220 Taper key with gib head L11B

Material Steel DIN6880

b x h x L	☒	Art.number	b x h x L	☒	Art.number	b x h x L	☒	Art.number
6X6X40MM	25	39220.066.040	12X8X50MM	10	39220.128.050	16X10X80MM	10	39220.170.080
6X6X50MM	25	39220.066.050	12X8X60MM	10	39220.128.060	16X10X100MM	10	39220.170.100
6X6X60MM	25	39220.066.060	12X8X63MM	10	39220.128.063			
			12X8X70MM	10	39220.128.070	18X11X63MM	10	39220.191.063
8X7X40MM	25	39220.087.040	12X8X80MM	10	39220.128.080	18X11X70MM	10	39220.191.070
8X7X50MM	25	39220.087.050	12X8X90MM	10	39220.128.090	18X11X80MM	10	39220.191.080
8X7X63MM	25	39220.087.063	12X8X100MM	10	39220.128.100	18X11X90MM	10	39220.191.090
8X7X70MM	25	39220.087.070				18X11X100MM	10	39220.191.100
8X7X80MM	25	39220.087.080	14X9X50MM	10	39220.149.050	18X11X140MM	10	39220.191.140
			14X9X63MM	10	39220.149.063			
10X8X40MM	25	39220.108.040	14X9X70MM	10	39220.149.070	32X18X160MM	5	39220.338.160
10X8X50MM	25	39220.108.050	14X9X80MM	10	39220.149.080	32X18X200MM	5	39220.338.200
10X8X63MM	25	39220.108.063	14X9X90MM	10	39220.149.090			
10X8X70MM	25	39220.108.070	14X9X100MM	10	39220.149.100	36X20X160MM	5	39220.380.160
10X8X80MM	25	39220.108.080				36X20X200MM	5	39220.380.200
10X8X100MM	25	39220.108.100	16X10X63MM	10	39220.170.063			
			16X10X70MM	10	39220.170.070	40X22X200MM	5	39220.422.200
12X8X40MM	10	39220.128.040						

Fabory blind rivets

The technology of blind riveting is simple. The materials to be riveted have to be accessible from one side only.

This explains the term 'blind'. The rivet consists of two parts: the body and the mandrel. The body is deformed when the rivet is set and this deforming is what clamps the materials together. The mandrel is the part that deforms the body of the rivet. This part is stronger than the body. The mandrel breaks off at its own specific breaking point. This breaking point ensures that the mandrel breaks off at the exact right moment, so the body is deformed and the materials are clamped together correctly.

The Fabory range of blind rivets consists of five main groups:

Omni: standard open rivets

Plus Bulb & P-Lock: high strength rivets

Multi: open rivets with a large grip range

Sigma: closed end rivets

Specials: special rivets for application in soft materials (EXPO, TRIPO, HAMMER)

Fabory Omni

Fabory Omni label represents the product range of standard open blind rivets. The Fabory Omni rivet is a rivet for general use, with the mandrel breaking point placed just below the head of the mandrel.

Fabory High Strength Rivets (P-Lock & Plus Bulb)

High strength rivets are especially designed for heavy applications, for example in the automotive industry, the construction industry, repair & service, HVAC, white goods, cabinets... In short, everywhere, where high loads are combined with a need for reliability. High strength rivets are known for their high tensile and shear strengths and mandrel retention capacity

High strength group 34350 (P-Lock)

The blind rivet with a multigrip clamping range and a high tensile and shear strength offers a high resistance to vibrations and a good watertight connection. After setting, the rest mandrel is retained in the body permanently, because of the special mandrel locking system. To set this rivet special tooling or "nose piece" on the tool is needed (check tool specification). Minimal setting force required 13,5 kN

High strength groups 32635 - 32642 (Plus Bulb)

Those Plus Bulb Rivets have been engineered to fulfil a market need for a high clamp blind fastener, for thin sheet applications. Large diameter head and broad secondary flange diffuses the load over a large area, ensuring permanent clamp. This unique fastener also offers a tapered hole-seeking tip, which ensures quick and easy installation.

Advantages of groups 34350 (P-Lock) and 32635-32642 (Plus Bulb) are:

- The special locking mechanism increases the clamping force
- After setting, the mandrel is locked permanently
- A 100% watertight connection
- High resistance to vibrations
- Large clamping capacity

High strength groups 34320 - 34330 (Plus Bulb)

Those Plus Bulb rivets, steel as well as stainless steel, form a very large secondary flange on the back side after setting. This makes this rivet ideal for high strength assembly in thin sheets.

Advantages:

- High tensile and shear strengths
- Permanent mandrel retention, avoids rattling of restmandrels
- Good hole filling capacity compensates oversized, slotted or mis aligned holes
- Provides a large back side bearing area
- Good spreading of the clamping load
- Vibration resistant
- No special tooling or "nose piece" is needed

Fabory Multi

Fabory's Multi rivet is a multi-grip rivet with a larger clamping range. This can help achieve a significant reduction of stock. The Multi rivets can be used for general purposes. A large bulb is formed at the back of the rivet, spreading the clamping load to a wide area. After setting, the mandrel remains in the rivet and makes it vibration resistant. Due to the rivet's structural features, it has a good hole filling property, so the size of the pre-drilled hole is less critical.

Fabory Sigma

The Fabory Sigma range offers closed end rivets that have been especially developed to combine a strong fixation with a water or air proof seal. During setting, the rivet body expands to fill the hole, enabling the rivet to withstand pressures up to 35 bar (3500 kPa). The mandrel head is 100% retained, providing high resistance to vibration. The result is a rivet connection with higher tensile and shear strengths. To ensure optimal setting of the closed end rivets, it is important that the pre-drilled hole has the correct size.

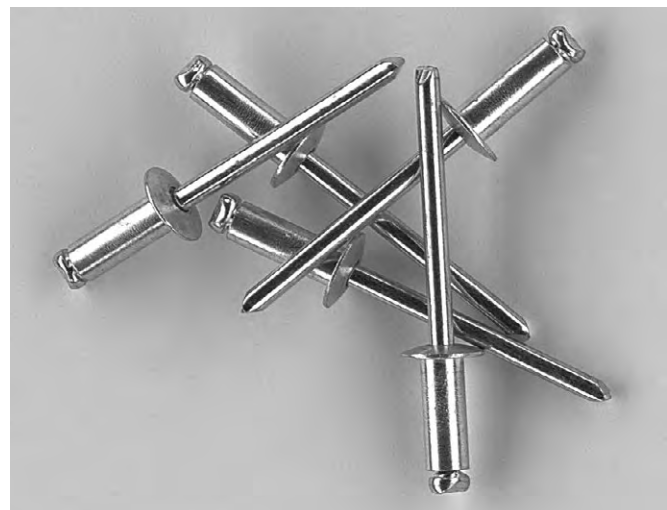

Fabory Specials

In addition to the standard ranges of blind rivets, Fabory offers the supply of many other types of blind rivets for specific applications from stock: the Fabory Specials. For application in soft materials.

- EXPO Peel rivets
- TRIPO rivets
- HAMMER rivets

Tools

Complementary to the blind rivet fastener range, a series of tools is available. There are tools for small and light assembly work as well as for heavy duty purposes. Fabory carries high quality hand tools, hydraulic / pneumatic tools as well as battery powered (cordless) tools. Please take a look at www.fabory.com for more details.

Domed head blind rivet

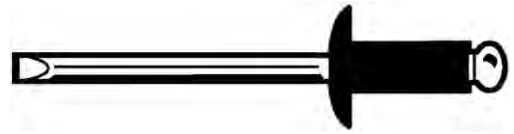
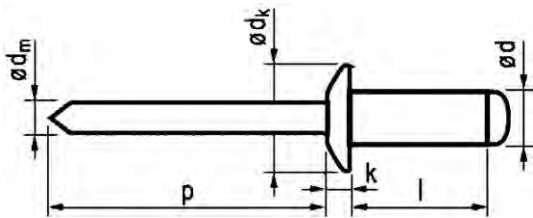

Technical Data

$\varnothing d$	Drill \varnothing	k	p	$\varnothing d_k$
2.4	2.5	0.7	≥ 27	5.0
3.0	3.1	0.8	≥ 27	6.5
3.2	3.3	0.8	≥ 27	6.5
4.0	4.1	1.0	≥ 27	8.0
4.8	4.9	1.1	≥ 27	9.5
5.0	5.1	1.1	≥ 27	9.5
6.0	6.1	1.5	≥ 31	12.0
6.4	6.5	1.8	≥ 31	13.0

Article groups

Material	Surface treatment		Code	Page
Al AlMg 2,5/3,5		Al-St.zipl	34110	9-56
Al AlMg 2,5/3,5		Al blk a.-St zipl	34310	9-57
Al AlMg 3		Al-St.St. A2	34190	9-57
Al AlMg 2,5		Al-Al	33190	9-58
St	Zipl	St zipl-St zipl	34130	9-58
St.St. A2		St.St. A2-St.St. A2	34180	9-59
St.St. A4		St.St. A4-St.St. A4	34186	9-60
Cu		Cu-St zipl	34150	9-60

Material Aluminium AIMg 2,5/3,5



ø d	l		ø d _m		
(mm)	(mm)	(mm)	(mm)	(N)	(N)
2,4	4,0	≈ 2,0	≈ 1,45	355	315
2,4	6,0	2,0-4,0	≈ 1,45	355	315
2,4	8,0	4,0-6,0	≈ 1,45	355	315
3,0	4,0	≈ 1,5	≈ 1,75	810	620
3,0	6,0	1,5-3,5	≈ 1,75	810	620
3,0	8,0	3,5-5,5	≈ 1,75	810	620
3,0	10,0	5,5-7,5	≈ 1,75	810	620
3,0	12,0	7,5-9,5	≈ 1,75	810	620
3,0	16,0	11,5-13,5	≈ 1,75	810	620
3,2	4,0	≈ 1,5	≈ 1,75	980	760
3,2	6,0	1,5-3,5	≈ 1,75	980	760
3,2	8,0	3,5-5,5	≈ 1,75	980	760
3,2	10,0	5,5-7,5	≈ 1,75	980	760
3,2	12,0	7,5-9,5	≈ 1,75	980	760
3,2	14,0	9,5-11,5	≈ 1,75	980	760
3,2	16,0	11,5-13,5	≈ 1,75	980	760
3,2	18,0	13,5-15,5	≈ 1,75	980	760
3,2	20,0	15,5-17,5	≈ 1,75	980	760
4,0	5,0	≈ 1,5	≈ 2,10	1600	1200
4,0	6,0	1,5-3,0	≈ 2,10	1600	1200
4,0	8,0	3,0-5,0	≈ 2,10	1600	1200
4,0	10,0	5,0-6,5	≈ 2,10	1600	1200
4,0	12,0	6,5-8,5	≈ 2,10	1600	1200
4,0	14,0	8,5-10,5	≈ 2,10	1600	1200
4,0	16,0	10,5-12,5	≈ 2,10	1600	1200
4,0	18,0	12,5-14,5	≈ 2,10	1600	1200
4,0	20,0	14,5-16,5	≈ 2,10	1600	1200
4,0	25,0	19,0-21,5	≈ 2,10	1600	1200
4,0	30,0	21,5-26,0	≈ 2,10	1600	1200
4,0	35,0	26,0-30,0	≈ 2,10	1600	1200
4,8	6,0	1,0-3,0	≈ 2,70	2230	1690
4,8	8,0	3,0-4,5	≈ 2,70	2230	1690
4,8	10,0	4,5-6,0	≈ 2,70	2230	1690
4,8	12,0	6,0-8,0	≈ 2,70	2230	1690
4,8	14,0	8,0-10,0	≈ 2,70	2230	1690
4,8	16,0	10,0-12,0	≈ 2,70	2230	1690
4,8	18,0	12,0-14,0	≈ 2,70	2230	1690
4,8	20,0	14,0-16,0	≈ 2,70	2230	1690
4,8	22,0	16,0-18,0	≈ 2,70	2230	1690



ø d	l		ø d _m		
(mm)	(mm)	(mm)	(mm)	(N)	(N)
4,8	25,0	18,0-21,0	≈ 2,70	2230	1690
4,8	28,0	21,0-23,5	≈ 2,70	2230	1690
4,8	30,0	23,5-25,0	≈ 2,70	2230	1690
4,8	35,0	25,0-30,0	≈ 2,70	2230	1690
4,8	45,0	35,0-39,0	≈ 2,70	2230	1690
5,0	6,0	1,0-3,0	≈ 2,70	2500	2000
5,0	8,0	3,0-4,5	≈ 2,70	2500	2000
5,0	10,0	4,5-6,0	≈ 2,70	2500	2000
5,0	12,0	6,0-8,0	≈ 2,70	2500	2000
5,0	14,0	8,0-10,0	≈ 2,70	2500	2000
5,0	16,0	10,0-12,0	≈ 2,70	2500	2000
5,0	18,0	12,0-14,0	≈ 2,70	2500	2000
5,0	21,0	14,0-17,0	≈ 2,70	2500	2000
5,0	25,0	17,0-20,0	≈ 2,70	2500	2000
5,0	27,0	20,0-23,0	≈ 2,70	2500	2000
5,0	30,0	23,0-25,0	≈ 2,70	2500	2000
5,0	35,0	25,0-30,0	≈ 2,70	2500	2000
5,0	40,0	30,0-35,0	≈ 2,70	2500	2000
5,0	45,0	35,0-40,0	≈ 2,70	2500	2000
5,0	50,0	40,0-45,0	≈ 2,70	2500	2000
5,0	55,0	45,0-50,0	≈ 2,70	2500	2000
5,0	60,0	50,0-55,0	≈ 2,70	2500	2000
6,0	8,0	2,0-4,0	≈ 3,60	3900	3000
6,0	10,0	4,0-6,0	≈ 3,60	3900	3000
6,0	12,0	6,0-8,0	≈ 3,60	3900	3000
6,0	14,0	7,0-9,0	≈ 3,60	3900	3000
6,0	16,0	9,0-11,0	≈ 3,60	3900	3000
6,0	18,0	11,0-13,0	≈ 3,60	3900	3000
6,0	22,0	13,0-17,0	≈ 3,60	3900	3000
6,0	26,0	17,0-20,0	≈ 3,60	3900	3000
6,0	30,0	20,0-24,0	≈ 3,60	3900	3000
6,4	12,0	4,0-6,0	≈ 3,85	4090	3120
6,4	15,0	6,0-9,0	≈ 3,85	4090	3120
6,4	18,0	9,0-13,0	≈ 3,85	4090	3120
6,4	22,0	13,0-16,0	≈ 3,85	4090	3120
6,4	26,0	16,0-20,0	≈ 3,85	4090	3120
6,4	30,0	18,0-24,0	≈ 3,85	4090	3120
6,4	35,0	24,0-30,0	≈ 3,85	4090	3120



9

d x L	✉	Art.number	d x L	✉	Art.number	d x L	✉	Art.number
2,4X4MM	500	34110.024.004	3,2X16MM	500	34110.032.016	4,8X8MM	500	34110.048.008
2,4X6MM	500	34110.024.006	3,2X18MM	500	34110.032.018	4,8X10MM	500	34110.048.010
2,4X8MM	500	34110.024.008	3,2X20MM	500	34110.032.020	4,8X12MM	500	34110.048.012
3,0X4MM	500	34110.030.004	4,0X6MM	500	34110.040.006	4,8X14MM	500	34110.048.014
3,0X6MM	500	34110.030.006	4,0X8MM	500	34110.040.008	4,8X16MM	500	34110.048.016
3,0X8MM	500	34110.030.008	4,0X10MM	500	34110.040.010	4,8X18MM	500	34110.048.018
3,0X10MM	500	34110.030.010	4,0X12MM	500	34110.040.012	4,8X20MM	500	34110.048.020
3,0X12MM	500	34110.030.012	4,0X14MM	500	34110.040.014	4,8X22MM	500	34110.048.022
3,0X16MM	500	34110.030.016	4,0X16MM	500	34110.040.016	4,8X25MM	500	34110.048.025
3,2X4MM	500	34110.032.004	4,0X18MM	500	34110.040.018	4,8X30MM	250	34110.048.030
3,2X6MM	500	34110.032.006	4,0X20MM	500	34110.040.020	4,8X35MM	250	34110.048.035
3,2X8MM	500	34110.032.008	4,0X25MM	500	34110.040.025	4,8X45MM	250	34110.048.045
3,2X10MM	500	34110.032.010	4,0X30MM	500	34110.040.030	5,0X6MM	500	34110.050.006
3,2X12MM	500	34110.032.012	4,0X35MM	500	34110.040.035	5,0X8MM	500	34110.050.008
3,2X14MM	500	34110.032.014	4,8X6MM	500	34110.048.006	5,0X10MM	500	34110.050.010
						5,0X12MM	500	34110.050.012

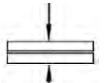
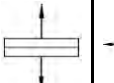

34110 OMNI Domed head blind rivet								
d x L	☒	Art.number	d x L	☒	Art.number	d x L	☒	Art.number
5,0X14MM	500	34110.050.014	5,0X50MM	100	34110.050.050	6,0X26MM	250	34110.060.026
5,0X16MM	500	34110.050.016	5,0X60MM	250	34110.050.060	6,0X30MM	250	34110.060.030
5,0X18MM	500	34110.050.018						
5,0X21MM	500	34110.050.021	6,0X8MM	500	34110.060.008	6,4X12MM	250	34110.064.012
5,0X25MM	500	34110.050.025	6,0X10MM	500	34110.060.010	6,4X15MM	250	34110.064.015
5,0X27MM	250	34110.050.027	6,0X12MM	500	34110.060.012	6,4X18MM	250	34110.064.018
5,0X30MM	500	34110.050.030	6,0X14MM	250	34110.060.014	6,4X22MM	250	34110.064.022
5,0X35MM	100	34110.050.035	6,0X16MM	500	34110.060.016	6,4X26MM	250	34110.064.026
5,0X40MM	250	34110.050.040	6,0X18MM	250	34110.060.018	6,4X30MM	250	34110.064.030
5,0X45MM	100	34110.050.045	6,0X22MM	250	34110.060.022	6,4X35MM	250	34110.064.035

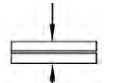
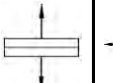

34310 OMNI Domed head blind rivet		T05A
Material	Aluminium AlMg 2,5/3,5	



ø d	l		ø d _m		
(mm)	(mm)	(mm)	(mm)	(N)	(N)
3,0	8,0	3,5-5,5	≈ 1,75	810	620
3,0	10,0	5,5-7,5	≈ 1,75	810	620
3,0	12,0	7,5-9,5	≈ 1,75	810	620

ø d	l		ø d _m		
(mm)	(mm)	(mm)	(mm)	(N)	(N)
4,0	8,0	3,0-5,0	≈ 2,10	1600	1200
4,0	10,0	5,0-6,5	≈ 2,10	1600	1200
4,0	12,0	6,5-8,5	≈ 2,10	1600	1200

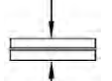
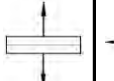
d x L	☒	Art.number	d x L	☒	Art.number	d x L	☒	Art.number
3,0X8MM	500	34310.030.008				4,0X10MM	500	34310.040.010
3,0X10MM	500	34310.030.010	4,0X8MM	500	34310.040.008	4,0X12MM	500	34310.040.012
3,0X12MM	500	34310.030.012						

34190 OMNI Domed head blind rivet		T05A
Material	Aluminium AlMg 3	
		

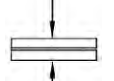
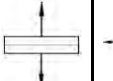
ø d	l		ø d _m		
(mm)	(mm)	(mm)	(mm)	(N)	(N)
3,0	4,0	≈ 1,5	≈ 1,75	810	620
3,0	6,0	1,5-3,5	≈ 1,75	810	620
3,0	8,0	3,5-5,5	≈ 1,75	810	620
3,0	10,0	5,5-7,0	≈ 1,75	810	620
3,0	12,0	7,0-9,0	≈ 1,75	810	620
3,2	6,0	1,5-3,5	≈ 1,95	980	760
3,2	8,0	3,5-5,5	≈ 1,95	980	760
4,0	6,0	1,0-3,0	≈ 2,10	1600	1200
4,0	8,0	3,0-5,0	≈ 2,10	1600	1200
4,0	10,0	5,0-7,0	≈ 2,10	1600	1200
4,0	12,0	7,0-9,0	≈ 2,10	1600	1200
4,0	16,0	11,5-12,5	≈ 2,10	1600	1200

ø d	l		ø d _m		
(mm)	(mm)	(mm)	(mm)	(N)	(N)
4,0	20,0	15,0-17,0	≈ 2,10	1600	1200
4,0	25,0	17,0-20,0	≈ 2,10	1600	1200
4,8	10,0	4,5-6,5	≈ 2,70	2230	1690
4,8	12,0	6,5-8,5	≈ 2,70	2230	1690
4,8	14,0	8,5-10,5	≈ 2,70	2230	1690
4,8	16,0	10,5-12,5	≈ 2,70	2230	1690
5,0	8,0	2,5-4,5	≈ 2,70	2500	2000
5,0	10,0	4,5-6,5	≈ 2,70	2500	2000
5,0	12,0	6,5-8,5	≈ 2,70	2500	2000
5,0	14,0	8,5-10,5	≈ 2,70	2500	2000
5,0	16,0	10,5-12,5	≈ 2,70	2500	2000

d x L	☒	Art.number	d x L	☒	Art.number	d x L	☒	Art.number
3,0X6MM	500	34190.030.006	4,0X8MM	500	34190.040.008	4,8X12MM	500	34190.048.012
3,0X8MM	500	34190.030.008	4,0X10MM	500	34190.040.010	4,8X14MM	500	34190.048.014
3,0X10MM	500	34190.030.010	4,0X12MM	500	34190.040.012	4,8X16MM	500	34190.048.016
3,0X12MM	500	34190.030.012	4,0X16MM	500	34190.040.016			
			4,0X20MM	250	34190.040.020	5,0X8MM	500	34190.050.008
3,2X6MM	500	34190.032.006	4,0X25MM	500	34190.040.025	5,0X10MM	500	34190.050.010
3,2X8MM	500	34190.032.008				5,0X12MM	500	34190.050.012
4,0X6MM	500	34190.040.006	4,8X10MM	500	34190.048.010	5,0X16MM	500	34190.050.016

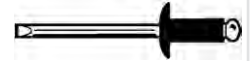
33190 OMNI Domed head blind rivet
T05A
Material Aluminium AIMg 2,5

$\varnothing d$	l		$\varnothing d_m$		
(mm)	(mm)	(mm)	(mm)	(N)	(N)
3,2	6,0	1,5-3,5	≈ 1,95	670	535
3,2	8,0	3,5-5,5	≈ 1,95	670	535
3,2	10,0	5,5-7,5	≈ 1,95	670	535
4,0	6,0	1,5-3,0	≈ 2,45	1025	845
4,0	8,0	3,0-5,0	≈ 2,45	1025	845
4,0	10,0	5,0-7,0	≈ 2,45	1025	845

$\varnothing d$	l		$\varnothing d_m$		
(mm)	(mm)	(mm)	(mm)	(N)	(N)
4,0	12,0	7,0-9,0	≈ 2,45	1025	845
4,8	8,0	2,5-4,5	≈ 2,90	1425	1155
4,8	10,0	4,5-6,5	≈ 2,90	1425	1155
4,8	12,0	6,5-8,5	≈ 2,90	1425	1155
4,8	14,0	8,5-10,5	≈ 2,90	1425	1155

$d \times L$	☒	Art.number	$d \times L$	☒	Art.number	$d \times L$	☒	Art.number
3,2X6MM	500	33190.032.006	4,0X8MM	500	33190.040.008	4,8X8MM	500	33190.048.008
3,2X8MM	500	33190.032.008	4,0X10MM	500	33190.040.010	4,8X10MM	500	33190.048.010
3,2X10MM	500	33190.032.010	4,0X12MM	500	33190.040.012	4,8X12MM	500	33190.048.012
4,0X6MM	500	33190.040.006				4,8X14MM	500	33190.048.014

34130 OMNI Domed head blind rivet
T05A
Material Steel
Surface treatment Zinc plated



$\varnothing d$	l		$\varnothing d_m$		
(mm)	(mm)	(mm)	(mm)	(N)	(N)
3,0	6,0	1,5-3,0	≈ 1,90	1125	915
3,0	8,0	3,0-5,0	≈ 1,90	1125	915
3,0	10,0	5,0-7,0	≈ 1,90	1125	915
3,0	12,0	7,0-9,0	≈ 1,90	1125	915
3,0	14,0	9,0-11,0	≈ 1,90	1125	915
3,2	6,0	1,5-3,0	≈ 2,00	1285	1060
3,2	8,0	3,0-5,0	≈ 2,00	1285	1060
3,2	10,0	5,0-7,0	≈ 2,00	1285	1060
3,2	12,0	7,0-9,0	≈ 2,00	1285	1060
3,2	14,0	9,0-11,0	≈ 2,00	1285	1060
4,0	6,0	1,5-2,5	≈ 2,50	1990	1550
4,0	8,0	2,5-4,5	≈ 2,50	1990	1550
4,0	10,0	4,5-6,5	≈ 2,50	1990	1550
4,0	12,0	6,5-8,5	≈ 2,50	1990	1550
4,0	14,0	8,5-10,5	≈ 2,50	1990	1550
4,0	16,0	10,5-12,5	≈ 2,50	1990	1550
4,0	18,0	12,5-14,5	≈ 2,50	1990	1550
4,0	20,0	14,5-16,5	≈ 2,50	1990	1550
4,8	6,0	1,0-2,5	≈ 2,90	2920	2300
4,8	8,0	2,5-4,5	≈ 2,90	2920	2300
4,8	10,0	4,5-6,0	≈ 2,90	2920	2300
4,8	12,0	6,0-8,0	≈ 2,90	2920	2300
4,8	14,0	8,0-10,0	≈ 2,90	2920	2300
4,8	16,0	10,0-11,5	≈ 2,90	2920	2300

$\varnothing d$	l		$\varnothing d_m$		
(mm)	(mm)	(mm)	(mm)	(N)	(N)
4,8	18,0	11,5-13,5	≈ 2,90	2920	2300
4,8	20,0	13,5-15,0	≈ 2,90	2920	2300
4,8	22,0	15,0-17,0	≈ 2,90	2920	2300
4,8	25,0	17,0-20,0	≈ 2,90	2920	2300
5,0	8,0	2,5-4,0	≈ 2,90	3255	2575
5,0	10,0	4,0-6,0	≈ 2,90	3255	2575
5,0	12,0	6,0-8,0	≈ 2,90	3255	2575
5,0	14,0	8,0-10,0	≈ 2,90	3255	2575
5,0	16,0	10,0-11,5	≈ 2,90	3255	2575
5,0	18,0	11,5-13,5	≈ 2,90	3255	2575
5,0	20,0	13,5-15,0	≈ 2,90	3255	2575
5,0	25,0	15,0-16,5	≈ 2,90	3255	2575
5,0	30,0	21,0-24,0	≈ 2,90	3255	2575
5,0	35,0	22,0-30,0	≈ 2,90	3255	2575
5,0	40,0	27,0-35,0	≈ 2,90	3255	2575
6,0	10,0	1,5-4,5	≈ 3,60	5020	4040
6,0	12,0	3,5-6,5	≈ 3,60	5020	4040
6,4	12,0	3,5-6,5	≈ 3,85	5415	4355
6,4	15,0	6,5-9,5	≈ 3,85	5415	4355
6,4	18,0	9,5-12,5	≈ 3,85	5415	4355
6,4	22,0	14,5-16,5	≈ 3,85	5415	4355
6,4	26,0	18,5-20,5	≈ 3,85	5415	4355
6,4	30,0	22,5-24,5	≈ 3,85	5415	4355

$d \times L$	☒	Art.number	$d \times L$	☒	Art.number	$d \times L$	☒	Art.number
3,0X6MM	500	34130.030.006	3,0X14MM	500	34130.030.014	3,2X10MM	500	34130.032.010
3,0X8MM	500	34130.030.008				3,2X12MM	500	34130.032.012
3,0X10MM	500	34130.030.010	3,2X6MM	500	34130.032.006	3,2X14MM	500	34130.032.014
3,0X12MM	500	34130.030.012	3,2X8MM	500	34130.032.008			

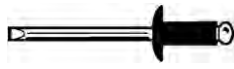
34130 OMNI Domed head blind rivet								
d x L	☒	Art.number	d x L	☒	Art.number	d x L	☒	Art.number
4,0X6MM	500	34130.040.006	4,8X14MM	500	34130.048.014	5,0X20MM	500	34130.050.020
4,0X8MM	500	34130.040.008	4,8X16MM	500	34130.048.016	5,0X40MM	250	34130.050.040
4,0X10MM	500	34130.040.010	4,8X18MM	500	34130.048.018			
4,0X12MM	500	34130.040.012	4,8X20MM	500	34130.048.020	6,0X12MM	250	34130.060.012
4,0X14MM	500	34130.040.014	4,8X22MM	250	34130.048.022			
4,0X16MM	500	34130.040.016	4,8X25MM	250	34130.048.025	6,4X12MM	250	34130.064.012
4,0X18MM	500	34130.040.018				6,4X15MM	250	34130.064.015
4,0X20MM	500	34130.040.020	5,0X8MM	500	34130.050.008	6,4X18MM	200	34130.064.018
			5,0X10MM	500	34130.050.010	6,4X22MM	250	34130.064.022
4,8X6MM	500	34130.048.006	5,0X12MM	500	34130.050.012	6,4X26MM	250	34130.064.026
4,8X8MM	500	34130.048.008	5,0X14MM	500	34130.050.014	6,4X30MM	100	34130.064.030
4,8X10MM	500	34130.048.010	5,0X16MM	250	34130.050.016			
4,8X12MM	500	34130.048.012	5,0X18MM	200	34130.050.018			

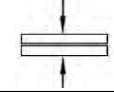
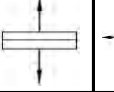
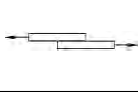
34180 OMNI Domed head blind rivet		T05A
Material	Stainless steel A2	
		
		

ø d	l		ø d _m		
(mm)	(mm)	(mm)	(mm)	(N)	(N)
3,0	6,0	1,5-2,5	≈ 1,90	2000	1600
3,0	8,0	2,5-4,5	≈ 1,90	2000	1600
3,0	10,10	4,5-6,5	≈ 1,90	2000	1600
3,0	12,0	6,5-8,5	≈ 1,90	2000	1600
3,0	15,0	9,5-11,5	≈ 1,90	2000	1600
3,2	6,0	1,5-2,5	≈ 2,00	2500	1800
3,2	8,0	2,5-4,5	≈ 2,00	2500	1800
3,2	10,0	4,5-6,5	≈ 2,00	2500	1800
3,2	12,0	6,5-8,5	≈ 2,00	2500	1800
3,2	15,0	8,5-12,0	≈ 2,00	2500	1800
4,0	6,0	≈ 2,0	≈ 2,50	3800	3100
4,0	8,0	2,0-4,0	≈ 2,50	3800	3100
4,0	10,0	4,0-6,0	≈ 2,50	3800	3100
4,0	13,0	7,0-9,0	≈ 2,50	3800	3100
4,0	14,0	9,0-10,0	≈ 2,50	3800	3100
4,0	16,0	10,0-12,0	≈ 2,50	3800	3100
4,0	18,0	12,0-14,0	≈ 2,50	3800	3100
4,0	20,0	14,0-16,0	≈ 2,50	3800	3100

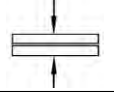
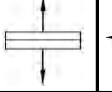
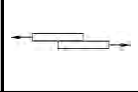

ø d	l		ø d _m		
(mm)	(mm)	(mm)	(mm)	(N)	(N)
4,0	25,0	17,0-21,0	≈ 2,50	3800	3100
4,8	8,0	1,5-3,0	≈ 2,90	6000	4500
4,8	10,0	3,0-5,0	≈ 2,90	6000	4500
4,8	12,0	5,0-7,0	≈ 2,90	6000	4500
4,8	16,0	9,0-11,0	≈ 2,90	6000	4500
4,8	18,0	11,0-13,0	≈ 2,90	6000	4500
4,8	20,0	13,0-15,0	≈ 2,90	6000	4500
4,8	25,0	15,0-20,0	≈ 2,90	6000	4500
4,8	27,0	18,0-22,0	≈ 2,90	6000	4500
4,8	30,0	20,0-25,0	≈ 2,90	6000	4500
5,0	8,0	1,5-3,0	≈ 2,90	6500	5000
5,0	10,0	3,0-5,0	≈ 2,90	6500	5000
5,0	12,0	5,0-7,0	≈ 2,90	6500	5000
5,0	16,0	9,0-11,0	≈ 2,90	6500	5000
5,0	18,0	11,0-13,0	≈ 2,90	6500	5000
5,0	20,0	13,0-15,0	≈ 2,90	6500	5000
5,0	25,0	17,0-20,0	≈ 2,90	6500	5000



d x L	☒	Art.number	d x L	☒	Art.number	d x L	☒	Art.number
3,0X6MM	500	34180.030.006	4,0X6MM	500	34180.040.006	4,8X14MM	500	34180.048.014
3,0X8MM	500	34180.030.008	4,0X8MM	500	34180.040.008	4,8X16MM	500	34180.048.016
3,0X10MM	500	34180.030.010	4,0X10MM	500	34180.040.010	4,8X18MM	500	34180.048.018
3,0X12MM	500	34180.030.012	4,0X13MM	500	34180.040.013	4,8X20MM	500	34180.048.020
3,0X15MM	500	34180.030.015	4,0X16MM	500	34180.040.016	4,8X25MM	500	34180.048.025
			4,0X18MM	500	34180.040.018	4,8X30MM	500	34180.048.030
3,2X6MM	500	34180.032.006	4,0X20MM	500	34180.040.020			
3,2X8MM	500	34180.032.008	4,0X25MM	500	34180.040.025	5,0X8MM	500	34180.050.008
3,2X10MM	500	34180.032.010				5,0X10MM	500	34180.050.010
3,2X12MM	500	34180.032.012	4,8X8MM	500	34180.048.008	5,0X12MM	500	34180.050.012
3,2X15MM	500	34180.032.015	4,8X10MM	500	34180.048.010	5,0X16MM	500	34180.050.016
			4,8X12MM	500	34180.048.012	5,0X20MM	250	34180.050.020

34186 OMNI Domed head blind rivet T05A

Material Stainless steel A4

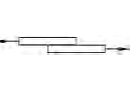

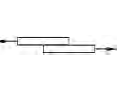

ø d	l		ø d _m		
(mm)	(mm)	(mm)	(mm)	(N)	(N)
3,0	6,0	1,5-2,5	≈ 1,90	2000	1600
3,0	8,0	2,5-4,5	≈ 1,90	2000	1600
3,0	10,0	4,6-6,5	≈ 1,90	2000	1600
3,0	12,0	6,5-8,5	≈ 1,90	2000	1600
3,2	6,0	1,5-2,5	≈ 2,00	2500	1800
3,2	8,0	2,5-4,5	≈ 2,00	2500	1800
3,2	10,0	4,5-6,5	≈ 2,00	2500	1800
3,2	12,0	6,5-8,5	≈ 2,00	2500	1800
4,0	6,0	≈ 2,0	≈ 2,50	3800	3100
4,0	8,0	2,0-4,0	≈ 2,50	3800	3100



ø d	l		ø d _m		
(mm)	(mm)	(mm)	(mm)	(N)	(N)
4,0	10,0	4,0-6,0	≈ 2,50	3800	3100
4,0	13,0	7,0-9,0	≈ 2,50	3800	3100
4,0	16,0	10,0-12,0	≈ 2,50	3800	3100
4,8	8,0	1,5-3,0	≈ 2,90	6000	4500
4,8	10,0	3,0-5,0	≈ 2,90	6000	4500
4,8	12,0	5,0-7,0	≈ 2,90	6000	4500
4,8	16,0	9,0-11,0	≈ 2,90	6000	4500
4,8	18,0	11,0-13,0	≈ 2,90	6000	4500
4,8	20,0	13,0-15,0	≈ 2,90	6000	4500

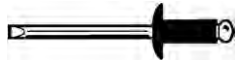

d x L	⊠	Art.number	d x L	⊠	Art.number	d x L	⊠	Art.number
3,0X6MM	500	34186.030.006	3,2X12MM	500	34186.032.012	4,8X8MM	500	34186.048.008
3,0X8MM	500	34186.030.008	4,0X6MM	500	34186.040.006	4,8X10MM	500	34186.048.010
3,0X10MM	500	34186.030.010	4,0X8MM	500	34186.040.008	4,8X12MM	500	34186.048.012
3,2X6MM	500	34186.032.006	4,0X10MM	500	34186.040.010	4,8X16MM	500	34186.048.016
3,2X8MM	500	34186.032.008	4,0X13MM	500	34186.040.013	4,8X18MM	500	34186.048.018
3,2X10MM	500	34186.032.010	4,0X16MM	500	34186.040.016	4,8X20MM	500	34186.048.020

34150 OMNI Domed head blind rivet T05A

Material Copper

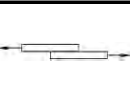

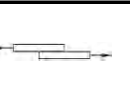

ø d	l		ø d _m		
(mm)	(mm)	(mm)	(mm)	(N)	(N)
3,0	6,0	1,0-3,0	≈ 1,75	700	600
3,0	8,0	3,0-5,0	≈ 1,75	700	600
3,0	10,0	5,0-7,0	≈ 1,75	700	600
3,0	12,0	7,0-9,0	≈ 1,75	700	600
4,0	6,0	1,0-2,5	≈ 2,10	1500	1000

ø d	l		ø d _m		
(mm)	(mm)	(mm)	(mm)	(N)	(N)
4,0	8,0	2,5-4,5	≈ 2,10	1500	1000
4,0	10,0	4,5-6,5	≈ 2,10	1500	1000
4,0	12,0	6,5-8,5	≈ 2,10	1500	1000
4,0	16,0	10,5-12,5	≈ 2,10	1500	1000

d x L	⊠	Art.number	d x L	⊠	Art.number	d x L	⊠	Art.number
3,0X6MM	500	34150.030.006	4,0X6MM	500	34150.040.006	4,0X10MM	500	34150.040.010
3,0X8MM	500	34150.030.008	4,0X8MM	500	34150.040.008	4,0X12MM	500	34150.040.012
3,0X10MM	500	34150.030.010				4,0X16MM	500	34150.040.016
3,0X12MM	500	34150.030.012						

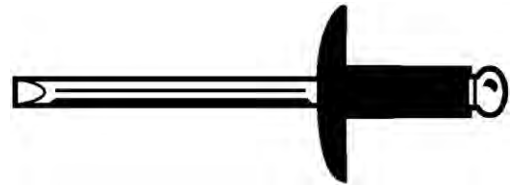
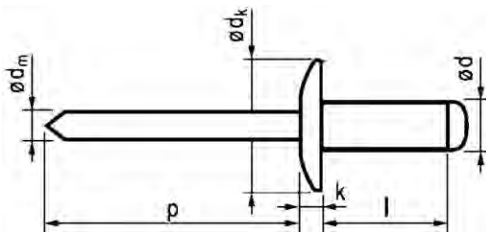
Large domed head blind rivet



Technical Data

$\varnothing d$	Drill \varnothing	k	p	$\varnothing d_k$
3.2	3.3	≤ 2.0	≥ 27	9.5
4.0	4.1	≤ 2.0	≥ 27	12.0
4.8xk14	4.9	≤ 2.5	≥ 27	14.0
4.8xk16	4.9	≤ 2.5	≥ 27	16.0
5.0xk9.5	5.1	≤ 2.5	≥ 27	9.5
5.0xk11	5.1	≤ 2.5	≥ 27	11.0
5.0xk14	5.1	≤ 2.5	≥ 27	14.0
5.0xk16	5.1	1.1	≥ 27	16.0

Article groups

Material		Code	Page
Al AIMg 3,5	Al-St Zinc plated	34113	9-61
Al AIMg 2,5	Al-St Zinc plated	34126	9-62

34113 OMNI Large domed head blind rivet

T05A

Material Aluminium AIMg 3,5

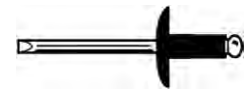



$\varnothing d$	l		$\varnothing d_m$		
(mm)	(mm)	(mm)	(mm)	(N)	(N)
3,2	6,0	1,5-3,5	$\approx 1,70$	980	760
3,2	8,0	3,5-5,5	$\approx 1,70$	980	760
3,2	10,0	5,5-7,5	$\approx 1,70$	980	760
3,2	12,0	7,5-9,5	$\approx 1,70$	980	760
4,0	6,0	1,5-3,0	$\approx 2,10$	1600	1200
4,0	8,0	3,0-5,0	$\approx 2,10$	1600	1200
4,0	10,0	5,0-6,5	$\approx 2,10$	1600	1200
4,0	12,0	6,5-8,5	$\approx 2,10$	1600	1200
4,0	14,0	8,5-10,5	$\approx 2,10$	1600	1200
4,0	16,0	10,5-12,5	$\approx 2,10$	1600	1200
4,8	8,0	3,0-4,5	$\approx 2,10$	2230	1690
4,8	10,0	4,5-6,0	$\approx 2,10$	2230	1690
4,8	12,0	6,0-8,0	$\approx 2,10$	2230	1690
4,8	16,0	10,0-12,0	$\approx 2,10$	2230	1690
4,8	18,0	12,0-14,0	$\approx 2,10$	2230	1690
4,8	20,0	14,0-16,0	$\approx 2,10$	2230	1690
5,0	8,0	2,0-5,0	$\approx 2,70$	2500	2000
5,0	10,0	4,0-6,5	$\approx 2,70$	2500	2000
5,0	12,0	6,0-8,0	$\approx 2,70$	2500	2000
5,0	14,0	7,0-10,0	$\approx 2,70$	2500	2000

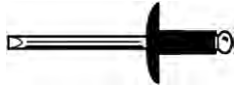

$\varnothing d$	l		$\varnothing d_m$		
(mm)	(mm)	(mm)	(mm)	(N)	(N)
5,0	16,0	8,0-12,0	$\approx 2,70$	2500	2000
5,0	18,0	11,5-13,5	$\approx 2,70$	2500	2000
5,0	20,0	12,0-15,5	$\approx 2,70$	2500	2000
5,0	25,0	15,0-20,5	$\approx 2,70$	2500	2000
5,0	30,0	20,0-25,0	$\approx 2,70$	2500	2000
5,0	8,0	3,0-4,5	$\approx 2,70$	2500	2000
5,0	10,0	4,5-6,0	$\approx 2,70$	2500	2000
5,0	12,0	6,0-8,0	$\approx 2,70$	2500	2000
5,0	14,0	8,0-10,0	$\approx 2,70$	2500	2000
5,0	16,0	10,0-12,0	$\approx 2,70$	2500	2000
5,0	18,0	12,0-14,0	$\approx 2,70$	2500	2000
5,0	21,0	14,0-17,0	$\approx 2,70$	2500	2000
5,0	25,0	17,0-20,0	$\approx 2,70$	2500	2000
5,0	30,0	23,0-26,0	$\approx 2,70$	2500	2000
5,0	10,0	2,0-6,5	$\approx 2,70$	2500	2000
5,0	16,0	6,0-12,0	$\approx 2,70$	2500	2000
5,0	20,0	11,5-15,5	$\approx 2,70$	2500	2000
5,0	25,0	15,0-20,5	$\approx 2,70$	2500	2000
5,0	33,0	20,0-28,0	$\approx 2,70$	2500	2000

d x L	☒	Art.number	d x L	☒	Art.number	d x L	☒	Art.number
3,2X6MM D=9,5	500	34113.320.609	4,0X6MM D=12	500	34113.400.612	4,0X16MM D=12	500	34113.401.612
3,2X8MM D=9,5	500	34113.320.809	4,0X8MM D=12	500	34113.400.812	4,8X10MM D=16	250	34113.481.016
3,2X10MM D=9,5	500	34113.321.009	4,0X10MM D=12	500	34113.401.012	4,8X12MM D=16	500	34113.481.216
3,2X12MM D=9,5	500	34113.321.209	4,0X12MM D=12	500	34113.401.212	4,8X16MM D=16	250	34113.481.616
			4,0X14MM D=12	100	34113.401.412	4,8X18MM D=16	250	34113.481.816

34113 OMNI Large domed head blind rivet								
d x L	☒	Art.number	d x L	☒	Art.number	d x L	☒	Art.number
4,8X20MM D=16	250	34113.482.016	5,0X12MM D=14	500	34113.501.214	5,0X20MM D=16	250	34113.502.016
			5,0X14MM D=11	500	34113.501.411	5,0X21MM D=14	250	34113.502.114
			5,0X14MM D=14	500	34113.501.414	5,0X24MM D=14	250	34113.502.414
5,0X8MM D=11	500	34113.500.811	5,0X16MM D=11	500	34113.501.611	5,0X25MM D=11	500	34113.502.511
5,0X8MM D=14	250	34113.500.814	5,0X16MM D=14	500	34113.501.614	5,0X25MM D=16	250	34113.502.516
			5,0X16MM D=16	500	34113.501.616			
5,0X10MM D=11	500	34113.501.011	5,0X18MM D=11	500	34113.501.811	5,0X30MM D=11	250	34113.503.011
5,0X10MM D=14	250	34113.501.014	5,0X18MM D=14	500	34113.501.814	5,0X30MM D=14	250	34113.503.014
5,0X10MM D=16	250	34113.501.016				5,0X35MM D=16	250	34113.503.516
5,0X12MM D=11	500	34113.501.211	5,0X20MM D=11	250	34113.502.011			

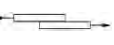
34126 MULTI Large domed head blind rivet		T05A
Material	Aluminium AlMg 2,5	
		

∅ d	l		∅ d _m		
(mm)	(mm)	(mm)	(mm)	(N)	(N)
3,2	8,0	0,5-5,0	≈ 1,78	980	680
3,2	9,5	2,0-6,5	≈ 1,78	980	680
3,2	11,1	3,5-8,0	≈ 1,78	980	680
4,0	8,0	0,5-4,5	≈ 2,18	1600	1150
4,0	12,7	4,0-9,5	≈ 2,18	1600	1150

∅ d	l		∅ d _m		
(mm)	(mm)	(mm)	(mm)	(N)	(N)
4,0	17,0	8,5-13,5	≈ 2,18	1600	1150
4,8	10,0	0,5-5,0	≈ 2,78	2350	1500
4,8	14,0	4,0-9,0	≈ 2,78	2350	1500
4,8	16,0	6,0-11,0	≈ 2,78	2350	1500
4,8	20,0	10,0-15,0	≈ 2,78	2350	1500

d x L	☒	Art.number	d x L	☒	Art.number	d x L	☒	Art.number
3,2X8MM D=9,5	500	34126.320.809	4,0X13MM D=12	500	34126.401.312	4,8X14MM D=14	250	34126.481.414
3,2X9MM D=9,5	500	34126.320.909	4,0X17MM D=12	500	34126.401.712	4,8X16MM D=14	250	34126.481.614
3,2X10MM D=9,5	500	34126.321.109	4,8X10MM D=14	250	34126.481.014	4,8X20MM D=14	250	34126.482.014
4,0X8MM D=12	500	34126.400.812						

Countersunk head blind rivet

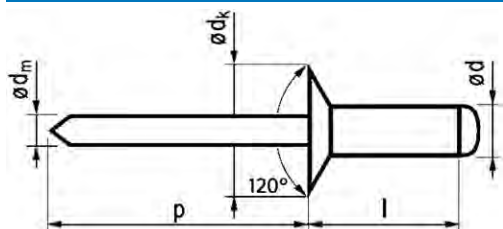

Technical Data

$\varnothing d$	Drill \varnothing	p	$\varnothing d_k$
3.0	3.1	≥ 27	6.0
3.2	3.3	≥ 27	6.0
4.0	4.1	≥ 27	7.5
4.8	4.9	≥ 27	9.0
5.0	5.1	≥ 27	9.0

Article groups

Material	Surface treatment	Code	Page
Al AlMg 2,5/3,5		Al-St zipl	34120
Al AlMg 3		Al-St.St. A2	34200
St	Zipl	St zipl-St zipl	34140
St.St. A2		St.St. A2-St.St. A3	34184

34120 OMNI Countersunk head blind rivet

T05A

Material Aluminium AlMg 2,5/3,5



$\varnothing d$	l		$\varnothing d_m$		
(mm)	(mm)	(mm)	(mm)	(N)	(N)
3,0	6,0	1,5-3,5	$\approx 1,75$	810	620
3,0	8,0	3,5-5,5	$\approx 1,75$	810	620
3,0	10,0	5,5-7,5	$\approx 1,75$	810	620
3,0	12,0	7,5-9,5	$\approx 1,75$	810	620
3,2	6,0	1,5-3,5	$\approx 1,75$	980	760
3,2	8,0	3,5-5,5	$\approx 1,75$	980	760
3,2	10,0	5,5-7,5	$\approx 1,75$	980	760
3,2	12,0	7,5-9,5	$\approx 1,75$	980	760
4,0	6,0	1,5-3,0	$\approx 2,10$	1600	1200
4,0	8,0	3,0-5,0	$\approx 2,10$	1600	1200
4,0	10,0	5,0-6,5	$\approx 2,10$	1600	1200
4,0	12,0	6,5-8,5	$\approx 2,10$	1600	1200
4,0	14,0	10,5-12,5	$\approx 2,10$	1600	1200
4,0	16,0	12,5-14,5	$\approx 2,10$	1600	1200
4,8	8,0	3,0-4,5	$\approx 2,70$	2230	1690



$\varnothing d$	l		$\varnothing d_m$		
(mm)	(mm)	(mm)	(mm)	(N)	(N)
4,8	10,0	4,5-6,0	$\approx 2,70$	2230	1690
4,8	12,0	6,0-8,0	$\approx 2,70$	2230	1690
4,8	14,0	8,0-10,0	$\approx 2,70$	2230	1690
4,8	16,0	10,0-12,0	$\approx 2,70$	2230	1690
4,8	18,0	12,0-14,0	$\approx 2,70$	2230	1690
4,8	20,0	14,0-16,0	$\approx 2,70$	2230	1690
4,8	25,0	18,0-21,0	$\approx 2,70$	2230	1690
5,0	8,0	3,0-4,5	$\approx 2,70$	2500	2000
5,0	10,0	4,5-6,0	$\approx 2,70$	2500	2000
5,0	12,0	6,0-8,0	$\approx 2,70$	2500	2000
5,0	14,0	8,0-10,0	$\approx 2,70$	2500	2000
5,0	16,0	10,0-12,0	$\approx 2,70$	2500	2000
5,0	18,0	12,0-14,0	$\approx 2,70$	2500	2000
5,0	21,0	14,0-17,0	$\approx 2,70$	2500	2000
5,0	25,0	17,0-20,0	$\approx 2,70$	2500	2000



$d \times L$	☒	Art.number	$d \times L$	☒	Art.number	$d \times L$	☒	Art.number
3,0X6MM	500	34120.030.006	4,0X10MM	500	34120.040.010	4,8X20MM	250	34120.048.020
3,0X8MM	500	34120.030.008	4,0X12MM	500	34120.040.012	4,8X25MM	250	34120.048.025
3,0X10MM	500	34120.030.010	4,0X16MM	500	34120.040.016	5,0X8MM	500	34120.050.008
3,0X12MM	500	34120.030.012	4,0X18MM	500	34120.040.018	5,0X10MM	500	34120.050.010
3,2X6MM	500	34120.032.006	4,8X8MM	500	34120.048.008	5,0X12MM	500	34120.050.012
3,2X8MM	500	34120.032.008	4,8X10MM	500	34120.048.010	5,0X14MM	250	34120.050.014
3,2X10MM	500	34120.032.010	4,8X12MM	500	34120.048.012	5,0X16MM	500	34120.050.016
3,2X12MM	500	34120.032.012	4,8X14MM	500	34120.048.014	5,0X18MM	500	34120.050.018
4,0X6MM	500	34120.040.006	4,8X16MM	500	34120.048.016	5,0X20MM	250	34120.050.020
4,0X8MM	500	34120.040.008	4,8X18MM	500	34120.048.018	5,0X25MM	250	34120.050.025

34200 OMNI Countersunk head blind rivet T05A

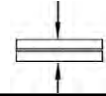
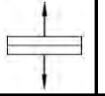
Material Aluminium AIMg 3

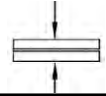
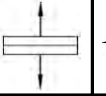

$\varnothing d$	l		$\varnothing d_m$		
(mm)	(mm)	(mm)	(mm)	(N)	(N)
3,0	6,0	1,5-3,5	≈ 1,75	870	680
3,0	8,0	3,5-5,0	≈ 1,75	870	680
3,0	10,0	5,0-7,0	≈ 1,75	870	680
4,0	6,0	1,0-2,5	≈ 2,10	1600	1200
4,0	8,0	2,5-5,0	≈ 2,10	1600	1200

$\varnothing d$	l		$\varnothing d_m$		
(mm)	(mm)	(mm)	(mm)	(N)	(N)
4,0	10,0	5,0-6,5	≈ 2,10	1600	1200
4,0	12,0	6,0-8,0	≈ 2,10	1600	1200
5,0	12,0	4,0-8,5	≈ 2,70	2500	2000
5,0	14,0	8,0-10,0	≈ 2,70	2500	2000
5,0	16,0	10,0-12,0	≈ 2,70	2500	2000

d x L	☒	Art.number	d x L	☒	Art.number	d x L	☒	Art.number
3,0X6MM	500	34200.030.006	4,0X6MM	500	34200.040.006	4,0X12MM	500	34200.040.012
3,0X8MM	500	34200.030.008	4,0X8MM	500	34200.040.008			
3,0X10MM	500	34200.030.010	4,0X10MM	500	34200.040.010	5,0X12MM	500	34200.050.012

34140 OMNI Countersunk head blind rivet T05A

Material Steel
Surface treatment Zinc plated

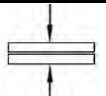
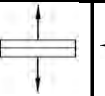
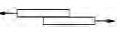

$\varnothing d$	l		$\varnothing d_m$		
(mm)	(mm)	(mm)	(mm)	(N)	(N)
3,0	6,0	1,5-3,0	≈ 1,90	1125	915
3,0	8,0	3,0-5,0	≈ 1,90	1125	915
3,0	10,0	5,0-7,0	≈ 1,90	1125	915
3,0	12,0	7,0-9,0	≈ 1,90	1125	915
3,2	6,0	1,5-3,0	≈ 2,00	1285	1060
3,2	8,0	3,0-5,0	≈ 2,00	1285	1060
4,0	6,0	1,5-2,5	≈ 2,50	1990	1550
4,0	8,0	2,5-4,5	≈ 2,50	1990	1550
4,0	10,0	4,5-6,5	≈ 2,50	1990	1550
4,0	12,0	6,5-8,5	≈ 2,50	1990	1550

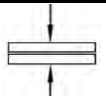
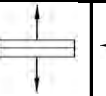
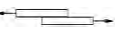
$\varnothing d$	l		$\varnothing d_m$		
(mm)	(mm)	(mm)	(mm)	(N)	(N)
4,0	16,0	10,5-12,5	≈ 2,50	1990	1550
4,8	8,0	2,5-4,5	≈ 2,90	2920	2300
4,8	10,0	4,5-6,0	≈ 2,90	2920	2300
4,8	12,0	6,0-8,0	≈ 2,90	2920	2300
4,8	14,0	8,0-10,0	≈ 2,90	2920	2300
4,8	16,0	10,0-11,5	≈ 2,90	2920	2300
4,8	18,0	11,5-13,5	≈ 2,90	2920	2300
4,8	20,0	13,5-15,5	≈ 2,90	2920	2300
5,0	20,0	13,5-15,0	≈ 2,90	4000	3100
5,0	25,0	17,0-20,0	≈ 2,90	4000	3100

d x L	☒	Art.number	d x L	☒	Art.number	d x L	☒	Art.number
3,0X6MM	500	34140.030.006	4,0X8MM	500	34140.040.008	4,8X14MM	500	34140.048.014
3,0X8MM	500	34140.030.008	4,0X10MM	500	34140.040.010	4,8X16MM	500	34140.048.016
3,0X10MM	500	34140.030.010	4,0X12MM	500	34140.040.012	4,8X18MM	500	34140.048.018
3,0X12MM	500	34140.030.012	4,0X14MM	500	34140.040.014	4,8X20MM	250	34140.048.020
			4,0X16MM	500	34140.040.016			
3,2X6MM	1000	34140.032.006				5,0X20MM	250	34140.050.020
3,2X8MM	500	34140.032.008	4,8X8MM	500	34140.048.008	5,0X25MM	250	34140.050.025
			4,8X10MM	500	34140.048.010			
4,0X6MM	500	34140.040.006	4,8X12MM	200	34140.048.012			

34184	OMNI Countersunk head blind rivet	T05A
Material	Stainless steel A2	

$\varnothing d$	l		$\varnothing d_m$		
(mm)	(mm)	(mm)	(mm)	(N)	(N)
4,0	8,0	2,0-4,0	$\approx 2,50$	3800	3100
4,0	10,0	4,0-6,0	$\approx 2,50$	3800	3100
4,0	12,0	6,0-8,0	$\approx 2,50$	3800	3100
4,0	15,0	9,0-11,0	$\approx 2,50$	3800	3100

$\varnothing d$	l		$\varnothing d_m$		
(mm)	(mm)	(mm)	(mm)	(N)	(N)
4,8	8,0	1,5-3,0	$\approx 2,90$	6000	4500
4,8	10,0	3,0-5,0	$\approx 2,90$	6000	4500
4,8	12,0	5,0-7,0	$\approx 2,90$	6000	4500
4,8	15,0	8,0-10,0	$\approx 2,90$	6000	4500

$d \times L$	☒	Art.number	$d \times L$	☒	Art.number	$d \times L$	☒	Art.number
4,0X8MM	500	34184.040.008	4,0X15MM	500	34184.040.015	4,8X10MM	500	34184.048.010
4,0X10MM	500	34184.040.010				4,8X12MM	500	34184.048.012
4,0X12MM	500	34184.040.012	4,8X8MM	500	34184.048.008	4,8X15MM	500	34184.048.015

Domed head blind rivet PLUS BULB



Technical Data				
$\varnothing d$	Drill \varnothing	k	p	$\varnothing d_k$
4.8	5.0	2.2	≥ 32	9.8
6.4	6.6	3.0	≥ 32	13.0

32635	PLUS BULB Domed head blind rivet	T01A
Material	Steel	
Surface treatment	Zinc plated	

$\varnothing d$	l		$\varnothing d_m$		
(mm)	(mm)	(mm)	(mm)	(N)	(N)
4,8	11,5	3,5-6,0	$\approx 3,02$	3600	3920/6270
4,8	14,0	6,0-8,5	$\approx 3,02$	3600	3920/6270
6,4	10,5	2,8-4,8	$\approx 4,17$	6600	5390/11180
6,4	12,5	4,8-6,8	$\approx 4,17$	6600	5390/11180

$\varnothing d$	l		$\varnothing d_m$		
(mm)	(mm)	(mm)	(mm)	(N)	(N)
6,4	14,5	6,8-8,8	$\approx 4,17$	6600	5390/11180
6,4	16,5	8,8-10,8	$\approx 4,17$	6600	5390/11180
6,4	18,5	10,8-12,8	$\approx 4,17$	6600	5390/11180
6,4	20,5	12,8-14,8	$\approx 4,17$	6600	5390/11180

$d \times L$	☒	Art.number	$d \times L$	☒	Art.number	$d \times L$	☒	Art.number
4,8X11,5MM	500	32635.048.011	6,4X10,5MM	250	32635.064.010	6,4X16,5MM	200	32635.064.016
4,8X14MM	250	32635.048.014	6,4X12,5MM	250	32635.064.012	6,4X18,5MM	200	32635.064.018
			6,4X14,5MM	200	32635.064.014	6,4X20,5MM	200	32635.064.020

PLUS BULB Domed head structural blind rivet

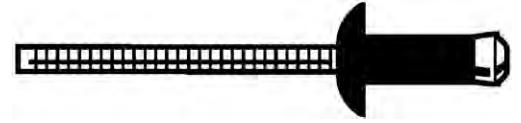
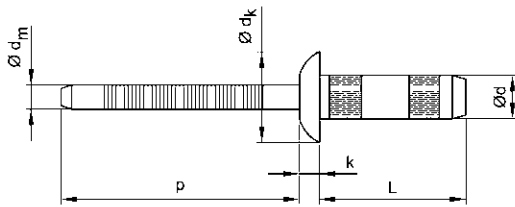

Technical Data

Ø d	Drill ø	k (max.)	p	Ø d _k
3.2	3.3	1.4	>27	6.8
4.0	4.1	1.5	>27	8.0
4.8	4.9	1.5	>27	9.6

Article groups

Material	Code	Page
St	34320	9-66
St.St.	34330	9-66

34320 PLUS BULB Domed head structural blind rivet

T05A

Material Steel

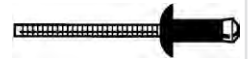

Ø d	l	Ø d _m	(N)	(N)
3,2	6,6	≈ 2,00	1300	1200
3,2	9,2	≈ 2,00	1300	1700
3,2	11,5	≈ 2,00	1300	2500
4,0	7,5	≈ 2,60	2800	3500
4,0	9,5	≈ 2,60	2800	3500

Ø d	l	Ø d _m	(N)	(N)
4,0	12,5	≈ 2,60	2800	3500
4,8	10,0	≈ 3,00	3800	4200
4,8	12,0	≈ 3,00	3800	4200
4,8	14,3	≈ 3,00	3800	4200

d x L	Art.number	d x L	Art.number	d x L	Art.number
3,2X7,0MM	500 34320.032.007	4,0X8,0MM	500 34320.040.008	4,8X9,0MM	500 34320.048.009
3,2X9,0MM	500 34320.032.009	4,0X10,0MM	500 34320.040.010	4,8X12,0MM	500 34320.048.012
3,2X11,0MM	500 34320.032.011	4,0X12,0MM	500 34320.040.012	4,8X14,0MM	500 34320.048.014

34330 PLUS BULB Domed head structural blind rivet

T05A

Material Stainless steel A2



Ø d	l	Ø d _m	(N)	(N)
3,2	6,6	≈ 2,10	2000	1600
3,2	9,2	≈ 2,10	2000	1700
3,2	11,5	≈ 2,10	2000	2500
4,0	7,5	≈ 2,60	4000	4200
4,0	9,5	≈ 2,60	4000	4200

Ø d	l	Ø d _m	(N)	(N)
4,0	12,5	≈ 2,60	4000	4200
4,8	10,0	≈ 3,20	5000	5500
4,8	12,0	≈ 3,20	5000	5500
4,8	14,3	≈ 3,20	5000	5500

d x L	Art.number	d x L	Art.number	d x L	Art.number
3,2X7,0MM	500 34330.032.007	3,2X11,0MM	500 34330.032.011	4,0X8,0MM	500 34330.040.008
3,2X9,0MM	500 34330.032.009			4,0X10,0MM	500 34330.040.010

34330 PLUS BULB Domed head structural blind rivet								
d x L	⊗	Art.number	d x L	⊗	Art.number	d x L	⊗	Art.number
4,0X12,0MM	500	34330.040.012	4,8X9,0MM	500	34330.048.009	4,8X14,0MM	500	34330.048.014
			4,8X12,0MM	500	34330.048.012			

P-LOCK Domed head structural blind rivet



Technical Data				
$\varnothing d$	Drill \varnothing	k (max.)	p	$\varnothing d_k$
6.4	6.6	2.9	>27	12.7

34350 P-LOCK Domed head structural blind rivet		T05A
Material	Steel	

$\varnothing d$	l		$\varnothing d_m$		
(mm)	(mm)	(mm)	(mm)	(N)	(N)
6,4	14,0	2,0-9,5	≈ 4,00	10400	11700

$\varnothing d$	l		$\varnothing d_m$		
(mm)	(mm)	(mm)	(mm)	(N)	(N)
6,4	20,0	2,0-15,8	≈ 4,00	10400	11700

d x L	⊗	Art.number	d x L	⊗	Art.number
6,4X14MM	250	34350.064.014	6,4X20MM	250	34350.064.020

PLUS BULB Countersunk head blind rivet

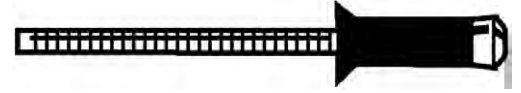
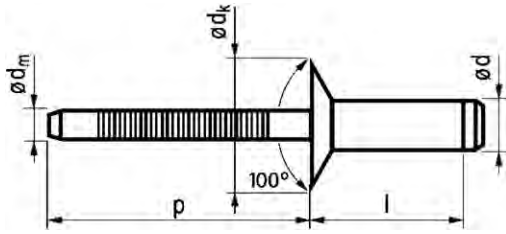

Technical Data

$\varnothing d$	Drill \varnothing	k	p	$\varnothing d_k$
6.4	6.6	2.0	≥ 32	10.0

32642 PLUS BULB Countersunk head blind rivet T05A

Material: Steel
Surface treatment: Zinc plated

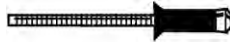



$\varnothing d$	l		$\varnothing d_m$		
(mm)	(mm)	(mm)	(mm)	(N)	(N)
6,4	13,5	5,8-7,8	$\approx 4,17$	5490	5390/10300
6,4	15,5	7,8-9,8	$\approx 4,17$	5490	5390/10300

$\varnothing d$	l		$\varnothing d_m$		
(mm)	(mm)	(mm)	(mm)	(N)	(N)
6,4	17,5	9,8-11,8	$\approx 4,17$	5490	5390/10300
6,4	19,5	11,8-13,8	$\approx 4,17$	5490	5390/10300

d x L	☒	Art.number	d x L	☒	Art.number	d x L	☒	Art.number
6,4X13,5MM	250	32642.064.013	6,4X17,5MM	250	32642.064.017	6,4X19,5MM	250	32642.064.019
6,4X15,5MM	250	32642.064.015						

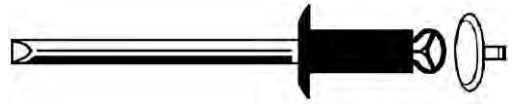
Expanding blind rivet domed head with cap



Technical Data

d	Rivet head ø
4.8	9.5

72004 Expanding blind rivet domed head with cap

Y92D

Material Aluminium



d x L		Art.number
4,8X15,5MM	100	72004.048.015

Multigrip blind rivet domed head, Type A

DIN ≈7337 A

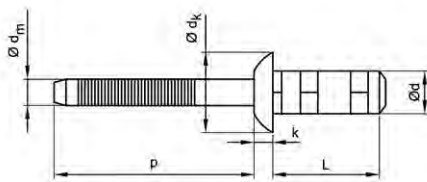

Technical Data

ø d	Drill ø	k (max.)	p	ø d _k
3.2	3.3	1.02	>27	6.4
4.0	4.1	1.27	>27	7.9
4.8	4.9	1.52	>27	9.5

33900 Multigrip blind rivet domed head, Type A

T05A

Material Steel

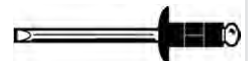

ø d	l		ø d _m		
(mm)	(mm)	(mm)	(mm)	(N)	(N)
3,2	11,4	1,6-6,4	≈ 2,05	1400	1100
4,0	12,0	1,6-6,4	≈ 2,65	2100	1800
4,0	13,6	3,2-8,0	≈ 2,65	2100	1800

ø d	l		ø d _m		
(mm)	(mm)	(mm)	(mm)	(N)	(N)
4,8	12,7	1,6-6,4	≈ 3,00	3100	2600
4,8	14,3	3,2-8,0	≈ 3,00	3100	2600
4,8	19,3	8,0-12,7	≈ 3,00	3100	2600

d x L		Art.number	d x L		Art.number	d x L		Art.number
3,2X11MM	500	33900.032.011	4,0X13MM	500	33900.040.013	4,8X14MM	500	33900.048.014
4,0X12,5MM	500	33900.040.012	4,8X12,7MM	500	33900.048.012	4,8X19MM	500	33900.048.019

Multigrip blind rivet domed head, Type B

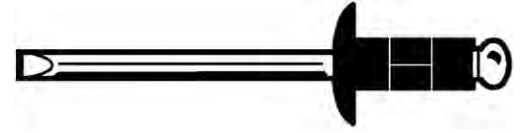
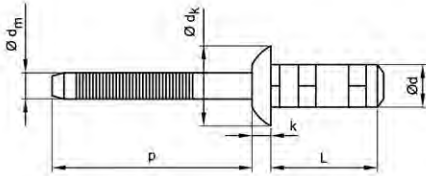

Technical Data

$\varnothing d$	Drill \varnothing	k (max.)	p	$\varnothing d_k$
3.2	3.3	1.02	>27	6.4
4.0	4.1	1.27	>27	7.9
4.8	4.9	1.52	>27	9.5

34185 Multigrip blind rivet domed head, Type B

T05A

Material Stainless steel A2



$\varnothing d$	l		$\varnothing d_m$		
(mm)	(mm)	(mm)	(mm)	(N)	(N)
3,2	9,9	1,0-4,8	≈ 2,20	2000	1700
4,0	12,0	1,6-6,4	≈ 2,70	3200	2900
4,0	13,6	3,2-8,0	≈ 2,70	3200	2900
4,0	16,8	6,4-11,2	≈ 2,70	3200	2900

$\varnothing d$	l		$\varnothing d_m$		
(mm)	(mm)	(mm)	(mm)	(N)	(N)
4,8	12,7	1,6-6,4	≈ 3,10	4800	4100
4,8	14,3	3,2-8,0	≈ 3,10	4800	4100
4,8	17,5	6,5-10,0	≈ 3,10	4800	4100
4,8	19,3	8,0-12,5	≈ 3,10	4800	4100

d x L	☒	Art.number	d x L	☒	Art.number	d x L	☒	Art.number
3,2X10MM	500	34185.032.010	4,0X16MM	500	34185.040.016	4,8X14MM	500	34185.048.014
4,0X12MM	500	34185.040.012	4,8X12,7MM	500	34185.048.012	4,8X17,5MM	500	34185.048.017
4,0X13MM	500	34185.040.013				4,8X19MM	500	34185.048.019

Domed head multigrip blind rivet

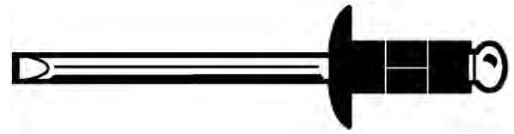
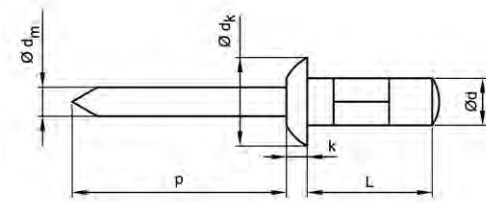

Technical Data

Ø d	Drill ø	k	p	Ø d _k
3.2	3.3	≤ 1.4	≥27	6.0
4.0	4.1	≤ 1.7	≥27	8.0
4.8	4.9	≤ 2.0	≥27	9.5

Article groups

Material		Code	Page
Al AlMg 2,5	Al-St zipl	34125	9-71
Al AlMg 5	Al-St.St. A2	34205	9-72

34125 MULTI Domed head multigrip blind rivet

T05A

Material Aluminium AlMg 2,5



Ø d	l		Ø d _m		
(mm)	(mm)	(mm)	(mm)	(N)	(N)
3,2	8,0	0,5-5,0	≈ 1,78	980	680
3,2	9,5	2,0-6,5	≈ 1,78	980	680
3,2	11,1	3,5-8,0	≈ 1,78	980	680
4,0	9,5	1,0-6,0	≈ 2,18	1600	1150
4,0	12,7	4,0-9,5	≈ 2,18	1600	1150

Ø d	l		Ø d _m		
(mm)	(mm)	(mm)	(mm)	(N)	(N)
4,0	17,0	8,5-13,5	≈ 2,18	1600	1150
4,8	10,3	0,5-5,5	≈ 2,78	2350	1500
4,8	15,1	5,0-10,5	≈ 2,78	2350	1500
4,8	17,0	7,0-12,0	≈ 2,78	2350	1500
4,8	24,8	14,5-19,5	≈ 2,78	2350	1500

d x L	☒	Art.number	d x L	☒	Art.number	d x L	☒	Art.number
3,2X8MM	500	34125.032.008	4,0X9,5MM	500	34125.040.009	4,8X10,3MM	500	34125.048.011
3,2X9,5MM	500	34125.032.009	4,0X12,7MM	500	34125.040.013	4,8X15,1MM	250	34125.048.015
3,2X11,1MM	500	34125.032.011	4,0X17MM	500	34125.040.017	4,8X17MM	500	34125.048.017
						4,8X24,8MM	500	34125.048.025

34205	Domed head multigrip blind rivet	T05A
Material	Aluminium AIMg 5	

$\varnothing d$	l		$\varnothing d_m$		
(mm)	(mm)	(mm)	(mm)	(N)	(N)
3,2	8,0	0,5-5,0	$\approx 1,78$	980	680
3,2	9,5	2,0-6,5	$\approx 1,78$	980	680
3,2	11,1	3,5-8,0	$\approx 1,78$	980	680
4,0	9,5	1,0-6,0	$\approx 2,18$	1600	1150
4,0	12,7	4,0-9,5	$\approx 2,18$	1600	1150

$\varnothing d$	l		$\varnothing d_m$		
(mm)	(mm)	(mm)	(mm)	(N)	(N)
4,0	17,0	8,5-13,5	$\approx 2,18$	1600	1150
4,8	10,3	0,5-5,5	$\approx 2,78$	2350	1500
4,8	15,1	5,0-10,5	$\approx 2,78$	2350	1500
4,8	17,0	7,0-12,0	$\approx 2,78$	2350	1500
4,8	24,8	14,5-19,5	$\approx 2,78$	2350	1500

$d \times L$	☒	Art.number	$d \times L$	☒	Art.number	$d \times L$	☒	Art.number
3,2X8,0MM	500	34205.032.008	4,0X9,5MM	500	34205.040.009	4,8X10,3MM	500	34205.048.010
3,2X9,5MM	500	34205.032.009	4,0X12,7MM	500	34205.040.012	4,8X15,1MM	500	34205.048.015
3,2X11,1MM	500	34205.032.011	4,0X16,9MM	500	34205.040.016	4,8X16,9MM	500	34205.048.016
						4,8X24,8MM	250	34205.048.024

MULTI blind rivet large domed head

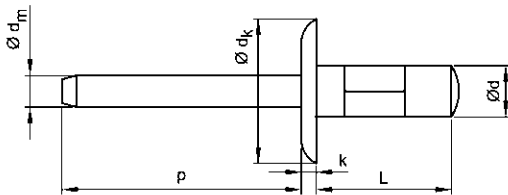

Technical Data

$\varnothing d$	Drill \varnothing	k (max.)	p	$\varnothing d_k$
4.8	4.9	2.5	>27	16.0

34250	MULTI blind rivet large domed head	T05A
Material	Aluminium AIMg 3	

$\varnothing d$	l		$\varnothing d_m$		
(mm)	(mm)	(mm)	(mm)	(N)	(N)
4,8	10,0	0,5-5,0	$\approx 2,78$	2350	1500
4,8	10,3	0,5-5,5	$\approx 2,78$	2350	1500
4,8	12,0	2,0-7,0	$\approx 2,78$	2350	1500
4,8	14,0	4,0-9,0	$\approx 2,78$	2350	1500
4,8	16,0	6,0-11,0	$\approx 2,78$	2350	1500
4,8	17,0	7,0-12,0	$\approx 2,78$	2350	1500

$\varnothing d$	l		$\varnothing d_m$		
(mm)	(mm)	(mm)	(mm)	(N)	(N)
4,8	18,0	8,0-13,0	$\approx 2,78$	2350	1500
4,8	20,0	10,0-15,0	$\approx 2,78$	2350	1500
4,8	22,0	12,0-17,0	$\approx 2,78$	2350	1500
4,8	24,0	14,0-19,0	$\approx 2,78$	2350	1500
4,8	24,8	14,5-19,5	$\approx 2,78$	2350	1500
4,8	27,0	16,0-22,0	$\approx 2,78$	2350	1500

$d \times L$	☒	Art.number	$d \times L$	☒	Art.number	$d \times L$	☒	Art.number
4,8X10X16MM	250	34250.048.010	4,8X16X16MM	250	34250.048.016	4,8X22X16MM	250	34250.048.022
4,8X10,3X16MM	250	34250.048.011	4,8X17X16MM	250	34250.048.017	4,8X24X16MM	250	34250.048.024
4,8X12X16MM	250	34250.048.012	4,8X18X16MM	250	34250.048.018	4,8X24,8X16MM	250	34250.048.025
4,8X14X16MM	250	34250.048.014	4,8X20X16MM	250	34250.048.020	4,8X27X16MM	250	34250.048.027

Multigrip blind rivet countersunk head

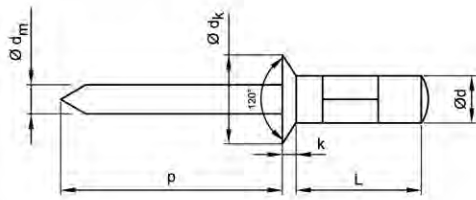

Technical Data

$\varnothing d$	Drill \varnothing	p	$\varnothing d_k$
3.2	3.3	>27	6.0
4.0	4.1	>27	8.0
4.8	4.9	>27	9.5

34128 Multigrip blind rivet countersunk head

T05A

Material Aluminium AlMg 5



$\varnothing d$	l		$\varnothing d_m$		
(mm)	(mm)	(mm)	(mm)	(N)	(N)
3,2	8,0	1,5-5,0	≈ 1,78	980	680
3,2	9,7	2,5-6,5	≈ 1,78	980	680
3,2	10,0	2,5-7,0	≈ 1,78	980	680
3,2	12,0	4,5-9,0	≈ 1,78	980	680
4,0	8,0	1,5-4,5	≈ 2,18	1600	1150
4,0	10,0	1,5-6,5	≈ 2,18	1600	1150
4,0	11,3	2,5-7,5	≈ 2,18	1600	1150

$\varnothing d$	l		$\varnothing d_m$		
(mm)	(mm)	(mm)	(mm)	(N)	(N)
4,0	12,0	3,5-8,5	≈ 2,18	1600	1150
4,0	14,0	5,5-10,5	≈ 2,18	1600	1150
4,8	10,0	1,5-5,0	≈ 2,78	2350	1500
4,8	12,0	2,0-7,0	≈ 2,78	2350	1500
4,8	14,0	4,0-9,0	≈ 2,78	2350	1500
4,8	16,0	6,0-11,0	≈ 2,78	2350	1500
4,8	16,9	7,0-12,0	≈ 2,78	2350	1500

d x L	☒	Art.number	d x L	☒	Art.number	d x L	☒	Art.number
3,2X8MM	500	34128.032.008	4,0X10MM	500	34128.040.010	4,8X12MM	500	34128.048.012
3,2X9,7MM	500	34128.032.009	4,0X11,3MM	500	34128.040.011	4,8X14MM	500	34128.048.014
3,2X10MM	500	34128.032.010	4,0X12MM	500	34128.040.012	4,8X16MM	500	34128.048.016
3,2X12MM	500	34128.032.012	4,0X14MM	500	34128.040.014	4,8X16,9MM	500	34128.048.017
4,0X8MM	500	34128.040.008	4,8X10MM	500	34128.048.010			

Sealed domed head blind rivet

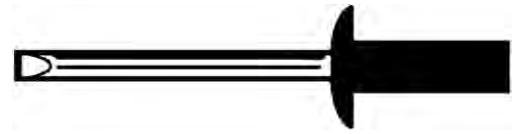
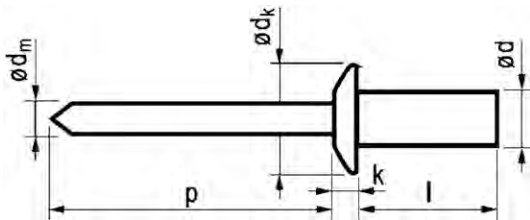

Technical Data

$\varnothing d$	Drill \varnothing	k	p	$\varnothing d_k$
3.2	3.3	≤ 1.4	≥ 27	6.0
4.0xk 1.4	4.1	1.4	≥ 27	8.0
4.0xk ≤ 1.7	4.1	≤ 1.7	≥ 27	8.0
4.8xk 1.7	4.9	1.7	≥ 27	9.5
4.8xk ≤ 2.0	4.9	≤ 2.0	≥ 27	9.5
6.4	6.5	≤ 2.5	≥ 27	12.7

Article groups

Material	Surface treatment	Code	Page	
Al AlMg 5		Al-St	33610	9-74
Al AlMg 5		Al-St.St. A2	33650	9-75
Al Al 99,5		Al-Al	33600	9-75
St	Zipl	St zipl-St zipl	33695	9-76
St.St. A2		St.St. A2-St.St. A2	33670	9-76

33610 SIGMA Sealed domed head blind rivet

T03A

Material Aluminium AlMg 5

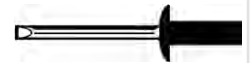

$\varnothing d$	l		$\varnothing d_m$		
(mm)	(mm)	(mm)	(mm)	(N)	(N)
3,2	6,5	0,5-2,0	$\approx 1,70$	1250	1070
3,2	8,0	2,0-3,5	$\approx 1,70$	1250	1070
3,2	9,5	3,5-5,0	$\approx 1,70$	1250	1070
3,2	10,7	5,0-6,5	$\approx 1,70$	1250	1070
3,2	12,7	6,5-8,0	$\approx 1,70$	1250	1070
4,0	8,0	0,5-3,5	$\approx 2,18$	2240	1700
4,0	9,5	3,5-4,5	$\approx 2,18$	2240	1700
4,0	11,0	4,5-6,0	$\approx 2,18$	2240	1700
4,0	12,7	6,0-7,5	$\approx 2,18$	2240	1700
4,8	8,0	1,0=3,0	$\approx 2,63$	3100	2200



$\varnothing d$	l		$\varnothing d_m$		
(mm)	(mm)	(mm)	(mm)	(N)	(N)
4,8	9,5	3,0-4,5	$\approx 2,63$	3100	2200
4,8	11,0	4,5-6,0	$\approx 2,63$	3100	2200
4,8	12,5	6,0-7,5	$\approx 2,63$	3100	2200
4,8	14,0	7,5-9,0	$\approx 2,63$	3100	2200
4,8	16,0	9,0-11,0	$\approx 2,63$	3100	2200
4,8	18,0	11,0-13,0	$\approx 2,63$	3100	2200
4,8	21,0	13,0-16,0	$\approx 2,63$	3100	2200
6,4	12,5	1,5-6,0	$\approx 3,70$	4900	3950
6,4	16,0	6,0-8,0	$\approx 3,70$	4900	3950

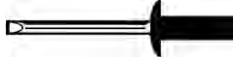

d x L	☒	Art.number	d x L	☒	Art.number	d x L	☒	Art.number
3,2X6,5MM	500	33610.032.006	4,0X11MM	500	33610.040.011	4,8X14MM	500	33610.048.014
3,2X8MM	500	33610.032.008	4,0X12,5MM	500	33610.040.012	4,8X16MM	500	33610.048.016
3,2X9,5MM	500	33610.032.009				4,8X18MM	500	33610.048.018
3,2X10MM	500	33610.032.010	4,8X8MM	500	33610.048.008	4,8X21MM	500	33610.048.021
3,2X12,5MM	500	33610.032.012	4,8X9,5MM	500	33610.048.009			
			4,8X11MM	500	33610.048.011	6,4X12,5MM	250	33610.064.012
4,0X8MM	500	33610.040.008	4,8X12MM	500	33610.048.012	6,4X16MM	250	33610.064.016
4,0X9,5MM	500	33610.040.009						

33650 SIGMA Sealed domed head blind rivet T03A

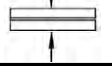
Material Aluminium AlMg 5

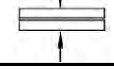

$\varnothing d$	l		$\varnothing d_m$		
(mm)	(mm)	(mm)	(mm)	(N)	(N)
3,2	6,5	0,5-2,0	≈ 1,70	1250	1070
3,2	8,0	2,0-3,5	≈ 1,70	1250	1070
3,2	9,5	3,5-5,0	≈ 1,70	1250	1070
3,2	11,0	5,0-6,5	≈ 1,70	1250	1070
3,2	12,7	6,5-8,0	≈ 1,70	1250	1070
4,0	8,0	0,5-3,5	≈ 2,18	2240	1700
4,0	9,5	3,5-4,5	≈ 2,18	2240	1700
4,0	11,0	4,5-6,5	≈ 2,18	2240	1700
4,0	12,7	6,5-8,0	≈ 2,18	2240	1700



$\varnothing d$	l		$\varnothing d_m$		
(mm)	(mm)	(mm)	(mm)	(N)	(N)
4,8	8,0	1,0-3,0	≈ 2,63	3100	2200
4,8	9,5	3,0-4,5	≈ 2,63	3100	2200
4,8	11,0	4,5-6,0	≈ 2,63	3100	2200
4,8	12,5	6,0-7,5	≈ 2,63	3100	2200
4,8	14,0	7,5-9,0	≈ 2,63	3100	2200
4,8	16,0	9,0-11,0	≈ 2,63	3100	2200
4,8	18,0	11,0-13,0	≈ 2,63	3100	2200
4,8	21,0	13,0-16,0	≈ 2,63	3100	2200



d x L	☒	Art.number	d x L	☒	Art.number	d x L	☒	Art.number
3,2X6,5MM	1000	33650.032.006	4,0X9,5MM	500	33650.040.009	4,8X11MM	500	33650.048.011
3,2X8MM	500	33650.032.008	4,0X11MM	500	33650.040.011	4,8X12,5MM	500	33650.048.012
3,2X9,5MM	500	33650.032.009	4,0X12,5MM	500	33650.040.012	4,8X14MM	250	33650.048.014
3,2X11MM	500	33650.032.011				4,8X16MM	500	33650.048.016
3,2X12,5MM	500	33650.032.012	4,8X8MM	500	33650.048.008	4,8X18MM	500	33650.048.018
4,0X8MM	500	33650.040.008	4,8X9,5MM	500	33650.048.009	4,8X21MM	500	33650.048.021

33600 SIGMA Sealed domed head blind rivet T03A

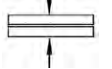
Material Aluminium Al 99,5

$\varnothing d$	l		$\varnothing d_m$		
(mm)	(mm)	(mm)	(mm)	(N)	(N)
3,2	8,0	0,5-3,5	≈ 1,80	460	450
3,2	9,5	3,5-5,5	≈ 1,80	460	450
4,0	9,5	0,5-5,0	≈ 2,20	820	580
4,0	12,5	5,0-8,0	≈ 2,20	820	580

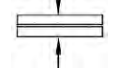
$\varnothing d$	l		$\varnothing d_m$		
(mm)	(mm)	(mm)	(mm)	(N)	(N)
4,8	9,5	1,0-4,5	≈ 2,65	1120	900
4,8	11,5	4,5-6,5	≈ 2,65	1120	900
4,8	14,5	6,5-9,5	≈ 2,65	1120	900
4,8	18,0	9,5-13,0	≈ 2,65	1120	900

d x L	☒	Art.number	d x L	☒	Art.number	d x L	☒	Art.number
3,2X8MM	500	33600.032.008	4,0X12,5MM	500	33600.040.012	4,8X11,5MM	500	33600.048.011
3,2X9,5MM	500	33600.032.009	4,8X9,5MM	500	33600.048.009	4,8X14,5MM	250	33600.048.014
4,0X9,5MM	500	33600.040.009				4,8X18MM	500	33600.048.018

33695 SIGMA Sealed domed head blind rivet
T03A
Material Steel
Surface treatment Zinc plated

$\varnothing d$	l		$\varnothing d_m$		
(mm)	(mm)	(mm)	(mm)	(N)	(N)
4,0	6,0	0,5-1,5	≈ 2,30	2500	2300
4,0	8,0	1,5-3,0	≈ 2,30	2500	2300
4,0	12,0	5,0-6,5	≈ 2,30	2500	2300
4,0	15,0	6,5-10,5	≈ 2,30	2500	2300

$\varnothing d$	l		$\varnothing d_m$		
(mm)	(mm)	(mm)	(mm)	(N)	(N)
4,8	8,0	1,0-3,0	≈ 2,90	3800	2900
4,8	12,0	5,0-6,5	≈ 2,90	3800	2900
4,8	16,0	6,5-10,5	≈ 2,90	3800	2900

d x L	☒	Art.number	d x L	☒	Art.number	d x L	☒	Art.number
4,0X6MM	500	33695.040.006	4,0X15MM	500	33695.040.015	4,8X12MM	500	33695.048.012
4,0X8MM	500	33695.040.008	4,8X8MM	500	33695.048.008	4,8X16MM	500	33695.048.016
4,0X12MM	500	33695.040.012						

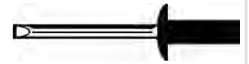
33670 SIGMA Sealed domed head blind rivet
T03A
Material Stainless steel A2

$\varnothing d$	l		$\varnothing d_m$		
(mm)	(mm)	(mm)	(mm)	(N)	(N)
3,2	6,0	0,5-1,5	≈ 1,90	2500	2000
3,2	8,0	1,5-3,0	≈ 1,90	2500	2000
3,2	9,5	3,0-5,0	≈ 1,90	2500	2000
3,2	12,0	5,0-7,0	≈ 1,90	2500	2000
4,0	6,0	0,5-1,5	≈ 2,30	4000	3000
4,0	8,0	1,5-3,0	≈ 2,30	4000	3000
4,0	9,5	3,0-5,0	≈ 2,30	4000	3000

$\varnothing d$	l		$\varnothing d_m$		
(mm)	(mm)	(mm)	(mm)	(N)	(N)
4,0	12,0	5,0-6,5	≈ 2,30	4000	3000
4,0	16,0	6,5-10,5	≈ 2,30	4000	3000
4,8	8,0	1,0-3,0	≈ 2,90	5500	4500
4,8	9,5	3,0-5,0	≈ 2,90	5500	4500
4,8	12,0	5,0-6,5	≈ 2,90	5500	4500
4,8	16,0	6,5-10,5	≈ 2,90	5500	4500

d x L	☒	Art.number	d x L	☒	Art.number	d x L	☒	Art.number
3,2X6MM	500	33670.032.006	4,0X6MM	500	33670.040.006	4,8X8MM	500	33670.048.008
3,2X8MM	500	33670.032.008	4,0X8MM	500	33670.040.008	4,8X9MM	500	33670.048.009
3,2X9MM	500	33670.032.009	4,0X9MM	500	33670.040.009	4,8X12MM	500	33670.048.012
3,2X12MM	500	33670.032.012	4,0X12MM	500	33670.040.012	4,8X16MM	500	33670.048.016
			4,0X16MM	500	33670.040.016			

Sealed countersunk head blind rivet

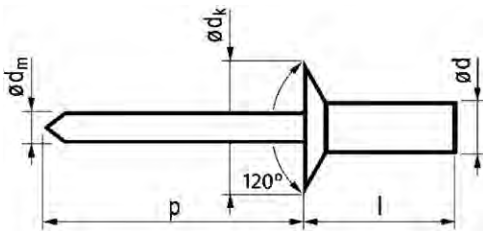

Technical Data

$\varnothing d$	Drill \varnothing	p	$\varnothing d_k$
3.2	3.3	≥ 27	6.0
4.0	4.1	≥ 27	7.5
4.8	4.9	≥ 27	9.0

33620 SIGMA Sealed countersunk head blind rivet

T03A

Material Aluminium AlMg 5

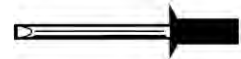

$\varnothing d$	l		$\varnothing d_m$		
(mm)	(mm)	(mm)	(mm)	(N)	(N)
3,2	7,5	1,5-3,5	$\approx 1,70$	1245	1070
3,2	9,0	3,0-5,0	$\approx 1,70$	1245	1070
3,2	10,5	4,5-6,5	$\approx 1,70$	1245	1070
3,2	12,0	6,0-7,5	$\approx 1,70$	1245	1070
4,0	9,5	3,0-5,0	$\approx 2,20$	2240	1710
4,0	11,0	4,5-6,5	$\approx 2,20$	2240	1710
4,0	12,5	6,0-8,0	$\approx 2,20$	2240	1710

$\varnothing d$	l		$\varnothing d_m$		
(mm)	(mm)	(mm)	(mm)	(N)	(N)
4,8	9,5	2,5-4,5	$\approx 2,65$	3070	2230
4,8	11,0	4,0-6,0	$\approx 2,65$	3070	2230
4,8	12,5	5,5-7,5	$\approx 2,65$	3070	2230
4,8	14,0	7,0-9,0	$\approx 2,65$	3070	2230
4,8	15,5	8,5-10,5	$\approx 2,65$	3070	2230
4,8	19,0	12,0-14,0	$\approx 2,65$	3070	2230

$d \times L$	☒	Art.number	$d \times L$	☒	Art.number	$d \times L$	☒	Art.number
3,2X7,5MM	500	33620.032.007	4,0X9,5MM	500	33620.040.009	4,8X11MM	500	33620.048.011
3,2X9,5MM	500	33620.032.009	4,0X11MM	500	33620.040.011	4,8X12,5MM	500	33620.048.012
3,2X10,5MM	500	33620.032.010	4,0X12,5MM	500	33620.040.012	4,8X14MM	500	33620.048.014
3,2X12MM	500	33620.032.012	4,8X9,5MM	250	33620.048.009	4,8X15,5MM	500	33620.048.015
						4,8X19,5MM	250	33620.048.019

Domed head expanding blind rivet

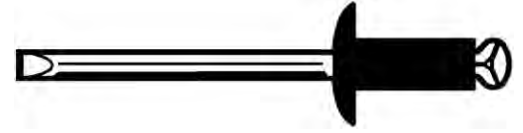
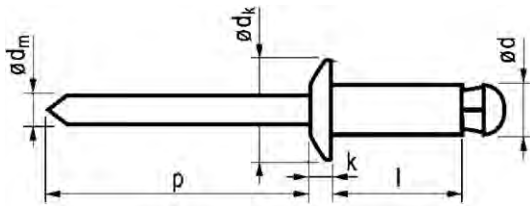

Technical Data

$\varnothing d$	Drill \varnothing	k	p	$\varnothing d_k$
3.2	3.7	1	≥ 27	6.5
4.0	4.5	1.2	≥ 27	8.0
4.8	5.3	1.4	≥ 27	9.0

33410 EXPO Domed head expanding blind rivet

T03A

Material Aluminium AlMg 3,5

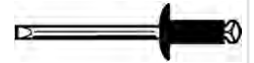

$\varnothing d$	l		$\varnothing d_m$		
(mm)	(mm)	(mm)	(mm)	(N)	(N)
3,2	10,0	1,0-3,0	$\approx 1,80$	750	820
3,2	16,0	7,0-9,0	$\approx 1,80$	750	820
3,2	18,0	9,0-11,0	$\approx 1,80$	750	820
4,0	10,0	1,5-5,0	$\approx 2,10$	1140	1280
4,0	16,0	8,0-11,0	$\approx 2,10$	1140	1280
4,0	18,0	10,0-13,0	$\approx 2,10$	1140	1280
4,8	10,0	1,5-4,0	$\approx 2,70$	2450	2100

$\varnothing d$	l		$\varnothing d_m$		
(mm)	(mm)	(mm)	(mm)	(N)	(N)
4,8	14,0	4,0-8,0	$\approx 2,70$	2450	2100
4,8	18,0	8,0-12,0	$\approx 2,70$	2450	2100
4,8	22,0	12,0-16,0	$\approx 2,70$	2450	2100
4,8	25,0	16,0-19,0	$\approx 2,70$	2450	2100
4,8	30,0	19,0-24,0	$\approx 2,70$	2450	2100
4,8	35,0	24,0-29,0	$\approx 2,70$	2450	2100

d x L	☒	Art.number	d x L	☒	Art.number	d x L	☒	Art.number
3,2X10MM	500	33410.032.010	4,0X16MM	500	33410.040.016	4,8X18MM	500	33410.048.018
3,2X16MM	500	33410.032.016	4,0X18MM	500	33410.040.018	4,8X22MM	500	33410.048.022
3,2X18MM	500	33410.032.018	4,8X10MM	500	33410.048.010	4,8X25MM	250	33410.048.025
4,0X10MM	500	33410.040.010	4,8X14MM	500	33410.048.014	4,8X30MM	250	33410.048.030
						4,8X35MM	250	33410.048.035

Domed head expanding blind rivet

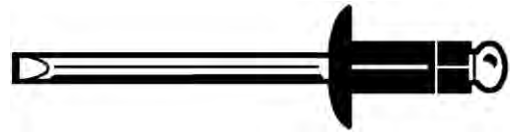
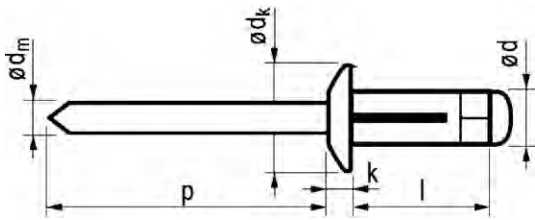

Technical Data

$\varnothing d$	Drill \varnothing	k	p	$\varnothing d_k$
4.0	4.2	≤ 1.7	≥ 27	8.0
4.8	5.0	≤ 2.0	≥ 27	9.6

34121 TRIPO Domed head expanding blind rivet

T05A

Material Aluminium AlMg 3



$\varnothing d$	l		$\varnothing d_m$		
(mm)	(mm)	(mm)	(mm)	(N)	(N)
4,0	13,6	1,0-3,0	$\approx 2,50$	800	500
4,0	18,8	3,0-7,0	$\approx 2,50$	800	500
4,8	15,3	1,0-3,0	$\approx 2,90$	1100	800

$\varnothing d$	l		$\varnothing d_m$		
(mm)	(mm)	(mm)	(mm)	(N)	(N)
4,8	20,5	3,0-9,0	$\approx 2,90$	1100	800
4,8	24,5	5,0-12,0	$\approx 2,90$	1100	800

d x L	☒	Art.number	d x L	☒	Art.number	d x L	☒	Art.number
4,0X13MM	500	34121.040.013	4,8X15MM	500	34121.048.015	4,8X20MM	250	34121.048.020
4,0X18MM	500	34121.040.018				4,8X24MM	250	34121.048.024

Blind rivet tool



	ø 2,4			ø 3,0 - 3,2			ø 4,0			ø 4,8 - 5,0			ø 6,0 - 6,4		
	Al	St	St.st.	Al	St	St.st.	Al	St	St.st.	Al	St	St.st.	Al	St	St.st.
F 80															
F 150															
F 260															
FEZ1000															
FEZ2000															

additional option
 recommended capacity

Article groups

Code	Page
35145	9-80
35760	9-80

35145 Blind rivet hand plier T90A

Type	Art.number	
F80	1 35145.080.001	<ul style="list-style-type: none"> Professional blind riveting tool. Possibility to use by only one hand. Capacity: ø3,0 - 6,4 mm. Weight: 2,2 kg. Length: 310 mm (closed) - 830 mm (open). Body material: aluminium. Lever material: steel Equipment: nose pieces ø3,0 - 6,4 mm.
F150 B	1 35145.150.001	<ul style="list-style-type: none"> Professional blind riveting tool for small and light assembly work. Equipped with an opening spring. Capacity: ø2,4 - 5,0 mm. Weight: 0,7 kg. Dimensions: 255 mm. Body: Aluminium. Lever: Steel. Equipment: nose pieces ø3,0 - 5,0 mm.
F260	1 35145.260.001	<ul style="list-style-type: none"> Heavy duty long arm riveter with adjustable front sleeve, allowing the breaking point to be set in the most ideal position. Capacity: ø3,0 - 6,4 mm. Weight: 1,8 kg. Dimensions: 500 mm. Body: Plastic with steel parts. Lever: Steel. Equipment: nose pieces ø3,0 - 6,4 mm.

35760 Blind rivet tool pneumatic T91A

Type	Art.number	
FEZ 1000	1 35760.100.001	<ul style="list-style-type: none"> New generation hydraulic/pneumatic blind riveting tool with extraction, mandrel collector and suspension bracket. Capacity: ø3,0 - 5,0 mm. Weight: 1,25 kg. Dimensions: 264 x 272 x 102mm. Stroke: 17,0 mm. Pressure required: 5-7 Bar. Traction power (6 Bar): 7,3 kN. Equipment: Nose pieces ø3,0 - 5,0 mm.

9

35760 Blind rivet tool pneumatic		←
Type	☒	Art.number
FEZ 2000	1	35760.200.001 <ul style="list-style-type: none"> • New generation hydraulic/pneumatic blind riveting tool with extraction, mandrel collector and suspension bracket. • Capacity: \varnothing4,0 - 6,4 mm. • Weight: 1,65 kg. • Dimensions: 275 x 272 x 125 mm. • Stroke: 21,0 mm. • Pressure required: 5-7 Bar. • Traction power (6 Bar): 12,5 kN. • Equipment: Nose pieces \varnothing4,0 - 6,4 mm.



Blind rivet set



35146 Blind rivet set		T90A



Size	☒	Art.number
F150BS	1	35146.150.001 <ul style="list-style-type: none"> • Set in aluminium case. • F150 Blind rivet tool with 8 sizes of rivets from \varnothing 3,2 mm to \varnothing 4,8 mm for small and light assembly work.



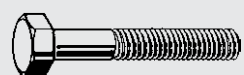

1 Bolts



2 Hexagon socket products



3 Nuts, rivet nuts & inserts



4 Threaded rods & studbolts



5 Hook & eye products



6 Screws

I Index



7 Washers & O-rings



8 Anchoring products

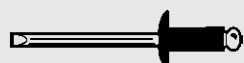

9 Rivets, pins & keys



10 Systems, furniture & security fasteners



11 Assortments & storage systems

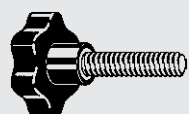

12 Engineering parts & machine parts

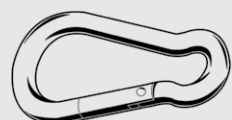











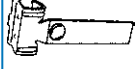

13 Maritime products

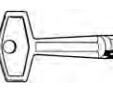
T Fastening technology

Systems, furniture & security fasteners **10**



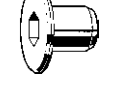





 Page 10-4 DIN 787 For T-slots Metric	 Page 10-5 DIN 508 For T-slots Metric	 Page 10-6 DIN 6330 B Single sphere Metric	 Page 10-7 DIN 6331 With collar Metric	 Page 10-8 3xd Metric
 Page 10-9 DIN 6319 Spherical washer	 Page 10-10 DIN 6340 Washers for T-slots	 Page 10-11 DIN 6379 For T-slots Metric	 Page 10-12 Assortment for T-slots	 Page 10-16 LINDAPTER Hollo-bolt hexagon
 Page 10-17 LINDAPTER Hollo-bolt countersunk	 Page 10-18 LINDAPTER Hollo-bolt Flush Fit	 Page 10-19 LINDAPTER Hollo-bolt Flush Fit tool	 Page 10-20 LINDAPTER Clamp system	 Page 10-23 LINDAPTER Type AAF
 Page 10-23 LINDAPTER Packings	 Page 10-27 LINDAPTER Type W	 Page 10-27 LINDAPTER Type CF	 Page 10-28 LINDAPTER Type LR	 Page 10-29 LINDAPTER Type D2
 Page 10-30 LINDAPTER Type BR	 Page 10-31 LINDAPTER Flange clamp	 Page 10-32 LINDAPTER Flush clamp	 Page 10-33 LINDAPTER Floorfast	 Page 10-34 LINDAPTER GF3030
 Page 10-35 FISCHER Saddle	 Page 10-36 Hinged pipe clamp	 Page 10-37 Pipe clamp	 Page 10-38 Refrigeration pipe clamp	 Page 10-39 Channel
 Page 10-40 Cantilever arm	 Page 10-41 Cover cap	 Page 10-41 T-head bolt clix	 Page 10-42 Sliding nut	 Page 10-43 Channel washer
 Page 10-43 T-head bolt	 Page 10-44 Installation angle bracket	 Page 10-45 Angle bracket	 Page 10-46 Saddle flange	 Page 10-47 Beam clamp
 Page 10-48 Channel connector	 Page 10-49 Parallel connector	 Page 10-50 Clamp hanger	 Page 10-51 Perforated steel banding	 Page 10-52 Double connector plate
 Page 10-53 Bolt connector	 Page 10-55 Beam clamp type H	 Page 10-55 Beam clamp type 50H	 Page 10-56 Beam clip type BC	 Page 10-56 Beam clip type BCC

Systems, furniture & security fasteners **10**

 Page 10-57 Beam clip type RH	 Page 10-58 Push fastener type PF	 Page 10-58 Snap-on clip	 Page 10-59 Master clamp type MC	 Page 10-59 Cable run clip
 Page 10-61 Toggle latch	 Page 10-63 Strike for toggle latches	 Page 10-66 Locking	 Page 10-68 Pawl	 Page 10-71 Key
 Page 10-72 Bare guide	 Page 10-73 Bare guide	 Page 10-75 Stud with slotted head	 Page 10-75 Stud with wing head	 Page 10-76 Stud with knurled slotted knob
 Page 10-76 Ball stud	 Page 10-77 Retaining washer	 Page 10-78 Grommet	 Page 10-79 Protecting washer	 Page 10-79 Sealing ring
 Page 10-80 Conical retaining spring	 Page 10-80 Rivet spring	 Page 10-81 Welding spring plate	 Page 10-82 Slip-on spring receptacle	 Page 10-82 Spring bracket
 Page 10-83 Front load receptacle	 Page 10-85 Three part clips	 Page 10-85 Protection cups	 Page 10-86 Type C brass	 Page 10-86 Type D brass
 Page 10-87 Type E brass	 Page 10-88 Type 530 brass	 Page 10-88 For wood	 Page 10-89 Type SK/SKD	 Page 10-90 DIN 7965 Type A
 Page 10-91 Type SKDZ	 Page 10-91 Type TS	 Page 10-92 Type RM	 Page 10-92 Type RSK	 Page 10-93 Type RF
 Page 10-94 Type RT	 Page 10-95 Type KF	 Page 10-95 Type KT	 Page 10-96 Type KOK	 Page 10-96 Type Q
 Page 10-97 Open	 Page 10-98 Closed	 Page 10-98 For countersunk head screw	 Page 10-99 Turned	 Page 10-100 Sleeve nut

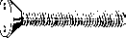
10

Systems, furniture & security fasteners 10

 Page 10-101 Booknut	 Page 10-102 Bookscrew	 Page 10-103 Bookscrew	 Page 10-103 Elongation piece	 Page 10-104 Binderscrew
 Page 10-104 Tube cap	 Page 10-105 Tube cap	 Page 10-105 Tube cap	 Page 10-106 Tube cap conical	 Page 10-108 SECURITY Nut
 Page 10-109 SECURITY inviolable nut	 Page 10-110 SECURITY socket head with pin	 Page 10-111 SECURITY hexagon with plug	 Page 10-112 SECURITY hexalobular with pin	 Page 10-113 SECURITY with 2 holes
 Page 10-113 SECURITY One-way	 Page 10-114 SECURITY hexagon with pin	 Page 10-115 SECURITY hexagon with plug	 Page 10-115 SECURITY hexalobular with pin	 Page 10-116 SECURITY with 2 holes
 Page 10-117 SECURITY hexagon with pin	 Page 10-118 SECURITY hexalobular with pin	 Page 10-119 SECURITY cross recessed with pin	 Page 10-119 SECURITY tapping screw with 2 holes	 Page 10-120 SECURITY tapping screw with 2 holes
 Page 10-121 SECURITY One-way	 Page 10-122 SECURITY with Tri-wing	 Page 10-122 SECURITY hexagon with pin	 Page 10-123 SECURITY hexalobular with pin	 Page 10-124 SECURITY cross recessed with pin
 Page 10-124 SECURITY tapping screw with 2 holes	 Page 10-125 SECURITY tapping screw with 2 holes	 Page 10-126 SECURITY One-way	 Page 10-126 SECURITY with square socket drive	 Page 10-127 SECURITY drive-in plug hexagon socket
 Page 10-128 SECURITY drive-in plug hexalobular drive	 Page 10-128 Welding studs			

Bolt and screw for T-slots

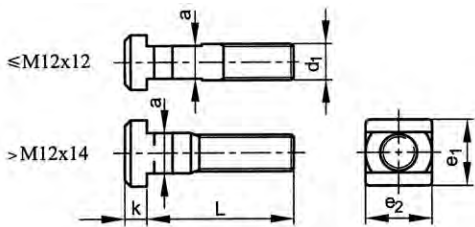

DIN 787
 ISO 299
 NF E21-301
 BS 2485

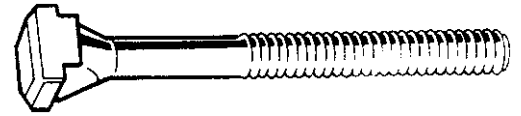

Technical Data

d ₁ x a	e (e ₂ ≥ e ₁)	k	P	d ₁ x a	e (e ₂ ≥ e ₁)	k	P
M8x8	13	6	1.25	M16x18	28	10	2
M10x10	15	6	1.5	M20x20 (#DIN)	32	12	2.5
M12x12	18	7	1.75	M20x22	35	14	2.5
M12x14	22	8	1.75	M24x24 (#DIN)	40	16	3
M16x16 (#DIN)	25	9	2	M24x28	44	18	3

• For sizes of T-slots, see DIN 650.

16202	Bolt and screw for T-slots	F95A
Thread	Metric thread	
Material	Steel	
Class	10.9/8.8	
		

d ₁ x a x L	☒	Art.number	d ₁ x a x L	☒	Art.number	d ₁ x a x L	☒	Art.number
M8X8X32	25	16202.088.032	M12X14X80	25	16202.134.080	M20X20X125	5	16202.220.125
M8X8X50	25	16202.088.050	M12X14X125	25	16202.134.125	M20X20X160	5	16202.220.160
M8X8X80	25	16202.088.080				M20X20X200	5	16202.220.200
			M16X16X63	10	16202.176.063			
M10X10X40	25	16202.110.040	M16X16X80	10	16202.176.080	M20X22X80	5	16202.222.080
M10X10X63	25	16202.110.063	M16X16X100	10	16202.176.100	M20X22X125	5	16202.222.125
M10X10X100	25	16202.110.100	M16X16X125	10	16202.176.125	M20X22X200	5	16202.222.200
			M16X16X160	10	16202.176.160			
M12X12X50	25	16202.132.050				M24X24X100	5	16202.264.100
M12X12X63	25	16202.132.063	M16X18X63	10	16202.178.063	M24X24X160	5	16202.264.160
M12X12X80	25	16202.132.080	M16X18X100	10	16202.178.100	M24X24X250	5	16202.264.250
M12X12X100	25	16202.132.100	M16X18X160	10	16202.178.160			
M12X12X125	25	16202.132.125				M24X28X100	5	16202.268.100
						M24X28X160	5	16202.268.160
M12X14X50	25	16202.134.050	M20X20X80	5	16202.220.080	M24X28X250	5	16202.268.250
M12X14X63	25	16202.134.063	M20X20X100	5	16202.220.100			

• Bolts for T-slots up to and including size M12 class 10.9, above size M12 class 8.8.

Nut for T-slot

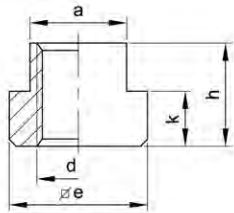

DIN 508
ISO 299
NF E21-301
BS 2485

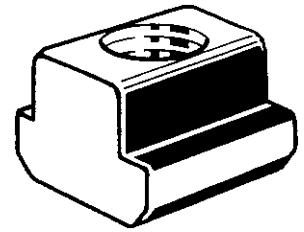

Technical Data

d x a	e	h	k	P	d x a	e	h	k	P
M5x6	10	8	4	0.8	M12x18 (≠DIN)	28	20	10	1.75
M6x8	13	10	6	1	M14x16 (≠DIN)	25	18	9	2
M8x10	15	12	6	1.25	M14x18 (≠DIN)	28	20	10	2
M8x12 (≠DIN)	18	14	7	1.25	M16x18	28	20	10	2
M10x12	18	14	7	1.5	M16x22 (≠DIN)	35	28	14	2
M10x14 (≠DIN)	22	16	8	1.5	M20x22	35	28	14	2.5
M12x14	22	16	8	1.75	M24x28	44	36	18	3
M12x16 (≠DIN)	25	18	9	1.75					

- For sizes of T-slots, see DIN 650.

16196 Nut for T-slot		F95A
Thread	Metric thread	 
Material	Steel	
Class	[10]	

d x a	☒	Art.number	d x a	☒	Art.number	d x a	☒	Art.number
M5X6	50	16196.050.006	M10X14	50	16196.100.014	M14X18	25	16196.140.018
M6X8	50	16196.060.008	M12X14	50	16196.120.014	M16X18	25	16196.160.018
M8X10	50	16196.080.010	M12X16	25	16196.120.016	M16X22	25	16196.160.022
M8X12	50	16196.080.012	M12X18	25	16196.120.018	M20X22	10	16196.200.022
M10X12	50	16196.100.012	M14X16	25	16196.140.016	M24X28	10	16196.240.028

Hexagon nut

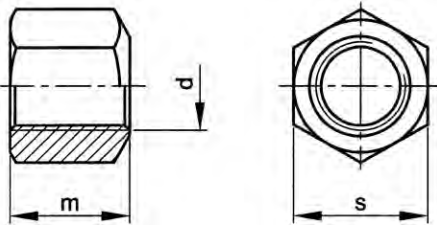

DIN 6330 B
NEN 2307

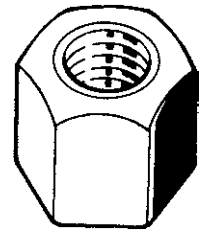

Technical Data

d	m (js15)	P	s	d	m (js15)	P	s
M6	9	1	10	M16	24	2	24
M8	12	1.25	13	M20	30	2.5	30
M10 (#DIN)	15	1.5	17	M24	36	3	36
M10	15	1.5	16	M27	39	3	41
M12 (#DIN)	18	1.75	19	M30	45	3.5	46
M12	18	1.75	18	M33	48	3.5	50
M14 (#DIN)	21	2	22	M36	54	4	55

Examples of application

Washer for clamping
acc. to DIN 6340

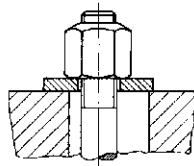

Conical seat acc.
to DIN 6319D

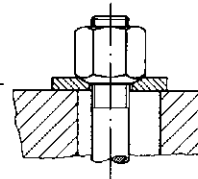

Article groups

Thread	Driving features	Material	Class	Code	Page
M	Hexagon	St	10	16203	10-6
M	Hexagon	St.St. A1	70	51102	10-6
M	Hexagon	St.St. A4	70	55102	10-7

16203 Hexagon nut		F95A	
Thread	Metric thread		
Material	Steel		
Class	10		



d	☒	Art.number	d	☒	Art.number	d	☒	Art.number
M8	50	16203.080.001	M12 s=19	50	16203.120.190	M20	10	16203.200.001
M10 s=16	50	16203.100.001	M14	25	16203.140.001	M24	10	16203.240.001
M10 s=17	50	16203.100.170	M16	25	16203.160.001	M30	5	16203.300.001
M12 s=18	50	16203.120.001						

51102 Hexagon nut		R09A	
Thread	Metric thread		
Material	Stainless steel A1		
Class	70		





d	☒	Art.number	d	☒	Art.number	d	☒	Art.number
M6*	50	51102.060.001	M14*	25	51102.140.001	M27*	10	51102.270.001
M8	50	51102.080.001	M16	25	51102.160.001	M30*	10	51102.300.001
M10	50	51102.100.001	M20	10	51102.200.001	M33*	10	51102.330.001
M12	50	51102.120.001	M24	10	51102.240.001			

55102	Hexagon nut	R49A
Thread	Metric thread	
Material	Stainless steel A4	
Class	70	

d	☒	Art.number	d	☒	Art.number	d	☒	Art.number
M6*	50	55102.060.001	M14*	25	55102.140.001	M27*	10	55102.270.001
M8	50	55102.080.001	M16	25	55102.160.001	M30*	10	55102.300.001
M10	50	55102.100.001	M20	10	55102.200.001	M36*	10	55102.360.001
M12	50	55102.120.001	M24	10	55102.240.001			

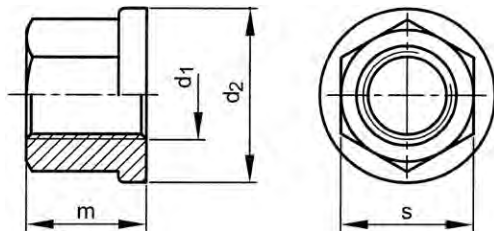
Hexagon nut with collar



DIN 6331

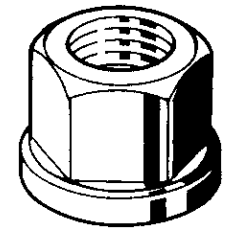

Technical Data

d ₁	d ₂ (h13)	m (js15)	P	s	d ₁	d ₂ (h13)	m (js15)	P	s
M6	14	9	1	10	M16	31	24	2	24
M8	18	12	1.25	13	M20	37	30	2.5	30
M10	22	15	1.5	16/17	M24	45	36	3	36
M12	25	18	1.75	18	M30	58	45	3.5	46
M14	28	21	2	22					

Article groups

Thread	Driving features	Material	Class	Code	Page
M	Hexagon	St	10	16204	10-7
M	Hexagon	St.St. A1	70	51104	10-7
M	Hexagon	St.St. A4	70	55104	10-8

16204	Hexagon nut with collar	F95A
Thread	Metric thread	
Material	Steel	
Class	10	

d ₁	☒	Art.number	d ₁	☒	Art.number	d ₁	☒	Art.number
M6	50	16204.060.001	M12	50	16204.120.001	M20	10	16204.200.001
M8	50	16204.080.001	M14	50	16204.140.001	M24	10	16204.240.001
M10 s=16	50	16204.100.001	M16	25	16204.160.001	M30	10	16204.300.001

51104	Hexagon nut with collar	R09A
Thread	Metric thread	
Material	Stainless steel A1	
Class	70	
DIN ≈6331		

d ₁	☒	Art.number	d ₁	☒	Art.number	d ₁	☒	Art.number
M6*	50	51104.060.001	M12	25	51104.120.001	M20	5	51104.200.001
M8	25	51104.080.001	M14*	25	51104.140.001	M24	5	51104.240.001
M10 s=17	25	51104.100.001	M16	10	51104.160.001			

55104 Hexagon nut with collar R49A

Thread: Metric thread
 Material: Stainless steel A4
 Class: 70

DIN ≈6331

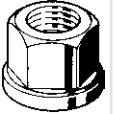
d ₁	☒	Art.number	d ₁	☒	Art.number	d ₁	☒	Art.number
M6*	50	55104.060.001	M12	25	55104.120.001	M20	5	55104.200.001
M8	25	55104.080.001	M14*	25	55104.140.001	M24	5	55104.240.001
M10 s=17	25	55104.100.001	M16	10	55104.160.001			

Extension nut 3xd

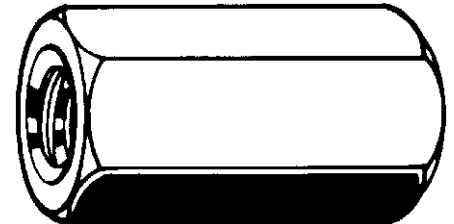
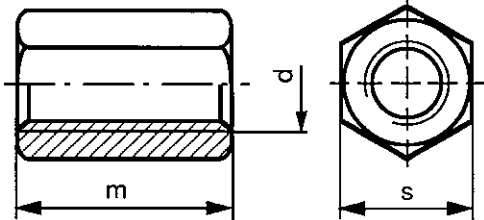

Technical Data

d	m	P	s	d	m	P	s
M8	24	1.25	13	M20	60	2.5	30
M10	30	1.5	17	M24	72	3	36
M12	36	1.75	19	M27	81	3	41
M14	42	2	22	M30	90	3.5	46
M16	48	2	24	M36	108	4	55

16225 Extension nut 3xd F95A

Thread: Metric thread
 Material: Steel
 Class: |10|

d	☒	Art.number	d	☒	Art.number	d	☒	Art.number
M8	25	16225.080.001	M16	10	16225.160.001	M27	5	16225.270.001
M10	25	16225.100.001	M20	5	16225.200.001	M30	5	16225.300.001
M12	25	16225.120.001	M24	5	16225.240.001	M36	5	16225.360.001

Spherical- and conical washer

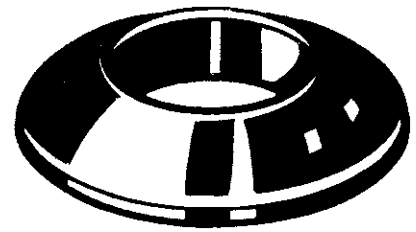
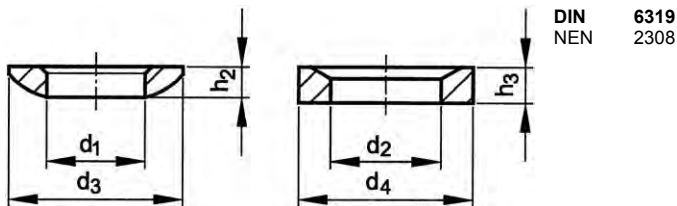

Technical Data

For nom.size	d ₁ (H13)	d ₂ (H13)	d ₃	d ₄	h ₂	h ₃	h ₄ ≈	S
M6	6.4	7.1	12	12	2.3	2.8	4.2	9
M8	8.4	9.6	17	17	3.2	3.5	5.6	17
M10	10.5	12	21	21	4	4.2	6.5	26
M12	13	14.2	24	24	4.6	5	8	38
M14	15	16.5	28	28	5	5.6	8.5	53
M16	17	19	30	30	5.3	6.2	9.6	73
M20	21	23.2	36	36	6.3	7.5	11.7	117
M24	25	28	44	44	8.2	9.5	15.2	168
M30	31	35	56	56	11.2	12	19.2	269
M36	37	42	69	69	14	15	23.5	394

- S = Static load in kN (max.).
- The combination of a spherical washer type C with a conical seat type D enables a swing of $\approx 3^\circ$ in any direction to be attained, when positioning a bolt through.
- ATTENTION: when these washers are applied in combination with fasteners class 10.9 or 10, the allowable clamping load will be at maximum 46% of R_p ; for class 8.8 or 8 at maximum 66% of R_p .
- These washers cannot be applied on slotted holes.

Assembly sequence

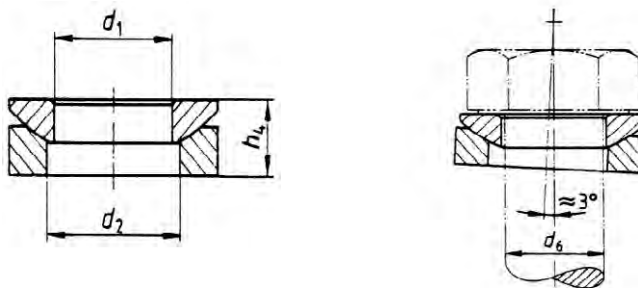

Article groups

Material	Type	Code	Page
St 550+100 HV10	Type C	16206	10-9
St.St. A2	Type C	51936	10-10
St 550+100 HV10	Type D	16207	10-10
St.St. A2	Type D	51935	10-10



16206 Spherical washer type C



F95A



Material Steel 550+100 HV10
DIN 6319 C
NEN 2308 C

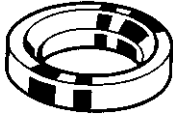

For nom. size	☒	Art.number	For nom. size	☒	Art.number	For nom. size	☒	Art.number
M6	100	16206.060.001	M14	50	16206.140.001	M24	25	16206.240.001
M8	100	16206.080.001	M16	50	16206.160.001	M30	25	16206.300.001
M10	100	16206.100.001	M20	25	16206.200.001	M36	25	16206.360.001
M12	100	16206.120.001						

51936 Spherical washer type C				F95A				
Material		Stainless steel A2	DIN		6319 C			
			NEN		2308 C			
								
For nom. size	<input checked="" type="checkbox"/>	Art.number	For nom. size	<input checked="" type="checkbox"/>	Art.number	For nom. size	<input checked="" type="checkbox"/>	Art.number
M8	50	51936.080.001	M12	25	51936.120.001	M20	25	51936.200.001
M10	50	51936.100.001	M16	100	51936.160.001			

16207 Conical washer type D				F95A				
Material		Steel 550+100 HV10	DIN		6319 D			
			NEN		2308 D			
								
For nom. size	<input checked="" type="checkbox"/>	Art.number	For nom. size	<input checked="" type="checkbox"/>	Art.number	For nom. size	<input checked="" type="checkbox"/>	Art.number
M6	100	16207.060.001	M14	50	16207.140.001	M24	25	16207.240.001
M8	100	16207.080.001	M16	50	16207.160.001	M30	25	16207.300.001
M10	100	16207.100.001	M20	25	16207.200.001	M36	25	16207.360.001
M12	100	16207.120.001						

51935 Conical washer type D				F95A				
Material		Stainless steel A2	DIN		6319 D			
			NEN		2308 D			
								
For nom. size	<input checked="" type="checkbox"/>	Art.number	For nom. size	<input checked="" type="checkbox"/>	Art.number	For nom. size	<input checked="" type="checkbox"/>	Art.number
M8	50	51935.080.001	M12	25	51935.120.001	M20	25	51935.200.001
M10	50	51935.100.001	M16	25	51935.160.001			

Washer for clamping device

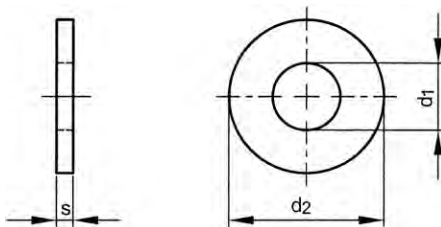

DIN 6340
NF E25-518

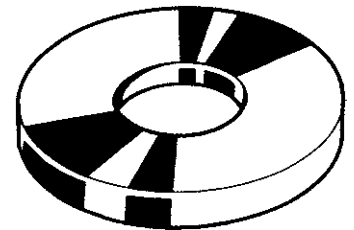

Technical Data

For nom.size	d ₁ (H14)	d ₂ (h14)	s	For nom.size	d ₁ (H14)	d ₂ (h14)	s
M6	6.4	17	3	M14 (#DIN)	15	40	5
M8	8.4	23	4	M16	17	45	6
M10	10.5	28	4	M20	21	50	6
M12	13	35	5	M24	25	60	8

Article groups

Material	Surface treatment	Code	Page
St 350+80 HV30		16205	10-11
St 350+80 HV30	Zipl	16229	10-11

16205 Washer for clamping device				F95A				
Material		Steel 350+80 HV30						
For nom. size	☒	Art.number	For nom. size	☒	Art.number	For nom. size	☒	Art.number
M6	50	16205.060.001	M12	50	16205.120.001	M20	10	16205.200.001
M8	50	16205.080.001	M14	50	16205.140.001	M24	10	16205.240.001
M10	50	16205.100.001	M16	25	16205.160.001			

16229 Washer for clamping device				F95A				
Material		Steel 350+80 HV30						
Surface treatment		Zinc plated						
For nom. size	☒	Art.number	For nom. size	☒	Art.number	For nom. size	☒	Art.number
M6	100	16229.060.001	M10	100	16229.100.001	M16	100	16229.160.001
M8	100	16229.080.001	M12	100	16229.120.001	M20	100	16229.200.001

Stud for T-slot nuts

DIN 6379

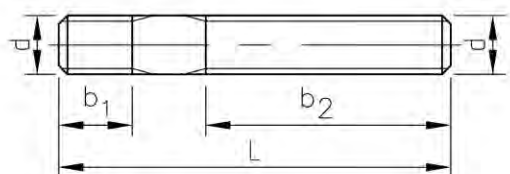

Technical Data

d	b ₁	P	d	b ₁	P
M8	11	1.25	M16	19	2
M10	13	1.5	M20	27	2.5
M12	15	1.75	M24	35	3
M14 (≠DIN)	17	2			

- Studs up to and including size M12 class 10.9, above size M12 class 8.8.

16226 Stud for T-slot nuts				F95A				
Thread		Metric thread						
Material		Steel						
Class		10.9/8.8						
d x L (b ₂)	☒	Art.number	d x L (b ₂)	☒	Art.number	d x L (b ₂)	☒	Art.number
M8X40 (20)	25	16226.080.040	M12X125 (75)	25	16226.120.125	M20X200 (125)	5	16226.200.200
M8X63 (40)	25	16226.080.063	M12X160 (100)	25	16226.120.160	M20X250 (160)	5	16226.200.250
M8X100 (63)	25	16226.080.100	M12X200 (125)	10	16226.120.200	M20X315 (200)	3	16226.200.315
M8X160 (100)	25	16226.080.160				M20X400 (250)	3	16226.200.400
			M16X63 (32)	10	16226.160.063	M20X500 (315)	3	16226.200.500
M10X50 (25)	25	16226.100.050	M16X80 (50)	10	16226.160.080			
M10X80 (50)	25	16226.100.080	M16X100 (63)	10	16226.160.100	M24X100 (45)	10	16226.240.100
M10X100 (75)	25	16226.100.100	M16X125 (75)	10	16226.160.125	M24X125 (70)	10	16226.240.125
M10X125 (75)	25	16226.100.125	M16X160 (100)	10	16226.160.160	M24X160 (100)	10	16226.240.160
M10X160 (100)	25	16226.100.160	M16X200 (125)	5	16226.160.200	M24X200 (125)	5	16226.240.200
M10X200 (125)	10	16226.100.200	M16X250 (160)	5	16226.160.250	M24X250 (160)	5	16226.240.250
			M16X315 (180)	5	16226.160.315	M24X315 (200)	5	16226.240.315
M12X50 (25)	25	16226.120.050				M24X400 (250)	3	16226.240.400
M12X63 (32)	25	16226.120.063	M20X80 (32)	10	16226.200.080	M24X500 (315)	3	16226.240.500
M12X80 (50)	25	16226.120.080	M20X125 (70)	10	16226.200.125	M24X630 (315)	3	16226.240.630
M12X100 (63)	25	16226.120.100	M20X160 (100)	10	16226.200.160			

T-Bolt sets for T-Slots



Article groups

Material	Code	Page
St	16227	10-12
St	16228	10-13

16227 T-Bolt sets for T-Slots No. 6520		F95A
Material	Steel	



No.	Art.number	
M10X10	1 16227.100.010	<p>Packed in wooden case</p> <p>Content:</p> <ul style="list-style-type: none"> • 2 pieces bolts and screws for T-slots acc. to DIN 787 length 40 mm • 4 pieces bolts and screws for T-slots acc. to DIN 787 length 63 mm • 4 pieces bolts and screws for T-slots acc. to DIN 787 length 100 mm • 4 pieces studs for T-slots acc. to DIN 6379 length 50 mm • 4 pieces studs for T-slots acc. to DIN 6379 length 80 mm • 4 pieces studs for T-slots acc. to DIN 6379 length 200 mm • 4 pieces hexagon nuts 1,5 d acc. to DIN 6330 B • 4 pieces extension nuts height 3 x d • 4 pieces spherical washers acc. to DIN 6319 C and 4 pieces conical seats acc. to DIN 6319 G • 4 pieces washers for clamping devices acc. to DIN 6340
M12X12	1 16227.120.012	<p>Packed in wooden case</p> <p>Content:</p> <ul style="list-style-type: none"> • 2 pieces bolts and screws for T-slots acc. to DIN 787 length 50 mm • 4 pieces bolts and screws for T-slots acc. to DIN 787 length 80 mm • 4 pieces bolts and screws for T-slots acc. to DIN 787 length 125 mm • 4 pieces studs for T-slots acc. to DIN 6379 length 63 mm • 4 pieces studs for T-slots acc. to DIN 6379 length 100 mm • 4 pieces studs for T-slots acc. to DIN 6379 length 200 mm • 4 pieces hexagon nuts 1,5 d acc. to DIN 6330 B • 4 pieces extension nuts height 3 x d • 4 pieces spherical washers acc. to DIN 6319 C and 4 pieces conical seats acc. to DIN 6319 G • 4 pieces washers for clamping devices acc. to DIN 6340
M12X14	1 16227.120.014	<p>Packed in wooden case</p> <p>Content:</p> <ul style="list-style-type: none"> • 2 pieces bolts and screws for T-slots acc. to DIN 787 length 50 mm • 4 pieces bolts and screws for T-slots acc. to DIN 787 length 80 mm • 4 pieces nuts for T-slots acc. to DIN 508 • 4 pieces studs for T-slots acc. to DIN 6379 length 63 mm • 4 pieces studs for T-slots acc. to DIN 6379 length 100 mm • 4 pieces studs for T-slots acc. to DIN 6379 length 125 mm • 4 pieces studs for T-slots acc. to DIN 6379 length 200 mm • 4 pieces hexagon nuts 1,5 d acc. to DIN 6330 B • 4 pieces extension nuts height 3 x d • 4 pieces spherical washers acc. to DIN 6319 C and 4 pieces conical seats acc. to DIN 6319 G • 4 pieces washers for clamping devices acc. to DIN 6340
M16X18	1 16227.160.018	<p>Packed in wooden case</p> <p>Content:</p> <ul style="list-style-type: none"> • 2 pieces bolts and screws for T-slots acc. to DIN 787 length 63 mm • 4 pieces bolts and screws for T-slots acc. to DIN 787 length 100 mm • 4 pieces nuts for T-slots acc. to DIN 508 • 4 pieces studs for T-slots acc. to DIN 6379 length 80 mm • 4 pieces studs for T-slots acc. to DIN 6379 length 125 mm • 4 pieces studs for T-slots acc. to DIN 6379 length 160 mm • 4 pieces studs for T-slots acc. to DIN 6379 length 250 mm • 4 pieces hexagon nuts 1,5 d acc. to DIN 6330 B • 4 pieces extension nuts height 3 x d • 4 pieces spherical washers acc. to DIN 6319 C and 4 pieces conical seats acc. to DIN 6319 G • 4 pieces washers for clamping devices acc. to DIN 6340



16227 T-Bolt sets for T-Slots No. 6520		←	
No.	✉	Art.number	
M20X22	1	16227.200.022	Packed in wooden case Content: <ul style="list-style-type: none"> • 2 pieces bolts and screws for T-slots acc. to DIN 787 length 80 mm • 4 pieces bolts and screws for T-slots acc. to DIN 787 length 125 mm • 4 pieces nuts for T-slots acc. to DIN 508 • 4 pieces studs for T-slots acc. to DIN 6379 length 80 mm • 4 pieces studs for T-slots acc. to DIN 6379 length 125 mm • 4 pieces studs for T-slots acc. to DIN 6379 length 200 mm • 4 pieces studs for T-slots acc. to DIN 6379 length 315 mm • 4 pieces hexagon nuts 1,5 d acc. to DIN 6330 B • 4 pieces extension nuts height 3 x d • 4 pieces spherical washers acc. to DIN 6319 C and 4 pieces conical seats acc. to DIN 6319 G • 4 pieces washers for clamping devices acc. to DIN 6340
M24X28	1	16227.240.028	Packed in wooden case Content: <ul style="list-style-type: none"> • 2 pieces bolts and screws for T-slots acc. to DIN 787 length 100 mm • 4 pieces bolts and screws for T-slots acc. to DIN 787 length 160 mm • 4 pieces nuts for T-slots acc. to DIN 508 • 4 pieces studs for T-slots acc. to DIN 6379 length 100 mm • 4 pieces studs for T-slots acc. to DIN 6379 length 160 mm • 4 pieces studs for T-slots acc. to DIN 6379 length 250 mm • 4 pieces studs for T-slots acc. to DIN 6379 length 400 mm • 4 pieces hexagon nuts 1,5 d acc. to DIN 6330 B • 4 pieces extension nuts height 3 x d • 4 pieces spherical washers acc. to DIN 6319 C and 4 pieces conical seats acc. to DIN 6319 G • 4 pieces washers for clamping devices acc. to DIN 6340





16228 T-Bolt sets for T-Slots No. 6530		F95A
Material	Steel	



No.	✉	Art.number	
M10X10	1	16228.100.010	Packed in wooden case with detachable lid Content: <ul style="list-style-type: none"> • 4 pieces step clamps 11 x 80 mm • 4 pieces universal step blocks no. 1 • 4 pieces universal step blocks no. 2 • 4 pieces universal step blocks no. 3 • 2 pieces bolts and screws for T-slots acc. to DIN 787 length 40 mm • 4 pieces bolts and screws for T-slots acc. to DIN 787 length 63 mm • 4 pieces bolts and screws for T-slots acc. to DIN 787 length 100 mm • 4 pieces studs for T-slots acc. to DIN 6379 length 80 mm • 6 pieces hexagon nuts 1,5 d acc. to DIN 6330 B • 4 pieces extension nuts height 3 x d • 6 pieces conical seats acc. to ≈ DIN 6319 G • 4 pieces low-height clamping jaws (incl. hexagon socket head cap screws acc. to DIN 912, hexagon socket screw keys acc. to DIN 911 and nuts for T-slots acc. to DIN 508) • 1 piece ring spanner 17 mm
M12X12	1	16228.120.012	Packed in wooden case with detachable lid Content: <ul style="list-style-type: none"> • 4 pieces step clamps 14 x 100 mm • 4 pieces universal step blocks no. 2 • 4 pieces universal step blocks no. 3 • 2 pieces bolts and screws for T-slots acc. to DIN 787 length 50 mm • 4 pieces bolts and screws for T-slots acc. to DIN 787 length 80 mm • 4 pieces bolts and screws for T-slots acc. to DIN 787 length 125 mm • 4 pieces studs for T-slots acc. to DIN 6379 length 100 mm • 6 pieces hexagon nuts 1,5 d acc. to DIN 6330 B • 4 pieces extension nuts height 3 x d • 6 pieces conical seats acc. to ≈ DIN 6319 G • 4 pieces low-height clamping jaws (incl. hexagon socket head cap screws acc. to DIN 912, hexagon socket screw keys acc. to DIN 911 and nuts for T-slots acc. to DIN 508) • 1 piece ring spanner 19 mm
M12X14	1	16228.120.014	Packed in wooden case with detachable lid Content: <ul style="list-style-type: none"> • 4 pieces step clamps 14 x 100 mm • 4 pieces universal step blocks no. 2 • 4 pieces universal step blocks no. 3 • 2 pieces bolts and screws for T-slots acc. to DIN 787 length 50 mm • 4 pieces bolts and screws for T-slots acc. to DIN 787 length 80 mm • 4 pieces bolts and screws for T-slots acc. to DIN 787 length 125 mm • 4 pieces studs for T-slots acc. to DIN 6379 length 100 mm • 6 pieces hexagon nuts 1,5 d acc. to DIN 6330 B • 4 pieces extension nuts height 3 x d • 6 pieces conical seats acc. to ≈ DIN 6319 G • 4 pieces low-height clamping jaws (incl. hexagon socket head cap screws acc. to DIN 912, hexagon socket screw keys acc. to DIN 911 and nuts for T-slots acc. to DIN 508) • 1 piece ring spanner 19 mm • 1 piece T-slot scraper



No.		Art.number	Packed in wooden case with detachable lid	
M16X18	1	16228.160.018	Content: <ul style="list-style-type: none"> • 4 pieces step clamps 18 x 125 mm • 4 pieces universal step blocks no. 2 • 4 pieces universal step blocks no. 3 • 2 pieces bolts and screws for T-slots acc. to DIN 787 length 63 mm • 4 pieces bolts and screws for T-slots acc. to DIN 787 length 100 mm • 4 pieces bolts and screws for T-slots acc. to DIN 787 length 160 mm • 4 pieces studs for T-slots acc. to DIN 6379 length 125 mm • 6 pieces hexagon nuts 1,5 d acc. to DIN 6330 B • 4 pieces extension nuts height 3 x d • 6 pieces conical seats acc. to ≈ DIN 6319 G • 4 pieces low-height clamping jaws (incl. hexagon socket head cap screws acc. to DIN 912, hexagon socket screw keys acc. to DIN 911 and nuts for T-slots acc. to DIN 508) • 1 piece ring spanner 24 mm • 1 piece T-slot scraper 	

Lindapter - Technical Innovation in Steelwork Connections

Connect steel faster without the need for drilling or welding: Lindapter's easy-to-install fixings are suitable for connecting steel beams, hollow section, suspending building services, securing steel flooring and low speed railway lines.

Key benefits:

- Saves time and labour costs
- Use only simple hand tools without the need for drilling or welding.
- Avoids hot work permits and site closures.
- Connections can be disassembled
- Steelwork and coatings are not damaged and can be reused
- Onsite adjustability
- Industry leading product approvals

Girder Clamps

Girder Clamps offer an adjustable alternative to drilling or welding, saving time and labour costs for contractors. The clamps suit virtually any size or shape of steel section and provide a safe, high strength connection, accomplished by simply clamping two steel sections together.

High Slip Resistance (HSR) clamps

Lindapter's high slip resistant (HSR) clamps are specifically designed for high load requirements including frictional, tensile and combined load applications. The Type AAF is the latest addition to its HSR family of clamps, which offers adjustability, anti-corrosion protection and high load capacities, even in temperatures down to -60°.

Hollo-Bolt

Lindapter's CE marked Hollo-Bolts are available in various materials, lengths and sizes. The three main head types: Hexagonal, countersunk and Flush Fit are available in sizes M8 to M12. For higher strength connections the M16 and M20 hexagonal Hollo-Bolts have been optimised to give an increased clamping force, three times greater than a product of the same size without the mechanism. Hollo-Bolt is the only expansion bolt that is featured in the BCSA/SCI design guide 'Joints in steel construction'. It is also the only steelwork expansion bolt that is fully approved by ICC-ES for use in all seismic design categories A to F.

The Hollo-Bolt eliminates the needs for conventional through bolting or welding of structural hollow sections or any other steel construction where access is only available from one side. Hollo-Bolt has CE mark certification and is also approved by the the Deutsches Institute für Bautechnik and TÜV Nord.

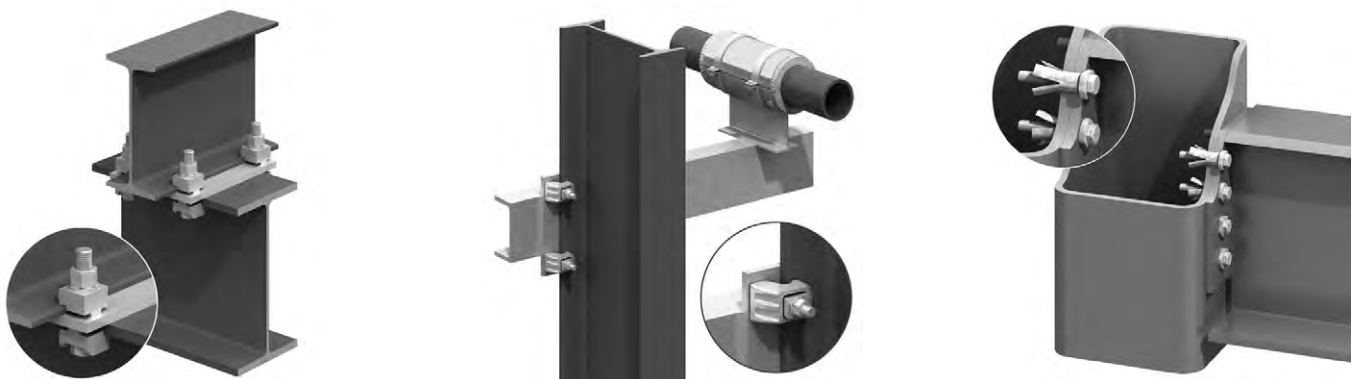

Hollow section solutions, hexagon

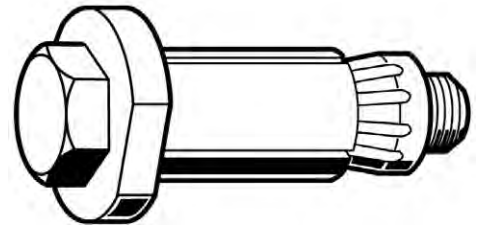
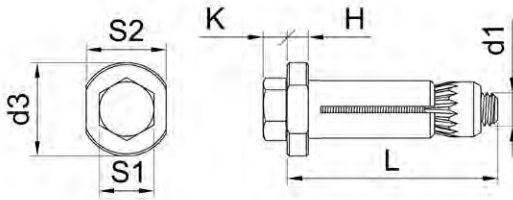

Technical Data

$d_1 \times L$	M8x 50	M8x 70	M8x 90	M10x 55	M10x 70	M10x 90	M12x 60	M12x 80	M12x 100	M16x 75	M16x 100	M16x 120	M20x 90	M20x 120	M20x 150
d_3	22	22	22	29	29	29	32	32	32	38	38	38	51	51	51
Grip range (max.)	22	41	60	22	41	60	25	47	69	29	50	71	34	60	86
Grip range (min.)	3	22	41	3	22	41	3	25	47	12	29	50	12	34	60
h	5	5	5	6	6	6	7	7	7	8	8	8	10	10	10
Hole \varnothing	14	14	14	18	18	18	20	20	20	26	26	26	33	33	33
k	5.3	5.3	5.3	6.4	6.4	6.4	7.5	7.5	7.5	10	10	10	12.5	12.5	12.5
s_1	13	13	13	17	17	17	19	19	19	24	24	24	30	30	30
s_2	19	19	19	24	24	24	30	30	30	36	36	36	46	46	46
Shear strength (5:1) (kN)	5	5	5	10	10	10	15	15	15	30	30	30	40	40	40
Tensile strength (5:1) (kN)	4	4	4	8.5	8.5	8.5	10.5	10.5	10.5	21	21	21	35	35	35
Tightening torque (Nm)	23	23	23	45	45	45	80	80	80	190	190	190	300	300	300

- **M8-M10-M12; +1,0/-0,2 / M16-M20; +2,0/-0,2**
- A Holo-Bolt is simply inserted, through the steelwork (cone end first), in a pre-drilled hole. Grip the Holo-Bolt collar with an open-ended spanner, using a torque wrench, tighten the hexagonal bolt to the torque given by the table above.
- The recommended tightening torque creates a limited clamping load in the assembly, the connection may **not** be compared with a regular bolt/nut assembly.
- For further technical data on sizes, loads, examples of application and assembly sequences, an extensive LINDAPTER brochure is available on request.

Assembly sequence

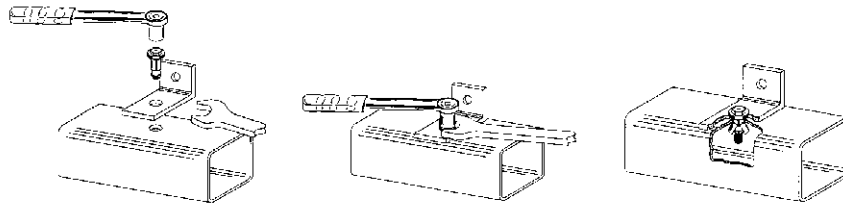

Article groups

Thread	Driving features	Material	Surface treatment	Code	Page
M	Hexagon	St	Zipl	61944	10-16
M	Hexagon	St	Hot d.g.	61945	10-17
M	Hexagon	St.St. A4		61946	10-17

61944 LINDAPTER Holo-Bolt hexagon

Thread	Metric thread
Material	Steel
Surface treatment	Zinc plated

Holo-Bolt

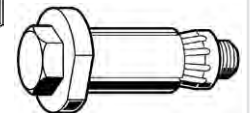



$d_1 \times L$	✉	Art.number	$d_1 \times L$	✉	Art.number	$d_1 \times L$	✉	Art.number
M8X50	100	61944.080.050	M12X60	50	61944.120.060	M16X100	25	61944.160.100
M8X70	100	61944.080.070	M12X80	25	61944.120.080	M16X120	20	61944.160.120
M8X90	50	61944.080.090	M12X100	25	61944.120.100	M20X90	10	61944.200.090
M10X55	50	61944.100.055	M16X75	25	61944.160.075	M20X120	10	61944.200.120
M10X70	50	61944.100.070				M20X150	10	61944.200.150
M10X90	50	61944.100.090						

61945 LINDAPTER Hollo-Bolt hexagon S02A

Thread: Metric thread
 Material: Steel
 Surface treatment: Hot dip galvanized

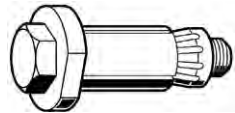
Hollo-Bolt





d ₁ x L	☒	Art.number	d ₁ x L	☒	Art.number	d ₁ x L	☒	Art.number
M8X50	100	61945.080.050	M12X60	50	61945.120.060	M16X100	25	61945.160.100
M8X70	100	61945.080.070	M12X80	25	61945.120.080	M16X120	20	61945.160.120
M8X90	50	61945.080.090	M12X100	25	61945.120.100	M20X90	10	61945.200.090
M10X55	50	61945.100.055	M16X75	25	61945.160.075	M20X120	10	61945.200.120
M10X70	50	61945.100.070				M20X150	10	61945.200.150
M10X90	50	61945.100.090						

61946 LINDAPTER Hollo-Bolt hexagon S02A

Thread: Metric thread
 Material: Stainless steel A4

Hollo-Bolt

d ₁ x L	☒	Art.number	d ₁ x L	☒	Art.number	d ₁ x L	☒	Art.number
M8X50	100	61946.080.050	M12X55	50	61946.120.060	M16X100	25	61946.160.100
M8X70	100	61946.080.070	M12X80	25	61946.120.080	M16X120	20	61946.160.120
M8X90	100	61946.080.090	M12X100	25	61946.120.100	M20X90	10	61946.200.090
M10X50	50	61946.100.055	M16X75	25	61946.160.075	M20X120	10	61946.200.120
M10X70	50	61946.100.070				M20X150	10	61946.200.150
M10X90	50	61946.100.090						

Hollow section solutions, countersunk



Technical Data												
d ₁ x L	M8x50	M8x70	M8x90	M10x55	M10x70	M10x90	M12x60	M12x80	M12x100	M16x75	M16x100	M16x120
d ₂	14	14	14	18	18	18	20	20	20	26	26	26
d ₃	22	22	22	29	29	29	32	32	32	38	38	38
Grip range (max.)	22	41	60	22	41	60	25	47	69	29	50	71
Grip range (min.)	3	22	41	3	22	41	3	25	47	12	29	50
H	5	5	5	6	6	6	7	7	7	8	8	8
s ₁	5	5	5	6	6	6	8	8	8	10	10	10
s ₂	19	19	19	24	24	24	30	30	30	36	36	36
Shear strength (5:1) (kN)	5	5	5	10	10	10	15	15	15	30	30	30
Tensile strength (5:1) (kN)	4	4	4	8.5	8.5	8.5	10.5	10.5	10.5	21	21	21
Tightening torque (Nm)	23	23	23	45	45	45	80	80	80	190	190	190

- M8-M10-M12: +1,0/-0,2 / M16: +2,0/-0,2
- A Hollo-bolt is simply inserted, through fixture and steelwork (cone end first), in a pre-drilled hole.
- Allowable shear load. Application under dynamic load needs to be fixed carefully.
- The recommended tightening torque creates a limited clamping load in the assembly, the connection may not be compared with a regular bolt/nut assembly.
- For further technical data on sizes, loads, examples of application and assembly sequences, an extensive LINDAPTER brochure is available on request.

Assembly sequence

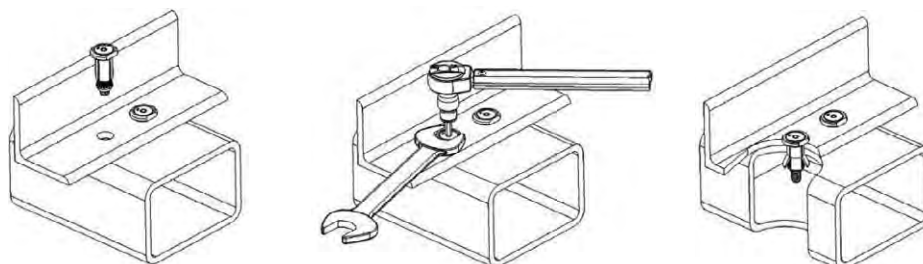

Article groups

Thread	Driving features	Material	Surface treatment	Code	Page
M	Hexagon socket	St	Zipl	61952	10-18
M	Hexagon socket	St.St. A2		61953	10-18

61952 LINDAPTER Hollo-bolt countersunk

S02A

Thread	Metric thread
Material	Steel
Surface treatment	Zinc plated

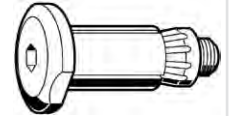

$d_1 \times L$	☒	Art.number	$d_1 \times L$	☒	Art.number	$d_1 \times L$	☒	Art.number
M8X50	100	61952.080.050	M10X70	50	61952.100.070	M12X100	25	61952.120.100
M8X70	100	61952.080.070	M10X90	50	61952.100.090	M16X75	25	61952.160.075
M8X90	50	61952.080.090	M12X60	50	61952.120.060	M16X100	25	61952.160.100
M10X55	50	61952.100.055	M12X80	25	61952.120.080	M16X120	20	61952.160.120

61953 LINDAPTER Hollo-bolt countersunk

S02A

Thread	Metric thread
Material	Stainless steel A2

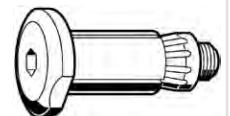

$d_1 \times L$	☒	Art.number	$d_1 \times L$	☒	Art.number	$d_1 \times L$	☒	Art.number
M8X50	100	61953.080.050	M10X70	50	61953.100.070	M12X100	25	61953.120.100
M8X70	100	61953.080.070	M10X90	50	61953.100.090	M16X75	25	61953.160.075
M8X90	100	61953.080.090	M12X60	50	61953.120.060	M16X100	25	61953.160.100
M10X55	50	61953.100.055	M12X80	25	61953.120.080	M16X120	20	61953.160.120

Hollow section solutions, non protruding

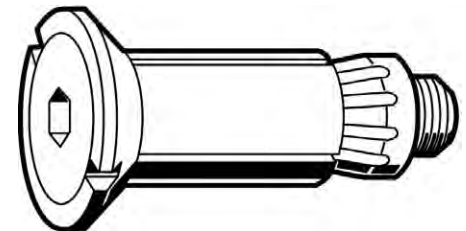
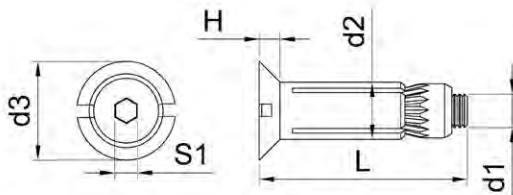

Technical Data

$d_1 \times L$	$d_2 = \text{drill } \varnothing^*$	d_3	Grip range (max.)	Grip range (min.)	H	s_1	Shear strength (5:1) (kN)	Tensile strength (5:1) (kN)	Tightening torque (Nm)
M8x50	14	24	27	10	5	5	5	4	23
M10x50	18	30	27	12	6	6	10	8.5	45
M12x55	20	33	30	12	7	8	15	10.5	80

- * M8-M10-M12; +1,0/-0,2
- For installation use auxiliary tool 61949.
- Hollo-bolt is simply inserted, through fixture and steelwork (cone end first), in a pre-drilled hole.
- Allowable shear load. Application under dynamic load needs to be fixed carefully.
- The recommended tightening torque creates a limited clamping load in the assembly, the connection may not be compared with a regular bolt/nut assembly.
- For further technical data on sizes, loads, examples of application and assembly sequences, an extensive LINDAPTER brochure is available on request.

Assembly sequence

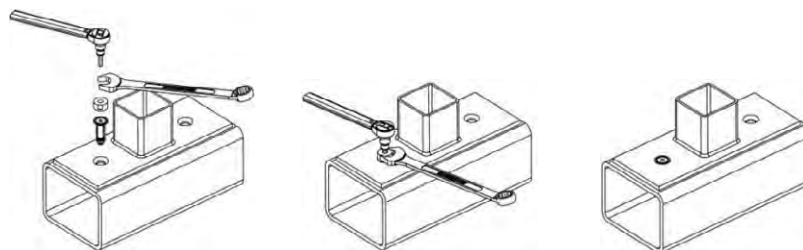

61948 LINDAPTER Hollo-bolt Flush Fit						S02A	
Thread	Metric thread						
Material	Steel						
Surface treatment	Zinc plated						
d₁ x L	✉ Art.number	d₁ x L	✉ Art.number	d₁ x L	✉ Art.number	d₁ x L	✉ Art.number
M8X50	100 61948.080.050	M10X50	50 61948.100.050	M12x55	50 61948.120.055		

Non protruding fit tool

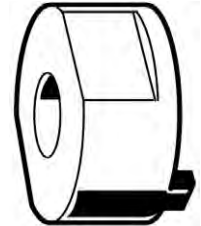
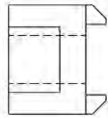
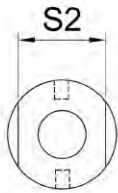

Technical Data	
For nom.size	S ₂
M8	19
M10	24
M12	30

- Auxiliary tool for HB 61948.

61949 LINDAPTER Hollo-bolt Flush Fit tool						S02A	
Material	Steel						
Surface treatment	Zinc plated						
For nom. size	✉ Art.number	For nom. size	✉ Art.number	For nom. size	✉ Art.number	For nom. size	✉ Art.number
M8	1 61949.080.001	M10	1 61949.100.001	M12	1 61949.120.001		

Girder clamp components

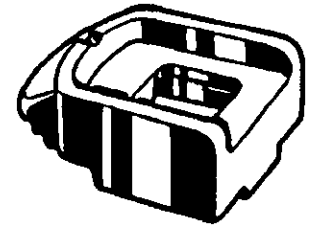

Article groups

Material	Surface treatment		Code	Page
Mal.Ir.	Zipl	A short	61015	10-20
Mal.Ir.	Hot d.g.	A short	61020	10-20
Mal.Ir.	Zipl	A medium	61035	10-20
Mal.Ir.	Hot d.g.	A medium	61040	10-21
Mal.Ir.	Zipl	A long	61055	10-21
Mal.Ir.	Hot d.g.	A long	61060	10-21
Mal.Ir.	Zipl	B short	61115	10-21
Mal.Ir.	Hot d.g.	B short	61120	10-21
Mal.Ir.	Zipl	B medium	61135	10-22
Mal.Ir.	Hot d.g.	B medium	61140	10-22
Mal.Ir.	Zipl	B long	61155	10-22
Mal.Ir.	Hot d.g.	B long	61165	10-22
SG iron	Hot d.g.	AF short	61170	10-22
SG iron	Hot d.g.	AF medium	61180	10-23

61015 LINDAPTER Steelwork fixing Type A short

S05A

Material Malleable iron
Surface treatment Zinc plated

lindapter



For bolt size	☒	Art.number	For bolt size	☒	Art.number	For bolt size	☒	Art.number
M10	100	61015.100.001	M16	50	61015.160.001	M24	20	61015.240.001
M12	100	61015.120.001	M20	50	61015.200.001			

- With recess, incline max. 8°.

61020 LINDAPTER Steelwork fixing Type A short

S05A

Material Malleable iron
Surface treatment Hot dip galvanized

lindapter



For bolt size	☒	Art.number	For bolt size	☒	Art.number	For bolt size	☒	Art.number
M10	100	61020.100.001	M16	50	61020.160.001	M24	20	61020.240.001
M12	100	61020.120.001	M20	50	61020.200.001			

- With recess, incline max. 8°.

61035 LINDAPTER Steelwork fixing Type A medium

S05A

Material Malleable iron
Surface treatment Zinc plated

lindapter



For bolt size	☒	Art.number	For bolt size	☒	Art.number	For bolt size	☒	Art.number
M10	100	61035.100.001	M16	50	61035.160.001	M24	20	61035.240.001
M12	100	61035.120.001	M20	50	61035.200.001			

- With recess, incline max. 8°.

61040 LINDAPTER Steelwork fixing Type A medium S05A

Material	Malleable iron			
Surface treatment	Hot dip galvanized			

For bolt size	☒	Art.number	For bolt size	☒	Art.number	For bolt size	☒	Art.number
M10	100	61040.100.001	M16	50	61040.160.001	M24	10	61040.240.001
M12	100	61040.120.001	M20	50	61040.200.001			

- With recess, incline max. 8°.

61055 LINDAPTER Steelwork fixing Type A long S05A

Material	Malleable iron			
Surface treatment	Zinc plated			

For bolt size	☒	Art.number	For bolt size	☒	Art.number	For bolt size	☒	Art.number
M10	100	61055.100.001	M16	50	61055.160.001	M24	20	61055.240.001
M12	100	61055.120.001	M20	50	61055.200.001			

- With recess, incline max. 8°.

61060 LINDAPTER Steelwork fixing Type A long S05A

Material	Malleable iron			
Surface treatment	Hot dip galvanized			

For bolt size	☒	Art.number	For bolt size	☒	Art.number	For bolt size	☒	Art.number
M10	100	61060.100.001	M16	50	61060.160.001	M24	10	61060.240.001
M12	100	61060.120.001	M20	50	61060.200.001			

- With recess, incline max. 8°.

61115 LINDAPTER Steelwork fixing Type B short S05A

Material	Malleable iron			
Surface treatment	Zinc plated			

For bolt size	☒	Art.number	For bolt size	☒	Art.number	For bolt size	☒	Art.number
M10	100	61115.100.001	M16	50	61115.160.001	M24	20	61115.240.001
M12	100	61115.120.001	M20	25	61115.200.001			

- With flat top, incline max. 8°.

61120 LINDAPTER Steelwork fixing Type B short S05A

Material	Malleable iron			
Surface treatment	Hot dip galvanized			

For bolt size	☒	Art.number	For bolt size	☒	Art.number	For bolt size	☒	Art.number
M10	100	61120.100.001	M16	50	61120.160.001	M24	20	61120.240.001
M12	100	61120.120.001	M20	25	61120.200.001			

- With flat top, incline max. 8°.

61135	LINDAPTER Steelwork fixing Type B medium				S05A	
Material	Malleable iron					
Surface treatment	Zinc plated					

For bolt size	☒	Art.number	For bolt size	☒	Art.number	For bolt size	☒	Art.number
M10	100	61135.100.001	M16	50	61135.160.001	M24	20	61135.240.001
M12	100	61135.120.001	M20	25	61135.200.001			

- With flat top, incline max. 8°.

61140	LINDAPTER Steelwork fixing Type B medium				S05A	
Material	Malleable iron					
Surface treatment	Hot dip galvanized					

For bolt size	☒	Art.number	For bolt size	☒	Art.number	For bolt size	☒	Art.number
M10	100	61140.100.001	M16	50	61140.160.001	M24	10	61140.240.001
M12	100	61140.120.001	M20	25	61140.200.001			

- With flat top, incline max. 8°.

61155	LINDAPTER Steelwork fixing Type B long				S05A	
Material	Malleable iron					
Surface treatment	Zinc plated					

For bolt size	☒	Art.number	For bolt size	☒	Art.number	For bolt size	☒	Art.number
M10	100	61155.100.001	M16	50	61155.160.001	M24	20	61155.240.001
M12	100	61155.120.001	M20	25	61155.200.001			

- With flat top, incline max. 8°.

61165	LINDAPTER Steelwork fixing Type B long				S05A	
Material	Malleable iron					
Surface treatment	Hot dip galvanized					

For bolt size	☒	Art.number	For bolt size	☒	Art.number	For bolt size	☒	Art.number
M10	100	61165.100.001	M16	50	61165.160.001	M24	20	61165.240.001
M12	100	61165.120.001	M20	25	61165.200.001			

- With flat top, incline max. 8°.

61170	LINDAPTER Steelwork fixing Type AF short				S05A	
Material	SG iron					
Surface treatment	Hot dip galvanized					

For bolt size	☒	Art.number	For bolt size	☒	Art.number	For bolt size	☒	Art.number
M12	25	61170.120.001	M20	10	61170.200.001	M24	5	61170.240.001
M16	10	61170.160.001						

- With flat top, incline max. 10°.

61180 LINDAPTER Steelwork fixing Type AF medium		S05A	
Material	SG iron		
Surface treatment	Hot dip galvanized		

For bolt size	☒	Art.number	For bolt size	☒	Art.number	For bolt size	☒	Art.number
M12	25	61180.120.001	M20	10	61180.200.001	M24	5	61180.240.001
M16	20	61180.160.001						

- With flat top, incline max. 10°.

Self-adjustable clamp



61450 LINDAPTER Self-adjustable clamp Type AAF		S05A	
Material	SG iron		
Surface treatment	Hot dip galvanized		

d	☒	Art.number	d	☒	Art.number	d	☒	Art.number
M12	20	61450.120.001	M16	10	61450.160.001	M20	4	61450.200.001

Packings

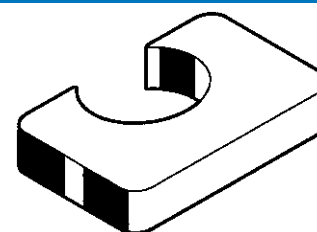

Article groups

Material	Surface treatment		Code	Page
St	Zipl	CW	61415	10-24
St	Hot d.g.	CW	61420	10-24
St	Zipl	P1 short	61515	10-24
St	Hot d.g.	P1 short	61530	10-24
St	Zipl	P2 short	61615	10-24
St	Hot d.g.	P2 short	61630	10-25
St	Hot d.g.	AF/CW	61430	10-25
St	Hot d.g.	AF/P1	61435	10-25
St	Hot d.g.	AF/P2	61440	10-25
St	Zipl	P1 long	61555	10-25
St	Hot d.g.	P1 long	61570	10-26
Cl	Zipl	P2 long	61650	10-26
Cl	Hot d.g.	P2 long	61670	10-26

61415 LINDAPTER Clipped washer Type CW S05A

Material	Steel			
Surface treatment	Zinc plated			

For bolt size	☒	Art.number	For bolt size	☒	Art.number	For bolt size	☒	Art.number
M10	250	61415.100.001	M16	250	61415.160.001	M24	100	61415.240.001
M12	250	61415.120.001	M20	100	61415.200.001			

• Suitable for steelwork fixings Type A, B and BR.

61420 LINDAPTER Clipped washer Type CW S05A

Material	Steel			
Surface treatment	Hot dip galvanized			

For bolt size	☒	Art.number	For bolt size	☒	Art.number	For bolt size	☒	Art.number
M10	250	61420.100.001	M16	250	61420.160.001	M24	100	61420.240.001
M12	250	61420.120.001	M20	100	61420.200.001			

• Suitable for steelwork fixings Type A, B and BR.

61515 LINDAPTER Packing Type P1 short S05A

Material	Steel			
Surface treatment	Zinc plated			

d	☒	Art.number	d	☒	Art.number	d	☒	Art.number
M10	250	61515.100.001	M16	100	61515.160.001	M24	25	61515.240.001
M12	200	61515.120.001	M20	100	61515.200.001			

• Suitable for steelwork fixings Type A, B and BR.

61530 LINDAPTER Packing Type P1 short S05A

Material	Steel			
Surface treatment	Hot dip galvanized			

d	☒	Art.number	d	☒	Art.number	d	☒	Art.number
M10	250	61530.100.001	M16	100	61530.160.001	M24	25	61530.240.001
M12	200	61530.120.001	M20	100	61530.200.001			

• Suitable for steelwork fixings Type A, B and BR.

61615 LINDAPTER Packing Type P2 short S05A

Material	Steel			
Surface treatment	Zinc plated			

d	☒	Art.number	d	☒	Art.number	d	☒	Art.number
M10	100	61615.100.001	M16	100	61615.160.001	M24	25	61615.240.001
M12	100	61615.120.001	M20	50	61615.200.001			

• Suitable for steelwork fixings Type A, B and BR.

61630 LINDAPTER Packing Type P2 short S05A

Material Steel
Surface treatment Hot dip galvanized

lindapter





d	☒	Art.number	d	☒	Art.number	d	☒	Art.number
M10	100	61630.100.001	M16	100	61630.160.001	M24	25	61630.240.001
M12	100	61630.120.001	M20	50	61630.200.001			

- Suitable for steelwork fixings Type A, B and BR.

61430 LINDAPTER Clipped washer Type AF/CW S05A

Material Steel
Surface treatment Hot dip galvanized

lindapter

For bolt size	☒	Art.number	For bolt size	☒	Art.number	For bolt size	☒	Art.number
M12	250	61430.120.001	M16	200	61430.160.001	M20	200	61430.200.001

- Suitable for high friction clamp Type AF.

61435 LINDAPTER Packing Type AF/P1 S05A

Material Steel
Surface treatment Hot dip galvanized

lindapter

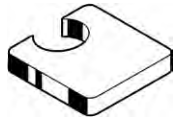
d	☒	Art.number	d	☒	Art.number	d	☒	Art.number
M12	100	61435.120.001	M20	50	61435.200.001	M24	25	61435.240.001
M16	100	61435.160.001						

- Suitable for high friction clamp Type AF.

61440 LINDAPTER Packing Type AF/P2 S05A

Material Steel
Surface treatment Hot dip galvanized

lindapter





d	☒	Art.number	d	☒	Art.number	d	☒	Art.number
M12	50	61440.120.001	M20	10	61440.200.001	M24	10	61440.240.001
M16	50	61440.160.001						

- Suitable for high friction clamp Type AF.

61555 LINDAPTER Packing Type P1 long S05A

Material Steel
Surface treatment Zinc plated

lindapter





d	☒	Art.number	d	☒	Art.number	d	☒	Art.number
M10	100	61555.100.001	M16	100	61555.160.001	M24	25	61555.240.001
M12	100	61555.120.001	M20	50	61555.200.001			

- Suitable for steelwork fixings Type D1, D2 and LR.

61570 LINDAPTER Packing Type P1 long S05A

Material Steel
Surface treatment Hot dip galvanized

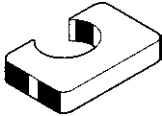
lindapter

d	☒	Art.number	d	☒	Art.number	d	☒	Art.number
M12	100	61570.120.001	M20	50	61570.200.001	M24	25	61570.240.001
M16	100	61570.160.001						

- Suitable for steelwork fixings Type D1, D2 and LR.

61650 LINDAPTER Packing Type P2 long S05A

Material Cast iron
Surface treatment Zinc plated

lindapter





d	☒	Art.number	d	☒	Art.number	d	☒	Art.number
M10	100	61650.100.001	M16	50	61650.160.001	M24	25	61650.240.001
M12	100	61650.120.001	M20	10	61650.200.001			

- Suitable for steelwork fixings Type D2 and LR.

61670 LINDAPTER Packing Type P2 long S05A

Material Cast iron
Surface treatment Hot dip galvanized

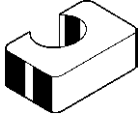
lindapter

d	☒	Art.number	d	☒	Art.number	d	☒	Art.number
M12	100	61670.120.001	M20	25	61670.200.001	M24	20	61670.240.001
M16	100	61670.160.001						

- Suitable for steelwork fixings Type D2 and LR.

Deep washer

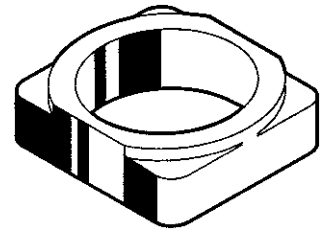

61810 LINDAPTER Deep washer Type W		S05A	
Material	Cast iron		
Surface treatment	Zinc plated		

d	☒	Art.number	d	☒	Art.number	d	☒	Art.number
M10		1000 61810.100.001	M16		500 61810.160.001	M20		250 61810.200.001
M12		500 61810.120.001						

- Suitable for steelwork fixings type A and D2
- For filling the recess

High friction clamp



61265 LINDAPTER High friction clamp Type CF		S05A	
Material	SG iron		
Surface treatment	Hot dip galvanized		

d	☒	Art.number	d	☒	Art.number	d	☒	Art.number
M12		25 61265.120.001	M16		20 61265.160.001	M20		10 61265.200.001

Self adjustable tail clamp

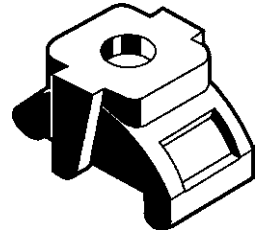

Article groups

Material	Surface treatment	Code	Page
Mal.Ir.	Zipl	61951	10-28
Mal.Ir.	Hot d.g.	61961	10-28

61951 LINDAPTER Self-adjustable clamp Type LR S05A

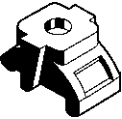
Material	Malleable iron	lindapter		
Surface treatment	Zinc plated			

d	☒	Art.number	d	☒	Art.number	d	☒	Art.number
M10	50	61951.100.001	M16	25	61951.160.001	M24	5	61951.240.001
M12	50	61951.120.001	M20	10	61951.200.001			

61961 LINDAPTER Self-adjustable clamp Type LR S05A

Material	Malleable iron	lindapter		
Surface treatment	Hot dip galvanized			

d	☒	Art.number	d	☒	Art.number	d	☒	Art.number
10MM	50	61961.100.001	16MM	25	61961.160.001	24MM	5	61961.240.001
12MM	100	61961.120.001	20MM	10	61961.200.001			

Adjustable tail clamp

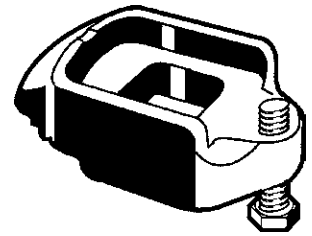

Article groups

Material	Surface treatment	Code	Page
Mal.lr.	Zipl	61290	10-29
Mal.lr.	Hot d.g.	61300	10-29

61290 LINDAPTER Adjustable tail clamp and set screw tail Type D2 S05A

Material Malleable iron
Surface treatment Zinc plated

lindapter

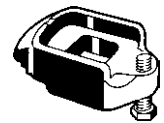

d	☒	Art.number	d	☒	Art.number	d	☒	Art.number
M10	100	61290.100.001	M16	50	61290.160.001	M20	25	61290.200.001
M12	100	61290.120.001						

- With recess and setscrew tail.

61300 LINDAPTER Adjustable tail clamp and set screw tail Type D2 S05A

Material Malleable iron
Surface treatment Hot dip galvanized

lindapter

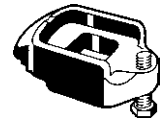

d	☒	Art.number	d	☒	Art.number	d	☒	Art.number
M10	100	61300.100.001	M16	50	61300.160.001	M20	25	61300.200.001
M12	100	61300.120.001						

- With recess and setscrew tail.

Rail clip

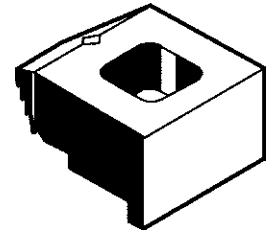

Article groups

Material	Surface treatment		Code	Page
Mal.l.r.	Zipl	BR short	61936	10-30
Mal.l.r.	Zipl	BR medium	61937	10-30
Mal.l.r.	Hot d.g.	BR short	61938	10-30
Mal.l.r.	Hot d.g.	BR medium	61939	10-30

61936 LINDAPTER Rail clip Type BR short S05A

Material Malleable iron
Surface treatment Zinc plated

lindapter

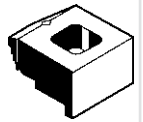

d	Art.number	d	Art.number	d	Art.number
M12	100 61936.120.001	M16	50 61936.160.001	M20	25 61936.200.001

- With flat top, incline max. 8°.

61937 LINDAPTER Rail clip Type BR medium S05A

Material Malleable iron
Surface treatment Zinc plated

lindapter

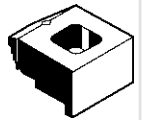

d	Art.number	d	Art.number	d	Art.number
M12	100 61937.120.001	M16	50 61937.160.001	M20	25 61937.200.001

- With flat top, incline max. 8°.

61938 LINDAPTER Rail clip Type BR short S05A

Material Malleable iron
Surface treatment Hot dip galvanized

lindapter

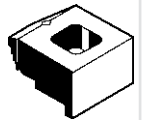

d	Art.number	d	Art.number	d	Art.number
M12	100 61938.120.001	M16	50 61938.160.001	M20	25 61938.200.001

- With flat top, incline max. 8°.

61939 LINDAPTER Rail clip Type BR medium S05A

Material Malleable iron
Surface treatment Hot dip galvanized

lindapter

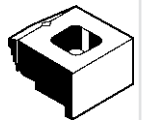

d	Art.number	d	Art.number	d	Art.number
M12	100 61939.120.001	M16	50 61939.160.001	M20	25 61939.200.001

- With flat top, incline max. 8°.

Flange clamp

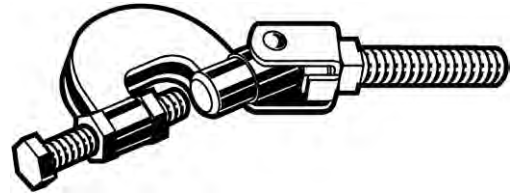

Article groups

Material	Surface treatment		Code	Page
SG iron	Zipl	FLS	61860	10-31
Mal.ir.	Zipl	LC	61317	10-31
Mal.ir.	Zipl	FL	61355	10-31
Mal.ir.	Hot d.g.	F3	61390	10-31

61860	LINDAPTER Flange clamp Type FLS	S05A
Material	SG iron	
Surface treatment	Zinc plated	

For drop rod/typenr.	Art.number	For drop rod/typenr.	Art.number
M8	25 61860.080.001	M10	25 61860.100.001

61317	LINDAPTER Flange clamp Type LC with set screw and nut	S05A
Material	Malleable iron	
Surface treatment	Zinc plated	

For drop rod/typenr.	Art.number
M6	100 61317.060.001

With horizontal and vertical attachment locations.

61355	LINDAPTER Flange clamp Type FL with set screw and nut	S05A
Material	Malleable iron	
Surface treatment	Zinc plated	

For drop rod/typenr.	Art.number	For drop rod/typenr.	Art.number	For drop rod/typenr.	Art.number
M8 FL1	100 61355.080.001	M12 FL3	50 61355.120.001	M12 FL4	25 61355.120.004
M10 FL2	50 61355.100.001				

- Approved by VdS and FM.

61390	LINDAPTER Universal flange clamp Type F3	S05A
Material	Malleable iron	
Surface treatment	Hot dip galvanized	

For drop rod/typenr.	Art.number	For drop rod/typenr.	Art.number
M12	25 61390.120.001	M16	10 61390.160.001

- Approved by FM

Girder clamp system

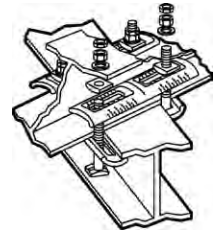



Technical Data

Nom.size	M16
Flange thickness/adjustability	5-19
Flange width/adjustability	75-180
Max. load (5:1) (kN)	30
Tightening torque (Nm)	147

- FLUSH CLAMP is an adjustable steelwork connection that clamps the flanges of two steel beams together without the use of a location plate. This assembly forms a clamp that is suitable for connecting beams of varying flange widths and thicknesses.
- Contents FLUSH CLAMP set: 4 each of six basic components: special body, special bolts, special washers, flat washers, hexagon nuts and half nuts.

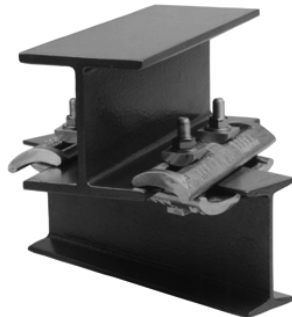
Example of application



61850	LINDAPTER Flush clamp	S05A
Thread	Metric thread	  
Material	Steel	
Surface treatment	Zinc plated	

Nom. size.	☒	Art.number
M16	1	61850.160.001

Eccentric steelwork locking system

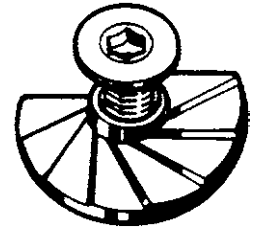
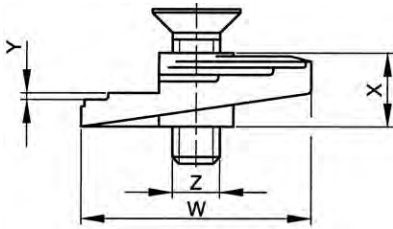

Technical Data

Z	W	X	Y
M8	60	20	2
M10	60	20	2
M12	60	20	2

- The FLOORFAST, fixing for chequerplate flooring, enables steel floorplates to be fixed from above, by one man only, using simply a tee-handled hexagon key. There is no need for access from below and no site drilling or welding is required.

Assembly sequence

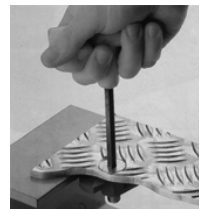
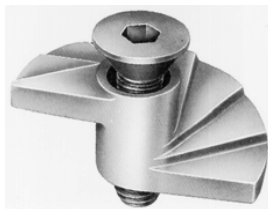

Article groups

Thread	Material	Surface treatment	Code	Page
M	Mal.Ir.	Zipl	61941	10-33
M	Mal.Ir.	Hot d.g.	61963	10-33

61941 LINDAPTER Floorfast		S05A
Thread	Metric thread	
Material	Malleable iron	
Surface treatment	Zinc plated	

Z	Art.number	Z	Art.number	Z	Art.number
M8	50 61941.080.001	M10	50 61941.100.001	M12	50 61941.120.001

Also available in stainless steel Grade 316.

61963 LINDAPTER Floorfast		S05A
Thread	Metric thread	
Material	Malleable iron	
Surface treatment	Hot dip galvanized	

Z	Art.number
10MM	100 61963.100.001

Also available in stainless steel Grade 316.

Clips

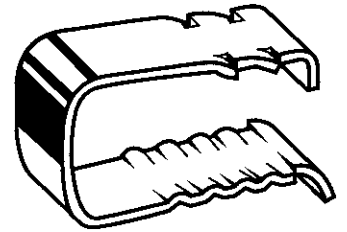
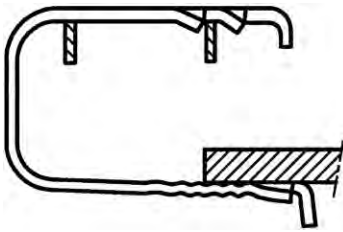



Technical Data

Type	GF3030
Clamping force per clip (N)	340-530-680
Total clamping thickness	38-43-48

- The GF 3030 is a groundbreaking product that enables the connection of European style 30 x 30 floor grating to steel sections.
- The product's ingenuity lies in its place and stand installation method, which can be carried out by one person only, working from above, without the need to drill or weld.
- Not only does this significant cost savings, but maintains the integrity of existing steelwork.
- The GF 3030 is designed specifically for use with 30 mm depth floor grating. It is however possible to use the product on other grating depths, providing the total fixing thickness (grating depth + steelwork flange thickness) is between 38 mm (minimum) and 48 mm (maximum). The steelwork flange thickness range is 8-18 mm.
- Sheradized acc. to BS 4921 Class 1 (380°C max.) plus passivation and one coat of silver Delta Seal.

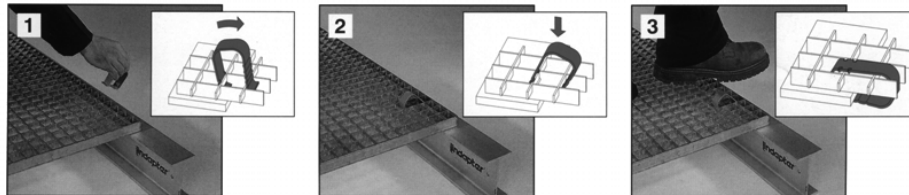
Assembly data



61942	LINDAPTER GF 3030 Clip	S05A
Material	Spring steel	 
Surface treatment	Sheraplex	

Type	☒	Art.number
GF 3030	50	61942.001.770

Saddle

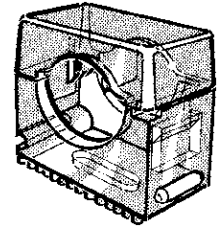
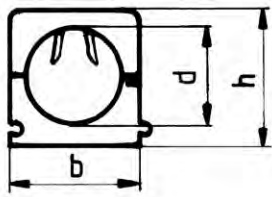
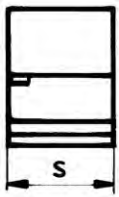

Technical Data

Type	b	Cable/pipe diameter d	h	Pull-out force (N)	s
SCH 812	21.5	8-12	23.1	0.09	16.5
SCH 1216	27.5	12-16	28.7	0.2	16.5
SCH 1619	32.5	16-19	37.6	0.2	16.5
SCH 1623	36	16-23	37.6	0.2	16.5
SCH 2332	46.5	23-32	50	0.3	16.5
SCH 3242	53.5	32-42	62	0.4	16.5

- Side coupling can be extended to 4 saddles in line.
- Pull-out force (breaking force) required to force off the saddle cap. It is advised to take a safetyfactor: ≥ 7 .

Assembly sequence

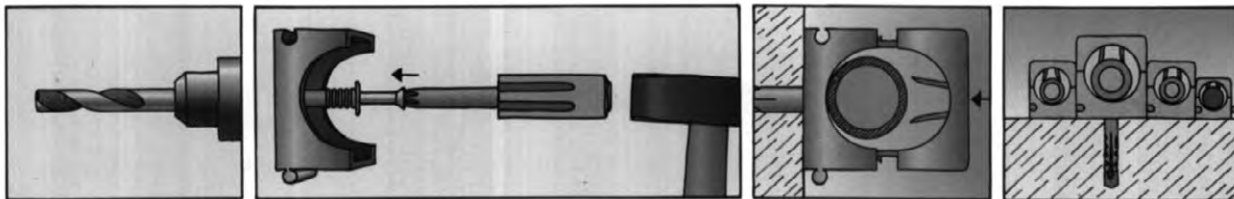

63500 FISCHER Saddle type SCH

N03B

Material Plastic Polyamide (nylon)

fischer
innovative solutions

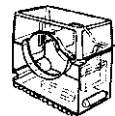

Type	☒	Art.number	Type	☒	Art.number	Type	☒	Art.number
SCH 8-12MM	100	63500.008.013	SCH 16-19MM	50	63500.016.019	23-32MM	25	63500.023.032
SCH 12-16MM	50	63500.012.016	SCH 16-23MM	50	63500.016.023	32-42MM	25	63500.032.042

Hinged pipe clamp

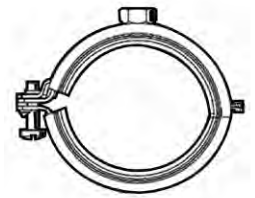
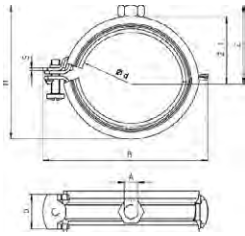

Technical Data

ø d	A	B	b x s	H	h	N	Pipe size	Screw size
15-19	M8	52	20x1.25	40	6.8	0.60	3/8	M5x25
20-24	M8	58	20x1.25	45	6.8	0.60	1/2	M5x25
25-30	M8	63	20x1.25	49	6.8	0.60	3/4	M5x25
32-37	M8	72	20x1.25	57	6.8	0.8	1 Inch	M5x25
40-45	M8	79	20x1.5	66	6.8	0.8	1.1/4	M5x30
48-53	M8	88	20x1.5	76	6.8	0.8	1.1/2	M5x30
59-63	M8	99	20x1.5	85	6.8	0.8	2 Inch	M5x30

- N = Max. recom. static load (centr. tension) [kN].

Assembly sequence

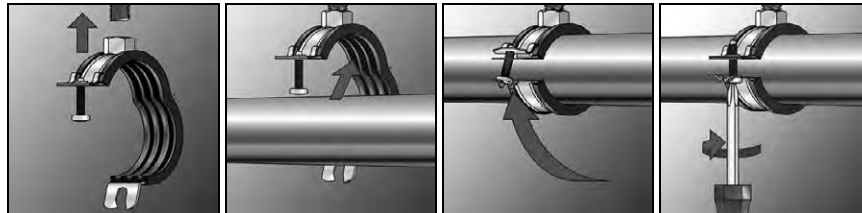

- Insert pipe, press together clamp parts, engage locking screw and tighten.

64100 FISCHER Hinged pipe clamp FGRS Plus

N02A

Material Steel DD11

fischer
innovative solutions



Grip range	✉	Art.number	Grip range	✉	Art.number	Grip range	✉	Art.number
15-19	100	64100.015.019	32-37	100	64100.032.037	48-53	50	64100.048.053
20-24	100	64100.020.024	40-45	50	64100.040.045	59-63	50	64100.059.063
25-30	100	64100.025.030						

- One-piece hinged pipe clamp with patented rapid locking and readjusting mechanism.
- Sound insulation for DIN 4109.
- Advantages / Benefits.
- Quick-connect permits a simple and fast installation with one hand.
- Hinged pipe clamp can open wide for easy insertion of the pipe.
- Time and energy saving insertion of the pipe in overhead installation.
- For fastening:
- Pipe lines to walls, ceilings and floors in the sanitary and heating area.
- Properties:
- Material: Steel DD11 (material no. 1.0332) acc. to DIN EN 10111.
- Zinc plating :Electro zinc plated, 5 - 9 µm.
- Connecting nut (FGRS Plus): Resistance welded, M 8, SW 13.
- Locking screw (FGRS Plus): Flat head screw with combination recessed head.
- Sound insulation insert: Material: SBR/EPDM; chlorine-free; silicone-free.
- Sound insulation for: DIN 4109.
- Temperature range: -50° to +110°C.
- Hardness: 45 +- 5° Shore.
- Fire behavior: DIN 4102: class B2.

Pipe clamp

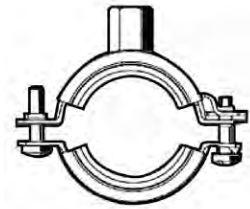
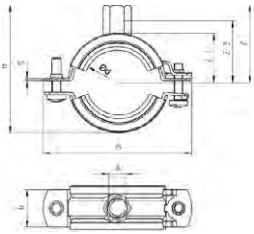

Technical Data

ø d	A	B	b x s	H	h	N	Pipe size	Screw size
15-19	M8/M10	61	20x1.25	51	17	0.8	3/8	M5x25
20-24	M8/M10	66	20x1.25	56	17	0.8	1/2	M5x25
25-30	M8/M10	72	20x1.25	62	17	0.8	3/4	M5x25
32-37	M8/M10	79	20x1.25	67	17	0.8	1 Inch	M5x25
40-45	M8/M10	86	20x1.25	78	17	1.00	1.1/4	M5x30
48-53	M8/M10	94	20x1.5	83	17	1.00	1.1/2	M5x30
59-63	M8/M10	114	20x1.5	96	17	1.40	2 Inch	M6x30
62-64	M8/M10	114	25x2.0	96	17	1.40	-	M6x30
68-73	M8/M10	124	25x2.0	108	17	1.40	-	M6x30
74-78	M8/M10	129	25x2.0	113	17	1.80	2.1/2	M6x30
80-86	M8/M10	133	25x2.0	115	17	1.80	-	M6x30
89-92	M8/M10	142	25x2.0	125	17	1.80	3 Inch	M6x30
95-103	M8/M10	156	25x2.0	140	17	1.80	-	M6x30

- N = Max. recom. static load (centr. tension) [kN].

Assembly sequence

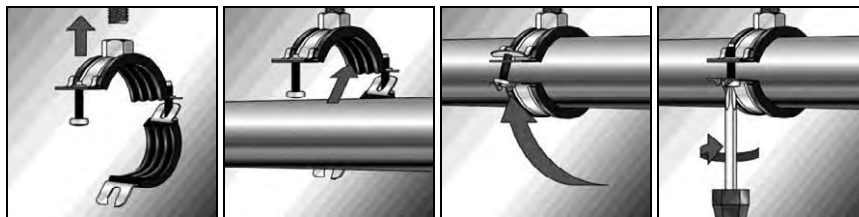

- Insert pipe, press together clamp parts, engage locking screw and tighten.

64108	FISCHER Pipe clamp FRS Plus	N02A
Material	Steel DD11	

Grip range	☒	Art.number	Grip range	☒	Art.number	Grip range	☒	Art.number
15-19	100	64108.015.019	40-45	50	64108.040.045	74-78	25	64108.074.078
20-24	100	64108.020.024	48-53	50	64108.048.053	80-86	25	64108.080.086
25-30	100	64108.025.030	62-64	25	64108.062.064	89-92	25	64108.089.092
32-37	100	64108.032.037	68-73	25	64108.068.073	95-103	25	64108.095.103

- Two-piece pipe clamp with patented rapid locking and readjusting mechanism.
- Sound insulation for DIN 4109.
- Connecting nut with combination thread M8 / M10.
- Advantages / Benefits
- Quick-connect permits simple and fast installation.
- Large opening angle for easy insertion of the pipes.
- Because of reliable click mechanism, the pipe can be preinstalled and adjusted easily.
- Time and energy saving insertion of the pipes for overhead installation.
- For fastening pipe lines, such as heating, sanitary and waste water pipes, to walls, ceilings and floors.
- Properties:
- Material: Steel DD11 (material no. 1.0332) acc. to DIN EN 10111.
- Zinc plating: Electro zinc plated, 5 - 9 µm.
- Connecting nut: Resistance welded, M 8/M 10, SW 13.
- Locking screw: Flat head screw with combination recessed head.
- Sound insulation insert: Material: SBR/EPDM; chlorine-free; silicone-free.
- Sound insulation for DIN 4109.
- Temperature range: -50° to +110°C.
- Hardness: 45 +- 5° Shore.
- Fire behavior: DIN 4102: class B2.

Refrigeration pipe clamp

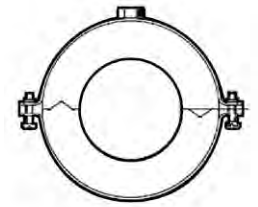
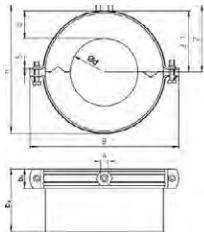

Technical Data

ø d	A	B	b ₂ x d	H	h	M	N	Pipe size	Z
21	M8	126	40x30	92	6.8	1.5	0.06	1/2	60

- N = Max. recom. static load (centr. tension) [kN].
- M = Max. recom. span [m].

Assembly data

- Apply corrosion protection to pipe line.
- Insert pipe, pull protective film from insulation and glue.
- Screw together clamp parts.
- On front side, glue sealing insulation to refrigeration clamp.

64122 FISCHER Refrigeration pipe clamp FRS F

N02A

Material PU

fischer
innovative solutions

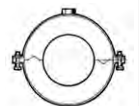

ø x d Art.number

21/30 1 [64122.021.030](#)

- Two-piece pipe clamp with PU hard foam shell.
- Insulation with self-adhesive seal.
- Advantages / Benefits:
- PU insulation element for high insulating effect.
- Compression-resistant PU hard foam for load absorption.
- Steam diffusion-tight due to Alu outer shroud.
- High aging resistance.
- Step-shaped sealing joints on the insulation for better sealing.
- Simple installation due to large opening angle.
- Locking screw with large combination recessed head is secured against loss.
- For fastening:
- Pipes in refrigeration and air conditioning technology with PU insulation.
- Properties:
- Material closed-cell polyurethane foam.
- Diffusion resistance 2500 K.
- Density 80 kg/m³.
- Compressive strength 0.6 N/mm².
- Heat conductivity (at 0°C) 0.030 W/(m*K).
- Locking screw: Flat head screw with combination recessed head.
- Temperature range - 40 °C to + 80 °C.
- Fire behavior: DIN 4102: class B2.

Channel

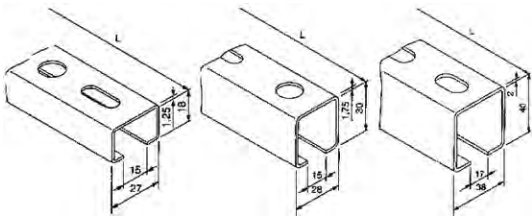

Technical Data

Profile	B	Channel	H	L	ly	lz	P ₁	P ₂	Wx
27/18	27	27/18/1.25-2m	18	2000	0.36	0.96	0.84	1.25	0.34
28/30	28	28/30/1.75-2m	30	2000	1.77	2.09	1.59	1.75	1.02
38/40	38	38/40/2.00-2m	40	2000	5.39	6.18	2.55	2	2.4

Assembly sequence

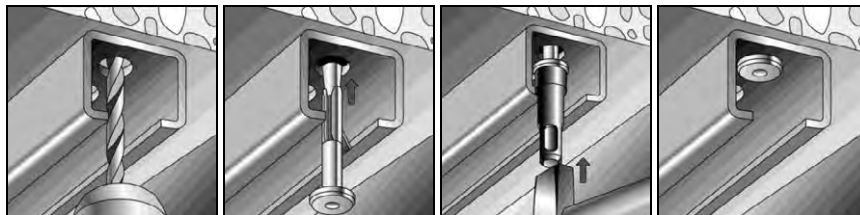

- Good fastening possibilities using suitable fixing.

64130 FISCHER Channel MS

N02A

Material Steel
Surface treatment Zinc plated

fischer
innovative solutions



B x H x L	⊗	Art.number	B x H x L	⊗	Art.number	B x H x L	⊗	Art.number
27/18 2000	1	64130.027.182	28/30 2000	1	64130.028.302	38/40 2000	1	64130.038.402

- Channel as C profile for the save installation of fastenings can be horizontally and vertically adjusted.
- Fast and streamlined fastening of pipe tracks and load-bearing constructions.
- Advantages / Benefits:
- High bending and pull-out strength due to optimized profile cross section.
- High flexibility due to different hole geometries.
- Versatile options for wall, floor and ceiling installation.
- Specially synchronised connection parts allow for assembly of simple, safe and versatile load bearing constructions.
- Simple cutting and installation due to stamped grid dimensions on the rail side.
- For fastening:
- Pipe tracks and pipe lines.
- Ventilation ducts.
- Material: Steel DX51D+Z 275 NA-C (material no. 1.0226+Z) acc. to DIN EN 10327.
- Zinc plating: Sendzimir zinc plated, approx. 20 µm.

Cantilever arm

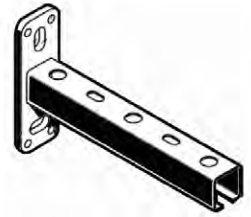
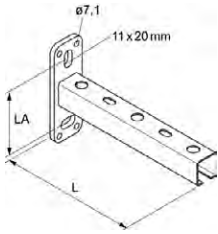

Technical Data

Profile x L	Base plate	Channel	L	LA
27/18-200	120 x 40 x 4	27/18	200	79
27/18-300	120 x 40 x 4	27/18	300	79
28/30-320	120 x 40 x 4	28/30	320	79
28/30-440	120 x 40 x 4	28/30	440	79
38/40-360	120 x 40 x 6	38/40	360	79
38/40-520	120 x 40 x 6	38/40	520	79
38/40-600	120 x 40 x 6	38/40	600	79

- LA = Hole spacing [mm].

Assembly data

- Good fastening possibilities using suitable fixing.
- Slots in the base plate offer good height adjustment.

64134 FISCHER Cantilever arm ALK

N02A

Material Steel
Surface treatment Zinc plated

fischer
innovative solutions



Profile x L	⊗	Art.number	Profile x L	⊗	Art.number	Profile x L	⊗	Art.number
ALK 38/40-600	10	64134.020.929	ALK 28/30-320	10	64134.079.578	ALK 38/40-360	10	64134.079.581
ALK 27/18-200	20	64134.079.575	ALK 28/30-440	10	64134.079.579	ALK 38/40-520	10	64134.079.582
ALK 27/18-300	20	64134.079.576						

- Channels as C profile with a welded base plate.
- Mainly for pipe mounting directly on the wall but also for fastenings and structures on the ceiling and in the floor area.
- ALK Q with base plate welded on laterally.
- Advantages / Benefits:
- Fast and simple installation of pipe lines.
- Stable base plate for load-bearing constructions.
- Versatile usage possibilities for stepped lengths.
- Slots in the rail offer versatile installation possibilities.
- For fastening:
- Pipe tracks and pipe lines.
- Ventilation ducts.
- Cable trays.
- Fittings and equipment.
- Properties:
- Zinc plating: Electro zinc plated, min. 8 µm.
- Material:
- Base plate: Steel DC01 (material no. 1.0330) acc. to DIN EN 10111.
- Channel: Steel S235JR (material no. 1.0037) acc. to DIN EN 1025.

Cover cap



64132 FISCHER Cover cap AK						N02A		
Material	Plastic Polyethylene							
Type	✉	Art.number	Type	✉	Art.number	Type	✉	Art.number
AK 27/18		100 64132.027.018	AK 28/30		100 64132.028.030	AK 38/40		50 64132.038.040

T-head bolt clix

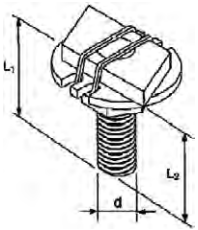

Technical Data			
d x L₁	Channel	L₁	L₂
M8x30	27/18+28/30+30/15	30	25
M8x40	27/18+28/30+30/15	40	35

Assembly sequence

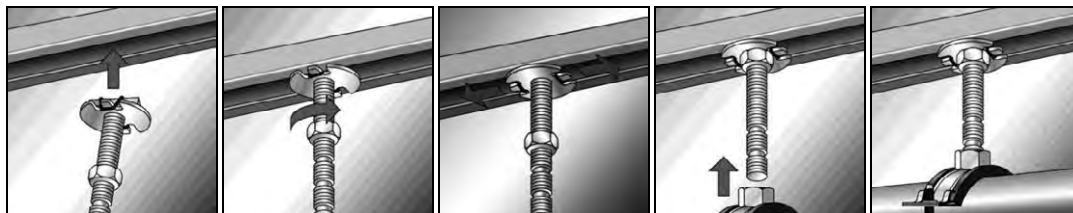

- Introduce T-head bolt into the rail or bracket and turn.
- After the alignment, the T-head bolt should be secured with the nut.

64162 FISCHER T-head bolt FHS clix						N02A	
Material	Steel						
Surface treatment	Zinc plated						
d x L₁	✉	Art.number	d x L₁	✉	Art.number		
8X30		100 64162.080.030	8X40		100 64162.080.040		

64162 FISCHER T-head bolt FHS clix ←

- FHS Clix N – patented T-head bolt with grooved pin.
- Grooved pin can be shortened using bolt cutter.
- FHS Clix – for small rail profiles (27/18, 28/30, 30/15)
- Advantages / Benefits:
- Patented safety mechanism.
- Simple, fast and effective installation.
- Fewer individual parts than with previous fastening.
- Retrofitting in rails possible.
- Simple alignment in the rail.
- Fits in all the usual rail profiles with 15 mm slot width.
- As a connection element between:
- Rail load-bearing constructions and pipe clamps.
- Cantilever brackets and pipe clamps.
- Properties:
- Material: Steel DD11 (material no. 1.0332) acc. to DIN EN 10111.
- Zinc plating: Electro zinc plated, 8 µm.

Sliding nut

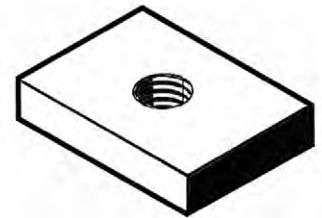
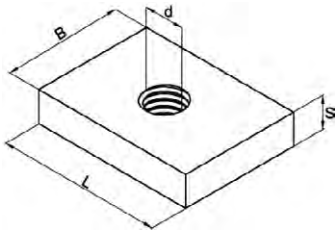

Technical Data

d	B	Channel	L	S
M8	23	27/18+28/30+30/15+38/40+40/60+40/120	33	6
M10	23	27/18+28/30+30/15+38/40+40/60+40/120	33	6

- Fastening elements for MS rails.
- Advantages / Benefits:
- Simple installation.
- Simple alignment in the rail.
- Fits in all the usual MS rail profiles with 15 mm and 17 mm slot width.
- As connecting element between:
- Rail load-bearing constructions and pipe clamps.
- Cantilever brackets and pipe clamps.

Assembly data

- After alignment, the threaded plate should be secured with the nut.

64168 FISCHER Sliding nut SM N02A

Material Steel
Surface treatment Zinc plated



Type	☒	Art.number	Type	☒	Art.number
38 M8	50	64168.080.001	38 M10	50	64168.100.001

Channel washer

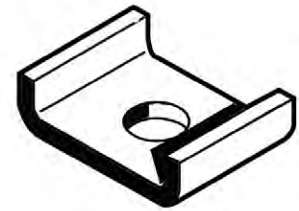
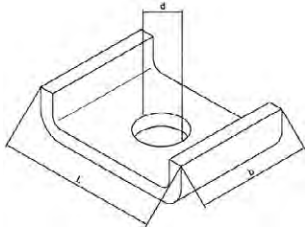

Technical Data

Type	b	Channel	L	ø d
HK27	33	27/18+28/30+30/15	25	11.5
HK38	33	38/40	40	12.5

64158 FISCHER Channel washer HK

N02A

Material Steel
Surface treatment Zinc plated

fischer
innovative solutions



Type	☒	Art.number	Type	☒	Art.number
27	50	64158.270.001	38	50	64158.380.001

- The channel washer can be used for proper fastening with a fixing, e.g. fischer anchor bolt.
- Used to secure connections.
- Advantage / Benefit:
- Prevents the rail from bending.
- For fastening:
- Channels.
- Components on channels.

T-head bolt

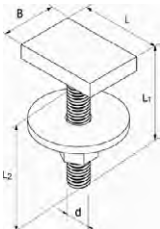

Technical Data

d x L ₁	B	Channel	d	L	L ₁	L ₂	S
M8x30	24	27/18+28/30+30/15+38/40+40/60+40/120	M8	30	30	24	6
M8x40	24	27/18+28/30+30/15+38/40+40/60+40/120	M8	30	40	34	6
M10x30	24	27/18+28/30+30/15+38/40+40/60+40/120	M10	30	30	24	6
M10x40	24	27/18+28/30+30/15+38/40+40/60+40/120	M10	30	40	34	6

- T-head bolt for all standard rail profiles with 15 mm and 17 mm slot width.
- Advantages / Benefits:
- Simple, fast and effective installation.
- Fewer individual parts than with traditional fixings.
- Simple alignment in the rail.
- As connection element between:
- Rail load-bearing constructions and pipe clamps.
- Cantilever brackets and pipe clamps.

Assembly data

- Introduce the T-head bolt into the rail or bracket from the side.
- After alignment, the T-head bolt should be secured with the nut.

64163 FISCHER T-head bolt HS 38		N02A
Material	Steel	  
Surface treatment	Zinc plated	

Type	☒	Art.number	Type	☒	Art.number	Type	☒	Art.number
38 M8X30	50	64163.080.030	38 M10X30	50	64163.100.030	38 M10X40	50	64163.100.040
38 M8X40	50	64163.080.040						

Installation angle bracket

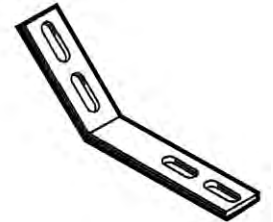
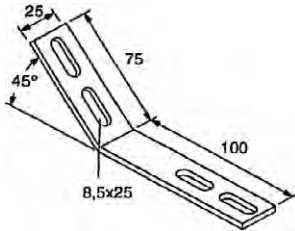

Technical Data

Type	Angle	B	Channel	H	L	S
MW27-45°	45°	25	27/18+28/30+30/15	75	100	4
MW27-90°	90°	25	27/18+28/30+30/15	75	80	4
MW38-45°	45°	40	38/40+41/21+41/41+40/60+40/120	75	105	6
MW38-90°	90°	40	38/40+41/21+41/41+40/60+40/120	85	105	6

Assembly data

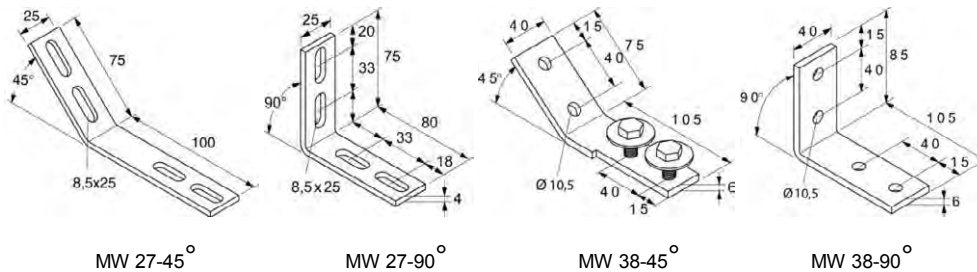

- Good fixing possibilities using suitable anchor.
- To simplify installation, the installation angle bracket MW 38-45° is supplied with pre-mounted clamping screw.

64144 FISCHER Installation angle bracket MW		N02A
Material	Steel	  
Surface treatment	Zinc plated	

Type	☒	Art.number	Type	☒	Art.number	Type	☒	Art.number
27-45	25	64144.027.045	38-45	10	64144.038.045	38-90	20	64144.038.090
27-90	25	64144.027.090						

- Installation angle brackets are support elements for use with load-bearing constructions that should not be welded.
- Installation angle brackets are used to reinforce load-bearing constructions.
- Advantages / Benefits:
- Installation advantages in producing load-bearing constructions in connection with fischer mounting rails.
- No welding necessary.
- System component can be used in many ways.
- Variable installation possibilities.
- For producing:
- Rail load-bearing structures.
- Traverses.
- Projections.
- Supports.
- Properties:
- Material: Steel S235 JR (material no. 1.0037) acc. to DIN EN 10025.
- Zinc plating: Electro zinc plated, 8 µm.

Angle bracket

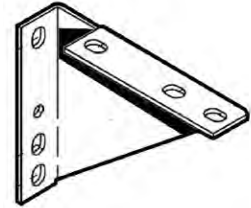
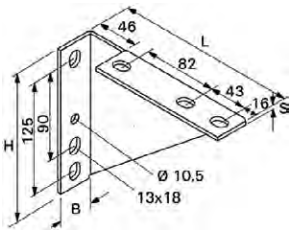

Technical Data

Type	B	Channel	H	L	S
207/165	40	38/40+41/21+41/41+40/60+40/120	165	207	4

Assembly data

- Good fixing possibility using suitable anchor.
- Thanks to bolting two angle brackets, significantly higher load and bending values are achieved.

64136 FISCHER Angle bracket WK		N02A
Material	Steel	
Surface treatment	Zinc plated	

Type	Art.number
207/165	6 64136.207.165

- Stable angle bracket for fixing pipe lines and components.
- The angle bracket acts as a reinforcement for load-bearing constructions.
- Advantages/Benefits:
- Versatile possibilities for wall, floor and ceiling installation, can be used in shafts and also free-standing.
- In combination with fischer mounting rails, the universal bracket produces a load-bearing construction with very high stability and safety.
- For producing:
- Rail load-bearing structures, traverses, projections
- For fastening:
- Pipe tracks and pipe lines, pipe line components such as fittings, water meters.
- Properties:
- Material: Steel DD11 (material no. 1.0332) acc. to DIN EN 10111.
- Zinc plating: Electro zinc plated, 8 µm.

Saddle flange

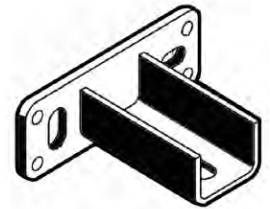
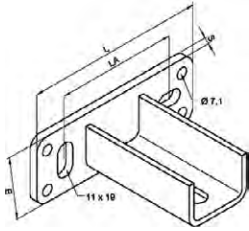



Technical Data

Type	B	Channel	L	LA	S
SF Q 27	40	27/18+28/30+30/15	125	84	5
SF Q 38	50	38/40+41/21+41/41+40/60+40/120	136	95	6

Assembly data

- Insert and screw the mounting rail in the saddle flange.
- Good fixing possibility using suitable anchor.
- Good height adjustment using slots in the base plate.

64140	FISCHER Saddle flange SF Q	N02A
Material	Steel	
Surface treatment	Zinc plated	
		 

Type	☒	Art.number	Type	☒	Art.number
Q27	15	64140.270.001	Q38	10	64140.380.001

- Connecting element for producing robust constructions in connection with the fischer mounting rails.
- Advantages / Benefits:
- Solid connecting element for load-bearing constructions.
- Simple installation by inserting the mounting rail in the saddle.
- For producing:
- Rail load-bearing structures.
- Traverses.
- Projections.
- Properties:
- Material:
- Base plate: Steel DD11 (material no. 1.0332) acc. to DIN EN 10111.
- U-Profil: S235JR acc. to DIN EN 10025.
- Zinc plating: Electro zinc plated, 8 µm.

Beam clamp

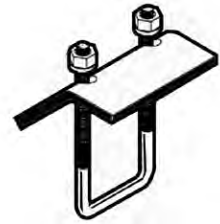
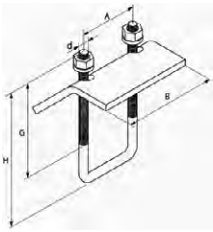

Technical Data

Type	A	B	Channel	d	G	Grip range	H	N
TKR27/18	37	60	27/18+28/30	M6	60	0-29	81	2.8
TKR38/40	47	70	38/40	M8	55	0-24.5	86	5.40

- N = Max. recom. static load (centr. tension) [kN].

Assembly data

- Two clamp supports are necessary for fastening to the steel girder.

64154 FISCHER Beam clamp TKR

N02A

Material Steel
Surface treatment Zinc plated

fischer 
innovative solutions



Type	Art.number
27/18	25 64154.027.018

- Stirrup for fastening profile rails to steel girders.
- Advantages / Benefits:
- No drilling or welding necessary.
- Adjustment is possible at any time.
- Due to the different lengths of the claw sides, the fischer clamp supporter can be fastened to all standard T-beams.
- For fastening rails to steel girders

Channel connector

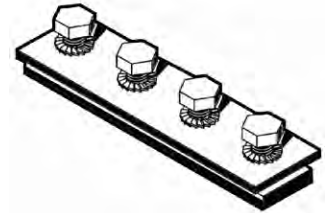
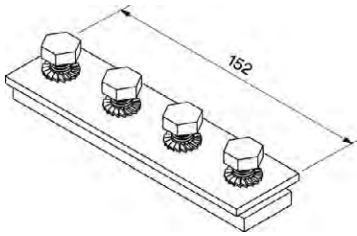

Technical Data

Type	Channel	Type	Channel
SV27	27/18+28/30	SV38	38/40

Assembly sequence

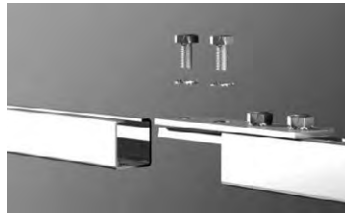

- The channel connectors are inserted into the rail ends and then screwed tight.

64152 FISCHER Channel connector SV		N02A
Material	Steel	
Surface treatment	Zinc plated	

Type	Art.number	Type	Art.number
27	20 64152.270.001	38	10 64152.380.001

- Mounting rails can be connected and aligned precisely with the fischer channel connector.
- Advantages / Benefits.
- Robust and fast connection of mounting rails.
- Simple installation by sliding into the mounting rail.
- Screws enable secure connection.
- For producing:
- Channel connections.
- Properties:
- Material SV 27 / SV 38: Steel DC01 (material no. 1.0330) acc. to DIN EN 10130.
- Zinc plating: Electro zinc plated, 8 µm

Parallel connector





Technical Data

Type	d	N
PV M8	M8	2.00

- N = Max. recom. static load (centr. tension) [kN].

Assembly data

- Hold threaded parts together, slide parallel connector over.
- Secure using lock nut.
- Level adjustment is possible by turning the threaded pin.

64180 FISCHER Parallel connector PV		N02A
Material	Zamac 3	  

Type	Art.number
M8	100 64180.080.001

- Simply and quickly installed connector for extending and/or connecting threaded rods.
- Advantages / Benefits:
- Fast installation.
- Simple level adjustment possible.
- High load possible.
- Level adjustment even in installed position.
- Fast level adjustment of threaded rods or threaded pins.
- Properties:
- Material diecasting.

Clamp hanger

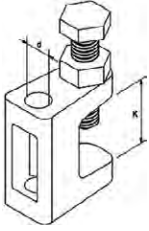

Technical Data

Type	d	K	N
TKL M8	M8	0-23	2.50
TKL ø9	ø9	0-18	1.20
TKL M10	M10	0-20	2.50
TKL ø11	ø11	0-20	2.50

- N = Max. recom. static load (centr. tension) [kN].

Assembly data

- Safety brackets necessary for VdS systems starting from DN 65.

64275	FISCHER Clamp hanger TKL	N02A
Material	Cast iron	 
Surface treatment	Zinc plated	
		

Type	☒	Art.number	Type	☒	Art.number	Type	☒	Art.number
TKL M8	50	64275.080.001	TKL M10	50	64275.100.001	TKL ø11	50	64275.110.001
TKL ø9	50	64275.090.001						

- Clamp hanger makes simple fastening possible by clamping to steel girders.
- Advantages / Benefits:
- High load-bearing capability.
- Simple and fast level adjustment.
- Level adjustment is also possible later with through-hole.
- VdS approval.
- Fastening on steel girder without welding and drilling.
- No slipping of the clamp from the steel girder.
- For fastening pipe lines, ventilation lines and sprinkler lines on steel girders.
- Properties:
- Material: Malleable cast iron EN-GJMB-350-10 acc. to DIN 1562.
- Zinc plating: Electro zinc plated, 8 µm.
- Bolt: Hexagonal bolt DIN 933.8.8, bolt end with cup point acc. to EN ISO 4753 and lock nut.

Perforated steel banding



Technical Data

Type	B	d	L	S
LBV 17	17	6.5	10	0.75
LBV 26	25	8.5	10	0.88

- To be fastened with: ED 15; ED 18; ED 22.

Assembly sequence

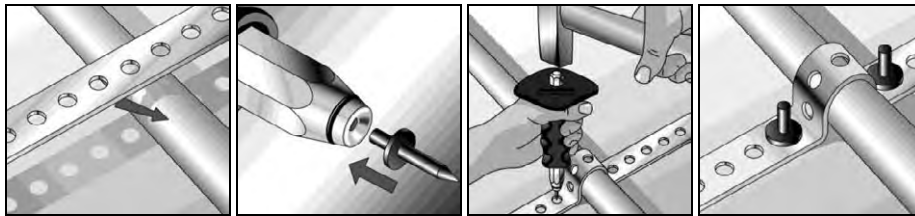

- Simple cutting to size possible with sheet metal shears.
- Floor fastening using the Fischer impact nail ED.
- For ceiling suspension in concrete, the Fischer nail anchor FNA II is recommended.

64272 FISCHER Perforated steel banding LBV

N02A

Material Steel
Surface treatment Zinc plated

fischer innovative solutions



Type	☒	Art.number	Type	☒	Art.number
17 (ROLL, 10 MTR)	1	64272.170.001	26 (ROLL, 10 MTR)	1	64272.260.001

- Steel band with stamped holes for simple installation in zinc plated or plastic coated version.
- Advantages/Benefits
- Advantageous, simple installation possible.
- Universal fastening possible.
- Flexible length selection.
- For fastening pipe lines on the floor or suspended from ceiling.
- Properties:
- Material: Steel DX51 D+Z (material no. 1.0226) acc. to DIN EN 10327.
- Zinc plating: sendzimir zinc plated, 5 - 27 µm.

Double connector plate

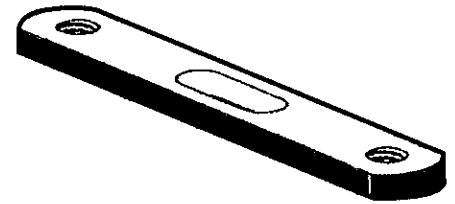

Technical Data

Type	L	M
DPP 65	65	M8
DPP 85	85	M8
DPF 60-105	105	M8

Assembly data

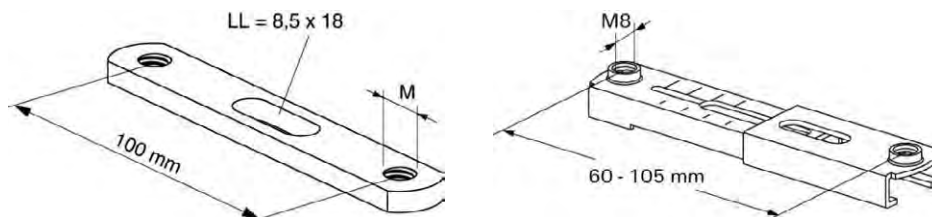

Article groups

Material	Surface treatment	Code	Page
St	Zipl	64271	10-52
St	Zipl	64270	10-52

64271 FISCHER Double connector plate DPP N02A

Material Steel
Surface treatment Zinc plated

fischer
innovative solutions



L	☒	Art.number	L	☒	Art.number
DPP 65	50	64271.000.065	DPP 85	50	64271.000.085

- Fastening element for installation of two parallel pipe lines with only one fastening point.
- Advantages/Benefits:
- Only one fastening point for two pipe lines.
- Very good for visible installation.
- Adjusting possibility due to slot.
- For fastening:
- Parallel pipe lines on the wall.
- Properties:
- Material: Steel DD11 (material no. 1.0332) acc. to DIN EN 10111.
- Zinc plating: Electro zinc plated, 5 - 9 µm.

64270 FISCHER Double connector plate DPF N02A

Material Steel
Surface treatment Zinc plated

fischer
innovative solutions

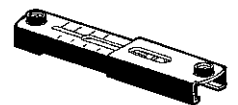

L	☒	Art.number
DPF 60-105	50	64270.060.105

64270 FISCHER Double connector plate DPF

- Fastening element for installation of two parallel pipe lines with only one fastening point.
- Advantages/Benefits:
- Only one fastening point for two pipe lines.
- Very good for visible installation.
- Adjusting possibility due to slot.
- Variable pipe spacing with double connecting plate DPF.
- For fastening:
- Parallel pipe lines on the wall.
- Properties:
- Material: Steel DD11 (material no. 1.0332) acc. to DIN EN 10111.
- Zinc plating: Electro zinc plated, 5 - 9 µm.

Bolt connector

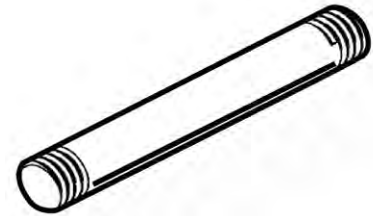
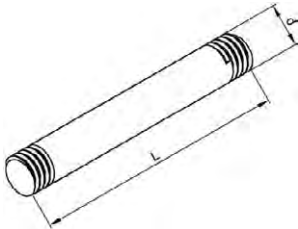

Technical Data

Type	d	L
SBB 35	M8	35
SBB 55	M8	55

64273 FISCHER Bolt connector SBB
N02A

Material Steel
Surface treatment Zinc plated

fischer
innovative solutions



d x L	✉	Art.number	d x L	✉	Art.number
35	100	64273.080.035	55	100	64273.080.055

- Ideal connecting element for double connector plates and multi-connectors.
- Properties:
- Material: Steel S235 JR (material no. 1.0037) acc. to DIN EN 10025.
- Zinc plating: Electro zinc plated, 8 µm.

Fabory Fastclip fixing system

General

The Fabory Fastclip fixing system consists of a basic clip, which can be installed trouble-free on steel structures either as a single hanger or in combination with accessories, simply by hand or using handtools like a hammer, combination pliers, screwdriver. Considerable savings of costs and time can be achieved.

Application

Fabory Fastclip fixing clips with their various combination possibilities are widely used in the general building industry, e.g. in the electrotechnical installation technics, ceiling-, sanitary-, air conditioning- and heating industry.

Standardisation

The Fabory Fastclip fixing system has been tested in accordance to DIN 18168.

Loads

Load rating of these fasteners is expressed in Newton as static load limit. Values indicate maximum allowable installed loads for user applications. Static load limit is a rated stationary load limit for a fastener. Ultimate static load limit is the rated stationary load limit which, if exceeded, may cause failure of fastener. These values are for loads applied vertically to the normal fastener installation. When load rating of the fasteners exceeds that of the structural member, the lowest rated item must set the load limit. Fabory Fastclip fixing clips are punched out of spring steel and hardened.

Surface treatment

Fabory Fastclip fixing clips are treated with an anticorrosion layer named Deltatone, layer thickness 10-12 µm (corrosion resistance in saltspray test acc. to ASTM B117/DIN 50021 ca. 480 hours). Deltatone eliminates the possibility of fracture due to hydrogen embrittlement!

Application example

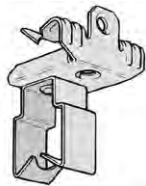

Type 50 H + 75 H

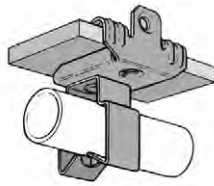

Type CC

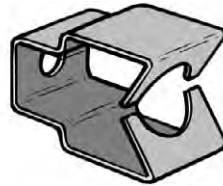

Type CR

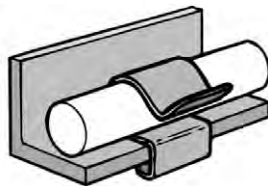

Type PF



Type H



Type MC

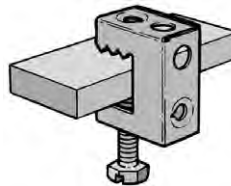

Type RH



Type BC

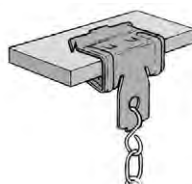

Type BCC

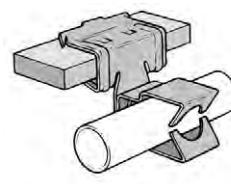

Universal beam clamp

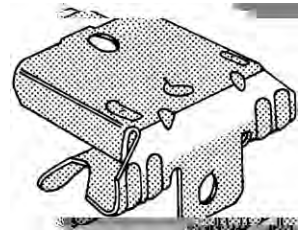

Technical Data

Type	Allowable static load	Flange thickness
H2-4	450 N (3:1)	3-7
H5-8	450 N (3:1)	8-12.5

- For technical data, examples of application and technical data concerning DELTATONE, see INFO page.

60319 FASTCLIP Universal beam clamp type H

S06A

Material Spring steel
Surface treatment Deltatone

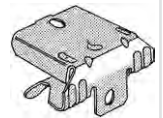

Type	Art.number	Type	Art.number
H 2-4	100 60319.002.004	H 5-8	100 60319.005.008

Universal beam clip/conduit clip combination

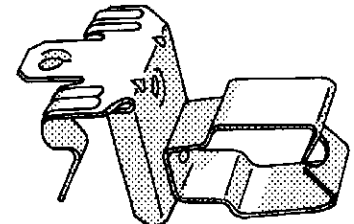

Technical Data

Type	Conduit size	Flange thickness	Max. static load
50H2-4	20	3-7	110 N (3:1)
50H5-8	20	8-12.5	110 N (3:1)
75H2-4	25	3-7	110 N (3:1)
75H5-8	25	8-12.5	110 N (3:1)

- For technical data, examples of application and technical data concerning DELTATONE, see INFO page.

60321 FASTCLIP Universal beam clip/conduit clip combination

S06A

Material Spring steel
Surface treatment Deltatone

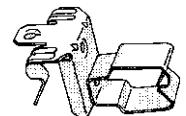

Type	Art.number	Type	Art.number	Type	Art.number
50H 2-4	50 60321.502.004	75H 2-4	100 60321.752.004	75H 5-8	50 60321.755.008
50H 5-8	50 60321.505.008				

10

Beam clip type BC

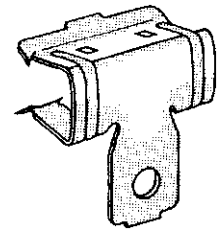

Technical Data

Type	Allowable static load	Flange thickness
BC-250	900 N (3:1)	5-9
BC-500	900 N (3:1)	10-16
BC-750	900 N (3:1)	17-20

• For technical data, examples of application and technical data concerning DELTATONE, see INFO page.

60311 FASTCLIP Beam clip type BC S06A

Material Spring steel
Surface treatment Deltatone



Type	Art.number	Type	Art.number	Type	Art.number
BC-250	100 60311.000.250	BC-500	100 60311.000.500	BC-750	100 60311.000.750

Beam clip/conduit clip combination (snap-in) type BCC

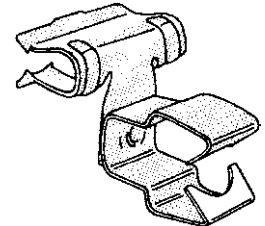

Technical Data

Type	Conduit size	Flange thickness	Max. static load
BCC 25-50	20	5-9	110 N (3:1)
BCC 50-50	20	10-16	110 N (3:1)
BCC 25-75	25	5-9	110 N (3:1)
BCC 50-75	25	10-16	110 N (3:1)
BCC 25-100	32	5-9	110 N (3:1)
BCC 50-100	32	10-16	110 N (3:1)

• For technical data, examples of application and technical data concerning DELTATONE, see INFO page.

60313 FASTCLIP Beam clip/conduit clip combination (snap-in) type BCC S06A

Material Spring steel
Surface treatment Deltatone

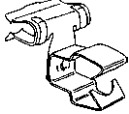
Type	Art.number	Type	Art.number	Type	Art.number
BCC 25-50	100 60313.025.050	BCC 25-100	50 60313.025.100	BCC 50-75	50 60313.050.075
BCC 25-75	100 60313.025.075	BCC 50-50	100 60313.050.050	BCC 50-100	50 60313.050.100

Beam clip/threaded rod hanger combination type RH

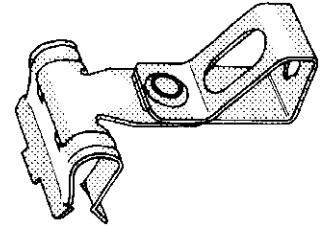

Technical Data

Type	Allowable static load	Flange thickness	Stud
RH-6MT/25	680 N (3:1)	5-9	M6
RH-6MT/50	680 N (3:1)	10-16	M6
RH-6MT/75	680 N (3:1)	17-20	M6
RH-8MT/25	680 N (3:1)	5-9	M8
RH-8MT/50	680 N (3:1)	10-16	M8
RH-8MT/75	680 N (3:1)	17-20	M8
RH-10MT/25	680 N (3:1)	5-9	M10
RH-10MT/50	680 N (3:1)	10-16	M10
RH-10MT/75	680 N (3:1)	17-20	M10

- For technical data, examples of application and technical data concerning DELTATONE, see INFO page.

60315 FASTCLIP Beam clip/threaded rod hanger combination type RH

S06A

Material Spring steel
Surface treatment Deltatone

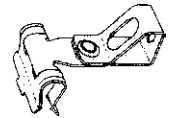

Type	☒	Art.number	Type	☒	Art.number	Type	☒	Art.number
RH-6MT/25	100	60315.060.025	RH-8MT/25	100	60315.080.025	RH-10MT/25	100	60315.100.025
RH-6MT/50	100	60315.060.050	RH-8MT/50	50	60315.080.050	RH-10MT/50	100	60315.100.050
RH-6MT/75	100	60315.060.075	RH-8MT/75	100	60315.080.075	RH-10MT/75	100	60315.100.075

Push fastener type PF

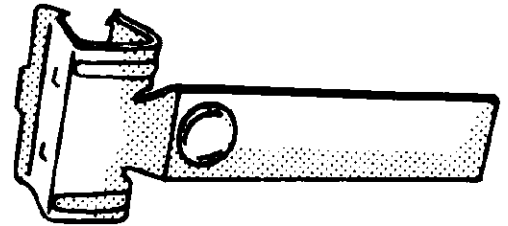

Technical Data

Type	Flange thickness
PF-250	5-9
PF-500	10-16

• For technical data, examples of application and technical data concerning DELTATONE, see INFO page.

60317 FASTCLIP Push fastener type PF S06A

Material Spring steel
Surface treatment Deltatone

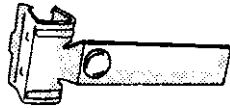
Type	Art.number	Type	Art.number
PF-250	100 60317.000.250	PF-500	50 60317.000.500

Snap-in conduit/pipe clip type CC



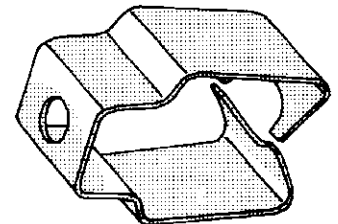

Technical Data

Type	Conduit size	Max. static load	Screw ø
CC-500	20	110 N (3:1)	6
CC-750	25	110 N (3:1)	6
CC-1000	32	110 N (3:1)	6

• For technical data, examples of application and technical data concerning DELTATONE, see INFO page.

60325 FASTCLIP Snap-in conduit/pipe clip type CC S06A

Material Spring steel
Surface treatment Deltatone

Type	Art.number	Type	Art.number	Type	Art.number
CC-500	100 60325.000.500	CC-750	100 60325.000.750	CC-1000	100 60325.001.000

10

Master clamp type MC

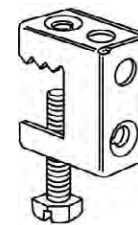
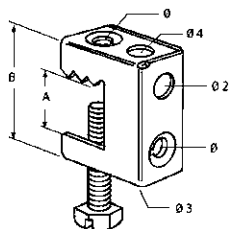

Technical Data

Type	A	Allowable static load	B	ø	ø 2	ø 3	ø 4
MC	2-18	450 N	35	M6	6.5	11	6.5

- For technical data, examples of application and technical data concerning DELTATONE, see INFO page.

60323 FASTCLIP Master clamp type MC

S06A

Material Spring steel
Surface treatment Deltatone



Type	Art.number
MC	100 60323.001.770

- Incl. hexagon screw.

Cable run clip type CR

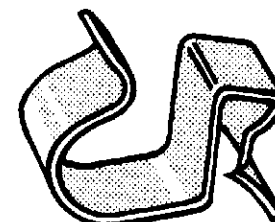

Technical Data

Type	Flange thickness	For cable
CR-215	2-4	15-18
CR-219	2-4	19-24
CR-225	2-4	25-30
CR-412	4-7	12-14
CR-415	4-7	15-18
CR-419	4-7	19-24
CR-812	8-12	12-14
CR-815	8-12	15-18
CR-819	8-12	19-24
CR-825	8-12	25-30

- For technical data, examples of application and technical data concerning DELTATONE, see INFO page.

60331 FASTCLIP Cable run clip type CR

S06A

Material Spring steel
Surface treatment Deltatone



Type	Art.number	Type	Art.number	Type	Art.number
CR-215	100 60331.000.215	CR-415	100 60331.000.415	CR-815	100 60331.000.815
CR-219	100 60331.000.219	CR-419	100 60331.000.419	CR-819	100 60331.000.819
CR-225	100 60331.000.225	CR-812	100 60331.000.812	CR-825	100 60331.000.825
CR-412	100 60331.000.412				

FABORY QUICK SYSTEM

Toggle latches

Application

FABORY toggle latches have a place of importance in the FABORY QUICK SYSTEM, their wide applicability varies from, for example the closing of the covers of simple wooden component cases to the efficient securing of the engine compartments of agricultural machinery.

Assembly

The principle of operation of the FABORY QUICK SYSTEM toggle latches is identical, regardless of the size, the lockability and the adjustability. The toggle itself is fastened to one side of the component and the strike is fastened to the other part. For closing the construction, the toggle is pulled over the strike and is tensioned by lowering the latch. Off-centring of the pivot point and the gripping point of the toggle in the strike ensures that the latch cannot unclutch. The closure spring is generally slightly bent and absorbs a great deal of the closing force despite small tolerances in the mounting in or on the various parts.

Presentation

Since experience has taught that the available mounting space generally determines the final choice of the FABORY QUICK SYSTEM toggle latch, the following presentation of the extensive toggle latch product range is given in order of physical size, therefore see details of the smallest models first and largest models are described last. A distinction is also made between the steel models and the stainlesssteel models. In each presentation is tried to give an overview of all the relevant information in such a way that it can be read at one glance.

Special data

A number of specific data is given for each FABORY QUICK SYSTEM toggle latch such as the load data, the standard finish and, where relevant, the specific properties of the closure such as its adjustability and the possibility for locking if you require more protection against unwanted opening of the toggle latch.

Strikes

The mounting preparation information assumes the use of the indicated toggle latch in combination with the recommended strike. The use of alternative strikes is of course possible, the right mounting preparation of the parts must then be determined by trial.

Specials

Depending on the application, special toggle latches, other shapes of strikes, different finishes etc. are available on request.

Example of application

















Toggle latch











Article groups



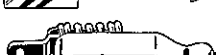





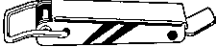

Material	Surface treatment	Code	Page
St	Zipl	62255	10-61
St.St. A2		62257	10-62

62255 QUICK SYSTEM Toggle latch		S04A
Material	Steel	 
Surface treatment	Zinc plated	

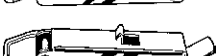
No.	✉	Art.number		
2.00.00.04/6	5	62255.200.004	<ul style="list-style-type: none"> Max. allowable load 2000 N Min. breaking force 4000 N Size length x width x height : 131 x 43 x 19 mm 	
2.00.01.04/6	5	62255.200.104	<ul style="list-style-type: none"> Padlockable. Max. allowable load 2000 N. Min. breaking force 4000 N. Size length x width x height : 131 x 43 x 30,5 mm. 	
2.01.00.04/6	10	62255.201.004	<ul style="list-style-type: none"> Max. allowable load 1500 N. Min. breaking force 3000 N. Size length x width x height : 101 x 34 x 12,5 mm. 	
2.02.00.04/6	10	62255.202.004	<ul style="list-style-type: none"> Max. allowable load 400 N. Min. breaking force 1000 N. Size length x width x height : 52 x 21 x 10,7 mm. 	
2.03.00.04/6	10	62255.203.004	<ul style="list-style-type: none"> Max. allowable load 550 N. Min. breaking force 1500 N. Size length x width x height : 75 x 23 x 11 mm. 	
2.03.02.04/6	10	62255.203.204	<ul style="list-style-type: none"> With secondary lock Max. allowable load 550 N Min. breaking force 1500 N Size length x width x height : 75 x 23 x 11 mm 	
2.04.00.04/6	10	62255.204.004	<ul style="list-style-type: none"> Max. allowable load 550 N Min. breaking force 1500 N Size length x width x height : 42,5 x 41 x 12 mm 	
2.05.00.04/6	5	62255.205.004	<ul style="list-style-type: none"> 12 mm adjustable Max. allowable load 1100 N Min. breaking force 2500 N Size length x width x height : 128 x 52 x 18 mm 	
2.06.00.04/6	10	62255.206.004	<ul style="list-style-type: none"> Max. allowable load 1000 N Min. breaking force 2500 N Size length x width x height : 84 x 28 x 17 mm 	
2.06.01.04/6	10	62255.206.104	<ul style="list-style-type: none"> Padlockable Max. allowable load 1000 N Min. breaking force 2500 N Size length x width x height : 84 x 28 x 17 mm 	
2.07.00.04	10	62255.207.004	<ul style="list-style-type: none"> Closure spring grips the construction part directly Fastening by welding or spot welding Max. allowable load 300 N Min. breaking force 600 N Size length x width x height : 81 x 29 x 18 mm 	
2.08.00.04	10	62255.208.004	<ul style="list-style-type: none"> Closure spring grips the construction part directly Max. allowable load 500N Min. breaking force 900 N Size length x width x height : 90 x 20 x 17 mm 	
2.17.00.04/6	10	62255.217.004	<ul style="list-style-type: none"> Max. allowable load 400 N Min. breaking force 1000 N Size length x width x height : 51 x 22 x 12,5 mm 	
2.18.00.04/6	5	62255.218.004	<ul style="list-style-type: none"> 12 mm adjustable Max. allowable load 1500 N Min. breaking force 3000 N Size length x width x height : 88 x 52 x 26 mm 	
2.18.01.04/6	5	62255.218.104	<ul style="list-style-type: none"> 12 mm adjustable Padlockable Max. allowable load 1500 N Min. breaking force 3000 N Size length x width x height : 88 x 52 x 25 mm 	

62255 QUICK SYSTEM Toggle latch		←		
No.	☒	Art.number		
2.19.00.04	5	62255.219.004	<ul style="list-style-type: none"> • Closure spring grips the construction part directly • Max. allowable load 750 N • Min. breaking force 1500 N • Size length x width x height : 128,5 x 28,5 x 27 mm 	
2.40.00.04/6	5	62255.240.086	<ul style="list-style-type: none"> • 15 mm adjustable • Max. allowable load 2000 N • Min. breaking force 4000 N • Size length x width x height : 131,5 x 45,5 x 23 mm 	
2.41.00.04/6	10	62255.241.086	<ul style="list-style-type: none"> • 10 mm adjustable • Max. allowable load 1000 N • Min. breaking force 2000 N • Size length x width x height : 70 x 25,5 x 18 mm 	
2.41.01.04/6	10	62255.241.186	<ul style="list-style-type: none"> • 10 mm adjustable • Padlockable • Max. allowable load 1000 N • Min. breaking force 2000 N • Size length x width x height : 70 x 25,5 x 18,5 mm 	
2.42.00.04/6	10	62255.242.086	<ul style="list-style-type: none"> • With tension springs • Max. allowable load 500 N • Min. breaking force 1500 N • Size length x width x height : 54 x 37 x 12,5 mm. 	
2.43.00.04/6	10	62255.243.086	<ul style="list-style-type: none"> • Max. allowable load 550 N • Min. breaking force 1500 N • Size length x width x height : 45 x 23 x 12 mm 	
2.45.00.04/6	10	62255.245.086	<ul style="list-style-type: none"> • Max. allowable load 150 N • Min. breaking force 300 N • Size length x width x height : 32 x 16 x 6 mm 	

62257 QUICK SYSTEM Toggle latch		S04A
Material	Stainless steel A2	
		

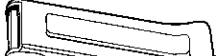
No.	☒	Art.number		
2.00.00.30/6	5	62257.200.030	<ul style="list-style-type: none"> • Max. allowable load 2000 N • Min. breaking force 4000 N • Size length x width x height : 131 x 43 x 19 mm 	
2.00.02.30/6	5	62257.200.230	<ul style="list-style-type: none"> • With secondary lock • Max. allowable load 2000 N • Min. breaking force 4000 N • Size length x width x height : 131 x 43 x 19 mm 	
2.01.00.30/6	10	62257.201.030	<ul style="list-style-type: none"> • Max. allowable load 1500 N • Min. breaking force 3000 N • Size length x width x height : 101 x 34 x 12,5 mm 	
2.02.00.30/6	10	62257.202.030	<ul style="list-style-type: none"> • Max. allowable load 400 N • Min. breaking force 1000 N • Size length x width x height : 52 x 21 x 10,7 mm 	
2.03.00.30/6	10	62257.203.030	<ul style="list-style-type: none"> • Max. allowable load 550 N • Min. breaking force 1500 N • Size length x width x height : 75 x 23 x 11 mm 	
2.03.02.30/6	10	62257.203.230	<ul style="list-style-type: none"> • With secondary lock • Max. allowable load 550 N • Min. breaking force 1500 N • Size length x width x height : 75 x 23 x 11 mm 	
2.04.00.30/6	10	62257.204.030	<ul style="list-style-type: none"> • Max. allowable load 550 N • Min. breaking force 1500 N • Size length x width x height : 42,5 x 41 x 12 mm 	
2.05.00.30/6	5	62257.205.030	<ul style="list-style-type: none"> • 12 mm adjustable • Max. allowable load 1100 N • Min. breaking force 2500 N • Size length x width x height : 128 x 52 x 18 mm 	
2.05.02.30/6	10	62257.205.230	<ul style="list-style-type: none"> • 12 mm adjustable • With secondary lock • Max. allowable load 1100 N • Min. breaking force 2500 N • Size length x width x height : 128 x 52 x 18 mm 	
2.06.00.30/6	10	62257.206.030	<ul style="list-style-type: none"> • Max. allowable load 1000 N • Min. breaking force 2500 N • Size length x width x height : 84 x 28 x 17 mm 	
2.06.01.30/6	10	62257.206.130	<ul style="list-style-type: none"> • Padlockable • Max. allowable load 1000 N • Min. breaking force 2500 N • Size length x width x height : 84 x 28 x 17 mm 	
2.18.00.30/6	5	62257.218.030	<ul style="list-style-type: none"> • 12 mm adjustable • Max. allowable load 1500 N • Min. breaking force 3000 N • Size length x width x height : 88 x 52 x 25 mm 	

62257 QUICK SYSTEM Toggle latch				←
No.	☒	Art.number		
2.41.00.30/6	10	62257.241.030	<ul style="list-style-type: none"> • 10 mm adjustable • Max. allowable load 1000 N • Min. breaking force 2000 N • Size length x width x height : 70 x 25,5 x 18 mm 	
2.43.00.30/6	10	62257.243.030	<ul style="list-style-type: none"> • Max. permitted load 550 N (120 lb). Min. breaking strength 1500 N (340 lb). • Dimensions length x width x height: 45 x 23 x 12 mm. 	

Strike for toggle latch

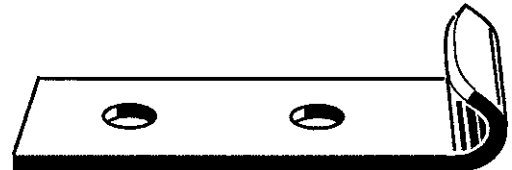

Article groups			
Material	Surface treatment	Code	Page
St	Zipl	62265	10-63
St.St.		62267	10-64

62265 QUICK SYSTEM Strike for toggle latch		S04A
Material	Steel	
Surface treatment	Zinc plated	

No.	☒	Art.number		
2.00.00.04/5	5	62265.200.004	<ul style="list-style-type: none"> • Suitable for toggle latches type 2.00.00.04/6 and 2.00.01.04/6 	
2.01.00.04/5	5	62265.201.004	<ul style="list-style-type: none"> • Suitable for toggle latches type 2.01.00.04/6 	
2.02.00.04/5	10	62265.202.004	<ul style="list-style-type: none"> • Suitable for toggle latches type 2.02.00.04/6 	
2.03.00.04/5	10	62265.203.004	<ul style="list-style-type: none"> • Suitable for toggle latches type 2.03.00.04/6 and 2.03.02.04/6 	
2.04.00.04/5	10	62265.204.004	<ul style="list-style-type: none"> • Suitable for toggle latches type 2.04.00.04/6 	
2.05.00.04/5	5	62265.205.004	<ul style="list-style-type: none"> • Suitable for toggle latches type 2.02.00.04/6, 2.06.00.04/6 and 2.06.01.04/6 	
2.18.00.04/5	5	62265.218.004	<ul style="list-style-type: none"> • Suitable for toggle latches type 2.18.00.04/6 and 2.18.01.04/6 	
2.40.00.08/5	5	62265.240.008	<ul style="list-style-type: none"> • Suitable for toggle latches type 2.40.00.08/6 and 2.40.01.08/6 	

62265 QUICK SYSTEM Strike for toggle latch		←
No.	✉ Art.number	
2.41.00.08/5	10 62265.241.008	• Suitable for toggle latches type 2.41.00.08/6 and 2.41.01.08/6
2.42.00.08/5	10 62265.242.008	• Suitable for toggle latches type 2.42.00.08/6 and 2.43.00.08/6
2.44.00.08/5	10 62265.244.008	• Suitable for toggle latches type 2.45.00.08/6 and 2.17.00.04/6

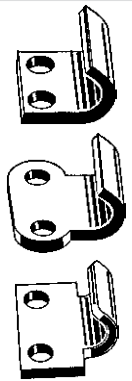

62267 QUICK SYSTEM Strike for toggle latch		S04A
Material	Stainless steel	

No.	✉ Art.number	
2.00.00.30/5	5 62267.200.030	• Suitable for toggle latches type 2.00.00.30/6 and 2.00.02.30/6
2.01.00.30/5	5 62267.201.030	• Suitable for toggle latches type 2.01.00.30/6
2.02.00.30/5	10 62267.202.030	• Suitable for toggle latches type 2.02.00.30/6
2.03.00.30/5	10 62267.203.030	• Suitable for toggle latches type 2.03.00.30/6 and 2.03.02.30/6
2.04.00.30/5	10 62267.204.030	• Suitable for toggle latches type 2.04.00.30/6
2.05.00.30/5	5 62267.205.030	• Suitable for toggle latches type 2.05.00.30/6, 2.05.02.30/6, 2.06.00.30/6 and 2.06.01.30/6
2.18.00.30/5	5 62267.218.030	• Suitable for toggle latches type 2.18.00.30/6
2.41.00.30/5	10 62267.241.030	• Suitable for toggle latches type 2.41.00.30/6
2.42.00.30/5	10 62267.242.030	• Suitable for toggle latches type 2.43.00.30/6

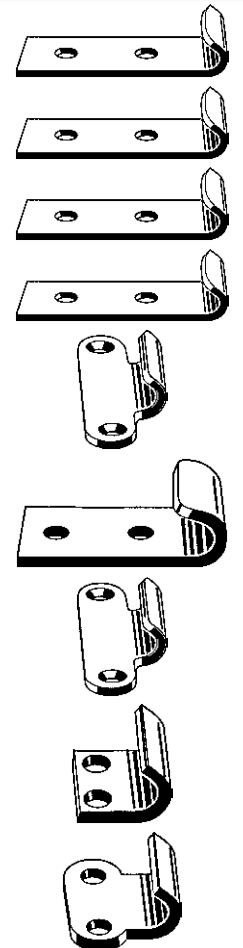

10

FABORY QUICK SYSTEM

Pawl latches

Application

FABORY QUICK SYSTEM pawl latches are mainly used for locking installation boxes, cabinet doors, machinery cabinets etc.

Assembly

The FABORY QUICK SYSTEM pawl latch locking is mounted on the panel or door. On operation of the locking mechanism, the pawl mounted on the locking engages behind the frame part and thus makes a secure fastening.

Function

The pawl of the FABORY QUICK SYSTEM lockings are identical in function; for size, method of operation and manufacture, i.e. material (black polyamid with zinc inner parts, chrome plated zinc and stainless steel), there is a wide choice. With the standard models both an internal O-ring and a sealing ring for under the head are supplied with which the fastenings are splashproof in conformance with IP65.

Types

FABORY QUICK SYSTEM pawl latches are available in a large type and in a small type.



Technical and assembly data

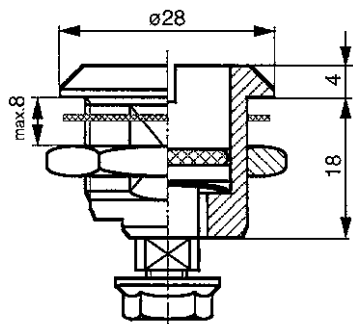

Large type

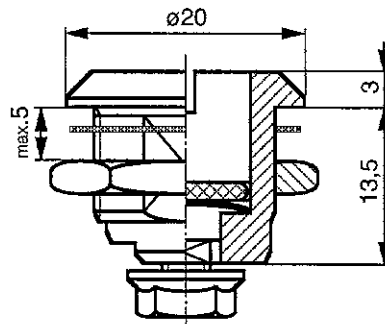

Small type

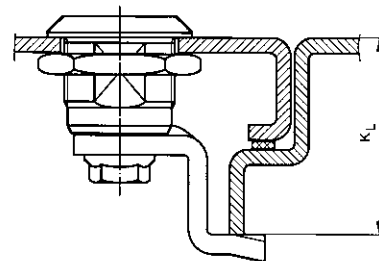

Grip range KL



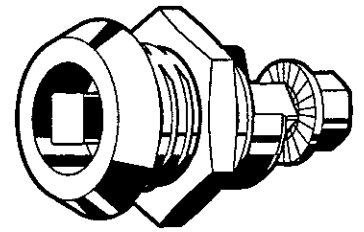

Locking

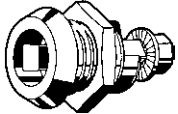

Article groups

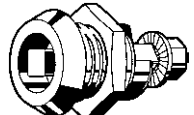
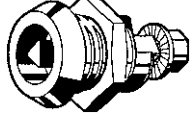
Material	Surface treatment	Code	Page
	Chr.pl.	62411	10-66
St.St.		62413	10-67

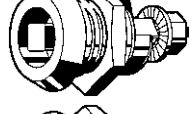
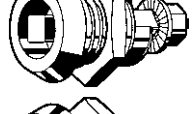
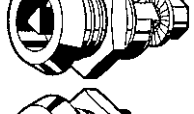
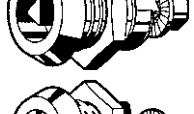
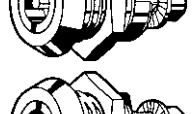
62411 QUICK SYSTEM Locking		S04A
Surface treatment	Chrome plated	

No.	✉	Art.number		
221178A	10	62411.221.178	<ul style="list-style-type: none"> • Locking with square 6 mm • Zinc chrome plated • Matching key, see article group 62415, type 291109 	
221179A	10	62411.221.179	<ul style="list-style-type: none"> • Locking with triangle 6,5 mm • Zinc chrome plated • Matching key, see article group 62415, type 291112 	
221180A	10	62411.221.180	<ul style="list-style-type: none"> • Locking with slotted head • Zinc chrome plated 	
221308A	10	62411.221.308	<ul style="list-style-type: none"> • Locking with square 7 mm • Zinc chrome plated • Matching key, see article group 62415, type 291102 	
221308B	10	62411.221.309	<ul style="list-style-type: none"> • Locking with square 7 mm • Black polyamide with zinc inner parts • Matching key, see article group 62415, type 291102 	
221313A	10	62411.221.313	<ul style="list-style-type: none"> • Locking with triangle 8 mm • Zinc chrome plated • Matching key, see article group 62415, type 291105. 	
221313B	10	62411.221.314	<ul style="list-style-type: none"> • Locking with triangle 8 mm • Black polyamide with zinc inner parts • Matching key, see article group 62415, type 291105. 	
221316A	10	62411.221.316	<ul style="list-style-type: none"> • Locking with double bit 3 mm • Zinc chrome plated • Matching key, see article group 62415, type 291107. 	
221316B	10	62411.221.317	<ul style="list-style-type: none"> • Locking with double bit 3 mm • Black polyamide with zinc inner parts • Matching key, see article group 62415, type 291107. 	

62411 QUICK SYSTEM Locking				←
No.	☒	Art.number		
221320A	10	62411.221.320	<ul style="list-style-type: none"> • Locking with slotted head • Zinc chrome plated 	
221320B	10	62411.221.321	<ul style="list-style-type: none"> • Locking with slotted head • Black polyamide with zinc inner parts 	
241334	1	62411.241.334	<ul style="list-style-type: none"> • Locking with cylinder lock • Identical locked • 2 keys are supplied • Zinc chrome plated 	
241336	1	62411.241.336	<ul style="list-style-type: none"> • Locking with cylinder lock • Not identical locked • 2 keys are supplied • Zinc chrome plated 	
251350	1	62411.251.350	<ul style="list-style-type: none"> • Locking with T-handle • Zinc chrome plated 	
251352	1	62411.251.352	<ul style="list-style-type: none"> • Locking with T-handle with cylinder lock • Identical locked • 2 keys are supplied • Zinc chrome plated 	
251354	1	62411.251.354	<ul style="list-style-type: none"> • Locking with T-handle with cylinder lock • Not identical locked • 2 keys are supplied • Zinc chrome plated 	
295074A	10	62411.295.074	<ul style="list-style-type: none"> • Locking with wing head • Zinc chrome plated 	
295074B	10	62411.295.075	<ul style="list-style-type: none"> • Locking with wing head • Black polyamide with zinc inner parts 	

62413 QUICK SYSTEM Locking				S04A
Material	Stainless steel			

No.	☒	Art.number		
223003A	1	62413.213.003	<ul style="list-style-type: none"> • Matching key, see type 291102, article group 62415. 	
223013A	1	62413.213.005	<ul style="list-style-type: none"> • Matching key, see type 291105, article group 62415. 	
223016A	1	62413.213.006	<ul style="list-style-type: none"> • Matching key, see type 291107, article group 62415. 	

62413 QUICK SYSTEM Locking		←
No.	✉ Art.number	
223020A	1 62413.213.008	• Slotted.

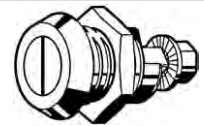

Pawl latch



Article groups



Material	Surface treatment	Code	Page
St	Zipl	62412	10-68
St.St.		62414	10-70

62412 QUICK SYSTEM Pawl latch		S04A
Material	Steel	
Surface treatment	Zinc plated	











No.	✉ Art.number		
232101	10 62412.232.101	• 1 point pawl. • Suitable for lockings, large type. • Grip range 4mm.	
232102	10 62412.232.102	• 1 point pawl. • Suitable for lockings, large type. • Klembereik 6mm.	
232103	10 62412.232.103	• 1 point pawl. • Suitable for lockings, large type. • Grip range 8mm.	
232104	10 62412.232.104	• 1 point pawl. • Suitable for lockings, large type. • Grip range 10mm.	
232105	10 62412.232.105	• 1 point pawl. • Suitable for lockings, large type. • Grip range 12mm.	
232106	10 62412.232.106	• 1 point pawl. • Suitable for lockings, large type. • Grip range 13mm.	
232107	10 62412.232.107	• 1 point pawl. • Suitable for lockings, large type. • Grip range 14mm.	



62412 QUICK SYSTEM Pawl latch				←
No.	☒	Art.number		
232108	10	62412.232.108	<ul style="list-style-type: none"> • 1 point pawl. • Suitable for lockings, large type. • Grip range 16mm. 	
232109	10	62412.232.109	<ul style="list-style-type: none"> • 1 point pawl. • Suitable for lockings, large type. • Grip range 18mm. 	
232110	10	62412.232.110	<ul style="list-style-type: none"> • 1 point pawl. • Suitable for lockings, large type. • Grip range 20mm. 	
232111	10	62412.232.111	<ul style="list-style-type: none"> • 1 point pawl. • Suitable for lockings, large type. • Grip range 22mm. 	
232112	10	62412.232.112	<ul style="list-style-type: none"> • 1 point pawl. • Suitable for lockings, large type. • Grip range 24mm. 	
232113	10	62412.232.113	<ul style="list-style-type: none"> • 1 point pawl. • Suitable for lockings, large type. • Grip range 25mm. 	
232114	10	62412.232.114	<ul style="list-style-type: none"> • 1 point pawl. • Suitable for lockings, large type. • Grip range 26mm. 	
232115	10	62412.232.115	<ul style="list-style-type: none"> • 1 point pawl. • Suitable for lockings, large type. • Grip range 28mm. 	
232136	10	62412.232.136	<ul style="list-style-type: none"> • 3 points pawl. • Suitable for lockings, large type. • Grip range 18mm. • Applicable with locking bars. • 2 retaining washers (for assembly with locking bar) are supplied separately. 	
232137	10	62412.232.137	<ul style="list-style-type: none"> • 3 points pawl. • Suitable for lockings, large type. • Grip range 20mm. • Applicable with locking bars. • 2 retaining washers (for assembly with locking bar) are supplied separately. 	
232138	10	62412.232.138	<ul style="list-style-type: none"> • 3 points pawl. • Suitable for lockings, large type. • Grip range 22mm. • Applicable with locking bars. • 2 retaining washers (for assembly with locking bar) are supplied separately. 	
232139	10	62412.232.139	<ul style="list-style-type: none"> • 3 points pawl. • Suitable for lockings, large type. • Grip range 24mm. • Applicable with locking bars. • 2 retaining washers (for assembly with locking bar) are supplied separately. 	
232141	10	62412.232.141	<ul style="list-style-type: none"> • 3 points pawl. • Suitable for lockings, large type. • Grip range 26mm. • Applicable with locking bars. • 2 retaining washers (for assembly with locking bar) are supplied separately. 	
232142	10	62412.232.142	<ul style="list-style-type: none"> • 3 points pawl. • Suitable for lockings, large type. • Grip range 28mm. • Applicable with locking bars. • 2 retaining washers (for assembly with locking bar) are supplied separately. 	

62412 QUICK SYSTEM Pawl latch				←
No.	☒	Art.number		
232155	10	62412.232.155	<ul style="list-style-type: none"> • 1 points pawl. • Suitable for lockings, small type. • Grip range 7,5mm. 	
232160	10	62412.232.160	<ul style="list-style-type: none"> • 1 points pawl. • Suitable for lockings, small type. • Grip range 13,5mm. 	
232164	10	62412.232.164	<ul style="list-style-type: none"> • 1 points pawl. • Suitable for lockings, small type. • Grip range 19,5mm. 	

62414 QUICK SYSTEM Pawl latch		S04A
Material	Stainless steel	
		

No.	☒	Art.number		
233004	1	62414.233.004	<ul style="list-style-type: none"> • 1 point pawl. • Suitable for lockings, large type. • Grip range 10mm. 	
233005	1	62414.233.005	<ul style="list-style-type: none"> • 1 point pawl. • Suitable for lockings, large type. • Grip range 12mm. 	
233006	1	62414.233.006	<ul style="list-style-type: none"> • 1 point pawl. • Suitable for lockings, large type. • Grip range 13mm. 	
233007	1	62414.233.007	<ul style="list-style-type: none"> • 1 point pawl. • Suitable for lockings, large type. • Grip range 14mm. 	
233008	1	62414.233.008	<ul style="list-style-type: none"> • 1 point pawl. • Suitable for lockings, large type. • Grip range 16mm. 	
233009	1	62414.233.009	<ul style="list-style-type: none"> • 1 point pawl. • Suitable for lockings, large type. • Grip range 18mm. 	
233010	1	62414.233.010	<ul style="list-style-type: none"> • 1 point pawl. • Suitable for lockings, large type. • Grip range 20mm. 	
233011	1	62414.233.011	<ul style="list-style-type: none"> • 1 point pawl. • Suitable for lockings, large type. • Grip range 22mm. 	
233012	1	62414.233.012	<ul style="list-style-type: none"> • 1 point pawl. • Suitable for lockings, large type. • Grip range 24mm. 	



10

62414 QUICK SYSTEM Pawl latch				←
No.	☒	Art.number		
233013	1	62414.233.013	<ul style="list-style-type: none"> • 1 point pawl. • Suitable for lockings, large type. • Grip range 25mm. 	
233014	1	62414.233.014	<ul style="list-style-type: none"> • 1 point pawl. • Suitable for lockings, large type. • Grip range 26mm. 	
233015	1	62414.233.015	<ul style="list-style-type: none"> • 1 point pawl. • Suitable for lockings, large type. • Grip range 28mm. 	

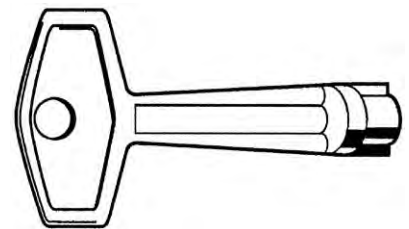
Matching key

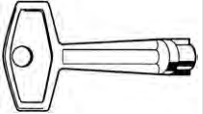

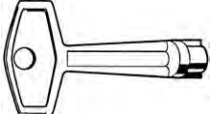
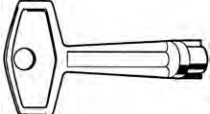
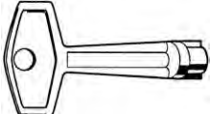
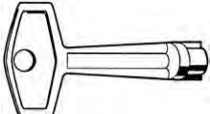
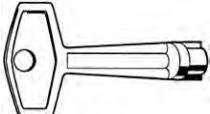
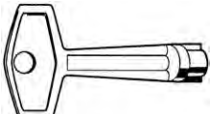
62415 QUICK SYSTEM Matching key				S04A
				

No.	☒	Art.number		
291102	1	62415.291.102	<ul style="list-style-type: none"> • Suitable for lockings, large type • Zinc • Square 7 mm 	
291103	1	62415.291.103	<ul style="list-style-type: none"> • Suitable for lockings, large type • Zinc • Square 8 mm 	
291104	1	62415.291.104	<ul style="list-style-type: none"> • Suitable for lockings, large type • Zinc • Triangle 7 mm 	
291105	1	62415.291.105	<ul style="list-style-type: none"> • Suitable for lockings, large type • Zinc • Triangle 8 mm 	
291107	1	62415.291.107	<ul style="list-style-type: none"> • Suitable for lockings, large type • Zinc • Double bit 3 mm 	
291108	1	62415.291.108	<ul style="list-style-type: none"> • Suitable for lockings, large type • Zinc • Double bit 5 mm 	
291109	1	62415.291.109	<ul style="list-style-type: none"> • Suitable for lockings, small type • Zinc • Square 6 mm 	

62415 QUICK SYSTEM Matching key		←	
No.	✉	Art.number	
291112	1	62415.291.112	<ul style="list-style-type: none"> • Suitable for lockings, small type • Zinc • Triangle 6,5 mm



Pawl latch accessories



62416 QUICK SYSTEM Pawl latch accessories		S04A

No.	✉	Art.number		
282103	4	62416.282.103	<ul style="list-style-type: none"> • Locking bar without runners • Length 600 mm 	
282107	4	62416.282.107	<ul style="list-style-type: none"> • Locking bar without runners • Length 1000 mm 	
282113	4	62416.282.113	<ul style="list-style-type: none"> • Locking bar with runners • Mounting adaptor has to be ordered separately • Length 600 mm 	
282116	4	62416.282.116	<ul style="list-style-type: none"> • Locking bar with runners • Mounting adaptor has to be ordered separately • Length 1000 mm 	
282119	4	62416.282.119	<ul style="list-style-type: none"> • Mounting adaptor • Zinc • Suitable for locking bar with runners 	

Locking bar guide

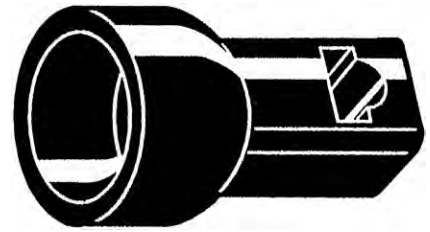

62417 QUICK SYSTEM Locking bar guide **S04A**

Material Plastic Polyamide (nylon)



No.	✉	Art.number	
200-3601	4	62417.203.601	<ul style="list-style-type: none"> • Type 258 024 • Sheet reversal 20 mm
200-3602	4	62417.203.602	<ul style="list-style-type: none"> • Type 258 023 • Sheet reversal 26 mm



FABORY QUICK SYSTEM

Quarter turn fasteners

General

A FABORY QUICK SYSTEM quarter turn fastener is a simple, fast and reliable fastener meant for connecting panels to a frame or components to one another.

Application

FABORY QUICK SYSTEM quarter turn fasteners are used for mounting panels or components in a fast and servicefriendly manner that must be removed or replaced for maintenance. It does not matter whether this operation must be done once a month or many times per hour.

Principle

In its simplest form a FABORY QUICK SYSTEM quarter turn fastener consists of a stud mounted on the panel by means of a retainer and a receptacle mounted on the frame.

Assembly

A FABORY QUICK SYSTEM quarter turn fastener is fastened by pressing, while a quarter turn breaks the bond, see assembly data below.

Assembly data

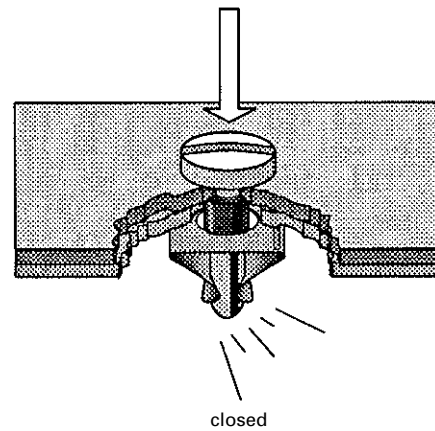
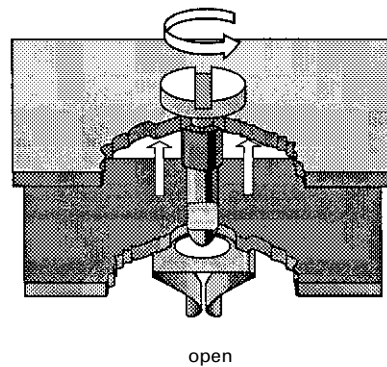

Stud with slotted head

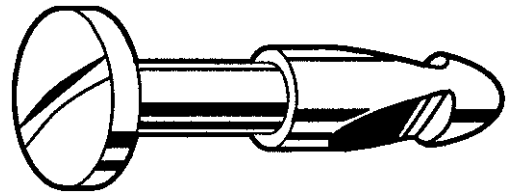

62272 QUICK SYSTEM Stud with slotted head type D

S04A

Material Brass
Surface treatment Nickel plated

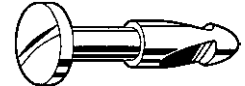

No.	☒	Art.number	No.	☒	Art.number	No.	☒	Art.number
D 0802	25	62272.000.802	D 1107	25	62272.001.107	D 1122	25	62272.001.122
D 0803	25	62272.000.803	D 1108	25	62272.001.108	D 1604	25	62272.001.604
D 0804	25	62272.000.804	D 1109	25	62272.001.109	D 1606	25	62272.001.606
D 0805	25	62272.000.805	D 1110	25	62272.001.110	D 1608	25	62272.001.608
D 0806	25	62272.000.806	D 1111	25	62272.001.111	D 1610	25	62272.001.610
D 0807	25	62272.000.807	D 1112	25	62272.001.112	D 1612	25	62272.001.612
D 0808	25	62272.000.808	D 1114	25	62272.001.114	D 1614	25	62272.001.614
D 1103	25	62272.001.103	D 1116	25	62272.001.116	D 1616	25	62272.001.616
D 1104	25	62272.001.104	D 1118	25	62272.001.118	D 1618	25	62272.001.618
D 1105	25	62272.001.105	D 1120	25	62272.001.120	D 1620	25	62272.001.620
D 1106	25	62272.001.106						

Stud with wing head

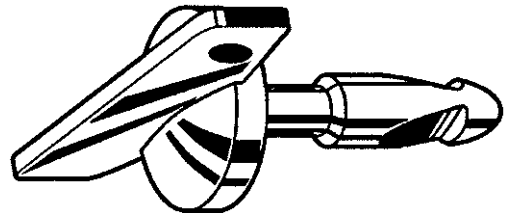

62273 QUICK SYSTEM Stud with wing head type W

S04A

Material Brass
Surface treatment Nickel plated

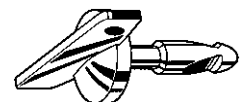

No.	☒	Art.number	No.	☒	Art.number	No.	☒	Art.number
W 0802	25	62273.000.802	W 1107	25	62273.001.107	W 1122	25	62273.001.122
W 0803	25	62273.000.803	W 1108	25	62273.001.108	W 1604	25	62273.001.604
W 0804	25	62273.000.804	W 1109	25	62273.001.109	W 1606	25	62273.001.606
W 0805	25	62273.000.805	W 1110	25	62273.001.110	W 1608	25	62273.001.608
W 0806	25	62273.000.806	W 1111	25	62273.001.111	W 1610	25	62273.001.610
W 0807	25	62273.000.807	W 1112	25	62273.001.112	W 1612	25	62273.001.612
W 0808	25	62273.000.808	W 1114	25	62273.001.114	W 1614	25	62273.001.614
W 1103	25	62273.001.103	W 1116	25	62273.001.116	W 1616	25	62273.001.616
W 1104	25	62273.001.104	W 1118	25	62273.001.118	W 1618	25	62273.001.618
W 1105	25	62273.001.105	W 1120	25	62273.001.120	W 1620	25	62273.001.620
W 1106	25	62273.001.106						

Stud with knurled slotted knob

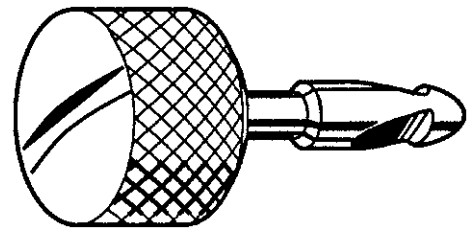

62274	QUICK SYSTEM Stud with knurled slotted knob type K	S04A
Material	Brass	
Surface treatment	Nickel plated	

No.	☒	Art.number	No.	☒	Art.number	No.	☒	Art.number
K 0803	25	62274.000.803	K 1107	25	62274.001.107	K 1606	25	62274.001.606
K 0804	25	62274.000.804	K 1108	25	62274.001.108	K 1608	25	62274.001.608
K 0805	25	62274.000.805	K 1110	25	62274.001.110	K 1610	25	62274.001.610
K 0806	25	62274.000.806	K 1112	25	62274.001.112	K 1612	25	62274.001.612
K 0808	25	62274.000.808	K 1114	25	62274.001.114	K 1614	25	62274.001.614
K 1103	25	62274.001.103	K 1116	25	62274.001.116	K 1616	25	62274.001.616
K 1104	25	62274.001.104	K 1118	25	62274.001.118	K 1618	25	62274.001.618
K 1105	25	62274.001.105	K 1120	25	62274.001.120	K 1620	25	62274.001.620
K 1106	25	62274.001.106	K 1122	25	62274.001.122			

Ball stud



62276	QUICK SYSTEM Ball stud type KB	S04A
		

Type	☒	Art.number	
KB 08 M4 S=7	25	62276.408.010	• Brass nickel plated.
KB 08 M5 S=11	25	62276.508.020	• Brass nickel plated.
KB 08 M5 S=111	25	62276.508.040	• Brass nickel plated.
KB 1615 M6X7 S=8	25	62276.616.150	• Steel zinc plated, yellow passivated.
KB 1615 M6X15 S=8	25	62276.616.151	• Steel zinc plated, yellow passivated.

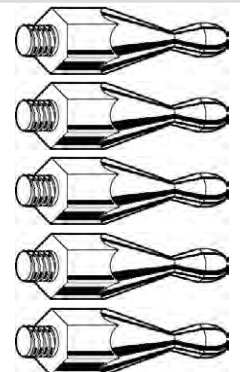

Retaining washer

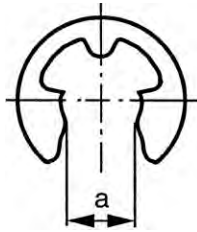
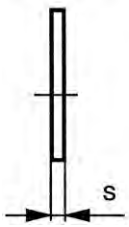

62282 QUICK SYSTEM Retaining washer

S04A

Material Spring steel



Nom. size.	☒	Art.number	
2,3MM	25	62282.023.001	<ul style="list-style-type: none"> Retaining washer (stud retainer) Spring steel, phosphated
4MM	25	62282.040.001	<ul style="list-style-type: none"> Retaining washer (stud retainer) Spring steel, phosphated
4MM	25	62282.040.002	<ul style="list-style-type: none"> Fixing washer (quick retainer) Spring steel, bronze plated and varnished
6MM	25	62282.060.002	<ul style="list-style-type: none"> Fixing washer (quick retainer) Spring steel, bronze plated and varnished
8 MM	25	62282.080.001	<ul style="list-style-type: none"> Retaining washer (stud retainer) Spring steel, phosphated
10MM	25	62282.100.002	<ul style="list-style-type: none"> Fixing washer (quick retainer) Spring steel, bronze plated and varnished

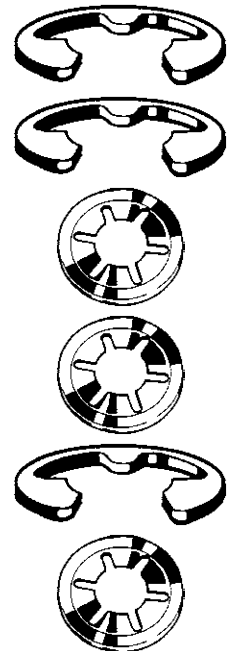

Grommet (retaining ring)

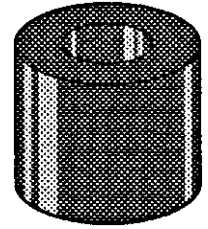

Article groups

Material		Code	Page
Neoprene	R	62283	10-78
Neoprene	RC	62284	10-78

62283 QUICK SYSTEM Grommet (retaining ring) type R		S04A
Material	Neoprene	

No.	✉	Art.number	No.	✉	Art.number	No.	✉	Art.number
R 1208	25	62283.001.208	R 2511	25	62283.002.511	R 4808	25	62283.004.808
R 1708	25	62283.001.708	R 2516	25	62283.002.516	R 5011	25	62283.005.011
R 1711	25	62283.001.711	R 3208	25	62283.003.208	R 5616	25	62283.005.616
R 1716	25	62283.001.716	R 4011	25	62283.004.011	R 6011	25	62283.006.011
R 2508	25	62283.002.508	R 4016	25	62283.004.016			

62284 QUICK SYSTEM Grommet (retaining ring) type RC		S04A
Material	Neoprene	

No.	✉	Art.number	No.	✉	Art.number	No.	✉	Art.number
RC 4008	25	62284.004.008	RC 6011/3	25	62284.060.113	RC 6011/6	25	62284.060.116

- Only suitable with three-part clip type CR, see group code 62325

Protecting washer

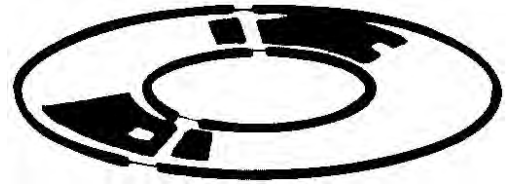

62285 QUICK SYSTEM Protecting washer type RT		S04A	
Material Class	Plastic Polyamide (nylon) 6		
No.	✉ Art.number	No.	✉ Art.number
RT 0208	25 62285.000.208	RT 0211	25 62285.000.211
		RT 0216	25 62285.000.216

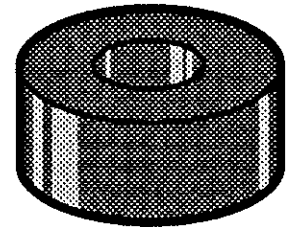

Sealing ring



62286 QUICK SYSTEM Sealing ring type RW		S04A	
Material	Neoprene		
No.	✉ Art.number	No.	✉ Art.number
RW 0511	25 62286.000.511	RW 1508	25 62286.001.508
RW 1011	25 62286.001.011	RW 1511	25 62286.001.511
		RW 2011	25 62286.002.011
		RW 2016	25 62286.002.016

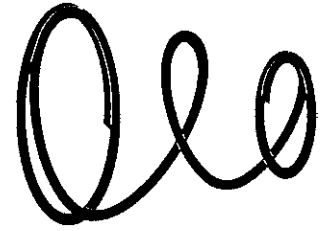

Conical retaining spring

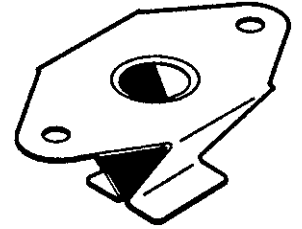

62302 QUICK SYSTEM Conical retaining spring type KF		S04A
Material	Spring steel	 
No.	✉ Art.number	No.
KF 08	25 62302.000.008	KF 11
		25 62302.000.011
		KF 16
	25 62302.000.016	

Rivet spring plate



62303 QUICK SYSTEM Rivet spring plate		S04A
		 

No.	✉ Art.number	
C 08/2,6	25 62303.080.001	• Steel zinc plated.
C 08/19	25 62303.080.002	• Steel zinc plated.
C 08/2,6	25 62303.080.003	• Stainless steel.
C 11	25 62303.110.001	• Steel zinc plated.
C 11	25 62303.110.002	• Stainless steel.
C 16	25 62303.160.001	• Steel zinc plated.

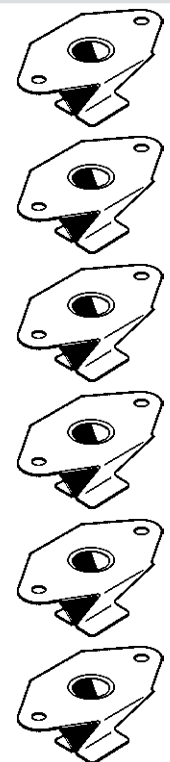

10

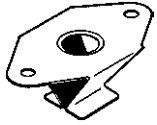
62303 QUICK SYSTEM Rivet spring plate				←
No.	✉	Art.number		
C 16	25	62303.160.002	• Stainless steel.	

Weld spring plate

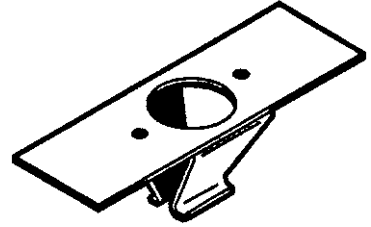

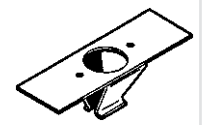

62304 QUICK SYSTEM Weld spring plate				S04A
				

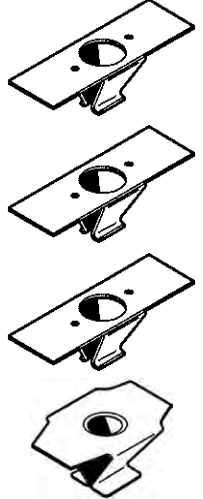

No.	✉	Art.number		
CP 08	25	62304.000.008	• Steel zinc plated.	
CP 11	25	62304.000.011	• Steel zinc plated.	
CP 16	25	62304.000.016	• Steel zinc plated.	
C 08/MSN	25	62304.080.004	• Stainless steel.	

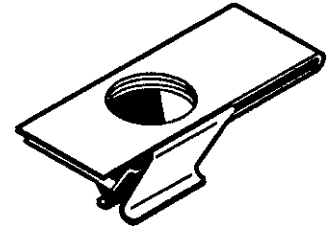
Slip-on spring receptacle





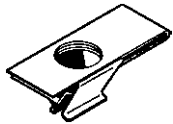
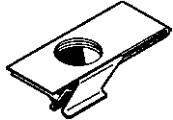

62305	QUICK SYSTEM Slip-on spring receptacle	S04A
Material	Steel	
Surface treatment	Zinc plated	
		
		

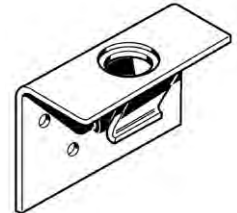
No.		Art.number		
CS 08/1,4	25	62305.080.001	• For frame thickness: 0,5 - 1,4 mm.	
CS 08/3,0	25	62305.080.003	• For frame thickness: 1,5 - 3,0 mm.	

Spring bracket

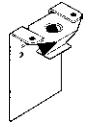
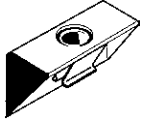

62306	QUICK SYSTEM Spring bracket	S04A
Material	Steel	
Surface treatment	Zinc plated	
		
		

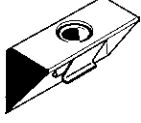





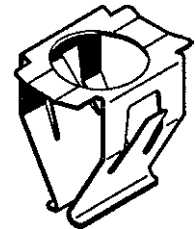

Type		Art.number		
MSC 08/1	25	62306.080.001		
MSCR 08	25	62306.080.002		
MSC 11/1	25	62306.110.001		
MSCR 11	25	62306.110.002		





62306 QUICK SYSTEM Spring bracket			←
Type	☒	Art.number	
MSC 16/1	25	62306.160.001	
MSCR 16	25	62306.160.002	

Front load receptacle

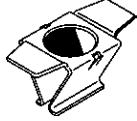
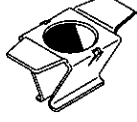

62323 QUICK SYSTEM Front load receptacle			S04A
Material	Steel		
			

No.	☒	Art.number		
CC 08/1	25	62323.080.001	• Steel zinc plated	
CC 08/2	25	62323.080.002	• Steel zinc plated	
CC 08/3	25	62323.080.003	• Steel zinc plated	
CC 08/4	25	62323.080.004	• Steel zinc plated	
CC 11/1	25	62323.110.001	• Steel zinc plated	
CC 11/2	25	62323.110.002	• Steel zinc plated	
CC 11/3	25	62323.110.003	• Steel zinc plated	
CC 11/4	25	62323.110.004	• Steel zinc plated	

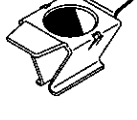
62323		QUICK SYSTEM Front load receptacle				←
No.	✉	Art.number				
CX11/15	25	62323.110.015	•	Stainless steel		
CX11/20	25	62323.110.020	•	Stainless steel		
CX11/25	25	62323.110.025	•	Stainless steel		
CC 16/1	25	62323.160.001	•	Steel zinc plated		
CC 16/2	25	62323.160.002	•	Steel zinc plated		
CC 16/3	25	62323.160.003	•	Steel zinc plated		
CC 16/4	25	62323.160.004	•	Steel zinc plated		

Three-part clip

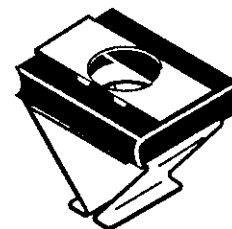

62325 QUICK SYSTEM Three-part clip, Type CR

S04A



No.	☒	Art.number	No.	☒	Art.number	No.	☒	Art.number
CR1008	25	62325.001.008	CR2008	25	62325.002.008	CR2011	25	62325.002.011
CR1508	25	62325.001.508						

- Stainless steel/steel with neoprene ring.
- For retaining ring type RC, see article group 62284.

Protection cup

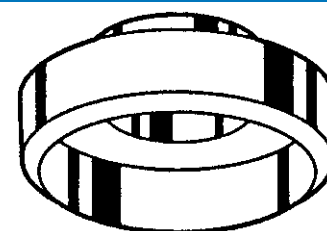

62332 QUICK SYSTEM Protection cup type TA/TAR

S04A

Color Assorted



Type	☒	Art.number	
TA 08	25	62332.080.001	• Brass nickel plated.
TAR 08	25	62332.080.002	• Black plastic.
TA 11	25	62332.110.001	• Brass nickel plated.
TA 16	25	62332.160.001	• Brass nickel plated.
TAR 16	25	62332.160.002	• Black plastic.

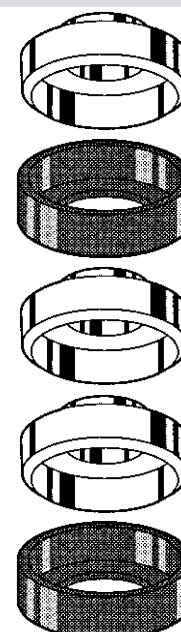

Insert type C

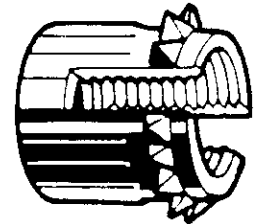
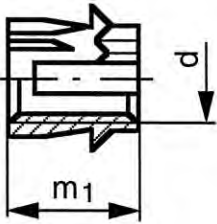

Technical Data

d	Drill ø	m ₁	P	d	Drill ø	m ₁	P
M3	4.7	5	0.5	M5	6.8	6	0.8
M4	5.6	5	0.7	M6	7.7	7	1

- Special features of inserts:
- Are highly suitable to provide soft materials like plastic, wood, chipboard and aluminium with strong ISO-metric thread in a fast and efficient way.
- During assembly the teeth are anchoring into the wall of the hole.
- The connection is selflocking against vibrations and shocks.
- Type C with one row of teeth is recommended for low forces and less frequent disassembly.

64010		Insert type C				N07A	
Thread		Metric thread					
Material		Brass					

d	☒	Art.number	d	☒	Art.number	d	☒	Art.number
M3	200	64010.030.001	M5	100	64010.050.001	M6	100	64010.060.001
M4	200	64010.040.001						

Insert type D

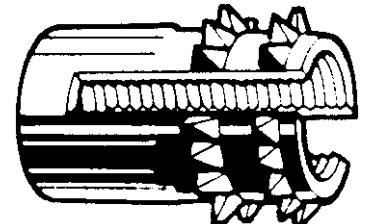
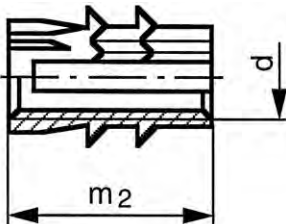

Technical Data

d	Drill ø	m ₂	P	d	Drill ø	m ₂	P
M3	4.7	9.5	0.5	M6	7.7	9	1
M4	5.6	9.5	0.7	M8	9.6	10	1.25
M5	6.8	9.5	0.8				

- Special features of inserts:
- Are highly suitable to provide soft materials like plastic, wood, chipboard and aluminium with strong ISO-metric thread in a fast and efficient way.
- During assembly the teeth are anchoring into the wall of the hole.
- The connection is selflocking against vibrations and shocks.
- Type D with two rows of teeth may be used for wood, larger forces and frequent disassembly.

64050		Insert type D				N07A	
Thread		Metric thread					
Material		Brass					

d	☒	Art.number	d	☒	Art.number	d	☒	Art.number
M3	200	64050.030.001	M5	100	64050.050.001	M8	100	64050.080.001
M4	200	64050.040.001	M6	100	64050.060.001			

Insert type E

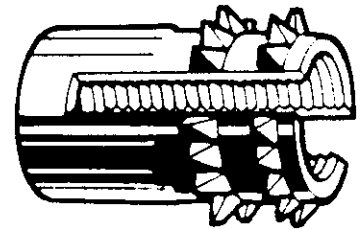
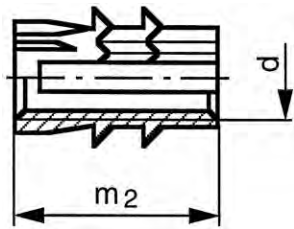

Technical Data

d	Drill \emptyset	m_2	P
M3	4.7	8	0.5
M4	5.6	8	0.7

Special features of inserts:

- are highly suitable to provide soft materials like plastic, wood, chipboard and aluminium with strong ISO-metric thread in a fast and efficient way.
- during assembly the teeth are anchoring into the wall of the hole.
- the connection is self-locking against vibrations and shocks.
- Type E (shorter version of type D) with two rows of teeth may be used for wood, larger forces and frequent disassembly.

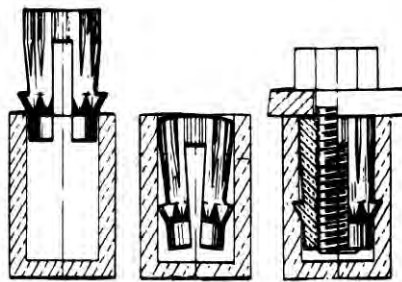

64030 Insert type E

N07A

Thread Metric thread
Material Brass

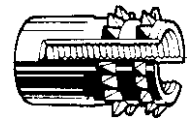

d	Art.number	d	Art.number
M3	200 64030.030.001	M4	200 64030.040.001

Screw insert type 530

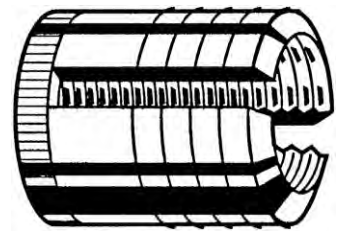
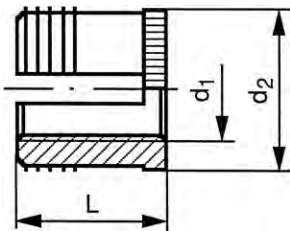

Technical Data

d_1	d_2	Drill ϕ	L	P
M3	4.3	4	4.8	0.5
M4	5.9	5.6	8	0.7
M5	6.7	6.4	9.5	0.8
M6	8.3	8	12.7	1
M8	9.9	9.5	12.7	1.25

- It is recommended that the exact diameter selection is made on basis of tests.

71570 Screw insert type 530

N07A

Thread Metric thread
Material Brass

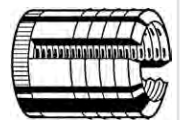

d_1	☒	Art.number	d_1	☒	Art.number	d_1	☒	Art.number
M3	200	71570.030.001	M5	100	71570.050.001	M8	100	71570.080.001
M4	200	71570.040.001	M6	100	71570.060.001			

Drive-in nut for wood

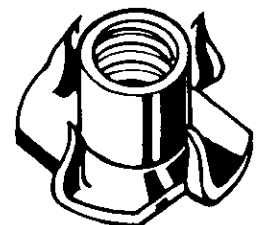
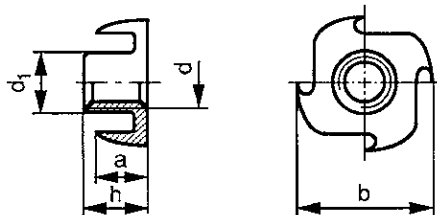

Technical Data



d	a	b	d_1	h	P
M3	3.5	13	4.3	5	0.5
M4	4.5	15	5	8	0.7
M5	5.5	17	6.3	8	0.8
M6	7	19	7.3	9	1
M8	7.5	22	9.7	11	1.25
M10	9	25	11.9	12	1.5
M12	9.5	27	13.7	14.5	1.75

Article groups

Thread	Material	Surface treatment	Code	Page
M	St		14100	10-89
M	St	Zipl	14110	10-89

14100	Drive-in nut for wood	F01F
Thread	Metric thread	 
Material	Steel	

d	☒	Art.number	d	☒	Art.number	d	☒	Art.number
M4	500	14100.040.001	M6	500	14100.060.001	M10	250	14100.100.001
M5	500	14100.050.001	M8	500	14100.080.001			

14110	Drive-in nut for wood	F01F
Thread	Metric thread	 
Material	Steel	
Surface treatment	Zinc plated	

d	☒	Art.number	d	☒	Art.number	d	☒	Art.number
M4	500	14110.040.001	M6	500	14110.060.001	M10	250	14110.100.001
M5	500	14110.050.001	M8	500	14110.080.001	M12	100	14110.120.001

Hexagon socket screw insert



Technical Data					
d₁	d₂	Hole ø hard wood	Hole ø soft wood	P	s
M4	8	6.9-7.2	6.6-6.9	0.7	4
M5	10	8.7-9.2	8.4-8.9	0.8	5
M6	12	10.2-10.8	10.0-10.4	1	6
M8	14	12.2-12.8	12.0-12.4	1.25	8
M8x23	16	14.2-14.8	14.0-14.5	1.25	8
M10	18.5	16.7-17.2	16.2-16.7	1.5	10

- It is recommended that the exact diameter selection is made on basis of tests.

Article groups

Thread	Material	Surface treatment	Code	Page
M	St	Zipl	14439	10-89
M	St	Zipl	with collar 14440	10-90

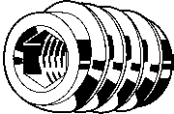
14439	Hexagon socket screw insert Type SK	F01F
Thread	Metric thread	 
Material	Steel	
Surface treatment	Zinc plated	

d₁ x L	☒	Art.number	d₁ x L	☒	Art.number	d₁ x L	☒	Art.number
M4X10	100	14439.040.010	M6X12	100	14439.060.012	M8X15	100	14439.080.015
			M6X15	100	14439.060.015	M8X23	100	14439.080.023
M5X12	100	14439.050.012	M6X20	100	14439.060.020	M10X25	100	14439.100.025

14440 Hexagon socket screw insert Type SKD F01F

Thread Metric thread
 Material Steel
 Surface treatment Zinc plated



$d_1 \times L$	☒	Art.number	$d_1 \times L$	☒	Art.number	$d_1 \times L$	☒	Art.number
M4X10	100	14440.040.010	M6X15	100	14440.060.015	M8X18	100	14440.080.018
M5X12	100	14440.050.012	M6X18	100	14440.060.018	M10X20	100	14440.100.020

Slotted screw insert

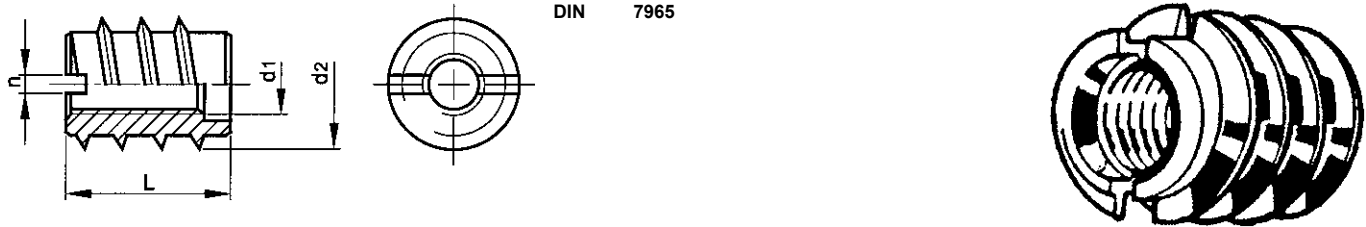

Technical Data

d_1	d_2	Hole \varnothing hard wood	Hole \varnothing soft wood	n	P
M3	6	4.9-5.2	4.6-4.9	1	0.5
M4	8	6.1-6.6	5.7-6.1	1.2	0.7
M5	10	8.0-8.5	7.6-8.0	1.6	0.8
M6	12	9.9-10.4	9.4-9.9	2	1
M8x15 (#DIN)	14	11.9-12.4	11.4-11.9	2.5	1.25
M8x18	16	13.3-14.0	12.6-13.3	2.5	1.25
M10	18.5	15.8-16.5	15.1-15.8	3	1.5
M12	22	19.0-19.8	18.3-19.0	3	1.75

• It is recommended that the exact diameter selection is made on basis of tests.

14410 Slotted screw insert Type A F01F

Thread Metric thread
 Material Steel



$d_1 \times L$	☒	Art.number	$d_1 \times L$	☒	Art.number	$d_1 \times L$	☒	Art.number
M3X8	100	14410.030.008	M5X12	100	14410.050.012	M8X18	100	14410.080.018
M4X8	100	14410.040.008	M6X12	100	14410.060.012	M10X20	100	14410.100.020
M4X10	100	14410.040.010	M6X15	100	14410.060.015	M10X25	100	14410.100.025
M4X12	100	14410.040.012	M8X15	100	14410.080.014	M12X30	100	14410.120.030

Hexagon socket screw insert with collar

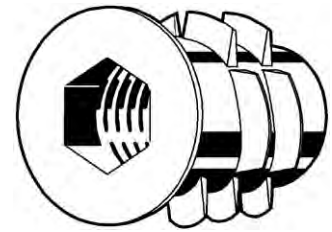
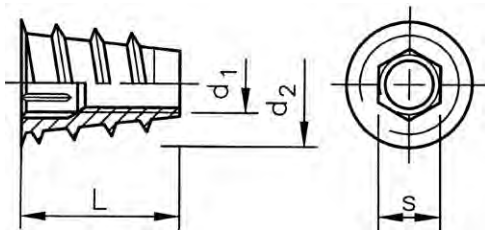

Technical Data

d ₁	d ₂	Hole ø (max.)	Hole ø (min.)	P	s
M4	8.5	6	5.7	0.7	4
M5	11.5	8	7.7	0.8	5
M6	12.5	9	8.7	1	6
M8	14.5	11	10.7	1.25	8
M10	16	12.5	12.2	1.5	10

- It is recommended that the exact diameter selection is made on basis of tests.

14446 Hexagon socket screw insert with collar Type SKDZ

F01F

Thread Metric thread
Material Die cast zinc
Surface treatment Zinc plated yellow passivated



d ₁ x L	☒	Art.number	d ₁ x L	☒	Art.number	d ₁ x L	☒	Art.number
M4X10	100	14446.040.010	M6X10	100	14446.060.010	M8X25	100	14446.080.025
M5X10	100	14446.050.010	M6X13	100	14446.060.013	M10X13	100	14446.100.013
M5X13	100	14446.050.013	M8X13	100	14446.080.013	M10X25	100	14446.100.025

Knock-in insert with collar

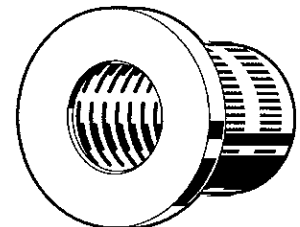
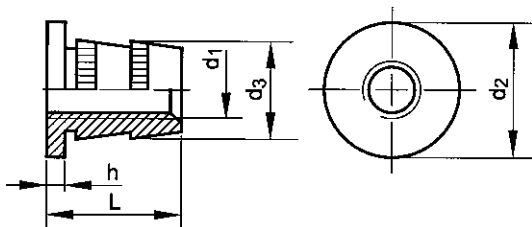

Technical Data

d ₁	d ₂	d ₃	h	L	P
M4	8	5.5	1	8	0.7
M5	10	6.5	1.3	10	0.8
M6	12	8.5	1.5	12	1
M8	15	10.5	2	12	1.25
M10	18.5	12.5	2	12	1.5

- It is recommended that the exact diameter selection is made on basis of tests.

14444 Knock-in insert with collar type TS

F01F

Thread Metric thread
Material Steel
Surface treatment Zinc plated

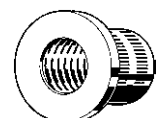

d ₁	☒	Art.number	d ₁	☒	Art.number	d ₁	☒	Art.number
M4	100	14444.040.001	M6	100	14444.060.001	M10	100	14444.100.001
M5	100	14444.050.001	M8	100	14444.080.001			

Knurled nut

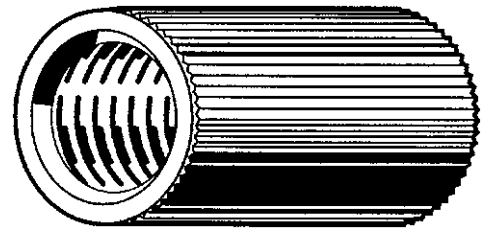
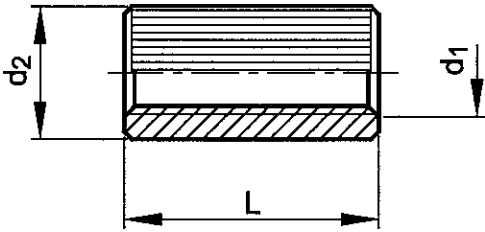



14443	Knurled nut type RM	F01F
Thread	Metric thread	 
Material	Steel	
Surface treatment	Zinc plated	

$d_1 \times d_2 \times L$	☒	Art.number	$d_1 \times d_2 \times L$	☒	Art.number
M6x10x15	100	14443.060.015	M6x10x18	100	14443.060.018

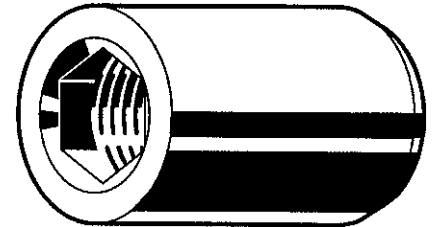
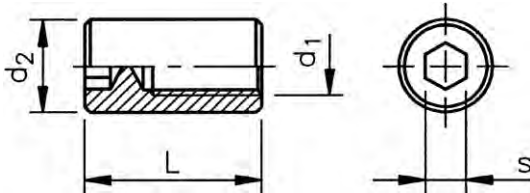
Hexagon socket dowel nut



14445	Hexagon socket dowel nut type RSK	F01F
Thread	Metric thread	 
Material	Steel	
Surface treatment	Zinc plated	

$d_1 \times d_2 \times L$	☒	Art.number	$d_1 \times d_2 \times L$	☒	Art.number
M6x10x16 (s=5)	100	14445.060.016	M6x10x20 (s=5)	100	14445.060.020

Hexagon socket flat head cap nut

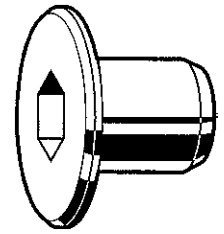
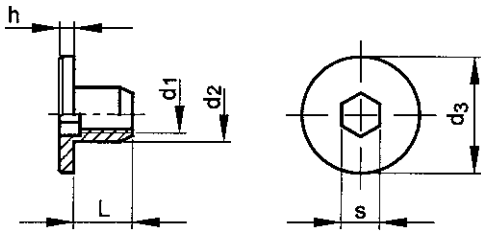

Technical Data

d_1	d_2	d_3	h	P	s
M6	9	15	2	1	5
M8	10	20	2	1.25	5

Article groups

Thread	Driving features	Material	Surface treatment	Code	Page
M	Hexagon socket	St	Ni.pl.	14456	10-93
M	Hexagon socket	Br	Ni.pl.	14483	10-93

14456 Hexagon socket flat head cap nut type RF

F01F

Thread	Metric thread
Material	Steel
Surface treatment	Nickel plated

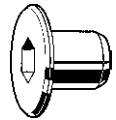

$d_1 \times L$	Art.number
M6x12	100 14456.060.001

14483 Hexagon socket flat head cap nut type RF

F01F

Thread	Metric thread
Material	Brass
Surface treatment	Nickel plated

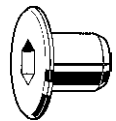

$d_1 \times L$	Art.number	$d_1 \times L$	Art.number
M6x10	100 14483.060.001	M8x10	100 14483.080.001

Hexagon socket mushroom head cap nut

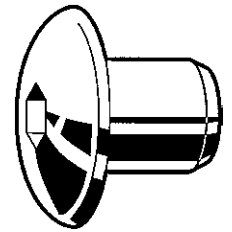
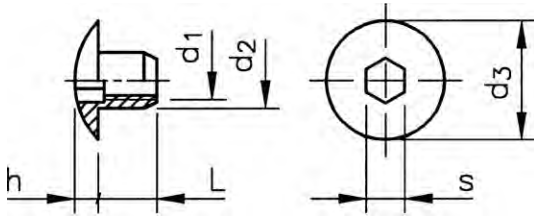

Technical Data

d_1	d_2	d_3	h	P	s
M6	9	15	3.5	1	5
M8	10	20	3	1.25	5

Article groups

Thread	Driving features	Material	Surface treatment	Code	Page
M	Hexagon socket	St	Ni.pl.	14457	10-94
M	Hexagon socket	Br	Ni.pl.	14484	10-94

14457 Hexagon socket mushroom head cap nut type RT

F01F

Thread	Metric thread
Material	Steel
Surface treatment	Nickel plated

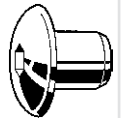

$d_1 \times L$ **Art.number**

M6x12 100 [14457.060.001](#)

14484 Hexagon socket mushroom head cap nut type RT

F01F

Thread	Metric thread
Material	Brass
Surface treatment	Nickel plated

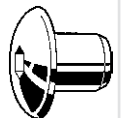

$d_1 \times L$ **Art.number** $d_1 \times L$ **Art.number**

M6x10 100 [14484.060.001](#) M8x10 100 [14484.080.001](#)

Hexagon socket flat head cap screw

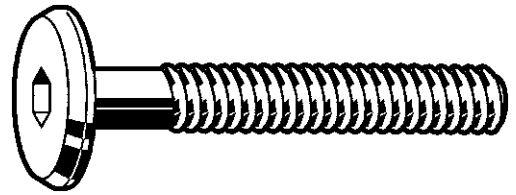
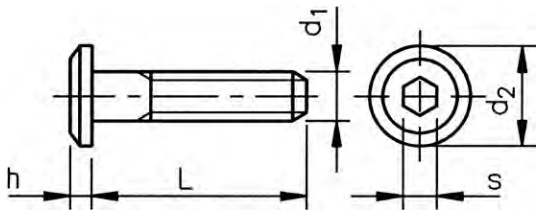

Technical Data

d_1	d_2	h	P	s
M6	15	2.5	1	4

14441 Hexagon socket flat head cap screw type KF

H09A

Thread Metric thread
Material Steel
Surface treatment Zinc plated



$d_1 \times L$	☒	Art.number	$d_1 \times L$	☒	Art.number	$d_1 \times L$	☒	Art.number
M6X12	100	14441.060.012	M6X35	100	14441.060.035	M6X70	100	14441.060.070
M6X16	100	14441.060.016	M6X40	100	14441.060.040	M6X80	100	14441.060.080
M6X20	100	14441.060.020	M6X45	100	14441.060.045	M6X90	100	14441.060.090
M6X25	100	14441.060.025	M6X50	100	14441.060.050	M6X100	100	14441.060.100
M6X30	100	14441.060.030	M6X60	100	14441.060.060			

Hexagon socket mushroom head cap screw

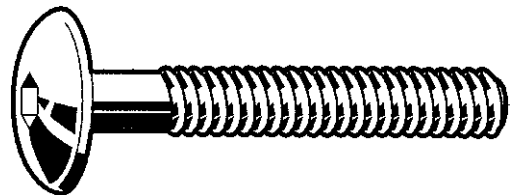
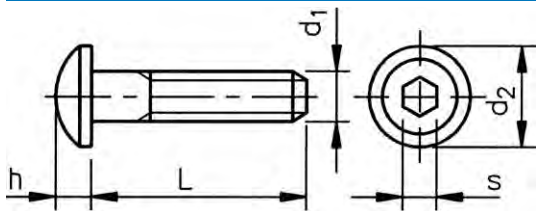

Technical Data

d_1	d_2	h	P	s
M6	15	3.3	1	4

14442 Hexagon socket mushroom head cap screw type KT

H09A

Thread Metric thread
Material Steel
Surface treatment Zinc plated

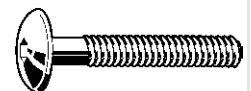

$d_1 \times L$	☒	Art.number	$d_1 \times L$	☒	Art.number	$d_1 \times L$	☒	Art.number
M6X12	100	14442.060.012	M6X35	100	14442.060.035	M6X70	100	14442.060.070
M6X16	100	14442.060.016	M6X40	100	14442.060.040	M6X80	100	14442.060.080
M6X20	100	14442.060.020	M6X45	100	14442.060.045	M6X90	100	14442.060.090
M6X25	100	14442.060.025	M6X50	100	14442.060.050	M6X100	100	14442.060.100
M6X30	100	14442.060.030	M6X60	100	14442.060.060			

Hexagon socket corner connector

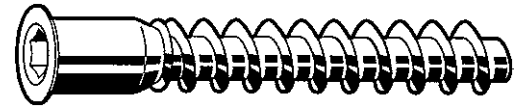
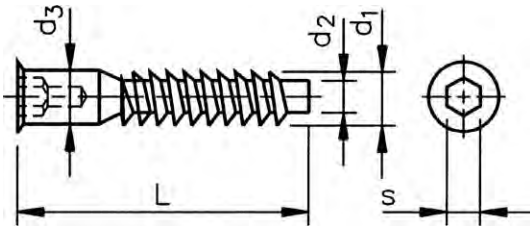

Technical Data

d_1	d_2	d_3	Drill \emptyset	s
7	4.5	7	4.5	4

14451 Hexagon socket corner connector type KOK

H09A

Material Steel
Surface treatment Zinc plated

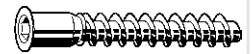

$d_1 \times L$	☒	Art.number
7X50MM	200	14451.070.050

Slotted cross dowel

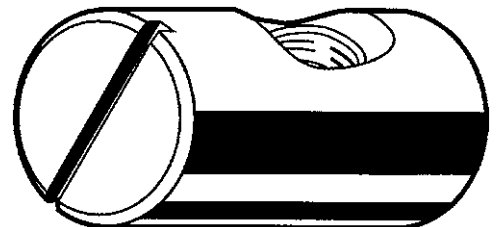
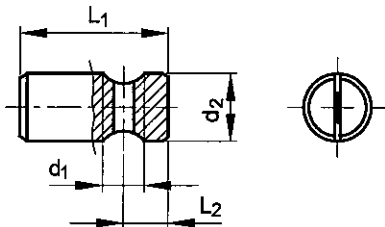

Technical Data

$d_1 \times L_1$	d_2	L_2	P	$d_1 \times L_1$	d_2	L_2	P
M6x12	10	6	1	M6x17	10	6	1
M6x14	10	6	1	M6x20	10	10	1
M6x15	10	6	1	M6x25	10	12.5	1

14450 Slotted cross dowel type Q

F01F

Thread Metric thread
Material Steel
Surface treatment Zinc plated



$d_1 \times L_1$	☒	Art.number	$d_1 \times L_1$	☒	Art.number	$d_1 \times L_1$	☒	Art.number
M6X12	100	14450.060.012	M6X15	100	14450.060.015	M6X20	100	14450.060.020
M6X14	100	14450.060.014	M6X17	100	14450.060.017	M6X25	100	14450.060.025

Rosette open model

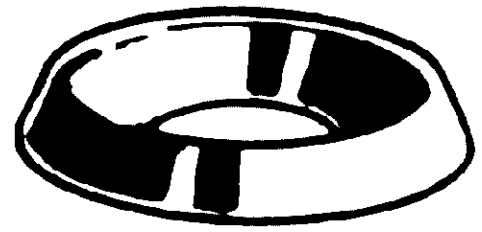
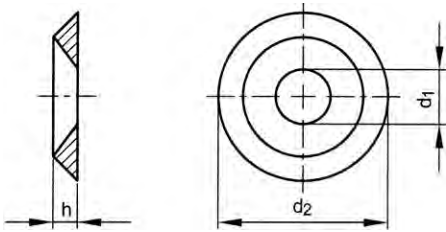

Technical Data

Nom. size d ₁	d ₂	For screw ø	h
3.2	9	2.5-3	1.9
4	11	3.5-4	2.3
4.8	13	4-4.5	2.7
5.5	15	5	3.2
6.6	17	5.5-6	3.2
7.4	20	7	4

Example of application

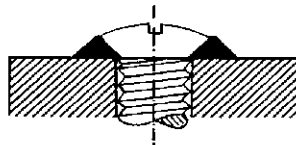

Article groups

Material	Surface treatment	Code	Page
St.St. A2		51350	10-97
Br		50230	10-97
Br	Ni.pl.	50260	10-97

51350 Rosette open model R09A

Material: Stainless steel A2



Nom. size d ₁	Art.number	Nom. size d ₁	Art.number	Nom. size d ₁	Art.number
3,2MM	250 51350.032.001	4,8MM	250 51350.048.001	6,6MM	200 51350.066.001
4,0MM	250 51350.040.001	5,5MM	200 51350.055.001	7,4MM	200 51350.074.001

50230 Rosette open model M11F

Material: Brass



Nom. size d ₁	Art.number	Nom. size d ₁	Art.number	Nom. size d ₁	Art.number
3,2MM	250 50230.032.001	4,8MM	250 50230.048.001	6,6MM	200 50230.066.001
4,0MM	250 50230.040.001	5,5MM	200 50230.055.001	7,4MM	200 50230.074.001

50260 Rosette open model M11F

Material: Brass
Surface treatment: Nickel plated



Nom. size d ₁	Art.number	Nom. size d ₁	Art.number	Nom. size d ₁	Art.number
3,2MM	250 50260.032.001	4,8MM	250 50260.048.001	6,6MM	200 50260.066.001
4,0MM	250 50260.040.001	5,5MM	200 50260.055.001	7,4MM	200 50260.074.001

Rosette closed model

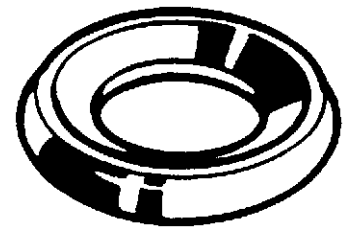
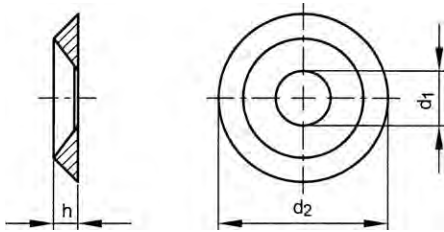

Technical Data

Nom. size d_1	d_2	For screw	For tapping screw	h
4	9	M3	ST2.9	2
5	11	M4	ST4.2	2.3
6	13	M5	ST4.8	2.5

50280 Rosette closed model M11F

Material Brass
Surface treatment Nickel plated



Nom. size d_1	☒	Art.number	Nom. size d_1	☒	Art.number	Nom. size d_1	☒	Art.number
4,0MM	250	50280.040.001	5,0MM	250	50280.050.001	6,0MM	150	50280.060.001

Washer for 90° countersunk head screw

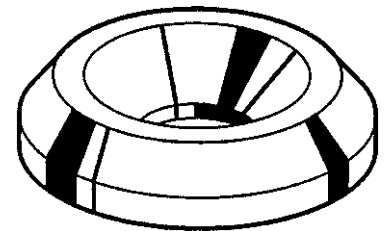
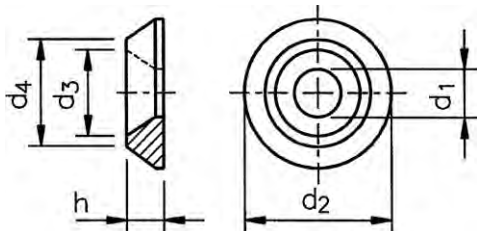

Technical Data

For nom. size d_1	d_1 (min.)	d_2 (max.)	d_3 (min.)	d_4	h (min.)
M4	4.3	14	8.6	9.5	2.3
M5	5.3	16	10.4	11.5	2.8
M6	6.4	18	12.4	13.5	3.3
M8	8.4	25	16.4	17.5	4.8

45140 Washer for 90° countersunk head screw W01A

Material Aluminium

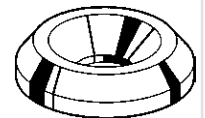

For nom. size d_1	☒	Art.number	For nom. size d_1	☒	Art.number	For nom. size d_1	☒	Art.number
M4	100	45140.040.001	M6	100	45140.060.001	M8	100	45140.080.001
M5	100	45140.050.001						

Turned cup washers

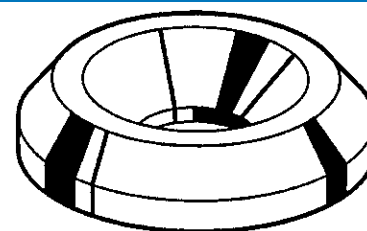
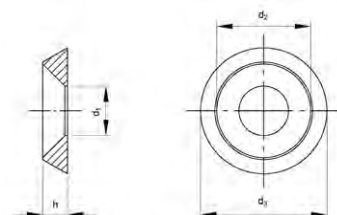

Technical Data

d	d ₁	d ₂	d ₃	h
M3	3.5	6.5	9	2
M4	4.5	8	11	2.5
M5	5.5	10	14	3
M6	7	12	16	4
M8	9	16	22	5
M10	11	20	28	6
M12	14	24	32	6.5

Article groups

Material	Code	Page
St.St. A1	51546	10-99
St.St. A4	55350	10-99

51546 Turned cup washers

R09A

Material Stainless steel A1



For nom. size d ₁	⊗	Art.number	For nom. size d ₁	⊗	Art.number	For nom. size d ₁	⊗	Art.number
M3	100	51546.030.001	M6	100	51546.060.001	M10*	50	51546.100.001
M4	100	51546.040.001	M8	100	51546.080.001	M12*	50	51546.120.001
M5	100	51546.050.001						

55350 Turned cup washers

R05A

Material Stainless steel A4



For nom. size d ₁	⊗	Art.number	For nom. size d ₁	⊗	Art.number	For nom. size d ₁	⊗	Art.number
M3*	200	55350.030.001	M6*	100	55350.060.001	M10*	50	55350.100.001
M4*	200	55350.040.001	M8*	100	55350.080.001	M12*	50	55350.120.001
M5*	200	55350.050.001						

Sleeve nut

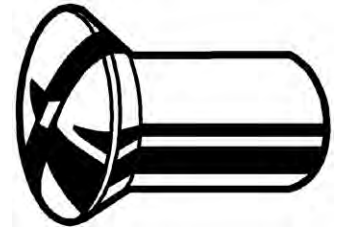
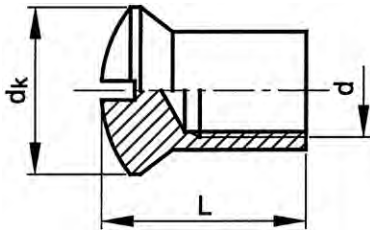

Technical Data

d	P
M4	0.7
M5	0.8
M6	1
M8	1.25

Article groups

Thread	Material	Surface treatment	Code	Page
M	Br	Ni.pl.	47796	10-100
M	St.St. A1		51212	10-100
M	St.St. A4		55212	10-100

47796 Sleeve nut

M01D

Thread	Metric thread
Material	Brass
Surface treatment	Nickel plated

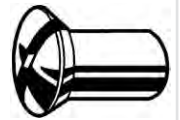

d x dk x L	☒	Art.number	d x dk x L	☒	Art.number	d x dk x L	☒	Art.number
M4X7X12	100	47796.040.012	M5X9X15	100	47796.050.015	M6X10X20	100	47796.060.020
M4X7X14	100	47796.040.014	M5X9X20	100	47796.050.020	M8X15X15	100	47796.080.015
M4X7X20	100	47796.040.020	M6X12X14	100	47796.060.014	M8X15X20	100	47796.080.020
M5X9X10	100	47796.050.010	M6X10X15	100	47796.060.015	M8X15X25	100	47796.080.025

51212 Sleeve nut

R05A

Thread	Metric thread
Material	Stainless steel A1

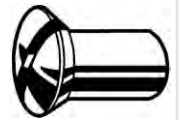

d x dk x L	☒	Art.number	d x dk x L	☒	Art.number	d x dk x L	☒	Art.number
M4X7X12*	100	51212.040.012	M6X10X15*	100	51212.060.015	M8X15X20*	100	51212.080.020
M5X9X15*	100	51212.050.015						

55212 Sleeve nut

R45A

Thread	Metric thread
Material	Stainless steel A4

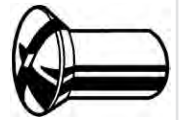

d x dk x L	☒	Art.number	d x dk x L	☒	Art.number	d x dk x L	☒	Art.number
M4X7X12*	100	55212.040.012	M6X10X15*	100	55212.060.015	M8X15X20*	100	55212.080.020
M5X9X15*	100	55212.050.015						

Booknut

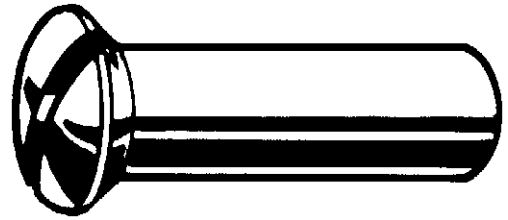
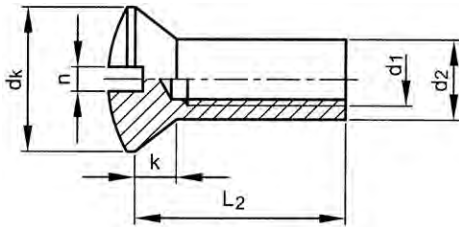

Technical Data

d_1	d_2	d_k	k (max.)	n	P
M4	5	7.5	2.2	1	0.7

Article groups

Thread	Material	Surface treatment	Code	Page
M	Br		47780	10-101
M	Br	Ni.pl.	47790	10-101

47780 Booknut		M11D
Thread	Metric thread	
Material	Brass	

$d_1 \times L_2$	Art.number
M4X22	250 47780.040.022

47790 Booknut		M11D
Thread	Metric thread	
Material	Brass	
Surface treatment	Nickel plated	

$d_1 \times L_2$	Art.number
M4X22	250 47790.040.022

Bookscrew

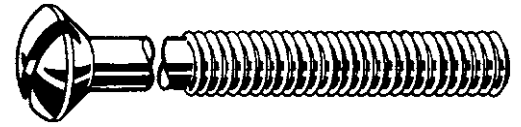
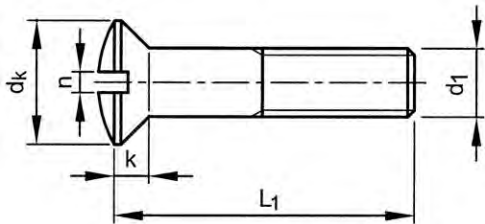

Technical Data

d_1	d_k	k (max.)	n	P
M4	7.5	2.2	1	0.7

Article groups

Thread	Material	Surface treatment	Code	Page
M	St	Ni.pl.	47720	10-102
M	Br	Ni.pl.	47750	10-102

47720	Bookscrew	M11D
Thread	Metric thread	
Material	Steel	
Surface treatment	Nickel plated	

$d_1 \times L_1$	☒	Art.number	$d_1 \times L_1$	☒	Art.number	$d_1 \times L_1$	☒	Art.number
M4X38	250	47720.040.038	M4X45	250	47720.040.045	M4X55	250	47720.040.055

47750	Bookscrew	M11D
Thread	Metric thread	
Material	Brass	
Surface treatment	Nickel plated	

$d_1 \times L_1$	☒	Art.number	$d_1 \times L_1$	☒	Art.number
M4X38	250	47750.040.038	M4X45	250	47750.040.045

Bookscrew

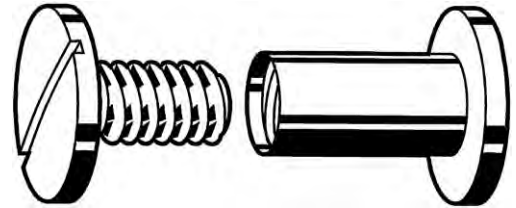
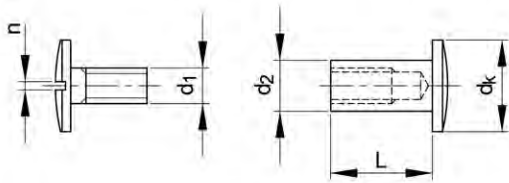

Technical Data

d_1	d_2	d_k	n	P
M3.5	5	9	0.8	0.6

47711 Bookscrew		M11D
Material	Brass	
		

$d_1 \times L$	☒	Art.number	$d_1 \times L$	☒	Art.number	$d_1 \times L$	☒	Art.number
M3,5X10	100	47711.035.010	M3,5X25	50	47711.035.025	M3,5X50	25	47711.035.050
M3,5X15	100	47711.035.015	M3,5X30	50	47711.035.030	M3,5X60	25	47711.035.060
M3,5X20	100	47711.035.020	M3,5X40	25	47711.035.040			

Elongation piece for bookscrews

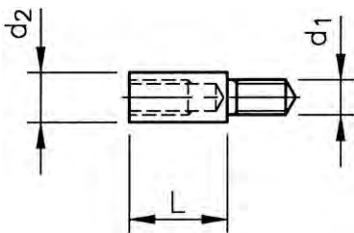

Technical Data

L	d_1	d_2	P
10	M3.5	5	0.6
15	M3.5	5	0.6

47715 Elongation piece for bookscrews		M11D
Thread	Metric thread	
Material	Brass	

L	☒	Art.number	L	☒	Art.number
10MM	100	47715.000.010	15MM	100	47715.000.015

Binder screw

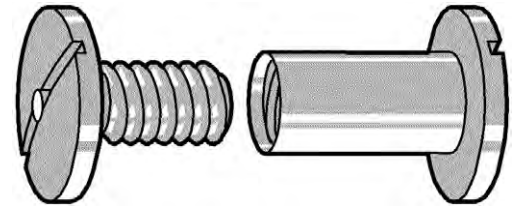
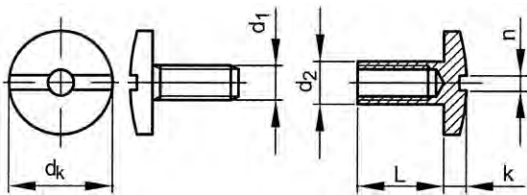

Technical Data

d₁	d₂	d_k	k	n	P
M4	5	12	2.6	1.8	0.7

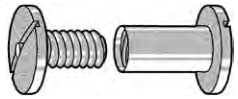
56480	Binder screw	W02A
Thread	Metric thread	
Material	Plastic Polyethylene	
Color	White	

L	☒	Art.number	L	☒	Art.number	L	☒	Art.number
6MM	100	56480.060.001	25MM	50	56480.250.001	60MM	50	56480.600.001
8MM	100	56480.080.001	30MM	50	56480.300.001	70MM	25	56480.700.001
10MM	100	56480.100.001	35MM	50	56480.350.001	80MM	25	56480.800.001
15MM	50	56480.160.001	40MM	50	56480.400.001	90MM	25	56480.900.001
20MM	50	56480.200.001	50MM	50	56480.500.001			

Tube cap round

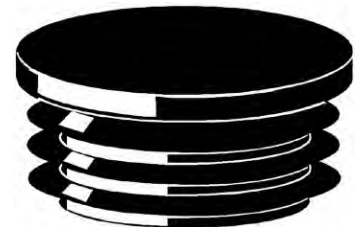
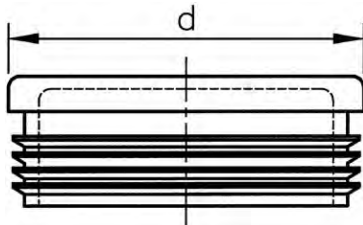

56792	Tube cap round	W05F
Material	Plastic Polyethylene	
Color	Black	

d (t)	☒	Art.number	d (t)	☒	Art.number	d (t)	☒	Art.number
12MM (1-2mm)	25	56792.120.001	23MM (0,8-2,5mm)	25	56792.230.001	36MM (1-3mm)	25	56792.360.001
13MM (1-2mm)	25	56792.130.001	24MM (1-2,5mm)	25	56792.240.001	37MM (1-3mm)	25	56792.370.001
14MM (1-2mm)	25	56792.140.001	25MM (1-2mm)	25	56792.250.001	38MM (1-2mm)	25	56792.380.001
15MM (0,8-2mm)	25	56792.150.001	26MM (1-3mm)	25	56792.260.001	40MM (1-2mm)	25	56792.400.001
16MM (1-2mm)	25	56792.160.001	27MM (1-3mm)	25	56792.270.001	42MM (1-2mm)	25	56792.420.001
18MM (1-2mm)	25	56792.180.001	28MM (0,8-2,5mm)	25	56792.280.001	45MM (1-3,5mm)	25	56792.450.001
19MM (1-2mm)	25	56792.190.001	30MM (0,8-2,5mm)	25	56792.300.001	48MM (1-2mm)	25	56792.480.001
20MM (0,8-2,5mm)	25	56792.200.001	32MM (0,8-2mm)	25	56792.320.001	50MM (1-2,5mm)	25	56792.500.001
21MM (0,8-2mm)	25	56792.210.001	34MM (1-3mm)	25	56792.340.001	55MM (1-3mm)	25	56792.550.001
22MM (1-2mm)	25	56792.220.001	35MM (1-3mm)	25	56792.350.001	60MM (1,5-2,5mm)	25	56792.600.001

• (t) = Suitable for thickness of base material.

Tube cap square

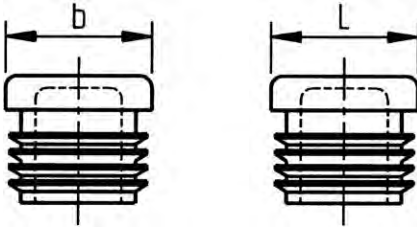

56795	Tube cap square	W05F
Material	Plastic Polyethylene	
Color	Black	

L x b (t)	☒	Art.number	L x b (t)	☒	Art.number	L x b (t)	☒	Art.number
12-12MM (1-2mm)	100	56795.120.120	30-30MM (1-2mm)	100	56795.300.300	60-60MM (1,5-2,5mm)	25	56795.600.600
15-15MM (1-2mm)	100	56795.150.150	35-35MM (1-2mm)	50	56795.350.350	70-70MM (2-4mm)	10	56795.700.700
20-20MM (1-2mm)	100	56795.200.200	40-40MM (1-2mm)	25	56795.400.400	80-80MM (2-4mm)	10	56795.800.800
22-22MM (1-2mm)	100	56795.220.220	45-45MM (1-3mm)	25	56795.450.450	100-100MM (3-6mm)	10	56795.982.982
25-25MM (1-2mm)	100	56795.250.250	50-50MM (1-3mm)	25	56795.500.500			

- (t) = Suitable for thickness of base material.
- 15-15MM; with smooth shank.

Tube cap rectangular

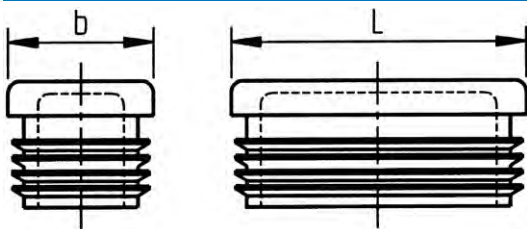

56797	Tube cap rectangular	W05F
Material	Plastic Polyethylene	
Color	Black	

L x b (t)	☒	Art.number	L x b (t)	☒	Art.number	L x b (t)	☒	Art.number
20-10MM (0,75-2mm)	100	56797.200.100	40-25MM (1-2mm)	50	56797.400.250	70-40MM (1-2mm)	25	56797.700.400
20-15MM (1-2mm)	100	56797.200.150	40-30MM (1-2mm)	50	56797.400.300	80-40MM (1-3mm)	25	56797.800.400
25-10MM (1-2mm)	100	56797.250.100	45-25MM (1-2mm)	50	56797.450.250	80-40x4MM (2-4mm)	25	56797.800.404
25-15MM (1-2mm)	100	56797.250.150	50-20MM (1-2mm)	50	56797.500.200	80-50MM (2-4mm)	25	56797.800.500
30-10MM (1-2mm)	100	56797.300.100	50-25MM (1-3mm)	50	56797.500.250	100-40x4MM (1,5-4mm)	25	56797.960.400
30-15MM (1,2-2,5mm)	100	56797.300.150	50-30MM (1-3mm)	50	56797.500.300	100-60x4MM (2,5-4,5mm)	25	56797.960.600
30-20MM (1-2mm)	100	56797.300.200	60-20MM (1-3mm)	50	56797.600.200	120-30MM (1-2mm)	25	56797.980.300
35-20MM (1-2mm)	100	56797.350.200	60-30MM (2-4mm)	50	56797.600.300	120-60MM (2-3mm)	25	56797.980.600
35-25MM (1-3mm)	50	56797.350.250	60-40MM (2-4mm)	50	56797.600.400	120-80MM (2-3mm)	25	56797.980.800
40-20MM (1-2mm)	50	56797.400.200	70-20MM (1-2mm)	25	56797.700.200			

- (t) = Suitable for thickness of base material.

Tube cap conical

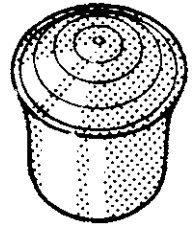
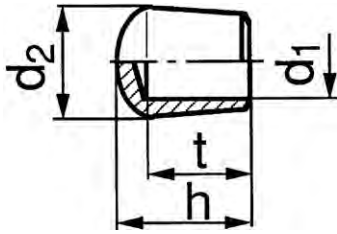

Technical Data

d ₁	d ₂	h	t	d ₁	d ₂	h	t
3	5	10	8	32	36	33	25
4	6	11	9	34	38	33	25
5	7	7.5	7	35	39	33	25
6	8	13	10.5	38	42	33	27
8	11	15	13	40	44	33	24
10	15	18	14	42	46	33	27
12	17	21	17	43	47	33	26
13	17	20	16	45	49	33	26
14	19	22	18	47	51	33	24
16	21	24	20	48	53	33	28
18	25	27	22	49	53	33	28
19	24	24	19	50	53	33	24
20	27	30	24	54	57	35	26
22	29	33	26	59	63	38	27
24	32	36	30	63	67	38	28
25	30	31	24	69	73	38	28
26	33	36	31	75	78	40	28
28	32	30	24	90	95	45	31
30	34	31	24	103	106	40	35

56790 Tube cap

W02A

Material Plastic Polyvinylchloride
Color Black



d ₁	☒	Art.number	d ₁	☒	Art.number	d ₁	☒	Art.number
3MM	100	56790.030.001	20MM	50	56790.200.001	43MM	25	56790.430.001
4MM	100	56790.040.001	22MM	50	56790.220.001	45MM	25	56790.450.001
5MM	100	56790.050.001	25MM	25	56790.250.001	47MM	25	56790.470.001
6MM	100	56790.060.001	28MM	25	56790.280.001	48MM	25	56790.480.001
8MM	100	56790.080.001	30MM	25	56790.300.001	50MM	25	56790.500.001
10MM	100	56790.100.001	32MM	25	56790.320.001	54MM	25	56790.540.001
12/13MM	100	56790.120.001	34MM	25	56790.340.001	59MM	25	56790.590.001
14MM	100	56790.140.001	35MM	25	56790.350.001	63MM	25	56790.630.001
16MM	100	56790.160.001	38MM	25	56790.380.001	69MM	10	56790.690.001
18MM	50	56790.180.001	40MM	25	56790.400.001	75MM	10	56790.750.001
19MM	50	56790.190.001	42MM	25	56790.420.001	90MM	10	56790.900.001

Fabory Security Fasteners

To counter threats as vandalism, theft and tampering, security fasteners are used in a variety of applications like outdoor furniture, billboards, outdoor lights etc. By using these fasteners the so-called "opportunity theft" will be reduced to a minimum as the potential thief / vandal will not have the tools to loosen the product to be taken.

Fabory Security fasteners, nuts as well as screws, provide this added level of security by their drive design that prevents removal with ordinary tools.

Fabory offers a variety of security fastener head styles, drives and of course the appropriate tools for fastening and loosening. The security screws are available in metric thread as well as sheet metal thread.

As you see using the Fabory Security fasteners will be a good fastening system together with an investment in safety. When you want to be on top of things use Fabory Security fasteners. They only can be unfastened if you want them to!



SECURITY Nut



Technical Data

d	M6-4k	M8-4k	M10-4k	M12-6k
h ≈	6.2	7	6.8	7.3
P	1	1.25	1.5	1.75

- SECURITY nuts are up to and including M10 square formed, M12 is hexagonal formed with the size 31 mm.

Assembly sequence

Special features FABORY SECURITY nuts:

- assembly has always to be done with two identical nuts
- screw the first nut onto the bolt by hand. Install the second nut upside down to a half-turn distance from the first nut resulting in a diabolicshaped unity. Both nuts can now be torqued simultaneously with an adjustable wrench. After this the upper nut can be removed by hand.
- disassembly: screw a second nut upside down onto the bolt by hand to a half-turn distance of the already assembled nut. Loosen both nuts simultaneously with an adjustable wrench.

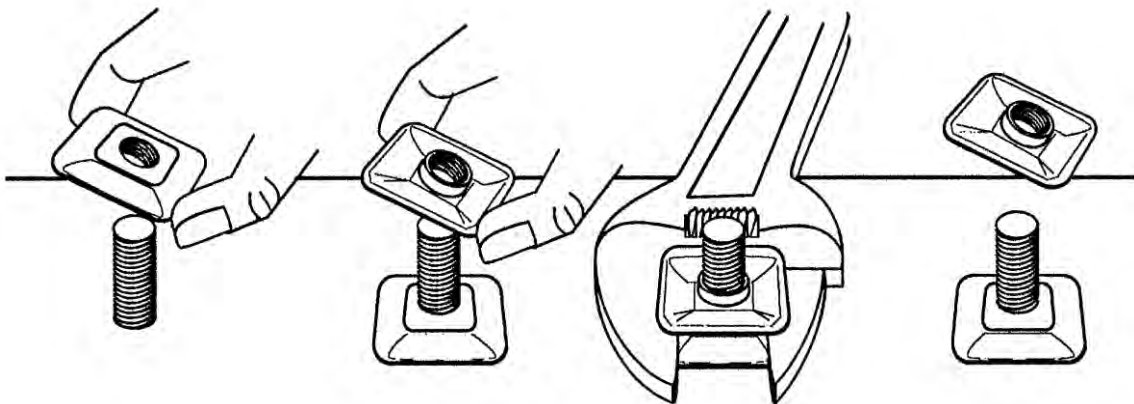

11430 SECURITY Nut		K91A	
Thread	Metric thread		
Material	Steel Min.55HRc		
Surface treatment	Zinc plated yellow passivated		



d	☒	Art.number	d	☒	Art.number	d	☒	Art.number
M6-4k	10	11430.060.001	M10-4k	10	11430.100.001	M12-6k	10	11430.120.001
M8-4k	10	11430.080.001						

SECURITY Shear nut

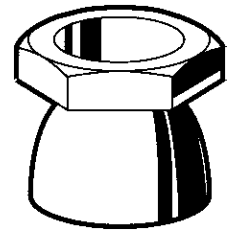
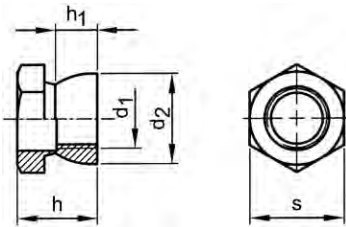

Technical Data

d ₁	d ₂	h	h ₁	P	s	Ultimate moment (Nm)
M6	9.8	9.5	4.5	1	11	7-13
M8	12.8	12	7	1.25	13	13-25
M10	16.8	15	8.5	1.5	17	30-40
M12	18.8	16	9	1.75	19	35-45
M16	23.8	22	13	2	24	45-60
M20	29.8	25	18.5	2.5	27	65-80

Assembly data

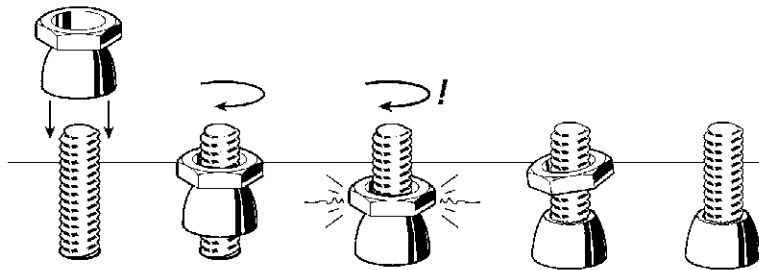

51097 SECURITY Shear nut		K91A
Thread	Metric thread	
Material	Stainless steel A2	

d ₁	☒	Art.number	d ₁	☒	Art.number	d ₁	☒	Art.number
M6 S=10	100	51097.060.001	M10 S=17	50	51097.100.001	M16 S=24	25	51097.160.001
M8 S=13	100	51097.080.001	M12 S=19	50	51097.120.001	M20*	100	51097.200.001

SECURITY Hexagon socket button head screw with pin

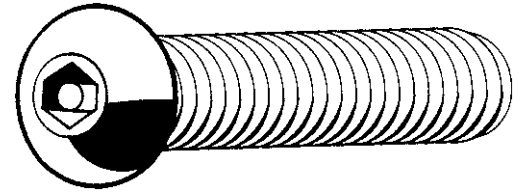
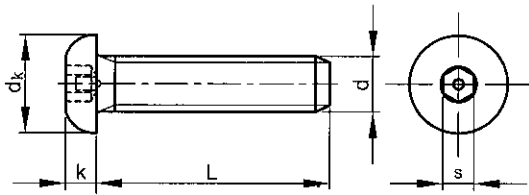

Technical Data

d	d _k (max.)	k (max.)	P	s
M3	5.7	1.65	0.5	2
M4	7.6	2.2	0.7	2.5
M5	9.5	2.75	0.8	3
M6	10.5	3.3	1	4
M8	14	4.4	1.25	5
M10	10	5.5	1.5	6

51036 SECURITY Hexagon socket button head screw with pin

K91A

Thread Metric thread
Material Stainless steel A2

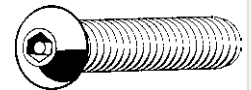

d x L	☒	Art.number	d x L	☒	Art.number	d x L	☒	Art.number
M3X6*	100	51036.030.006	M5X20	50	51036.050.020	M8X25	25	51036.080.025
M3X8*	100	51036.030.008	M5X25	25	51036.050.025	M8X30	25	51036.080.030
M3X10*	100	51036.030.010	M5X30	25	51036.050.030	M8X40	25	51036.080.040
M3X12*	100	51036.030.012	M5X40*	100	51036.050.040	M8X45*	100	51036.080.045
M3X16*	100	51036.030.016				M8X50	25	51036.080.050
M3X20*	100	51036.030.020	M6X10	25	51036.060.010	M8X60*	100	51036.080.060
			M6X12	25	51036.060.012			
M4X6*	100	51036.040.006	M6X16	25	51036.060.016	M10X16*	100	51036.100.016
M4X8*	100	51036.040.008	M6X20	25	51036.060.020	M10X20*	100	51036.100.020
M4X10	50	51036.040.010	M6X25	25	51036.060.025	M10X25*	100	51036.100.025
M4X12	50	51036.040.012	M6X30	25	51036.060.030	M10X30*	100	51036.100.030
M4X16	50	51036.040.016	M6X40	25	51036.060.040	M10X40*	100	51036.100.040
M4X20	50	51036.040.020	M6X50	25	51036.060.050	M10X45*	100	51036.100.045
M4X25	50	51036.040.025	M6X60*	100	51036.060.060	M10X50*	100	51036.100.050
M4X30	50	51036.040.030				M10X60*	100	51036.100.060
			M8X10	25	51036.080.010	M10X70*	100	51036.100.070
M5X10	50	51036.050.010	M8X12	25	51036.080.012	M10X75*	100	51036.100.075
M5X12	50	51036.050.012	M8X16	25	51036.080.016	M10X90*	100	51036.100.090
M5X16	50	51036.050.016	M8X20	25	51036.080.020			

SECURITY Hexagon socket button head screw with plug

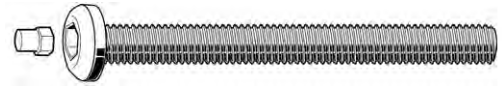
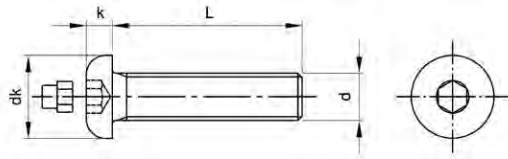

Technical Data

d	dk	k	s
M6	10.5	3.3	4
M8	14	4.4	5
M10	17.5	5.5	6
M12	21	6.6	7

51672 SECURITY Hexagon socket button head screw with plug

K91A

Thread Metric thread
Material Stainless steel A2



d x L	☒	Art.number	d x L	☒	Art.number	d x L	☒	Art.number
M6X12*	100	51672.060.012	M8X20*	100	51672.080.020	M10X35*	100	51672.100.035
M6X16*	100	51672.060.016	M8X25*	100	51672.080.025	M10X40*	100	51672.100.040
M6X20*	100	51672.060.020	M8X30*	100	51672.080.030	M10X45*	100	51672.100.045
M6X25*	100	51672.060.025	M8X40*	100	51672.080.040	M10X60*	100	51672.100.060
M6X30*	100	51672.060.030	M8X45*	100	51672.080.045	M12X25*	100	51672.120.025
M6X35*	100	51672.060.035	M8X50*	100	51672.080.050	M12X30*	100	51672.120.030
M6X50*	100	51672.060.050	M8X60*	100	51672.080.060	M12X40*	100	51672.120.040
M6X60*	100	51672.060.060	M10X25*	100	51672.100.025	M12X50*	100	51672.120.050
M8X12*	100	51672.080.012	M10X30*	100	51672.100.030	M12X60*	100	51672.120.060

SECURITY Button head screw hexalobular with pin

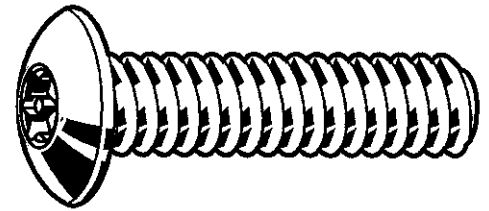
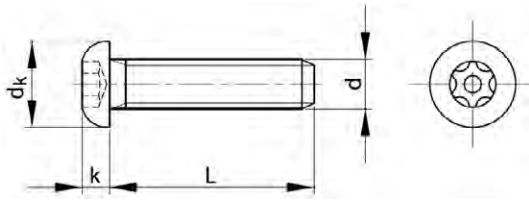

Technical Data

d	d _k (max.)	k (max.)	P	Socket
M3	5.7	1.65	0.5	T10
M4	7.6	2.2	0.7	T20
M5	9.5	2.75	0.8	T25
M6	10.5	3.3	1	T30
M8	14	4.4	1.25	T40
M10	17.5	5.5	1.5	T45

51037 SECURITY Button head screw hexalobular with pin

K91A

Thread Metric thread
Material Stainless steel A2
Class 70

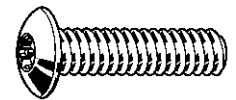

d x L	☒	Art.number	d x L	☒	Art.number	d x L	☒	Art.number
M3X6*	100	51037.030.006	M5X16	50	51037.050.016	M6X55*	100	51037.060.055
M3X8*	100	51037.030.008	M5X20	50	51037.050.020	M6X60*	100	51037.060.060
M3X10*	100	51037.030.010	M5X25	25	51037.050.025	M8X12	25	51037.080.012
M3X12*	100	51037.030.012	M5X30	25	51037.050.030	M8X16	25	51037.080.016
M3X16*	100	51037.030.016	M5X40*	100	51037.050.040	M8X20	25	51037.080.020
M3X20*	100	51037.030.020	M5X50*	100	51037.050.050	M8X25	25	51037.080.025
			M5X60*	100	51037.050.060	M8X30	25	51037.080.030
M4X6*	100	51037.040.006	M6X10	25	51037.060.010	M8X40	25	51037.080.040
M4X8*	100	51037.040.008	M6X12	25	51037.060.012	M8X50	25	51037.080.050
M4X10	50	51037.040.010	M6X14*	100	51037.060.014	M8X60*	100	51037.080.060
M4X12	50	51037.040.012	M6X16	25	51037.060.016			
M4X16	50	51037.040.016	M6X18*	100	51037.060.018	M10X16*	100	51037.100.016
M4X20	50	51037.040.020	M6X20	25	51037.060.020	M10X20*	100	51037.100.020
M4X25	50	51037.040.025	M6X22*	100	51037.060.022	M10X25*	100	51037.100.025
M4X30	50	51037.040.030	M6X25	25	51037.060.025	M10X30*	100	51037.100.030
M4X35*	100	51037.040.035	M6X30	25	51037.060.030	M10X40*	100	51037.100.040
M4X40*	100	51037.040.040	M6X35*	100	51037.060.035	M10X50*	100	51037.100.050
M4X50*	100	51037.040.050	M6X40	25	51037.060.040	M10X60*	100	51037.100.060
			M6X45*	100	51037.060.045	M10X65*	100	51037.100.065
M5X8*	100	51037.050.008	M6X50	25	51037.060.050	M10X70*	100	51037.100.070
M5X10	50	51037.050.010						
M5X12	50	51037.050.012						

SECURITY Pan head screw with 2 holes

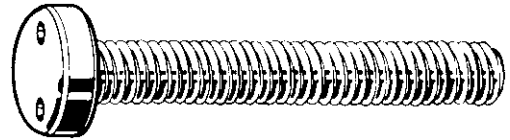
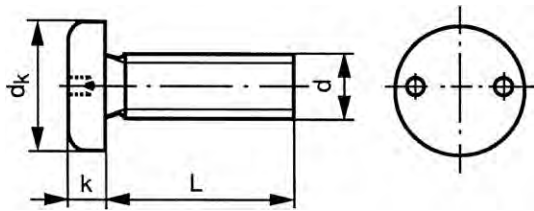

Technical Data

d	d _k	k	P	d	d _k	k	P
M3	6	1.8	0.5	M5	10	3	0.8
M4	8	2.4	0.7	M6	12	3.6	1

51591 SECURITY Pan head screw with 2 holes

K91A

Thread Metric thread
Material Stainless steel A2



d x L	☒	Art.number	d x L	☒	Art.number	d x L	☒	Art.number
M3X6*	100	51591.030.006	M4X12	10	51591.040.012	M5X30	10	51591.050.030
M3X8*	100	51591.030.008	M4X16	10	51591.040.016	M6X10*	100	51591.060.010
M3X10	10	51591.030.010	M4X20	10	51591.040.020	M6X12	10	51591.060.012
M3X12	10	51591.030.012	M4X25	10	51591.040.025	M6X16	10	51591.060.016
M3X16	10	51591.030.016	M5X10*	100	51591.050.010	M6X20	10	51591.060.020
M3X20*	100	51591.030.020	M5X12	10	51591.050.012	M6X25	10	51591.060.025
M4X6*	100	51591.040.006	M5X16	10	51591.050.016	M6X30	10	51591.060.030
M4X8*	100	51591.040.008	M5X20	10	51591.050.020	M6X40	10	51591.060.040
M4X10	10	51591.040.010	M5X25	10	51591.050.025			

SECURITY Pan head screw one-way

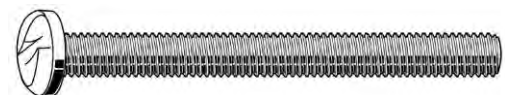
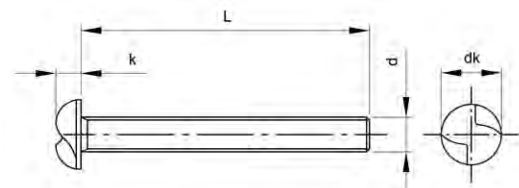

Technical Data

d	d _k	k
M4	7.5	3
M5	9.17	3.5
M6	12	4.4
M8	13	4.8

51667 SECURITY Pan head screw one-way

K91A

Thread Metric thread
Material Stainless steel A2



d x L	☒	Art.number	d x L	☒	Art.number	d x L	☒	Art.number
M4X8*	100	51667.040.008	M4X50*	100	51667.040.050	M5X40*	100	51667.050.040
M4X10*	100	51667.040.010	M5X8*	100	51667.050.008	M5X50*	100	51667.050.050
M4X12*	100	51667.040.012	M5X10*	100	51667.050.010	M5X60*	100	51667.050.060
M4X16*	100	51667.040.016	M5X12*	100	51667.050.012	M5X70*	100	51667.050.070
M4X20*	100	51667.040.020	M5X16*	100	51667.050.016	M6X10*	100	51667.060.010
M4X25*	100	51667.040.025	M5X20*	100	51667.050.020	M6X12*	100	51667.060.012
M4X30*	100	51667.040.030	M5X25*	100	51667.050.025	M6X16*	100	51667.060.016
M4X35*	100	51667.040.035	M5X30*	100	51667.050.030	M6X20*	100	51667.060.020
M4X40*	100	51667.040.040						

51667 SECURITY Pan head screw one-way								
d x L	☒	Art.number	d x L	☒	Art.number	d x L	☒	Art.number
M6X25*	100	51667.060.025	M6X70*	100	51667.060.070	M8X30*	100	51667.080.030
M6X30*	100	51667.060.030				M8X35*	100	51667.080.035
M6X35*	100	51667.060.035	M8X10*	100	51667.080.010	M8X40*	100	51667.080.040
M6X40*	100	51667.060.040	M8X12*	100	51667.080.012	M8X45*	100	51667.080.045
M6X45*	100	51667.060.045	M8X16*	100	51667.080.016	M8X50*	100	51667.080.050
M6X50*	100	51667.060.050	M8X20*	100	51667.080.020	M8X60*	100	51667.080.060
M6X60*	100	51667.060.060	M8X25*	100	51667.080.025	M8X70*	100	51667.080.070

SECURITY Hexagon socket countersunk head screw with pin

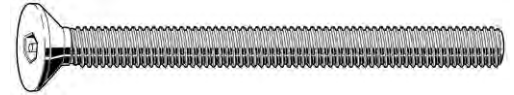
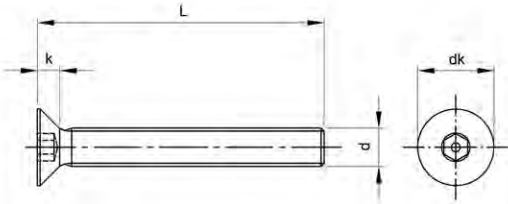

Technical Data			
d	dk	k	Socket
M3	6	1.75	2
M4	8	2.4	2.5
M5	10	2.95	3
M6	12	3.45	4
M8	16	4.6	5
M10	20	5.5	6

51578 SECURITY Hexagon socket countersunk head screw with pin		K91A
Thread	Metric thread	
Material	Stainless steel A2	

d x L	☒	Art.number	d x L	☒	Art.number	d x L	☒	Art.number
M3X6*	100	51578.030.006	M5X12*	100	51578.050.012	M8X10*	100	51578.080.010
M3X8*	100	51578.030.008	M5X16*	100	51578.050.016	M8X12*	100	51578.080.012
M3X10*	100	51578.030.010	M5X20*	100	51578.050.020	M8X16*	100	51578.080.016
M3X12*	100	51578.030.012	M5X25*	100	51578.050.025	M8X20*	100	51578.080.020
M3X16*	100	51578.030.016	M5X30*	100	51578.050.030	M8X25*	100	51578.080.025
M3X20*	100	51578.030.020	M5X40*	100	51578.050.040	M8X30*	100	51578.080.030
			M5X50*	100	51578.050.050	M8X40*	100	51578.080.040
M4X8*	100	51578.040.008	M6X10*	100	51578.060.010	M8X50*	100	51578.080.050
M4X10*	100	51578.040.010	M6X12*	100	51578.060.012	M8X60*	100	51578.080.060
M4X12*	100	51578.040.012	M6X16*	100	51578.060.016			
M4X16*	100	51578.040.016	M6X20*	100	51578.060.020	M10X25*	100	51578.100.025
M4X20*	100	51578.040.020	M6X25*	100	51578.060.025	M10X30*	100	51578.100.030
M4X25*	100	51578.040.025	M6X30*	100	51578.060.030	M10X40*	100	51578.100.040
M4X30*	100	51578.040.030	M6X40*	100	51578.060.040	M10X50*	100	51578.100.050
M4X40*	100	51578.040.040	M6X50*	100	51578.060.050	M10X60*	100	51578.100.060
M5X10*	100	51578.050.010						

SECURITY Hexagon socket countersunk head screw with plug

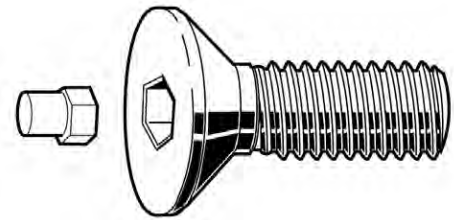
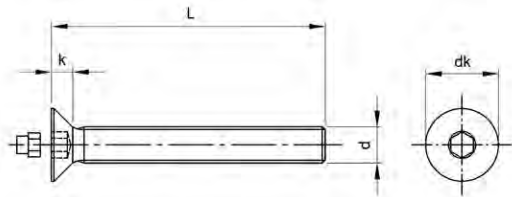

Technical Data

d	d _k	k	Socket
M6	12	3.45	4
M8	16	4.6	5
M10	20	5.5	6
M12	24	6.5	8

51673 SECURITY Hexagon socket countersunk head screw with plug

K91A

Thread Metric thread
Material Stainless steel A2
Class 50



d x L	☒	Art.number	d x L	☒	Art.number	d x L	☒	Art.number
M6X12*	100	51673.060.012	M6X50*	100	51673.060.050	M8X60*	100	51673.080.060
M6X20*	100	51673.060.020	M8X16*	100	51673.080.016	M10X25*	100	51673.100.025
M6X25*	100	51673.060.025	M8X40*	100	51673.080.040	M12X30*	100	51673.120.030
M6X30*	100	51673.060.030	M8X50*	100	51673.080.050			
M6X40*	100	51673.060.040						

SECURITY Countersunk head screw hexalobular with pin

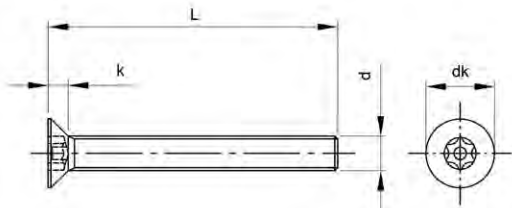

Technical Data

d	d _k	k	Socket
M3	6	1.75	T10
M4	8	2.4	T20
M5	10	2.95	T25
M6	12	3.45	T30

51574 SECURITY Countersunk head screw hexalobular with pin

K91A

Thread Metric thread
Material Stainless steel A2
Class 50



d x L	☒	Art.number	d x L	☒	Art.number	d x L	☒	Art.number
M3X6*	100	51574.030.006	M4X16*	100	51574.040.016	M5X20*	100	51574.050.020
M3X8*	100	51574.030.008	M4X20*	100	51574.040.020	M5X25*	100	51574.050.025
M3X10*	100	51574.030.010	M4X25*	100	51574.040.025	M5X30*	100	51574.050.030
M3X12*	100	51574.030.012	M4X30*	100	51574.040.030	M5X40*	100	51574.050.040
M3X16*	100	51574.030.016	M4X40*	100	51574.040.040	M5X50*	100	51574.050.050
M3X20*	100	51574.030.020	M4X50*	100	51574.040.050	M5X60*	100	51574.050.060
M4X6*	100	51574.040.006	M5X8*	100	51574.050.008	M5X70*	100	51574.050.070
M4X8*	100	51574.040.008	M5X10*	100	51574.050.010	M5X80*	100	51574.050.080
M4X10*	100	51574.040.010	M5X12*	100	51574.050.012	M6X10*	100	51574.060.010
M4X12*	100	51574.040.012	M5X16*	100	51574.050.016	M6X12*	100	51574.060.012

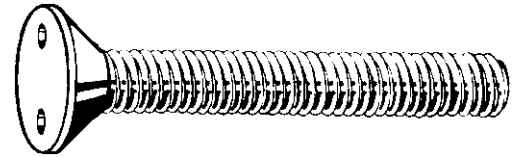
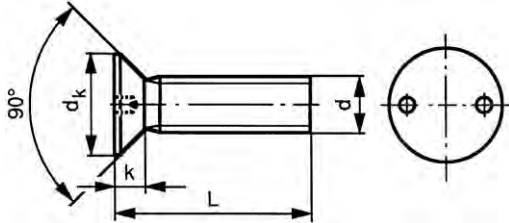

51574 SECURITY Countersunk head screw hexalobular with pin								
d x L	☒	Art.number	d x L	☒	Art.number	d x L	☒	Art.number
M6X16*	100	51574.060.016	M6X30*	100	51574.060.030	M6X60*	100	51574.060.060
M6X20*	100	51574.060.020	M6X40*	100	51574.060.040			
M6X25*	100	51574.060.025	M6X50*	100	51574.060.050			

SECURITY Countersunk head screw with 2 holes



Technical Data

d	dk	k (max.)	P	d	dk	k (max.)	P
M3	6.3	1.7	0.5	M5	10.4	2.7	0.8
M4	9.4	2.7	0.7	M6	12.6	3.3	1

51592 SECURITY Countersunk head screw with 2 holes		K91A
Thread	Metric thread	
Material	Stainless steel A2	
		
		

d x L	☒	Art.number	d x L	☒	Art.number	d x L	☒	Art.number
M3X10	10	51592.030.010	M4X20	10	51592.040.020	M5X30	10	51592.050.030
M3X12	10	51592.030.012	M4X25	10	51592.040.025			
M3X16	10	51592.030.016				M6X12	10	51592.060.012
			M5X12	10	51592.050.012	M6X20	10	51592.060.020
M4X10	10	51592.040.010	M5X16	10	51592.050.016	M6X25	10	51592.060.025
M4X12	10	51592.040.012	M5X20	10	51592.050.020	M6X30	10	51592.060.030
M4X16	10	51592.040.016	M5X25	10	51592.050.025	M6X40	10	51592.060.040

SECURITY Hexagon socket button head screw with pin

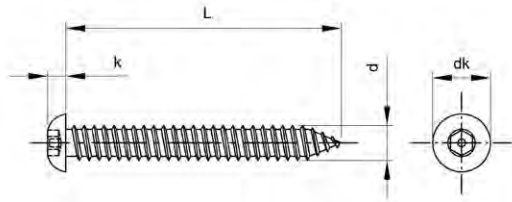

Technical Data

d	d _k	k	Socket
ST3.5	5.7	1.65	2
ST4.2	7.6	2.2	2.5
ST4.8	9.5	2.75	3
ST6.3	10.5	3.3	4

51599 SECURITY Hexagon socket button head screw with pin

K91A

Thread Self tapping thread
Material Stainless steel A2



d x L	☒	Art.number	d x L	☒	Art.number	d x L	☒	Art.number
ST3,5X9,5MM*	100	51599.035.009	ST4,2X19MM*	100	51599.042.019	ST4,8X32MM*	100	51599.048.032
ST3,5X13MM*	100	51599.035.013	ST4,2X25MM*	100	51599.042.025	ST4,8X38MM*	100	51599.048.038
ST3,5X16MM*	100	51599.035.016	ST4,2X32MM*	100	51599.042.032	ST4,8X50MM*	100	51599.048.050
ST3,5X19MM*	100	51599.035.019	ST4,2X38MM*	100	51599.042.038	ST6,3X16MM*	100	51599.063.016
ST3,5X25MM*	100	51599.035.025	ST4,2X50MM*	100	51599.042.050	ST6,3X19MM*	100	51599.063.019
ST3,5X38MM*	100	51599.035.038	ST4,8X13MM*	100	51599.048.013	ST6,3X25MM*	100	51599.063.025
ST4,2X9,5MM*	100	51599.042.009	ST4,8X16MM*	100	51599.048.016	ST6,3X32MM*	100	51599.063.032
ST4,2X13MM*	100	51599.042.013	ST4,8X19MM*	100	51599.048.019	ST6,3X38MM*	100	51599.063.038
ST4,2X16MM*	100	51599.042.016	ST4,8X25MM*	100	51599.048.025	ST6,3X50MM*	100	51599.063.050

SECURITY Button head hexalobular with pin

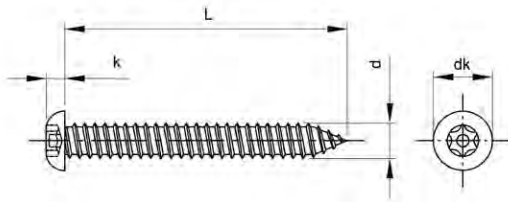

Technical Data

d	d _k	k	Socket
ST3.5	5.7	1.65	T10
ST4.2	7.6	2.2	T15
ST4.8	9.5	2.75	T25
ST5.5	9.9	2.9	T27
ST6.3	10.5	3.3	T27

51572 SECURITY Button head hexalobular with pin

K91A

Thread Self tapping thread
Material Stainless steel A2



d x L	☒	Art.number	d x L	☒	Art.number	d x L	☒	Art.number
ST3,5X13MM*	100	51572.035.013	ST4,8X13MM*	100	51572.048.013	ST5,5X50MM*	100	51572.055.050
ST3,5X19MM*	100	51572.035.019	ST4,8X19MM*	100	51572.048.019	ST5,5X63MM*	100	51572.055.063
ST3,5X25MM*	100	51572.035.025	ST4,8X25MM*	100	51572.048.025	ST5,5X75MM*	100	51572.055.075
ST3,5X38MM*	100	51572.035.038	ST4,8X32MM*	100	51572.048.032			
			ST4,8X38MM*	100	51572.048.038	ST6,3X13MM*	100	51572.063.013
ST4,2X13MM*	100	51572.042.013	ST4,8X50MM*	100	51572.048.050	ST6,3X19MM*	100	51572.063.019
ST4,2X19MM*	100	51572.042.019				ST6,3X25MM*	100	51572.063.025
ST4,2X25MM*	100	51572.042.025	ST5,5X19MM*	100	51572.055.019	ST6,3X32MM*	100	51572.063.032
ST4,2X32MM*	100	51572.042.032	ST5,5X32MM*	100	51572.055.032	ST6,3X38MM*	100	51572.063.038
ST4,2X38MM*	100	51572.042.038	ST5,5X38MM*	100	51572.055.038	ST6,3X50MM*	100	51572.063.050

SECURITY Cross recessed pan head tapping screw with pin

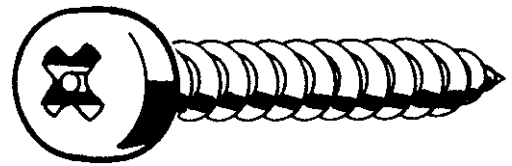
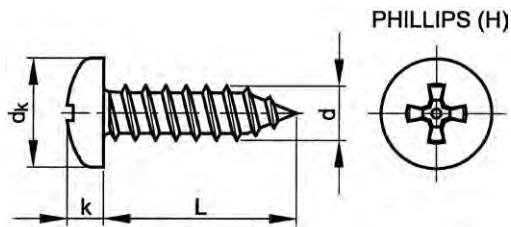

Technical Data

d	dk ≈	k ≈	No. cross recess	P
ST3.5	7	2.5	2	1.3
ST4.2	8.1	2.8	2	1.4
ST4.8	9.3	3.5	2	1.6
ST5.5	10.6	3.8	3	1.8

51593 SECURITY Cross recessed pan head tapping screws Phillips with pin

K91A

Thread Self tapping thread
Material Stainless steel A2

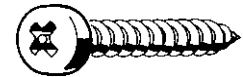

d x L	⊠	Art.number	d x L	⊠	Art.number	d x L	⊠	Art.number
ST3,5X13MM	10	51593.035.013	ST4,2X32MM	10	51593.042.032	ST4,8X50MM	10	51593.048.050
ST3,5X19MM	10	51593.035.019	ST4,2X38MM	10	51593.042.038	ST5,5X19MM	10	51593.055.019
ST3,5X25MM	10	51593.035.025	ST4,8X13MM	10	51593.048.013	ST5,5X25MM	10	51593.055.025
ST3,5X38MM	10	51593.035.038	ST4,8X19MM	10	51593.048.019	ST5,5X32MM	10	51593.055.032
ST4,2X13MM	10	51593.042.013	ST4,8X25MM	10	51593.048.025	ST5,5X38MM	10	51593.055.038
ST4,2X19MM	10	51593.042.019	ST4,8X32MM	10	51593.048.032	ST5,5X50MM	10	51593.055.050
ST4,2X25MM	10	51593.042.025	ST4,8X38MM	10	51593.048.038			

SECURITY Pan head tapping screw with 2 holes

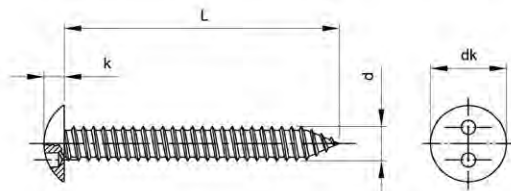

Technical Data

d	dk	k
ST4.2	9.5	2.2
ST4.8	10.5	2.75

51598 SECURITY Pan head tapping screw with 2 holes

K91A

Thread Self tapping thread
Material Stainless steel A2



d x L	⊠	Art.number	d x L	⊠	Art.number	d x L	⊠	Art.number
ST4,2X13MM*	100	51598.042.013	ST4,8X9,5MM*	100	51598.048.009	ST4,8X25MM*	100	51598.048.025
ST4,2X19MM*	100	51598.042.019	ST4,8X13MM*	100	51598.048.013	ST4,8X32MM*	100	51598.048.032
ST4,2X25MM*	100	51598.042.025	ST4,8X19MM*	100	51598.048.019	ST4,8X38MM*	100	51598.048.038
ST4,2X32MM*	100	51598.042.032				ST4,8X50MM*	100	51598.048.050
ST4,2X38MM*	100	51598.042.038						

SECURITY Cheese head tapping screw with 2 holes

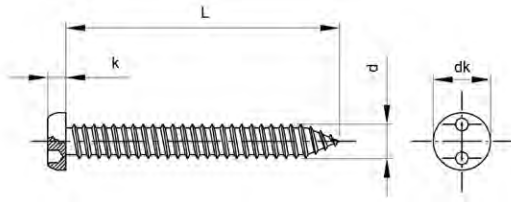

Technical Data

d	d _k	k
ST2.9	5.6	1.65
ST3.5	5.7	1.65
ST4.2	7.6	2.2
ST4.8	9.5	2.75
ST5.5	10.5	3.3
ST6.3	12.4	3.3

51595 SECURITY Cheese head tapping screw with 2 holes

K91A

Thread Self tapping thread
Material Stainless steel A2



d x L	☒	Art.number	d x L	☒	Art.number	d x L	☒	Art.number
ST2,9X6,5MM*	100	51595.029.006	ST3,5X50MM*	100	51595.035.050	ST4,8X32MM*	100	51595.048.032
ST2,9X9,5MM*	100	51595.029.009	ST4,2X13MM*	100	51595.042.013	ST4,8X38MM*	100	51595.048.038
ST2,9X13MM*	100	51595.029.013	ST4,2X16MM*	100	51595.042.016	ST4,8X45MM*	100	51595.048.045
ST2,9X16MM*	100	51595.029.016	ST4,2X19MM*	100	51595.042.019	ST4,8X50MM*	100	51595.048.050
ST2,9X19MM*	100	51595.029.019	ST4,2X25MM*	100	51595.042.025	ST5,5X13MM*	100	51595.055.013
ST2,9X25MM*	100	51595.029.025	ST4,2X32MM*	100	51595.042.032	ST5,5X19MM*	100	51595.055.019
ST3,5X6,5MM*	100	51595.035.006	ST4,2X38MM*	100	51595.042.038	ST5,5X25MM*	100	51595.055.025
ST3,5X9,5MM*	100	51595.035.009	ST4,2X45MM*	100	51595.042.045	ST5,5X32MM*	100	51595.055.032
ST3,5X13MM*	100	51595.035.013	ST4,2X50MM*	100	51595.042.050	ST5,5X38MM*	100	51595.055.038
ST3,5X16MM*	100	51595.035.016	ST4,8X13MM*	100	51595.048.013	ST5,5X50MM*	100	51595.055.050
ST3,5X19MM*	100	51595.035.019	ST4,8X16MM*	100	51595.048.016	ST6,3X25MM*	100	51595.063.025
ST3,5X25MM*	100	51595.035.025	ST4,8X19MM*	100	51595.048.019	ST6,3X32MM*	100	51595.063.032
ST3,5X32MM*	100	51595.035.032	ST4,8X25MM*	100	51595.048.025	ST6,3X50MM*	100	51595.063.050
ST3,5X38MM*	100	51595.035.038						

SECURITY One-way tapping screw

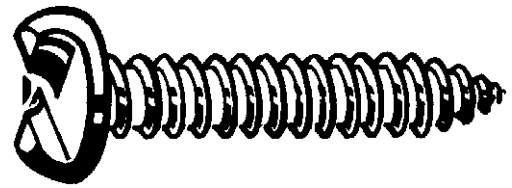
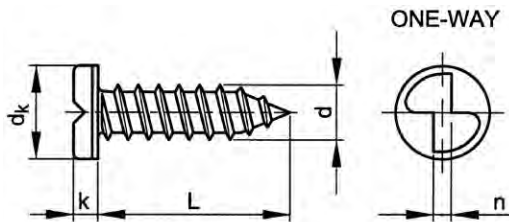

Technical Data

d	d _k	k	n	P
ST2.9	5.6	1.75	0.8	1.1
ST3.5	6.9	2.1	1	1.3
ST4.2	8.2	2.45	1.2	1.4
ST4.8	9.1	3.5	1.4	1.6
ST5.5	10.4	3.9	1.6	1.8
ST6.3	12	4.4	2.0	1.8

Article groups

Thread	Driving features	Material	Surface treatment	Code	Page
ST	One-way	St	Zipl	26910	10-121
ST	One-way	St.St. A2		51668	10-121

26910 SECURITY One-way tapping screw

K91A

Thread	Self tapping thread
Material	Steel
Surface treatment	Zinc plated



d x L	☒	Art.number	d x L	☒	Art.number	d x L	☒	Art.number
ST2,9X19MM	200	26910.029.019	ST3,5X25MM	200	26910.035.025	ST4,2X32MM	200	26910.042.032
ST3,5X13MM	200	26910.035.013	ST4,2X19MM	200	26910.042.019	ST4,2X38MM	200	26910.042.038
ST3,5X19MM	200	26910.035.019	ST4,2X25MM	200	26910.042.025	ST4,2X50MM	200	26910.042.050
						ST4,2X63MM	200	26910.042.063

51668 SECURITY One-way tapping screw

K91A

Thread	Self tapping thread
Material	Stainless steel A2



d x L	☒	Art.number	d x L	☒	Art.number	d x L	☒	Art.number
ST2,9X9,5MM	200	51668.029.009	ST4,2X32MM	200	51668.042.032	ST5,5X25MM*	100	51668.055.025
ST2,9X13MM	200	51668.029.013	ST4,2X38MM	200	51668.042.038	ST5,5X32MM*	100	51668.055.032
ST2,9X16MM*	100	51668.029.016	ST4,2X50MM	200	51668.042.050	ST5,5X38MM*	100	51668.055.038
ST2,9X19MM	200	51668.029.019				ST5,5X50MM*	100	51668.055.050
			ST4,8X13MM*	100	51668.048.013	ST5,5X63MM*	100	51668.055.063
ST3,5X13MM	200	51668.035.013	ST4,8X16MM*	100	51668.048.016			
ST3,5X16MM*	100	51668.035.016	ST4,8X19MM*	100	51668.048.019	ST6,3X19MM*	100	51668.063.019
ST3,5X19MM	200	51668.035.019	ST4,8X25MM*	100	51668.048.025	ST6,3X25MM*	100	51668.063.025
ST3,5X25MM	200	51668.035.025	ST4,8X32MM*	100	51668.048.032	ST6,3X32MM*	100	51668.063.032
ST3,5X32MM*	100	51668.035.032	ST4,8X38MM*	100	51668.048.038	ST6,3X38MM*	100	51668.063.038
			ST4,8X50MM*	100	51668.048.050	ST6,3X50MM*	100	51668.063.050
ST4,2X13MM*	100	51668.042.013				ST6,3X63MM*	100	51668.063.063
ST4,2X19MM	200	51668.042.019	ST5,5X19MM*	100	51668.055.019	ST6,3X75MM*	100	51668.063.075
ST4,2X25MM	200	51668.042.025						

SECURITY Mushroom head tapping screw with Tri-wing recessed

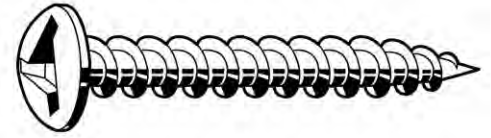
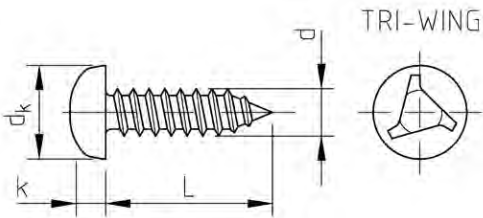

Technical Data

d	d _k	k	No. Tri-Wing	P
ST4.2	8.18	2.44	W4	1.7
ST4.8	9.48	2.88	W5	2

51669 SECURITY Mushroom head tapping screw with Tri-wing recessed

K91A

Thread Self tapping thread
Material Stainless steel A2



d x L	☒	Art.number	d x L	☒	Art.number	d x L	☒	Art.number
ST4,2X13MM	10	51669.042.013	ST4,2X32MM	10	51669.042.032	ST4,8X19MM	10	51669.048.019
ST4,2X19MM	10	51669.042.019				ST4,8X25MM	10	51669.048.025
ST4,2X25MM	10	51669.042.025	ST4,8X13MM	10	51669.048.013			

SECURITY Hexagon socket countersunk head screw with pin

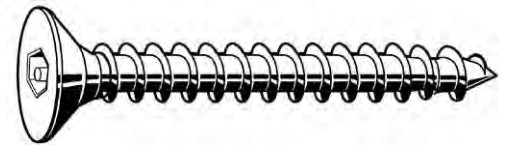
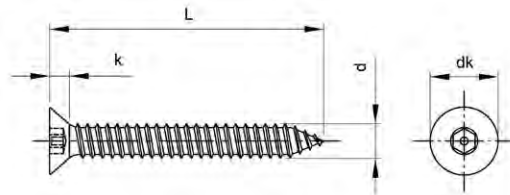

Technical Data

d	d _k	k	Socket
ST3.5	6.8	2.15	2
ST4.2	8.1	2.6	2.5
ST4.8	9.5	3.15	3
ST5.5	10.8	3.55	4
ST6.3	12.4	4	4

51588 SECURITY Hexagon socket countersunk head screw with pin

K91A

Thread Self tapping thread
Material Stainless steel A2



d x L	☒	Art.number	d x L	☒	Art.number	d x L	☒	Art.number
ST3,5X9,5MM*	100	51588.035.009	ST4,2X38MM*	100	51588.042.038	ST5,5X19MM*	100	51588.055.019
ST3,5X19MM*	100	51588.035.019	ST4,2X50MM*	100	51588.042.050	ST5,5X32MM*	100	51588.055.032
ST3,5X25MM*	100	51588.035.025						
ST3,5X38MM*	100	51588.035.038	ST4,8X16MM*	100	51588.048.016	ST6,3X19MM*	100	51588.063.019
ST4,2X13MM*	100	51588.042.013	ST4,8X19MM*	100	51588.048.019	ST6,3X25MM*	100	51588.063.025
ST4,2X16MM*	100	51588.042.016	ST4,8X25MM*	100	51588.048.025	ST6,3X50MM*	100	51588.063.050
ST4,2X19MM*	100	51588.042.019	ST4,8X32MM*	100	51588.048.032			
ST4,2X25MM*	100	51588.042.025	ST4,8X38MM*	100	51588.048.038			
			ST4,8X50MM*	100	51588.048.050			

SECURITY Countersunk head hexalobular with pin

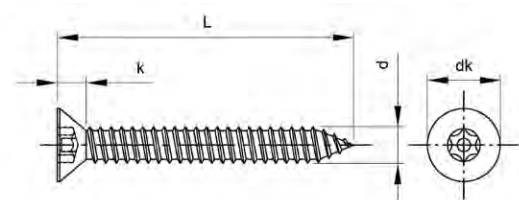

Technical Data

d	d _k	k	Socket
ST3.5	6.8	2.15	T15
ST4.2	8.1	2.6	T20
ST4.8	9.5	3.15	T25
ST5.5	10.8	3.55	T27
ST6.3	12.4	4	T30

51573 SECURITY Countersunk head hexalobular with pin

K91A

Thread Self tapping thread
Material Stainless steel A2



d x L	☒	Art.number	d x L	☒	Art.number	d x L	☒	Art.number
ST3,5X13MM*	100	51573.035.013	ST4,2X32MM*	100	51573.042.032	ST5,5X25MM*	100	51573.055.025
ST3,5X16MM*	100	51573.035.016	ST4,2X38MM*	100	51573.042.038	ST5,5X38MM*	100	51573.055.038
ST3,5X19MM*	100	51573.035.019				ST5,5X50MM*	100	51573.055.050
ST3,5X25MM*	100	51573.035.025	ST4,8X13MM*	100	51573.048.013	ST5,5X75MM*	100	51573.055.075
ST3,5X32MM*	100	51573.035.032	ST4,8X16MM*	100	51573.048.016			
ST3,5X38MM*	100	51573.035.038	ST4,8X19MM*	100	51573.048.019	ST6,3X16MM*	100	51573.063.016
			ST4,8X25MM*	100	51573.048.025	ST6,3X19MM*	100	51573.063.019
ST4,2X13MM*	100	51573.042.013	ST4,8X32MM*	100	51573.048.032	ST6,3X25MM*	100	51573.063.025
ST4,2X16MM*	100	51573.042.016	ST4,8X38MM*	100	51573.048.038	ST6,3X32MM*	100	51573.063.032
ST4,2X19MM*	100	51573.042.019	ST4,8X50MM*	100	51573.048.050	ST6,3X38MM*	100	51573.063.038
ST4,2X25MM*	100	51573.042.025				ST6,3X50MM*	100	51573.063.050

SECURITY Cross recessed countersunk head tapping screw with pin

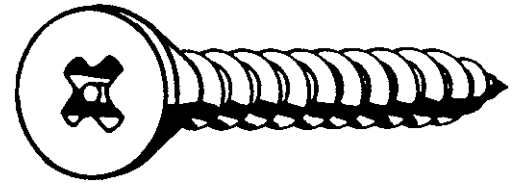
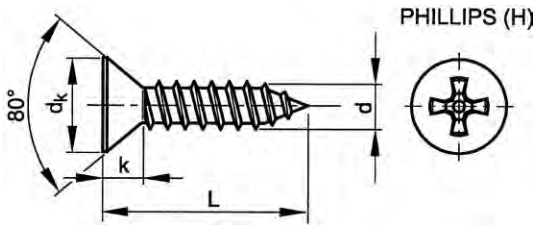

Technical Data

d	d _k ≈	k ≈	No. cross recess	P
ST3.5	6.7	2.7	2	1.3
ST4.2	8.3	3.4	2	1.4
ST4.8	9	3.4	2	1.6
ST5.5	10.6	4.3	3	1.8

51594 SECURITY Cross recessed Phillips countersunk head tapping screw with pin

K91A

Thread Self tapping thread
Material Stainless steel A2



d x L	☒	Art.number	d x L	☒	Art.number	d x L	☒	Art.number
ST3,5X13MM	10	51594.035.013	ST4,2X32MM	10	51594.042.032	ST4,8X50MM	10	51594.048.050
ST3,5X25MM	10	51594.035.025	ST4,2X38MM	10	51594.042.038			
ST3,5X32MM	10	51594.035.032				ST5,5X19MM	10	51594.055.019
ST3,5X38MM	10	51594.035.038	ST4,8X19MM	10	51594.048.019	ST5,5X25MM	10	51594.055.025
			ST4,8X25MM	10	51594.048.025	ST5,5X32MM	10	51594.055.032
ST4,2X19MM	10	51594.042.019	ST4,8X32MM	10	51594.048.032	ST5,5X38MM	10	51594.055.038
ST4,2X25MM	10	51594.042.025	ST4,8X38MM	10	51594.048.038	ST5,5X50MM	10	51594.055.050

SECURITY Countersunk tapping screw with 2 holes

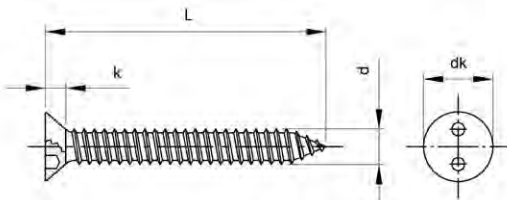

Technical Data

d	d _k	k
ST2.9	5.6	1.7
ST3.5	6.8	2.15
ST4.2	8.1	2.6
ST4.8	9.5	3.15
ST5.5	10.8	3.55
ST6.3	12.4	4

51596 SECURITY Countersunk tapping screw with 2 holes

K91A

Thread Self tapping thread
Material Stainless steel A2



d x L	☒	Art.number	d x L	☒	Art.number	d x L	☒	Art.number
ST2,9X6,5MM*	100	51596.029.006	ST3,5X13MM*	100	51596.035.013	ST4,2X13MM*	100	51596.042.013
ST2,9X9,5MM*	100	51596.029.009	ST3,5X16MM*	100	51596.035.016	ST4,2X16MM*	100	51596.042.016
ST2,9X13MM*	100	51596.029.013	ST3,5X19MM*	100	51596.035.019	ST4,2X19MM*	100	51596.042.019
ST2,9X19MM*	100	51596.029.019	ST3,5X25MM*	100	51596.035.025	ST4,2X25MM*	100	51596.042.025
ST2,9X25MM*	100	51596.029.025	ST3,5X32MM*	100	51596.035.032	ST4,2X32MM*	100	51596.042.032
			ST3,5X38MM*	100	51596.035.038	ST4,2X38MM*	100	51596.042.038
ST3,5X9,5MM*	100	51596.035.009				ST4,2X50MM*	100	51596.042.050

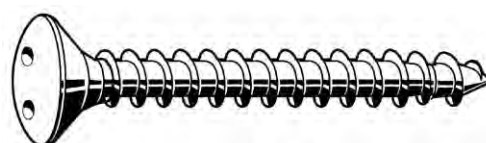
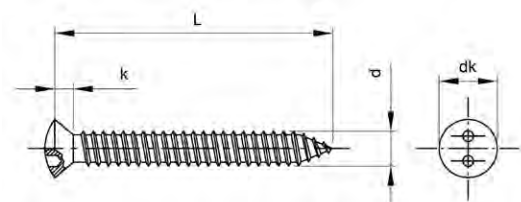

51596 SECURITY Countersunk tapping screw with 2 holes								
d x L	☒	Art.number	d x L	☒	Art.number	d x L	☒	Art.number
ST4,8X13MM*	100	51596.048.013	ST4,8X38MM*	100	51596.048.038	ST5,5X38MM*	100	51596.055.038
ST4,8X16MM*	100	51596.048.016	ST4,8X45MM*	100	51596.048.045	ST5,5X50MM*	100	51596.055.050
ST4,8X19MM*	100	51596.048.019	ST4,8X50MM*	100	51596.048.050			
ST4,8X25MM*	100	51596.048.025	ST5,5X25MM*	100	51596.055.025	ST6,3X50MM*	100	51596.063.050
ST4,8X32MM*	100	51596.048.032	ST5,5X32MM*	100	51596.055.032			

SECURITY Raised countersunk head tapping screw with 2 holes



Technical Data

d	dk	k
3.5	5.7	1.65
4.2	7.6	2.2
4.8	9.5	2.75

51597 SECURITY Raised countersunk head tapping screw with 2 holes		K91A
Thread	Self tapping thread	
Material	Stainless steel A2	
		
		

d x L	☒	Art.number	d x L	☒	Art.number	d x L	☒	Art.number
ST3,5X16MM*	100	51597.035.016	ST4,2X13MM*	100	51597.042.013	ST4,8X13MM*	100	51597.048.013
ST3,5X19MM*	100	51597.035.019	ST4,2X19MM*	100	51597.042.019	ST4,8X19MM*	100	51597.048.019
ST3,5X25MM*	100	51597.035.025	ST4,2X25MM*	100	51597.042.025	ST4,8X25MM*	100	51597.048.025
ST3,5X32MM*	100	51597.035.032	ST4,2X32MM*	100	51597.042.032	ST4,8X32MM*	100	51597.048.032
ST3,5X38MM*	100	51597.035.038	ST4,2X38MM*	100	51597.042.038	ST4,8X38MM*	100	51597.048.038
ST3,5X50MM*	100	51597.035.050	ST4,2X50MM*	100	51597.042.050			

SECURITY Raised countersunk head tapping screw one-way

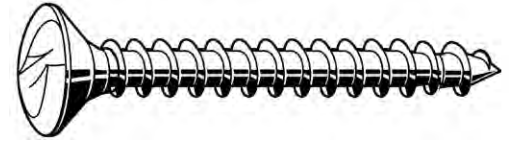
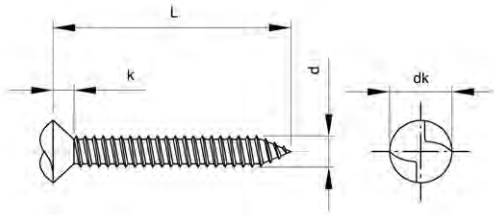



Technical Data

d	d_k	k
4.2	8.4	3.9
4.8	9.8	4.5

51671 SECURITY Raised countersunk head tapping screw one-way K91A

Thread Self tapping thread
Material Stainless steel A2

d x L	☒	Art.number	d x L	☒	Art.number	d x L	☒	Art.number
ST4,2X13MM*	100	51671.042.013	ST4,2X38MM*	100	51671.042.038	ST4,8X19MM*	100	51671.048.019
ST4,2X19MM*	100	51671.042.019				ST4,8X25MM*	100	51671.048.025
ST4,2X25MM*	100	51671.042.025	ST4,8X13MM*	100	51671.048.013	ST4,8X38MM*	100	51671.048.038
ST4,2X32MM*	100	51671.042.032						

SECURITY Square socket drive round head wood screw

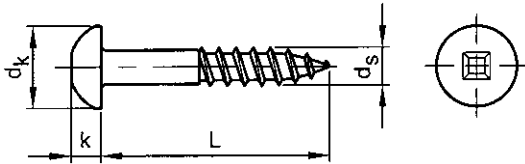

Technical Data



d_s	d_k	k (max.)	No. square
4.2	8	2.8	2

Article groups

Driving features	Material	Surface treatment	Code	Page
Square socket	St	Zipl	25750	10-126
Square socket	St	Zipl fully threaded	25751	10-127

25750 SECURITY Square socket drive round head wood screw K05A

Material Steel
Surface treatment Zinc plated

d_s x L	☒	Art.number	d_s x L	☒	Art.number	d_s x L	☒	Art.number
4,2X32MM	200	25750.042.032	4,2X38MM	200	25750.042.038	4,2X50MM	200	25750.042.050

25751	SECURITY Square socket drive round head wood screw fully threaded	K05A
Material	Steel	
Surface treatment	Zinc plated	
		 

d_s x L	✉	Art.number	d_s x L	✉	Art.number
4,2X19MM	200	25751.042.019	4,2X25MM	200	25751.042.025

SECURITY Drive-in plug for hexagon socket

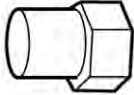

Technical Data	
d	s
M4	4
M5	5
M6	6
M8	8

51674	SECURITY Drive-in plug for hexagon socket	K91A
Material	Stainless steel A1	
		 

d	✉	Art.number	d	✉	Art.number	d	✉	Art.number
M4*	100	51674.040.001	M6*	100	51674.060.001	M8*	100	51674.080.001
M5*	100	51674.050.001						

SECURITY Drive-in plug for hexalobular drive

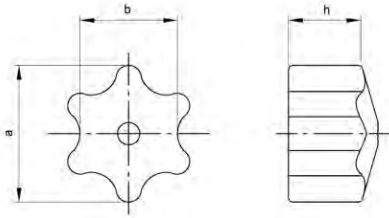

Technical Data

d	a	b	h	Socket
10	2.74	2.05	1.1	T10
15	3.27	2.4	1.8	T15
20	3.86	2.85	1.6	T20
25	4.43	3.25	2.45	T25
30	5.52	4.05	2.2	T30
40	6.65	4.85	3.4	T40

51675 SECURITY Drive-in plug for hexalobular drive

K91A

Material Stainless steel



Size	☒	Art.number	Size	☒	Art.number	Size	☒	Art.number
T10*	100	51675.000.010	T20*	100	51675.000.020	T30*	100	51675.000.030
T15*	100	51675.000.015	T25*	100	51675.000.025	T40*	100	51675.000.040

Welding stud

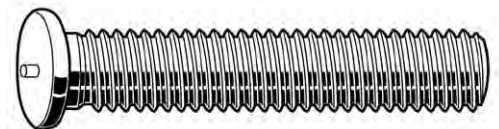
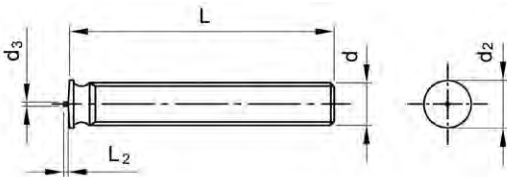

Technical Data

d ₂	d ₂	d ₃	k	L ₂
M3	4.5	0.5	0.7	0.5
M4	5.5	0.6	0.7	0.7
M5	6.5	0.8	0.8	0.8
M6	7.5	0.9	0.8	1.0
M8	9	1.2	0.8	1.4

51190 Welding stud

R09A

Thread Metric thread
Material Stainless steel A2

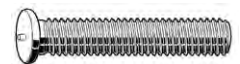

d x L	☒	Art.number	d x L	☒	Art.number	d x L	☒	Art.number
M3X8*	500	51190.030.008	M4X20*	500	51190.040.020	M5X30*	500	51190.050.030
M3X10*	500	51190.030.010	M4X25*	500	51190.040.025	M5X35*	500	51190.050.035
M3X12*	500	51190.030.012	M4X30*	500	51190.040.030	M5X40*	500	51190.050.040
M3X16*	500	51190.030.016	M4X35*	500	51190.040.035			
M3X20*	500	51190.030.020				M6X8*	200	51190.060.008
M3X25*	500	51190.030.025	M5X8*	500	51190.050.008	M6X10*	200	51190.060.010
			M5X10*	500	51190.050.010	M6X12*	200	51190.060.012
M4X8*	500	51190.040.008	M5X12*	500	51190.050.012	M6X16*	200	51190.060.016
M4X10*	500	51190.040.010	M5X16*	500	51190.050.016	M6X20*	200	51190.060.020
M4X12*	500	51190.040.012	M5X20*	500	51190.050.020	M6X25*	200	51190.060.025
M4X16*	500	51190.040.016	M5X25*	500	51190.050.025	M6X30*	200	51190.060.030

51190 Welding stud ←								
d x L	☒	Art.number	d x L	☒	Art.number	d x L	☒	Art.number
M6X35*	200	51190.060.035	M8X16*	200	51190.080.016	M8X40*	200	51190.080.040
M6X40*	200	51190.060.040	M8X20*	200	51190.080.020	M8X45*	200	51190.080.045
			M8X25*	200	51190.080.025	M8X50*	200	51190.080.050
M8X10*	200	51190.080.010	M8X30*	200	51190.080.030	M8X60*	200	51190.080.060
M8X12*	200	51190.080.012	M8X35*	200	51190.080.035			

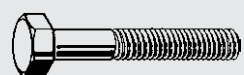

1 Bolts



2 Hexagon socket products



3 Nuts, rivet nuts & inserts



4 Threaded rods & studbolts



5 Hook & eye products



6 Screws

I Index



7 Washers & O-rings



8 Anchoring products

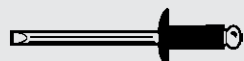

9 Rivets, pins & keys



10 Systems, furniture & security fasteners



11 Assortments & storage systems

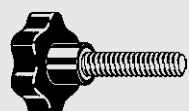

12 Engineering parts & machine parts



13 Maritime products

T Fastening technology

Assortments & storage systems **11**

 Page 11-3 Plastic box	 Page 11-14 Steel box	 Page 11-23 Accessories assortment	 Page 11-26 Carrying box
---	--	---	--

Fabory Auality Assortments

Fabory Quality Assortments, compiled from the most popular fasteners, make a unique range of plastic (types 9T and 18T) and steel (type S) assortment boxes for repairs, maintenance, service, etc. All Fabory Quality Assortments are permanently available from stock.

Over 120 plastic assortment boxes (types 9T and 18T) Fabory Quality Assortments have been carefully selected from fasteners best seller and for years have been an indispensable tool for every maintenance- and service engineer.



All solid transparent assortment boxes are provided with a clear label, a conveniently arranged table of contents and a lockable lid. The environmentally friendly plastic boxes are provided with a 9 or 18 compartment interior.



Thanks to their unique composition, over 100 steel assortment boxes (type S) Fabory Quality Assortments make a complete range of fasteners and are therefore eminently suitable for repairs and maintenance in the factory, on site or in the workshop.

All solid steel assortment boxes are provided with a sturdy plastic interior, a clear label and a conveniently arranged multi-lingual table of contents.

Assortment box plastic



41000 Assortment box plastic











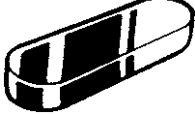

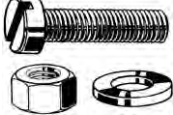
Y94A

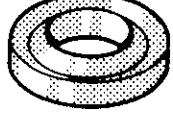

























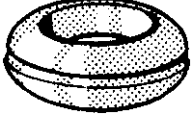

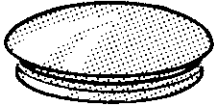





Size	✉	Art.number		
9 T 1	1	41000.000.001	Composition: <ul style="list-style-type: none"> • Spring lock washers with square ends acc. to DIN 127 B • Steel zinc plated • Content: M5 / M6 / M8 / M10 / M11 / M12 / M14 / M16 / M20 • 523 pieces 	
9 T 3	1	41000.000.003	Composition: <ul style="list-style-type: none"> • Serrated lock washers external teeth acc. to DIN 6798 A • Steel zinc plated • Content: M4 / M5 / M6 / M8 / M10 / M12 / M14 / M16 / M20 • 743 pieces 	
9 T 5	1	41000.000.005	Composition: <ul style="list-style-type: none"> • Countersunk serrated lock washers external teeth acc. to DIN 6798 V • Steel • Content: M3 / M4 / M5 / M6 / M8 / M10 / M12 / M14 / M16 / M20 • 595 pieces 	
9 T 6	1	41000.000.006	Composition: <ul style="list-style-type: none"> • Wave spring washers acc. to DIN 137 B • Steel • Content: M5 / M6 / M7 / M8 / M10 / M12 / M14 / M16 / M20 • 570 pieces 	
9 T 7	1	41000.000.007	Composition: <ul style="list-style-type: none"> • Plain washers without chamfer acc. to DIN 125-1 A • Steel zinc plated • Content: M3 / M4 / M5 / M6 / M8 / M10 / M12 / M14 / M16 • 825 pieces 	
9 T 8	1	41000.000.008	Composition: <ul style="list-style-type: none"> • Single chamfer plain washers acc. to DIN 125-1 B • Brass • Content: M3 / M4 / M5 / M6 / M8 / M10 / M12 / M14 / M16 • 835 pieces 	
9 T 9	1	41000.000.009	Composition: <ul style="list-style-type: none"> • Single chamfer plain washers acc. to DIN 125-1 B and plain washers without chamfer acc. to DIN 125-1 A • Steel • Content: M5 / M6 / M8 / M10 / M11 / M12 / M14 / M16 / M20 • 440 pieces 	
18 T 10	1	41000.000.010	Composition: <ul style="list-style-type: none"> • Sealing rings acc. to DIN 7603 A • Aluminium 99F11, hardness HB 32-45 • Content: Ø 4x8x1 / 5x9x1 / 6x10x1 / 6x12x1 / 8x12x1 / 8x14x1 / 10x14x1 / 12x18x1,5 / 14x20x1,5 / 16x20x1,5 / 16x22x1,5 / 18x24x1,5 / 20x26x1,5 / 22x27x1,5 / 24x30x2 / 26x32x2 • 571 pieces 	
9 T 11	1	41000.000.011	Composition: <ul style="list-style-type: none"> • Mudwing repair washers and plain washers d2 ≈ 3xd1 acc. to DIN 9021 • Steel zinc plated • Content: Mudwing repair washers: M4x20 / M5x20 / M6x25 / M8x30 / M10x30 / M12x36 • DIN 9021: M6x18 / M8x24 / M10x30 • 180 pieces 	
9 T 12	1	41000.000.012	Composition: <ul style="list-style-type: none"> • Shim rings thickness 0,1 mm • Steel • Content: Ø 8x20 / 10x22 / 12x24 / 14x26 / 16x28 / 18x30 / 20x32 / 22x34 / 24x36 • 215 pieces 	

41000 Assortment box plastic		←	
Size	☒	Art.number	
9 T 13	1	41000.000.013 Composition: • Rosettes, open model • Brass nickel plated • Content: • Ø 3,2 / 4 / 4,8 / 5,5 / 6,6 / 7,4 • 850 pieces	
18 T 14	1	41000.000.014 Composition: • Sealing rings acc. to DIN 7603 A • Copper, annealed • Content: • Ø 5x10x1 / 6x10x1 / 7x10x1 / 8x12x1 / 9x14x1 / 10x16x1,5 / 10,5x17x1,5 / 11x17x1,5 / 12x16x1,5 / 12,5x20x1,5 / 13x18x2 / 14x18x1 / 14x20x1,5 / 15x20x2 / 16x22x2 / 16,5x24x2 / 17x24x2 / 17,5x25x2 • 244 pieces	
9 T 15	1	41000.000.015 Composition: • Sealing rings acc. to DIN 7603 A • Copper, annealed • Content: • Ø 18x24x2 / 20x24x2 / 22x26x2 / 24x30x2 / 26x33x2 / 28x35x2 / 30x38x2 / 32x40x2 / 35x45x2 • 90 pieces	
9 T 16	1	41000.000.016 Composition: • Split pins (cotter pins) acc. to DIN 94 • Steel • Content: • 1x25 / 1,6x32 / 2x40 / 2,5x40 / 3,2x40 -x50 / 4x32 -x50 / 5x50 • 600 pieces	
9 T 17	1	41000.000.017 Composition: • Slotted cheese head screws acc. to DIN 84 and hexagon nuts acc. to DIN 934 • Steel class 4.8-l8l zinc plated • Content: • M3x25 -x40 / M4x25 -x40 / M5x25 -x40 / M6x25 -x40 -x50 • 550 pieces	
9 T 18	1	41000.000.018 Composition: • Slotted countersunk head screws acc. to DIN 963 and hexagon nuts acc. to DIN 934 • Steel class 4.8-l8l zinc plated • Content: • M3x10 -x30 / M4x16 -x40 / M5x16 -x30 -x40 / M6x16 -x50 • 490 pieces	
9 T 19	1	41000.000.019 Composition: • Phillips (H) cross recessed raised cheese head screws acc. to DIN 7985 H and hexagon nuts acc. to DIN 934 • Steel class 4.8-l8l zinc plated • Content: • M3x25 -x30 / M4x25 -x40 / M5x25 -x40 / M6x25 -x40 -x50 • 550 pieces	
9 T 20	1	41000.000.020 Composition: • Phillips (H) cross recessed countersunk head screws acc. to DIN 965 H and hexagon nuts acc. to DIN 934 • Steel class 4.8-l8l zinc plated • Content: • M3x10 -x20 / M4x16 -x30 / M5x16 -x30 -x40 / M6x16 -x50 • 480 pieces	
9 T 21	1	41000.000.021 Composition: • Slotted cheese head screws acc. to DIN 84 and hexagon nuts acc. to DIN 934 • Steel class 4.8-l8l zinc plated • Content: • M5x10 -x16 -x20 -x25 / M6x10 -x16 -x20 -x25 -x30 • 400 pieces	
9 T 22	1	41000.000.022 Composition: • Slotted cheese head screws acc. to DIN 84 and hexagon nuts acc. to DIN 934 • Brass • Content: • M3x25 -x40 / M4x25 -x40 / M5x25 -x40 / M6x25 -x40 -x50 • 470 pieces	
9 T 23	1	41000.000.023 Composition: • Slotted pan head tapping screws acc. to DIN 7971 C and slotted raised countersunk head tapping screws acc. to DIN 7973 C • Steel nickel plated • Content: • ST2,9x13 / ST3,5x16 -x19 / ST4,2x16 -x19 -x25 / ST4,8x16 -x19 / ST5,5x25 • 390 pieces	
9 T 24	1	41000.000.024 Composition: • Slotted pan head tapping screws acc. to DIN 7971 C • Steel nickel plated • Content: • ST2,9x13 / ST3,5x16 -x19 / ST4,2x16 -x19 -x25 / ST4,8x16 -x19 / ST5,5x25 • 390 pieces	
9 T 25	1	41000.000.025 Composition: • Slotted raised countersunk head tapping screws acc. to DIN 7973 C • Steel nickel plated • Content: • ST2,9x13 / ST3,5x16 -x19 / ST4,2x16 -x19 -x25 / ST4,8x16 -x19 / ST5,5x25 • 390 pieces	
9 T 26	1	41000.000.026 Composition: • SECURITY One way tapping screws • Steel zinc plated • Content: • ST2,9x19 / ST3,5x13 -x19 -x25 / ST4,2x19 -x25 -x32 -x38 -x50 • 370 pieces	









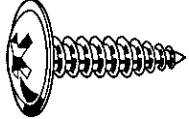

41000		Assortment box plastic		←
Size	☒	Art.number		
9 T 27	1	41000.000.027	Composition: <ul style="list-style-type: none"> Hexagon washer head tapping screws acc. to ≈ DIN 7976 C, hexagon head tapping screws acc. to DIN 7976 F and hexagon head tapping screws with cone end and captive washer Steel zinc plated and steel zinc plated, yellow passivated Content: <ul style="list-style-type: none"> ≈ DIN 7976 C: ST3,5x16 / ST4,2x16 -x19 -x25 / ST4,8x19 -x25 DIN 7976 F: ST6,3x25 With cone end and captive washer: ST5,6x13 / ST6,5x20 255 pieces 	
18 T 28	1	41000.000.028	Composition: <ul style="list-style-type: none"> Phillips (H) cross recessed pan head tapping screws acc. to DIN 7981 C-H and Phillips (H) cross recessed raised countersunk head tapping screws acc. to DIN 7983 C-H Steel zinc plated, black passivated Content: <ul style="list-style-type: none"> ST2,9x19 / ST3,5x16 -x25 / ST4,2x16 -x25 -x32 / ST4,8x19 -x25 -x32 440 pieces 	
9 T 29	1	41000.000.029	Composition: <ul style="list-style-type: none"> Hexagon head bolts acc. to ISO 8765, hexagon head screws acc. to ISO 8676 and hexagon nuts acc. to DIN 934 Metric fine pitch thread Steel class 8.8-18l Content: <ul style="list-style-type: none"> M8x1x30 -x40 / M10x1x30 -x40 / M10x1,25x30 -x40 76 pieces 	
9 T 30	1	41000.000.030	Composition: <ul style="list-style-type: none"> Hexagon head screws acc. to ISO 4017 and hexagon nuts acc. to DIN 934 Steel class 8.8-18l zinc plated Content: <ul style="list-style-type: none"> M5x12 -x16 -x20 -x25 / M6x12 -x16 -x20 -x25 -x30 320 pieces 	
9 T 32	1	41000.000.032	Composition: <ul style="list-style-type: none"> Finished hex bolts and hexagon nuts Steel class ≈ 8.8/8 Content: <ul style="list-style-type: none"> UNC 1/4 x 5/8 -x 3/4 -x 1.1N. -x 1.1/4 / UNC 5/16 x 1.1N. -x 1.1/2 / UNC 3/8 x 1.1N. -x 1.1/2 / UNC 1/2 x 1.1/4 126 pieces 	
9 T 33	1	41000.000.033	Composition: <ul style="list-style-type: none"> Hexagon head screws acc. to DIN 933 (1954) and hexagon nuts acc. to DIN 934 (1954) Steel class ≈ 8.8/8 Content: <ul style="list-style-type: none"> BSW 1/4 x 15 -x20 -x25 -x30 / BSW 5/16 x 20 -x30 / BSW 3/8 x 25 -x35 / BSW 1/2 x 30 110 pieces 	
9 T 34	1	41000.000.034	Composition: <ul style="list-style-type: none"> Hexagon head screws acc. to ISO 4017 and hexagon nuts acc. to DIN 934 Brass Content: <ul style="list-style-type: none"> M5x12 -x16 -x20 -x25 / M6x12 -x16 -x20 -x25 -x30 300 pieces 	
9 T 35	1	41000.000.035	Composition: <ul style="list-style-type: none"> Hexagon socket head cap screws acc. to DIN 912 Steel class 8.8 zinc plated Content: <ul style="list-style-type: none"> M6x16 -x20 -x25 -x30 / M8x25 -x30 -x35 / M10x25 -x35 95 pieces 	
9 T 36	1	41000.000.036	Composition: <ul style="list-style-type: none"> Hexagon socket head cap screws Steel class ≈ 12.9 Content: <ul style="list-style-type: none"> UNC 1/4 x 5/8 -x 3/4 -x 1.1N. -x 1.1/4 / UNC 5/16 x 1.1N. -x 1.1/4 -x 1.1/2 / UNC 3/8 x 1.1N. -x 1.1/2 98 pieces 	
9 T 37	1	41000.000.037	Composition: <ul style="list-style-type: none"> Hexagon socket countersunk head screws acc. to DIN 7991 Steel class 8.8 zinc plated Content: <ul style="list-style-type: none"> M6x20 -x25 -x30 / M8x20 -x25 -x30 -x40 / M10x30 -x40 78 pieces 	
9 T 39	1	41000.000.039	Composition: <ul style="list-style-type: none"> Hexagon head screws acc. to ISO 4017 and hexagon nuts acc. to DIN 934 Steel class 8.8-18l zinc plated, yellow passivated Content: <ul style="list-style-type: none"> M5x10 -x20 / M6x12 -x30 / M8x20 -x40 / M10x30 -x40 190 pieces 	
9 T 40	1	41000.000.040	Composition: <ul style="list-style-type: none"> Hexagon socket head cap screws acc. to DIN 912 Steel class 12.9 Content: <ul style="list-style-type: none"> M6x16 -x20 -x25 -x30 / M8x25 -x30 -x35 / M10x25 -x35 95 pieces 	
18 T 41	1	41000.000.041	Composition: <ul style="list-style-type: none"> Filled sealing rings acc. to DIN 7603 C Copper/FESTAPLAN Content: <ul style="list-style-type: none"> ∅ 5x9x1,5 / 6x10x1,5 / 8x12x1,5 / 8x14x1,5 / 10x14x1,5 / 10x16x1,5 / 12x16x2 / 12x18x2 / 14x18x2 / 14x20x2 / 16x20x2 / 16x22x2 / 18x22x2 / 18x24x2 / 20x24x2 / 20x26x2 / 22x27x2 / 22x29x2 200 pieces 	

41000 Assortment box plastic		←	
Size	☒	Art.number	
9 T 42	1	41000.000.042 Composition: • Filled sealing rings acc. to DIN 7603 C • Copper/FESTAPLAN • Content: • Ø 24x32x2,5 / 26x32x2,5 / 26x34x2,5 / 30x36x2,5 / 30x38x2,5 / 32x38x2,5 / 35x41x2,5 / 38x44x2,5 / 40x47x2,5 • 65 pieces	
9 T 51	1	41000.000.051 Composition: • Parallel keys - high type acc. to DIN 6885 A • Steel • Content: • 5x5x20 -x32 -x40 / 6x6x20 -x32 / 8x7x40 -x50 / 10x8x50 -x63 • 90 pieces	
9 T 54	1	41000.000.054 Composition: • Packing (jointing) rings • Fibre • Content: • Ø 20x24 / 22x26 / 24x28 / 25x34 / 26x33 / 28x40 / 30x42 / 32x44 / 34x46 • 120 pieces	
18 T 55	1	41000.000.055 Composition: • Hexagon nuts acc. to ≈ DIN 934, slotted cheese head screws acc. to ≈ DIN 84 and plain washers without chamfer ≈ DIN 125-1 A • Plastic PA 6.6 (white) • Content: • M3x6 -x8 -x10 -x12 / M4x8 -x10 -x12 -x16 / M5x10 -x16 -x20 -x25 • 770 pieces	
9 T 56	1	41000.000.056 Composition: • Plain washers without chamfer • Aluminium Sopral AG3 • Content: • M3 / M4 / M5 / M6 / M8 / M10 / M12 / M16 / M20 • 514 pieces	
9 T 57	1	41000.000.057 Composition: • DUBO retaining rings for hexagon bolts and nuts • Plastic PA 6 (white) • Content: • M5 / M6 / M8 / M10 / M12 / M14 / M16 / M18 / M20 • 311 pieces	
9 T 58	1	41000.000.058 Composition: • Plain washers without chamfer acc. to ≈ DIN 125-1 A • Plastic PA 6.6 (white) • Content: • M4 / M5 / M6 / M8 / M10 / M12 / M14 / M16 / M20 • 484 pieces	
9 T 59	1	41000.000.059 Composition: • Hexagon head screws acc. to ≈ ISO 4017, hexagon nuts acc. to ≈ DIN 934 and slotted cheese head screws acc. to ≈ DIN 84 • Plastic PA 6.6 (white) • Content: • M5x20 / M6x20 -x40 / M8x30 -x50 / M10x50 • 106 pieces	
18 T 60	1	41000.000.060 Composition: • Spacers • Plastic PA 6.6 (white) • Content: • Ø 2,5x5x5 / 2,5x5x15 / 3x8x5 / 3x8x15 / 3,5x6x5 / 3,5x6x15 / 4x8x15 / 5x10x5 / 5x10x15 / 6x10x5 / 6x10x15 / 8x12x5 / 8x12x15 / 10x15x5 / 10x15x15 / 10x15x25 / 12x18x5 / 12x18x15 • 191 pieces	
9 T 62	1	41000.000.062 Composition: • Pozidriv (Z) cross recessed countersunk screws for chipboard • Steel zinc plated • Content: • 3x13 -x17 -x20 / 3,5x20 -x25 / 4x20 -x25 -x30 / 5x40 • 380 pieces	
9 T 66	1	41000.000.066 Composition: • Split pins (cotter pins) acc. to DIN 94 • Stainless steel A2 • Content: • 1x20 / 1,6x20 / 2x32 / 2,5x32 / 3,2x32 -x40 / 4x40 / 5x50 / 6,3x50 • 165 pieces	
9 T 68	1	41000.000.068 Composition: • Hexagon socket head cap screws acc. to DIN 912 • Stainless steel A2-70 • Content: • M6x16 -x20 -x25 -x30 / M8x25 -x30 -x35 / M10x25 -x35 • 85 pieces	
18 T 69	1	41000.000.069 Composition: • Slotted cheese head screws acc. to DIN 84, hexagon nuts acc. to DIN 934, plain washers without chamfer acc. to DIN 125-1 A and spring lock washers with square ends acc. to ≈ DIN 127 B • Stainless steel A2-70 • Content: • M1,6x6 / M2x8 / M2,5x10 / M3x6 -x8 -x10 / M4x8 -x10 -x12 / M5x10 -x16 -x20 • 945 pieces	
9 T 70	1	41000.000.070 Composition: • Spring lock washers with square ends acc. to DIN 127 B • Stainless steel A2 • Content: • M4 / M5 / M6 / M8 / M10 / M12 / M14 / M16 / M20 • 527 pieces	

41000		Assortment box plastic		←
Size	☒	Art.number		
9 T 71	1	41000.000.071	Composition: <ul style="list-style-type: none"> • Plain washers without chamfer acc. to DIN 125-1 A • Stainless steel A2 • Content: • M4 / M5 / M6 / M8 / M10 / M12 / M14 / M16 / M20 • 390 pieces 	
9 T 72	1	41000.000.072	Composition: <ul style="list-style-type: none"> • Slotted round head wood screws acc. to DIN 96 • Stainless steel A2 • Content: • 3x12 -x16 / 4x20 -x25 -x30 -x40 / 5x25 -x40 -x50 • 279 pieces 	
9 T 73	1	41000.000.073	Composition: <ul style="list-style-type: none"> • Slotted countersunk (flat) head wood screws acc. to DIN 97 • Stainless steel A2 • Content: • 3x20 -x25 / 4x20 -x25 -x30 -x40 / 5x30 -x40 -x50 • 223 pieces 	
9 T 74	1	41000.000.074	Composition: <ul style="list-style-type: none"> • Pozidriv (Z) cross recessed countersunk screws for chipboard • Stainless steel A2 • Content: • 3,5x25 -x30 / 4x20 -x30 -x40 -x50 / 5x50 -x60 -x70 • 220 pieces 	
9 T 75	1	41000.000.075	Composition: <ul style="list-style-type: none"> • Hexagon head screws acc. to ISO 4017 and hexagon nuts acc. to DIN 934 • Stainless steel A2-70 • Content: • M6x16 -x20 -x25 / M8x20 -x25 -x30 / M10x25 -x30 -x40 • 138 pieces 	 
9 T 76	1	41000.000.076	Composition: <ul style="list-style-type: none"> • Slotted cheese head screws acc. to DIN 84 and hexagon nuts acc. to DIN 934 • Stainless steel A2-70 • Content: • M4x10 -x16 -x20 / M5x10 -x16 -x20 / M6x16 -x20 -x25 • 360 pieces 	 
9 T 77	1	41000.000.077	Composition: <ul style="list-style-type: none"> • Slotted countersunk head screws acc. to DIN 963 and hexagon nuts acc. to DIN 934 • Stainless steel A2-70 • Content: • M4x10 -x16 -x20 / M5x10 -x16 -x20 / M6x16 -x20 -x25 • 360 pieces 	 
9 T 78	1	41000.000.078	Composition: <ul style="list-style-type: none"> • Slotted pan head tapping screws acc. to DIN 7971 C • Stainless steel A2 • Content: • ST2,9x13 / ST3,5x9,5 -x13 -x19 / ST4,2x13 -x19 -x25 / ST4,8x19 -x25 • 265 pieces 	
9 T 79	1	41000.000.079	Composition: <ul style="list-style-type: none"> • Slotted raised countersunk head tapping screws acc. to DIN 7973 C • Stainless steel A2 • Content: • ST2,9x13 / ST3,5x9,5 -x13 -x19 / ST4,2x13 -x19 -x25 / ST4,8x19 -x25 • 265 pieces 	
9 T 80	1	41000.000.080	Composition: <ul style="list-style-type: none"> • Prevailing torque type hexagon nuts with non-metallic insert acc. to DIN 985 • Steel class 5/8 zinc plated • Content: • M4 / M5 / M6 / M7 / M8 / M10 / M12 / M14 / M16 • 214 pieces 	
9 T 81	1	41000.000.081	Composition: <ul style="list-style-type: none"> • Prevailing torque type hexagon nuts with non-metallic insert acc. to DIN 985 • Steel class ≥ 6 zinc plated • Content: • M10x1 -x1,25 / M12x1,25 -x1,5 • UNF 1/4 / UNF 5/16 / UNF 3/8 / UNF 7/16 / UNF 1/2 • 95 pieces 	
18 T 85	1	41000.000.085	Composition: <ul style="list-style-type: none"> • O-rings (metric) • Rubber - NBR 70° shore (black) • Content: • Ø 5x1,5 / 6x1,5 / 7x1,5 / 8x1,5 / 8x2 / 10x2 / 12x2 / 11,3x2,4 / 13,3x2,4 / 12x2,5 / 14x2,5 / 15x2,5 / 16x2,5 / 18x3 / 20,2x3 / 22,2x3 / 24,2x3 / 26,2x3 • 179 pieces 	
18 T 86	1	41000.000.086	Composition: <ul style="list-style-type: none"> • O-rings (non-metric) • Rubber - NBR 70° shore (black) • Content: • Ø 5,28x1,78 / 6,07x1,78 / 7,66x1,78 / 9,25x1,78 / 10,82x1,78 / 12,42x1,78 / 10,78x2,62 / 12,37x2,62 / 13,95x2,62 / 15,08x2,62 / 17,13x2,62 / 18,72x2,62 / 20,29x2,62 / 21,89x2,62 / 23,47x2,62 / 23,40x3,53 / 24,99x3,53 / 26,58x3,53 • 167 pieces 	
9 T 88	1	41000.000.088	Composition: <ul style="list-style-type: none"> • Grommets • Rubber (black) • Content: • Ø 4x6,4 / 5,5x8 / 6,4x9,5 / 8x9,5 / 9,5x12,5 / 11x12,5 / 12,5x17,5 / 14,2x17,5 / 16x19 • 218 pieces 	

41000 Assortment box plastic		←		
Size	✉	Art.number		
9 T 89	1	41000.000.089	Composition: <ul style="list-style-type: none"> • Blanking plugs • Rubber (black) • Content: <ul style="list-style-type: none"> • Ø 6,4x9,5 / 8x14,2 / 9,5x15,4 / 11,2x17,7 / 12,5x18,7 / 15,5x22 / 19x25,5 / 20x25,5 / 22,5x28,4 • 178 pieces 	
9 T 91	1	41000.000.091	Composition: <ul style="list-style-type: none"> • Round head rivets acc. to DIN 660 and countersunk head rivets acc. to DIN 661 • Copper • Content: <ul style="list-style-type: none"> • 2x6 -x10 / 3x6 -x10 / 4x10 -x16 / 5x12 -x20 / 6x20 • 620 pieces 	 
9 T 93	1	41000.000.093	Composition: <ul style="list-style-type: none"> • Round head rivets acc. to DIN 660 and countersunk head rivets acc. to DIN 661 • Aluminium • Content: <ul style="list-style-type: none"> • 2x6 -x10 / 3x6 -x10 / 4x10 -x16 / 5x12 -x20 / 6x20 • 620 pieces 	 
18 T 101	1	41000.000.101	Composition: <ul style="list-style-type: none"> • Packing (jointing) rings • Fibre • Content: <ul style="list-style-type: none"> • Ø 5x8 / 6x9 / 6,5x10 / 7x10 / 8x12 / 8,5x14 / 9x14 / 9,5x14 / 10x14 / 11x17 / 12x16 / 12,5x18 / 14x18 / 15x19 / 16x21 / 17x22 / 18x24 / 19x23 • 400 pieces 	
18 T 102	1	41000.000.102	Composition: <ul style="list-style-type: none"> • Retaining rings for shafts acc. to DIN 471 • Steel • Content: <ul style="list-style-type: none"> • Ø 10 / 11 / 12 / 13 / 14 / 15 / 16 / 17 / 18 / 19 / 20 / 21 / 22 / 23 / 24 / 25 / 26 / 27 • 260 pieces 	
18 T 103	1	41000.000.103	Composition: <ul style="list-style-type: none"> • Retaining rings for bores acc. to DIN 472 • Steel • Content: <ul style="list-style-type: none"> • Ø 10 / 11 / 12 / 13 / 14 / 15 / 16 / 17 / 18 / 19 / 20 / 21 / 22 / 23 / 24 / 25 / 26 / 27 • 260 pieces 	
9 T 104	1	41000.000.104	Composition: <ul style="list-style-type: none"> • Retaining rings for shafts acc. to DIN 471 • Steel • Content: <ul style="list-style-type: none"> • Ø 29 / 30 / 31 / 33 / 35 / 36 / 38 / 40 / 42 • 115 pieces 	
9 T 105	1	41000.000.105	Composition: <ul style="list-style-type: none"> • Retaining rings for bores acc. to DIN 472 • Steel • Content: <ul style="list-style-type: none"> • Ø 28 / 29 / 30 / 32 / 35 / 36 / 37 / 40 / 42 • 115 pieces 	
18 T 107	1	41000.000.107	Composition: <ul style="list-style-type: none"> • Slotted pan head tapping screws acc. to DIN 7971 C • Steel nickel plated • Content: <ul style="list-style-type: none"> • ST2,9x13 / ST3,5x13 -x16 -x19 -x25 / ST4,2x13 -16 -x19 -x25 / ST4,8x16 -x19 -x25 -x32 / ST5,5x19 -25 -x32 / ST6,3x25 -x38 • 500 pieces 	
18 T 109	1	41000.000.109	Composition: <ul style="list-style-type: none"> • Phillips (H) cross recessed raised countersunk head tapping screws acc. to DIN 7983 C-H • Steel nickel plated • Content: <ul style="list-style-type: none"> • ST2,9x13 / ST3,5x13 -x16 -x19 -x25 / ST4,2x13 -x16 -x19 -x25 / ST4,8x16 -x19 -x25 -x32 / ST5,5x19 -x25 -x32 / ST6,3x25 -x38 • 500 pieces 	
18 T 110	1	41000.000.110	Composition: <ul style="list-style-type: none"> • Hexagon socket set screws with cup point acc. to DIN 916 (excl. UNC sizes) • Steel class 45H • Content: <ul style="list-style-type: none"> • M4x5 -x10 / M5x10 -x16 / M6x8 -x12 -x20 / M8x12 -x20 / UNC 3/16 x 1/4 -x 3/8 / UNC 1/4 x 3/8 -x 1/2 -x 5/8 -x 3/4 / UNC 5/16 x 1/2 -x 5/8 -x 3/4 • 229 pieces 	
18 T 111	1	41000.000.111	Composition: <ul style="list-style-type: none"> • Woodruff keys acc. to DIN 6888 • Steel • Content: <ul style="list-style-type: none"> • 2x3,7 / 2,5x3,7 / 3x3,7 -x5 -x6,5 / 4x5 -x6,5 -x7,5 -x9 / 5x6,5 -x9 / 6x9 -x11 -x13 -x15 / 8x11 -x13 / 10x13 • 220 pieces 	
18 T 112	1	41000.000.112	Composition: <ul style="list-style-type: none"> • Slotted cheese head screws acc. to DIN 84 and hexagon nuts acc. to DIN 934 • Steel class 4.8-l8l zinc plated • Content: <ul style="list-style-type: none"> • M3x4 -x6 -x8 -x10 -x12 -x16 -x20 -x25 / M4x6 -x8 -x10 -x12 -x16 -x20 -x25 -x30 • 1020 pieces 	 

41000 Assortment box plastic		←		
Size	☒	Art.number		
18 T 113	1	41000.000.113	Composition: <ul style="list-style-type: none"> • PRYM spring-type straight pins (spiral pins), coiled standard duty acc. to ISO 8750 • Steel • Content: 1,5x8 -x12 / 2x10 -x16 / 3x12 -x14 -x16 -x20 -x24 -x30 / 4x16 -x20 -x24 -x30 -x40 / 5x20 -x40 / 6x40 • 415 pieces 	
18 T 114	1	41000.000.114	Composition: <ul style="list-style-type: none"> • Taper pins - turned acc. to DIN 1 B • Steel • Content: 2x10 -x12 -x14 -x20 -x30 / 3x14 -x20 -x24 -x30 -x40 / 4x20 -x30 -x40 / 5x20 -x30 -x40 / 6x30 -x40 • 365 pieces 	
18 T 115	1	41000.000.115	Composition: <ul style="list-style-type: none"> • Parallel pins (dowel pins) - hardened and ground acc. to DIN 6325 • Steel hardness 60 ± 2 HRC • Content: 2x10 -x12 -x14 -x20 -x28 / 3x14 -x20 -x24 -x32 -x40 / 4x20 -x32 -x40 / 5x20 -x32 -x40 / 6x28 -x40 • 187 pieces 	
18 T 116	1	41000.000.116	Composition: <ul style="list-style-type: none"> • Spring type straight pins slotted - heavy type acc. to ISO 8752 • Steel • Content: 1,5x8 -x12 / 2x10 -x16 / 2,5x30 / 3x14 -x16 -x20 -x24 -x30 / 4x16 -x20 -x24 -x30 -x40 / 5x20 -x40 / 6x40 • 414 pieces 	
9 T 117	1	41000.000.117	Composition: <ul style="list-style-type: none"> • Spring type straight pins slotted - heavy type acc. to ISO 8752 • Steel • Content: 4x50 / 5x50 -x60 / 6x50 -x60 -x70 / 8x50 -x60 -x70 • 136 pieces 	
9 T 121	1	41000.000.121	Composition: <ul style="list-style-type: none"> • Slotted countersunk (flat) head wood screws acc. to DIN 97 • Brass • Content: 3x20 -x25 / 4x20 -x25 -x30 -x40 / 5x30 -x40 -x50 • 223 pieces 	
9 T 122	1	41000.000.122	Composition: <ul style="list-style-type: none"> • Slotted round head wood screws acc. to DIN 96 • Brass • Content: 3x20 / 3,5x20 -x25 -x30 / 4x20 -x25 -x30 / 5x30 -x40 • 235 pieces 	
9 T 125	1	41000.000.125	Composition: <ul style="list-style-type: none"> • Slotted countersunk (flat) head wood screws acc. to DIN 97 • Steel zinc plated • Content: 3x20 / 3,5x20 -x25 -x30 / 4x20 -x25 -x30 / 5x40 -x50 • 425 pieces 	
9 T 126	1	41000.000.126	Composition: <ul style="list-style-type: none"> • Slotted round head wood screws acc. to DIN 96 • Steel zinc plated • Content: 3x20 / 3,5x20 -x25 -x30 / 4x20 -x25 -x30 / 5x30 -x40 • 425 pieces 	
18 T 131	1	41000.000.131	Composition: <ul style="list-style-type: none"> • Slotted pan head tapping screws acc. to DIN 7971 C • Steel zinc plated • Content: ST2,9x13 / ST3,5x13 -x16 -x19 -x25 / ST4,2x13 -x16 -x19 -x25 / ST4,8x16 -x19 -x25 -x32 / ST5,5x19 -x25 -x32 / ST6,3x25 -x38 • 500 pieces 	
18 T 133	1	41000.000.133	Composition: <ul style="list-style-type: none"> • Slotted raised countersunk head tapping screws acc. to DIN 7973 C • Steel zinc plated • Content: ST2,9x13 / ST3,5x13 -x16 -x19 -x25 / ST4,2x13 -x16 -x19 -x25 / ST4,8x16 -x19 -x25 -x32 / ST5,5x19 -x25 -x32 / ST6,3x25 -x38 • 500 pieces 	
18 T 137	1	41000.000.137	Composition: <ul style="list-style-type: none"> • Phillips (H) cross recessed pan head tapping screws acc. to DIN 7981 C-H • Steel zinc plated • Content: ST2,9x13 / ST3,5x13 -x16 -x19 -x25 / ST4,2x13 -x16 -x19 -x25 / ST4,8x16 -x19 -x25 -x32 / ST5,5x19 -x25 -x32 / ST6,3x25 -x38 • 500 pieces 	
18 T 139	1	41000.000.139	Composition: <ul style="list-style-type: none"> • Phillips (H) cross recessed raised countersunk head tapping screws acc. to DIN 7983 C-H • Steel zinc plated • Content: ST2,9x13 / ST3,5x13 -x16 -x19 -x25 / ST4,2x13 -x16 -x19 -x25 / ST4,8x16 -x19 -x25 -x32 / ST5,5x19 -x25 -x32 / ST6,3x25 -x38 • 500 pieces 	
9 T 140	1	41000.000.140	Composition: <ul style="list-style-type: none"> • Phillips (H) cross recessed pan head tapping screws acc. to DIN 7981 C-H • Steel zinc plated, black passivated • Content: ST2,9x19 / ST3,5x16 -x25 / ST4,2x16 -x25 -x32 / ST4,8x19 -x25 -x32 • 440 pieces 	

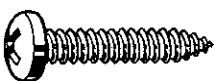
41000 Assortment box plastic		←
Size	Art.number	
9 T 141	41000.000.141	<p>Composition:</p> <ul style="list-style-type: none"> Phillips (H) cross recessed raised countersunk head tapping screws acc. to DIN 7983 C-H Steel zinc plated, black passivated Content: ST2,9x19 / ST3,5x16 -x25 / ST4,2x16 -x25 -x32 / ST4,8x19 -x25 -x32 440 pieces 
9 T 143	41000.000.143	<p>Composition:</p> <ul style="list-style-type: none"> Phillips (H) cross recessed mushroom head tapping screws with flange Steel zinc plated, black passivated Content: ST3,5x16 -x19 / ST4,2x16 -x19 -x22 / ST4,8x16 -x19 -x25 360 pieces 
9 T 151	41000.000.151	<p>Composition:</p> <ul style="list-style-type: none"> Packing (jointing) rings Fibre Content: Ø 3x5 / 4x6,5 / 4,5x8 / 5x8 / 5,5x9 / 6x9 / 6,5x10 / 7x10 / 8x12 750 pieces 
9 T 152	41000.000.152	<p>Composition:</p> <ul style="list-style-type: none"> Woodruff keys acc. to DIN 6888 Steel Content: 2x2,6 -x3,7 -x5 / 2,5x3,7 / 3x3,7 -x5 -x6,5 -x7,5 / 4x5 235 pieces 
9 T 156	41000.000.156	<p>Composition:</p> <ul style="list-style-type: none"> Retaining rings for shafts acc. to DIN 471 and retaining rings for bores acc. to DIN 472 Steel Content: Ø 8 / 9 / 10 / 11 / 12 / 13 / 14 / 15 / 16 326 pieces 
9 T 157	41000.000.157	<p>Composition:</p> <ul style="list-style-type: none"> Retaining rings for shafts acc. to DIN 6799 Steel Content: Ø 1,5 / 1,9 / 2,3 / 3,2 / 4 / 5 / 6 / 7 / 8 550 pieces 
9 T 159	41000.000.159	<p>Composition:</p> <ul style="list-style-type: none"> STARLOCK fixing washers for shafts Springsteel (without cap) and springsteel (with stainless steel cap) Content: Ø 3 / 4 / 5 / 6 / 8 / 10 / 12 / 16 / 20 289 pieces 
9 T 175	41000.000.175	<p>Composition:</p> <ul style="list-style-type: none"> Lubricating nipples cone type acc. to ≈ DIN 71412 Steel zinc plated Content: R 1/8 -45° -90° -180° / R 1/4 -45° -90° -180° SAE (UNF) 1/4 -180° / UNF 5/16 -180° / UNF 3/8 -180° 97 pieces 
18 T 176	41000.000.176	<p>Composition:</p> <ul style="list-style-type: none"> Lubricating nipples cone type acc. to ≈ DIN 71412 and drive-in lubricating nipples Steel zinc plated Content: M6x1-45° -90° -180° M8x1-45° -90° -180° / M8x1,25-45° -90° -180° M10x1-45° -90° -180° / M10x1,5-90° -180° Drive-in lubricating nipple: 6-45° -180° / 8-90° -180° 123 pieces 
9 T 177	41000.000.177	<p>Composition:</p> <ul style="list-style-type: none"> Lubricating nipples cone type acc. to ≈ DIN 71412 Steel zinc plated Content: M6x1-45° -90° -180° M8x1-180° / M8x1,25-45° -90° -180° M10x1-180° / M10x1,5-180° 120 pieces 
9 T 201	41000.000.201	<p>Composition:</p> <ul style="list-style-type: none"> Plain washers without chamfer acc. to DIN 125-1 A and spring lock washers with square ends acc. to DIN 127 B Steel zinc plated Content: M5 / M6 / M8 / M10 / M11 675 pieces 
9 T 203	41000.000.203	<p>Composition:</p> <ul style="list-style-type: none"> Plain washers without chamfer acc. to DIN 125-1 A and spring lock washers with square ends acc. to DIN 127 B Steel zinc plated, yellow passivated Content: M5 / M6 / M8 / M10 / M12 630 pieces 
18 T 209	41000.000.209	<p>Composition:</p> <ul style="list-style-type: none"> Phillips (H) cross recessed pan head tapping screws acc. to DIN 7981 C-H Steel nickel plated Content: ST2,9x13 / ST3,5x13 -x16 -x19 -x25 / ST4,2x13 -x16 -x19 -x25 / ST4,8x16 -x19 -x25 x32 / ST5,5x19-x25 -x32 / ST6,3x25-x38 500 pieces 

41000 Assortment box plastic		←		
Size	☒	Art.number		
18 T 210	1	41000.000.210	Composition: <ul style="list-style-type: none"> • Hexagon socket set screws with cup point acc. to DIN 916 • Steel class 45H • Content: <ul style="list-style-type: none"> • M4x5 -x8 -x10 / M5x8 -x10 -x12 -x16 / M6x8 -x10 -x12 -x16 -x20 / M8x12 -x16 -x20 / M10x16 -x20 -x25 • 245 pieces 	
9 T 212	1	41000.000.212	Composition: <ul style="list-style-type: none"> • Shim rings thickness 0,1 mm • Steel • Content: <ul style="list-style-type: none"> • Ø 24x36 / 26x38 / 28x40 / 30x42 / 32x44 / 34x46 / 36x48 / 38x50 / 40x50 • 160 pieces 	
9 T 214	1	41000.000.214	Composition: <ul style="list-style-type: none"> • Taper pins - turned acc. to DIN 1 B • Steel • Content: <ul style="list-style-type: none"> • 3x50 / 4x50 -x60 / 5x50 -x60 / 6x50 -x60 -x70 / 6,5x60 • 150 pieces 	
9 T 219	1	41000.000.219	Composition: <ul style="list-style-type: none"> • Phillips (H) cross recessed raised cheese head screws acc. to DIN 7985 H • Steel class 4.8 zinc plated, black passivated • Content: <ul style="list-style-type: none"> • M3x6 -x10 -x16 -x20 -x30 / M4x10 -x20 -x30 -x50 • 525 pieces 	
9 T 220	1	41000.000.220	Composition: <ul style="list-style-type: none"> • Phillips (H) cross recessed countersunk head screws acc. to DIN 965H • Steel class 4.8 zinc plated, black passivated • Content: <ul style="list-style-type: none"> • M3x6 -x10 -x16 -x20 -x30 / M4x10 -x20 -x30 -x50 • 525 pieces 	
9 T 230	1	41000.000.230	Composition: <ul style="list-style-type: none"> • Hexagon head screws acc. to ISO 4017 and hexagon nuts acc. to DIN 934 • Steel class 8.8-18l zinc plated • Content: <ul style="list-style-type: none"> • M8x20 -x25 -x30 -x35 / M10x25 -x30 -x35 • 86 pieces 	
9 T 231	1	41000.000.231	Composition: <ul style="list-style-type: none"> • Finished hex bolts and hexagon nuts • Steel Grade 5 zinc plated • Content: <ul style="list-style-type: none"> • UNF 1/4 x 5/8 -x 3/4 -x 1.1N. -x 1.1/4 / UNF 5/16 x 1.1N. -x 1.1/2 / UNF 3/8 x 1.1N. -x 1.1/2 / UNF 1/2 x 1.1/4 • 126 pieces 	
9 T 240	1	41000.000.240	Composition: <ul style="list-style-type: none"> • Helical compression springs acc. to DIN 2095 • Spring steel zinc plated • Content: <ul style="list-style-type: none"> • 0,5x6,5x30 / 0,8x7,7x35 -x50 / 1x8x30 / 1x10x60 / 1,5x10x50 / 1,5x12x40 / 1,5x14x60 / 2x14x50 • 105 pieces 	
9 T 245	1	41000.000.245	Composition: <ul style="list-style-type: none"> • Helical tension springs acc. to DIN 2097 • Spring steel zinc plated • Content: <ul style="list-style-type: none"> • 0,5x4,5x20 / 0,5x6,5x20 -x30 / 0,8x6,7x35 / 0,8x7,7x40 -x50 / 1x10x40 -x60 / 1,5x10x50 • 166 pieces 	
18 T 250	1	41000.000.250	Composition: <ul style="list-style-type: none"> • Helical compression springs acc. to DIN 2095 and helical tension springs acc. to DIN 2097 • Spring steel zinc plated • Content: <ul style="list-style-type: none"> • 0,5x3,5x15 -x20 / 0,5x4,5x12 / 0,5x6,5x20 -x25 -x35 / 0,8x5,7x25 / 0,8x6,7x25 -x30 / 0,8x7,7x30 / 1x6x25 -x30 / 1x8x25 -x35 / 1x10x25 -x35 / 1x10x40 -x60 / 1,5x10x35 • 251 pieces 	
9 T 300	1	41000.000.300	Composition: <ul style="list-style-type: none"> • Pre-insulated terminals and connectors • Steel/plastic • Content: <ul style="list-style-type: none"> • Cable 0,5 - 1,5 mm <ul style="list-style-type: none"> : type 545 / 547 / 548 • Cable 1,5 - 2,5 mm <ul style="list-style-type: none"> : type 546 / 550 / 549 • Cable 2,5 - 6,0 mm <ul style="list-style-type: none"> : type 563 (M8) / 554 (M10) • Connector type C-560 blue • 149 pieces 	
18 T 305	1	41000.000.305	Composition: <ul style="list-style-type: none"> • Pre-insulated terminals • Steel/plastic • Content: <ul style="list-style-type: none"> • Cable 0,5 - 1,5 mm <ul style="list-style-type: none"> : type 599 / 741 / 541 / 540 / 1541 / 561 / 556 (M3) / 535 (M4) / 557 (M5) • Cable 1,5 - 2,5 mm <ul style="list-style-type: none"> : type 742 / 542 / 740 / 1542 / 562 / 536 (M4) / 537 (M5) / 560 (M6) • Cable 2,5 - 6,0 mm <ul style="list-style-type: none"> : type 539 (M6) • 204 pieces 	

41000 Assortment box plastic		←
Size	✉	Art.number
18 T 320	1	41000.000.320
		Composition: <ul style="list-style-type: none"> • Car fuses • Steel/plastic • Content: • 7,5A / 10A / 15A / 20A / 25A / 30A • 2A (5x20 mm) / 2A (6,35x25 mm) / 5A / 10A / 15A / 20A / 25A • 5A / 8A / 16A / 25A / 40A • 152 pieces
9 T 321	1	41000.000.321
		Composition: <ul style="list-style-type: none"> • NORD-LOCK Vibration proof washer 2 pieces • Steel Deltaprotekt • Content: • M4 / M5 / M6 / M8 / M10 / M12 / M14 / M16 • 180 (x2) pieces

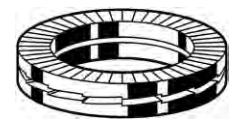
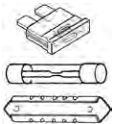

MaxxFast Assortment Boxes

A complete new range of MaxxFast assortment boxes with the best selling technical wood screws, nylon plugs and hose clamps in convenient and sturdy metal assortment boxes.

MaxxFast assortment boxes are suitable for repairs and maintenance in the factory, on site or in the workshop!

The range consists of the following boxes:

- 6 boxes of MaxxFast Revolutionary woodscrews in various types
- 1 box of MaxxFast Nylon plugs
- 2 boxes of MaxxFast Nylon plugs with matching chipboard screws
- 1 box of MaxxFast Hose clamps



Assortment box steel



Article groups

	Code	Page
S-Case	41010	11-14
MaxxFast	30950	11-22

41010 Assortment box steel

Y94A











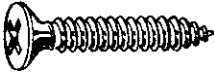

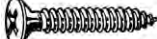



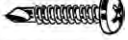

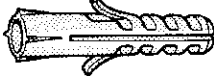

Size	☒	Art.number	Composition:	
S 502	1	41010.000.502	<ul style="list-style-type: none"> Hexagon head bolts acc. to ISO 4014, hexagon head screws acc. to ISO 4017 and hexagon nuts acc. to DIN 934 Steel class 8.8-l8l zinc plated Content: M5x10 -x16 -x20 -x30 -x40 / M6x12 -x16 -x20 -x25 -x30 -x40 -x50 / M8x20 -x25 -x30 -x40 -x50 -x60 758 pieces 	
S 504	1	41010.000.504	<ul style="list-style-type: none"> Hexagon head bolts acc. to ISO 4014, hexagon head screws acc. to ISO 4017 and hexagon nuts acc. to DIN 934 Steel class 8.8-l8l zinc plated Content: M10x20 -x25 -x30 -x40 -x50 -x60 / M12x30 -x40 -x50 / M14x50 -x60 / M16x40 -x50 -x60 157 pieces 	
S 506	1	41010.000.506	<ul style="list-style-type: none"> Hexagon head screws acc. to ISO 4017 and hexagon nuts acc. to DIN 934 Steel class 8.8-l8l zinc plated Content: M5x10 -x16 -x20 / M6x16 -x20 -x25 / M8x20 -x25 -x30 / M10x30 -x40 / M12x30 -x40 950 pieces 	
S 508	1	41010.000.508	<ul style="list-style-type: none"> Hexagon head screws acc. to ISO 4017 Steel class 8.8 zinc plated, yellow passivated Content: M5x16 -x25 / M6x10 -x16 -x20 -x25 / M8x20 -x25 -x30 / M10x25 -x30 -x35 610 pieces 	
S 510	1	41010.000.510	<ul style="list-style-type: none"> Hexagon head bolts acc. to ISO 8765, hexagon head screws acc. to ISO 8676 and hexagon nuts acc. to DIN 934 Metric fine pitch thread Steel class 8.8-l8l Content: M10x1,25x20 -x25 -x30 -x40 -x50 / M12x1,5x30 -x40 -x45 -x50 / M14x1,5x30 -x40 -x50 -x60 / M16x1,5x30 -x40 -x50 -x60 196 pieces 	
S 512	1	41010.000.512	<ul style="list-style-type: none"> Hexagon head screws acc. to ISO 4017 and hexagon nuts acc. to DIN 934 Stainless steel A2-70 Content: M5x16 -x20 / M6x16 -x20 -x25 / M8x20 -x25 -x30 / M10x20 -x30 -x40 / M12x30 -x40 434 pieces 	
S 514	1	41010.000.514	<ul style="list-style-type: none"> Hexagon head bolts acc. to ISO 4014, hexagon nuts acc. to DIN 934 and spring lock washers with square ends acc. to DIN 127 B Stainless steel A2-70 Content: M6x30 -x35 -x40 -x50 -x60 / M8x30 -x35 -x40 -x50 -x60 / M10x40 -x50 -x60 / M12x50 552 pieces 	
S 518	1	41010.000.518	<ul style="list-style-type: none"> Hexagon head screws acc. to ≈ ISO 4017 and hexagon nuts acc. to ≈ DIN 934 Plastic PA 6.6 (white) Content: M5x10 -x20 / M6x10 -x20 -x25 -x30 -x40 / M8x16 -x20 -x25 -x30 -x40 -x50 987 pieces 	

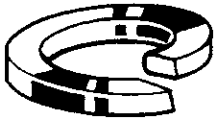





41010 Assortment box steel		←		
Size	☒	Art.number		
S 520	1	41010.000.520	Composition: <ul style="list-style-type: none"> • Finished hex bolts and hexagon nuts • Steel Grade 5 zinc plated • Content: <ul style="list-style-type: none"> • UNF 1/4 x 5/8 -x 3/4 -x 1.IN. -x 1.1/4 -x 1.1/2 -x 2.IN. / UNF 5/16 x 3/4 -x 1.IN. -x 1.1/4 -x 1.1/2 -x 2.IN. / UNF 3/8 x 3/4 -x 1.IN. -x 1.1/4 -x 1.1/2 -x 2.IN. -x 2.1/2 / UNF 7/16 x 1.1/2 • 600 pieces 	
S 522	1	41010.000.522	Composition: <ul style="list-style-type: none"> • Finished hex bolts and hexagon nuts • Steel Grade 5 zinc plated • Content: <ul style="list-style-type: none"> • UNF 7/16 x 1.IN. -x 1.1/4 -x 1.1/2 -x 1.3/4 -x 2.IN. / UNF 1/2 x 1.IN. -x 1.1/4 -x 1.1/2 -x 2.IN. / UNF 9/16 x 1.3/4 -x 2.IN. / UNF 5/8 x 1.1/2 -x 2.IN. -x 2.1/2 • 148 pieces 	
S 524	1	41010.000.524	Composition: <ul style="list-style-type: none"> • Finished hex bolts and hexagon nuts • Steel Grade 5 zinc plated • Content: <ul style="list-style-type: none"> • UNC 1/4 x 1/2 -x 5/8 -x 3/4 -x 1.IN. / UNC 5/16 x 3/4 -x 1.IN. -x 1.1/4 -x 1.1/2 / UNC 3/8 x 3/4 -x 1.IN. -x 1.1/4 -x 1.1/2 / UNC 1/2 x 1.1/4 -x 1.1/2 • 670 pieces 	
S 526	1	41010.000.526	Composition: <ul style="list-style-type: none"> • Finished hex bolts and hexagon nuts • Stainless steel A4 • Content: <ul style="list-style-type: none"> • UNC 1/4 x 3/4 / UNC 5/16 x 3/4 -x 1.IN. / UNC 3/8 x 3/4 -x1.IN. / UNC 1/2 x 1.IN. • 395 pieces 	
S 528	1	41010.000.528	Composition: <ul style="list-style-type: none"> • Mushroom head square neck bolts acc. to DIN 603 and hexagon nuts acc. to DIN 555 • Steel class 4.6-8 zinc plated • Content: <ul style="list-style-type: none"> • M5x16 -x20 -x25 -x30 / M6x25 -x30 -x35 -x40 / M8x25 -x40 -x50 -x60 • 517 pieces 	
S 530	1	41010.000.530	Composition: <ul style="list-style-type: none"> • Hexagon head wood screws acc. to DIN 571 • Steel zinc plated • Content: <ul style="list-style-type: none"> • 6x30 -x40 -x50 -x60 / 8x30 -x40 -x50 -x60 -x70 -x80 / 10x50 -x60 mm • 357 pieces 	
S 532	1	41010.000.532	Composition: <ul style="list-style-type: none"> • Hexagon head wood screws acc. to DIN 571 • Stainless steel A2 • Content: <ul style="list-style-type: none"> • 6x30 -x40 -x50 -x60 -x70 / 8x40 -x50 -x60 -x70 -x80 / 10x50 -x70 • 323 pieces 	
S 534	1	41010.000.534	Composition: <ul style="list-style-type: none"> • Hexagon socket head cap screws acc. to DIN 912 • Steel class 8.8 zinc plated • Content: <ul style="list-style-type: none"> • M4x10 -x16 -x20 / M5x10 -x16 -x20 -x25 -x30 / M6x10 -x16 -x20 -x25 -x30 -x40 / M8x20 -x25 -x30 -x40 • 885 pieces 	
S 536	1	41010.000.536	Composition: <ul style="list-style-type: none"> • Hexagon socket head cap screws acc. to DIN 912 • Stainless steel A2-70 • Content: <ul style="list-style-type: none"> • M4x10 -x12 -x16 / M5x10 -x12 -x16 -x20 / M6x10 -x12 -x16 -x20 -x25 -x30 / M8x16 -x20 -x25 -x30 -x35 • 355 pieces 	
S 538	1	41010.000.538	Composition: <ul style="list-style-type: none"> • Hexagon socket countersunk head screws acc. to DIN 7991 • Steel class 8.8 zinc plated • Content: <ul style="list-style-type: none"> • M3x8 -x16 / M4x10 -x12 -x16 / M5x10 -x16 / M6x10 -x16 -x20 -x25 / M8x20 -x25 -x30 / M10x20 -x25 -x30 -x40 • 1147 pieces 	
S 540	1	41010.000.540	Composition: <ul style="list-style-type: none"> • Hexagon socket button head screws acc. to ISO 7380 • Steel class 10.9 zinc plated • Content: <ul style="list-style-type: none"> • M4x6 -x10 / M5x12 -x16 -x20 / M6x10 -x12 -x16 -x20 -x25 / M8x16 -x20 -x25 / M10x20 -x25 -x30 / M12x25 -x30 • 582 pieces 	
S 542	1	41010.000.542	Composition: <ul style="list-style-type: none"> • Hexagon socket set screws with flat point acc. to DIN 913, hexagon socket set screws with cone point acc. to DIN 914 and hexagon socket set screws with dog point acc. to DIN 915 • Steel class 45H • Content: <ul style="list-style-type: none"> • M4x5 -x8 -x10 / M5x6 -x10 -x20 / M6x8 -x10 -x12 -x16 -x20 / M8x10 -x16 • 1950 pieces 	
S 544	1	41010.000.544	Composition: <ul style="list-style-type: none"> • Hexagon socket set screws with cup point acc. to DIN 916S • Steel class 45H zinc plated • Content: <ul style="list-style-type: none"> • M4x4 -x6 -x8 -x10 / M5x6 -x8 -x10 / M6x8 -x10 -x16 -x20 / M8x10 -x12 -x16 -x20 / M10x16 -x20 -x25 • 1105 pieces 	

41010 Assortment box steel		←		
Size	☒	Art.number		
S 546	1	41010.000.546	Composition: <ul style="list-style-type: none"> Hexagon socket set screws with cup point acc. to DIN 916 Stainless steel A2-70 Content: M6x6 -x8 -x10 -x16 / M8x16 -x20 -x25 -x30 / M10x10 -x16 -x20 -x30 585 pieces 	
S 548	1	41010.000.548	Composition: <ul style="list-style-type: none"> Hexagon socket screw plugs acc. to DIN 908 and hexagon head screw plugs acc. to DIN 910 Metric fine cylindrical thread Steel Content: M10x1 / M12x1,5 / M14x1,5 / M16x1,5 / M18x1,5 / M20x1,5 / M22x1,5 / M24x1,5 / M30x1,5 126 pieces 	
S 550	1	41010.000.550	Composition: <ul style="list-style-type: none"> Hexagon nuts acc. to DIN 934 Steel class I8I zinc plated Content: M3 / M4 / M5 / M6 / M8 / M10 / M12 / M16 2200 pieces 	
S 552	1	41010.000.552	Composition: <ul style="list-style-type: none"> Hexagon nuts acc. to ISO 4032 and plain washers without chamfer acc. to DIN 125-1A Steel class 8 zinc plated, yellow passivated Content: M4 / M5 / M6 / M8 / M10 / M12 2210 pieces 	
S 554	1	41010.000.554	Composition: <ul style="list-style-type: none"> Hexagon nuts acc. to DIN 934 and plain washers without chamfer acc. to DIN 125-1 A Stainless steel A2-70 Content: M4 / M5 / M6 / M8 / M10 / M12 1700 pieces 	
S 556	1	41010.000.556	Composition: <ul style="list-style-type: none"> Prevailing torque type hexagon nuts with non-metallic insert acc. to DIN 985 Steel class ≥ 5 zinc plated Content: M3 / M4 / M5 / M6 / M7 / M8 / M10 / M12 / M14 / M16 1450 pieces 	
S 558	1	41010.000.558	Composition: <ul style="list-style-type: none"> Prevailing torque type hexagon nuts with non-metallic insert acc. to ≈ DIN 985 Stainless steel A2 Content: M3 / M4 / M5 / M6 / M8 / M10 / M12 / M14 / M16 / M20 614 pieces 	
S 560	1	41010.000.560	Composition: <ul style="list-style-type: none"> Hexagon domed cap nuts acc. to DIN 1587 and hexagon cap nuts, low type acc. to DIN 917 Steel class 6 zinc plated Content: M4 / M5 / M6 / M8 / M10 1050 pieces 	
S 562	1	41010.000.562	Composition: <ul style="list-style-type: none"> Hexagon domed cap nuts acc. to DIN 1587 and hexagon cap nuts acc. to DIN 917 Stainless steel A1-50 Content: M4 / M5 / M6 / M8 / M10 540 pieces 	
S 564	1	41010.000.564	Composition: <ul style="list-style-type: none"> Wing screws, rounded wings acc. to DIN 316 and wing nuts light (American) type Cast iron and steel class 04 zinc plated Content: DIN 316: M5x16 / M6x10 -x20 -x30 / M8x20 -x30 Wing nuts: M4 / M5 / M6 / M8 / M10 / M12 417 pieces 	
S 566	1	41010.000.566	Composition: <ul style="list-style-type: none"> Slotted screwed inserts type A acc. to DIN 7965 and drive-in nuts for wood Steel Content: DIN 7965: M4x10 / M5x12 / M6x15 / M8x15 -x18 Drive-in nuts for wood: M4 / M5 / M6 / M8 / M10 665 pieces 	
S 570	1	41010.000.570	Composition: <ul style="list-style-type: none"> Spacers with 2x internal thread type H1200 and spacers with internal thread and external threaded stud type H1202 Steel zinc plated Content: H1200: M3x5x5 -x8,5x8,5 -x10x10 -x20x7 / M4x10x10 -x15x15 / -x25x9 -x40x9 -x50x9 H1202: M3x5x3 -x10x7 -x15x7 -x30x7 / M4x10x6 -x30x9 -x40x9 / M5x20x11 -x30x11 435 pieces 	
S 572	1	41010.000.572	Composition: <ul style="list-style-type: none"> Self-cutting threaded inserts type 300 Steel zinc plated, yellow passivated and stainless steel C4 Content: M3 / M4 / M5 / M6 / M8 / M10 / M12 / M16 420 pieces 	





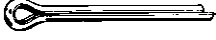
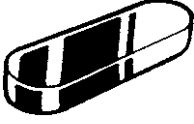

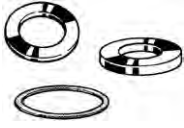
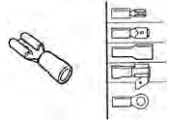
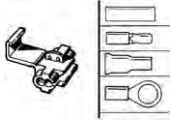
41010 Assortment box steel		←		
Size	☒	Art.number		
S 574	1	41010.000.574	Composition: <ul style="list-style-type: none"> Screw eyes art. 1G: 2,40x10x5 / 4,00x30x12 / 4,40x40x16, Square hook pins art. 4: 2,40x25 / 3,20x30 / 4,00x50, Square hooks art. 7: 2,65x30 / 3,20x40, Cross recessed heavy square hooks art. 9G: 5,25x40 -x50, Cup hooks art. 11: 2,40x16/30 / 3,20x20/40 Steel zinc plated 1050 pieces 	
S 576	1	41010.000.576	Composition: <ul style="list-style-type: none"> Dowel screws art. 73A and dowel screws with hexagon for jaw art. 69G Steel zinc plated Content: Art. 73A: M6x40 -x50 -x60 -x90 / M8x60 -x70 Art. 69G: M8x80 -x90 / M10x80 -x90 -x100 226 pieces 	
S 578	1	41010.000.578	Composition: <ul style="list-style-type: none"> Dee (chain) shackles and bow (anchor) shackles with screw collar pin Stainless steel A4 Content: 5 / 6 / 8 / 10 / 12 32 pieces 	
S 580	1	41010.000.580	Composition: <ul style="list-style-type: none"> Stud bolts acc. to DIN 976-1 A Steel class ≥ 4.6 zinc plated, yellow passivated Content: M4x30 -x40 / M5x40 -x50 / M6x30 -x40 -x50 / M8x60 -x70 -x80 / M10x40 -x60 505 pieces 	
S 582	1	41010.000.582	Composition: <ul style="list-style-type: none"> Studs metal end ≈ 1,25 d acc. to DIN 939 Stainless steel A4 Content: M6x30 / M8x20 -x25 -x40 -x50 / M10x25 -x30 -x40 -x50 / M12x40 -x50 / M16x50 73 pieces 	
S 584	1	41010.000.584	Composition: <ul style="list-style-type: none"> Slotted cheese head screws acc. to DIN 84 and hexagon nuts acc. to DIN 934 Steel class 4.8-l8l zinc plated Content: M3x10 -x12 -x16 -x20 -x25 / M4x10 -x16 -x20 -x25 -x30 / M5x20 -x25 -x30 -x40 / M6x25 -x30 -x40 -x50 3060 pieces 	
S 586	1	41010.000.586	Composition: <ul style="list-style-type: none"> Slotted countersunk head screws acc. to DIN 963 and hexagon nuts acc. to DIN 934 Steel class 4.8-l8l zinc plated Content: M3x10 -x20 -x30 / M4x10 -x20 -x30 / M5x10 -x20 -x25 / M6x20 -x30 / M8x20 -x25 2970 pieces 	
S 588	1	41010.000.588	Composition: <ul style="list-style-type: none"> Slotted cheese head screws acc. to DIN 84 and hexagon nuts acc. to DIN 934 Stainless steel A2-70 Content: M3x8 -x10 -x16 / M4x8 -x10 -x16 -x20 / M5x10 -x12 -x16 -x20 / M6x10 -x16 -x20 4550 pieces 	
S 590	1	41010.000.590	Composition: <ul style="list-style-type: none"> Slotted countersunk head screws acc. to DIN 963 and hexagon nuts acc. to DIN 934 Stainless steel A2-70 Content: M3x6 -x10 -x16 / M4x10 -x16 -x20 / M5x10 -x16 -x20 -x30 / M6x16 -x20 -x25 -x30 1550 pieces 	
S 592	1	41010.000.592	Composition: <ul style="list-style-type: none"> Hexagon nuts acc. to ≈ DIN 934, slotted cheese head screws acc. to ≈ DIN 84, slotted countersunk head screws acc. to ≈ DIN 963 and plain washers without chamfer acc. to ≈ DIN 125-1 A Plastic PA 6.6 (white) Content: M3x10 / M4x8 -x20 / M5x16 / M6x20 2100 pieces 	
S 594	1	41010.000.594	Composition: <ul style="list-style-type: none"> Phillips (H) cross recessed pan head tapping screws acc. to DIN 7981 C-H Steel zinc plated Content: ST2,9x13 / ST3,5x13 -x16 -x19 -x25 / ST4,2x13 -x16 -x19 -x25 / ST4,8x16 -x19 -x25 -x32 / ST5,5x19 -x25 -x32 / ST6,3x25 -x38 1855 pieces 	
S 596	1	41010.000.596	Composition: <ul style="list-style-type: none"> Phillips (H) cross recessed pan head tapping screws acc. to DIN 7981 C-H Steel zinc plated, black passivated Content: ST2,9x6,5 -x9,5 -x13 -x19 / ST3,5x9,5 -x13 -x16 -x19 -x25 / ST3,9x9,5 / ST4,2x9,5 -x13 -x16 -x19 -x25 / ST4,8x16 -x19 -x25 2145 pieces 	

41010 Assortment box steel		←		
Size	☒	Art.number		
S 598	1	41010.000.598	Composition: <ul style="list-style-type: none"> • Phillips (H) cross recessed countersunk head tapping screws acc. to DIN 7982 C-H • Steel zinc plated • Content: ST2,9x9,5 -x13 / ST3,5x16 -x19 -x25 -x32 / ST3,9x19 / ST4,2x13 -x16 -x19 -x25 -x32 -x38 / ST4,8x19 -x25 -x32 / ST5,5x25 -x32 • 1650 pieces 	
S 600	1	41010.000.600	Composition: <ul style="list-style-type: none"> • Phillips (H) cross recessed pan head tapping screws acc. to DIN 7981 C-H and Phillips (H) cross recessed countersunk head tapping screws acc. to DIN 7982 C-H • Stainless steel A2 • Content: ST3,5x9,5 -x13 -x16 -x19 -x25 / ST4,2x13 -x16 -x19 -x25 -x32 / ST4,8x19 -x25 • 1675 pieces 	 
S 602	1	41010.000.602	Composition: <ul style="list-style-type: none"> • Phillips (H) cross recessed raised countersunk head tapping screws acc. to DIN 7983 C-H • Steel zinc plated • Content: ST2,9x9,5 -x13 -x16 / ST3,5x13 -x16 -x19 -x25 / ST4,2x13 -x16 -x19 -x25 -x32 / ST4,8x16 -x19 -x25 -x32 / ST5,5x19 -x25 • 2175 pieces 	
S 604	1	41010.000.604	Composition: <ul style="list-style-type: none"> • Phillips (H) cross recessed raised countersunk head tapping screws acc. to DIN 7983 C-H • Steel zinc plated, black passivated • Content: ST2,9x9,5 -x13 -x19 / ST3,5x13 -x16 -x19 -x25 / ST3,9x16 -x25 / ST4,2x13 -x16 -x19 -x25 -x32 / ST4,8x16 -x19 -x25 -x32 • 1875 pieces 	
S 606	1	41010.000.606	Composition: <ul style="list-style-type: none"> • Pozidriv (Z) cross recessed countersunk screws for chipboard • Steel zinc plated • Content: 3,5x20 -x25 -x30 -x35 -x40 / 4x17 -x20 -x25 -x30 -x35 -x40 -x45 -x50 / 4,5x30 -x40 -x50 / 5x50 -x60 • 1225 pieces 	
S 608	1	41010.000.608	Composition: <ul style="list-style-type: none"> • SPEDEC: self-drilling Phillips (H) cross recessed pan head screws acc. to DIN 7504 M-H, self-drilling Phillips (H) cross recessed countersunk head screws acc. to DIN 7504 O-H and self-drilling hexagon head screws with collar acc. to DIN 7504 K • Steel zinc plated • Content: ST3,5x9,5 -x19 / ST3,9x13 -x19 / ST4,2x13 -x19 -x25 -x32 / ST4,8x13 -x16 -x19 -x32 / ST5,5x32 / ST6,3x19 • 1460 pieces 	  
S 610	1	41010.000.610	Composition: <ul style="list-style-type: none"> • Wall plugs • Plastic nylon (grey) • Content: 4 / 5 / 6 / 7 / 8 / 10 / 12 • 720 pieces 	
S 612	1	41010.000.612	Composition: <ul style="list-style-type: none"> • Mudwing repair washers and plain washers d2 ≈ 3xd1 acc. to DIN 9021 • Steel zinc plated • Content: Mudwing repair washers: M4x20 / M5x20 / M6x25 -x30 / M8x30 / M10x30 / M12x36 • DIN 9021: M4x12 / M5x15 / M6x18 / M8x24 / M10x24 • 1300 pieces 	
S 614	1	41010.000.614	Composition: <ul style="list-style-type: none"> • Plain washers without chamfer acc. to DIN 125-1 A and spring lock washers with square ends acc. to DIN 127 B • Steel zinc plated • Content: M4 / M5 / M6 / M8 / M10 / M11 / M12 / M14 / M16 • 1700 pieces 	 
S 616	1	41010.000.616	Composition: <ul style="list-style-type: none"> • Spring lock washers with square ends acc. to DIN 127 B • Stainless steel A2 • Content: M3 / M4 / M5 / M6 / M8 / M10 / M12 / M14 / M16 / M20 / M24 / M27 • 1180 pieces 	
S 618	1	41010.000.618	Composition: <ul style="list-style-type: none"> • Wave spring washers acc. to DIN 137 B, serrated lock washers external teeth acc. to DIN 6798 A and serrated lock washers internal teeth acc. to DIN 6798 J • Steel zinc plated and steel zinc plated, yellow passivated • Content: M3 / M4 / M5 / M6 / M8 / M10 • 6450 pieces 	  
S 620	1	41010.000.620	Composition: <ul style="list-style-type: none"> • Plain washers without chamfer acc. to DIN 125-1 A, wave spring washers acc. to DIN 137 B and serrated lock washers external teeth acc. to ≈ DIN 6798 A • Stainless steel A2 • Content: M3 / M4 / M5 / M6 / M8 / M10 • 2475 pieces 	  

41010 Assortment box steel		←		
Size	☒	Art.number		
S 622	1	41010.000.622	Composition: <ul style="list-style-type: none"> Retaining rings for shafts acc. to DIN 471 Steel Content: Ø 25 / 26 / 27 / 30 / 31 / 33 / 35 / 38 / 40 / 42 247 pieces 	
S 624	1	41010.000.624	Composition: <ul style="list-style-type: none"> Retaining rings for bores acc. to DIN 472 Steel Content: Ø 8 / 9 / 10 / 11 / 12 / 13 / 14 / 15 / 16 / 17 / 18 / 19 / 20 / 22 / 24 / 25 / 26 / 27 1460 pieces 	
S 626	1	41010.000.626	Composition: <ul style="list-style-type: none"> Retaining rings for shafts acc. to DIN 471 and retaining rings for bores acc. to DIN 472 Stainless steel Content: Ø 5 / 6 / 8 / 10 / 12 / 14 / 16 / 20 / 22 / 25 / 26 / 30 / 32 / 35 / 42 / 47 263 pieces 	
S 628	1	41010.000.628	Composition: <ul style="list-style-type: none"> Adjusting rings acc. to ≈ DIN 705 A with socket set screw acc. to DIN 916 Stainless steel A1 Content: 6x12x8 / 8x16x8 / 10x20x10 / 12x22x12 / 14x25x12 / 15x25x12 / 20x32x14 / 25x40x16 / 30x45x16 / 36x56x16 46 pieces 	
S 630	1	41010.000.630	Composition: <ul style="list-style-type: none"> Sealing rings acc. to DIN 7603 A Copper, annealed Content: Ø 6x10x1 / 8x12x1 / 8x14x1,5 / 10x14x1,5 / 10x16x1,5 / 12x16x1,5 / 12x18x1,5 / 13x18x1,5 / 14x18x1 / 14x20x1,5 / 16x20x1,5 840 pieces 	
S 632	1	41010.000.632	Composition: <ul style="list-style-type: none"> Sealing rings acc. to DIN 7603 A Copper, annealed Content: Ø 8x12x1 / 10x14x1,5 / 10x16x1,5 / 12x16x1,5 / 12x18x1,5 / 12x20x1,5 / 14x18x1,5 / 14x20x1,5 / 14x20x2 / 16x20x1,5 / 16x22x2 / 18x24x2 / 20x24x1,5 / 22x26x2 / 24x30x2 / 24x30x2 / 26x33x2 / 28x34x2 / 30x38x2 780 pieces 	
S 634	1	41010.000.634	Composition: <ul style="list-style-type: none"> Sealing rings acc. to DIN 7603 A Copper, annealed Content: Ø 14x20x2 / 15x20x2 / 16x22x2 / 17x24x2 / 18x24x2 / 20x24x2 / 22x26x2 / 24x30x2 / 26x33x2 / 28x34x2 / 30x38x2 / 32x40x2 275 pieces 	
S 636	1	41010.000.636	Composition: <ul style="list-style-type: none"> Filled sealing rings acc. to DIN 7603 C Copper/FESTAPLAN Content: Ø 6x10x1,5 / 8x12x1,5 / 8x14x1,5 / 12x16x2 / 14x18x2 / 14x20x2 / 16x22x2 / 18x24x2 / 20x26x2 / 24x32x2,5 / 26x32x2,5 / 32x38x2,5 645 pieces 	
S 638	1	41010.000.638	Composition: <ul style="list-style-type: none"> Packing (jointing) rings Fibre Content: Ø 5x8 / 6x9 / 7x10 / 8x12 / 9x14 / 10x14 / 11x17 / 12x16 / 12,5x18 / 14x18 / 15x19 / 16x21 / 17x22 / 18x24 / 19x23 / 20x24 / 22x26 / 24x28 1910 pieces 	
S 640	1	41010.000.640	Composition: <ul style="list-style-type: none"> O-rings (metric) Rubber - NBR 70° shore (black). Content: Ø 5x1,5 / 6x1,5 / 7x1,5 / 8x2 / 10x2 / 12x2 / 18x2 / 20x2 / 11,3x2,4 / 13,3x2,4 / 13x2,5 / 14x2,5 / 15x2,5 / 16x2,5 / 20,2x3 / 22,2x3 / 24,2x3 1075 pieces 	
S 642	1	41010.000.642	Composition: <ul style="list-style-type: none"> O-ring cord with measuring tape, knives, cutting mould and cyanoacrylate adhesive (Loctite 406) Rubber - Buna N 70° shore Content: Ø 1,78 / 2,0 / 2,4 / 2,62 / 3,0 / 3,53 / 4,0 / 5,0 / 5,33 / 5,7 ATTENTION: quantity is 10x2 meters O-ring cord. 	
S 644	1	41010.000.644	Composition: <ul style="list-style-type: none"> Grommets and blanking plugs Rubber (black) Content: Grommets: Ø 4x6,4 / 5,5x8 / 6,4x9,5 / 8x9,5 / 9,5x12,5 / 11x12,5 / 12,5x17,5 / 14,2x17,5 / 16x19 Blanking plugs: Ø 6,4x9,5 / 8x14,2 / 9,5x15,4 / 11,2x17,7 / 12,5x18,7 / 15,5x22 / 19x25,5 / 20x25,5 / 22,5x28,4 596 pieces 	
S 646	1	41010.000.646	Composition: <ul style="list-style-type: none"> STARLOCK fixing washers for shafts Springsteel (without cap) and springsteel (with stainless steel cap) Content: Ø 3 / 4 / 5 / 6 / 8 / 10 1400 pieces 	

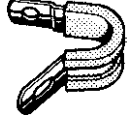
41010 Assortment box steel		←		
Size	☒	Art.number		
S 648	1	41010.000.648	Composition: <ul style="list-style-type: none"> Spring type straight pins slotted - heavy type acc. to ISO 8752 Steel Content: 4x30 -x40 -x50 -x60 / 5x20 -x26 -x30 -x40 -x50 -x60 / 6x40 -x50 -x60 -x70 / 8x40 -x50 -x60 -x70 520 pieces 	
S 650	1	41010.000.650	Composition: <ul style="list-style-type: none"> PRYM spring-type straight pins (spiral pins), coiled standard duty acc. to ISO 8750 Steel Content: 1,5x12 / 2x16 / 3x16 -x20 -x24 / 4x20 -x24 -x30 -x40 / 5x30 -x50 / 6x40 -x50 -x70 8x50 -x70 / 10x50 -x70 1040 pieces 	
S 652	1	41010.000.652	Composition: <ul style="list-style-type: none"> PRYM spring-type straight pins (spiral pins), coiled standard duty acc. to ISO 8750 Stainless steel A2 Content: 2,5x8 -x16 / 3x8 -x10 -x12 -x16 -x20 / 4x10 -x14 -x16 -x18 -x22 -x30 / 5x24 -x26 -x50 / 6x20 725 pieces 	
S 654	1	41010.000.654	Composition: <ul style="list-style-type: none"> Split pins (cotter pins) acc. to DIN 94 Steel zinc plated Content: 2x20 -x40 / 2,5x32 -x40 / 3,2x40 -x50 / 4x40 -x50 / 5x40 -x50 / 6,3x63 -x80 1345 pieces 	
S 656	1	41010.000.656	Composition: <ul style="list-style-type: none"> Split pins (cotter pins) acc. to DIN 94 Stainless steel A2 Content: 1,6x16 -x32 / 2x16 -x20 -x32 -x40 / 2,5x25 -x32 / 3,2x20 -x40 / 4x25 -x32 915 pieces 	
S 658	1	41010.000.658	Composition: <ul style="list-style-type: none"> Parallel keys - high type acc. to DIN 6885 A Steel Content: 4x4x12 / 5x5x10 -x20 -x25 / 6x6x12 -x20 -x25 -x32 -x40 / 8x7x25 -x32 -x40 -x50 / 10x8x40 -x50 -x63 / 12x8x40 -x50 336 pieces 	
S 660	1	41010.000.660	Composition: <ul style="list-style-type: none"> Woodruff keys acc. to DIN 6888 Steel Content: 2x3,7 / 2,5x3,7 / 3x3,7 -x5 -x6,5 / 4x5 -x6,5 -x7,5 -x9 / 5x6,5 -x9 / 6x9 -x11 -x13 -x15 / 8x11 -x13 / 10x13 450 pieces 	
S 662	1	41010.000.662	Composition: <ul style="list-style-type: none"> Clevis pins with head and split pin hole acc. to DIN 1434, plain washers for clevis pins acc. to DIN 1440 and split pins (cotter pins) acc. to DIN 94 Steel zinc plated Content: ISO 2341 B: Ø 5x14 / 6x18 / 8x22 / 10x28 / 12x35 / 14x40 DIN 1440: For pin Ø 5 / 6 / 8 / 10 / 12 / 14 / 16 DIN 94: 1,6x10 / 2x16 / 2,5x20 / 3,2x20 / 4x25 234 pieces 	
S 666	1	41010.000.666	Composition: <ul style="list-style-type: none"> Sealing rings acc. to DIN 7603 A, filled sealing rings acc. to DIN 7603 C and plain washers without chamfer acc. to DIN 125-1 A Aluminium 99F11; hardness HB 32-45, copper, copper/FESTAPLAN and plastic PA 6.6 (white) Content: Aluminium: Ø 8x14x1 / 10x14x1 / 12x18x1,5 / 14x20x1,5 / 16x22x1,5 / 18x24x1,5 / 20x26x1,5 Copper: Ø 10x16x1,5 / 12x16x1,5 / 14x20x1,5 / 16x22x2 / 18x24x2 / 20x24x2 Copper/FESTAPLAN: Ø 14x20x2 / 16x22x2 / 18x24x2 / 20x26x2 Plastic: M14,5 1155 pieces 	
S 668	1	41010.000.668	Composition: <ul style="list-style-type: none"> Pre-insulated terminals Steel/plastic Content: Cable 0,5 - 1,5 mm: type 599 / 741 / 541 / 540 / 1541 / 561 / 556 (M3) / 535 (M4) / 557 (M5) Cable 1,5 - 2,5 mm: type 742 / 542 / 740 / 1542 / 562 / 536 (M4) / 537 (M5) / 560(M6) Cable 2,5 - 6,0 mm: type 539 (M6) 408 pieces 	
S 670	1	41010.000.670	Composition: <ul style="list-style-type: none"> Pre-insulated terminals and connectors Steel/plastic Content: Cable 0,5 - 1,5 mm: type 545 / 547 / 548 Cable 1,5 - 2,5 mm: type 546 / 550 / 549 Cable 2,5 - 6,0 mm: type 563 (M8) / 554 (M10) Connector type C-560 blue 298 pieces 	

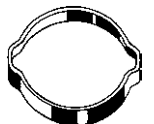
41010 Assortment box steel		←		
Size	☒	Art.number		
S 672	1	41010.000.672	<p>Composition:</p> <ul style="list-style-type: none"> • Car fuses • Steel/plastic • Content: • 7,5A / 10A / 15A / 20A / 25A / 30A • 2A (5x20 mm) / 2A (6,35x25 mm) / 5A / 10A / 15A / 20A / 25A • 5A / 8A / 16A / 25A / 40A • 304 pieces 	
S 676	1	41010.000.676	<p>Composition:</p> <ul style="list-style-type: none"> • Lubricating nipples cone type acc. to ≈ DIN 71412 and drive-in lubricating nipples • Steel zinc plated • Content: • M6x1-45° -90° -180° / M8x1-45° -90° -180° / M8x1,25-45° -90° -180° / M10x1-45° -90° -180° / M10x1,25-45° -90° -180° • Drive-in-lubricating nipple: 6-45° -180° / 8-90° -180° • 246 pieces 	
S 680	1	41010.000.680	<p>Composition:</p> <ul style="list-style-type: none"> • Helical compression springs acc. to DIN 2095 • Spring steel zinc plated • Content: • 0,5x3,5x15 / 0,5x4,5x12 / 0,5x6,5x20 -x30 / 0,8x5,7x25 / 0,8x6,7x25 / 0,8x7,7x30 -x35 -x50 / 1x6x25 / 1x8x25 -x30 / 1x10x25 -x60 / 1,5x10x50 / 1,5x12x40 / 1,5x14x60 / 2x14x50 • 695 pieces 	
S 682	1	41010.000.682	<p>Composition:</p> <ul style="list-style-type: none"> • Helical tension springs acc. to DIN 2097 • Spring steel zinc plated • Content: • 0,5x3,5x20 / 0,5x4,5x20 / 0,5x6,5x20 -x25 -x30 -x35 / 0,8x6,7x30 -x35 / 0,8x7,7x40 -x50 / 1x6x30 / 1x8x25 -x35 / 1x10x35 -x40 -x60 / 1,5x10x35 -x50 • 522 pieces 	
S 684	1	41010.000.684	<p>Composition:</p> <ul style="list-style-type: none"> • SECURITY: pan head screws with 2 holes, countersunk head screws with 2 holes, cross recessed pan head tapping screws with pin, one way tapping screws, square socket drive round head wood screws, hexagon socket button head cap screws with pin, screwdriver bits, hexagon socket screw key, screwdriver and nuts • Steel, steel zinc plated and stainless steel A2 • Content: • Pan head screws with 2 holes: M4x10 / M5x12 + screwdriver bit • Countersunk head screws with 2 holes: M3x12 / M4x10 + screwdriver bit • Cross recessed pan head tapping screws with pin: ST 4,8x13 -x19 + screwdriver bit • One way tapping screws: ST 3,5x25 / ST 4,2x19 -x32 • Square socket drive round head wood screws: 4,2x25 -x32 • Hexagon socket button head cap screws with pin: M6x25 + hexagon socket screw key • Nuts: M8 • Screwdriver • 310 	
S 686	1	41010.000.686	<p>Composition:</p> <ul style="list-style-type: none"> • Parallel shank twist drills acc. to DIN 338-RN (code U0000) • Steel HSS • Content: • Ø 0,5 / 1 / 1,5 / 2 / 2,5 / 3 / 3,5 / 4 / 4,5 / 5 / 5,5 / 6 / 6,5 / 7 / 7,5 / 8 / 8,5 / 9 / 9,5 / 10 • 175 pieces 	
S 688	1	41010.000.688	<p>Composition:</p> <ul style="list-style-type: none"> • Furniture fasteners: hexagon screwed inserts type SK, hexagon socket screwed inserts with collar type SKD, knurled nuts type RM, hexagon socket dowel nuts type RSK, hexagon socket flat head cap nuts type RF, hexagon socket mushroom head cap nuts type RT, knock-in inserts with collar type TS, slotted cross dowels type Q, hexagon socket flat head cap screws type KF, hexagon socket mushroom head cap screws type KT and hexagon socket corner connectors type KOK • Steel zinc plated, steel nickel plated and brass nickel plated • Content: • Hexagon screwed inserts: M6x15 • Hexagon socket screwed inserts with collar: M6x15 • Knurled nuts: M6x18 • Hexagon socket dowel nuts: M6x16 • Hexagon socket flat head cap nuts: M6 • Hexagon socket mushroom head cap nuts: M6 • Knock-in inserts with collar: M6 • Slotted cross dowels: M6x12 -x14 • Hexagon socket flat head cap screws: M6x50 -x60 -x70 • Hexagon socket mushroom head cap screws: M6x50 -x60 -x70 • Hexagon socket corner connectors: 7x50 • 425 pieces 	
S 690	1	41010.000.690	<p>Composition:</p> <ul style="list-style-type: none"> • Wall plugs and masonry drills type A • Plastic nylon (grey) and steel • Content: • 5 / 6 / 7 / 8 / 10 / 12 • 520 pieces 	
S 692	1	41010.000.692	<p>Composition:</p> <ul style="list-style-type: none"> • Car fuses • Steel/plastic • Content: • 7,5A / 10A / 15A / 20A / 25A / 30A • 4A / 5A / 7,5A / 10A / 15A / 20A / 25A / 30A • 20A / 30A / 40A / 50A / 60A / 70A / 80A • 276 pieces 	

41010 Assortment box steel		←		
Size	☒	Art.number		
S 694	1	41010.000.694	<p>Composition:</p> <ul style="list-style-type: none"> NORD-LOCK Vibration proof washer 2 pieces Steel Deltaprotekt Content: M8 / M10 / M14 / M16 / M18 / M20 / M24 170 (x2) pieces 	
S 698	1	41010.000.698	<p>Composition:</p> <ul style="list-style-type: none"> OMNI domed head blind rivets, plain washers without chamfer acc. to DIN 125-1 A and handtool Aluminium with steel zinc plated mandrel Content: 3x6 -x8 -x10 / 4x6 -x8 -x10 -x12 -x16 / 4,8x8 - x10 -x12 -x14 DIN 125-1 A: M3 / M4 / M5 Handtool: type F150B 1,565 pieces 	
S 700	1	41010.000.700	<p>Composition:</p> <ul style="list-style-type: none"> ABA Rubber lined clip Content: 5 / 6 / 8 / 10 / 11 / 13 / 14 / 16 mm 130 pieces 	
S 702	1	41010.000.702	<p>Composition:</p> <ul style="list-style-type: none"> ABA Nova and Mini clamps Content: Nova 11-17 / 13-20 / 15-24 / 19-28 / 22-32 / 26-38 mm Mini No. 8 / 10 / 12 / 14 / 16 / 17 1 flexible screwdriver 146 pieces 	
S 704	1	41010.000.704	<p>Composition:</p> <ul style="list-style-type: none"> ABA 2-ear clamps Content: 5-7 / 7-9 / 9-11 / 11-13 / 13-15 / 15-18 / 17-20 / 20-23 / 23-25 1 tool 601 pieces 	
S706	1	41010.000.706	<p>Composition:</p> <ul style="list-style-type: none"> NORD-LOCK Vibration proof washer / NORD-LOCK Vibration proof washer large outside diameter Content: M6 - M8 - M10 - M12 - M16 - M20 / M6x13,5 - M8x16 - M10x21 - M12x25 - M16x30 - M20x39 350 pieces 	

30950 Assortment box steel		MFNA
		
		

Size	☒	Art.number		
Woodscrew 3,5X25-6X60	1	30950.007.001	<p>Composition:</p> <ul style="list-style-type: none"> 3,5x25mm, 4x30mm, 4x35mm, 4x40mm, 4x45mm, 5x40mm, 5x50mm, 6x60mm MF 1/4 Bit TTAP 15, MF 1/4 Bit TTAP 20, MF 1/4 Bit TTAP 25 	
Woodscrew 3,5X16-5X70	1	30950.007.002	<p>Composition:</p> <ul style="list-style-type: none"> 3,5x25mm, 3,5x20mm, 3,5x25mm, 3,5x30mm, 3,5x35mm, 4x30mm, 4x40mm, 4x50mm, 4x60mm, 5x50mm, 5x60mm, 5x70mm MF 1/4 Bit TTAP15, MF 1/4 Bit TTAP 20, MF 1/4 Bit TTAP 25 	
Woodscrew 3X16-5X50	1	30950.007.003	<p>Composition:</p> <ul style="list-style-type: none"> 3x16mm, 3,5x20mm, 3,5x25mm, 4x16mm, 4x20mm, 4x25mm, 4x30mm, 4x40mm, 5x20mm, 5x30mm, 5x40mm, 5x50mm MF 1/4 Bit TTAP 10, MF 1/4 Bit TTAP 15, MF 1/4 Bit TTAP 20, MF 1/4 Bit TTAP 25 	
Woodscrew 3,5X25-6X60	1	30950.007.010	<p>Composition:</p> <ul style="list-style-type: none"> 3,5x25mm, 4x30mm, 4x35mm, 4x40mm, 4x45mm, 5x40mm, 5x50mm, 6x60mm MF 1/4 Bit TTAP PZ2, MF 1/4 Bit TTAP PZ3 	
Woodscrew 3,5X16-5X70	1	30950.007.011	<p>Composition:</p> <ul style="list-style-type: none"> 3,5x25mm, 3,5x20mm, 3,5x25mm, 3,5x30mm, 3,5x35mm, 4x30mm, 4x40mm, 4x50mm, 4x60mm, 5x50mm, 5x60mm, 5x70mm MF 1/4 Bit PZ2 	
Woodscrew 3X16-5X50	1	30950.007.012	<p>Composition:</p> <ul style="list-style-type: none"> 3x16mm, 3,5x20mm, 3,5x25mm, 4x16mm, 4x20mm, 4x25mm, 4x30mm, 4x40mm, 5x20mm, 5x30mm, 5x40mm, 5x50mm MF 1/4 Bit PZ1, MF 1/4 Bit PZ2 	

30950 Assortment box steel				←
Size	☒	Art.number		
Plug 5-6-8-10-12	1	30950.009.001	Composition: <ul style="list-style-type: none"> • 4FAST: 5, 6, 8, 10, 12mm • Multifast: 6, 8, 10mm 	
Plug + screw 5-6-8-10	1	30950.009.002	Composition: <ul style="list-style-type: none"> • 4FAST: 5, 6, 8, 10mm • Chipboard screw: 4x30mm, 4,5x40mm, 5x50mm, 6x60mm 	
Plug + screw 6-8-10	1	30950.009.003	Composition: <ul style="list-style-type: none"> • 4FAST: 6, 8, 10mm • Chipboard screw: 4,5x40mm, 5x50mm, 6x60mm, 4,5x45mm, 4,5x60mm, 5x70mm • Multifast: 6, 8, 10mm 	
Hose-clamp 8-70	1	30950.012.001	Composition: <ul style="list-style-type: none"> • 9mm 8-16, 12-22, 16-27, 20-32, 25-40, 32-50, 40-60, 50-70 	

Accessories assortment



Article groups	
Code	Page
41030	11-23
41020	11-24
41040	11-24

41030 Cabinet drawers		*99B

Type	☒	Art.number		
SF-3	1	41030.001.770	<ul style="list-style-type: none"> • Usable for 3 x type S Quality assortment boxes (steel) • Size: 385 x 265 x 215 mm • Robust, stackable • With two holes in the back, enabling the storage cabinet to be attached to the wall if required 	
SF-5	1	41030.001.780	<ul style="list-style-type: none"> • For use with 5 x type S Quality assortment boxes (steel). • Size: 415 x 255 x 430 mm. • Each drawer has a handy red locking device. • Each drawer is extendable with telescopic lever. • A cylinder lock enables all the drawers to be locked in a single operation. Fastening materials are included, enabling the chest of drawers to be attached to the wall. 	

41020 S-box *99B



Type	☒	Art.number
S-case complete	1	41020.001.775



41040 Accessories assortment *99B

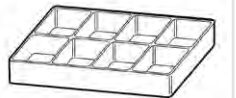

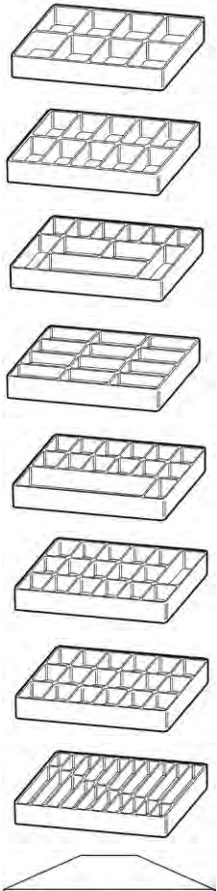

Type	☒	Art.number
8-Comp.	1	41040.100.008
10-Comp.	1	41040.100.010
11-Comp.	1	41040.100.011
12-Comp.	1	41040.100.012
14-Comp.	1	41040.100.014
17-Comp.	1	41040.100.017
18-Comp.	1	41040.100.018
20-Comp.	1	41040.100.020
Foam cover	1	41040.200.010



KEEPSTOCK HARDWARE

All the hardware you need for the most efficient KeepStock solution.
A variety of Cabinets, Racks, Bins and more.

 <p>Standing cabinet with 12 shelves without partitions. W1200.000.005 198x60x30 cm</p>	 <p>Tilting storage cabinet without tilt bins. Suitable for 96 tilt bins. W1200.200.027 200x100x30 cm</p>	 <p>Standing cabinet with 12 shelves without partitions. W1201.201.031 198x100x30 cm</p>		
 <p>Transport cabinet with two covers and handles. W1201.202.300 147x100x52 cm</p>	 <p>Cabinet with 8 holes for threaded rods. W1297.000.008 63x60x25 cm</p>	 <p>Mobile bin unit with 2 nylon rigid and 2 swivelling casters with brakes and 18 mounting strips for bin nos. 52, 53, 54 and 55. W1210.001.775</p>		
 <p>Plastic tilt unit for storage cabinet. W1276.001.125 160x115x110 cm</p>	 <p>Tilt bin for tilt unit. W1276.001.105</p>	 <p>Plastic partition for storage cabinet. W1290.001.030</p>	 <p>Metal partition for storage cabinet. W1290.000.030</p>	 <p>Plastic suspendable bin for mobile bin unit. W1275.000.052: 16,5x20,5x35 cm W1275.000.053: 13x15x24 cm W1275.000.054: 17,5x10x17,5 cm W1275.000.055: 5x10,5x9 cm</p>

Please check our website, www.fabory.com, for more detailed information about all KeepStock hardware as well as KeepStock solutions.

Carrying box



63152 FISCHER Carrying box		N03B
Material	Plastic	 
Color	Red	

Type	☒	Art.number	
MOBIBOX	1	63152.001.770	• With aluminium handle, red.



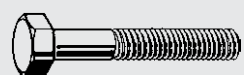

1 Bolts



2 Hexagon socket products



3 Nuts, rivet nuts & inserts



4 Threaded rods & studbolts



5 Hook & eye products



6 Screws

I Index



7 Washers & O-rings

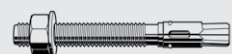

8 Anchoring products

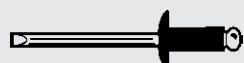

9 Rivets, pins & keys



10 Systems, furniture & security fasteners



11 Assortments & storage systems

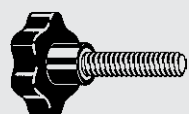

12 Engineering parts & machine parts

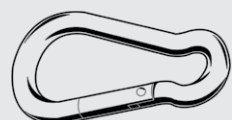

13 Maritime products











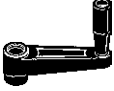

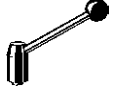

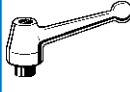











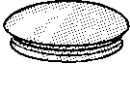

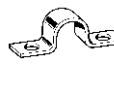

T Fastening technology

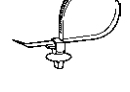
Engineering parts & machine parts **12**

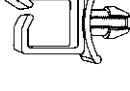

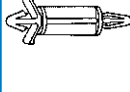

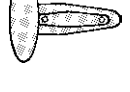

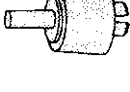



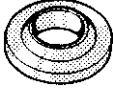

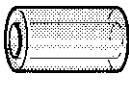

 Page 12-6 Hose clamp 9mm	 Page 12-8 Hose clamp 12mm	 Page 12-9 Hose clamp 12mm stainless steel	 Page 12-11 Hose clamp stainless steel	 Page 12-12 MAXXFAST Mini hose clamp
 Page 12-13 ABA Mini hose clamp	 Page 12-14 ABA heavy duty hose clamp stainless steel	 Page 12-15 ABA heavy duty hose clamp	 Page 12-16 Micro hose clamp	 Page 12-16 One-ear clip
 Page 12-17 ABA Two-ear clip	 Page 12-18 Hose clamp two parts	 Page 12-19 MAXXFAST Rubber lined clip	 Page 12-20 ABA Rubber lined clip	 Page 12-21 Assortment hose clamp
 Page 12-23 Flexible socket screwdriver	 Page 12-24 Exhaust pipe clamp	 Page 12-25 Pipe clamp 8mm	 Page 12-26 BAND-IT	 Page 12-29 U-bolt type A
 Page 12-31 U-bolt type B	 Page 12-32 Half pipe clamps Steel	 Page 12-34 Half pipe clamps stainless steel	 Page 12-36 Full pipe clamps steel	 Page 12-37 Full pipe clamps stainless steel
 Page 12-39 Ornamental hood	 Page 12-40 DIN ≈443 Sealing push-in cap	 Page 12-41 DIN ≈470 Sealing washer	 Page 12-42 DIN ≈71412 Conical Metric	 Page 12-43 Drive-in
 Page 12-43 DIN ≈3405 A Cupped model Metric	 Page 12-44 DIN ≈3404 A Flat Metric (fine)	 Page 12-44 DIN ≈71412 A/B/C Conical Metric fine	 Page 12-45 DIN ≈71412 A/B/C Conical Metric extra fine	 Page 12-45 DIN ≈71412 A/B/C Conical Non Metric R
 Page 12-46 DIN ≈71412 A/B/C Conical Non Metric UNF	 Page 12-46 DIN ≈3404 A Flat G	 Page 12-47 DIN 71802 CS Metric/Metric fine	 Page 12-48 DIN 808 E Single	 Page 12-49 DIN 808 D Double
 Page 12-49 DIN 71752 Fork joint	 Page 12-50 DIN 648 B Rod end with internal thread	 Page 12-52 DIN 648 A Rod end with external thread	 Page 12-53 Multiple connector	 Page 12-53 Clamping joint individually adjustable
 Page 12-54 Welding hinge steel	 Page 12-55 Thermoplast hinge	 Page 12-56 Slotted spring plungers with ball	 Page 12-57 Slotted spring plungers with pin	 Page 12-58 With pin and hexagon socket

 Page 12-59 With plastic pin and hexagon socket	 Page 12-59 Smooth execution	 Page 12-60 Without locking groove	 Page 12-60 With locking groove Plastic	 Page 12-61 Steel
 Page 12-61 Mounting type A	 Page 12-62 Mounting type B	 Page 12-63 Mounting type C	 Page 12-64 Mounting type D-KD	 Page 12-65 Mounting type RA
 Page 12-66 Mounting type RAEM	 Page 12-67 Mounting type RAB	 Page 12-68 Mounting type M	 Page 12-69 Mounting type SE	 Page 12-69 Hammer-In square cap
 Page 12-70 Foot plate	 Page 12-71 Spindle	 Page 12-72 Machine support	 Page 12-73 Bush type VP	 Page 12-74 DIN 2095 Compression spring
 Page 12-75 DIN 2097 Tension spring	 Page 12-76 DIN ≈319 Metric	 Page 12-77 DIN ≈319 M With conical hole	 Page 12-78 DIN ≈6336 L Type L Metric	 Page 12-78 DIN ≈6336 K Type K Metric
 Page 12-79 4-Grips Metric	 Page 12-80 4-Grips deep Metric	 Page 12-81 Metric	 Page 12-82 3-Star Metric	 Page 12-83 5-Star Metric
 Page 12-84 For hexagon	 Page 12-85 For hexagon socket	 Page 12-85 Metric	 Page 12-86 Metric	 Page 12-87 Metric
 Page 12-87 Metric	 Page 12-88 Metric	 Page 12-88 Metric	 Page 12-89 Metric	 Page 12-90 With insert Metric
 Page 12-90 With hole	 Page 12-91 Solid Metric	 Page 12-91 With tubular and hole	 Page 12-92 Conical flat Metric	 Page 12-92 Conical round Metric
 Page 12-93 Conical hollow	 Page 12-93 Not revolvable Metric	 Page 12-94 Revolvable Metric	 Page 12-95 Revolvable Metric	 Page 12-95 Foldaway handle revolvable Metric

Engineering parts & machine parts **12**

 Page 12-96 Foldaway Metric	 Page 12-96 With handle Metric	 Page 12-97 With ball knob Metric	 Page 12-97 Liftable Metric	 Page 12-98 Liftable Metric
 Page 12-99 Liftable Metric	 Page 12-101 Liftable with ball Metric	 Page 12-102 Liftable Metric	 Page 12-103 Firm high Metric	 Page 12-103 Firm Metric
 Page 12-104 DIN 388-1C Plastic	 Page 12-105 DIN 950 Aluminium	 Page 12-106 2-Spokes Plastic	 Page 12-106 Foldaway handle 2-spokes Plastic	 Page 12-107 Closed plastic
 Page 12-107 Solid with handle plastic	 Page 12-108 Solid with foldaway handle Plastic	 Page 12-108 Solid with foldaway handle Plastic	 Page 12-109 Solid with foldaway handle Plastic	 Page 12-111 DIN =5401 Technical ball
 Page 12-113 Technical ball Non ferro	 Page 12-115 Grommet	 Page 12-116 Blanking plug	 Page 12-117 With 1 fixing hole	 Page 12-118 With 2 fixing holes
 Page 12-120 Cable tie	 Page 12-122 Cable tie stainless steel	 Page 12-123 Cable tie	 Page 12-124 Cable tie assortment	 Page 12-124 Cable tie with eye
 Page 12-125 Cable tie with label	 Page 12-126 Cable tie releasable	 Page 12-127 Cable tie with mount	 Page 12-127 Cable tie mount	 Page 12-128 Cable tie mount
 Page 12-129 Hand pliers for cable ties	 Page 12-130 Hose clamp plastic	 Page 12-131 Cable clip	 Page 12-132 Cable clip adhesive	 Page 12-133 Cable clip adhesive
 Page 12-134 Driller	 Page 12-135 Spacer plastic	 Page 12-136 Drive rivet	 Page 12-137 Screw rivet	 Page 12-138 Ratched rivet
 Page 12-139 Push rivet	 Page 12-140 Expansion nut	 Page 12-141 Glide	 Page 12-142 Bumper adhesive	 Page 12-143 Protective buffer

Engineering parts & machine parts 12

 <p>Page 12-143</p> <p>Closed plastic</p>	 <p>Page 12-144</p> <p>Retaining washer</p>	 <p>Page 12-145</p> <p>Shoulder washer</p>	 <p>Page 12-145</p> <p>Insulating bush</p>	 <p>Page 12-146</p> <p>Slide bearing</p>
 <p>Page 12-147</p> <p>Insulating bush</p>	 <p>Page 12-147</p> <p>Spacer plastic</p>	 <p>Page 12-148</p> <p>Insulating tube</p>	 <p>Page 12-149</p> <p>Cover plug</p>	 <p>Page 12-150</p> <p>Protecting cap and plug</p>
 <p>Page 12-151</p> <p>Vertical</p>	 <p>Page 12-153</p> <p>Horizontal</p>	 <p>Page 12-156</p> <p>Push-pull</p>	 <p>Page 12-159</p> <p>Toggle clamp</p>	 <p>Page 12-160</p> <p>Horizontal</p>
 <p>Page 12-161</p> <p>Vertical</p>	 <p>Page 12-162</p> <p>Counter catch for hook</p>			

MaxxFast hose clamps

- Smooth band underside and beveled edges preventing damage to the hose.
- Strong housing with mechanical interlocking.
- The housing design ensures a tight contact between the screw and the band.
- The overall design ensures excellent clamping force distribution around the band, hence preventing highpressure leakage.
- ROHS compliant (2006)
- DIN 3017

MaxxFast zinc plated hose clamps

- MaxxFast 9mm ZPL hose clamps
- MaxxFast 12mm ZPL hose clamps
- MaxxFast hose clamps tool
- MaxxFast mini clips
- MaxxFast rubber lined clips

MaxxFast stainless steel hose clamps

- MaxxFast 12mm STNL STL hose clamps

MaxxFast hose clamps rack

Our exclusive MaxxFast hose clamps rack is fitted with the most used standard steel hose clamps and miniclips and a specially designed tool.



Hose clamp band width 9mm

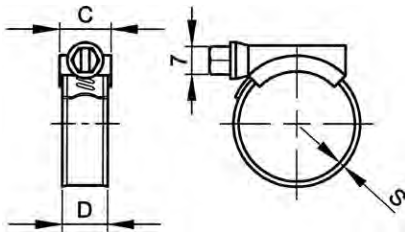

Technical Data

Type	C (max.)	D	S	Tightening torque (max.) (Nm)
8-14	12	9	0.8	3.5
8-16	14	9	0.6	3
11-17	12	9	0.8	3.5
12-22	14	9	0.6	3
13-20	12	9	0.8	4
15-24	12	9	0.8	4
16-27	14	9	0.7	3.5
19-28	12	9	0.8	4
20-32	14	9	0.7	3.5
22-32	12	9	0.8	4
25-40	14	9	0.7	4
26-38	12	9	0.8	4.5
32-44	12	9	0.8	4.5
32-50	14	9	0.7	4
38-50	12	9	0.8	4.5
40-60	14	9	0.7	4
44-56	12	9	0.8	4.5
50-65	12	9	0.8	4.5
50-70	14	9	0.7	4
58-75	12	9	0.8	4.5
68-85	12	9	0.8	4.5

- The type number displays the minimum and maximum grip range.

Article groups

Material	Surface treatment	Code	Page
St	Zipl	30650	12-6
St	Zipl	43081	12-7
St	Zipl	large pack	12-7

30650 MAXXFAST Hose clamp band width 9mm

MF60

Material	Steel
Surface treatment	Zinc plated

MAXXFAST
PROFESSIONAL HARDWARE



Grip range	☒	Art.number	Grip range	☒	Art.number	Grip range	☒	Art.number
8-16MM	50	30650.008.016	20-32MM	50	30650.020.032	40-60MM	25	30650.040.060
12-22MM	50	30650.012.022	25-40MM	50	30650.025.040	50-70MM	25	30650.050.070
16-27MM	50	30650.016.027	32-50MM	25	30650.032.050			

- Full boxes only.

43081	ABA Hose clamp band width 9mm	Y01A
Material	Steel	
Surface treatment	Zinc plated	

Special features of ABA hose clamps:

- with the **BLUE** one piece pressed housing (ABA patent)
- rolled-up band edges, no damage of the hose
- smooth band underside that protects the hose
- easy to install and to loosen due to the hexagon slotted head
- re-usable



Grip range	✉	Art.number	Grip range	✉	Art.number	Grip range	✉	Art.number
8-14MM	10	43081.008.014	11-17MM	10	43081.011.017	13-20MM	10	43081.013.020

43080	ABA Hose clamp band width 9mm	Y01A
Material	Steel	
Surface treatment	Zinc plated	

Special features of ABA hose clamps:

- with the **BLUE** one piece pressed housing (ABA patent)
- rolled-up band edges, no damage of the hose
- smooth band underside that protects the hose
- easy to install and to loosen due to the hexagon slotted head
- re-usable



Grip range	✉	Art.number	Grip range	✉	Art.number	Grip range	✉	Art.number
8-14MM	50	43080.008.014	22-32MM	50	43080.022.032	44-56MM	50	43080.044.056
11-17MM	50	43080.011.017	26-38MM	50	43080.026.038	50-65MM	50	43080.050.065
13-20MM	50	43080.013.020	32-44MM	50	43080.032.044	58-75MM	25	43080.058.075
15-24MM	50	43080.015.024	38-50MM	50	43080.038.050	68-85MM	25	43080.068.085
19-28MM	50	43080.019.028						

Hose clamp band width 12mm

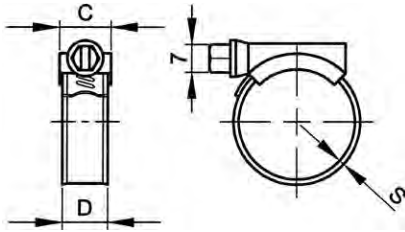

Technical Data

Type	C (max.)	D	S	Tightening torque (max.) (Nm)
13-20	17	12	0.8	5
15-24	17	12	0.8	5
16-27	18	12	0.8	4.2
19-28	17	12	0.8	5
20-32	18	12	0.8	5.2
22-32	17	12	0.8	5
25-40	18	12	0.8	5.2
26-38	17	12	0.8	5
32-44	17	12	1	6
32-50	18	12	0.8	6
38-50	17	12	1	6
40-60	18	12	0.8	6
44-56	17	12	1	6
50-65	17	12	1	6
50-70	18	12	0.8	6.8
58-75	17	12	1	6
60-80	18	12	0.8	6.8
68-85	17	12	1	6
70-90	18	12	0.8	6.8
77-95	17	12	1	6
80-100	18	12	0.8	6.8
87-112	17	12	1	6
90-110	18	12	0.8	6.8
104-138	17	12	1	6
130-165	17	12	1	6
150-180	17	12	1	6
175-205	17	12	1	6
200-231	17	12	1	6
226-256	17	12	1	6
251-282	17	12	1	6
277-307	17	12	1	6

- The type number displays the minimum and maximum grip range.

Article groups

Material	Surface treatment	Code	Page
St	Zipl	30660	12-8
St	Zipl	43011	12-9
St	Zipl	large pack	43010

30660 MAXXFAST Hose clamp band width 12mm

MF60

Material Steel
Surface treatment Zinc plated

MAXXFAST
PROFESSIONAL HARDWARE



Grip range	☒	Art.number	Grip range	☒	Art.number	Grip range	☒	Art.number
16-27MM	50	30660.016.027	40-60MM	25	30660.040.060	70-90MM	10	30660.070.090
20-32MM	50	30660.020.032	50-70MM	25	30660.050.070	80-100MM	10	30660.080.100
25-40MM	50	30660.025.040	60-80MM	25	30660.060.080	90-110MM	10	30660.090.110
32-50MM	50	30660.032.050						

- Full bags only.

43011 ABA Hose clamp band width 12mm Y01A

Material: Steel
Surface treatment: Zinc plated

ABA

Grip range	☒	Art.number	Grip range	☒	Art.number	Grip range	☒	Art.number
15-24MM	10	43011.015.024	38-50MM	10	43011.038.050	77-95MM	10	43011.077.095
19-28MM	10	43011.019.028	44-56MM	10	43011.044.056	87-112MM	10	43011.087.112
22-32MM	10	43011.022.032	50-65MM	10	43011.050.065	104-138MM	10	43011.104.138
26-38MM	10	43011.026.038	58-75MM	10	43011.058.075	130-165MM	10	43011.130.165
32-44MM	10	43011.032.044	68-85MM	10	43011.068.085			

43010 ABA Hose clamp band width 12mm Y01A

Material: Steel
Surface treatment: Zinc plated

ABA

Grip range	☒	Art.number	Grip range	☒	Art.number	Grip range	☒	Art.number
15-24MM	50	43010.015.024	50-65MM	50	43010.050.065	150-180MM	10	43010.150.180
19-28MM	50	43010.019.028	58-75MM	25	43010.058.075	175-205MM	10	43010.175.205
22-32MM	50	43010.022.032	68-85MM	25	43010.068.085	200-231MM	10	43010.200.231
26-38MM	50	43010.026.038	77-95MM	25	43010.077.095	226-256MM	10	43010.226.256
32-44MM	50	43010.032.044	87-112MM	25	43010.087.112	251-282MM	10	43010.251.282
38-50MM	50	43010.038.050	104-138MM	25	43010.104.138	277-307MM	10	43010.277.307
44-56MM	50	43010.044.056	130-165MM	25	43010.130.165			

Hose clamp band width 12mm Stainless steel A2

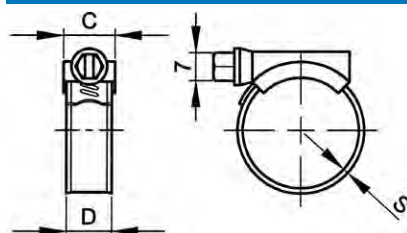

Technical Data				
Type	C (max.)	D	S	Tightening torque (max.) (Nm)
15-24	17	12	0.8	5
16-27	18	12	0.8	4.6
19-28	17	12	0.8	5
20-32	18	12	0.8	5.6
22-32	17	12	0.8	5
25-40	18	12	0.8	5.6
26-38	17	12	0.8	5
32-44	17	12	0.8	6
32-50	18	12	0.8	6.5
38-50	17	12	0.8	6
40-60	18	12	0.8	6.5
44-56	17	12	0.8	6
50-65	17	12	0.8	6
50-70	18	12	0.8	7
58-75	17	12	0.8	6
68-85	17	12	0.8	6
77-95	17	12	0.8	6
87-112	17	12	0.8	6
104-138	17	12	0.8	6
130-165	17	12	0.8	6
150-180	17	12	0.8	6
175-205	17	12	0.8	6
200-231	17	12	0.8	6
226-256	17	12	0.8	6
251-282	17	12	0.8	6
277-307	17	12	0.8	6



- The type number displays the minimum and maximum grip range.

Article groups

Material	Code	Page
St.St. A2	30664	12-10
St.St. A2	43020	12-10

30664 MAXXFAST Hose clamp band width 12mm Stainless steel A2 MF60

Material: Stainless steel A2







Grip range	⊗	Art.number	Grip range	⊗	Art.number	Grip range	⊗	Art.number
16-27MM	10	30664.016.027	25-40MM	10	30664.025.040	40-60MM	10	30664.040.060
20-32MM	10	30664.020.032	32-50MM	10	30664.032.050	50-70MM	10	30664.050.070

- Full bags only.

43020 ABA Hose clamp band width 12mm Stainless steel A2 Y03A

Material: Stainless steel A2



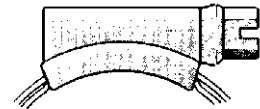
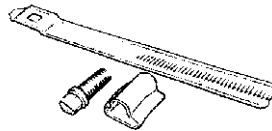
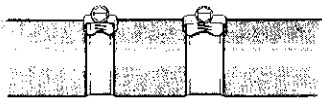

- Special features of ABA hose clamps:
- with the one piece pressed stainless steel housing (ABA patent)
 - rolled-up band edges, no damage of the hose
 - smooth band underside that protects the hose
 - easy to install and to loosen due to the hexagon slotted head
 - re-usable many times

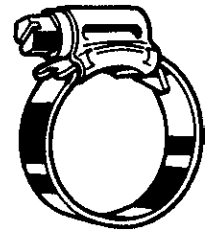
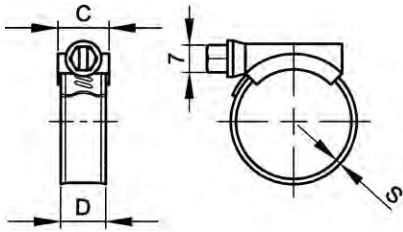

Grip range	⊗	Art.number	Grip range	⊗	Art.number	Grip range	⊗	Art.number
15-24MM	10	43020.015.024	50-65MM	10	43020.050.065	150-180MM	5	43020.150.180
19-28MM	10	43020.019.028	58-75MM	10	43020.058.075	175-205MM	5	43020.175.205
22-32MM	10	43020.022.032	68-85MM	10	43020.068.085	200-231MM	5	43020.200.231
26-38MM	10	43020.026.038	77-95MM	10	43020.077.095	226-256MM	5	43020.226.256
32-44MM	10	43020.032.044	87-112MM	5	43020.087.112	251-282MM	3	43020.251.282
38-50MM	10	43020.038.050	104-138MM	5	43020.104.138	277-307MM	3	43020.277.307
44-56MM	10	43020.044.056	130-165MM	5	43020.130.165			

Hose clamp A4



Technical Data

Type	C	D	S	Tightening torque (Nm)
8-14	13	9	1	2.5-3.5
11-17	19	9	1	2.5-3.5
13-20	19	9	1	2.5-3.5
15-24	19	12	1	2.5-3.5
19-28	19	12	1	2.5-3.5
22-32	19	12	1	2.5-3.5
26-38	19	12	1	3.5-4.5
32-44	19	12	1	3.5-4.5
38-50	19	12	1	3.5-4.5
44-56	19	12	1	5-6
50-65	19	12	1	5-6
58-75	19	12	1	5-6
68-85	19	12	1	5-6
77-95	19	12	1	5-6
87-112	19	12	1	5-6
104-138	19	12	1	5-6
130-165	19	12	1	5-6
150-180	19	12	1	5-6
175-205	19	12	1	5-6
200-231	19	12	1	5-6
226-256	19	12	1	5-6
251-282	19	12	1	5-6
277-307	19	12	1	5-6

- The type number displays the minimum and maximum grip range.

43019	AWAB Hose clamp	Y03A
Material	Stainless steel A4	

Grip range	☒	Art.number	Grip range	☒	Art.number	Grip range	☒	Art.number
8-14MM D= 9MM	10	43019.008.014	38-50MM D=12MM	10	43019.038.050	130-165MM D=12MM	5	43019.130.165
11-17MM D= 9MM	10	43019.011.017	44-56MM D=12MM	10	43019.044.056	150-180MM D=12MM	5	43019.150.181
13-20MM D= 9MM	10	43019.013.020	50-65MM D=12MM	10	43019.050.065	175-205MM D=12MM	5	43019.180.206
15-24MM D=12MM	10	43019.015.024	58-75MM D=12MM	10	43019.058.075	200-231MM D=12MM	5	43019.205.232
19-28MM D=12MM	10	43019.019.028	68-85MM D=12MM	10	43019.068.085	226-256MM D=12MM	5	43019.231.257
22-32MM D=12MM	10	43019.022.032	77-95MM D=12MM	10	43019.077.095	251-282MM D=12MM	3	43019.256.283
26-38MM D=12MM	10	43019.026.038	87-112MM D=12MM	5	43019.087.112	277-307MM D=12MM	3	43019.282.308
32-44MM D=12MM	10	43019.032.044	104-138MM D=12MM	5	43019.104.138			

Hose clamp Mini

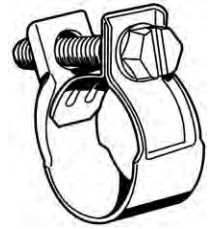
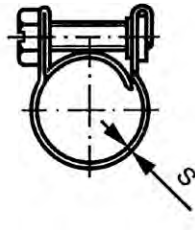

Technical Data

Type	D	Grip range (max.)	Grip range (min.)	S	Tightening torque (Nm)
6	8.4	6	5	0.5	0.4
8	9	8	7	0.5	0.4
9	10	9	7.5	0.5	1
9.5-10	10	10	9.5	0.5	1
10-11	10	11	10	0.5	1
12-13	10	13	12	0.5	1
13-14	10	14	13	0.5	1
14-15	10	15	14	0.5	1
15-17	10	17	15	0.5	1

30667 MAXXFAST Hose clamp Mini

MF6A

Material Steel
Surface treatment Zinc plated

MAXXFAST
PROFESSIONAL HARDWARE



Type	☒	Art.number	Type	☒	Art.number	Type	☒	Art.number
6	10	30667.006.001	9,5-10	10	30667.009.010	13-14	10	30667.013.014
8	10	30667.008.001	10-11	10	30667.010.011	14-15	10	30667.014.015
9	10	30667.009.001	12-13	10	30667.012.013	15-17	10	30667.015.017

- The corresponding hexagon nuts have a property class \geq I4I.

Hose clamp Mini

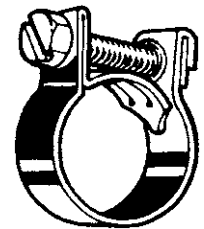
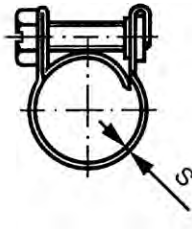
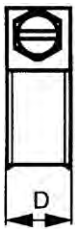

Technical Data

No.	D	Grip range (max.)	Grip range (min.)	S	Tightening torque (Nm)
No.8	9	8.5	7	0.5	1.5
No.9	9	9.5	8	0.5	1.5
No.10	9	10.5	9	0.5	1.5
No.11	9	11.5	9.5	0.5	1.5
No.12	9	12.5	10.5	0.5	1.5
No.13	9	13.5	11.5	0.5	1.5
No.14	9	14.5	12.5	0.5	1.5
No.15	9	15.5	13.5	0.5	1.5
No.16	9	16.5	14	0.5	1.5
No.17	9	17.5	15	0.5	1.5

- ABA MINI hose clamps: sure seal of small thin-walled hoses, easy to assemble and with a fixed nut.

Article groups

Material	Surface treatment	Code	Page
St	Zipl	43063	12-13
St.St. A2		43062	12-13

43063 ABA MINI Hose clamp Y03A

Material: Steel
Surface treatment: Zinc plated

ABA

No.	☒	Art.number	No.	☒	Art.number	No.	☒	Art.number
No.8	25	43063.000.008	No.12	25	43063.000.012	No.15	25	43063.000.015
No.9	25	43063.000.009	No.13	25	43063.000.013	No.16	25	43063.000.016
No.10	25	43063.000.010	No.14	25	43063.000.014	No.17	25	43063.000.017
No.11	25	43063.000.011						

43062 ABA MINI Hose clamp Y03A

Material: Stainless steel A2

ABA

No.	☒	Art.number	No.	☒	Art.number	No.	☒	Art.number
No.8	25	43062.000.008	No.12	25	43062.000.012	No.15	25	43062.000.015
No.9	25	43062.000.009	No.13	25	43062.000.013	No.16	25	43062.000.016
No.10	25	43062.000.010	No.14	25	43062.000.014	No.17	25	43062.000.017
No.11	25	43062.000.011						

Heavy duty hose clamp

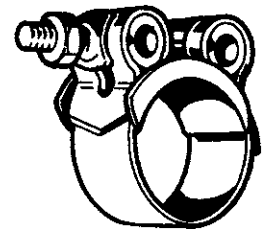
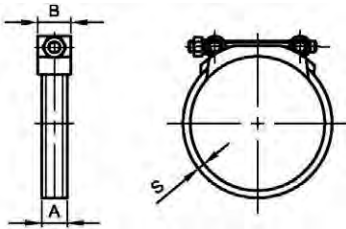

Technical Data

Type	A	B	S	Type	A	B	S
29-31	18	19.8	0.6	92-97	25	26.5	1.2
32-35	20	19.8	1	98-103	25	26.5	1.2
36-39	20	22	1	104-112	25	26.5	1.2
40-43	20	22	1	113-121	25	26.5	1.2
44-47	20	24.5	1	122-130	25	26.5	1.2
48-51	20	24.5	1	131-139	25	29	1.2
52-55	20	24.5	1	140-148	25	29	1.2
56-59	20	24.5	1	149-161	25	29	1.5
60-63	20	24.5	1	162-174	25	29	1.5
64-67	25	24.5	1	175-187	25	29	1.5
68-73	25	26.5	1	188-200	25	29	1.5
74-79	25	26.5	1	201-213	25	29	1.5
80-85	25	26.5	1.2	214-226	25	29	1.5
86-91	25	26.5	1.2				

- ABA ROBUST is a heavy-duty hose clamp with rolled-up band edges. It is used primarily for tightening heavy-gauge reinforced hoses.
- The type number displays the minimum and maximum grip range.

Assembly data



43024 ABA ROBUST Hose clamp

Y03A

Material Stainless steel A4

ABA

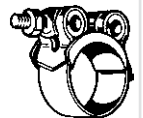

Grip range	☒	Art.number	Grip range	☒	Art.number	Grip range	☒	Art.number
29-31MM	10	43024.029.031	64-67MM	10	43024.064.067	122-130MM	5	43024.122.130
32-35MM	10	43024.032.035	68-73MM	10	43024.068.073	131-139MM	5	43024.131.139
36-39MM	10	43024.036.039	74-79MM	10	43024.074.079	140-148MM	3	43024.140.148
40-43MM	10	43024.040.043	80-85MM	10	43024.080.085	149-161MM	3	43024.149.161
44-47MM	10	43024.044.047	86-91MM	5	43024.086.091	162-174MM	3	43024.162.174
48-51MM	10	43024.048.051	92-97MM	5	43024.092.097	175-187MM	3	43024.175.187
52-55MM	10	43024.052.055	98-103MM	5	43024.098.103	188-200MM	3	43024.188.200
56-59MM	10	43024.056.059	104-112MM	5	43024.104.112	201-213MM	3	43024.201.213
60-63MM	10	43024.060.063	113-121MM	5	43024.113.121	214-226MM	3	43024.214.226

Heavy duty hose clamp

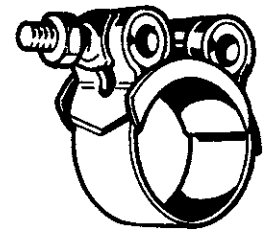
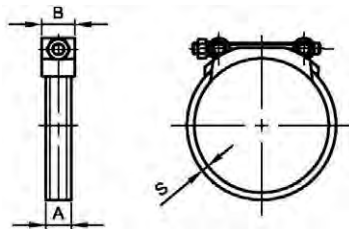

Technical Data

Type	A	B	S	Type	A	B	S
29-31	18	20	0.6	104-111	20	22.1	0.8
31-34	18	20	0.6	111-118	20	22.1	0.8
34-37	18	20	0.6	118-125	20	22.1	0.8
37-40	18	20	0.6	125-132	20	22.1	0.8
40-43	18	20	0.6	132-139	20	22.1	0.8
43-47	20	22.1	0.8	139-146	20	22.1	0.8
47-51	20	22.1	0.8	146-153	20	22.1	0.8
51-55	20	22.1	0.8	153-160	20	22.1	0.8
55-59	20	22.1	0.8	160-167	20	22.1	0.8
59-63	20	22.1	0.8	167-174	20	22.1	0.8
63-68	20	22.1	0.8	174-187	30	32.5	1.25
68-73	20	22.1	0.8	187-200	30	32.5	1.25
73-79	20	22.1	0.8	200-213	30	32.5	1.25
79-85	20	22.1	0.8	213-226	30	32.5	1.25
85-91	20	22.1	0.8	226-239	30	32.5	1.25
91-97	20	22.1	0.8	239-252	30	32.5	1.25
97-104	20	22.1	0.8				

- ABA ROBUST is a heavy-duty hose clamp with rolled-up band edges. It is used primarily for tightening heavy-gauge reinforced hoses.
- The type number displays the minimum and maximum grip range.

Assembly data



43033	ABA Hose clamp Robust	Y03A
Material	Stainless steel AISI 430	

Type	☒	Art.number	Type	☒	Art.number	Type	☒	Art.number
29-31	25	43033.029.031	68-73	25	43033.068.073	139-146	5	43033.139.146
31-34	25	43033.031.034	73-79	25	43033.073.079	146-153	5	43033.146.153
34-37	25	43033.034.037	79-85	25	43033.079.085	153-160	5	43033.153.160
37-40	25	43033.037.040	85-91	10	43033.085.091	160-167	5	43033.160.167
40-43	25	43033.040.043	91-97	10	43033.091.097	167-174	5	43033.167.174
43-47	25	43033.043.047	97-104	10	43033.097.104	174-187	5	43033.174.187
47-51	25	43033.047.051	104-111	10	43033.104.111	187-200	5	43033.187.200
51-55	25	43033.051.055	111-118	10	43033.111.118	200-213	5	43033.200.213
55-59	25	43033.055.059	118-125	10	43033.118.125	213-226	5	43033.213.226
59-63	25	43033.059.063	125-132	5	43033.125.132	226-239	5	43033.226.239
63-68	25	43033.063.068	132-139	5	43033.132.139	239-252	5	43033.239.252

- Material type: band and bridging piece AISI 430 / screw and bolt steel zinc plated.
- Up to type 40-43 with hexagonal bolt M6x40, w.a.f. 8mm.
- Type 43-47 up to type 167-174 with hex socket screw M7x55, w.a.f. 5mm.
- Type 174-187 up to type 239-252 with hexagonal bolt M10x80, w.a.f. 17mm.

Hose clamp Micro

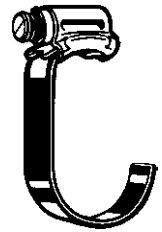
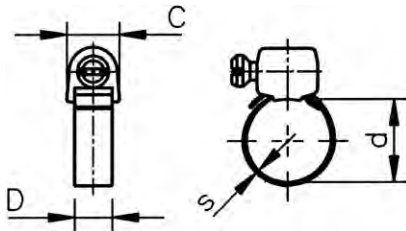

Technical Data

Type	C	D	s	Tightening torque (Nm)
6-11	7.5	5	0.4	0.5-0.7
7-11	9	5.5	0.5	0.5-0.7

- Material band stainless steel.
- The type number displays the minimum and maximum grip range.

43065 ABA MICRO Hose clamp

Y03A

Material Steel
Surface treatment Zinc plated

ABA



Grip range	Art.number
7-11MM	25 43065.007.011

One-ear clip

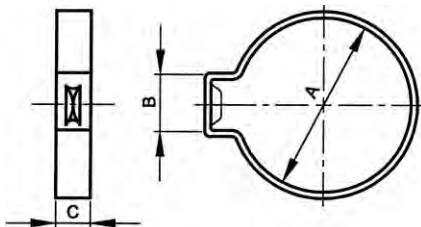

Technical Data

Type	A	B	C
10-12	12.3	7	6.5
12-14	14	7	6.5
14-16	16.5	8.5	7
16-18	18.5	9.5	7

- Can be installed easily and quickly with pincer or ear clip plier.
- The typenumber amounts of the minimum and maximum grip range.

43074 ABA One-ear clip

Y03A

Material Steel
Surface treatment Galvanized thick Cr³⁺ passivated

ABA



Grip range	Art.number	Grip range	Art.number	Grip range	Art.number
10-12MM	50 43074.010.012	14-16MM	50 43074.014.016	16-18MM	50 43074.016.018
12-14MM	50 43074.012.014				

Two-ear clip

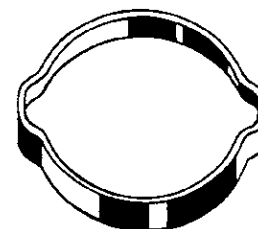
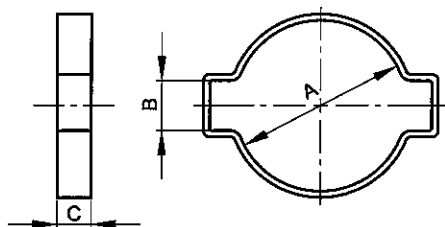

Technical Data

Type	A	B	C	Type	A	B	C
5-7	7.3	4.3	6	22-25	25.5	9.1	8.5
7-9	9.3	4.8	6	25-28	28.5	10	9
9-11	11.3	5.3	6.5	28-31	31.5	11	9.5
11-13	13.3	5.8	6.5	31-34	34.5	11	9.5
13-15	15.3	6.3	7	34-37	37.5	11.5	9.5
15-18	18.5	7	7.5	37-40	40.5	12	10
17-20	20.5	7.6	7.5	40-43	43.3	8.5	10
20-23	23.5	8.5	8	43-46	46.3	8.5	10

- Can be installed easily and quickly with pincer or ear clip plier.
- The typenumber amounts of the minimum and maximum grip range.

43076 ABA Two-ear clip

Y03A

Material Steel
Surface treatment Galvanized thick Cr³⁺ passivated

ABA

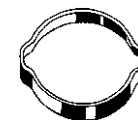

Grip range	☒	Art.number	Grip range	☒	Art.number	Grip range	☒	Art.number
5-7MM	50	43076.005.007	17-20MM	50	43076.017.020	34-37MM	50	43076.034.037
7-9MM	50	43076.007.009	20-23MM	50	43076.020.023	37-40MM	50	43076.037.040
9-11MM	50	43076.009.011	22-25MM	50	43076.022.025	40-43MM	50	43076.040.043
11-13MM	50	43076.011.013	25-28MM	50	43076.025.028	43-46MM	50	43076.043.046
13-15MM	50	43076.013.015	28-31MM	50	43076.028.031			
15-18MM	50	43076.015.018	31-34MM	50	43076.031.034			

Hose clamp two parts

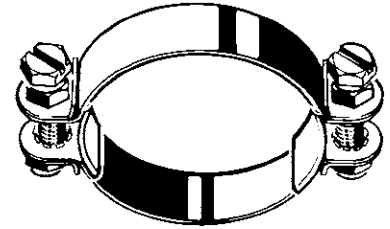
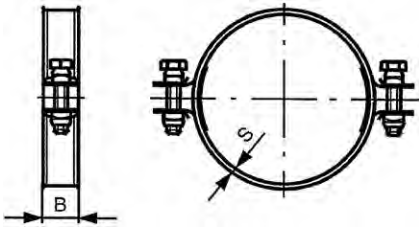

Technical Data

Type	B	S	Type	B	S
33-39	20	1	106-116	25	1.25
37-43	20	1	112-122	25	1.25
43-49	20	1	118-128	25	1.25
49-55	20	1	126-136	25	1.25
55-63	20	1	136-146	25	1.25
61-69	20	1	156-166	25	1.25
67-75	20	1	166-176	25	1.25
73-81	20	1	176-186	25	1.25
79-87	20	1	186-196	25	1.25
85-93	20	1	196-206	25	1.25
89-97	20	1	208-218	25	1.25
95-103	20	1	218-228	25	1.25
97-105	20	1	228-238	25	1.25
96-106	25	1.25	238-248	25	1.25
102-112	25	1.25	146-156	25	1.25

- Band steel heavy zinc plated with a layer thickness of min. 18µm.
- The type number displays the minimum and maximum grip range.

Article groups

Material	Surface treatment		Code	Page
St	Zipl	B=20	43025	12-18
St	Zipl	B=25	43026	12-18

43025 Hose clamp two parts Y03A

Material: Steel
Surface treatment: Zinc plated

Type	☒	Art.number	Type	☒	Art.number	Type	☒	Art.number
33-39MM	5	43025.033.039	61-69MM	5	43025.061.069	85-93MM	5	43025.085.093
37-43MM	5	43025.037.043	67-75MM	5	43025.067.075	89-97MM	5	43025.089.097
43-49MM	5	43025.043.049	73-81MM	5	43025.073.081	95-103MM	5	43025.095.103
49-55MM	5	43025.049.055	79-87MM	5	43025.079.087	97-105MM	5	43025.097.105
55-63MM	5	43025.055.063						

43026 Hose clamp two parts Y03A

Material: Steel
Surface treatment: Zinc plated

Type	☒	Art.number	Type	☒	Art.number	Type	☒	Art.number
96-106MM	2	43026.096.106	136-146MM	2	43026.136.146	196-206MM	1	43026.196.206
102-112MM	2	43026.102.112	146-156MM	2	43026.146.156	208-218MM	1	43026.208.218
106-116MM	2	43026.106.116	156-166MM	2	43026.156.166	218-228MM	1	43026.218.228
112-122MM	2	43026.112.122	166-176MM	2	43026.166.176	228-238MM	1	43026.228.238
118-128MM	2	43026.118.128	176-186MM	1	43026.176.186	238-248MM	1	43026.238.248
126-136MM	2	43026.126.136	186-196MM	1	43026.186.196			

Rubber lined clip

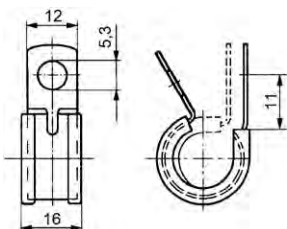

Technical Data

Type	d	D	Pipe ø	Type	d	D	Pipe ø
5	5.3	12	5	19	5.3	12	19
6	5.3	12	6	20	5.3	12	20
8	5.3	12	8	21	5.3	12	21
10	5.3	12	10	22	5.3	12	22
12	5.3	12	12	23	5.3	12	23
13	5.3	12	13	24	5.3	12	24
14	5.3	12	14	25	5.3	12	25
15	5.3	12	15	26	5.3	12	26
16	5.3	12	16	27	5.3	12	27
17	5.3	12	17	28	5.3	12	28
18	5.3	12	18				

30666 MAXXFAST Rubber lined clip

MF6A

Material Steel
Surface treatment Zinc plated

MAXXFAST
PROFESSIONAL HARDWARE



Type / D	☒	Art.number	Type / D	☒	Art.number	Type / D	☒	Art.number
5/12	10	30666.050.012	15/12	10	30666.150.012	22/12	10	30666.220.012
6/12	10	30666.060.012	16/12	10	30666.160.012	23/12	10	30666.230.012
8/12	10	30666.080.012	17/12	10	30666.170.012	24/12	10	30666.240.012
10/12	10	30666.100.012	18/12	10	30666.180.012	25/12	10	30666.250.012
12/12	10	30666.120.012	19/12	10	30666.190.012	26/12	10	30666.260.012
13/12	10	30666.130.012	20/12	10	30666.200.012	27/12	10	30666.270.012
14/12	10	30666.140.012	21/12	10	30666.210.012	28/12	10	30666.280.012

- Full boxes only.

Rubber lined clip

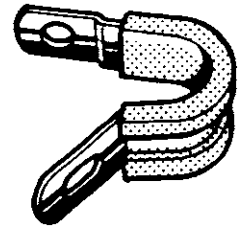
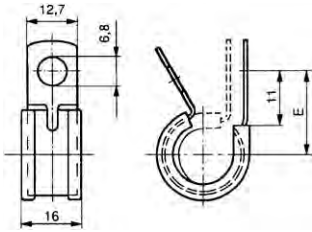

Technical Data

Type	E	Pipe ø	Type	E	Pipe ø
300	14.6	3	314	25.8	25
301	15.4	5	315	27.1	27
302	16.2	6	316	27.9	29
303	17	8	317	28.6	30
304	17.8	10	318	29.4	32
305	18.6	11	319	30.2	33
306	19.4	13	320	31	35
307	20.2	14	321	31.8	37
308	21	16	322	32.6	38
309	21.8	18	323	38	45
310	22.6	19	325	45.5	54
311	23.4	21	326	34	41
312	24.2	22	329	43.5	60
313	25	24			

- Special features of ABA rubber lined clips:
- With rubber (EPDM) profile
- High resistance to water, wear, temperature fluctuations and ageing
- Especially for vibration-damping suspension of pipes, cables, cable circuits and hoses etc.

Article groups

Material	Surface treatment	Code	Page
St	Hot d.g.	43111	12-20
St	Hot d.g.	large pack	12-20
St.St. A2		43115	12-21

43111 ABA Rubber lined clip Y03A

Material Steel
Surface treatment Hot dip galvanized



Type-pipe ø	Art.number	Type-pipe ø	Art.number	Type-pipe ø	Art.number
300-3MM	25 43111.000.300	305-11MM	25 43111.000.305	309-18MM	25 43111.000.309
301-5MM	25 43111.000.301	306-13MM	25 43111.000.306	310-19MM	25 43111.000.310
302-6MM	25 43111.000.302	307-14MM	25 43111.000.307	311-21MM	25 43111.000.311
303-8MM	25 43111.000.303	308-16MM	25 43111.000.308	312-22MM	25 43111.000.312
304-10MM	25 43111.000.304				

43110 ABA Rubber lined clip Y03A

Material Steel
Surface treatment Hot dip galvanized

Type-pipe ø	Art.number	Type-pipe ø	Art.number	Type-pipe ø	Art.number
300-3MM	100 43110.000.300	309-18MM	50 43110.000.309	318-32MM	50 43110.000.318
301-5MM	100 43110.000.301	310-19MM	50 43110.000.310	319-33MM	50 43110.000.319
302-6MM	100 43110.000.302	311-21MM	50 43110.000.311	320-35MM	50 43110.000.320
303-8MM	100 43110.000.303	312-22MM	50 43110.000.312	321-37MM	50 43110.000.321
304-10MM	100 43110.000.304	313-24MM	50 43110.000.313	322-38MM	50 43110.000.322
305-11MM	100 43110.000.305	314-25MM	50 43110.000.314	323-45MM	50 43110.000.323
306-13MM	100 43110.000.306	315-27MM	50 43110.000.315	325-54MM	50 43110.000.325
307-14MM	100 43110.000.307	316-29MM	50 43110.000.316	326-41MM	50 43110.000.326
308-16MM	100 43110.000.308	317-30MM	50 43110.000.317	329-60MM	50 43110.000.329

Assembly hole ø = 5,3MM



43115	Rubber lined clip	Y03A
Material	Stainless steel A2	
		  

Type-pipe ø	☒	Art.number	Type-pipe ø	☒	Art.number	Type-pipe ø	☒	Art.number
302-6MM	25	43115.000.006	307-14MM	25	43115.000.014	312-22MM	25	43115.000.023
303-8MM	25	43115.000.008	309-18MM	25	43115.000.018	314-25MM	25	43115.000.026
304-10MM	25	43115.000.010	311-21MM	25	43115.000.021	322-38MM	25	43115.000.040
306-13MM	25	43115.000.013						

Hose clamp assortment



Article groups	
Code	Page
30668	12-21
43055	12-22

30668	MAXXFAST Hose clamps rack	MFNA
		 

Size	☒	Art.number	
8-70 EMPTY	1	30668.000.005	
8-70 + Hoseclamp	1	30668.000.010	<ul style="list-style-type: none"> • Our exclusive MaxxFast hose clamps rack is fitted with the most used standard hose clamps and mini-clips and a specially designed tool. <p>Full rack content</p> <p>MaxxFast ZPL 9mm hose clamps:</p> <ul style="list-style-type: none"> • 8-16mm - 10pcs • 12-22mm - 10pcs • 16-27mm - 10pcs • 20-32mm - 10pcs • 25-40mm - 10pcs • 32-50mm - 10pcs • 40-60mm - 10pcs • 50-70mm - 10pcs <p>MaxxFast ZPL mini clips:</p> <ul style="list-style-type: none"> • 8mm - 10pcs • 9mm - 10pcs • 9,5-10mm - 10pcs • 10-11mm - 10pcs • 12-13mm - 10pcs • 13-14mm - 10pcs • 14-15mm - 10pcs • 15-17mm - 10pcs <ul style="list-style-type: none"> • MaxxFast hose clamps tool hex 7mm - 1pc • 2 wall plugs and 2 hooks for installation







Type	☒	Art.number	
244C	1	43055.001.803	<ul style="list-style-type: none"> • Display rack • Size: 65 x 15 x 23,4 cm • Contents: • 12 x 8-14/9 W1 • 12 x 11-17/9 W1 • 12 x 13-20/9 W1 • 24 x 15-24/12 W1 • 12 x 19-28/12 W1 • 12 x 22-32/12 W1 • 12 x 26-38/12 W1 • 12 x 32-44/12 W1 • 12 x 38-50/12 W1 • 12 x 44-56/12 W1 • 12 x 50-65/12 W1 • 10 x Mini 8 C • 10 x Mini 9 C • 10 x Mini 10 C • 10 x Mini 11 C • 10 x Mini 12 C • 10 x Mini 13 C • 10 x Mini 14 C • 10 x Mini 15 C • 10 x Mini 16 C • 10 x Mini 17 C • 1 ABA flexible socket screwdriver normal model 250 mm
270C	1	43055.001.805	<ul style="list-style-type: none"> • In plastic box • Size: 40 x 27 x 8,5 cm • Contents: • 50 x 8-14/9 W1 • 50 x 11-17/9 W1 • 50 x 13-20/9 W1 • 25 x 15-24/12 W1 • 25 x 19-28/12 W1 • 20 x 22-32/12 W1 • 15 x 26-38/12 W1 • 15 x 32-44/12 W1 • 10 x 38-50/12 W1 • 10 x 44-56/12 W1 • 1 ABA flexible socket screwdriver normal model 250 mm
ABA Display 244 empty	1	43055.790.244	

Flexible socket screwdriver





Article groups

Code	Page
30669	12-23
43030	12-23

30669	MAXXFAST Hose clamps tool	MT2A
 		

Size	Art.number
7 MM	30669.000.100

- Flexible screwdriver with 7mm hex drive for MaxxFast hose clamps.
- Compatible with Euro standard hose clamps.
- High grip ergonomic bi-material handle for comfort and high torque transmission.
- Flexible axial shaft for easy installation or removal even in tight areas.
- Thin wall socket designed for standard hose clamps (S=7mm).

43030	ABA Flexible socket screwdriver	Y95A
 		

Type	Art.number		
Flex	43030.001.770	• Normal model	
Flex long	43030.001.780	Long model 600 mm	

- For areas where access is difficult
- Provided with a 7 mm hexagon socket, cannot slip out
- Bendable to 90°
- Usable for all types of ABA and AWAB hose clamps

Exhaust pipe clamp

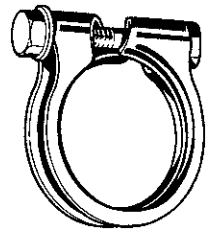
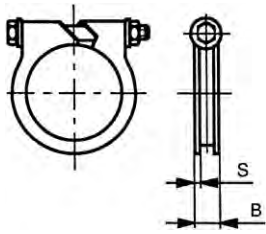

Technical Data

Type	B	Grip range (max.)	Grip range (min.)	S	Tightening torque (Nm)
R27-1.5	11.5	27	24	1.5	8-10
R30-1.5	11.5	30	27	1.5	8-10
R33-1.5	11.5	33	30	1.5	8-10
R42-2	11.5	42	39	2.0	8-10
R45-2.5	11.5	45	42	2.5	8-10
R48-2.5	12.5	48	45	2.5	10-15
R51-2.5	12.5	51	48	2.5	10-15
R55-2.5	12.5	55	52	2.5	10-15
R58-2.5	12.5	58	55	2.5	10-15

Assembly data

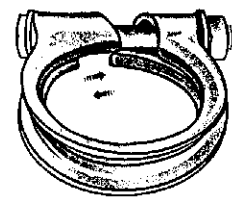
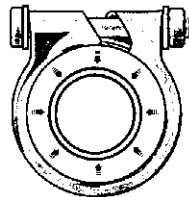

43246 AWAB Exhaust pipe clamp

Y03A

Material Steel

ABA



Type	☒	Art.number	Type	☒	Art.number	Type	☒	Art.number
R27-1,5MM	10	43246.270.001	R42-2MM	10	43246.420.001	R51-2,5MM	10	43246.510.001
R30-1,5MM	10	43246.300.001	R45-2,5MM	10	43246.450.001	R55-2,5MM	10	43246.550.001
R33-1,5MM	10	43246.330.001	R48-2,5MM	10	43246.480.001	R58-2,5MM	10	43246.580.001

Exhaust pipe clamp M8

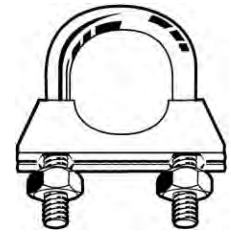
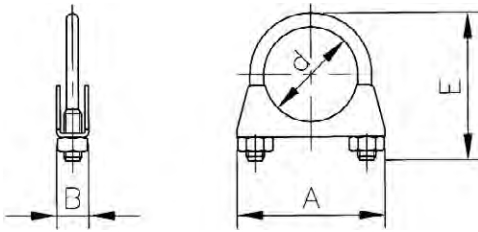

Technical Data

For nom.size d	A	B	E	For nom.size d	A	B	E
25	50	14.5	52	50	84	13.5	77
26	55	13.5	57	51	76	14.5	76
28	54.5	13.5	56	52	53.5	13.5	77
32	59.5	13.5	59	54	88	13.5	78
35	60	14.5	63	57	82.5	14.5	83
36	63	13.5	68	58	91	13.5	85
38	67	13.5	62	60	94	13.5	84.5
42	72	13.5	68.5	65	99	13.5	89
45	75	13.5	70	70	107	13.5	94
48	79.5	13.5	74	75	115	13.5	102

43241 Exhaust pipe clamp M8

Y03A

Material Steel
Surface treatment Zinc plated



For nom. size d	☒	Art.number	For nom. size d	☒	Art.number	For nom. size d	☒	Art.number
26MM	10	43241.260.001	45MM	10	43241.450.001	60MM	10	43241.600.001
28MM	10	43241.280.001	48MM	10	43241.480.001	64/65MM	10	43241.650.001
32MM	10	43241.320.001	50MM	10	43241.500.001	70MM	10	43241.700.001
36MM	10	43241.360.001	51/52MM	10	43241.520.001	75/76MM	10	43241.750.001
38MM	10	43241.380.001	54MM	10	43241.540.001			
42MM	10	43241.420.001	58MM	10	43241.580.001			

- Depending on availability the dimensions may deviate.

Clamping system



		Width		Thickness mm	Average breaking strength Lbs	Ear-Lokt 	Clip 	Scru-Lok 	J-020 	C-001
		IN	mm							
						43272.380.xxx	43273.380.xxx	43274.380.xxx	43276.385.041	43276.380.001
43270.380.201		1/4	6.35	0.51	500	211			X	X
43270.380.202		3/8	9.52	0.64	900	212	322	451	X	X
43270.380.203		1/2	12.70	0.76	1500	213	323	452		X
43270.380.204		5/8	15.87	0.76	1875	214	324	453		X
43270.380.205		3/4	19.05	0.76	2250	215	325	454		X
43280.000.203		3/8	9.52	0.64	900	212	322	451	X	X
43280.000.204		1/2	12.70	0.76	1500	213	323	452		X
43280.000.205		5/8	15.87	0.76	1875	214	324	453		X
43280.000.206		3/4	19.05	0.76	2250	215	325	454		X
43271.380.302		3/8	9.52	0.38	450	212	322	451	X	X
43271.380.303		1/2	12.70	0.38	600	213	323	452		X
43271.380.304		5/8	15.87	0.38	750	214	324	453		X
43271.380.305		3/4	19.05	0.38	900	215	325	454		X

Article groups

Material	Code	Page
St.St. Band type 201	43270	12-26
St.St. Band type 201 with dispenser	43280	12-26
St.St. Buckle Ear-Lokt	43272	12-27
St.St. Valu-strap band	43271	12-27
St.St. Valuclips for valu-strap	43273	12-27
St.St. Scru-Lokt buckle	43274	12-27
St.St. Brack-its	43279	12-27
St.St. Band clamping	43275	12-28
Tools	43276	12-28

43270 Band type 201 Y63A

Material	Stainless steel		

Type	Art.number	Type	Art.number	Type	Art.number
C-202 1/4-30,5M-0,51MM	1 43270.380.201	C-204 1/2-30,5M-0,76MM	1 43270.380.203	C-206 3/4-30,5M-0,76MM	1 43270.380.205
C-203 3/8-30,5M-0,64MM	1 43270.380.202	C-205 5/8-30,5M-0,76MM	1 43270.380.204		

43280 Band type 201 with dispenser Y63A

Material	Stainless steel		

Type	Art.number	Type	Art.number	Type	Art.number
C203Y 3/8-30,5M-0,64MM	1 43280.000.203	C205G 5/8-30,5M-0,76MM	1 43280.000.205	C206R 3/4-30,5M-0,76MM	1 43280.000.206
C204B 1/2-30,5M-0,76MM	1 43280.000.204				

43272	Buckle Ear-Lokt	Y63A
Material	Stainless steel	BAND-IT®
		
		

Type	☒	Art.number	Type	☒	Art.number	Type	☒	Art.number
C-252 1/4-0,38MM	100	43272.380.211	C-254 1/2-0,38MM	100	43272.380.213	C-256 3/4-0,38MM	100	43272.380.215
C-253 3/8-0,38MM	100	43272.380.212	C-255 5/8-0,38MM	100	43272.380.214			

43271	Valu-strap band	Y63A
Material	Stainless steel	BAND-IT®
		
		

Type	☒	Art.number	Type	☒	Art.number	Type	☒	Art.number
C-133 3/8-30,5M-0,38MM	1	43271.380.302	C-135 5/8-30,5M-0,38MM	1	43271.380.304	C-136 3/4-30,5M-0,38MM	1	43271.380.305
C-134 1/2-30,5M-0,38MM	1	43271.380.303						

43273	Valuclips for Valu-Strap band	Y63A
Material	Stainless steel	BAND-IT®
		
		

Type	☒	Art.number	Type	☒	Art.number	Type	☒	Art.number
C-153 3/8	100	43273.380.322	C-155 5/8	100	43273.380.324	C-156 3/4	100	43273.380.325
C-154 1/2	100	43273.380.323						



43274	Scru-Lokt buckle	Y63A
Material	Stainless steel	BAND-IT®
		
		



Type	☒	Art.number	Type	☒	Art.number	Type	☒	Art.number
C-720 1/4	50	43274.380.451	C-724 1/2	25	43274.380.453	C-726 3/4	25	43274.380.454
C-722 3/8	50	43274.380.452						



• For band type 201 and Valu-Strap band.



43279	Brack-its	Y63A
Material	Stainless steel	BAND-IT®
		
		

Type	☒	Art.number	
D-007 BR-IT Lmount	50	43279.007.001	<ul style="list-style-type: none"> • L-mount right angle. • For 6mm screws.
D-008 BR-IT 2Bolt	50	43279.008.001	<ul style="list-style-type: none"> • 2 Bolts • Straight legs.





43279		Brack-its					
Type	☒	Art.number					
D-001 1-BT Straight	50	43279.380.484	• Single Bolt. • Straight legs.				
D-021 1-BT Flared	50	43279.380.485	• Single bolt. • Flared legs.				

43275		Band clamping				Y63A	
Material	Stainless steel					BAND-IT®	
							
							

Type	☒	Art.number					
M-158 Scru-Band Pack	1	43275.153.001	• 3,5m Scru-Band (9,5mm wide - Stainless Steel). • 5 Housings. • 5 Slotted screws.				
M-211 SEAL KLMM	10	43275.380.471	• 10 Screw-Seal racks. • 10 Housings. • Works with C-133 (43271.380.302) and C-134 (43271.380.303) Valu-Strap band.				
M-210 SEAL BND	1	43275.380.473	• 30,5m Valu-Strap band 3/8" (9,53mm). • 25 Screw-Seal racks. • 25 Housings.				

43276		Tools				Y63A	
						BAND-IT®	
							
							

Type	☒	Art.number					
380001 C-001	1	43276.380.001	• TOOL TYPE C-001: for bands from 3/16" to 3/4"				
J-020 POKKITII	1	43276.385.041	• TOOL TYPE J-020 Pok-it II: for bands from 3/16" to 3/8"				

U-bolt type A

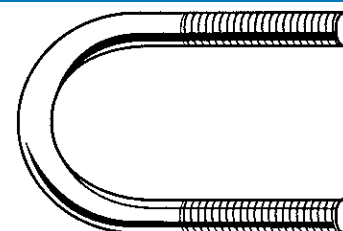
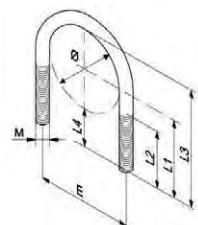

Technical Data



M x L ₃	d	E	L ₁	L ₂	L ₄
M5x37	22	25	26	21	15
M6x33	18	28	24	18	15
M6x37	22	29	26	20	15
M6x42	27	31	29	22	15
M6x49	34	34	32	26	15
M6x62	42	36	41	27	20
M6x68	48	38	44	27	20
M6x85	60	41	55	32	25
M6x101	76	43	63	32	25
M6x114	89	45	70	32	25
M6x144	114	50	87	37	30
M8x37	22	52	26	18	15
M8x42	27	54	29	20	15
M8x49	34	56	32	24	15
M8x62	42	58	41	29	20
M8x68	48	60	44	29	20
M8x85	60	69	55	34	25
M8x101	76	71	63	34	25
M8x114	89	73	70	34	25
M8x132	102	75	81	39	30
M8x144	114	85	87	39	30
M8x170	140	87	100	39	30
M10x42	27	89	29	18	15
M10x49	34	91	32	22	15
M10x62	42	98	41	31	20
M10x68	48	100	44	31	20
M10x85	60	102	55	36	25
M10x101	76	104	63	36	25
M10x114	89	113	70	36	25
M10x132	102	115	81	41	30
M10x144	114	117	87	41	30
M10x170	140	123	100	41	30
M10x203	168	125	119	46	35
M10x259	219	127	150	51	40
M12x85	60	129	55	38	25
M12x101	76	133	63	38	25
M12x114	89	152	70	38	25
M12x132	102	154	81	43	30
M12x144	114	156	87	43	30
M12x170	140	160	100	43	30
M12x203	168	182	119	48	35
M12x259	219	184	150	53	40
M12x313	273	188	177	53	40
M12x364	324	218	202	53	40
M16x144	114	233	87	48	30
M16x170	140	235	100	48	30
M16x203	168	239	119	53	35
M16x259	219	243	150	58	40
M16x313	273	289	177	58	40
M16x364	324	293	202	58	40
M20x234	194	297	137	62	40
M20x259	219	341	150	62	40
M20x313	273	345	177	62	40
M20x364	324	349	202	62	40
M24x364	324	353	202	66	40

Article groups

Thread	Material	Surface treatment	Code	Page
M	St	Zipl	17260	12-30
M	St.St. A2		17261	12-30
M	St.St. A4		17262	12-30

17260 U-bolt type A		F11B
Thread	Metric thread	
Material	Steel	
Surface treatment	Zinc plated	
		

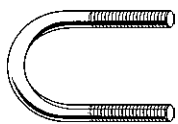
M x L ₃	Art.number	M x L ₃	Art.number	M x L ₃	Art.number
M5x37	17260.050.028	M8x132	17260.080.113	M12x132	17260.120.117
M6x33	17260.060.025	M8x144	17260.080.125	M12x144	17260.120.129
M6x37	17260.060.029	M8x170	17260.080.152	M12x170	17260.120.156
M6x42	17260.060.034	M10x42	17260.100.038	M12x203	17260.120.184
M6x49	17260.060.041	M10x49	17260.100.045	M12x259	17260.120.235
M6x62	17260.060.050	M10x62	17260.100.054	M12x313	17260.120.289
M6x68	17260.060.056	M10x68	17260.100.060	M12x364	17260.120.341
M6x85	17260.060.069	M10x85	17260.100.073	M16x144	17260.160.133
M6x101	17260.060.085	M10x101	17260.100.089	M16x170	17260.160.160
M6x114	17260.060.098	M10x114	17260.100.102	M16x203	17260.160.188
M6x144	17260.060.123	M10x132	17260.100.115	M16x259	17260.160.239
M8x37	17260.080.031	M10x144	17260.100.127	M16x313	17260.160.293
M8x42	17260.080.036	M10x170	17260.100.154	M16x364	17260.160.345
M8x49	17260.080.043	M10x203	17260.100.182	M20x234	17260.200.218
M8x62	17260.080.052	M10x259	17260.100.233	M20x259	17260.200.243
M8x68	17260.080.058	M12x85	17260.120.075	M20x313	17260.200.297
M8x85	17260.080.071	M12x101	17260.120.091	M20x364	17260.200.349
M8x101	17260.080.087	M12x114	17260.120.104	M24x364	17260.240.353
M8x114	17260.080.100				

17261 U-bolt type A		F11C
Thread	Metric thread	
Material	Stainless steel A2	
		

M x L ₃	Art.number	M x L ₃	Art.number	M x L ₃	Art.number
M5x37	17261.050.028	M8x132	17261.080.113	M12x132	17261.120.117
M6x33	17261.060.025	M8x144	17261.080.125	M12x144	17261.120.129
M6x37	17261.060.029	M8x170	17261.080.152	M12x170	17261.120.156
M6x42	17261.060.034	M10x42	17261.100.038	M12x203	17261.120.184
M6x49	17261.060.041	M10x49	17261.100.045	M12x259	17261.120.235
M6x62	17261.060.050	M10x62	17261.100.054	M12x313	17261.120.289
M6x68	17261.060.056	M10x68	17261.100.060	M12x364	17261.120.341
M6x85	17261.060.069	M10x85	17261.100.073	M16x144	17261.160.133
M6x101	17261.060.085	M10x101	17261.100.089	M16x170	17261.160.160
M6x114	17261.060.098	M10x114	17261.100.102	M16x203	17261.160.188
M6x144	17261.060.123	M10x132	17261.100.115	M16x259	17261.160.239
M8x37	17261.080.031	M10x144	17261.100.127	M16x313	17261.160.293
M8x42	17261.080.036	M10x170	17261.100.154	M16x364	17261.160.345
M8x49	17261.080.043	M10x203	17261.100.182	M20x234	17261.200.218
M8x62	17261.080.052	M10x259	17261.100.233	M20x259	17261.200.243
M8x68	17261.080.058	M12x85	17261.120.075	M20x313	17261.200.297
M8x85	17261.080.071	M12x101	17261.120.091	M20x364	17261.200.349
M8x101	17261.080.087	M12x114	17261.120.104	M24x364	17261.240.353
M8x114	17261.080.100				

17262 U-bolt type A		F11C
Thread	Metric thread	
Material	Stainless steel A4	
		

M x L ₃	Art.number	M x L ₃	Art.number	M x L ₃	Art.number
M5x37	17262.050.028	M6x62	17262.060.050	M6x144	17262.060.123
M6x33	17262.060.025	M6x68	17262.060.056	M8x37	17262.080.031
M6x37	17262.060.029	M6x85	17262.060.069	M8x42	17262.080.036
M6x42	17262.060.034	M6x101	17262.060.085	M8x49	17262.080.043
M6x49	17262.060.041	M6x114	17262.060.098	M8x62	17262.080.052

17262 U-bolt type A								
M x L ₃	☒	Art.number	M x L ₃	☒	Art.number	M x L ₃	☒	Art.number
M8x68	1	17262.080.058	M10x132	1	17262.100.115	M12x364	1	17262.120.341
M8x85	1	17262.080.071	M10x144	1	17262.100.127	M16x144	1	17262.160.133
M8x101	1	17262.080.087	M10x170	1	17262.100.154	M16x170	1	17262.160.160
M8x114	1	17262.080.100	M10x203	1	17262.100.182	M16x203	1	17262.160.188
M8x132	1	17262.080.113	M10x259	1	17262.100.233	M16x259	1	17262.160.239
M8x144	1	17262.080.125	M12x85	1	17262.120.075	M16x313	1	17262.160.293
M8x170	1	17262.080.152	M12x101	1	17262.120.091	M16x364	1	17262.160.345
M10x42	1	17262.100.038	M12x114	1	17262.120.104	M20x234	1	17262.200.218
M10x49	1	17262.100.045	M12x132	1	17262.120.117	M20x259	1	17262.200.243
M10x62	1	17262.100.054	M12x144	1	17262.120.129	M20x313	1	17262.200.297
M10x68	1	17262.100.060	M12x170	1	17262.120.156	M20x364	1	17262.200.349
M10x85	1	17262.100.073	M12x203	1	17262.120.184	M24x364	1	17262.240.353
M10x101	1	17262.100.089	M12x259	1	17262.120.235			
M10x114	1	17262.100.102	M12x313	1	17262.120.289			

U-bolt type B

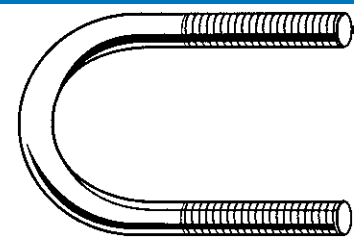
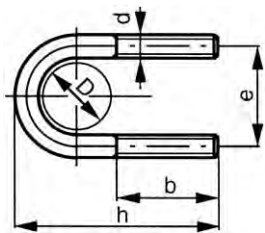

Technical Data				
d x h	b	D (nom. inch)	D (nom. mm)	e
M6x42	20	1/2	22	29
M6x53	25	3/4	27	34
M6x61	30	1 Inch	34	41
M8x42	20	1/2	22	29
M8x61	30	1 Inch	34	44
M8x65	25	1 Inch	35	48
M8x71	30	3/4	27	36
M8x74	35	1.1/4	42	52
M8x85	40	1.1/2	48	57
M8x99	40	2 Inch	60	71
M10x85	40	1.1/2	48	59
M10x99	40	2 Inch	60	73
M10x112	40	2.1/2	76	89
M12x124	50	3 Inch	89	102
M12x155	50	4 Inch	117	126
M16x140	-	-	-	-
M16x184	60	5 Inch	140	160
M16x209	60	6 Inch	168	186
M16x216	-	-	-	-
M16x266	60	8 Inch	216	240

Article groups				
Thread	Material	Surface treatment	Code	Page
M	St	Zipl	17243	12-31
M	St.St. A2		17567	12-32

17243 U-Bolt article 40G				F11B
Thread	Metric thread			
Material	Steel			
Surface treatment	Zinc plated			

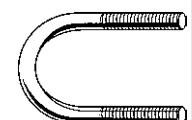

d x h x e x b	☒	Art.number	d x h x e x b	☒	Art.number	d x h x e x b	☒	Art.number
M6X42X29X20	50	17243.060.029	M8X74X52X35	50	17243.080.052	M12X124X102X50	10	17243.120.102
M6X53X34X25	50	17243.060.034	M8X85X57X40	50	17243.080.057	M12X155X126X50	10	17243.120.126
M6X61X41X30	50	17243.060.041						
			M10X85X59X40	25	17243.100.059	M16X184X160X60	3	17243.160.160
M8X71X36X30	50	17243.080.036	M10X99X73X40	25	17243.100.073	M16X209X186X60	3	17243.160.186
M8X61X44X30	50	17243.080.044	M10X112X89X40	25	17243.100.089			

17243 U-Bolt article 40G ←

d x h x e x b	Art.number
M16X266X240X60 2	17243.160.240

17567 U-Bolt article 40R F11C

Thread Metric thread
Material Stainless steel A2

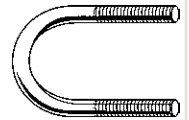

d x h x e x b	Art.number	d x h x e x b	Art.number	d x h x e x b	Art.number
M6X42X29X20 25	17567.060.029	M8X61X44X30 25	17567.080.044	M8X85X57X40 25	17567.080.057
M6X53X34X25 25	17567.060.034	M8X74X52X35 25	17567.080.052	M8X99X71X40 25	17567.080.073

Half pipe clamps Steel

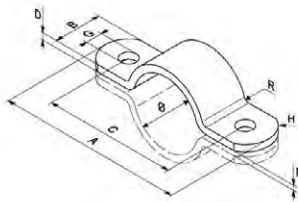

Technical Data

ø	A	C	F	G	H	R
12	63	38	3	9	18	4
16	68	43	3	9	18	4
18	72	47	3	9	18	4
20	75	50	3	9	18	4
22	80	55	3	9	18	4
25	88	58	4	11	18	5
27	92	62	4	11	18	5
30	93	63	4	11	18	5
32	95	65	4	11	18	5
34	98	68	4	11	18	5
38	104	74	4	11	18	5
42	126	86	5	14	22	6
45	132	92	5	14	22	6
48	135	95	5	14	22	6
54	140	100	5	14	22	6
57	145	105	5	14	22	6
60	150	110	5	14	22	6
63	150	110	5	14	22	6
66	155	115	5	14	22	6
70	162	122	5	14	22	6
76	165	125	5	14	22	6
80	172	132	5	14	22	6
83	175	135	5	14	22	6
89	180	140	5	14	22	6
95	185	145	5	14	22	6
102	200	160	5	14	38	10
108	210	170	5	14	38	10
114	215	175	5	14	38	10
120	220	180	5	14	38	10
127	225	185	5	14	38	10
133	255	205	6	18	60	12
140	260	210	6	18	60	12
146	266	216	6	18	60	12
152	272	222	6	18	60	12
159	285	235	6	18	60	12
165	290	240	6	18	60	12
168	293	243	6	18	60	12
174	300	250	6	18	60	12
178	304	254	6	18	60	12
191	320	270	6	18	60	12

Technical Data

ø	A	C	F	G	H	R
194	326	276	6	18	60	12
203	335	285	6	18	60	12
216	344	294	6	18	60	12
219	356	306	6	18	60	12
226	362	312	6	18	60	12
241	370	320	6	22	60	12
245	376	326	6	22	60	12
253	385	335	6	22	60	12
267	400	350	6	22	60	12
273	410	360	6	22	60	12
300	430	380	6	22	60	12
318	470	410	8	22	60	12
324	480	420	8	22	60	12
356	515	455	8	22	60	12
368	545	470	12	22	60	22
406	585	510	12	22	60	22
420	600	525	12	22	60	22
457	655	580	12	22	60	22
508	680	605	12	22	60	22
520	690	615	12	22	60	22
559	733	658	12	22	60	22
610	795	720	12	22	60	22
660	845	770	12	22	60	22
710	895	820	12	22	60	22
762	947	872	12	22	60	22
812	975	920	12	22	60	22
914	1124	1034	15	27	60	22

Article groups

Material	Surface treatment	Code	Page
St		64500	12-33
St	Hot d.g.	64507	12-34

64500 Half pipe clamps Steel

F11B

Material Steel



ø	Art.number	ø	Art.number	ø	Art.number
12MM	64500.012.001	89MM	64500.089.001	245MM	64500.245.001
16MM	64500.016.001	95MM	64500.095.001	253MM	64500.253.001
18MM	64500.018.001	102MM	64500.102.001	267MM	64500.267.001
20MM	64500.020.001	108MM	64500.108.001	273MM	64500.273.001
22MM	64500.022.001	114MM	64500.114.001	300MM	64500.300.001
25MM	64500.025.001	120MM	64500.120.001	318MM	64500.318.001
27MM	64500.027.001	127MM	64500.127.001	324MM	64500.324.001
30MM	64500.030.001	133MM	64500.133.001	356MM	64500.356.001
32MM	64500.032.001	140MM	64500.140.001	368MM	64500.368.001
34MM	64500.034.001	146MM	64500.146.001	406MM	64500.406.001
38MM	64500.038.001	152MM	64500.152.001	420MM	64500.420.001
42MM	64500.042.001	159MM	64500.159.001	457MM	64500.457.001
45MM	64500.045.001	165MM	64500.165.001	508MM	64500.508.001
48MM	64500.048.001	168MM	64500.168.001	520MM	64500.520.001
54MM	64500.054.001	174MM	64500.174.001	559MM	64500.559.001
57MM	64500.057.001	178MM	64500.178.001	610MM	64500.610.001
60MM	64500.060.001	191MM	64500.191.001	660MM	64500.660.001
63MM	64500.063.001	194MM	64500.194.001	710MM	64500.710.001
66MM	64500.066.001	203MM	64500.203.001	762MM	64500.762.001
70MM	64500.070.001	216MM	64500.216.001	812MM	64500.812.001
76MM	64500.076.001	219MM	64500.219.001	914MM	64500.914.001
80MM	64500.080.001	226MM	64500.226.001		
83MM	64500.083.001	241MM	64500.241.001		

64507 Half pipe clamps Steel
F11B
Material Steel
Surface treatment Hot dip galvanized

ø	✉	Art.number	ø	✉	Art.number	ø	✉	Art.number
12MM	1	64507.012.001	80MM	1	64507.080.001	219MM	1	64507.219.001
16MM	1	64507.016.001	83MM	1	64507.083.001	226MM	1	64507.226.001
18MM	1	64507.018.001	89MM	1	64507.089.001	241MM	1	64507.241.001
20MM	1	64507.020.001	95MM	1	64507.095.001	245MM	1	64507.245.001
22MM	1	64507.022.001	102MM	1	64507.102.001	253MM	1	64507.253.001
25MM	1	64507.025.001	108MM	1	64507.108.001	267MM	1	64507.267.001
27MM	1	64507.027.001	114MM	1	64507.114.001	273MM	1	64507.273.001
30MM	1	64507.030.001	120MM	1	64507.120.001	300MM	1	64507.300.001
32MM	1	64507.032.001	127MM	1	64507.127.001	318MM	1	64507.318.001
34MM	1	64507.034.001	133MM	1	64507.133.001	324MM	1	64507.324.001
38MM	1	64507.038.001	140MM	1	64507.140.001	356MM	1	64507.356.001
42MM	1	64507.042.001	152MM	1	64507.152.001	368MM	1	64507.368.001
45MM	1	64507.045.001	159MM	1	64507.159.001	406MM	1	64507.406.001
48MM	1	64507.048.001	165MM	1	64507.165.001	420MM	1	64507.420.001
54MM	1	64507.054.001	168MM	1	64507.168.001	457MM	1	64507.457.001
57MM	1	64507.057.001	178MM	1	64507.178.001	508MM	1	64507.508.001
60MM	1	64507.060.001	191MM	1	64507.191.001	520MM	1	64507.520.001
63MM	1	64507.063.001	194MM	1	64507.194.001	610MM	1	64507.610.001
66MM	1	64507.066.001	203MM	1	64507.203.001	710MM	1	64507.710.001
70MM	1	64507.070.001	216MM	1	64507.216.001	812MM	1	64507.812.001
76MM	1	64507.076.001						

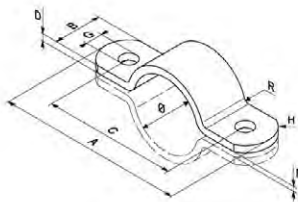
Half pipe clamps stainless steel

Technical Data

ø	A	C	F	G	H	R
12	63	39	3	7	20	3
16	67	43	3	7	20	3
18	69	45	3	7	20	3
20	71	47	3	7	20	3
22	73	49	3	7	20	3
25	76	52	3	7	20	3
27	78	54	3	7	20	3
30	81	57	3	7	20	3
32	83	59	3	7	20	3
34	85	61	3	7	20	3
38	89	65	3	7	20	3
42	102	74	3	10	25	4
45	105	77	3	10	25	4
48	108	80	3	10	25	4
51	112	83	3	10	25	4
54	114	86	3	10	25	4
57	117	89	3	10	25	4
60	120	92	3	10	25	4
63	123	95	3	10	25	4
66	126	98	3	10	25	4
70	138	110	4	10	30	4
76	144	116	4	10	30	4
80	148	120	4	10	30	4
83	151	123	4	10	30	4
89	157	129	4	10	30	4
95	163	135	4	10	30	4
102	170	142	4	10	30	4
108	176	148	4	10	30	4
114	182	154	4	10	30	4

Technical Data						
ø	A	C	F	G	H	R
120	188	160	4	10	30	4
127	195	167	4	10	30	4
133	218	182	5	12	40	5
140	225	189	5	12	40	5
146	231	195	5	12	40	5
152	237	201	5	12	40	5
159	244	208	5	12	40	5
165	250	214	5	12	40	5
168	253	217	5	12	40	5
174	259	223	5	12	40	5
178	263	227	5	12	40	5
191	276	240	5	12	40	5
194	279	243	5	12	40	5
203	288	252	5	12	40	5
216	301	265	5	12	40	5
219	304	268	5	12	40	5
226	311	275	5	12	40	5
241	341	301	5	14	40	8
245	345	305	5	14	40	8
253	353	313	5	14	40	8
267	367	327	5	14	40	8
273	373	333	5	14	40	8
300	400	360	5	14	40	8
318	418	378	5	14	40	8
324	424	384	5	14	40	8
356	456	416	5	14	40	8
368	468	428	5	14	40	8
406	506	466	5	14	40	8
420	520	480	5	14	40	8
457	557	517	5	14	40	8
508	608	568	5	14	40	8
520	620	580	5	14	40	8
559	659	619	5	14	40	8
610	710	670	5	14	40	8

Article groups		
Material	Code	Page
St.St. A2	64503	12-35
St.St. A4	64504	12-36

64503 Half pipe clamps stainless steel F11B

Material Stainless steel A2



ø	Art.number	ø	Art.number	ø	Art.number
12MM	64503.012.001	76MM	64503.076.001	203MM	64503.203.001
16MM	64503.016.001	80MM	64503.080.001	216MM	64503.216.001
18MM	64503.018.001	83MM	64503.083.001	219MM	64503.219.001
20MM	64503.020.001	89MM	64503.089.001	226MM	64503.226.001
22MM	64503.022.001	95MM	64503.095.001	241MM	64503.241.001
25MM	64503.025.001	102MM	64503.102.001	245MM	64503.245.001
27MM	64503.027.001	108MM	64503.108.001	253MM	64503.253.001
30MM	64503.030.001	114MM	64503.114.001	267MM	64503.267.001
32MM	64503.032.001	120MM	64503.120.001	273MM	64503.273.001
34MM	64503.034.001	127MM	64503.127.001	300MM	64503.300.001
38MM	64503.038.001	133MM	64503.133.001	318MM	64503.318.001
42MM	64503.042.001	140MM	64503.140.001	324MM	64503.324.001
45MM	64503.045.001	146MM	64503.146.001	356MM	64503.356.001
48MM	64503.048.001	152MM	64503.152.001	368MM	64503.368.001
51MM	64503.051.001	159MM	64503.159.001	406MM	64503.406.001
54MM	64503.054.001	165MM	64503.165.001	420MM	64503.420.001
57MM	64503.057.001	168MM	64503.168.001	457MM	64503.457.001
60MM	64503.060.001	174MM	64503.174.001	508MM	64503.508.001
63MM	64503.063.001	178MM	64503.178.001	520MM	64503.520.001
66MM	64503.066.001	191MM	64503.191.001	559MM	64503.559.001
70MM	64503.070.001	194MM	64503.194.001	610MM	64503.610.001

64504 Half pipe clamps stainless steel
F11B
Material Stainless steel A4

ø	☒	Art.number	ø	☒	Art.number	ø	☒	Art.number
12MM	1	64504.012.001	76MM	1	64504.076.001	203MM	1	64504.203.001
16MM	1	64504.016.001	80MM	1	64504.080.001	216MM	1	64504.216.001
18MM	1	64504.018.001	83MM	1	64504.083.001	219MM	1	64504.219.001
20MM	1	64504.020.001	89MM	1	64504.089.001	226MM	1	64504.226.001
22MM	1	64504.022.001	95MM	1	64504.095.001	241MM	1	64504.241.001
25MM	1	64504.025.001	102MM	1	64504.102.001	245MM	1	64504.245.001
27MM	1	64504.027.001	108MM	1	64504.108.001	253MM	1	64504.253.001
30MM	1	64504.030.001	114MM	1	64504.114.001	267MM	1	64504.267.001
32MM	1	64504.032.001	120MM	1	64504.120.001	273MM	1	64504.273.001
34MM	1	64504.034.001	127MM	1	64504.127.001	300MM	1	64504.300.001
38MM	1	64504.038.001	133MM	1	64504.133.001	318MM	1	64504.318.001
42MM	1	64504.042.001	140MM	1	64504.140.001	324MM	1	64504.324.001
45MM	1	64504.045.001	146MM	1	64504.146.001	356MM	1	64504.356.001
48MM	1	64504.048.001	152MM	1	64504.152.001	368MM	1	64504.368.001
51MM	1	64504.051.001	159MM	1	64504.159.001	406MM	1	64504.406.001
54MM	1	64504.054.001	165MM	1	64504.165.001	420MM	1	64504.420.001
57MM	1	64504.057.001	168MM	1	64504.168.001	457MM	1	64504.457.001
60MM	1	64504.060.001	174MM	1	64504.174.001	508MM	1	64504.508.001
63MM	1	64504.063.001	178MM	1	64504.178.001	520MM	1	64504.520.001
66MM	1	64504.066.001	191MM	1	64504.191.001	559MM	1	64504.559.001
70MM	1	64504.070.001	194MM	1	64504.194.001	610MM	1	64504.610.001

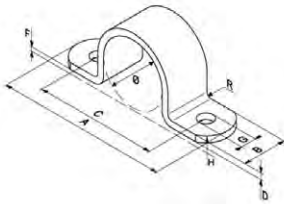
Full pipe clamps steel

Technical Data

ø	A	C	F	G	H	R
22	80	55	3	9	18	4
27	92	62	4	11	18	5
34	98	68	4	11	18	5
42	126	86	5	14	22	6
48	135	95	5	14	22	6
60	150	110	5	14	22	6
70	162	122	5	14	22	6
76	165	125	5	14	22	6
89	180	140	5	14	22	6
102	200	160	5	14	38	10
114	215	175	5	14	38	10
140	260	210	6	18	60	12
194	326	276	6	18	60	12
219	356	306	6	18	60	12
168	293	243	6	18	60	12
273	410	360	6	22	60	12
324	480	420	8	22	60	12

Article groups

Material	Surface treatment	Code	Page
St		64501	12-37
St	Hot d.g.	64502	12-37

64501 Full pipe clamps steel		F11B	
Material	Steel		

∅	☒	Art.number	∅	☒	Art.number	∅	☒	Art.number
22MM	1	64501.022.001	60MM	1	64501.060.001	114MM	1	64501.114.001
27MM	1	64501.027.001	70MM	1	64501.070.001	140MM	1	64501.140.001
34MM	1	64501.034.001	76MM	1	64501.076.001	194MM	1	64501.194.001
42MM	1	64501.042.001	89MM	1	64501.089.001	219MM	1	64501.219.001
48MM	1	64501.048.001	102MM	1	64501.102.001			

64502 Full pipe clamps steel		F11B	
Material	Steel		
Surface treatment	Hot dip galvanized		

∅	☒	Art.number	∅	☒	Art.number	∅	☒	Art.number
22MM	1	64502.022.001	60MM	1	64502.060.001	168MM	1	64502.168.001
27MM	1	64502.027.001	76MM	1	64502.076.001	219MM	1	64502.219.001
42MM	1	64502.042.001	89MM	1	64502.089.001	273MM	1	64502.273.001
48MM	1	64502.048.001	114MM	1	64502.114.001	324MM	1	64502.324.001

Full pipe clamps stainless steel

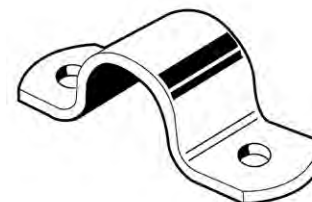
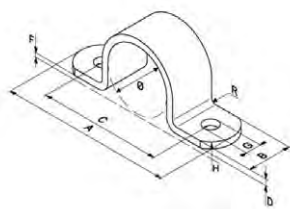

Technical Data						
∅	A	C	F	G	H	R
12	63	39	3	7	20	3
16	67	43	3	7	20	3
18	69	45	3	7	20	3
20	71	47	3	7	20	3
22	73	49	3	7	20	3
25	76	52	3	7	20	3
27	78	54	3	7	20	3
30	81	57	3	7	20	3
32	83	59	3	7	20	3
34	85	61	3	7	20	3
38	89	65	3	7	20	3
42	102	74	3	10	25	4
45	105	77	3	10	25	4
48	108	80	3	10	25	4
57	117	89	3	10	25	4
60	120	92	3	10	25	4
70	138	110	4	10	30	4
76	144	116	4	10	30	4
89	157	129	4	10	30	4
102	170	142	4	10	30	4
108	176	148	4	10	30	4
114	182	154	4	10	30	4
120	188	160	4	10	30	4
127	195	167	4	10	30	4
133	218	182	5	12	40	5
140	225	189	5	12	40	5
152	237	201	5	12	40	5
159	244	208	5	12	40	5
168	253	217	5	12	40	5

Technical Data						
ø	A	C	F	G	H	R
191	276	240	5	12	40	5
219	304	268	5	12	40	5
241	341	301	5	14	40	8
273	373	333	5	14	40	8
324	424	384	5	14	40	8
368	468	428	5	14	40	8
406	506	466	5	14	40	8
457	557	517	5	14	40	8
520	620	580	5	14	40	8
610	710	670	5	14	40	8

Article groups		
Material	Code	Page
St.St. A2	64505	12-38
St.St. A4	64506	12-38

64505 Full pipe clamps stainless steel F11B

Material: Stainless steel A2



ø	✉	Art.number	ø	✉	Art.number	ø	✉	Art.number
12MM	1	64505.012.001	48MM	1	64505.048.001	152MM	1	64505.152.001
16MM	1	64505.016.001	57MM	1	64505.057.001	159MM	1	64505.159.001
18MM	1	64505.018.001	60MM	1	64505.060.001	168MM	1	64505.168.001
20MM	1	64505.020.001	70MM	1	64505.070.001	191MM	1	64505.191.001
22MM	1	64505.022.001	76MM	1	64505.076.001	219MM	1	64505.219.001
25MM	1	64505.025.001	89MM	1	64505.089.001	241MM	1	64505.241.001
27MM	1	64505.027.001	102MM	1	64505.102.001	273MM	1	64505.273.001
30MM	1	64505.030.001	108MM	1	64505.108.001	324MM	1	64505.324.001
32MM	1	64505.032.001	114MM	1	64505.114.001	368MM	1	64505.368.001
34MM	1	64505.034.001	120MM	1	64505.120.001	406MM	1	64505.406.001
38MM	1	64505.038.001	127MM	1	64505.127.001	457MM	1	64505.457.001
42MM	1	64505.042.001	133MM	1	64505.133.001	520MM	1	64505.520.001
45MM	1	64505.045.001	140MM	1	64505.140.001	610MM	1	64505.610.001

64506 Full pipe clamps stainless steel F11B

Material: Stainless steel A4



ø	✉	Art.number	ø	✉	Art.number	ø	✉	Art.number
12MM	1	64506.012.001	48MM	1	64506.048.001	152MM	1	64506.152.001
16MM	1	64506.016.001	57MM	1	64506.057.001	159MM	1	64506.159.001
18MM	1	64506.018.001	60MM	1	64506.060.001	168MM	1	64506.168.001
20MM	1	64506.020.001	70MM	1	64506.070.001	191MM	1	64506.191.001
22MM	1	64506.022.001	76MM	1	64506.076.001	219MM	1	64506.219.001
25MM	1	64506.025.001	89MM	1	64506.089.001	241MM	1	64506.241.001
27MM	1	64506.027.001	102MM	1	64506.102.001	273MM	1	64506.273.001
30MM	1	64506.030.001	108MM	1	64506.108.001	324MM	1	64506.324.001
32MM	1	64506.032.001	114MM	1	64506.114.001	368MM	1	64506.368.001
34MM	1	64506.034.001	120MM	1	64506.120.001	406MM	1	64506.406.001
38MM	1	64506.038.001	127MM	1	64506.127.001	457MM	1	64506.457.001
42MM	1	64506.042.001	133MM	1	64506.133.001	520MM	1	64506.520.001
45MM	1	64506.045.001	140MM	1	64506.140.001	610MM	1	64506.610.001

Ornamental hood

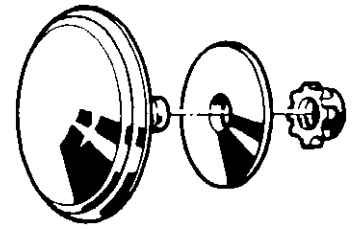

- Mounted on carton displaycard complete with mudwing repair washer and plastic nut.

Article groups

Material	Surface treatment	Color	Code	Page
Plastic		Black	72110	12-39
Plastic	Chr.pl.	Beige	72100	12-39

72110 Ornamental hood		Y92E
Material	Plastic	
Color	Black	

d	☒	Art.number	d	☒	Art.number	d	☒	Art.number
13-21-29 (6-22 ASS/S)	25	72110.001.770	18MM (6-21E/S)	25	72110.180.001	29MM (6-21C/S)	25	72110.320.001
13MM (6-21/S)	25	72110.130.001	21MM (6-21B/S)	25	72110.220.001	42MM (6-21D/S)	12	72110.400.001

- ASS/S (6-22), contents:
- 13mm - 10 pieces
- 21mm - 5 pieces
- 29mm - 10 pieces

72100 Ornamental hood		Y92E
Material	Plastic	
Surface treatment	Chrome plated	
Color	Beige	

d	☒	Art.number	d	☒	Art.number	d	☒	Art.number
13-21-29 (6-22 ASS)	25	72100.001.770	21MM (6-21B)	25	72100.220.001	42MM (6-21D)	12	72100.400.001
18MM (6-21E)	25	72100.180.001	29MM (6-21C)	25	72100.320.001			

- ASS (6-22), contents:
- 13mm - 10 pieces
- 21mm - 5 pieces
- 29mm - 10 pieces

Sealing push-in cap

DIN ≈443

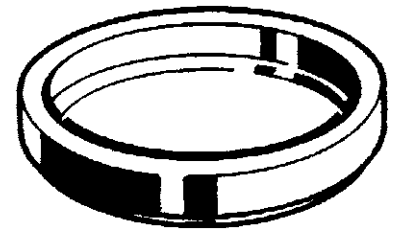
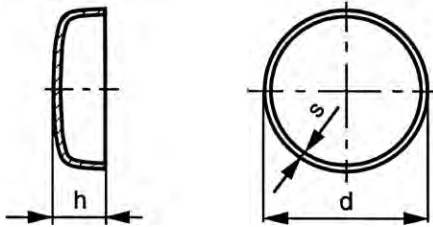

Technical Data

d (zc10)	h (js16)	s	d (zc10)	h (js16)	s
8	3	0.75	28	9	1.6
10	3	0.75	30	9	1.6
12	4	1	36	11	1.6
14	5	1	38	12	1.6
16	5	1	40	12	1.6
18	6	1	45	14	1.6
20	6	1	50	15	1.6
22	7	1.6	52	16	2
24 (#DIN)	7	1.6	56	17	2
25	8	1.6			

72150 Sealing push-in cap Y92D

Material Steel
Surface treatment Zinc plated



d	☒	Art.number	d	☒	Art.number	d	☒	Art.number
8MM	10	72150.080.001	22MM	10	72150.220.001	38MM	10	72150.380.001
10MM	10	72150.100.001	24MM	10	72150.240.001	40MM	10	72150.400.001
12MM	10	72150.120.001	25MM	10	72150.250.001	45MM	10	72150.450.001
14MM	10	72150.140.001	28MM	10	72150.280.001	50MM	10	72150.500.001
16MM	10	72150.160.001	30MM	10	72150.300.001	52MM	10	72150.520.001
18MM	10	72150.180.001	36MM	10	72150.360.001	56MM	10	72150.560.001
20MM	10	72150.200.001						

Sealing washer

DIN ≈470

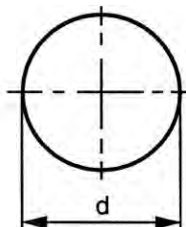
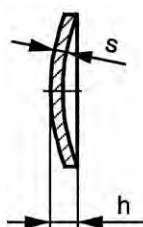

Technical Data

d (js11)	h	s	d (js11)	h	s
10	2.67	1.6	32	4.95	2
12	2.77	1.6	34	5.11	2
14	2.94	1.6	36	5.36	2
16	3.11	1.6	38	5.6	2
18	3.28	1.6	40	5.7	2
20	3.45	1.6	45	6.15	2
22	4.09	2	50	6.62	2
25	4.38	2	52	6.66	2
28	4.53	2	56	7.06	2
30	4.77	2			

72160 Sealing washer

Y92D

Material Steel
Surface treatment Zinc plated



d	☒	Art.number	d	☒	Art.number	d	☒	Art.number
10MM	20	72160.100.001	25MM	20	72160.250.001	38MM	20	72160.380.001
12MM	20	72160.120.001	28MM	20	72160.280.001	40MM	20	72160.400.001
14MM	20	72160.140.001	30MM	20	72160.300.001	45MM	20	72160.450.001
16MM	20	72160.160.001	32MM	20	72160.320.001	50MM	20	72160.500.001
18MM	20	72160.180.001	34MM	20	72160.340.001	52MM	20	72160.520.001
20MM	20	72160.200.001	36MM	20	72160.360.001	56MM	20	72160.560.001
22MM	20	72160.220.001						

Lubricating nipple cone type

DIN ≈71412



- Metric external taper screw thread acc. ≈ DIN 158.

Article groups

Thread	Material	Surface treatment	Code	Page
M	St	Zipl	72210	12-42
M	St.St. A1		72213	12-42

72210 Lubricating nipple cone type Y05A

Thread Metric thread
Material Steel
Surface treatment Zinc plated



d	☒	Art.number	d	☒	Art.number	d	☒	Art.number
M6-45°	100	72210.060.045	M8-90°	100	72210.080.090	M10-180°	100	72210.100.180
M6-90°	100	72210.060.090	M8-180°	100	72210.080.180	M12-45°	50	72210.120.045
M6-180°	100	72210.060.180	M10-45°	100	72210.100.045	M12-90°	50	72210.120.090
M8-45°	100	72210.080.045	M10-90°	100	72210.100.090	M12-180°	50	72210.120.180

72213 Lubricating nipple cone type Y05A

Thread Metric thread
Material Stainless steel A1



d	☒	Art.number	d	☒	Art.number	d	☒	Art.number
M6-45°	50	72213.060.045	M8-45°	50	72213.080.045	M10-45°	50	72213.100.045
M6-90°	50	72213.060.090	M8-90°	50	72213.080.090	M10-90°	50	72213.100.090
M6-180°	50	72213.060.180	M8-180°	50	72213.080.180	M10-180°	50	72213.100.180

Lubricating nipples drive-in type A/B/C (A=180°/B=45°/C=90°)

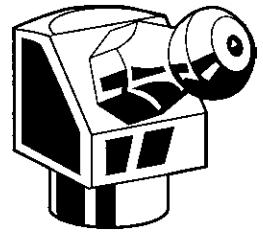

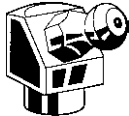

- Drill hole tolerance in steel – 0,25 to 0,3 mm, aluminium 0,15 to 0,2 mm and in castings – 0,1 mm.

72230 Lubricating nipples drive-in type A/B/C				Y05A				
Material	Steel			 				
Surface treatment	Zinc plated							
d	☒	Art.number	d	☒	Art.number	d	☒	Art.number
6MM-45°	100	72230.060.045	8MM-45°	100	72230.080.045	10MM-45°	100	72230.100.045
6MM-90°	100	72230.060.090	8MM-90°	100	72230.080.090	10MM-90°	100	72230.100.090
6MM-180°	100	72230.060.180	8MM-180°	100	72230.080.180	10MM-180°	100	72230.100.180

Lubricating nipple cupped type

DIN ≈3405 A



72170 Lubricating nipple cupped type				Y05A				
Thread	Metric fine thread			 				
Material	Steel							
Surface treatment	Zinc plated							
d	☒	Art.number	d	☒	Art.number	d	☒	Art.number
M6X0,75	100	72170.060.075	M8X1,00	100	72170.080.100	M10X1,00	100	72170.100.100
M6X1,00	100	72170.060.100	M8X1,25	100	72170.080.125			

Lubricating nipple button head M/MF

DIN ≈3404 A

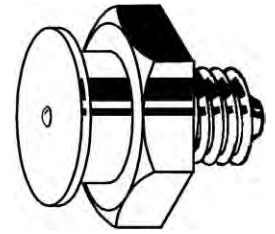

72186 Lubricating nipple button head M/MF

Y05A

Thread Metric fine thread
Material Steel
Surface treatment Zinc plated

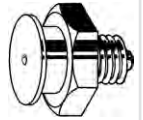

d x P	☒	Art.number	d x P	☒	Art.number	d x P	☒	Art.number
M6X0,75	100	72186.060.075	M8X1,00	100	72186.080.100	M10X1,00	100	72186.100.100
M6X1,00	100	72186.060.100	M8X1,25	100	72186.080.125	M10X1,50	100	72186.100.150

Lubricating nipple cone type MF (A=180°/B=45°/C=90°)

DIN ≈71412 A/B/C

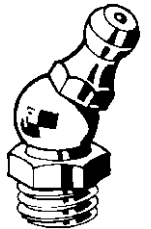

- Metric fine external taper screw thread acc. ≈ DIN 158.

72220 Lubricating nipple cone type MF (A=180°/B=45°/C=90°)

Y05A

Thread Metric fine thread
Material Steel
Surface treatment Zinc plated



d	☒	Art.number	d	☒	Art.number	d	☒	Art.number
M8X1,00-45°	100	72220.080.045	M12X1,50-45°	50	72220.120.045	M12X1,50-90°	50	72220.120.090
M8X1,00-90°	100	72220.080.090				M12X1,50-180°	50	72220.120.180
M8X1,00-180°	100	72220.080.180						

Lubricating nipple cone type MEF (A=180°/B=45°/C=90°)

DIN ≈71412 A/B/C

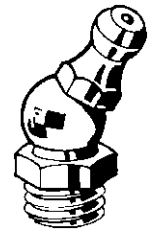

- Metric extra fine external taper screw thread acc. ≈ DIN 158.

72221 Lubricating nipple cone type MEF (A=180°/B=45°/C=90°)							Y05A	
Thread	Metric extra fine thread							
Material	Steel							
Surface treatment	Zinc plated							
d	☒	Art.number	d	☒	Art.number	d	☒	Art.number
M6X0,75-45°	100	72221.060.045	M8X0,75-90°	100	72221.080.090	M10X1,00-180°	100	72221.100.180
M6X0,75-90°	100	72221.060.090	M8X0,75-180°	100	72221.080.180	M12X1,00-45°	50	72221.120.045
M6X0,75-180°	100	72221.060.180	M10X1,00-45°	100	72221.100.045	M12X1,00-90°	50	72221.120.090
M8X0,75-45°	100	72221.080.045	M10X1,00-90°	100	72221.100.090	M12X1,00-180°	50	72221.120.180

Lubricating nipple cone R (A=180°/B=45°/C=90°)

DIN ≈71412 A/B/C

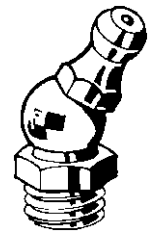

- External taper pipe thread acc. ≈ DIN 3858.

Article groups

Thread	Material	Surface treatment	Code	Page
R	St	Zipl	72240	12-45
R	St.St.		72243	12-45



72240 Lubricating nipple cone R (A=180°/B=45°/C=90°)							Y05A	
Thread	Conical pipe thread							
Material	Steel							
Surface treatment	Zinc plated							
d	☒	Art.number	d	☒	Art.number	d	☒	Art.number
1/8-45°	100	72240.031.045	1/4-90°	50	72240.063.090	3/8-180°	25	72240.096.180
1/8-90°	100	72240.031.090	1/4-180°	50	72240.063.180	1/2-45°	25	72240.127.045
1/8-180°	100	72240.031.180	3/8-45°	25	72240.096.045	1/2-90°	25	72240.127.090
1/4-45°	50	72240.063.045	3/8-90°	25	72240.096.090	1/2-180°	25	72240.127.180

72243 Lubricating nipple cone R (A=180°/B=45°/C=90°)							Y05A	
Thread	Conical pipe thread							
Material	Stainless steel							
d	☒	Art.number	d	☒	Art.number	d	☒	Art.number
1/8-45°	50	72243.031.045	1/8-180°	50	72243.031.180	1/4-90°	50	72243.063.090
1/8-90°	50	72243.031.090	1/4-45°	50	72243.063.045	1/4-180°	50	72243.063.180

Lubricating nipple cone type UNF (A=180°/B=45°/C=90°)

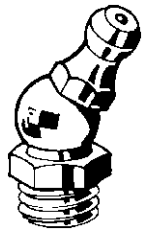
DIN ≈71412 A/B/C



72260	Lubricating nipple cone type UNF (A=180°/B=45°/C=90°)	Y05A
Thread	Unified National Fine	 
Material	Steel	
Surface treatment	Zinc plated	

d	⊠	Art.number	d	⊠	Art.number	d	⊠	Art.number
1/4-45°	100	72260.063.045	5/16-90°	100	72260.079.090	3/8-180°	100	72260.096.180
1/4-90°	100	72260.063.090	5/16-180°	100	72260.079.180	1/2-45°	50	72260.127.045
1/4-180°	100	72260.063.180	3/8-45°	100	72260.096.045	1/2-90°	50	72260.127.090
5/16-45°	100	72260.079.045	3/8-90°	100	72260.096.090	1/2-180°	50	72260.127.180

Lubricating nipple button head G

DIN ≈3404 A

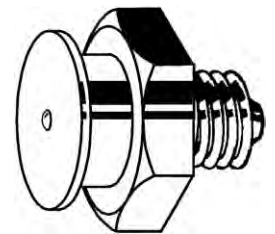

- Parallel pipe thread acc. to DIN ISO 228-1.

72185	Lubricating nipple button head G	Y05A
Thread	Cylindrical pipe thread	 
Material	Steel	
Surface treatment	Zinc plated	

d	⊠	Art.number	d	⊠	Art.number	d	⊠	Art.number
1/8	100	72185.031.001	1/4	100	72185.063.001	3/8	100	72185.096.001

Ball joint

DIN 71802 CS

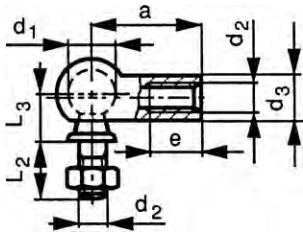

Technical Data

d ₂	a	d ₁	d ₃	e (min.)	L ₂	L ₃	P	Static load (kN)
M5	22	8	8	10.2	10.2	9	0.8	0.3
M6	25	10	10	11.5	12.5	11	1	0.7
M8	30	13	13	14	16.5	13	1.25	1.5
M10	35	16	16	15.5	20	16	1.5	2
M12 (#DIN)	35	16	16	15.5	20	16	1.75	2
M14 (#DIN)	45	19	22	21.5	28	20	1.5	3
M16 (#DIN)	45	19	22	21.5	28	20	2	3

- Special features of ball joints:
- Are supplied complete with INSIDE right hand- or left hand thread
- Equipped with a screw stud acc. to DIN 71805 type B with circlip acc. to DIN 71805 type S, angle joint acc. to DIN 71803 type A and a hexagon nut acc. to DIN 934

Article groups

Thread	Material	Surface treatment	Code	Page	
M	St	Zipl	right hand	57425	12-47
MF	St	Zipl	right hand	57426	12-47
M	St	Zipl	left hand	57475	12-47
MF	St	Zipl	left hand	57476	12-48

57425 Ball joint with inside right hand thread

L11A

Thread Metric thread
Material Steel
Surface treatment Zinc plated



d ₂	Art.number	d ₂	Art.number	d ₂	Art.number
M5	5 57425.050.001	M8	5 57425.080.001	M12	5 57425.120.001
M6	5 57425.060.001	M10	5 57425.100.001	M16	1 57425.160.001

57426 Ball joint with inside right hand thread

L11A

Thread Metric fine thread
Material Steel
Surface treatment Zinc plated



d ₂	Art.number
M14X1,50	5 57426.140.150

57475 Ball joint with inside left hand thread

L11A

Thread Metric thread
Material Steel
Surface treatment Zinc plated



d ₂	Art.number	d ₂	Art.number	d ₂	Art.number
M5	5 57475.050.001	M8	5 57475.080.001	M12	5 57475.120.001
M6	5 57475.060.001	M10	5 57475.100.001	M16	1 57475.160.001

57476 Ball joint with inside left hand thread L11A

Thread Metric fine thread
 Material Steel
 Surface treatment Zinc plated

d₂	✉	Art.number
M14X1,50	5	57476.140.150

Cardan joint single

DIN 808 E



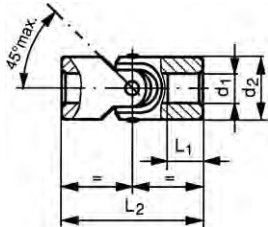

Technical Data

d ₁ (H7)	d ₂ (k11)	L ₁	L ₂	Md (max.) (Nm)
8 (#DIN)	13	12	42	6
10	16	15	52	8
12	20	18	62	20
16	25	22	74	30
20	32	25	86	60
25	40	32	108	160
32	50	40	132	290

• MD max. = maximum admissible torque.

57510 Cardan joint single L11A

Material Free-cutting steel

d ₁ x d ₂ x L ₂	✉	Art.number	d ₁ x d ₂ x L ₂	✉	Art.number	d ₁ x d ₂ x L ₂	✉	Art.number
8X13X42MM	1	57510.080.013	16X25X74MM	1	57510.160.025	25X40X108MM	1	57510.250.040
10X16X52MM	1	57510.100.016	20X32X86MM	1	57510.200.032	32X50X132MM	1	57510.320.050
12X20X62MM	1	57510.120.020						

Cardan joint double

DIN 808 D

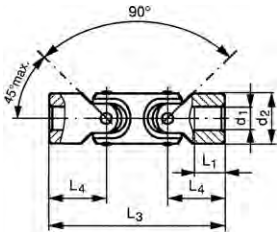

Technical Data

d ₁ (H7)	d ₂ (k11)	L ₁	L ₃	L ₄	Md (max.) (Nm)
8 (#DIN)	13	12	60	21	6
10	16	15	74	26	8
12	20	18	88	31	20
16	25	22	104	37	30
20	32	25	124	43	60
25	40	32	156	54	160

- MD max. = maximum admissible torque.

57560 Cardan joint double

L11A

Material Free-cutting steel



d ₁ x d ₂ x L ₃	☒	Art.number	d ₁ x d ₂ x L ₃	☒	Art.number	d ₁ x d ₂ x L ₃	☒	Art.number
8X13X60MM	1	57560.080.013	12X20X88MM	1	57560.120.020	20X32X124MM	1	57560.200.032
10X16X74MM	1	57560.100.016	16X25X104MM	1	57560.160.025	25X40X156MM	1	57560.250.040

Fork joint with spring pin type ES

DIN 71752

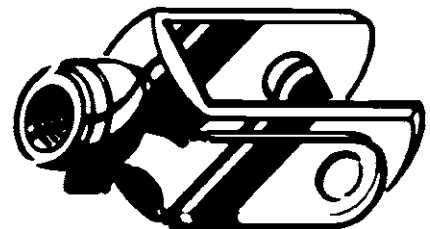
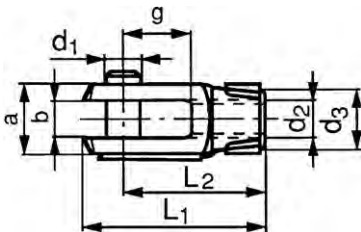

Technical Data

d ₁ x g	a	b (B13)	d ₂	d ₃	L ₁	L ₂
4x8	8	4	M4	8	21	16
5x10	10	5	M5	9	26	20
5x20	10	5	M5	9	36	30
6x12	12	6	M6	10	31	24
6x24	12	6	M6	10	43	36
8x16	16	8	M8	14	42	32
8x32	16	8	M8	14	58	48
10x20	20	10	M10	18	52	40
10x40	20	10	M10	18	72	60
12x24	24	12	M12	20	62	48
12x48	24	12	M12	20	86	72
14x28	27	14	M14	24	72	56
14x56	27	14	M14	24	101	85
16x32	32	16	M16	26	83	64
16x64	32	16	M16	26	115	96
20x40 (#DIN)	40	20	M20	34	105	80

- Special features of fork joints:
- Are supplied complete with a spring pin type ES.
- Due to the spring catch the hinge joints can be used much faster and easier without a tool than with the traditional method by means of a clevis pin with small head acc. to DIN 1434, a split pin (cotter pin) acc. to DIN 94 and a plain washer for clevis pins acc. to DIN 1440.
- Typical applications of fork joints are windscreen wipers, brake-gas or couplingrods and transmission of linear movements.
- Tolerance d₁ = H9/h11.

Article groups

Thread	Material	Surface treatment	Code	Page
M	Free-cutting steel	Zipl	57580	12-50
M	Free-cutting steel	Zipl left hand	57578	12-50

57580 Fork joint with spring pin type ES

L11A

Thread	Metric thread
Material	Free-cutting steel
Surface treatment	Zinc plated

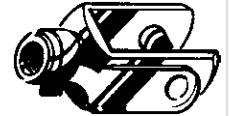

$d_1 \times g$	☒	Art.number	$d_1 \times g$	☒	Art.number	$d_1 \times g$	☒	Art.number
5X10MM	5	57580.050.010	8X32MM	5	57580.080.032	14X28MM	2	57580.140.028
5X20MM	5	57580.050.020	10X20MM	5	57580.100.020	14X56MM	2	57580.140.056
6X12MM	5	57580.060.012	10X40MM	5	57580.100.040	16X32MM	2	57580.160.032
6X24MM	5	57580.060.024	12X24MM	2	57580.120.024	16X64MM	1	57580.160.064
8X16MM	5	57580.080.016	12X48MM	2	57580.120.048	20X40MM	1	57580.200.040

57578 Fork joint with spring pin type ES, left-hand thread

L11A

Thread	Metric thread	DIN	71752 LH
Material	Free-cutting steel		
Surface treatment	Zinc plated		



$d_1 \times g$	☒	Art.number	$d_1 \times g$	☒	Art.number	$d_1 \times g$	☒	Art.number
5X20MM	5	57578.050.020	8X32MM	5	57578.080.032	12X48MM	2	57578.120.048
6X12MM	5	57578.060.012	10X20MM	5	57578.100.020	14X28MM	2	57578.140.028
6X24MM	5	57578.060.024	10X40MM	5	57578.100.040	16X32MM	2	57578.160.032
8X16MM	5	57578.080.016	12X24MM	2	57578.120.024	20X40MM	1	57578.200.040

Spherical plain bearing rod end with internal thread type SFC

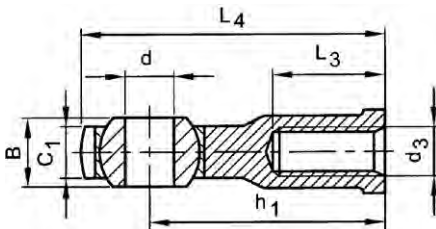

DIN 648 B
ISO 12240-4

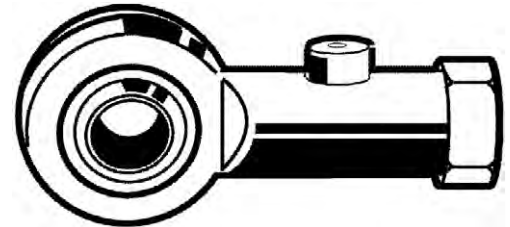

Technical Data

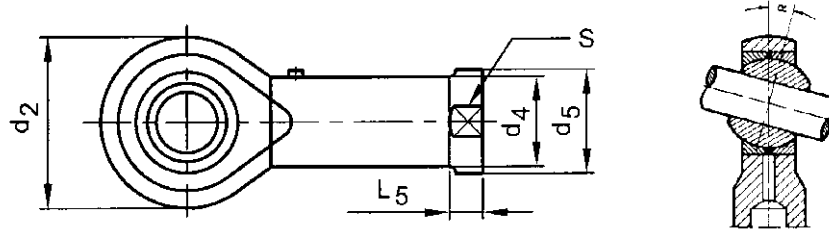

Type	SFC5	SFC6	SFC8	SFC10	SFC12	SFC14	SFC16
B	8	9	12	14	16	19	21
C₁ (max.)	7.5	7.5	9.5	11.5	12.5	14.5	15.5
d (H7)	5	6	8	10	12	14	16
d₂ (max.)	18	20	24	28	32	36	42
d₃	M5	M6	M8	M10	M12	M14	M16
d₄ (max.)	9	10	12.5	15	17.5	20	22
d₅ (max.)	12	13	16	19	22	25	27
h₁	27	30	36	43	50	57	64
L₃ (min.)	8	9	12	15	18	21	24
L₄ (max.)	37	41	49	58	67	76	86
L₅ (max.)	4	5	5	6.5	6.5	8	8
s	9	11	14	17	19	22	22
Static load (C°) (N)	6.000	7.000	12.000	14.500	17.000	24.000	28.500
α ° ≈	13	13	13	13	13	15	15



Article groups				
Thread	Material		Code	Page
M	St	right	57605	12-51
M	St	left hand	57655	12-51

57605 Spherical plain bearing rod end with internal thread type SFC right L11A



Thread: Metric thread
Material: Steel

Type	☒	Art.number	Type	☒	Art.number	Type	☒	Art.number
5	1	57605.050.001	10	1	57605.100.001	14	1	57605.140.001
6	1	57605.060.001	12	1	57605.120.001	16	1	57605.160.001
8	1	57605.080.001						

57655 Spherical plain bearing rod end with internal thread type SFC left L11A

Thread: Metric thread
Material: Steel



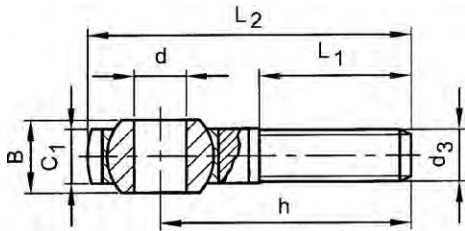

Type	☒	Art.number	Type	☒	Art.number	Type	☒	Art.number
5	1	57655.050.001	10	1	57655.100.001	14	1	57655.140.001
6	1	57655.060.001	12	1	57655.120.001	16	1	57655.160.001
8	1	57655.080.001						

Spherical plain bearing rod end with external thread

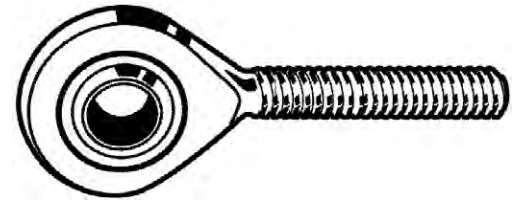

DIN 648 A
ISO 12240-4



Technical Data

Type	SMC 5	SMC 6	SMC 8	SMC 10	SMC 12	SMC 14	SMC 16
B	8	9	12	14	16	19	21
C ₁ (max.)	7.5	7.5	9.5	11.5	12.5	14.5	15.5
d (H7)	5	6	8	10	12	14	16
d ₂ (max.)	18	20	24	28	32	36	42
d ₃	M5	M6	M8	M10	M12	M14	M16
h	33	36	42	48	54	60	66
L ₁ (min.)	19	21	25	28	32	36	37
L ₂ (max.)	43	47	55	63	71	79	88
Static load (C°) (N)	3.000	4.000	8.000	13.000	17.000	24.000	28.500
α ° ≈	13	13	13	13	13	15	15

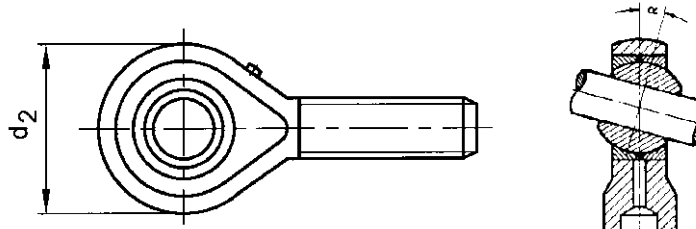

Article groups

Thread	Material	Surface treatment		Code	Page
M	St	Zipl	right	57600	12-52
M	St	Zipl	left hand	57650	12-52

57600 Spherical plain bearing rod end with external thread type SMC right L11A

Thread Metric thread
Material Steel
Surface treatment Zinc plated



Type	Art.number	Type	Art.number	Type	Art.number
5MM	1 57600.050.001	10MM	1 57600.100.001	14MM	1 57600.140.001
6MM	1 57600.060.001	12MM	1 57600.120.001	16MM	1 57600.160.001
8MM	1 57600.080.001				

57650 Spherical plain bearing rod end with external thread type SMC left L11A

Thread Metric thread
Material Steel
Surface treatment Zinc plated



Type	Art.number	Type	Art.number	Type	Art.number
5MM	1 57650.050.001	10MM	1 57650.100.001	14MM	1 57650.140.001
6MM	1 57650.060.001	12MM	1 57650.120.001	16MM	1 57650.160.001
8MM	1 57650.080.001				

Multiple connector

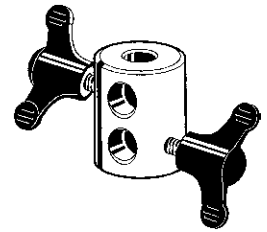
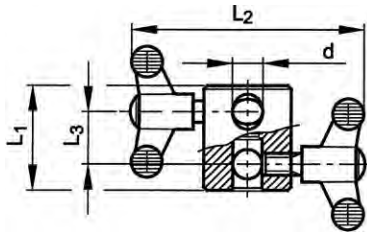

Technical Data

d	L ₁	L ₂	L ₃
10	40	90	20
12	44	90	20
16	56	126	24

57007 Multiple connector

W03A

Material Aluminium



d	Art.number	d	Art.number	d	Art.number
10MM	1 57007.100.001	12MM	1 57007.120.001	16MM	1 57007.160.001

Clamping joint individually adjustable

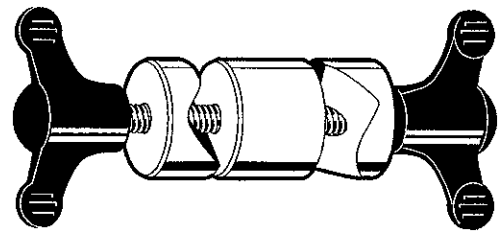
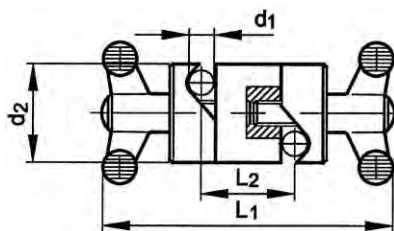

Technical Data

d ₁	d ₂	L ₁	L ₂
10	32	100	32
12	36	104	34
16	45	142	44

- Aluminium with steel class 5.8 zinc plated, threaded pin and Polyamid PA 6 winged knobs.

Assembly data

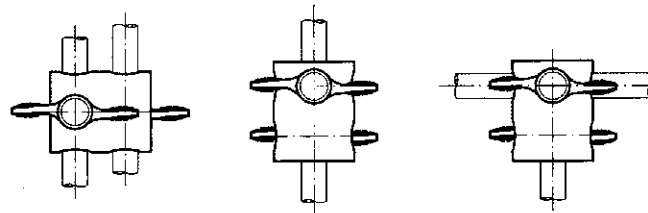

57008 Clamping joint individually adjustable

W03A

Material Aluminium

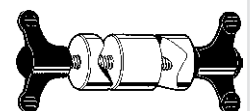

d ₁	Art.number	d ₁	Art.number	d ₁	Art.number
10MM	1 57008.100.001	12MM	1 57008.120.001	16MM	1 57008.160.001

Welding hinge



Article groups

Material	Code	Page
St	87911	12-54
St.St.	87916	12-54

87911 Welding hinge POM1

Material Steel



Size	⊗	Art.number	Size	⊗	Art.number	Size	⊗	Art.number
40	25	87911.000.040	80	25	87911.000.080	150	25	87911.000.150
50	25	87911.000.050	100	25	87911.000.100	180	25	87911.000.180
60	25	87911.000.060	120	25	87911.000.120	200	25	87911.000.200
70	25	87911.000.070	135	25	87911.000.135			

87916 Hinge POM1

Material Stainless steel

Size	⊗	Art.number	Size	⊗	Art.number	Size	⊗	Art.number
60	25	87916.000.060	100	25	87916.000.100	180MM	25	87916.000.180
80	25	87916.000.080	120	25	87916.000.120			

Hinge

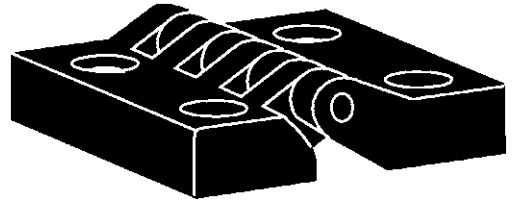
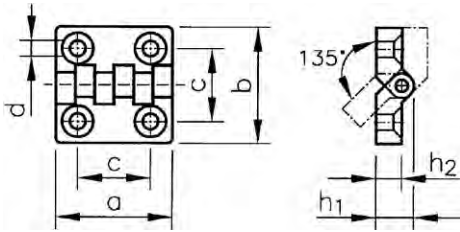

Technical Data

a x b	c	d	h ₁	h ₂
48 x 48	30	6.5	15.5	10.5
64 x 64	40	6.5	19	13

Assembly data

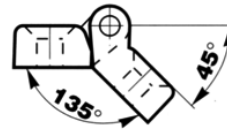
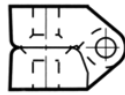

57013 Hinge		W03A
Material	Glass-fibre reinforced plastic	
Color	Black	

a x b	☒	Art.number	a x b	☒	Art.number	a x b	☒	Art.number
48X48MM	4	57013.040.040				64X64MM	4	57013.064.064

Slotted spring plunger with ball

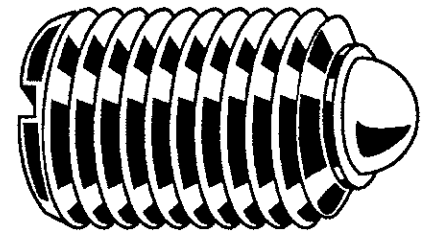
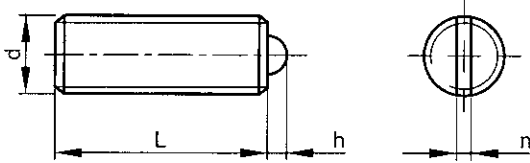

Technical Data

d	h	n	P	Spring pressure (N)
M3	0.5	0.4	0.5	1.5-3
M4	0.8	0.6	0.7	4-10
M5	0.9	0.8	0.8	6-11
M6	1	1	1	9-15
M8	1.5	1.2	1.25	15-30
M10	2	1.6	1.5	20-40
M12	2.5	2	1.75	30-55
M16	3.5	2.5	2	65-125
M20	4.5	2.5	2.5	80-160

Article groups

Thread	Material	Code	Page
M	Free-cutting steel	56950	12-56
M	St.St.	56951	12-56

56950 Slotted spring plunger with ball

W03A

Thread	Metric thread
Material	Free-cutting steel



d x L	☒	Art.number	d x L	☒	Art.number	d x L	☒	Art.number
M3X7	50	56950.030.007	M6X14	50	56950.060.014	M12X22	10	56950.120.022
M4X9	50	56950.040.009	M8X16	25	56950.080.016	M16X24	10	56950.160.024
M5X12	50	56950.050.012	M10X19	25	56950.100.019	M20X30	10	56950.200.030

56951 Slotted spring plunger with ball

W03A

Thread	Metric thread
Material	Stainless steel



d x L	☒	Art.number	d x L	☒	Art.number	d x L	☒	Art.number
M3X7	25	56951.030.007	M6X14	25	56951.060.014	M12X22	10	56951.120.022
M4X9	25	56951.040.009	M8X16	10	56951.080.016	M16X24	10	56951.160.024
M5X12	25	56951.050.012	M10X19	10	56951.100.019	M20X30	10	56951.200.030

Slotted spring plunger with pin

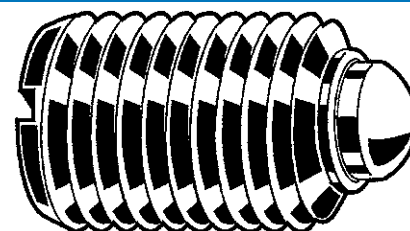
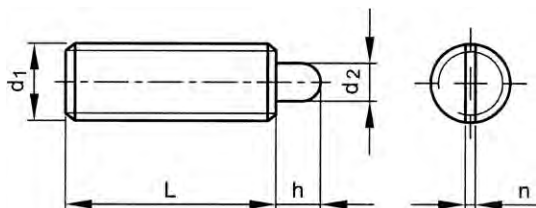

Technical Data

d ₁	d ₂	h	n	P	Spring pressure (N)
M4	1.8	1.5	0.6	0.7	6-20
M5	2.4	2	0.8	0.8	6-20
M6	2.7	2	1	1	7-20
M8	4	2	1.2	1.25	15-35
M10	4.5	2.5	1.6	1.5	20-45
M12	6	3.5	2	1.75	25-60
M16	8.5	4.5	2.5	2	45-100

Article groups

Thread	Material	Code	Page
M	Free-cutting steel	56975	12-57
M	St.St.	56976	12-57

56975 Slotted spring plunger with pin

W03A

Thread Metric thread
Material Free-cutting steel



d ₁	☒	Art.number	d ₁	☒	Art.number	d ₁	☒	Art.number
M4X9	50	56975.040.009	M8X16	25	56975.080.016	M12X22	10	56975.120.022
M5X12	50	56975.050.012	M10X19	25	56975.100.019	M16X24	10	56975.160.024
M6X14	50	56975.060.014						

56976 Slotted spring plunger with pin

W03A

Thread Metric thread
Material Stainless steel



d ₁ x L	☒	Art.number	d ₁ x L	☒	Art.number	d ₁ x L	☒	Art.number
M4X9	25	56976.040.009	M8X16	10	56976.080.016	M12X22	10	56976.120.022
M5X12	25	56976.050.012	M10X19	10	56976.100.019	M16X24	10	56976.160.024
M6X14	25	56976.060.014						

Spring plunger with pin and hexagon socket

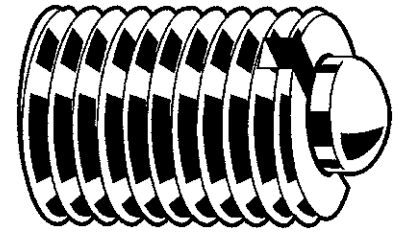
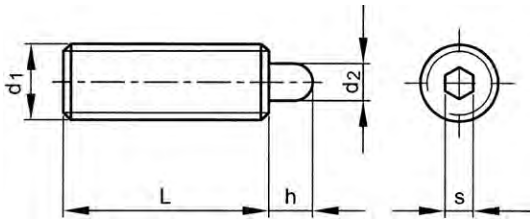

Technical Data

d_1	d_2	h	P	s	Spring pressure (N)
M3	1	1.5	0.5	0.7	0.5-3.5
M4	1.5	1.5	0.7	1.3	5-16
M5	2.4	2.3	0.8	1.5	6-20
M6	2.7	2.5	1	2	7-20
M8	3.5	3	1.25	2.5	9-35
M10	4	3	1.5	3	9-35
M12	6	4	1.75	4	10-55
M16	7.5	5	2	5	45-100
M20	10	7	2.5	6	60-145

Article groups

Thread	Material	Code	Page
M	Free-cutting steel	56977	12-58
M	St.St.	56978	12-58

56977 Spring plunger with pin and hexagon socket

W03A

Thread Metric thread
Material Free-cutting steel



$d_1 \times L$	☒	Art.number	$d_1 \times L$	☒	Art.number	$d_1 \times L$	☒	Art.number
M3X10	50	56977.030.010	M6X20	50	56977.060.020	M12X28	10	56977.120.028
M4X15	50	56977.040.015	M8X22	25	56977.080.022	M16X32	10	56977.160.032
M5X18	50	56977.050.018	M10X22	25	56977.100.022	M20X40	10	56977.200.040

56978 Spring plunger with pin and hexagon socket

W03A

Thread Metric thread
Material Stainless steel



$d_1 \times L$	☒	Art.number	$d_1 \times L$	☒	Art.number	$d_1 \times L$	☒	Art.number
M4X15	25	56978.040.015	M8X22	10	56978.080.022	M12X28	10	56978.120.028
M5X18	25	56978.050.018	M10X22	10	56978.100.022	M16X32	10	56978.160.032
M6X20	25	56978.060.020						

Spring plunger with plastic pin and hexagon socket

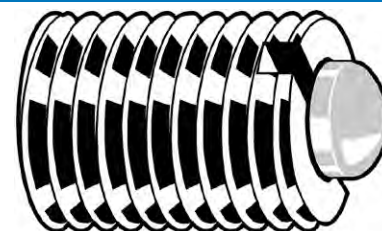
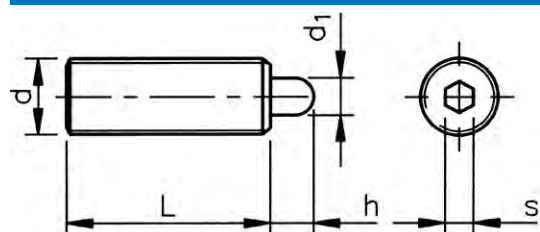

Technical Data

d	d ₁	h	P	s	Spring pressure (N)
M4	1.5	1.5	0.7	1.3	5-16
M5	2.4	2.3	0.8	1.5	5-20
M6	2.7	2.5	1	2	6-20
M8	3.5	3	1.25	2.5	7-35
M10	4	3	1.5	3	9-35
M12	6	4	1.75	4	10-55
M16	7.5	5	2	5	45-100

56980 Spring plunger with plastic pin and hexagon socket

W03A

Thread Metric thread
Material Free-cutting steel



d x L	⊠	Art.number	d x L	⊠	Art.number	d x L	⊠	Art.number
M4X15	25	56980.040.015	M8X22	10	56980.080.022	M12X28	10	56980.120.028
M5X18	25	56980.050.018	M10X22	10	56980.100.022	M16X32	10	56980.160.032
M6X20	25	56980.060.020						

Spring plunger smooth execution

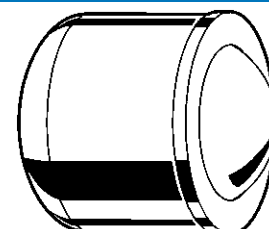
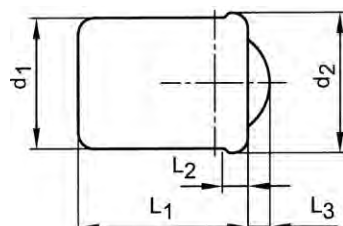

Technical Data

d ₁	d ₂	L ₁	L ₂	L ₃	Spring pressure (N)
4	4.6	5	1	0.8	3-7
5	5.6	6	1	1	4-7
6	6.5	7	1	1.5	6-12
8	8.5	9	1	1.8	6-12

56979 Spring plunger smooth execution

W03A

Material Stainless steel

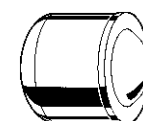

d ₁ x L ₁	⊠	Art.number	d ₁ x L ₁	⊠	Art.number	d ₁ x L ₁	⊠	Art.number
4X5MM	50	56979.040.005	6X7MM	50	56979.060.007	8X9MM	25	56979.080.009
5X6MM	50	56979.050.006						

Locking bolt without locking groove

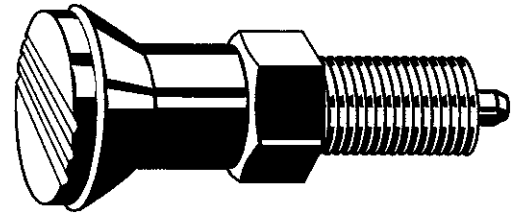
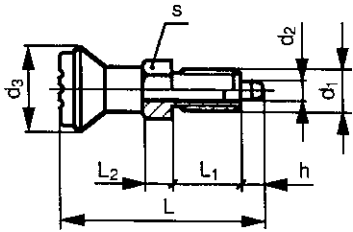

Technical Data

$d_1 \times P \times h$	d_2	d_3	h	L	L_2	s
M10x1.0x5	5	21	5	47	7	13
M12x1.5x6	6	25	6	56	8	14
M16x1.5x8	8	33	8	74	10	19
M16x1.5x15	8	33	15	80	13	19

56952 Locking bolt without locking groove

W03A

Thread Metric fine thread
Material Plastic Polyamide (nylon)/Steel
Class 6
Color Black

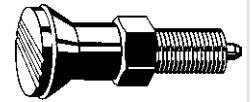

$d_1 \times P \times L_1$ (h)	☒	Art.number	$d_1 \times P \times L_1$ (h)	☒	Art.number	$d_1 \times P \times L_1$ (h)	☒	Art.number
M10X1,00X17/5	10	56952.100.017	M12X1,50X20/6	5	56952.120.020	M16X1,50X26/8	3	56952.160.026

Locking bolt with locking groove

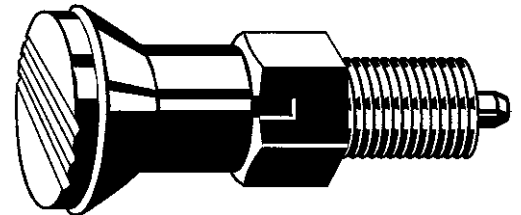
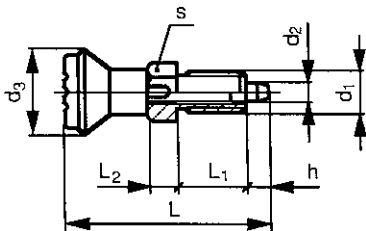

Technical Data

$d_1 \times P \times h$	d_2	d_3	h	L	L_2	s
M10x1.0x5	5	21	5	47	10	13
M12x1.5x6	6	25	6	56	11	14
M16x1.5x8	8	33	8	74	13	19

56953 Locking bolt with locking groove

W03A

Thread Metric fine thread
Material Plastic Polyamide (nylon)/Steel
Class 6
Color Black

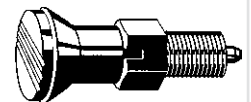

$d_1 \times P \times L_1$ (h)	☒	Art.number	$d_1 \times P \times L_1$ (h)	☒	Art.number	$d_1 \times P \times L_1$ (h)	☒	Art.number
M10X1,00X17/5	10	56953.100.017	M12X1,50X20/6	5	56953.120.020	M16X1,50X26/8	3	56953.160.026

Locking bolt

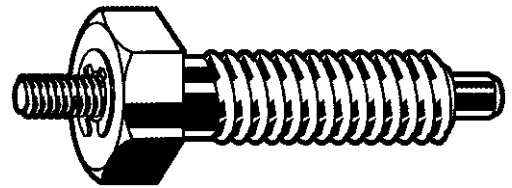
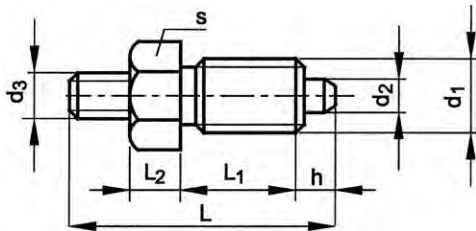

Technical Data

$d_1 \times P \times h$	d_2	d_3	h	L	L_2	s
M10x1.0x5	5	M4	5	37	7	13
M12x1.5x6	6	M6	6	43	8	14
M16x1.5x8	8	M8	8	56	10	19
M20x1.5x10	10	M8	10	62	12	22

57001 Locking bolt

W03A

Thread Metric fine thread
Material Steel

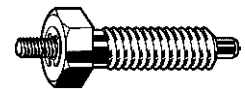

$d_1 \times P \times L_1 (h)$	☒	Art.number	$d_1 \times P \times L_1 (h)$	☒	Art.number	$d_1 \times P \times L_1 (h)$	☒	Art.number
M10X1,00X17/5	10	57001.100.100	M16X1,50X26/8	3	57001.160.150	M20X1,50X28/10	2	57001.200.150
M12X1,50X20/6	5	57001.120.150						

Cylindrical mounting type A

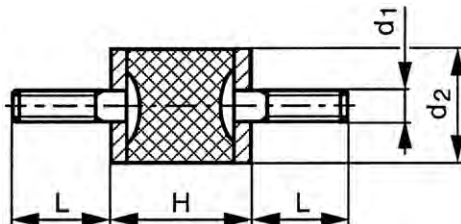

Technical Data

Type	d_1	d_2	H	L	Max. allowable shear load (N)	Max. compression load (N)
A10/10	M4	10	10	10	20	40
A15/08	M4	15	8	10	25	60
A15/15	M4	15	15	10	40	100
A18/8.5	M6	18	8.5	16	70	180
A20/15	M6	20	15	18	70	160
A20/20	M6	20	20	18	70	160
A20/25	M6	20	25	18	60	150
A25/10	M6	25	10	18	120	300
A25/15	M6	25	15	18	110	290
A25/20	M6	25	20	18	110	280
A25/25	M6	25	25	18	105	260
A25/30	M6	25	30	18	90	250
A30/15	M8	30	15	20	170	500
A30/20	M8	30	20	20	170	440
A30/30	M8	30	30	20	150	380
A30/40	M8	30	40	20	100	300
A40/30	M8	40	30	23	300	700
A40/40	M8	40	40	23	260	650
A50/20	M10	50	20	28	500	2.000
A50/25	M10	50	25	28	500	1.400
A50/30	M10	50	30	28	500	1.400
A50/40	M10	50	40	28	450	1.100
A50/45	M10	50	45	28	450	1.050
A50/50	M10	50	50	28	420	1.050
A70/45	M10	70	45	28	900	2.300
A75/25	M12	75	25	37	1.000	3.400

Technical Data

Type	d ₁	d ₂	H	L	Max. allowable shear load (N)	Max. compression load (N)
A75/40	M12	75	40	37	1.000	2.900
A75/50	M12	75	50	37	1.000	2.800
A75/55	M12	75	55	37	1.000	2.500
A100/40	M16	100	40	41	2.000	6.600
A100/55	M16	100	55	41	2.000	5.100
A100/60	M16	100	60	41	2.000	5.100
A100/65	M16	100	65	41	2.000	5.100

- Extension material natural rubber 55°/60° shore.

57770 Cylindrical mounting type A

S11A

Thread Metric thread
Material Steel
Surface treatment Zinc plated



Type	☒	Art.number	Type	☒	Art.number	Type	☒	Art.number
10/10 M4X10	10	57770.010.010	25/30 M6X18	10	57770.025.030	50/45 M10X28	5	57770.050.045
15/8 M4X10	10	57770.015.008	30/15 M8X20	10	57770.030.015	50/50 M10X28	5	57770.050.050
15/15 M4X13	10	57770.015.015	30/20 M8X20	10	57770.030.020	70/45 M10X28	5	57770.070.045
18/8,5 M6X16	10	57770.018.008	30/30 M8X20	10	57770.030.030	75/25 M12X37	5	57770.075.025
20/15 M6X18	10	57770.020.015	30/40 M8X20	10	57770.030.040	75/40 M12X37	5	57770.075.040
20/20 M6X18	10	57770.020.020	40/30 M8X23	10	57770.040.030	75/50 M12X37	5	57770.075.050
20/25 M6X18	10	57770.020.025	40/40 M8X23	10	57770.040.040	75/55 M12X37	5	57770.075.055
25/10 M6X18	10	57770.025.010	50/20 M10X28	5	57770.050.020	100/40 M16X41	2	57770.100.040
25/15 M6X18	10	57770.025.015	50/25 M10X28	5	57770.050.025	100/55 M16X41	2	57770.100.055
25/20 M6X18	10	57770.025.020	50/30 M10X28	5	57770.050.030	100/60 M16X41	2	57770.100.060
25/25 M6X18	10	57770.025.025	50/40 M10X28	5	57770.050.040	100/60M16X45	2	57770.100.065

Cylindrical mounting type B

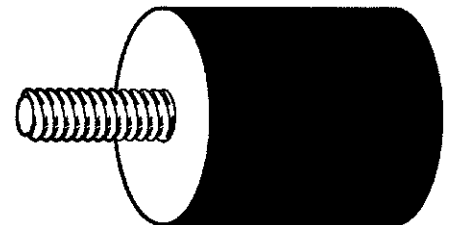
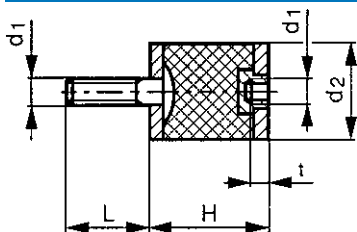

Technical Data

Type	d ₁	d ₂	H	L	Max. allowable shear load (N)	Max. compression load (N)	t
B10/10	M4	10	10	10	10	56	4
B15/15	M4	15	15	10	50	115	4
B20/15	M6	20	15	18	105	160	6
B20/20	M6	20	20	18	90	160	6
B20/25	M6	20	25	18	90	150	6
B25/15	M6	25	15	18	160	290	6
B25/20	M6	25	20	18	145	280	6
B25/25	M6	25	25	18	135	260	6
B25/30	M6	25	30	18	135	250	6
B30/15	M8	30	15	20	208	676	8
B30/20	M8	30	20	20	210	380	8
B30/30	M8	30	30	20	190	355	8
B30/40	M8	30	40	23	340	600	8
B40/30	M8	40	30	23	340	600	8
B40/40	M8	40	40	23	330	600	8
B50/20	M10	50	20	28	455	1.300	10
B50/30	M10	50	30	28	500	1.200	10
B50/40	M10	50	40	28	315	1.100	10
B50/45	M10	50	45	28	510	1.050	10
B50/50	M10	50	50	28	505	1.050	10
B70/45	M10	70	45	28	995	2.200	10
B75/40	M12	75	40	37	1.215	2.900	12
B75/50	M12	75	50	37	1.185	2.600	12
B75/55	M12	75	55	37	1.170	2.400	12
B100/40	M16	100	40	41	2.310	6.500	16

Technical Data

Type	d ₁	d ₂	H	L	Max. allowable shear load (N)	Max. compression load (N)	t
B100/55	M16	100	55	41	2.180	5.100	16
B100/60	M16	100	60	41	2.125	5.000	16

- Extension material natural rubber 55°/60° shore.
- Tolerance acc. to DIN 7715-2, class M3.

57771 Cylindrical mounting type B

S11A

Thread Metric thread
Material Steel
Surface treatment Zinc plated

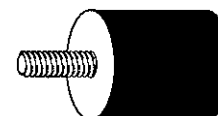

Type	☒	Art.number	Type	☒	Art.number	Type	☒	Art.number
10/10 M4X10-5	10	57771.010.010	30/15 M8X20	10	57771.030.015	50/45 M10X28-10	5	57771.050.045
15/15 M4X10-5	10	57771.015.015	30/20 M8X20-8	10	57771.030.020	50/50 M10X28-10	5	57771.050.050
20/15 M6X18-6	10	57771.020.015	30/30 M8X20-8	10	57771.030.030	70/45 M10X28-10	5	57771.070.045
20/20 M6X18-6	10	57771.020.020	30/40 M8X20	10	57771.030.040	75/40 M12X37-12	5	57771.075.040
20/25 M6X18-6	10	57771.020.025	40/30 M8X23-8	10	57771.040.030	75/50 M12X37	5	57771.075.050
25/15 M6X18-6	10	57771.025.015	40/40 M8X23-8	10	57771.040.040	75/55 M12X37-12	5	57771.075.055
25/20 M6X18-6	10	57771.025.020	50/20 M10X28-10	5	57771.050.020	100/40 M16X41-16	2	57771.100.040
25/25 M6X18-6	10	57771.025.025	50/30 M10X28-10	5	57771.050.030	100/55 M16X41-16	2	57771.100.055
25/30 M6X18-6	10	57771.025.030	50/40 M10X28-10	5	57771.050.040	100/60 M16X41-16	2	57771.100.060

Cylindrical mounting type C

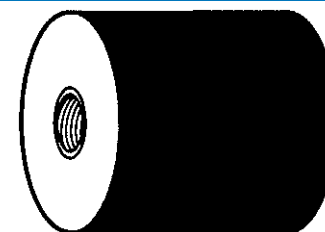
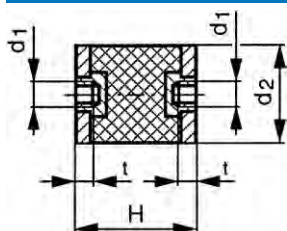

Technical Data

Type	d ₁	d ₂	H	Max. allowable shear load (N)	Max. compression load (N)	t
C10/10	M4	10	10	12	96	5
C15/15	M4	15	15	40	120	5
C20/20	M6	20	20	50	170	6
C20/25	M6	20	25	40	150	6
C25/20	M6	25	20	90	280	6
C25/25	M6	25	25	80	260	6
C25/30	M6	25	30	80	250	6
C30/20	M8	30	20	120	380	8
C30/30	M8	30	30	110	355	8
C30/40	M8	30	40	208	429	8
C40/30	M8	40	30	250	700	8
C40/40	M8	40	40	250	650	8
C50/30	M10	50	30	400	1.200	10
C50/40	M10	50	40	400	1.100	10
C50/45	M10	50	45	400	1.050	10
C50/50	M10	50	50	400	1.050	10
C70/45	M10	70	45	750	2.200	10
C75/40	M12	75	40	900	2.900	12
C75/50	M12	75	50	900	2.600	12
C100/40	M16	100	40	1.500	6.500	16
C100/55	M16	100	55	1.500	5.100	16
C100/60	M16	100	60	1.500	5.000	16

- Extension material natural rubber 55°/60° shore.
- Tolerance acc. to DIN 7715-2, class M3.

57780	Cylindrical mounting type C	S11A
Thread	Metric thread	
Material	Steel	
Surface treatment	Zinc plated	

Type	☒	Art.number	Type	☒	Art.number	Type	☒	Art.number
10/10M4X5	10	57780.010.010	30/20M8X8	10	57780.030.020	50/45M10X10	5	57780.050.045
15/15M4X5	10	57780.015.015	30/30M8X8	10	57780.030.030	50/50M10X10	5	57780.050.050
20/20M6X6	10	57780.020.020	30/40M8X8	10	57780.030.040	70/45M10X10	5	57780.070.045
20/25M6X6	10	57780.020.025	40/30M8X8	10	57780.040.030	75/40M12X12	5	57780.075.040
25/20M6X6	10	57780.025.020	40/40M8X8	10	57780.040.040	75/50M12X12	5	57780.075.050
25/25M6X6	10	57780.025.025	50/30M10X10	5	57780.050.030	100/40M16X16	2	57780.100.040
25/30M6X6	10	57780.025.030	50/40M10X10	5	57780.050.040	100/55M16X16	2	57780.100.055

Cylindrical mounting

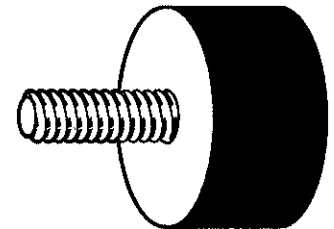
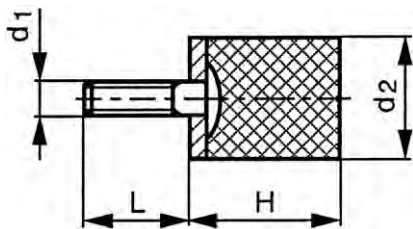

Technical Data

Type	d ₁	d ₂	H	L	Max. compression load (N)
D10/10	M4	10	10	10	59
D20/15	M6	20	15	18	160
KD25/17	M6	25	17	18	250
D25/17	M6	25	17	18	290
D30/17	M8	30	17	20	380
D30/20	M8	30	20	20	350
D40/28	M8	40	28	23	680
D40/30	M8	40	30	23	660
D40/38	M8	40	38	23	660
KD50/18	M10	50	18	28	1.400
D50/20	M10	50	20	28	1.500
D50/42	M10	50	42	28	1.100
D70/42	M10	70	42	30	2.200
D75/25	M12	75	25	37	5.446
D100/40	M16	100	40	41	6.600

- Extension material natural rubber 55°/60° shore.
- Tolerance acc. to DIN 7715-2, class M3.

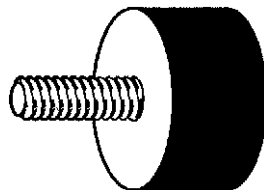
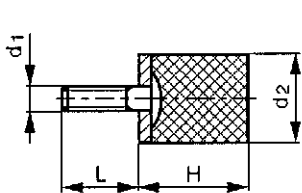

TYPE D

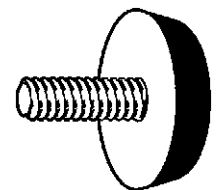
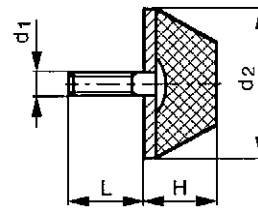

TYPE KD

57779	Cylindrical mounting type D en KD	S11A
Thread	Metric thread	
Material	Steel	
Surface treatment	Zinc plated	

Type	☒	Art.number	Type	☒	Art.number	Type	☒	Art.number
D10/10 M4X10	10	57779.010.010	D30/17 M8X20	10	57779.030.017	D40/38 M8X23	10	57779.040.038
D20/15 M6X18	10	57779.020.015	D30/20 M8X20	10	57779.030.020	KD50/18	5	57779.050.018
DK25/17 M6X18	10	57779.025.017	D40/28 M8X23	10	57779.040.028	D50/20 M10X28	5	57779.050.020
D25/17 M6X18	10	57779.025.117	D40/30 M8X23	10	57779.040.030	D50/42 M10X28	5	57779.050.042

57779 Cylindrical mounting type D en KD								
Type	☒	Art.number	Type	☒	Art.number	Type	☒	Art.number
D70/42 M10X30	5	57779.070.042	D75/25 M12X37	5	57779.075.025	D100/40 M16X41	2	57779.100.040

Mounting type RA

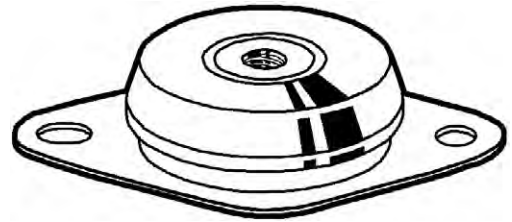
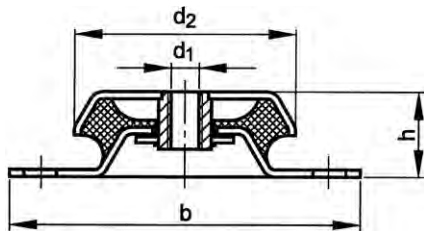

Technical Data							
Type	a	b	d ₁	d ₂	d ₃	h	Max. compression load (N)
RA 100/M10	110	130	M10	79	9	30	2.400
RA 100/M12	110	130	M12	79	9	30	2.400
RA 200/M10	124	150	M10	94	10	35	2.800
RA 200/M12	124	150	M12	94	10	35	2.800
RA 350/M12	140-148	175	M12	101	14	38	4.500
RA 350/M16	140-148	175	M16	101	14	38	4.500
RA 500/M16	158	192	M16	123	14	42	7.000
RA 800/M16	182	216	M16	144	14	48	13.000

- Domed cover zinc plated, blue passivated, vibration isolation material natural rubber (NR) 60° Shore (tol. ± 5°) and footplate steel with a Suncorite Aqua 100 Black coating.

Special features FABORY mountings type RA:

- suitable for the effective isolation of vibration and noise on different machines with rotating movements, like compressors, combusting engines, generators, converters, pumps, industrial and marin gen sets, fans, for use with presses, punches and other workshop machines.
- fitted as standard with an integral fail-safe design device with resilient stop.

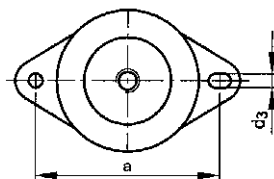

TYPE RA 100, RA 200, RA 500, RA 800

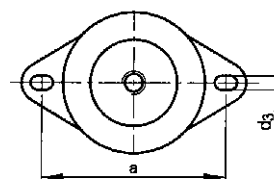

TYPE RA 350

57792 Mounting type RA							S12A
Thread	Metric thread						
Material	Steel						

Type	☒	Art.number	Type	☒	Art.number	Type	☒	Art.number
100-M10	2	57792.100.100	200-M12	2	57792.200.120	500-M16	1	57792.500.160
100-M12	2	57792.100.120	350-M12	1	57792.350.120	800-M16	1	57792.800.160
200-M10	2	57792.200.100	350-M16	1	57792.350.160			

Mounting type RAEM

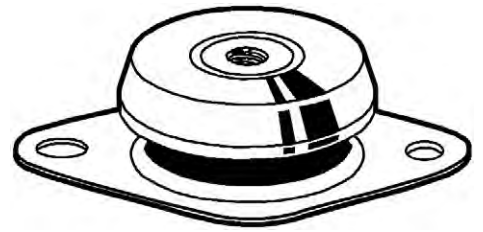
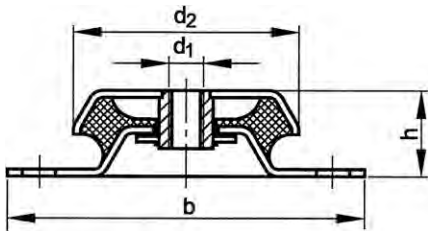

Technical Data

Type	a	b	d ₁	d ₂	d ₃	h	Max. compression load (N)
RAEM 40/M10	88	110	M10	64	9	35.5	600
RAEM 60/M12	100	120	M12	63	11	35.5	1.200
RAEM 125/M10	110	135	M10	84	11	35.5	1.800
RAEM 125/M12	110	135	M12	84	11	35.5	1.800
RAEM 350/M12	140-148	175	M12	110	14	42	4.000
RAEM 350/M16	140-148	175	M16	110	14	42	4.000
RAEM 800/M16	182	216	M16	155	14	54	8.000

- Domed cover zinc plated, blue passivated, vibration isolation material natural rubber (NR) 60° Shore (tol. ± 5°) and footplate steel with a Suncorite Aqua 100 Black coating.

Special features of FABORY mountings type RAEM:

- for applications demanding maximum isolation.
- suitable for the effective isolation of vibration and noise on different machines with rotating movements, like compressors, AC units, industrial fans, generators, combusting engines, emergency power sets, large milling machinery, industrial and marine gen sets, refiners and defibrators.
- fitted as standard with an integral fail-safe design device with resilient stop.

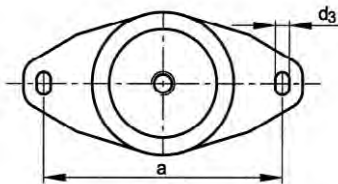

TYPE RAEM 60

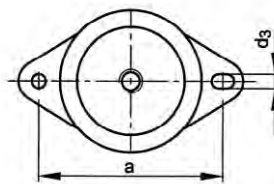

TYPE RAEM 40, RAEM 125, RAEM 800

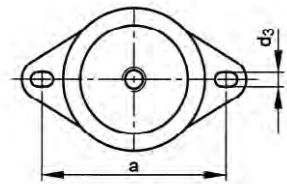

TYPE RAEM 350

57793 Mounting type RAEM		S12A
Thread	Metric thread	
Material	Steel	

Type	☒	Art.number	Type	☒	Art.number	Type	☒	Art.number
40-M10	2	57793.040.100	125-M12	2	57793.125.120	350-M16	1	57793.350.160
60-M12	2	57793.060.120	350-M12	1	57793.350.120	800-M16	1	57793.800.160
125-M10	2	57793.125.100						

Mounting type RAB

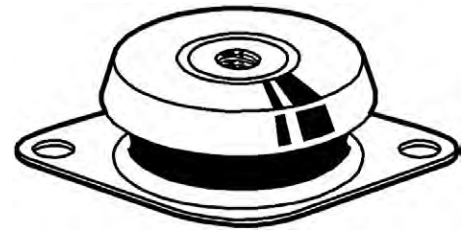
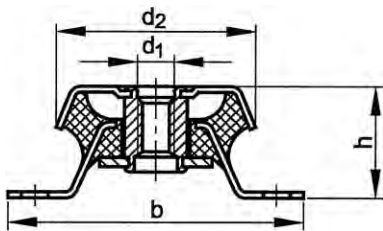

Technical Data

Type	a	b	d ₁	d ₂	h	Max. compression load (N)
RAB-0	76	93.5	M12	63	35	1.300
RAB-2	76	93.5	M12	63	35	1.050
RAB-3	76	93.5	M12	63	35	700

- Domed cover zinc plated, blue passivated, vibration isolation material butyl rubber (NR) 55° Shore (tol. ± 5°) and footplate steel with a Suncorite Aqua 100 Black coating.

Special features of FABORY mountings type RAB:

- optimum stiffness characteristics and horizontal stability
- especially effective on small 1, 2 and 3 cylinder diesel engines
- fitted as standard with an integral fail-safe design device with resilient stop

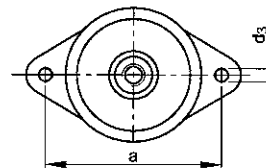

57794 Mounting type RAB

S12A

Thread Metric thread
Material Steel



Type	☒	Art.number	Type	☒	Art.number	Type	☒	Art.number
0-M12	2	57794.000.120	2-M12	2	57794.002.120	3-M12	2	57794.003.120

Mounting type M

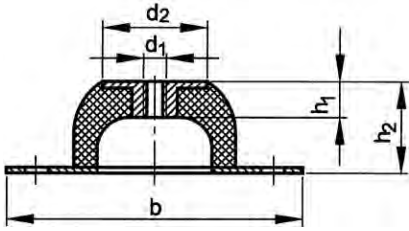

Technical Data

Type	a	b	d ₁	d ₂	d ₃	h ₁	h ₂	Max. compression load (N)
M 7	50	64	M6	18	7	7	20	90
M 25	66	85	M8	33	8	11	25	500
M 50	92	114	M10	45	10	14	35	800
M 100	110	136	M10	53	11.5	15	40	1.500
M 200	124	151	M10	58	11.5	13	45	2.200
M 400	120	150	M12	78	14.5	18	63	5.000

- Cover plate steel with a Suncorite Aqua 100 Black coating, vibration isolation material natural rubber (NR) 60° Shore (tol. ± 5°) and footplate steel with a Suncorite Aqua 100 Black coating.

Special features of FABORY mountings type M:

- high elastic, vertical as well as horizontal
- also suitable for shock attenuation
- the harmful effect of oil can often be avoided through the design of the mounting or by fitting a mechanical shield

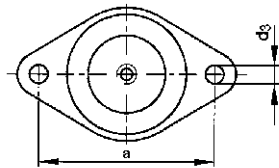

TYPE M7, M25, M50, M100, M200

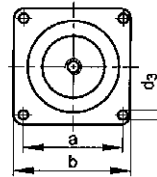

TYPE M400

57795	Mounting type M	S12A
Thread	Metric thread	
Material	Steel	

Type	☒	Art.number	Type	☒	Art.number	Type	☒	Art.number
7-M6	4	57795.007.060	50-M10	4	57795.050.100	200-M10	2	57795.200.100
25-M8	4	57795.025.080	100-M10	2	57795.100.100	400-M12	1	57795.400.120

Mounting type SE

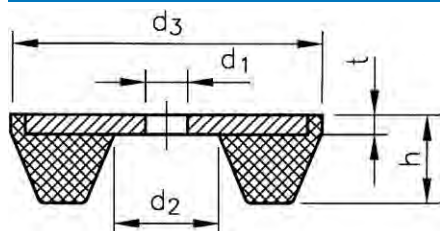

Technical Data

Type	d ₁	d ₂	d ₃	h	Max. compression load (N)	t
SE 75	8	18	55	15	1.500	3
SE 250	10	25	75	17	4.000	4

- Special features of mountings type SE:
- A simple mounting, friction is normally sufficient to prevent the suspended equipment from "walking"
- Suitable for office equipment, textile machinery, domestic appliances, electric motors, weighing equipment
- Cover plate steel with a Suncorite Aqua 100 Black coating, and vibration isolation material natural rubber (NR) 50° Shore.

57805 Mounting type SE

S12A

Thread Metric thread
Material Steel
Surface treatment Zinc plated



Type	☒	Art.number	Type	☒	Art.number
75SE	4	57805.000.075	250SE	4	57805.000.250

Hammer-In square cap

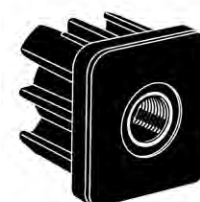
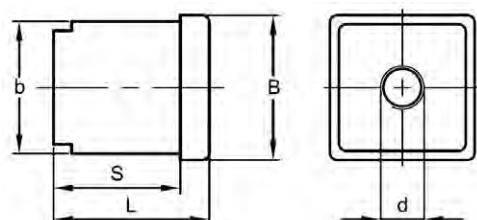

Technical Data

d x B x b	B	b	d	L	S
M10x30x27.5	30	27.5	M10	33	27
M12x40x36.5	40	36.5	M12	43	35
M12x50x45.5	50	45.5	M12	55	44
M14x40x36.5	40	36.5	M14	43	35
M16x40x36.5	40	36.5	M16	43	35
M16x40x37.5	40	37.5	M16	43	35
M16x50x45.5	50	45.5	M16	55	44
M16x50x47.5	50	47.5	M16	55	44
M16x60x56.5	60	56.5	M16	55	45
M20x50x45.5	50	45.5	M20	55	44
M20x50x46.5	50	46.5	M20	55	44

57730 Hammer-In square cap

S11A

Material Plastic Polyamide (nylon)



d x B x b	☒	Art.number	d x B x b	☒	Art.number	d x B x b	☒	Art.number
M10X30X27,5	2	57730.103.027	M16X40X36,5	1	57730.164.036	M16X60X56,5	1	57730.166.056
M12X40X36,5	2	57730.124.036	M16X40X37,5	1	57730.164.037	M20X50X45,5	1	57730.205.045
M12X50X45,5	2	57730.125.045	M16X50X45,5	1	57730.165.045	M20X50X46,5	1	57730.205.046
M14X40X36,5	2	57730.144.036	M16X50X47,5	1	57730.165.047			

Foot plate

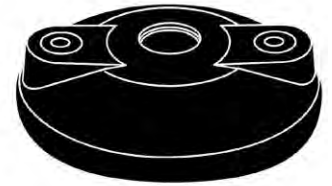
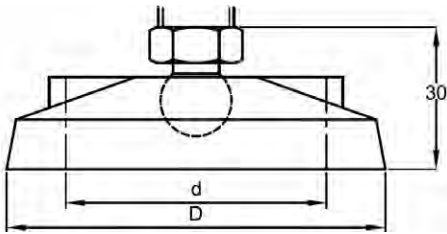

Technical Data

D	80	100	120
d	55	74	94



• Diameters 80, 100 and 120 from article group 57747 have a base plate with ground fixing holes.

Article groups

Material	Code	Page
Plastic PA	57747	12-70
St	57748	12-70
St.St. A2	57745	12-70

57747 Foot plate S11A



Material: Plastic Polyamide (nylon)

D	⊗	Art.number	D	⊗	Art.number	D	⊗	Art.number
50MM	4	57747.000.050	80MM	4	57747.000.080	120MM	2	57747.000.120
60MM	4	57747.000.060	100MM	2	57747.000.100			

57748 Foot plate S11A



Material: Steel

D	⊗	Art.number	D	⊗	Art.number	D	⊗	Art.number
30MM	4	57748.000.030	60MM	4	57748.000.060	120MM	2	57748.000.120
40MM	4	57748.000.040	80MM	4	57748.000.080			

57745 Foot plate S11A

Material: Stainless steel A2

d	⊗	Art.number	d	⊗	Art.number	d	⊗	Art.number
40MM	4	57745.040.001	60MM	4	57745.060.001	80MM	4	57745.080.001

Spindle for foot plates

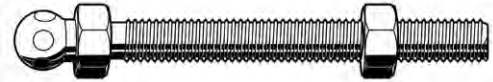
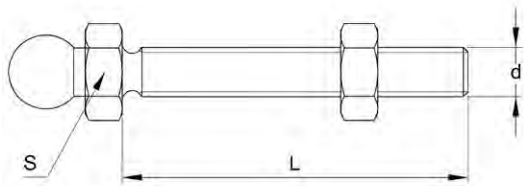

Technical Data

d	s	d	s
M8	14	M16	17
M10	14	M20	22
M12	14	M24*	17

* This nut has two flat sides instead of a hexagonal shape.

Article groups

Thread	Driving features	Material	Surface treatment	Code	Page
M	Hexagon	St	Zipl	57750	12-71
M	Hexagon	St.St. A2		57749	12-71

57750 Spindle for foot plates

S11A

Thread Metric thread
Material Steel
Surface treatment Zinc plated



d x L	☒	Art.number	d x L	☒	Art.number	d x L	☒	Art.number
M10X45	4	57750.100.045	M16X66	4	57750.160.066	M20X125	2	57750.200.125
M10X70	4	57750.100.070	M16X100	4	57750.160.100	M20X150	2	57750.200.150
M10X90	4	57750.100.090	M16X125	4	57750.160.125	M20X200	2	57750.200.200
M10X125	4	57750.100.125	M16X150	4	57750.160.150	M24X85	2	57750.240.085
M12X45	4	57750.120.045	M16X200	2	57750.160.200	M24X100	2	57750.240.100
M12X66	4	57750.120.066	M20X85	2	57750.200.085	M24X125	2	57750.240.125
M12X100	4	57750.120.100	M20X100	2	57750.200.100	M24X150	2	57750.240.150
M12X125	4	57750.120.125				M24X200	2	57750.240.200
M12X150	4	57750.120.150						

57749 Spindle for foot plates

S11A

Thread Metric thread
Material Stainless steel A2



d x L	☒	Art.number	d x L	☒	Art.number	d x L	☒	Art.number
M8X40	4	57749.080.040	M12X125	4	57749.120.125	M20X125	2	57749.200.125
M8X80	4	57749.080.080	M12X150	4	57749.120.150	M20X150	2	57749.200.150
M10X45	4	57749.100.045	M16X66	4	57749.160.066	M20X200	2	57749.200.200
M10X70	4	57749.100.070	M16X100	4	57749.160.100	M20X250	1	57749.200.250
M10X90	4	57749.100.090	M16X125	4	57749.160.125	M24X85	2	57749.240.085
M10X125	4	57749.100.125	M16X150	2	57749.160.150	M24X100	2	57749.240.100
M12X45	4	57749.120.045	M16X200	2	57749.160.200	M24X125	2	57749.240.125
M12X66	4	57749.120.066	M20X85	2	57749.200.085	M24X150	2	57749.240.150
M12X100	4	57749.120.100	M20X100	2	57749.200.100	M24X200	2	57749.240.200

Flexible machine support

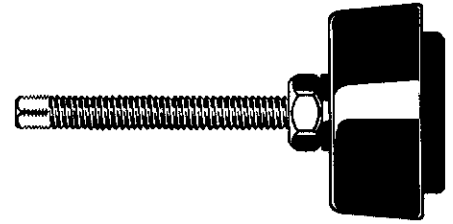
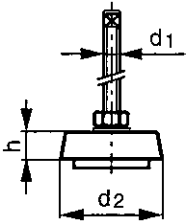

Technical Data

Type	T3	T5	T10	T15	T20	T25	T35	T40
d₁ x P	M10x1.25	M12x1.25	M14x1.5	M16x1.5	M16x1.5	M20x1.5	M20x1.5	M24x1.5
d₂	60	81	97	120	139	163	211	236
Ext. height of rubber	10	12	14	15	16	17	20	20
h	28	30	38	42	46	50	54	54
Length of adj. bolt	100	100	120	120	150	150	170	170
Load (kN)	0.5-1.5	1.5-4.5	4.5-7.5	6-12.5	7.5-15	11-22.5	22.5-45	30-60
Load per support for presses (kN)								
Max. strokes 125/min.	-	0.7-2	2-4	3-7	4-10	7-15	15-30	20-40
Max. strokes 160/min.	-	0.6-1.4	1.2-3.5	2.2-4.6	3.5-6	4.8-8	9-16	13-22
Max. strokes 200/min.	-	0.5-1.2	1-2.5	1.7-3.8	2.5-5	3.7-6.7	7.5-13	10-17

- Steel class 8.8 with rubber NBR profile.
- The adjustent bolt is up to and including type T20 with a square head bolt, above type T20 with a hexagon head bolt.
- Static load per flexible machine support in kN.
- Dynamic load per flexible machine support in kN for presses, max. number of strokes are stated per minute.
- Other sorts of rubber and/or hardness or longer adjustment bolts are available on request.

Examples of application

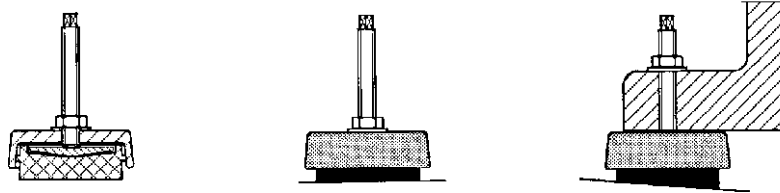

57676 Flexible machine support

S11A

Thread Metric fine thread
Material Steel
Class 8.8

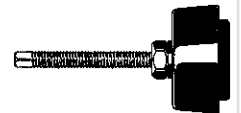

Type	☒	Art.number	Type	☒	Art.number	Type	☒	Art.number
T3	4	57676.000.003	T15	2	57676.000.015	T35	1	57676.000.035
T5	4	57676.000.005	T20	2	57676.000.020	T40	1	57676.000.040
T10	4	57676.000.010	T25	1	57676.000.026			

Bush

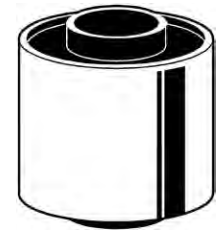
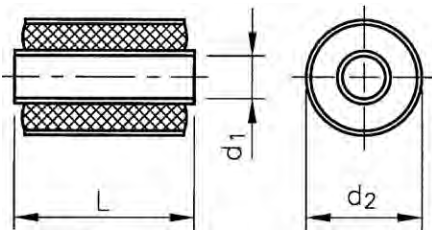

Technical Data

$d_1 \times d_2 \times L$	F_a (max.) (N)	F_r (max.) (N)	α (max.) in °	β (max.) in °
10x25x25	750	2.300	8	15
10x25x40	1.500	3.800	8	15
15x35x30	1.500	3.500	8	15
15x35x50	2.500	6.000	8	15
20x45x40	2.600	6.800	8	15
20x45x75	5.500	13.500	8	15
25x50x45	3.800	9.000	8	14
25x50x85	7.500	18.000	8	14
30x60x55	5.100	12.000	8	14
30x60x100	10.500	25.000	8	14
35x65x60	10.500	25.000	8	14
35x65x110	8.300	20.500	7	12
40x70x65	8.300	20.500	7	12
40x70x120	18.000	40.000	6	11
45x75x70	10.000	24.000	7	12
45x75x130	20.000	40.000	6	10
50x80x75	12.000	28.500	7	11
50x80x140	23.500	49.000	6	10

- Bush type VP designed to accommodate torsional movements and axial and radial loads.
- Consists of two concentric sleeves with rubber securely bonded between them.

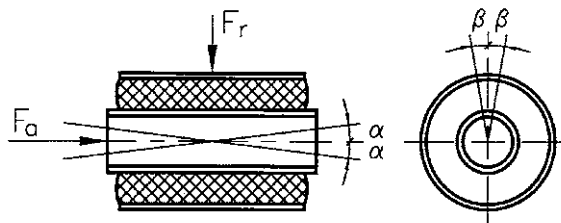

57807 Bush type VP

S12A

Material Steel



$d_1 \times d_2 \times L$	☒	Art.number	$d_1 \times d_2 \times L$	☒	Art.number	$d_1 \times d_2 \times L$	☒	Art.number
10X25X25MM	2	57807.125.025	25X50X45MM	1	57807.275.045	40X70X65MM	1	57807.470.065
10X25X40MM	2	57807.125.040	25X50X85MM	1	57807.275.085	40X70X120MM	1	57807.470.120
15X35X30MM	2	57807.185.030	30X60X55MM	1	57807.360.055	45X75X70MM	1	57807.525.070
20X45X40MM	2	57807.245.040				50X80X75MM	1	57807.580.075
20X45X75MM	1	57807.245.075						

Helical compression spring

DIN 2095

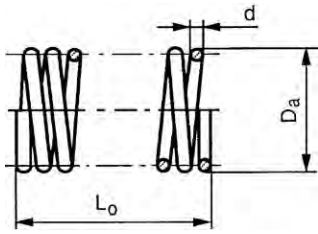

- Spring ends closed to, not grinded.

17912	Helical compression spring	Y92A
Material	Spring steel	
Surface treatment	Zinc plated	

d x D _a x L ₀	☒	Art.number	d x D _a x L ₀	☒	Art.number	d x D _a x L ₀	☒	Art.number
0,5X3,5X12MM	100	17912.053.012	0,8X7,7X40MM	100	17912.077.040	1,5X12,0X75MM	50	17912.162.075
0,5X3,5X15MM	100	17912.053.015	0,8X7,7X50MM	100	17912.077.050			
0,5X3,5X20MM	100	17912.053.020				1,5X14,0X40MM	100	17912.164.040
0,5X3,5X25MM	100	17912.053.025	1,0X6,0X20MM	100	17912.106.020	1,5X14,0X60MM	100	17912.164.060
			1,0X6,0X25MM	100	17912.106.025	1,5X14,0X75MM	50	17912.164.075
0,5X4,5X12MM	100	17912.054.012	1,0X6,0X30MM	100	17912.106.030	1,5X14,0X100MM	50	17912.164.100
0,5X4,5X15MM	100	17912.054.015	1,0X6,0X50MM	100	17912.106.050			
0,5X4,5X20MM	100	17912.054.020				2,0X12,0X35MM	100	17912.212.035
0,5X4,5X25MM	100	17912.054.025	1,0X8,0X25MM	100	17912.108.025	2,0X12,0X50MM	100	17912.212.050
			1,0X8,0X30MM	100	17912.108.030	2,0X12,0X75MM	100	17912.212.075
0,5X6,5X20MM	100	17912.056.020	1,0X8,0X35MM	100	17912.108.035			
0,5X6,5X25MM	100	17912.056.025				2,0X14,0X50MM	100	17912.214.050
0,5X6,5X30MM	100	17912.056.030	1,0X10,0X25MM	100	17912.110.025	2,0X14,0X75MM	50	17912.214.075
0,5X6,5X35MM	100	17912.056.035	1,0X10,0X35MM	100	17912.110.035	2,0X14,0X100MM	50	17912.214.100
0,5X6,5X40MM	100	17912.056.040	1,0X10,0X40MM	100	17912.110.040			
			1,0X10,0X60MM	100	17912.110.060	2,0X20,0X60MM	50	17912.220.060
0,8X4,7X15MM	100	17912.074.015	1,0X10,0X75MM	100	17912.110.075	2,0X20,0X75MM	50	17912.220.075
0,8X4,7X20MM	100	17912.074.020	1,0X10,0X100MM	100	17912.110.100	2,0X20,0X100MM	100	17912.220.100
0,8X4,7X25MM	100	17912.074.025						
			1,5X8,5X25MM	100	17912.158.025	2,25X14,0X50MM	100	17912.239.050
0,8X5,7X25MM	100	17912.075.025	1,5X8,5X35MM	100	17912.158.035	2,25X14,0X75MM	100	17912.239.075
0,8X5,7X35MM	100	17912.075.035				2,25X14,0X100MM	100	17912.239.100
			1,5X9,0X40MM	100	17912.159.040			
0,8X6,7X20MM	100	17912.076.020	1,5X9,0X75MM	100	17912.159.075	2,25X17,0X60MM	50	17912.242.060
0,8X6,7X25MM	100	17912.076.025				2,25X17,0X75MM	50	17912.242.075
0,8X6,7X30MM	100	17912.076.030	1,5X10,0X35MM	100	17912.160.035	2,25X17,0X100MM	50	17912.242.100
0,8X6,7X35MM	100	17912.076.035	1,5X10,0X50MM	100	17912.160.050			
			1,5X10,0X75MM	100	17912.160.075	2,25X22,0X60MM	50	17912.247.060
0,8X7,7X25MM	100	17912.077.025	1,5X10,0X100MM	50	17912.160.100	2,25X22,0X75MM	50	17912.247.075
0,8X7,7X30MM	100	17912.077.030				2,25X22,0X100MM	50	17912.247.100
0,8X7,7X35MM	100	17912.077.035	1,5X12,0X40MM	100	17912.162.040			

- Warning: electro-galvanizing of these products may cause hydrogen embrittlement.

Helical tension spring with English eye

DIN 2097

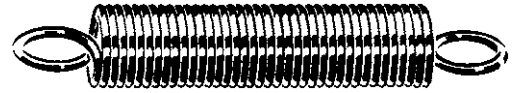
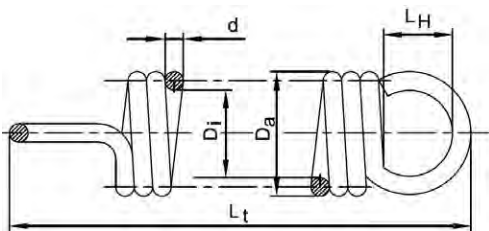

- With English eye $L_H \approx 1,1 D_1$.

17902 Helical tension spring with English eye		Y92A
Material	Spring steel	
Surface treatment	Zinc plated	

$d \times D_2 \times L_t$	☒	Art.number	$d \times D_2 \times L_t$	☒	Art.number	$d \times D_2 \times L_t$	☒	Art.number
0,5X3,5X12MM	100	17902.053.012	0,8X7,7X40MM	100	17902.077.040	1,5X12,0X40MM	100	17902.162.040
0,5X3,5X15MM	100	17902.053.015	0,8X7,7X50MM	100	17902.077.050	1,5X12,0X75MM	100	17902.162.075
0,5X3,5X20MM	100	17902.053.020						
0,5X3,5X25MM	100	17902.053.025	1,0X6,0X20MM	100	17902.106.020	1,5X14,0X40MM	100	17902.164.040
			1,0X6,0X25MM	100	17902.106.025	1,5X14,0X60MM	100	17902.164.060
0,5X4,5X12MM	100	17902.054.012	1,0X6,0X30MM	100	17902.106.030	1,5X14,0X75MM	100	17902.164.075
0,5X4,5X15MM	100	17902.054.015	1,0X6,0X44MM	100	17902.106.044	1,5X14,0X100MM	50	17902.164.100
0,5X4,5X20MM	100	17902.054.020	1,0X6,0X50MM	100	17902.106.050			
0,5X4,5X25MM	100	17902.054.025						
			1,0X8,0X25MM	100	17902.108.025	2,0X12,0X35MM	100	17902.212.035
0,5X6,5X20MM	100	17902.056.020	1,0X8,0X30MM	100	17902.108.030	2,0X12,0X50MM	100	17902.212.050
0,5X6,5X25MM	100	17902.056.025	1,0X8,0X35MM	100	17902.108.035	2,0X12,0X75MM	100	17902.212.075
0,5X6,5X30MM	100	17902.056.030						
0,5X6,5X35MM	100	17902.056.035	1,0X10,0X25MM	100	17902.110.025	2,0X14,0X50MM	100	17902.214.050
0,5X6,5X40MM	100	17902.056.040	1,0X10,0X35MM	100	17902.110.035	2,0X14,0X75MM	100	17902.214.075
0,5X6,0X46MM	100	17902.056.046	1,0X10,0X40MM	100	17902.110.040	2,0X14,0X100MM	50	17902.214.100
			1,0X10,0X60MM	100	17902.110.060	2,0X20,0X60MM	50	17902.220.060
0,8X4,7X15MM	100	17902.074.015	1,0X10,0X75MM	100	17902.110.075	2,0X20,0X75MM	50	17902.220.075
0,8X4,7X20MM	100	17902.074.020	1,0X10,0X100MM	100	17902.110.100	2,0X20,0X100MM	50	17902.220.100
0,8X4,7X25MM	100	17902.074.025						
			1,5X8,5X25MM	100	17902.158.025	2,25X14,0X50MM	100	17902.239.050
0,8X5,7X25MM	100	17902.075.025	1,5X8,5X35MM	100	17902.158.035	2,25X14,0X75MM	100	17902.239.075
0,8X5,7X35MM	100	17902.075.035				2,25X14,0X100MM	50	17902.239.100
			1,5X9,0X40MM	100	17902.159.040			
0,8X6,7X20MM	100	17902.076.020	1,5X9,0X75MM	100	17902.159.075	2,25X17,0X60MM	100	17902.242.060
0,8X6,7X25MM	100	17902.076.025				2,25X17,0X75MM	50	17902.242.075
0,8X6,7X30MM	100	17902.076.030	1,5X10,0X35MM	100	17902.160.035	2,25X17,0X100MM	25	17902.242.100
0,8X6,7X35MM	100	17902.076.035	1,5X10,0X50MM	100	17902.160.050			
			1,5X10,0X75MM	100	17902.160.075	2,25X22,0X60MM	100	17902.247.060
0,8X7,7X25MM	100	17902.077.025	1,5X10,0X100MM	100	17902.160.100	2,25X22,0X75MM	50	17902.247.075
0,8X7,7X30MM	100	17902.077.030				2,25X22,0X100MM	25	17902.247.100
0,8X7,7X35MM	100	17902.077.035						

- Warning: electro-galvanizing of these products may cause hydrogen embrittlement.

Ball knob

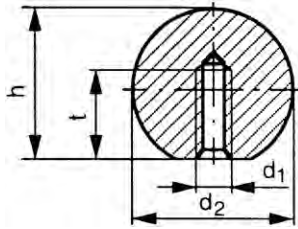

DIN ≈319



Technical Data

d ₁ x d ₂	h	P	t	d ₁ x d ₂	h	P	t
M3x10	9.5	0.5	5	M8x36	34	1.25	16
M4x12	11	0.7	7.5	M8x40	37	1.25	21
M4x16	15	0.7	7.5	M10x32	29	1.5	16
M4x20	18	0.7	10.5	M10x35	21	1.5	13.5
M5x16	15	0.8	7.5	M10x40	37	1.5	21
M5x20	18	0.8	10.5	M10x45	43	1.5	21
M5x25	22.5	0.8	13.5	M10x50	46	1.5	25
M6x16	15	1	7.5	M12x40	37	1.75	21
M6x20	18	1	10.5	M12x45	43	1.75	21
M6x25	22.5	1	13.5	M12x50	46	1.75	25
M6x32	29	1	16	M12x60	57	1.75	30
M8x20	18	1.25	10.5	M14x40	37	1.75	21
M8x25	13.5	1.25	13.5	M16x50	46	2	25
M8x32	29	1.25	16	M16x60	57	2	30
M8x35	21	1.25	13.5				

Article groups

Thread	Material	Class	Color	Code	Page
M	Plastic PF	FS31	Black	56914	12-76
M	Plastic PF	FS31	Black	56916	12-76

56914 Ball knob type C

W03F

Thread	Metric thread	DIN	≈319 C
Material	Plastic Fenolformaldehyde (bakelite)		
Class	FS31		
Color	Black		



d ₁ x d ₂	Art.number	d ₁ x d ₂	Art.number	d ₁ x d ₂	Art.number
M3X10	5 56914.030.010	M6X25	5 56914.060.025	M10X45	5 56914.100.045
M4X12	5 56914.040.012	M6X32	5 56914.060.032	M10X50	5 56914.100.050
M4X16	5 56914.040.016	M8X20	5 56914.080.020	M12X40	5 56914.120.040
M4X20	5 56914.040.020	M8X25	5 56914.080.025	M12X45	5 56914.120.045
M5X16	5 56914.050.016	M8X32	5 56914.080.032	M12X50	5 56914.120.050
M5X20	5 56914.050.020	M8X35	5 56914.080.035		
M5X25	5 56914.050.025	M8X40	5 56914.080.040	M14X40	5 56914.140.040
M6X16	5 56914.060.016	M10X32	5 56914.100.032	M16X50	5 56914.160.050
M6X20	5 56914.060.020	M10X35	5 56914.100.035	M16X60	5 56914.160.060
		M10X40	5 56914.100.040		

56916 Ball knob type E

W03F

Thread	Metric thread	DIN	≈319 E
Material	Plastic Fenolformaldehyde (bakelite)		
Class	FS31		
Color	Black		



d ₁ x d ₂	Art.number	d ₁ x d ₂	Art.number	d ₁ x d ₂	Art.number
M4X16	10 56916.040.016	M8X32	5 56916.080.032	M10X50	5 56916.100.050
M5X20	10 56916.050.020	M8X36	5 56916.080.036	M12X40	5 56916.120.040
M5X25	10 56916.050.025	M8X40	5 56916.080.040	M12X50	5 56916.120.050
M6X25	5 56916.060.025	M10X40	5 56916.100.040	M12X60	5 56916.120.060
M6X32	5 56916.060.032	M10X45	5 56916.100.045	M16X60	5 56916.160.060

56916 Ball knob type E

- With steel zinc plated threaded bush, sizes M4 x 16 and M16 x 60 with a brass threaded bush.

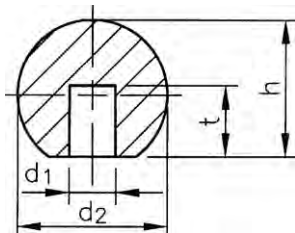
Ball knob with conical hole

DIN ≈319 M

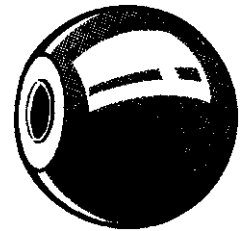
Technical Data

$d_1 \times d_2$	h	t	$d_1 \times d_2$	h	t
4x16	15	9	10x32	29	15
5x20	18	12	10x40	37	20
6x25	22.5	15	12x40	37	20
8x25	22.5	15	12x50	46	22
8x32	29	15	16x50	46	22

56915 Ball knob with conical hole type M

W03F

Material Plastic Fenolformaldehyde (bakelite)
Class FS31
Color Black



$d_1 \times d_2$	☒	Art.number	$d_1 \times d_2$	☒	Art.number	$d_1 \times d_2$	☒	Art.number
4X16MM	10	56915.040.016	8X32MM	5	56915.080.032	12X40MM	5	56915.120.040
5X20MM	10	56915.050.020	10X32MM	5	56915.100.032	12X50MM	5	56915.120.050
6X25MM	5	56915.060.025	10X40MM	5	56915.100.040	16X50MM	5	56915.160.050
8X25MM	5	56915.080.025						

Star grip type L

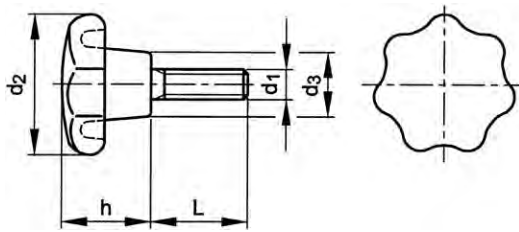

DIN ≈6336 L

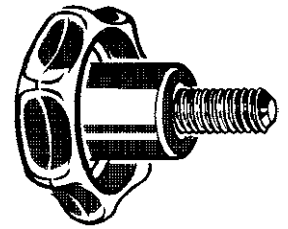

Technical Data

d_1	d_2	d_3	h	P
M5	25	12	16	0.8
M6	32	14	20	1
M8	40	16	25	1.25
M10	50	21	32	1.5

56922 Star grip type L

W03F

Thread	Metric thread
Material	Plastic Fenolformaldehyde (bakelite)
Class	FS31
Color	Black

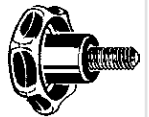

$d_1 \times L$	☒	Art.number	$d_1 \times L$	☒	Art.number	$d_1 \times L$	☒	Art.number
M5X15	10	56922.050.015	M8X15	10	56922.080.015	M10X15	5	56922.100.015
M5X20	10	56922.050.020	M8X20	10	56922.080.020	M10X20	5	56922.100.020
M6X15	10	56922.060.015	M8X25	10	56922.080.025	M10X25	5	56922.100.025
M6X20	10	56922.060.020	M8X30	10	56922.080.030	M10X30	5	56922.100.030
M6X25	10	56922.060.025	M8X40	10	56922.080.040	M10X35	5	56922.100.035
M6X30	10	56922.060.030	M8X50	10	56922.080.050			

- With steel zinc plated threaded end.

Star grip type K

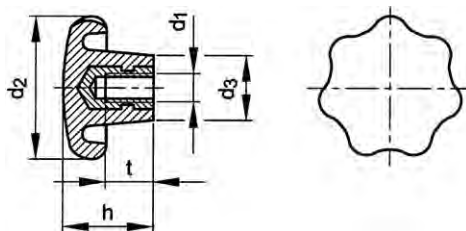

DIN ≈6336 K

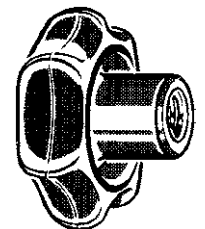

Technical Data

$d_1 \times d_2$	d_2	d_3	h	P	t
M4x20	20	10	17	0.7	8
M5x25	25	12	16	0.8	10.5
M5x32	32	14	20	0.8	10.5
M6x32	32	14	20	1	13.5
M6x40	40	16	25	1	13.5
M8x40	40	16	25	1.25	16
M8x50	50	21	32	1.25	16
M8x63	63	23	40	1.25	16
M10x50	50	21	32	1.5	21
M10x63	63	23	40	1.5	21
M12x50	50	21	32	1.75	21
M12x63	63	23	40	1.75	25
M12x80	80	34	48	1.75	25
M16x80	80	34	48	2	30

56921 Star grip type K		W03F	
Thread	Metric thread		
Material	Plastic Fenolformaldehyde (bakelite)		
Class	FS31		
Color	Black		



$d_1 \times d_2$	☒	Art.number	$d_1 \times d_2$	☒	Art.number	$d_1 \times d_2$	☒	Art.number
M4X20	10	56921.040.020	M8X40	10	56921.080.040	M12X50	5	56921.120.050
M5X25	10	56921.050.025	M8X50	10	56921.080.050	M12X63	5	56921.120.063
M5X32	10	56921.050.032	M8X63	10	56921.080.063	M12X80	5	56921.120.080
M6X32	10	56921.060.032	M10X50	5	56921.100.050	M16X80	5	56921.160.080
M6X40	10	56921.060.040	M10X63	5	56921.100.063			

- With steel zinc plated threaded bush, size M4 x 20 with a brass threaded bush.

Turning knob 4-grips

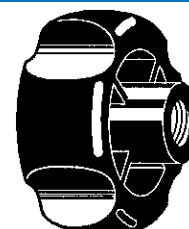
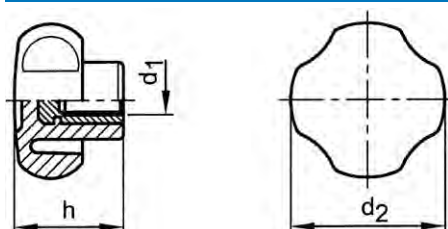

Technical Data

d_1	d_2	h	P	d_1	d_2	h	P
M4	20	13	0.7	M8	40	28	1.25
M5	20	13	0.8	M10	50	32	1.5
M6	25	15	1	M12	60	38	1.75

Article groups

Thread	Material	Color	Code	Page
M	GRP	Black	57040	12-79
M	GRP	through hole	57041	12-79
M	GRP	with threaded rod	57043	12-80

57040 Turning knob with brass threaded bush		W03A	
Thread	Metric thread		
Material	Glass-fibre reinforced plastic		
Color	Black		



d_1	☒	Art.number	d_1	☒	Art.number	d_1	☒	Art.number
M4	10	57040.040.001	M6	10	57040.060.001	M10	5	57040.100.001
M5	10	57040.050.001	M8	10	57040.080.001	M12	5	57040.120.001

57041 Turning knob through hole		W03A	
Thread	Metric thread		
Material	Glass-fibre reinforced plastic		
Color	Black		



d_1	☒	Art.number	d_1	☒	Art.number	d_1	☒	Art.number
M4	10	57041.040.001	M6	10	57041.060.001	M10	5	57041.100.001
M5	10	57041.050.001	M8	10	57041.080.001	M12	5	57041.120.001

57043	Turning knob with zinc plated threaded rod	W03A
Thread	Metric thread	
Material	Glass-fibre reinforced plastic	
Color	Black	

$d_1 \times L$	☒	Art.number	$d_1 \times L$	☒	Art.number	$d_1 \times L$	☒	Art.number
M4X10	10	57043.040.010	M6X15	10	57043.060.015	M10X30	5	57043.100.030
M5X16	10	57043.050.015	M8X30	10	57043.080.030	M12X50	5	57043.120.050

Turning knob 4-grips deep

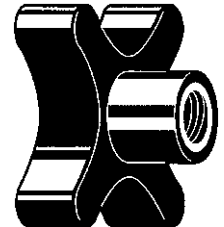
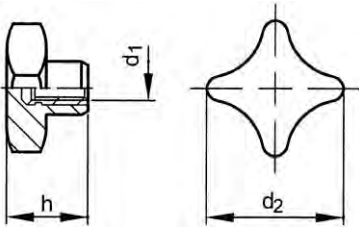

Technical Data

d_1	d_2	h	P	d_1	d_2	h	P
M6	40	24	1	M10	50	28.5	1.5
M8	40	24	1.25	M12	60	33	1.75

Article groups

Thread	Material	Color	Code	Page
M	GRP	Black	57045	12-80
M	GRP	with threaded rod	57046	12-80
M	GRP	through hole	57048	12-80

57045	Turning knob with brass threaded bush	W03A
Thread	Metric thread	
Material	Glass-fibre reinforced plastic	
Color	Black	

d_1	☒	Art.number	d_1	☒	Art.number	d_1	☒	Art.number
M6	10	57045.060.001	M10	5	57045.100.001	M12	5	57045.120.001
M8	10	57045.080.001						

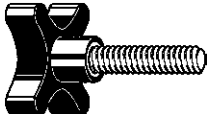
57046	Turning knob with steel plated threaded rod	W03A
Thread	Metric thread	
Material	Glass-fibre reinforced plastic	
Color	Black	

$d_1 \times L$	☒	Art.number	$d_1 \times L$	☒	Art.number	$d_1 \times L$	☒	Art.number
M6X20	10	57046.060.020	M10X40	5	57046.100.040	M12X50	5	57046.120.050
M8X30	10	57046.080.030						

57048	Turning knob through hole with brass threaded bush	W03A
Thread	Metric thread	
Material	Glass-fibre reinforced plastic	
Color	Black	

d_1	☒	Art.number	d_1	☒	Art.number	d_1	☒	Art.number
M6	10	57048.060.001	M10	5	57048.100.001	M12	5	57048.120.001
M8	10	57048.080.001						

Disc knob

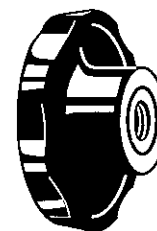
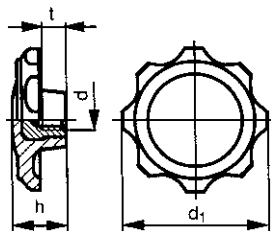

Technical Data

d x d ₁ x h	P	d x d ₁ x h	P
M5x30x20	0.8	M8x40x24	1.25
M6x30x20	1	M8x50x16	1.25
M6x30x24	1	M10x50x28.5	1.5
M6x40x14.5	1	M10x70x20	1.5
M6x40x24	1	M12x60x33	1.75

Article groups

Thread	Material		Color	Code	Page
M	GRP		Black	57090	12-81
M	GRP	through hole	Black	57091	12-81
M	GRP	with threaded rod	Black	57092	12-81
M	GRP		Black	57011	12-82
M	GRP	with threaded rod	Black	57012	12-82

57090 Disc knob with brass threaded bush

W03A

Thread	Metric thread
Material	Glass-fibre reinforced plastic
Color	Black



d x d ₁ x h	☒	Art.number	d x d ₁ x h	☒	Art.number	d x d ₁ x h	☒	Art.number
M6X30X24	10	57090.060.001	M10X50X28.5	5	57090.100.001	M12X60X33	5	57090.120.001
M8X40X24	10	57090.080.001						

57091 Disc knob through hole

W03A

Thread	Metric thread
Material	Glass-fibre reinforced plastic
Color	Black



d x d ₁ x h	☒	Art.number	d x d ₁ x h	☒	Art.number	d x d ₁ x h	☒	Art.number
M6X40X24	10	57091.060.001	M10X50X28,5	5	57091.100.001	M12X60X33	5	57091.120.001
M8X40X24	10	57091.080.001						

57092 Disc knob with zinc plated threaded rod

W03A

Thread	Metric thread
Material	Glass-fibre reinforced plastic
Color	Black

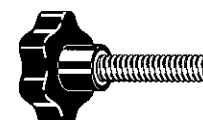

d x L	☒	Art.number	d x L	☒	Art.number	d x L	☒	Art.number
M6X20	10	57092.060.020	M10X30	5	57092.100.030	M12X50	5	57092.120.050
M8X30	10	57092.080.030						

57011	Disc knob with stainless steel A1 threaded bush	W03A
Thread	Metric thread	
Material	Glass-fibre reinforced plastic	
Color	Black	

d x d₁ x h	☒	Art.number	d x d₁ x h	☒	Art.number	d x d₁ x h	☒	Art.number
M5X30X20	10	57011.050.001	M8X40X24	10	57011.080.001	M12X60X33	5	57011.120.001
M6X30X20	10	57011.060.001	M10X50X28.5	5	57011.100.001			

57012	Disc knob with stainless steel A2 threaded rod	W03A
Thread	Metric thread	
Material	Glass-fibre reinforced plastic	
Color	Black	

d x L	☒	Art.number	d x L	☒	Art.number	d x L	☒	Art.number
M5X15	10	57012.050.015	M8X20	10	57012.080.020	M12X40	5	57012.120.040
M6X20	10	57012.060.020	M10X30	5	57012.100.030			

Triangular star knob

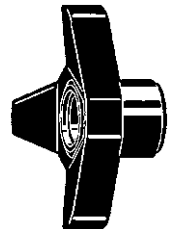
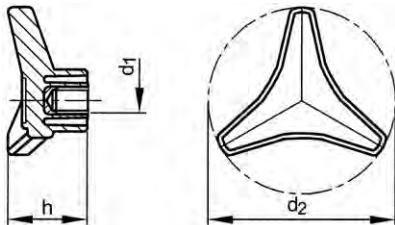

Technical Data

d₁	d₂	h	P	d₁	d₂	h	P
M8	85	36	1.25	M12	105	45	1.75
M10	85	36	1.5	M14	105	45	2

Article groups

Thread	Material	Color	Code	Page
M	GRP	Black	57020	12-82
M	GRP	with threaded rod	57021	12-82
M	GRP	through hole	57023	12-83

57020	Triangular star knob with brass threaded bush	W03A
Thread	Metric thread	
Material	Glass-fibre reinforced plastic	
Color	Black	

d₁	☒	Art.number	d₁	☒	Art.number	d₁	☒	Art.number
M8	10	57020.080.001	M12	5	57020.120.001	M14	5	57020.140.001
M10	10	57020.100.001						

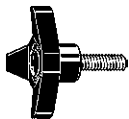
57021	Triangular star knob with zinc plated threaded rod	W03A
Thread	Metric thread	
Material	Glass-fibre reinforced plastic	
Color	Black	

d₁ x L	☒	Art.number	d₁ x L	☒	Art.number	d₁ x L	☒	Art.number
M8X30	10	57021.080.030	M12X50	5	57021.120.050	M14X50	5	57021.140.050
M10X40	10	57021.100.040						

57023	Triangular star knob through hole with brass threaded bush			W03A
Thread	Metric thread			
Material	Glass-fibre reinforced plastic			
Color	Black			



d_1	☒	Art.number	d_1	☒	Art.number	d_1	☒	Art.number
M8	10	57023.080.001	M12	5	57023.120.001	M14	5	57023.140.001
M10	10	57023.100.001						

Five lobe grip

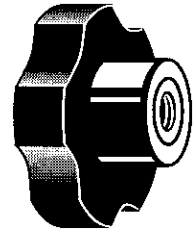
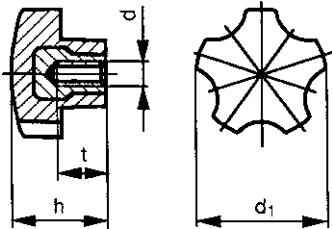

Technical Data							
d	d_1	h	P	d	d_1	h	P
M5	32	22.4	0.8	M8	40	28	1.25
M6	32	22.4	1	M10	40	28	1.5

56970	Five lobe grip			W03A
Thread	Metric thread			
Material	Plastic Fenolformaldehyde (bakelite)			
Class	FS31			
Color	Black			



$d \times t$	☒	Art.number	$d \times t$	☒	Art.number	$d \times t$	☒	Art.number
M5X10	10	56970.050.010	M8X14	10	56970.080.014	M10X14	5	56970.100.014
M6X9	10	56970.060.009						

- With brass threaded bush, sizes M8 x 14 and M10 x 14 with steel zinc plated threaded bush.

Knurled knob for hexagon bolts and nuts

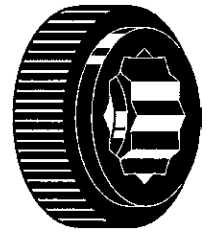
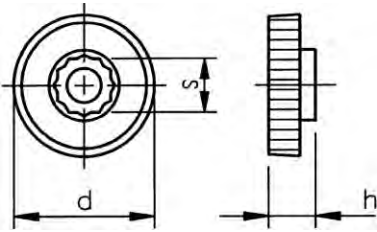

Technical Data

For use with x d	d	s	For use with x d	d	s
M4x13	13	7	M6x25	25	10
M4x17	17	7	M8x25	25	13
M5x17	17	8	M8x36	36	13
M5x20	20	8	M10x36	36	17
M6x20	20	10			

Article groups

Thread	Material		Color	Code	Page
M	Plastic POM	thin	Black	56730	12-84
M	Plastic POM	high	Black	56735	12-84

56730 Thin knurled knob for hexagon bolts and nuts

W02A

Thread	Metric thread
Material	Plastic Polyoxymethylene
Color	Black



For use with x d x h	Art.number	For use with x d x h	Art.number	For use with x d x h	Art.number
M4X13x4,5	100 56730.040.013	M5X20x6,5	100 56730.050.020	M8X25x8	100 56730.080.025
M4X17x5,5	100 56730.040.017	M6X20x6,5	100 56730.060.020	M8X36x10	100 56730.080.036
M5X17x5,5	100 56730.050.017	M6X25x8	100 56730.060.025	M10X36x10	100 56730.100.036

56735 High knurled knob for hexagon bolts and nuts

W02A

Thread	Metric thread
Material	Plastic Polyoxymethylene
Color	Black

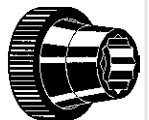

For use with x d x h	Art.number	For use with x d x h	Art.number	For use with x d x h	Art.number
M4X13x9,5	100 56735.040.013	M5X20x15	100 56735.050.020	M8X25x18	100 56735.080.025
M4X17x11,5	100 56735.040.017	M6X20x15	100 56735.060.020	M8X36x23	100 56735.080.036
M5X17x11,5	100 56735.050.017	M6X25x18	100 56735.060.025	M10X36x23	100 56735.100.036

Knurled knob for hexagon socket head cap screw

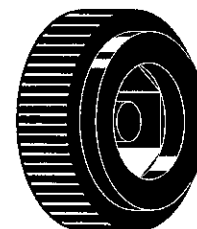
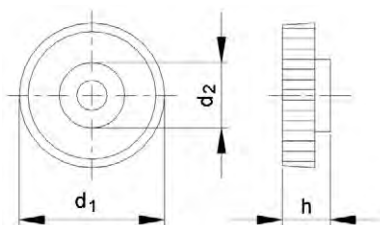

Technical Data

For use with x d ₁	d ₁	d ₂	h	For use with x d ₁	d ₁	d ₂	h
M3x11	11	5.5	4.5	M6x20	20	10	7.5
M4x13	13	7	5.5	M6x25	25	10	7.5
M4x17	17	7	5.5	M8x25	25	13	9.5
M5x17	17	8.5	6.5	M8x36	36	13	9.5
M5x20	20	8.5	6.5	M10x36	36	16	12

56740 Knurled knob for hexagon socket head cap screw

W02A

Thread Metric thread
Material Plastic Polyoxymethylene
Color Black



For use with x d ₁	☒	Art.number	For use with x d ₁	☒	Art.number	For use with x d ₁	☒	Art.number
M3X11	100	56740.030.011	M5X20	100	56740.050.020	M8X25	100	56740.080.025
M4X13	100	56740.040.013	M6X20	100	56740.060.020	M8X36	100	56740.080.036
M4X17	100	56740.040.017	M6X25	100	56740.060.025	M10X36	100	56740.100.036
M5X17	100	56740.050.017						

Knurled knob

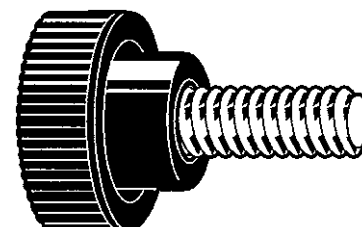
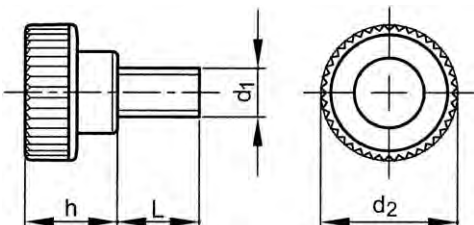

Technical Data

d ₁	d ₂	h	P	d ₁	d ₂	h	P
M5	21	15	0.8	M8	26	18	1.25
M6	21	15	1	M10	33	23	1.5

Article groups

Thread	Material	Color	Code	Page
M	GRP	with threaded rod	Black 57025	12-85
M	GRP	with threaded bush	Black 57027	12-86
M	GRP	through hole with threaded bush	Black 57028	12-86

57025 Knurled knob with steel zinc plated threaded rod

W03A

Thread Metric thread
Material Glass-fibre reinforced plastic
Color Black

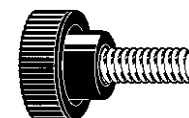

d ₁ x L	☒	Art.number	d ₁ x L	☒	Art.number	d ₁ x L	☒	Art.number
M5X15	10	57025.050.015	M8X25	10	57025.080.025	M10X30	5	57025.100.030
M6X20	10	57025.060.020						

57027	Knurled knob with brass threaded bush				W03A	
Thread	Metric thread					
Material	Glass-fibre reinforced plastic					
Color	Black					

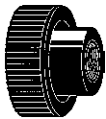

d₁	☒	Art.number	d₁	☒	Art.number	d₁	☒	Art.number
M5	10	57027.050.001	M8	10	57027.080.001	M10	5	57027.100.001
M6	10	57027.060.001						

57028	Knurled knob through hole with brass threaded bush				W03A	
Thread	Metric thread					
Material	Glass-fibre reinforced plastic					
Color	Black					



d₁	☒	Art.number	d₁	☒	Art.number	d₁	☒	Art.number
M5	10	57028.050.001	M8	10	57028.080.001	M10	5	57028.100.001
M6	10	57028.060.001						

Knurled knob with zinc plated threaded rod

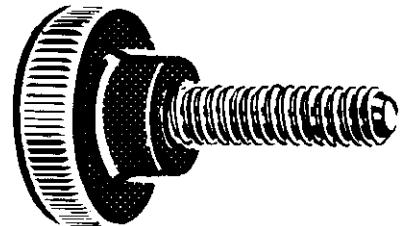
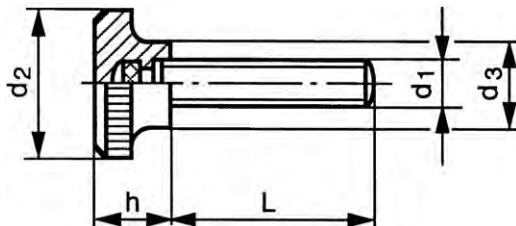

Technical Data

Type	d ₁	d ₂	d ₃	h	P
700	M5	18	10	12	0.8
710	M6	22	12	13	1
711	M8	26	15	13	1.25

56931	Knurled knob with zinc plated threaded rod				W03F	
Thread	Metric thread					
Material	Plastic Fenolformaldehyde (bakelite)					
Class	FS31					
Color	Black					

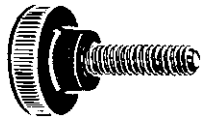

Type-d₁ x L	☒	Art.number	Type-d₁ x L	☒	Art.number	Type-d₁ x L	☒	Art.number
700-M5X20	10	56931.050.020	710-M6X30	10	56931.060.030	711-M8X30	10	56931.080.030
700-M5X30	10	56931.050.030	711-M8X20	10	56931.080.020	711-M8X40	10	56931.080.040
710-M6X20	10	56931.060.020						

• Depending on availability the threaded end can be supplied zinc plated as well as zinc plated, yellow passivated.

Knurled knob

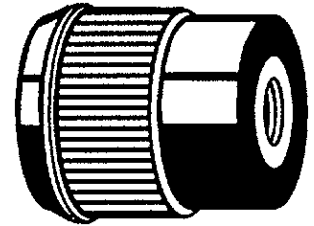
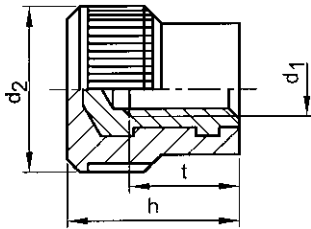

Technical Data

d ₁	d ₂	h	P
M3	12	13.5	0.5
M4	12	13.5	0.7
M5	15	15.5	0.8
M6	15	15.5	1

56972 Knurled knob with brass threaded bush

W03A

Thread	Metric thread
Material	Plastic Fenolformaldehide (bakelite)
Class	FS31
Color	Black

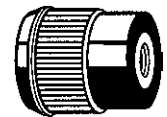

d ₁ x t	⊠	Art.number	d ₁ x t	⊠	Art.number	d ₁ x t	⊠	Art.number
M3X6,5	25	56972.030.006	M5X10	10	56972.050.010	M6X9	10	56972.060.009
M4X10	25	56972.040.010						

Wing grip

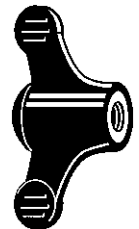
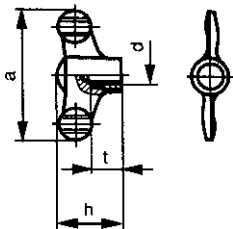

Technical Data

d	a	h	P	t
M5	50	24	0.8	10
M6	50	24	1	10
M8	75	35	1.25	14
M10	75	35	1.5	14

56966 Wing grip

W03A

Thread	Metric thread
Material	Plastic Polyamide (nylon)
Class	6
Color	Black



d	⊠	Art.number	d	⊠	Art.number	d	⊠	Art.number
M5	10	56966.050.001	M8	5	56966.080.001	M10	5	56966.100.001
M6	10	56966.060.001						

- With steel zinc plated, yellow passivated threaded bush.

Wing nut

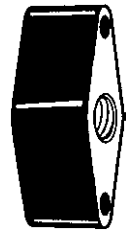
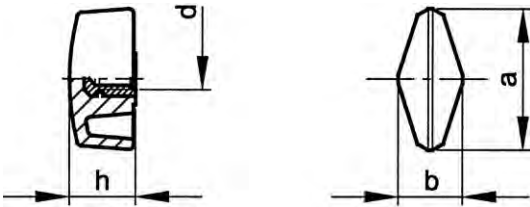

Technical Data

d	a	b	h	P
M5	33	15	16.5	0.8
M6	33	15	16.5	1
M8	33	15	16.5	1.25
M10	45	19	17	1.5

57051 Wing nut with brass threaded bush

W03A

Thread Metric thread
Material Glass-fibre reinforced plastic
Color Black



d	☒	Art.number	d	☒	Art.number	d	☒	Art.number
M5	10	57051.050.001	M8	10	57051.080.001	M10	5	57051.100.001
M6	10	57051.060.001						

- The shape of size M10 deviates.

Wing screw

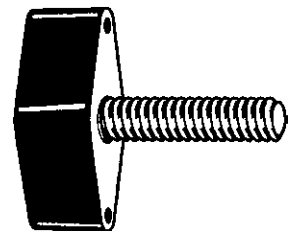
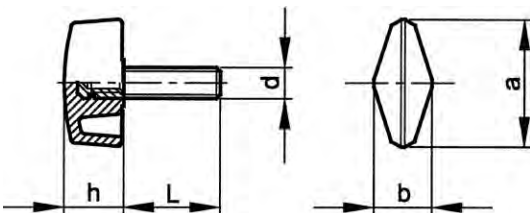

Technical Data

d	a	b	h	P
M5	33	15	16.5	0.8
M6	33	15	16.5	1
M8	33	15	16.5	1.25
M10	45	19	17	1.5

57050 Wing screw with zinc plated threaded Rod

W03A

Thread Metric thread
Material Glass-fibre reinforced plastic
Color Black

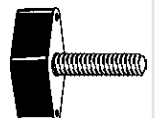

d x L	☒	Art.number	d x L	☒	Art.number	d x L	☒	Art.number
M5X15	10	57050.050.015	M8X25	10	57050.080.025	M10X30	5	57050.100.030
M6X20	10	57050.060.020						

- The shape of size M10 deviates.

T-grip

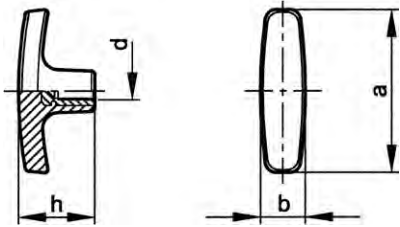

Technical Data

d	a	b	h	P
M5	50	15	24	0.8
M6	60	17	33	1
M8	60	17	33	1.25
M10	72	18	35	1.5

Article groups

Thread	Material		Color	Code	Page
M	GRP	with threaded bush	Black	57053	12-89
M	GRP	with threaded Rod	Black	57054	12-89

57053 T-grip with brass threaded bush

W03A

Thread	Metric thread
Material	Glass-fibre reinforced plastic
Color	Black



d	☒	Art.number	d	☒	Art.number	d	☒	Art.number
M5	10	57053.050.001	M8	10	57053.080.001	M10	5	57053.100.001
M6	10	57053.060.001						

57054 T-grip with steel zinc plated threaded Rod

W03A

Thread	Metric thread
Material	Glass-fibre reinforced plastic
Color	Black



d x L	☒	Art.number	d x L	☒	Art.number	d x L	☒	Art.number
M5X20	10	57054.050.020	M8X20	10	57054.080.020	M10X30	5	57054.100.030
M6X20	10	57054.060.020						

Bridge handle (Bowgrip) with threaded bushes

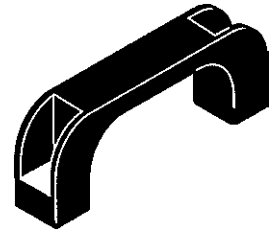
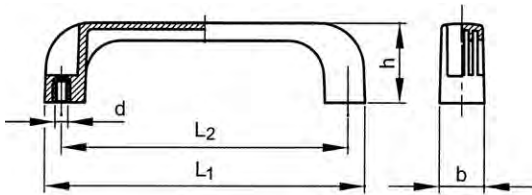

Technical Data

d x L ₁	b	h	L ₂	P
M5x110	21	37	94	0.8
M6x139	24	40	120	1
M6x151	26	43	132	1
M8x200	28	50	180	1.25
M10x260	32	53	235	1.5

57067 Bridge handle (Bowgrip) with threaded bushes

W03A

Thread Metric thread
Material Glass-fibre reinforced plastic

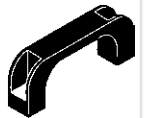

d x L ₁	☒	Art.number	d x L ₁	☒	Art.number	d x L ₁	☒	Art.number
M5X110	5	57067.050.110	M6X151	5	57067.060.151	M10X260	2	57067.100.260
M6X139	5	57067.060.139	M8X200	2	57067.080.200			

Bridge handle (Bowgrip)

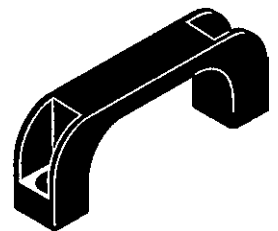
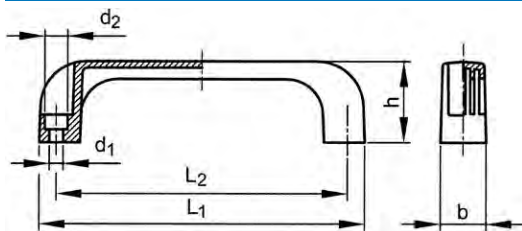

Technical Data

d ₁ x L ₁	b	d ₂	h	L ₂
6.5x110	21	11	37	94
6.5x139	24	14	40	120
8.5x151	26	14	43	132
8.5x200	28	14.5	50	180
10.5x260	32	17	53	235

57066 Bridge handle (Bowgrip)

W03A

Material Glass-fibre reinforced plastic
Color Black



d ₁ x L ₁	☒	Art.number	d ₁ x L ₁	☒	Art.number	d ₁ x L ₁	☒	Art.number
6,5X110MM	5	57066.065.110	8,5X151MM	5	57066.085.151	10,5X260MM	2	57066.105.260
6,5X139MM	5	57066.065.139	8,5X200MM	2	57066.085.200			

Solid bridge handle (Bowgrip)

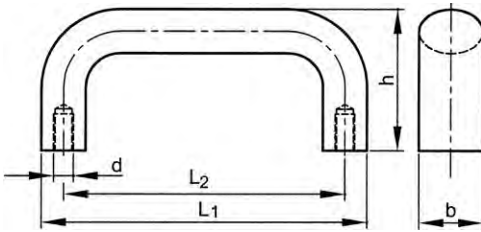

Technical Data

d x L ₁	b	h	L ₂	P
M5x106.5	20	40.5	94	0.8
M6x134	25	50	117	1
M6x148	25	50	132	1
M8x168	29	58	150	1.25
M8x197	29	58	179	1.25

57014 Solid bridge handle (Bowgrip) with brass threaded bushes

W03A

Thread Metric thread
Material Glass-fibre reinforced plastic
Color Black



d x L ₁	☒	Art.number	d x L ₁	☒	Art.number	d x L ₁	☒	Art.number
M5X106	5	57014.050.106	M6X148	5	57014.060.148	M8X197	2	57014.080.197
M6X134	5	57014.060.134	M8X168	2	57014.080.168			

Tubular bridge handle (Bowgrip)

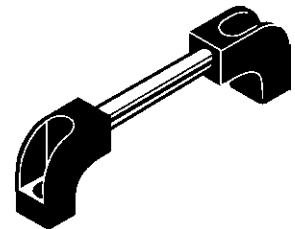
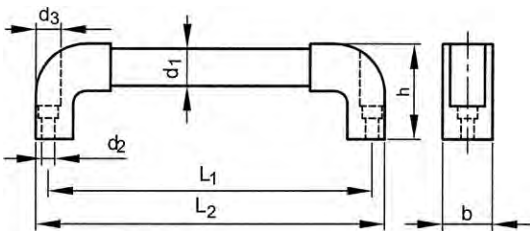

Technical Data

d ₁ x L ₁	b	d ₂	d ₃	h	L ₂
20x200	30	8.5	14	62	220
20x250	30	8.5	14	62	270
20x300	30	8.5	14	62	320
30x350	40	10.5	16	77	374
30x400	40	10.5	16	77	424
30x500	40	10.5	16	77	524

57015 Tubular bridge handle (Bowgrip)

W03A

Material Glass-fibre reinforced plastic
Color Black

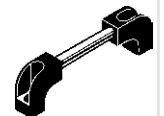

d ₁ x L ₁	☒	Art.number	d ₁ x L ₁	☒	Art.number	d ₁ x L ₁	☒	Art.number
20X200MM	2	57015.020.200	20X300MM	2	57015.020.300	30X400MM	2	57015.030.400
20X250MM	2	57015.020.250	30X350MM	2	57015.030.350	30X500MM	2	57015.030.500

- With anodised aluminium tube handle.

Handle

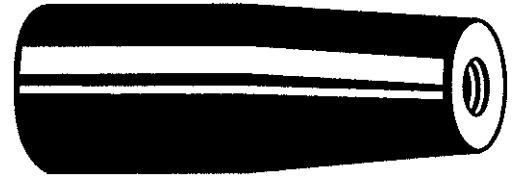
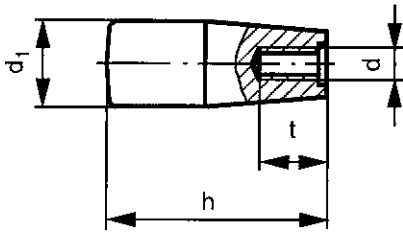

Technical Data

d	d ₁	h	P
M6	17	45	1
M8	17	45	1.25
M10	28	70	1.5

56955	Handle	W03A
Thread	Metric thread	
Material	Plastic Fenolformaldehyde (bakelite)	
Class	FS31	
Color	Black	



d x t	⊗	Art.number	d x t	⊗	Art.number	d x t	⊗	Art.number
M6X14	10	56955.060.014	M8X16	10	56955.080.016	M10X28	5	56955.100.028

Handle

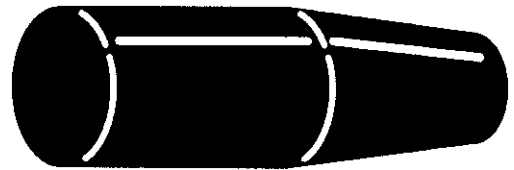
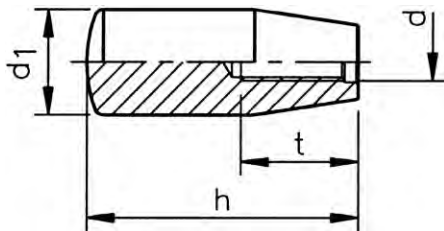

Technical Data

d	d ₁	h	P	t
M5	18	40	0.8	20
M6	20	50	1	20
M8	23	60	1.25	27
M10	27	80	1.5	34
M12	29	90	1.75	42

57030	Handle	W03A
Thread	Metric thread	
Material	Glass-fibre reinforced plastic	
Color	Black	



d	⊗	Art.number	d	⊗	Art.number	d	⊗	Art.number
M5	10	57030.050.001	M8	10	57030.080.001	M12	5	57030.120.001
M6	10	57030.060.001	M10	5	57030.100.001			

Spinner handle

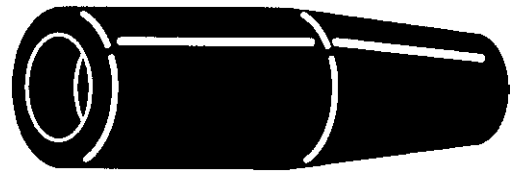
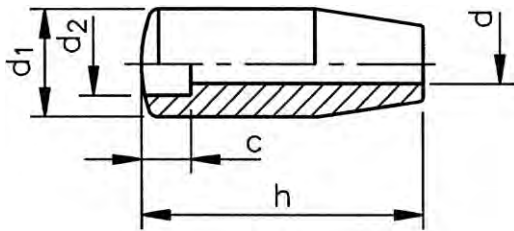

Technical Data

d	c	d ₁	d ₂	h
6.5	6.5	20	10.5	50
8.5	8.5	23	13.5	60
10.5	10.5	27	16.5	80
12.5	12.5	29	19.5	90

57031 Spinner handle

W03A

Material Glass-fibre reinforced plastic
Color Black



d	☒	Art.number	d	☒	Art.number	d	☒	Art.number
6,5MM	10	57031.065.001	10,5MM	5	57031.105.001	12,5MM	5	57031.125.001
8,5MM	10	57031.085.001						

Handle not revolvable

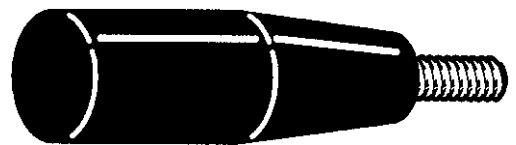
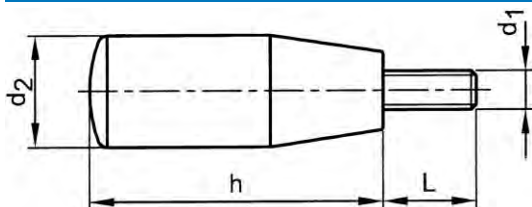

Technical Data

d ₁	d ₂	h	P	d ₁	d ₂	h	P
M6	20	50	1	M10	27	80	1.5
M8	23	60	1.25	M12	29	90	1.75

57033 Handle with steel zinc plated not revolvable threaded rod

W03A

Thread Metric thread
Material Glass-fibre reinforced plastic
Color Black



d ₁ x L	☒	Art.number	d ₁ x L	☒	Art.number	d ₁ x L	☒	Art.number
M6X20	10	57033.060.020	M10X30	5	57033.100.030	M12X30	5	57033.120.030
M8X30	10	57033.080.030						

Handle revolvable

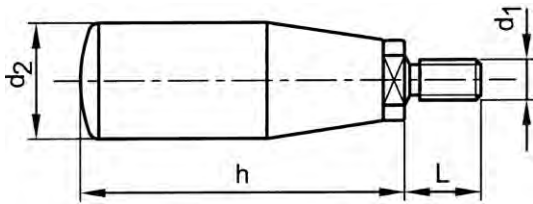

Technical Data

$d_1 \times h$	d_2	L	P	$d_1 \times h$	d_2	L	P
M6x55	20	12	1	M10x100	30	16	1.5
M8x67	23	15	1.25	M12x97	29	15	1.75
M8x73	23	12	1.25	M12x104	31	23	1.75
M10x87	25	15	1.5				

Article groups

Thread	Material	Class	Color	Code	Page
M	Plastic PF	FS31	Black	56988	12-94
M	GRP		Black	57035	12-94

56988	Handle revolvable	W03F
Thread	Metric thread	
Material	Plastic Fenolformaldehyde (bakelite)	
Class	FS31	
Color	Black	



$d_1 \times h$	☒	Art.number	$d_1 \times h$	☒	Art.number	$d_1 \times h$	☒	Art.number
M8x73	10	56988.080.001	M10x100	5	56988.100.001	M12x104	5	56988.120.001

- With steel zinc plated revolvable threaded rod.

57035	Handle revolvable	W03A
Thread	Metric thread	
Material	Glass-fibre reinforced plastic	
Color	Black	



$d_1 \times h$	☒	Art.number	$d_1 \times h$	☒	Art.number	$d_1 \times h$	☒	Art.number
M6x55	10	57035.060.001	M10x87	5	57035.100.001	M12x97	5	57035.120.001
M8x67	10	57035.080.001						

- With steel zinc plated revolvable threaded rod.

Handle revolvable

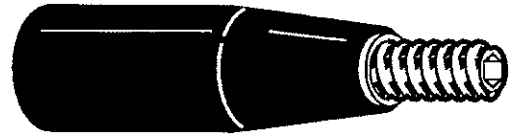
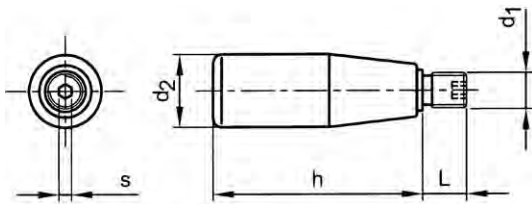

Technical Data

d_1	d_2	h	L	P	s
M6	23	62	15	1	4
M8	23	62	15	1.25	4
M10	26	82	15	1.5	5
M12	26	82	15	1.75	5

57049 Handle revolvable

W03A

Thread Metric thread
Material Glass-fibre reinforced plastic
Color Black



d_1	☒	Art.number	d_1	☒	Art.number	d_1	☒	Art.number
M6	10	57049.060.001	M10	5	57049.100.001	M12	5	57049.120.001
M8	10	57049.080.001						

- With steel zinc plated revolvable threaded rod with hexagon socket.

Foldaway handle revolvable

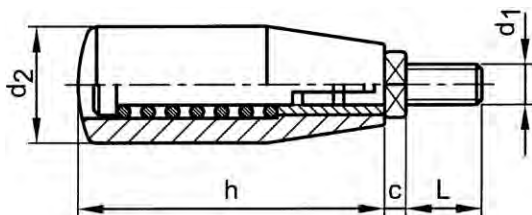

Technical Data

d_1	c	d_2	h	L	P
M6	6	20	50	9	1
M8	6.5	25	78	16	1.25
M10	7.5	25	82	17	1.5

57037 Foldaway handle revolvable

W03A

Thread Metric thread
Material Glass-fibre reinforced plastic
Color Black



d_1	☒	Art.number	d_1	☒	Art.number	d_1	☒	Art.number
M6	10	57037.060.001	M8	10	57037.080.001	M10	5	57037.100.001

- With steel zinc plated revolvable threaded rod.
- The shape of size M10 deviates.

Crank handle with handle

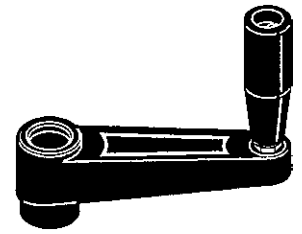
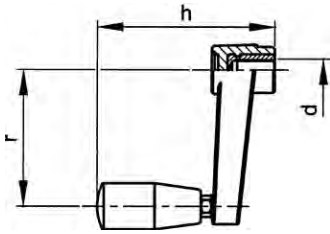

Technical Data

d	h	P	r	d	h	P	r
M8	86	1.25	65	M14	127	2	140
M10	87	1.5	80	M16	141	2	185
M12	105	1.75	110				

57063 Crank handle with handle with brass threaded bush

W03A

Thread Metric thread
Material Glass-fibre reinforced plastic
Color Black

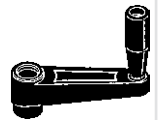

d	☒	Art.number	d	☒	Art.number	d	☒	Art.number
M8	2	57063.080.001	M12	2	57063.120.001	M16	1	57063.160.001
M10	2	57063.100.001	M14	1	57063.140.001			

Crank handle with foldaway handle

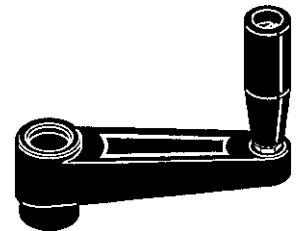
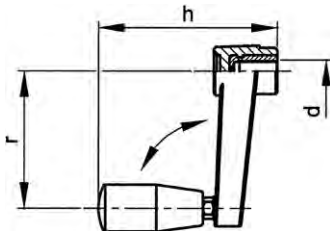

Technical Data

d	h	P	r	d	h	P	r
M8	86	1.25	65	M14	137	2	140
M10	87	1.5	80	M16	151	2	185
M12	115	1.75	110				

57064 Crank handle with foldaway handle with brass threaded bush

W03A

Thread Metric thread
Material Glass-fibre reinforced plastic
Color Black

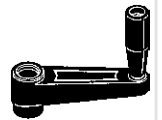

d	☒	Art.number	d	☒	Art.number	d	☒	Art.number
M8	2	57064.080.001	M12	2	57064.120.001	M16	1	57064.160.001
M10	2	57064.100.001	M14	1	57064.140.001			

Gear lever handle with ball knob

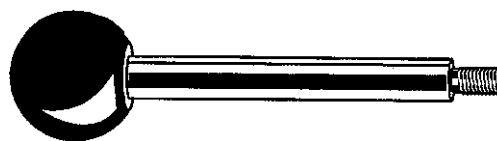
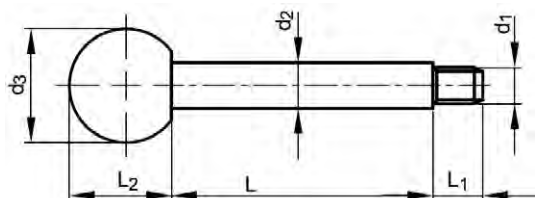

Technical Data

d ₁	d ₂	d ₃	L ₁	L ₂	P
M6	8	20	9	18	1
M8	10	25	13	22.5	1.25
M10	12	32	15	29	1.5

57003 Gear lever handle with ball knob type A

W03A

Thread Metric thread
Material Free-cutting steel



d ₁ x L	☒	Art.number	d ₁ x L	☒	Art.number	d ₁ x L	☒	Art.number
M6X65	5	57003.060.065	M8X80	5	57003.080.080	M10X80	5	57003.100.080

- With plastic (FS31) ball knob.

Flat tension lever liftable

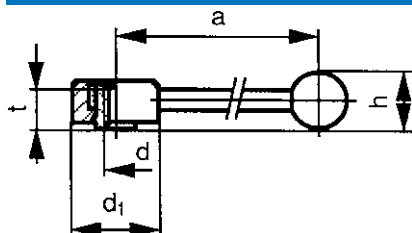

Technical Data

d ₁ x a	a	d ₂	h	P
M8x97	97	33	25	1.25
M8x102	102	33	25	1.25
M10x118	118	41	32	1.5
M10x130	130	41	30	1.5
M12x118	11	41	8	1.75
M12x130	130	41	30	1.75
M16x143	143	45	32	2
M16x148	148	45	37	2

- With black plastic (FS31) ball knob.

Article groups

Thread	Material	Code	Page
M	Free-cutting steel	56958	12-98
M	Free-cutting steel with threaded rod	56959	12-98

56958 Flat tension lever liftable

W03A

Thread Metric thread
Material Free-cutting steel



d ₁ x a x L	☒	Art.number	d ₁ x a x L	☒	Art.number	d ₁ x a x L	☒	Art.number
M8x97x18	3	56958.080.018	M12x118x21	3	56958.120.021	M16x143x27	2	56958.160.027
M10x118x21	3	56958.100.021						

56959	Flat tension lever liftable with threaded rod	W03A
Thread	Metric thread	
Material	Free-cutting steel	

$d_1 \times a \times L$	☒	Art.number	$d_1 \times a \times L$	☒	Art.number	$d_1 \times a \times L$	☒	Art.number
M8x102x30	3	56959.080.030	M12x130x40	2	56959.120.040	M16x148x40	2	56959.160.040
M10x130x30	3	56959.100.030						

Tension lever liftable

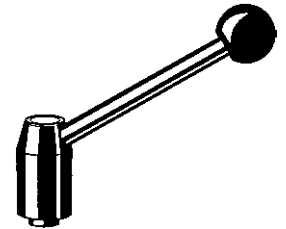
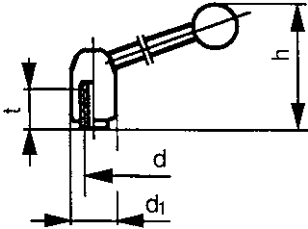

Technical Data

d	a	d_2	h	P
M8	87	24	70.5	1.25
M10	87	24	70.5	1.5
M12	106	28	84	1.75
M16	128	33	96	2

- With black plastic (FS31) ball knob.

Article groups

Thread	Material	Code	Page
M	Free-cutting steel	56956	12-98
M	Free-cutting steel with threaded rod	56957	12-98

56956	Tension lever liftable	W03A
Thread	Metric thread	
Material	Free-cutting steel	

$d \times t$	☒	Art.number	$d \times t$	☒	Art.number	$d \times t$	☒	Art.number
M8X14	3	56956.080.023	M12X17	2	56956.120.026	M16X23	1	56956.160.030
M10X14	3	56956.100.023						

56957	Tension lever liftable with threaded rod	W03A
Thread	Metric thread	
Material	Free-cutting steel	

$d \times L$	☒	Art.number	$d \times L$	☒	Art.number	$d \times L$	☒	Art.number
M8X30	3	56957.080.030	M12X40	2	56957.120.040	M16X50	1	56957.160.050
M10X30	3	56957.100.030						

Clamp lever steel

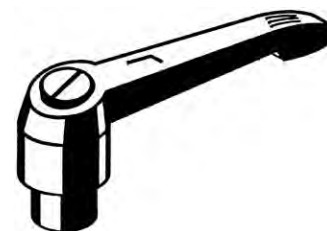
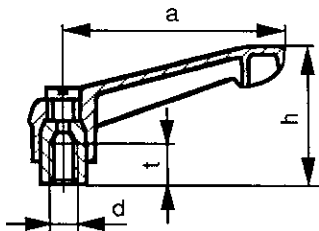

Technical Data

d	a	h	P	d	a	h	P
M4	30	30	0.7	M10	65	42.5	1.5
M5	40	31	0.8	M12	95	63	1.75
M6	40	31	1	M16	110	73	2
M8	65	42.5	1.25				

Article groups

Thread	Material	Class		Color	Code	Page
M	Free-cutting steel		with threaded bush	Black	56960	12-99
M	Free-cutting steel			Black	56961	12-99
M	GRP	6.6	with threaded bush	Black	56964	12-100
M	GRP	6.6		Black	56965	12-100
M	GRP	6.6	with threaded bush	Orange	56973	12-100
M	GRP	6.6		Orange	56974	12-100

56960 Clamp lever steel

W03A

Thread	Metric thread
Material	Free-cutting steel
Color	Black



d x t	☒	Art.number	d x t	☒	Art.number	d x t	☒	Art.number
M4X9	5	56960.040.009	M8X12	5	56960.080.012	M12X17	3	56960.120.017
M5X9	5	56960.050.009	M10X14	3	56960.100.014	M16X23	1	56960.160.023
M6X9	5	56960.060.009						

- Free cutting steel with threaded bush and handle of pressure die-cast zinc (acc. to DIN 1743) colour black.

56961 Clamp lever steel

W03A

Thread	Metric thread
Material	Free-cutting steel
Color	Black

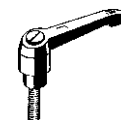

d x L	☒	Art.number	d x L	☒	Art.number	d x L	☒	Art.number
M5X30	5	56961.050.030	M8X40	5	56961.080.040	M12X50	3	56961.120.050
M6X30	5	56961.060.030	M10X50	3	56961.100.050	M16X60	1	56961.160.060

- Free cutting steel with threaded end and handle of pressure die-cast zinc (acc. to DIN 1743) colour black.

56964 Clamp lever steel

W03A

Thread	Metric thread
Material	Glass-fibre reinforced plastic
Class	6.6
Color	Black



d x t	☒	Art.number	d x t	☒	Art.number	d x t	☒	Art.number
M4X9	10	56964.040.009	M8X12	5	56964.080.012	M12X17	3	56964.120.017
M5X9	10	56964.050.009	M10X14	3	56964.100.014	M16X23	1	56964.160.023
M6X9	10	56964.060.009						

- With glass-fibre reinforced knob and a steel threaded bush
- Colour black RAL 7021

56965		Clamp lever steel				W03A	
Thread	Metric thread						
Material	Glass-fibre reinforced plastic						
Class	6.6						
Color	Black						



d x L	☒	Art.number	d x L	☒	Art.number	d x L	☒	Art.number
M5X30	5	56965.050.030	M8X40	5	56965.080.040	M12X50	3	56965.120.050
M6X30	5	56965.060.030	M10X50	3	56965.100.050	M16X60	1	56965.160.060

- With glass-fibre reinforced knob and a steel threaded rod.
- Colour black RAL 7021.

56973		Clamp lever steel				W03A	
Thread	Metric thread						
Material	Glass-fibre reinforced plastic						
Class	6.6						
Color	Orange						



d x t	☒	Art.number	d x t	☒	Art.number	d x t	☒	Art.number
M4X9	10	56973.040.009	M8X12	5	56973.080.012	M12X17	3	56973.120.017
M5X9	10	56973.050.009	M10X14	3	56973.100.014	M16X23	1	56973.160.023
M6X9	10	56973.060.009						

- With glass-fibre reinforced knob and a steel threaded bush
- Orange = RAL 2004

56974		Clamp lever steel				W03A	
Thread	Metric thread						
Material	Glass-fibre reinforced plastic						
Class	6.6						
Color	Orange						



d x L	☒	Art.number	d x L	☒	Art.number	d x L	☒	Art.number
M5X30	5	56974.050.030	M8X40	5	56974.080.040	M12X50	3	56974.120.050
M6X30	5	56974.060.030	M10X50	3	56974.100.050	M16X60	1	56974.160.060

- With glass-fibre reinforced knob and a steel threaded rod.
- Colour orange = RAL 2004.

Clamp lever liftable steel

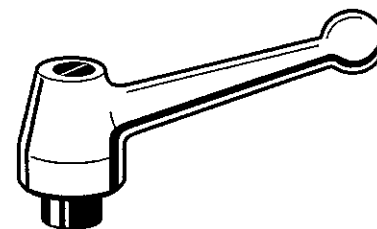
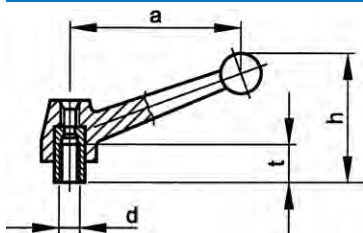

Technical Data

d	a	h	P
M8	83	64	1.25
M10	83	64	1.5
M12	108	81.5	1.75
M16	132	93	2

Article groups

Thread	Material	Color	Code	Page
M	Forged steel C35	Grey	57004	12-101
M	Forged steel C35 with threaded bush	Grey	57005	12-101

57004 Clamp lever liftable steel				W03A
Thread	Metric thread			
Material	Forged steel C35			
Color	Grey			

d x L	⊠	Art.number	d x L	⊠	Art.number	d x L	⊠	Art.number
M10X30	2	57004.100.030	M12X40	2	57004.120.040	M16X50	1	57004.160.050

- With steel class 5.8 threaded rod.

57005 Steel clamp lever liftable with threaded bush				W03A
Thread	Metric thread			
Material	Forged steel C35			
Color	Grey			

d x t	⊠	Art.number	d x t	⊠	Art.number	d x t	⊠	Art.number
M8X17	2	57005.080.017	M12X23	2	57005.120.023	M16X27	1	57005.160.027
M10X17	2	57005.100.017						

- With steel class 5.8 threaded bush.

Clamp lever liftable

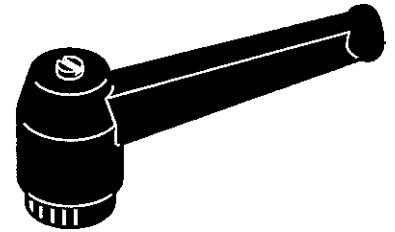
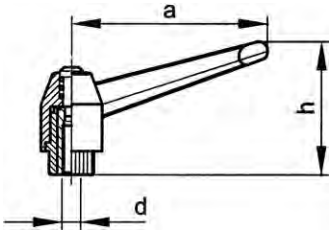

Technical Data

d	a	h	P	d	a	h	P
M4	43	35	0.7	M10	83	57	1.5
M5	43	35	0.8	M12	104	70	1.75
M6	43	35	1	M16	104	70	2
M8	65	46	1.25				

Article groups

Thread	Material	Color	Code	Page
M	GRP	Black	57070	12-102
M	GRP with threaded rod	Black	57071	12-102

57070	Clamp lever liftable with zinc plated threaded bush	W03A
Thread	Metric thread	
Material	Glass-fibre reinforced plastic	
Color	Black	



d	☒	Art.number	d	☒	Art.number	d	☒	Art.number
M4	10	57070.040.001	M8	10	57070.080.001	M12	5	57070.120.001
M5	10	57070.050.001	M10	5	57070.100.001	M16	5	57070.160.001
M6	10	57070.060.001						

57071	Clamp lever liftable with zinc plated threaded rod	W03A
Thread	Metric thread	
Material	Glass-fibre reinforced plastic	
Color	Black	



d x L	☒	Art.number	d x L	☒	Art.number	d x L	☒	Art.number
M4X15	10	57071.040.015	M8X30	10	57071.080.030	M12X50	5	57071.120.050
M5X20	10	57071.050.020	M10X40	5	57071.100.040	M16X50	5	57071.160.050
M6X25	10	57071.060.025						

Clamp lever firm high

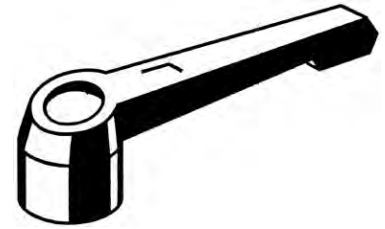
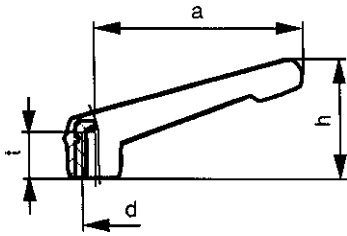

Technical Data

d	a	h	P	d	a	h	P
M4	40	27	0.7	M10	80	45	1.5
M5	40	27	0.8	M12	95	54	1.75
M6	40	27	1	M16	110	63	2
M8	65	36.5	1.25				

56971 Clamp lever firm high

W03A

Thread	Metric thread
Material	Plastic Polyamide (nylon)
Class	PA 6.6
Color	Black



d x t	Art.number	d x t	Art.number	d x t	Art.number
M4X11	10 56971.040.011	M8X12	5 56971.080.012	M12X20	3 56971.120.020
M5X11	10 56971.050.011	M10X16	3 56971.100.016	M16X24	1 56971.160.024
M6X11	10 56971.060.011				

- With a steel zinc plated, yellow passivated threaded bush.

Clamp lever firm

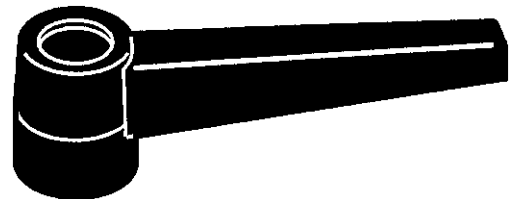
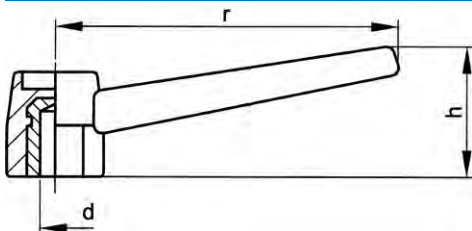

Technical Data

d	h	P	r	d	h	P	r
M5	21	0.8	43	M8	26	1.25	68
M6	21	1	43	M10	39	1.5	83

Article groups

Thread	Material	Color	Code	Page
M	GRP	Black	57076	12-103
M	GRP	with threaded rod	57077	12-104

57076 Clamp lever firm with brass threaded bush

W03A

Thread	Metric thread
Material	Glass-fibre reinforced plastic
Color	Black



d	Art.number	d	Art.number	d	Art.number
M5	10 57076.050.001	M8	10 57076.080.001	M10	5 57076.100.001
M6	10 57076.060.001				

57077	Clamp lever firm with zinc plated threaded rod		W03A
Thread	Metric thread		
Material	Glass-fibre reinforced plastic		
Color	Black		

d x L	☒	Art.number	d x L	☒	Art.number	d x L	☒	Art.number
M5X20	10	57077.050.020	M8X30	10	57077.080.030	M10X40	5	57077.100.040
M6X20	10	57077.060.020						

Handwheel with ripple ring

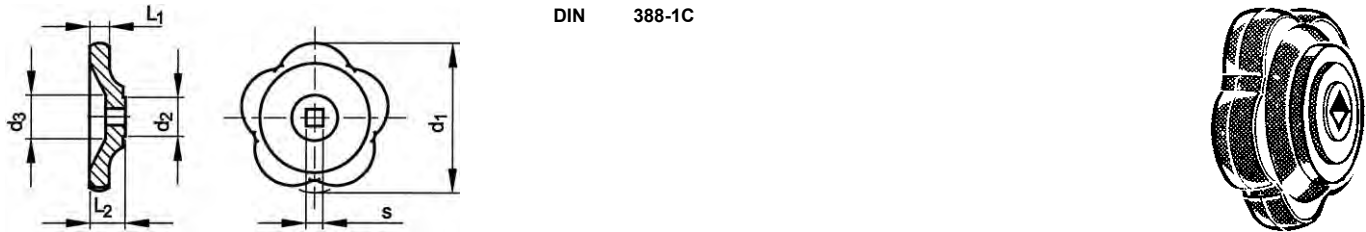

Technical Data

s (H11) x d ₁	d ₂	d ₃	L ₁	L ₂	s (H11) x d ₁	d ₂	d ₃	L ₁	L ₂
5x50 (#DIN)	22	21	10	18	7x80 (#DIN)	28	30	12	22
5x63 (#DIN)	22	24	11	20	8x63 (#DIN)	22	24	11	20
6x50 (#DIN)	22	22	10	18	8x80	28	28	12	22
6x63 (#DIN)	22	24	11	20	9x100	28	30	14	25
7x63	22	24	11	20					

56901	Handwheel with ripple ring		W03F
Material	Plastic Fenolformaldehyde (bakelite)		
Class	FS31		
Color	Black		

s x d ₁	☒	Art.number	s x d ₁	☒	Art.number	s x d ₁	☒	Art.number
5X50MM	10	56901.050.050	6X63MM	10	56901.060.063	8X63MM	10	56901.080.063
5X63MM	10	56901.050.063	7X63MM	10	56901.070.063	8X80MM	10	56901.080.080
6X50MM	10	56901.060.050	7X80MM	10	56901.070.080	9X100MM	5	56901.090.100

Handwheel AL

DIN 950

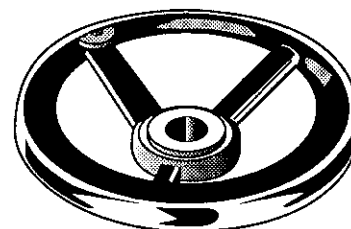
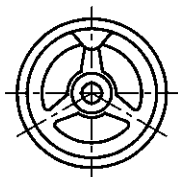
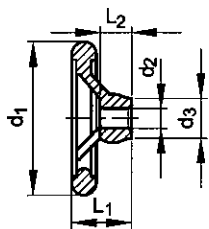

Technical Data

d_2 (H7) x d_1	d_3	$L_1 \approx$	L_2	Spokes
10x80	24	29	16	3
10x100	26	36	18	3
12x125	28	36	18	3
14x140	30	39	19	3
16x160	32	40	20	3
18x180 (≠DIN)	35	43	22	3
20x200 (≠DIN)	38	45	24	3
20x225 (≠DIN)	42	48	26	5
24x250 (≠DIN)	45	50	28	5
24x280 (≠DIN)	50	53	30	5
26x315	53	56	33	5
28x360 (≠DIN)	60	59	35	5
30x400	65	63	38	5
34x500	78	72	45	5

56940 Handwheel type A4

W03F

Material Aluminium



d_2 x d_1	☒	Art.number	d_2 x d_1	☒	Art.number	d_2 x d_1	☒	Art.number
10X80MM 3-SPOKES	1	56940.100.080	18X180MM 3-SPOKES	1	56940.180.001	26X315MM 5-SPOKES	1	56940.315.001
10X100MM 3-SPOKES	1	56940.100.100	20X200MM 3-SPOKES	1	56940.200.001	28X360MM 5-SPOKES	1	56940.360.001
12X125MM 3-SPOKES	1	56940.120.125	20X225MM 5-SPOKES	1	56940.225.001	30X400MM 5-SPOKES	1	56940.400.001
14X140MM 3-SPOKES	1	56940.140.140	24X250MM 5-SPOKES	1	56940.250.001	34X500MM 5-SPOKES	1	56940.500.001
16X160MM 3-SPOKES	1	56940.160.001	24X280MM 5-SPOKES	1	56940.280.001			

Handwheel two spokes

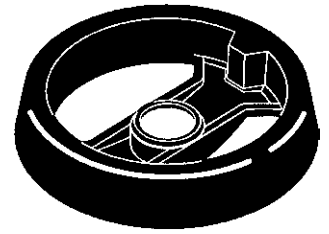
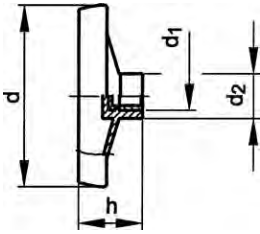

Technical Data

d	d ₁ (H7)	d ₂	h	d	d ₁ (H7)	d ₂	h
80	8	24	34	164	14	40	56
100	10	28	42	200	16	50	61
130	12	32	50	255	20	56	71

57060 Handwheel two spokes

W03A

Material Glass-fibre reinforced plastic
Color Black



d	☒	Art.number	d	☒	Art.number	d	☒	Art.number
80MM	2	57060.080.001	130MM	2	57060.130.001	200MM	1	57060.200.001
100MM	2	57060.100.001	164MM	2	57060.160.001	255MM	1	57060.250.001

- With steel zinc plated insert.

Handwheel with foldaway handle two spokes

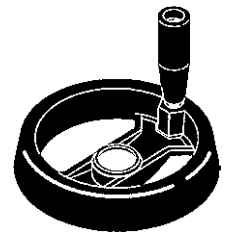
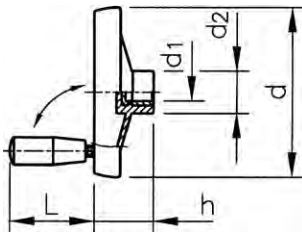

Technical Data

d	d ₁ (H7)	d ₂	h	L	d	d ₁ (H7)	d ₂	h	L
80	8	24	34	56	164	14	40	56	76
100	10	28	43	56	200	16	50	61	76
130	12	32	50	76	255	20	56	71	98

57061 Handwheel with foldaway handle two spokes

W03A

Material Glass-fibre reinforced plastic
Color Black



d	☒	Art.number	d	☒	Art.number	d	☒	Art.number
80MM	2	57061.080.001	130MM	2	57061.130.001	200MM	1	57061.200.001
100MM	2	57061.100.001	164MM	2	57061.160.001	255MM	1	57061.250.001

- With steel zinc plated insert.

Handwheel solid

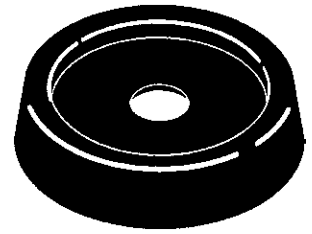
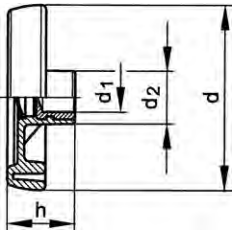

Technical Data

d	d ₁	d ₂	h	d	d ₁	d ₂	h
80	8	25	33	150	14	38	54
100	10	30	39	173	16	40	57
126	125	36	44	203	18	44	59

57080 Handwheel solid		W03A
Material	Glass-fibre reinforced plastic	
Color	Black	

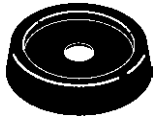

d	☒	Art.number	d	☒	Art.number	d	☒	Art.number
80MM	2	57080.080.001	126MM	2	57080.125.001	173MM	1	57080.175.001
100MM	2	57080.100.001	150MM	2	57080.150.001	203MM	1	57080.200.001

- With steel zinc plated insert.

Handwheel with handle solid

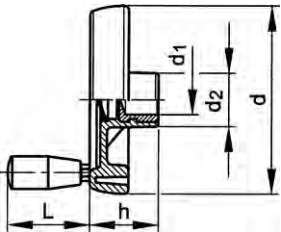

Technical Data

d	d ₁	d ₂	h	L	d	d ₁	d ₂	h	L
80	8	24	33	55	150	14	38	53	76
100	10	30	39	55	173	16	40	56	86
126	12	36	44	66	203	18	44	59	86

57081 Handwheel with handle solid		W03A
Material	Glass-fibre reinforced plastic	
Color	Black	



d	☒	Art.number	d	☒	Art.number	d	☒	Art.number
80MM	2	57081.080.001	126MM	2	57081.125.001	173MM	1	57081.175.001
100MM	2	57081.100.001	150MM	2	57081.150.001	203MM	1	57081.200.001

- With steel zinc plated insert.

Handwheel with foldaway handle solid

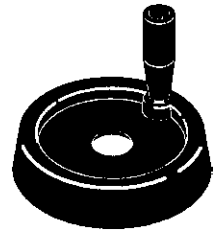
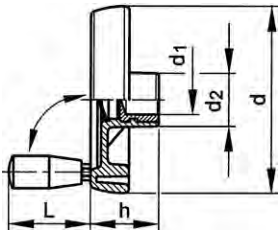

Technical Data

d	d ₁	d ₂	h	L
80	8	24	33	55
100	10	30	39	55
126	12	36	44	76

57083 Handwheel with foldaway handle solid

W03A

Material Glass-fibre reinforced plastic
Color Black



d	☒	Art.number	d	☒	Art.number	d	☒	Art.number
80MM	2	57083.080.001	100MM	2	57083.100.001	126MM	2	57083.125.001

- With steel zinc plated insert.

Handwheel with recessable foldaway handle solid

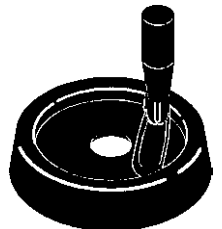
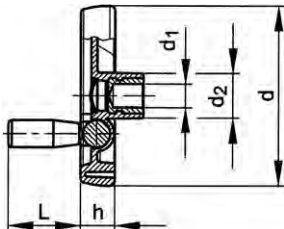

Technical Data

d	d ₁ (H7)	d ₂	h	L	d	d ₁ (H7)	d ₂	h	L
80	8	24	33	39	150	14	38	53	60
100	10	30	42	49	175	16	40	58	80
125	12	36	47	58	200	18	44	63	90

57084 Handwheel with recessable foldaway handle solid

W03A

Material Glass-fibre reinforced plastic
Color Black



d	☒	Art.number	d	☒	Art.number	d	☒	Art.number
80MM	2	57084.080.001	125MM	2	57084.125.001	175MM	1	57084.175.001
100MM	2	57084.100.001	150MM	2	57084.150.001	200MM	1	57084.200.001

- With steel zinc plated insert.

Handwheel with fold-away handle

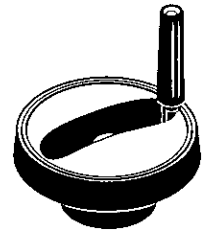
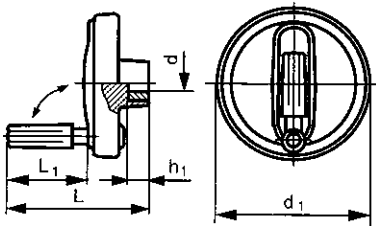

Technical Data

d (H7) x d ₁	h ₁	L	L ₁	d (H7) x d ₁	h ₁	L	L ₁
8x80	13	75	40	12x125	18.5	109	59.9
10x100	13	90	49	14x160	18.5	144	83.5

56954 Handwheel with fold-away handle

W03A

Material Thermoplastic Polyamide (nylon)
Class 6
Color Black



d x d ₁	☒	Art.number	d x d ₁	☒	Art.number	d x d ₁	☒	Art.number
8X80MM	1	56954.080.080	12X125MM	1	56954.120.125	14X160MM	1	56954.140.160
10X100MM	1	56954.100.100						

- With a steel insert.

FABORY Technical balls

Standardisation

FABORY technical balls are acc. to DIN 5401-1 and 5401-2 equal to ISO 3290 standardized. Not standardized FABORY technical balls are acc. to the highest qualities.

Stock

FABORY technical balls are available from stock in many diameters, tolerances and hardnesses in following materials: chrome steel, carbon steel, forged steel, stainless steel, plastic, glass etc.

Specials

Special products are available on request.

Applications

FABORY technical balls are e.g. applicable for cylindrical lockings, ballpoints, cigar lighters, drawer guidances, spray guns, forged railings and -fencings, video recorders and for grinding, bearings, sealings, deburring and polishing.

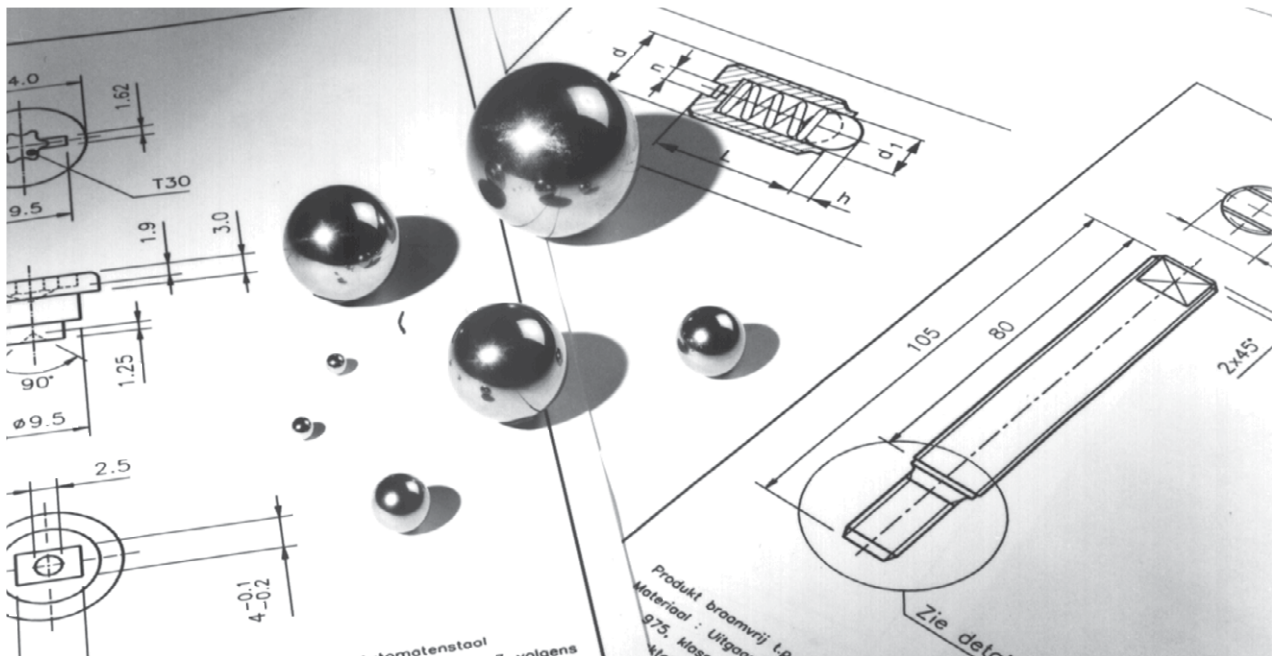

Technical ball

DIN ≈5401
ISO 3290

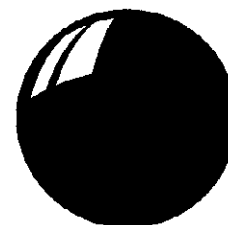

Article groups

Material	Class		Code	Page
Chrome steel HRc 60-67	G20	packed per piece	66813	12-111
Chrome steel HRc 60-67	G28	packed per piece	66816	12-111
Chrome steel HRc 60-67	G40	packed per piece	66819	12-112
Carbon steel unhardened HRc 25		packed per piece	66860	12-112
St.St. AISI304 not hardened HRc 25-29		packed per piece	66910	12-112
St.St. AISI316 not hardened HRc 25-29		packed per piece	66920	12-112
St.St. AISI420 hardened HRC 52-55	G100	packed per piece	66930	12-112

66813 Technical ball		S50A
Material Class	Chrome steel HRc 60-67 G20	

d	⊗	Art.number	d	⊗	Art.number	d	⊗	Art.number
1,000MM	1	66813.001.000	6,747MM	1	66813.006.747	15,081MM	1	66813.015.081
1,500MM	1	66813.001.500	7,000MM	1	66813.007.000	15,875MM	1	66813.015.875
1,588MM	1	66813.001.588	7,144MM	1	66813.007.144	16,000MM	1	66813.016.000
1,984MM	1	66813.001.984	7,938MM	1	66813.007.938	16,669MM	1	66813.016.669
2,000MM	1	66813.002.000	8,000MM	1	66813.008.000	17,000MM	1	66813.017.000
2,381MM	1	66813.002.381	8,500MM	1	66813.008.500	17,462MM	1	66813.017.462
2,500MM	1	66813.002.500	8,731MM	1	66813.008.731	18,000MM	1	66813.018.000
2,778MM	1	66813.002.778	9,000MM	1	66813.009.000	18,256MM	1	66813.018.256
3,000MM	1	66813.003.000	9,525MM	1	66813.009.525	19,050MM	1	66813.019.050
3,175MM	1	66813.003.175	10,000MM	1	66813.010.000	19,844MM	1	66813.019.844
3,500MM	1	66813.003.500	10,319MM	1	66813.010.319	20,000MM	1	66813.020.000
3,969MM	1	66813.003.969	11,000MM	1	66813.011.000	20,637MM	1	66813.020.637
4,000MM	1	66813.004.000	11,112MM	1	66813.011.112	21,000MM	1	66813.021.000
4,500MM	1	66813.004.500	11,906MM	1	66813.011.906	21,431MM	1	66813.021.431
4,762MM	1	66813.004.762	12,000MM	1	66813.012.000	22,000MM	1	66813.022.000
5,000MM	1	66813.005.000	12,700MM	1	66813.012.700	22,225MM	1	66813.022.225
5,500MM	1	66813.005.500	13,000MM	1	66813.013.000	23,000MM	1	66813.023.000
5,556MM	1	66813.005.556	13,494MM	1	66813.013.494	23,019MM	1	66813.023.019
6,000MM	1	66813.006.000	14,000MM	1	66813.014.000	24,000MM	1	66813.024.000
6,350MM	1	66813.006.350	14,287MM	1	66813.014.287	24,606MM	1	66813.024.606
6,500MM	1	66813.006.500	15,000MM	1	66813.015.000	25,000MM	1	66813.025.000

66816 Technical ball		S50A
Material Class	Chrome steel HRc 60-67 G28	

d	⊗	Art.number	d	⊗	Art.number	d	⊗	Art.number
25,400MM	1	66816.025.400	31,750MM	1	66816.031.750	41,275MM	1	66816.041.275
26,000MM	1	66816.026.000	33,337MM	1	66816.033.337	42,863MM	1	66816.042.863
26,988MM	1	66816.026.988	34,925MM	1	66816.034.925	44,450MM	1	66816.044.450
28,000MM	1	66816.028.000	35,000MM	1	66816.035.000	45,000MM	1	66816.045.000
28,575MM	1	66816.028.575	36,512MM	1	66816.036.512	46,038MM	1	66816.046.038
30,000MM	1	66816.030.000	38,100MM	1	66816.038.100	47,625MM	1	66816.047.625
30,162MM	1	66816.030.162	40,000MM	1	66816.040.000	50,000MM	1	66816.050.000

66819	Technical ball						S50A	
Material Class	Chrome steel HRc 60-67 G40							

d	☒	Art.number	d	☒	Art.number	d	☒	Art.number
50,800MM	1	66819.050.800	63,500MM	1	66819.063.500	80,000MM	1	66819.080.000
52,500MM	1	66819.052.500	69,850MM	1	66819.069.850	100,000MM	1	66819.100.000
60,000MM	1	66819.060.000	70,000MM	1	66819.070.000			

66860	Technical ball						S51A	
Material	Carbon steel unhardened HRc 25							

d	☒	Art.number	d	☒	Art.number	d	☒	Art.number
7,144MM	1	66860.007.144	9,525MM	1	66860.009.525	15,875MM	1	66860.015.875

66910	Technical ball						S52A	
Material	Stainless steel AISI304 not hardened HRc 25-29							

d	☒	Art.number	d	☒	Art.number	d	☒	Art.number
2,500MM	1	66910.002.500	6,000MM	1	66910.006.000	10,000MM	1	66910.010.000
3,969MM	1	66910.003.969	6,350MM	1	66910.006.350	12,000MM	1	66910.012.000
4,000MM	1	66910.004.000	8,000MM	1	66910.008.000			

66920	Technical ball						S52A	
Material	Stainless steel AISI316 not hardened HRc 25-29							

d	☒	Art.number	d	☒	Art.number	d	☒	Art.number
1,000MM	1	66920.001.000	6,000MM	1	66920.006.000	12,700MM	1	66920.012.700
2,000MM	1	66920.002.000	6,350MM	1	66920.006.350	14,000MM	1	66920.014.000
2,381MM	1	66920.002.381	7,144MM	1	66920.007.144	15,875MM	1	66920.015.875
2,500MM	1	66920.002.500	7,938MM	1	66920.007.938	19,050MM	1	66920.019.050
3,000MM	1	66920.003.000	8,000MM	1	66920.008.000	20,000MM	1	66920.020.000
3,175MM	1	66920.003.175	9,525MM	1	66920.009.525	25,000MM	1	66920.025.000
3,969MM	1	66920.003.969	10,000MM	1	66920.010.000	25,400MM	1	66920.025.400
4,000MM	1	66920.004.000	11,112MM	1	66920.011.112			
4,762MM	1	66920.004.762	12,000MM	1	66920.012.000			

66930	Technical ball						S52A	
Material Class	Stainless steel AISI420 hardened HRc 52-55 G100							

d	☒	Art.number	d	☒	Art.number	d	☒	Art.number
1,000MM	1	66930.001.000	4,762MM	1	66930.004.762	9,525MM	1	66930.009.525
1,500MM	1	66930.001.500	5,000MM	1	66930.005.000	10,000MM	1	66930.010.000
2,000MM	1	66930.002.000	5,556MM	1	66930.005.556	11,112MM	1	66930.011.112
2,381MM	1	66930.002.381	6,000MM	1	66930.006.000	12,000MM	1	66930.012.000
2,500MM	1	66930.002.500	6,350MM	1	66930.006.350	12,700MM	1	66930.012.700
3,000MM	1	66930.003.000	7,000MM	1	66930.007.000	13,000MM	1	66930.013.000
3,175MM	1	66930.003.175	7,144MM	1	66930.007.144	14,000MM	1	66930.014.000
3,500MM	1	66930.003.500	7,938MM	1	66930.007.938	14,287MM	1	66930.014.287
3,969MM	1	66930.003.969	8,000MM	1	66930.008.000	15,000MM	1	66930.015.000
4,000MM	1	66930.004.000	8,731MM	1	66930.008.731	15,875MM	1	66930.015.875
4,500MM	1	66930.004.500	9,000MM	1	66930.009.000	16,000MM	1	66930.016.000

66930		Technical ball							
d	⊗	Art.number	d	⊗	Art.number	d	⊗	Art.number	
18,000MM	1	66930.018.000	25,000MM	1	66930.025.000	40,000MM	1	66930.040.000	
19,050MM	1	66930.019.050	25,400MM	1	66930.025.400	50,000MM	1	66930.050.000	
20,000MM	1	66930.020.000	30,000MM	1	66930.030.000	60,000MM	1	66930.060.000	
22,000MM	1	66930.022.000	30,162MM	1	66930.030.162				
22,225MM	1	66930.022.225	34,925MM	1	66930.034.925				

Technical ball not according to standards

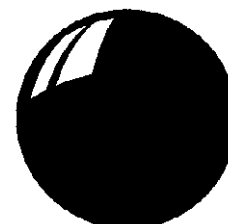

Article groups				
Material	Class	Color	Code	Page
Plastic PP		packed per piece	66950	12-113
Plastic PA	PA 6.6	packed per piece	Natural	66955
Plastic POM		packed per piece	White	66960
Plastic PTFE		packed per piece	White	66970
Glass		packed per piece	66990	12-114

66950 Technical ball not according to standards S54A

Material	Plastic Polypropylene				
-----------------	-----------------------	--	--	--	---

d	⊗	Art.number	d	⊗	Art.number	d	⊗	Art.number
2,000MM	1	66950.002.000	6,500MM	1	66950.006.500	15,875MM	1	66950.015.875
2,381MM	1	66950.002.381	7,000MM	1	66950.007.000	16,000MM	1	66950.016.000
2,500MM	1	66950.002.500	7,938MM	1	66950.007.938	17,000MM	1	66950.017.000
3,000MM	1	66950.003.000	8,000MM	1	66950.008.000	18,000MM	1	66950.018.000
3,175MM	1	66950.003.175	9,000MM	1	66950.009.000	19,000MM	1	66950.019.000
3,500MM	1	66950.003.500	9,525MM	1	66950.009.525	20,000MM	1	66950.020.000
3,969MM	1	66950.003.969	10,000MM	1	66950.010.000	22,000MM	1	66950.022.000
4,000MM	1	66950.004.000	11,000MM	1	66950.011.000	25,000MM	1	66950.025.000
4,500MM	1	66950.004.500	12,000MM	1	66950.012.000	25,400MM	1	66950.025.400
5,000MM	1	66950.005.000	13,000MM	1	66950.013.000	30,000MM	1	66950.030.000
6,000MM	1	66950.006.000	14,000MM	1	66950.014.000	35,000MM	1	66950.035.000
6,350MM	1	66950.006.350	15,000MM	1	66950.015.000	38,000MM	1	66950.038.000

Depending on the size, the colors of these balls may vary, between green, grey and natural.

66955 Technical ball not according to standards S54A

Material	Plastic Polyamide (nylon)				
Class	PA 6.6				
Color	Natural				

d	⊗	Art.number	d	⊗	Art.number	d	⊗	Art.number
2,000MM	1	66955.002.000	5,000MM	1	66955.005.000	13,000MM	1	66955.013.000
2,381MM	1	66955.002.381	6,000MM	1	66955.006.000	14,000MM	1	66955.014.000
2,500MM	1	66955.002.500	6,350MM	1	66955.006.350	15,000MM	1	66955.015.000
3,000MM	1	66955.003.000	7,000MM	1	66955.007.000	18,000MM	1	66955.018.000
3,175MM	1	66955.003.175	8,000MM	1	66955.008.000	20,000MM	1	66955.020.000
3,500MM	1	66955.003.500	10,000MM	1	66955.010.000	30,000MM	1	66955.030.000
3,969MM	1	66955.003.969	11,112MM	1	66955.011.112			
4,000MM	1	66955.004.000	12,700MM	1	66955.012.700			

66960		Technical ball not according to standards		S54A	
Material	Plastic Polyoxymethylene				
Color	White				
					

d	☒	Art.number	d	☒	Art.number	d	☒	Art.number
2,000MM	1	66960.002.000	6,350MM	1	66960.006.350	13,000MM	1	66960.013.000
2,500MM	1	66960.002.500	6,500MM	1	66960.006.500	14,000MM	1	66960.014.000
3,000MM	1	66960.003.000	8,000MM	1	66960.008.000	15,000MM	1	66960.015.000
3,175MM	1	66960.003.175	9,000MM	1	66960.009.000	15,875MM	1	66960.015.875
3,500MM	1	66960.003.500	10,000MM	1	66960.010.000	16,000MM	1	66960.016.000
4,000MM	1	66960.004.000	11,000MM	1	66960.011.000	19,000MM	1	66960.019.000
5,000MM	1	66960.005.000	12,000MM	1	66960.012.000	20,000MM	1	66960.020.000
6,000MM	1	66960.006.000						

66970		Technical ball not according to standards		S54A	
Material	Plastic Polytetrafluorethene				
Color	White				
					

d	☒	Art.number	d	☒	Art.number	d	☒	Art.number
2,000MM	1	66970.002.000	5,000MM	1	66970.005.000	12,700MM	1	66970.012.700
2,500MM	1	66970.002.500	8,000MM	1	66970.008.000	15,000MM	1	66970.015.000
3,000MM	1	66970.003.000	10,000MM	1	66970.010.000	16,000MM	1	66970.016.000
3,175MM	1	66970.003.175	12,000MM	1	66970.012.000	20,000MM	1	66970.020.000
4,000MM	1	66970.004.000						

66990		Technical ball not according to standards		S54A	
Material	Glass				
					

d	☒	Art.number	d	☒	Art.number	d	☒	Art.number
3,000MM	1	66990.003.000	5,000MM	1	66990.005.000	10,000MM	1	66990.010.000

Grommet

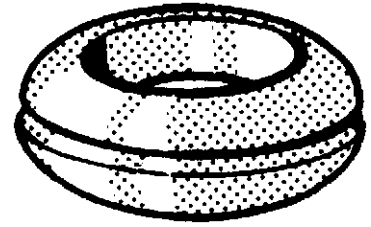
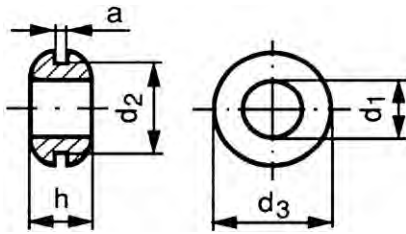

Technical Data

$d_1 \times d_2$	a	d_3	h	$d_1 \times d_2$	a	d_3	h
3.2x4.75	1.6	8	6.4	12.5x17.5	1.6	22	6.4
4.0x6.4	1.6	9.5	6.3	12.5x20	1.6	25.5	6.4
4.75x9.5	1.6	12.5	7	14.2x17.5	1.6	22	4.8
4.8x9.5	1.6	12.5	6.8	15.5x20	1.6	24	7.5
5.5x8	1.6	11	5.5	16.0x19	1.6	24	6
6.4x9.5	1.6	14.2	6.4	16.0x20	1.6	24	7.5
8.0x9.5	1.6	14.2	8	17.5x19	1.6	24	4.8
8.0x11	1.6	14.2	4.8	18.5x25.2	1.6	31.4	8
8.0x12.5	1.6	16	6.4	22.0x25.5	1.6	30	8
9.5x12.5	1.6	17	7	24.7x32	1.6	38	7.8
9.5x14.2	1.6	19	6.4	32.0x38	1.6	46	9.5
11.0x12.5	1.6	19	6.4	45.0x50	1.6	60	10

- Specific features of grommets:
- Protect electric wire in sheet iron.
- Excellent insulation.
- Strong and safe.
- Reducing vibration.

38900 Grommet

W05D

Material Plastic Polyvinylchloride
Color Black

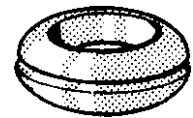

$d_1 \times d_2$	☒	Art.number	$d_1 \times d_2$	☒	Art.number	$d_1 \times d_2$	☒	Art.number
3,2X4,75MM	100	38900.032.047	9,5X12,5MM	100	38900.095.125	16,0X20,0MM	50	38900.160.200
4,0X6,4MM	100	38900.040.064	9,5X14,2MM	100	38900.095.142	17,5X19,0MM	50	38900.175.190
4,8X9,5MM	100	38900.048.095	11,0X12,5MM	100	38900.110.125	18,5X25,2MM	25	38900.185.252
5,5X8,0MM	100	38900.055.080	12,5X17,5MM	100	38900.125.175	22,0X25,5MM	25	38900.220.255
6,4X9,5MM	100	38900.064.095	12,5X20,0MM	100	38900.125.200	24,7X32,0MM	25	38900.249.310
8,0X9,5MM	100	38900.080.095	14,2X17,5MM	50	38900.142.175	32,0X38,0MM	25	38900.320.380
8,0X11,0MM	100	38900.080.110	16,0X19,0MM	50	38900.160.190	45,0X50,0MM	25	38900.450.500
8,0X12,5MM	100	38900.080.125						

Blanking plug

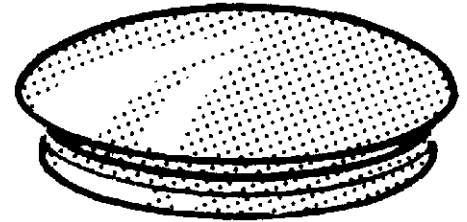
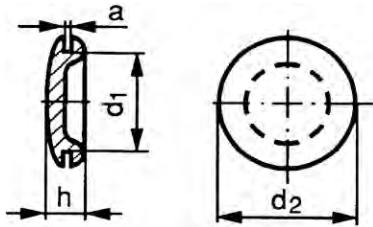

Technical Data

$d_1 \times d_2$	a	h	$d_1 \times d_2$	a	h
4.7x9.3	1.6	4.6	19.0x25.5	1.6	6.5
6.4x9.5	1.6	5	20.0x25.5	1.6	6.7
8.0x14.2	1.6	5	22.5x28.4	1.6	9.3
9.5x15.4	1.6	7.3	25.4x32	1.6	9
11.2x17.7	1.6	6.2	31.5x38.2	1.6	7.5
12.5x18.7	1.6	5.6	38.2x43.3	1.6	8.2
15.5x22	1.6	7.5	51.5x57.5	1.6	11.4

38950	Blanking plug	W05D
Material	Plastic Polyvinylchloride	
Color	Black	

$d_1 \times d_2$	☒	Art.number	$d_1 \times d_2$	☒	Art.number	$d_1 \times d_2$	☒	Art.number
4,7X9,3MM	100	38950.047.093	12,5X18,7MM	100	38950.125.187	25,4X32,0MM	25	38950.254.320
6,4X9,5MM	100	38950.064.095	15,5X22,0MM	100	38950.155.220	31,5X38,2MM	25	38950.315.382
8,0X14,2MM	100	38950.080.142	19,0X25,5MM	100	38950.190.255	38,2X43,3MM	25	38950.382.433
9,5X15,4MM	100	38950.095.154	20,0X25,5MM	50	38950.200.255	51,5X57,5MM	25	38950.515.575
11,2X17,7MM	100	38950.112.177	22,5X28,4MM	50	38950.225.284			

Clip with one fixing hole

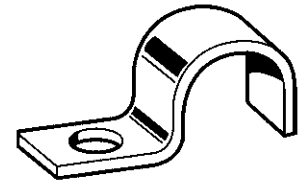
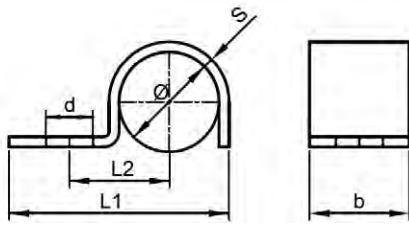

Technical Data

For pipe ø	b	d	L ₁	L ₂	s	ø
1x4	10	4.8	18	9	1	4
1x5	10	4.8	18.5	9	1	5
1x6	10	4.8	20	10	1	6
1x7	10	4.8	20.5	10	1	7
1x8	10	4.8	22	11	1	8
1x10	10	4.8	23	11	1	10
1x12	12	5.8	30.5	16	1.5	12
1x15	12	5.8	34	18	1.5	15
1x16	12	5.8	35	18	1.5	16
1x18	12	7	35.5	18	1.5	18
1x20	12	7	37.5	18	1.5	20
1x22	12	7	39.5	20	1.5	22
2x6	10	4.8	26.5	13	1	6
2x8	10	4.8	30.5	15	1	8
2x10	10	4.8	33.5	16	1	10
2x12	12	5.8	43	22	1.5	12

43213 Clip with one fixing hole

Y61A

Material Steel
Surface treatment Zinc plated



For pipe ø	☒	Art.number	For pipe ø	☒	Art.number	For pipe ø	☒	Art.number
1X4	100	43213.010.004	1X12	100	43213.010.012	2X6	100	43213.020.006
1X5	100	43213.010.005	1X15	100	43213.010.015	2X8	100	43213.020.008
1X6	100	43213.010.006	1X16	100	43213.010.016	2X10	100	43213.020.010
1X7	100	43213.010.007	1X18	100	43213.010.018	2X12	100	43213.020.012
1X8	100	43213.010.008	1X20	100	43213.010.020			
1X10	100	43213.010.010	1X22	100	43213.010.022			

Clip with two fixing holes

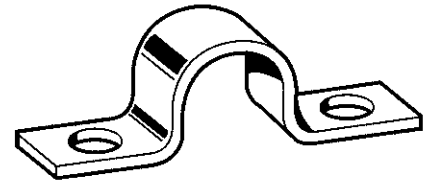
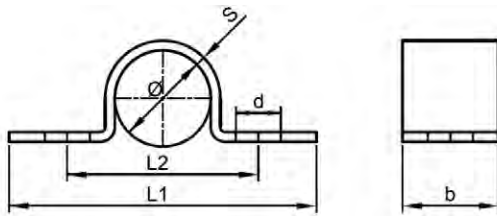

Technical Data

For pipe \varnothing	b	d	L ₁	L ₂	s	\varnothing
1x6	10	4.8	32	20	1	6
1x8	10	4.8	34	22	1	8
1x10	10	4.8	34	22	1	10
1x12	12	5.8	46	32	1.5	12
1x15	12	5.8	50	36	1.5	15
1x18	12	7	50	36	1.5	18
1x20	12	7	52	38	1.5	20
1x22	12	7	54	40	1.5	22
2x6	10	4.8	38	26	1	6
2x8	10	4.8	42	30	1	8
2x10	10	4.8	44	32	1	10
2x12	12	5.8	58	44	1.5	12
2x18	12	7	69	55	1.5	18

43214 Clip with two fixing holes

Y61A

Material Steel
Surface treatment Zinc plated



For pipe \varnothing	☒	Art.number	For pipe \varnothing	☒	Art.number	For pipe \varnothing	☒	Art.number
1X6	100	43214.010.006	1X18	100	43214.010.018	2X8	100	43214.020.008
1X8	100	43214.010.008	1X20	100	43214.010.020	2X10	100	43214.020.010
1X10	100	43214.010.010	1X22	100	43214.010.022	2X12	100	43214.020.012
1X12	100	43214.010.012	2X6	100	43214.020.006	2X18	100	43214.020.018
1X15	100	43214.010.015						

MaxxFast Cable Ties

MaxxFast introduces a complete new range of high quality cable ties and accessories. This range consists of standard nylon cables ties (white & black), colored nylon cables ties (blue, yellow, green, grey, red, orange), releasable nylon cables ties (white & black), cables ties mounts, and heavy duty stainless steel A2 cable ties. These high quality products will answer your needs for the most demanding applications.

Our standard PA 6.6 white & black cable ties are available in the most common dimensions and are resistant to oils and greases, salt and diluted acids.

The colored cable ties are available in 6 colors for color-coding circuits or color-matching cable jackets for improved aesthetics.

The releasable cable ties can be used over and over again, reducing wastes and costs for application when temporary light fixing is required.

The various PA 6.6 cables mounts are adapted to most situations and will allow strong and quick fixing for your cable ties bundles.

MaxxFast new A2 stainless steel cable ties

- Our very durable metal cable ties are made from high-quality A2 stainless steel
- Designed to withstand corrosive chemicals, salt-water, radiation, and exposure to extreme temperatures (-85°C/+500°C)
- Ball-style locking mechanism enhances tensile strength while maintaining ease of insertion for quick and user-friendly installation
- Available in a wide assortment for use in maritime, mechanical, food processing and sterile environments



Locking cable tie

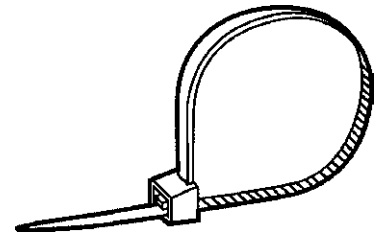
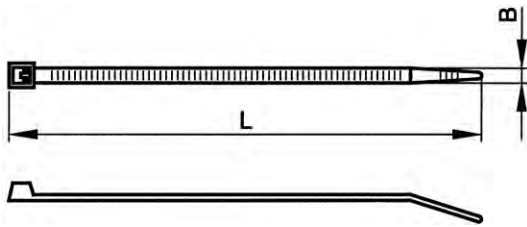

Technical Data

L x B	Max. bundle ø	Tensile strength (N)
100x2.5	22	80
200x2.5	50	80
140x3.6	33	180
200x3.6	53	180
160x4.8	38	220
200x4.8	50	220
250x4.8	60	220
300x4.8	76	220
368x4.8	102	220
430x4.8	110	220
300x7.6	76	533
368x7.6	102	533
450x7.6	132	533
540x7.6	105	533
430x9.0	110	778
530x9.0	140	778
710x9.0	190	778
780x9.0	228	778
830x9.0	239	778
500x12.5	140	1.118

- Depending on availability the dimensions may deviate.

Article groups

Material	Class	Color	Code	Page
Plastic PA	PA 6.6	White	30900	12-120
Plastic PA	PA 6.6	Black	30901	12-121
Plastic PA	PA 6.6	Assorted	30902	12-121
Plastic PA	PA 6.6	large pack	43317	12-121

30900 MAXXFAST Locking cable tie white

MF8A

Material	Plastic Polyamide (nylon)
Class	PA 6.6
Color	White

MAXXFAST
PROFESSIONAL HARDWARE

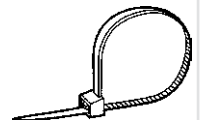

L x B	☒	Art.number	L x B	☒	Art.number	L x B	☒	Art.number
100X2,5	100	30900.100.025	250X4,8	100	30900.250.048	430X9,0	100	30900.430.090
140X3,6	100	30900.140.036	300X4,8	100	30900.300.048	450X7,6	100	30900.450.076
160X4,8	100	30900.160.048	300X7,6	100	30900.300.076	540X7,6	100	30900.540.076
200X2,5	100	30900.200.025	368X4,8	100	30900.368.048	780X9,0	100	30900.780.090
200X3,6	100	30900.200.036	368X7,6	100	30900.368.076			
200X4,8	100	30900.200.048	430X4,8	100	30900.430.048			

- Full boxes only.

30901	MAXXFAST Locking cable tie black		MF8A
Material	Plastic Polyamide (nylon)		
Class	PA 6.6		
Color	Black		

L x B	☒	Art.number	L x B	☒	Art.number	L x B	☒	Art.number
100X2,5	100	30901.100.025	300X4,8	100	30901.300.048	500X12,5	100	30901.500.125
140X3,6	100	30901.140.036	300X7,6	100	30901.300.076	530X9,0	100	30901.530.090
160X4,8	100	30901.160.048	368X4,8	100	30901.368.048	540X7,6	100	30901.540.076
200X2,5	100	30901.200.025	368X7,6	100	30901.368.076	710X9,0	100	30901.710.090
200X3,6	100	30901.200.036	430X4,8	100	30901.430.048	780X9,0	100	30901.780.090
200X4,8	100	30901.200.048	430X9,0	100	30901.430.090	830X9,0	100	30901.830.090
250X4,8	100	30901.250.048	450X7,6	100	30901.450.076			

- Full boxes only.

30902	MAXXFAST Locking cable tie		MF8A
Material	Plastic Polyamide (nylon)		
Class	PA 6.6		
Color	Assorted		

L x B	☒	Art.number	L x B	☒	Art.number	L x B	☒	Art.number
Blue 200X4,8	100	30902.000.002	Green 200X4,8	100	30902.000.005	Red 200X4,8	100	30902.000.009
Yellow 200X4,8	100	30902.000.004	Grey 200X4,8	100	30902.000.006	Orange 200X4,8	100	30902.000.030

- Full boxes only.

43317	Locking cable tie black		W050
Material	Plastic Polyamide (nylon)		
Class	PA 6.6		
Color	Black		

L x B	☒	Art.number	L x B	☒	Art.number	L x B	☒	Art.number
100X2,5	1000	43317.100.025	200X4,8	1000	43317.200.048	300X4,8	1000	43317.300.048

Locking cable tie stainless steel

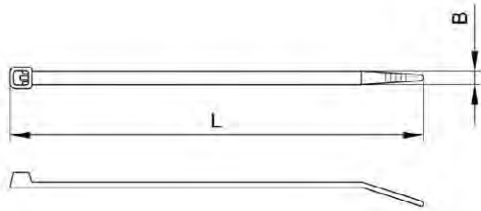

Technical Data

L x B	Max. bundle ø	Tensile strength (N)
125x4.6	33	451
200x4.6	50	451
290x4.6	76	451
360x4.6	102	451
520x4.6	156	451
680x4.6	207	451
840x4.6	257	451
200x7.94	50	1.118
290x7.94	76	1.118
360x7.94	102	1.118
520x7.94	150	1.118
680x7.94	207	1.118
840x7.94	257	1.118
1020x9.0	312	1.118

30905 MAXXFAST Locking cable tie stainless steel

MF9A

Material Stainless steel A2

MAXXFAST
PROFESSIONAL HARDWARE



L x B	☒	Art.number	L x B	☒	Art.number	L x B	☒	Art.number
125X4,6	100	30905.125.046	360X4,6	100	30905.360.046	680X7,94	100	30905.680.079
200X4,6	100	30905.200.046	360X7,94	100	30905.360.079	840X4,6	100	30905.840.046
200X7,94	100	30905.200.079	520X4,6	100	30905.520.046	840X7,94	100	30905.840.079
290X4,6	100	30905.290.046	520X7,94	100	30905.520.079	1020X9,0	100	30905.920.090
290X7,94	100	30905.290.079	680X4,6	100	30905.680.046			

• Full boxes only.

Cable tie with stainless steel clip

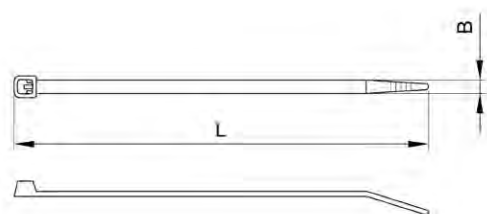

Technical Data

L x B	Max. bundle ø	Tensile strength (N)
92x2.4	16	81
140x3.6	29	180
186x4.8	45	225
281x3.6	76	180
338x7.0	90	544
360x4.8	102	225
762x7.0	229	544
200x2.4	50	81
356x2.4	102	81
208x3.6	50	180
368x3.6	103	180
293x4.8	78	225
223x7.0	50	544

Article groups

Material	Class	UV-resistant	Color	Code	Page
Plastic PA	PA 6.6	UV-resistant	Black	43295	12-123
Plastic PA	PA 6.6		Natural	43299	12-123

43295 Cable tie with stainless steel clip

Y70A

Material	Plastic Polyamide (nylon)
Class	PA 6.6
Color	Black

Ty-Rap®



L x B	☒	Art.number	L x B	☒	Art.number	L x B	☒	Art.number
92x2,4	100	43295.000.023	360x4,8	100	43295.000.028	208x3,6	100	43295.000.242
140x3,6	100	43295.000.024	762x7,0	50	43295.000.029	368x3,6	100	43295.000.244
186x4,8	100	43295.000.025	200x2,4	100	43295.000.232	293x4,8	100	43295.000.253
281x3,6	100	43295.000.026	356x2,4	100	43295.000.234	223x7,0	50	43295.005.272
338x7,0	50	43295.000.027						

43299 Cable tie with stainless steel clip

Y70A

Material	Plastic Polyamide (nylon)
Class	PA 6.6
Color	Natural

Ty-Rap®



L x B	☒	Art.number	L x B	☒	Art.number	L x B	☒	Art.number
92x2,4	100	43299.000.023	338x7,0	50	43299.000.027	208x3,6	100	43299.000.242
140x3,6	100	43299.000.024	360x4,8	100	43299.000.028	368x3,6	100	43299.000.244
186x4,8	100	43299.000.025	762x7,0	100	43299.000.029	293x4,8	100	43299.000.253
281x3,6	100	43299.000.026	200x2,4	100	43299.000.232	223x7,0	100	43299.005.272

Locking cable tie assortment

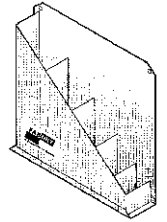

43310	Locking cable tie assortment	Y94A
Material Class	Plastic Polyamide (nylon) PA 6.6	

Type	Art.number	Content:
Assortment	1 43310.001.700	<ul style="list-style-type: none"> 100 x 2,5 mm - 500pcs. 140 x 3,6 mm - 300pcs. 200 x 4,8 mm - 300pcs. 300 x 4,8 mm - 300pcs. 368 x 4,8 mm - 200pcs.



Cable tie with eye

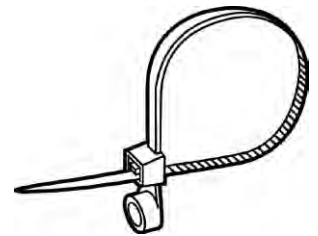
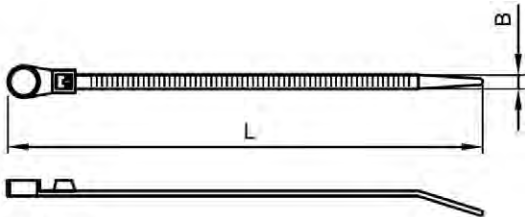

Technical Data			
L x B	Eye diameter ø	Max. bundle ø	Tensile strength (N)
110x2.5	3.2	22	81
150x3.6	4.2	32	182
200x4.8	5.5	50	222
377x4.8	5.5	102	222
380x7.6	6.3	98	544

• Depending on availability the dimensions may deviate.

43323	Cable tie with eye	W050
Material Class Color	Plastic Polyamide (nylon) PA 6.6 White	

L x B	Art.number	L x B	Art.number	L x B	Art.number
110x2,5	100 43323.110.025	200x4,8	100 43323.200.048	380x7,6	100 43323.368.076
150x3,6	100 43323.150.036	377x4,8	100 43323.368.048		

Cable tie with label

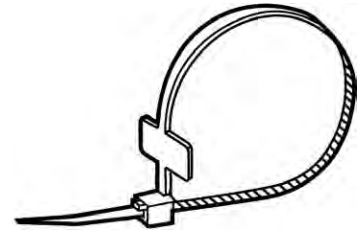
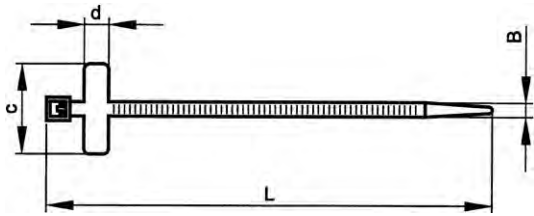

Technical Data

L x B	c	d	Max. bundle ø	Tensile strength (N)	Type no.
100x2.5	25.4	8	18	81	1
110x2.5	20.4	9.1	18	81	2
200x2.5	25.4	8	50	81	1
220x4.8	28	13	54	225	3
200x4.8 - 4	30	28	54	225	4
270x4.8	28	13	65	225	3
270x4.8 - 4	30	28	65	225	4

• Depending on availability the dimensions may deviate.

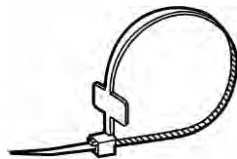
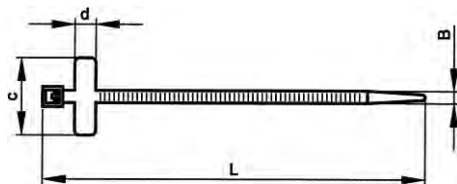

TYPE 1

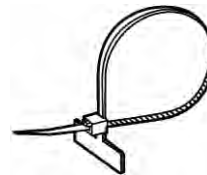
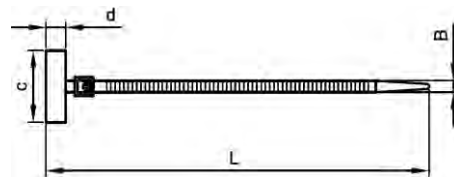

TYPE 2

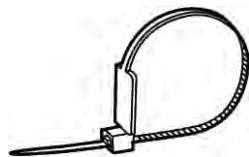
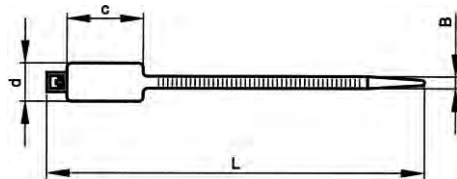

TYPE 3

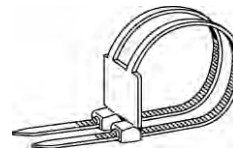
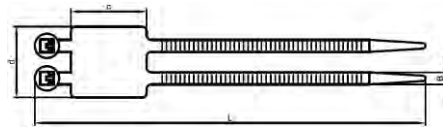

TYPE 4

Article groups

Material	Class	Color	Code	Page
Plastic PA	PA 6.6	White	43324	12-125
Plastic PA	PA 6.6	White	43325	12-126

43324 Cable tie with label

W050

Material Plastic Polyamide (nylon)
Class PA 6.6
Color White

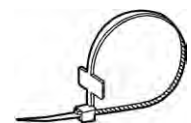

L x B	☒	Art.number	L x B	☒	Art.number	L x B	☒	Art.number
100X2,5MT	100	43324.100.025	200X2,5MT	100	43324.200.025	270X4,8MT	100	43324.270.048
110X2,5MT	100	43324.110.025	220X4,8MT	100	43324.220.048			

43325	Cable tie with label	W050
Material	Plastic Polyamide (nylon)	
Class	PA 6.6	
Color	White	

L x B	☒	Art.number
270X4,8MT2	100	43325.270.048

Releasable cable tie

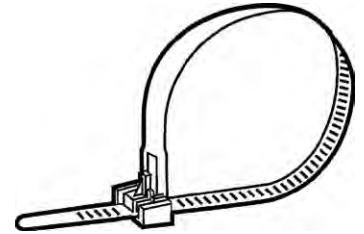
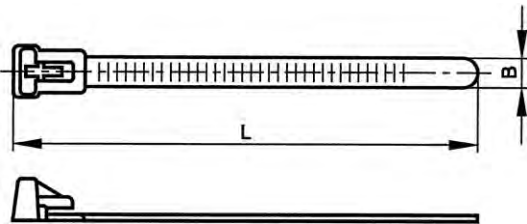

Technical Data

L x B	Max. bundle ø	Tensile strength (N)
140x3.6	33	180
200x4.8	50	220
300x4.8	86	220
368x4.8	102	220
100x7.6	20	220
150x7.6	35	220
200x7.6	50	220
300x7.6	80	220

• Depending on availability the dimensions may deviate.

Article groups

Material	Class	Color	Code	Page
Plastic PA	PA 6.6	Black	30903	12-126
Plastic PA	PA 6.6	White	30904	12-126

30903	MAXXFAST Releasable cable tie	MF8A
Material	Plastic Polyamide (nylon)	
Class	PA 6.6	
Color	Black	
		

L x B	☒	Art.number	L x B	☒	Art.number	L x B	☒	Art.number
100X7,6	100	30903.100.076	200X7,6	100	30903.200.076	300X7,6	100	30903.300.076
150X7,6	100	30903.150.076						

• Full boxes only.

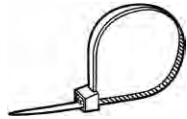
30904	MAXXFAST Releasable cable tie	MF8A
Material	Plastic Polyamide (nylon)	
Class	PA 6.6	
Color	White	
		

L x B	☒	Art.number	L x B	☒	Art.number	L x B	☒	Art.number
140X3,6	100	30904.140.036	300X4,8	100	30904.300.048	368X4,8	100	30904.368.048
200X4,8	100	30904.200.048						

• Full boxes only.

Releasable cable tie with mount

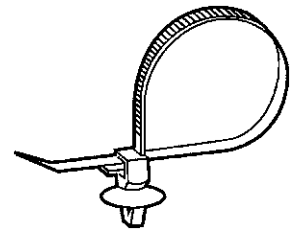
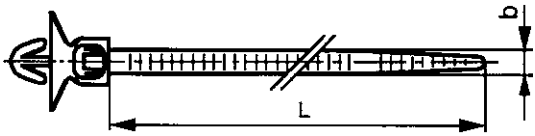

Technical Data

No.	2781
b	4.5
Hole \varnothing	6.5
L	140
Material thickness	0.6-1.6
Max. bundle \varnothing	8-35
Tensile strength (N)	140

- Depending on availability the dimensions may deviate.

56834 Releasable cable tie with mount

W05B

Material Class Color
 Plastic Polyamide (nylon)
 PA 6.6
 Black

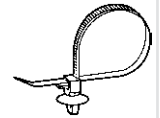

No.	Art.number
2781 Black 100	56834.278.101

Cable tie mount

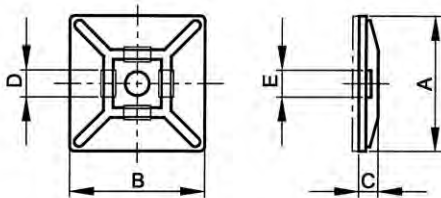

Technical Data

Type	A	B	C	D	E
19X19	19	19	4	3.8	3
28X28	28	28	5	5.5	5
2.4-4.8	9	14	7	5	3.5
2.4-9.0	10	37	6.5	9.2	-

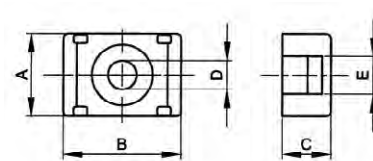
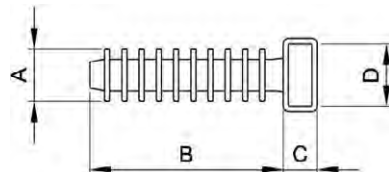
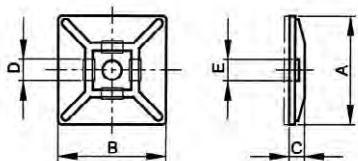

1

2

3

30908	MAXXFAST Cable tie mount	MF8A
Material	Plastic Polyamide (nylon)	

Size	☒	Art.number	Size	☒	Art.number	Size	☒	Art.number
Type-1-White19X19	100	30908.001.019	Type-1-Black19X19	100	30908.002.019	Type-3-Black2,4-4,8	100	30908.102.024
Type-1-White28X28	100	30908.001.028	Type-1-Black28X28	100	30908.002.028	Type-2-Black2,4-9,0	100	30908.770.024

- (1) 19x19mm PA 6.6 cable tie mounts for cable ties up to 3,6mm wide. 28x28mm PA 6.6 cable tie mounts for cable ties up to 4,8mm wide. Available in white or UV resistant black. High performance self adhesive rubber backing for quick and easy installation. Can alternatively be fastened with a screw.
- (2) PA 6.6 cable tie mounting plug available in UV resistant black. To install, simply drill a hole (diameter: 7mm - depth: 40mm) in the masonry and drive in the plug with a hammer. For cable ties up to 9mm wide.
- (3) PA 6.6 cable tie mounting block available in UV resistant black. Fastened with a simple screw. For cable ties up to 4,8mm wide.

Cable tie mount



Technical Data

No.	A	B	C	D ø	E	For cable ties
100	12.5	12.5	3.2	-	3.2	3.2
101	21	21	3.5	-	4.7	4.6
101-S	19	19	3.9	3.2	4.5	4.2
102	28	28	4	5	5	4.7/4.8
103	28	28	4	5	5	4.8
1675	25.4	25.4	6.8	4	3.6	2.5
1676	25.4	25.4	6.8	4	7.8	6.5
1708	9	13	6	3.1	4	3.6

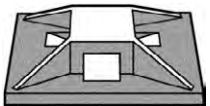
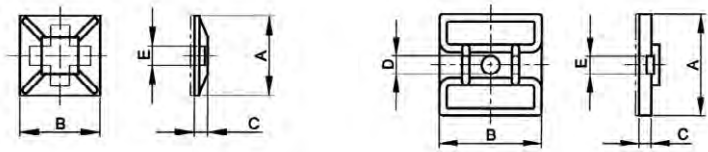

No. 100/101

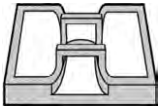

No. 103

56833	Cable tie mount	W05B
Material	Plastic Polyamide (nylon)	
Color	White	

No.	☒	Art.number	No.	☒	Art.number
100 SELF-ADHESIVE	100	56833.100.001	103 SELF-ADHESIVE	100	56833.103.001

Hand pliers for cable ties

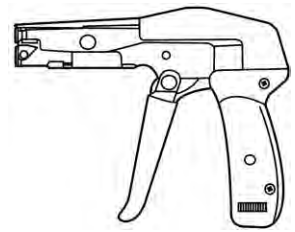

Article groups

Code	Page
30906	12-129
30907	12-129

30906	MAXXFAST Hand pliers for plastic cable ties	MFNA

For cable diam.	Art.number	For cable diam.	Art.number
2,4-4,8MM	1 30906.024.048	3,6-9,5MM	1 30906.036.095

- Manual setting tool for PA 6.6 cable ties up to 4,8mm. Automatically tightens and cuts the cable tie in one single operation.

30907	MAXXFAST Hand pliers for stainless steel cable ties	MFNA

For cable diam.	Art.number
4,6-7,94MM	1 30907.046.079

- Manual setting tool for stainless steel cable ties up to 7,94mm. Automatically tightens and cuts the cable tie in one single operation.

Hose clamp plastic

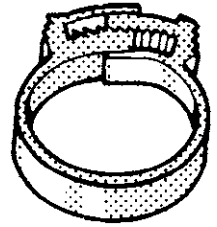
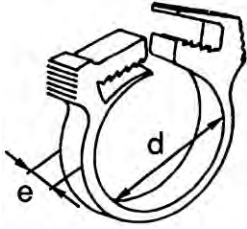

Technical Data

d	e	d	e
8-9.2	5	20.5-23	7
9.5-10.5	5	22-25	7
10.2-12	6	25-28	7
12-13.5	6	27-30	7.5
12.8-15	7	29.5-32.5	7.5
15-17.2	7	32.5-35.5	8
17-18.5	7	35-38.5	8
18.2-20.5	7		

- d = grip range.

56672 Hose clamp plastic

W02A

Material Class Plastic Polyamide (nylon)
PA 6.6



d	☒	Art.number	d	☒	Art.number	d	☒	Art.number
8,0-9,2MM	50	56672.008.009	15,0-17,2MM	50	56672.015.017	25,0-28,0MM	25	56672.025.028
9,2-10,5MM	50	56672.009.011	17,0-18,5MM	25	56672.017.019	27,0-30,0MM	25	56672.027.030
10,2-12,0MM	50	56672.010.012	18,2-20,5MM	25	56672.018.021	29,5-32,5MM	10	56672.029.033
12,0-13,5MM	50	56672.012.014	20,5-23,0MM	25	56672.020.023	32,5-35,5MM	10	56672.032.035
12,8-15,0MM	50	56672.012.015	22,0-25,0MM	25	56672.022.025	35,0-38,5MM	10	56672.035.038

Push mount wire saddle clip

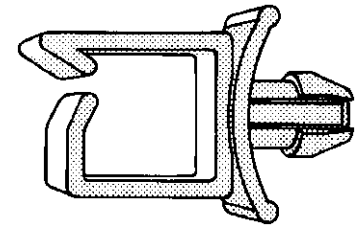
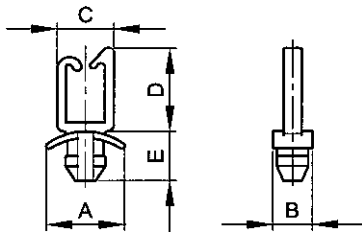

Technical Data

No.	0320	1590
A	13.4	12.4
B	5.7	5.5
C	11	11.9
D	13	2.4
E	7.8	8.5
F	-	7.5
Hole	4.8 ϕ	4.8 ϕ
Material thickness	0.4-1.5	0.4-1.8
Max. cable ϕ	8	5
Type no.	1	2

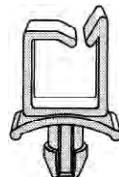
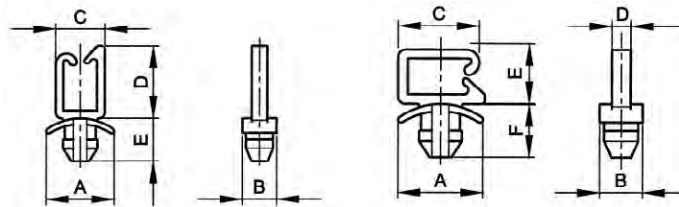

TYPE 1



TYPE 2

56840 Push mount wire saddle clip

W05B

Material Plastic Polyamide (nylon)
 Class PA 6.6
 Color White

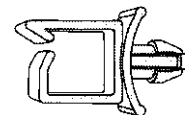

No.	☒	Art.number	No.	☒	Art.number
0320 NATURAL	100	56840.032.001	1590 NATURAL	100	56840.159.001

Cable clip self adhesive

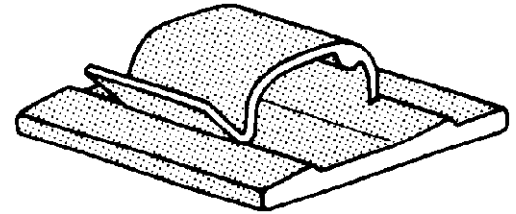
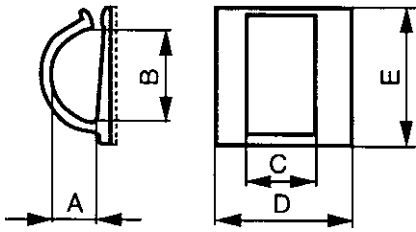

Technical Data

No.	1030	1061	1087	1818	2748
A	7	13.5	4	8	6.4
B	11.7	21	4.6	11.7	8
C	12.4	25.4	9.5	9.5	5.5
D	25.4	31.8	16	19	8.8
E	25.4	31.8	16	19	18
Max. cable ø	8	16	5	8	6.5
Type no.	1	1	1	1	2

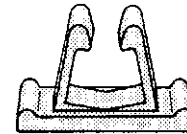
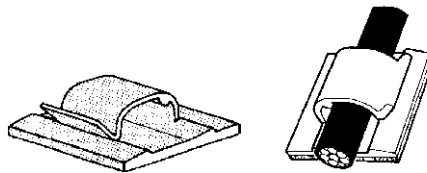
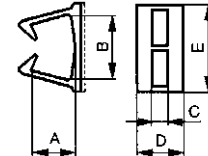
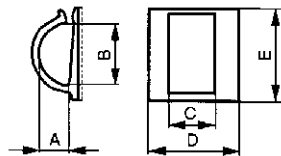

TYPE 1

TYPE 2

56835 Cable clip self adhesive		W05B
Material	Plastic Polyamide (nylon)	
Class	PA 6.6	
Color	White	

No.	☒	Art.number	No.	☒	Art.number	No.	☒	Art.number
1030 NATURAL	100	56835.103.001	1087 NATURAL	100	56835.108.701	2748 NATURAL	100	56835.274.801
1061 NATURAL	100	56835.106.101	1818 NATURAL	100	56835.181.801			

Flat cable clip self adhesive

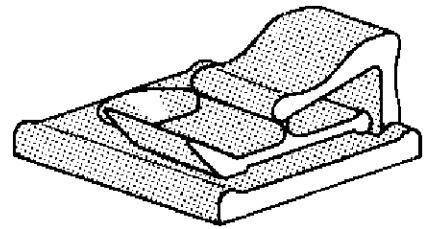
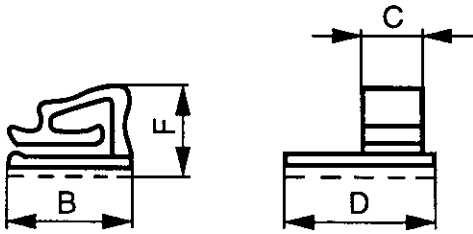

Technical Data

No.	A	B	C	D	F
2622	-	16	7	16	10
7122	51	62	8	16	14
7255	-	16	7	16	10

- 2622 - 7122 = With hole in bottom plate.

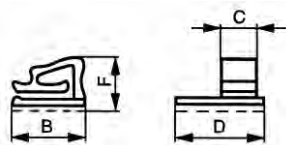

Nr. 2622

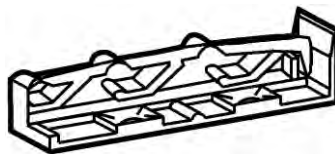
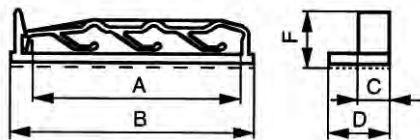

Nr. 7122

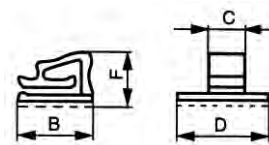

Nr. 7255

56832 Flat cable clip self adhesive

W05B

Material Plastic Polyamide (nylon)
Class PA 6.6
Color White



No.	☒	Art.number	No.	☒	Art.number	No.	☒	Art.number
2622 NATURAL	100	56832.262.201	7122 NATURAL	50	56832.712.201	7255 NATURAL	100	56832.725.501

Driller

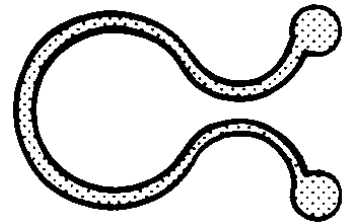
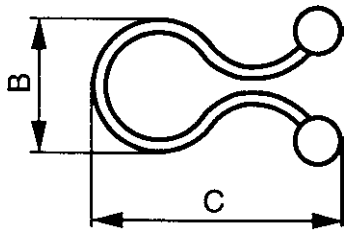

Technical Data

No.	B	C	Cable ø	Type no.
0787	8.5	20	4-6.9	1
0788	12.5	25	7-9.5	1
0789	15	30	10-12.5	1
0794	23	40	17-20	1
0960	12	25	7-9.5	2
1334	11.9	25	7.5-10	3
1650	19	35	13.5-16	2
1651	23	40	17-20	2
1652	30	46	25-27.5	2

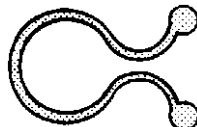
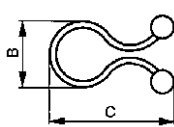

Type 1; with sharp profile
Type 2; with rounded profile

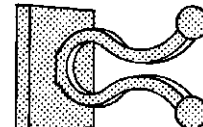
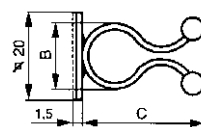

Type 3; with self-adhesive mount

56837 Driller

W05B

Material Class Plastic Polyamide (nylon)
PA 6.6

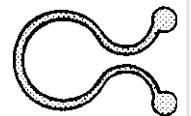

Nr. colour	☒	Art.number	Nr. colour	☒	Art.number	Nr. colour	☒	Art.number
0787 NATURAL	100	56837.078.701	0794 BLACK	100	56837.079.402	1650 NATURAL	100	56837.165.001
0788 NATURAL	100	56837.078.801	0960 NATURAL	100	56837.096.001	1650 BLACK	100	56837.165.002
0788 BLACK	100	56837.078.802	1334 NATURAL	100	56837.133.401	1651 NATURAL	100	56837.165.101
0789 NATURAL	100	56837.078.901	1334 SELF-ADHESIVE	100	56837.133.402	1652 NATURAL	100	56837.165.201
0794 NATURAL	100	56837.079.401						

Spacer

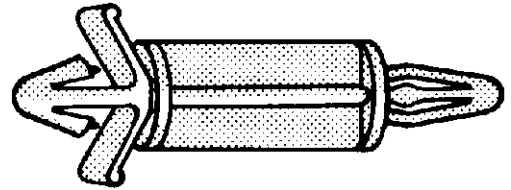
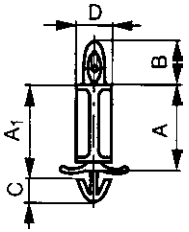

Technical Data

No.	7061	7062	7065	7112	7115	7192	7193
A	4.8	6.4	6.4	13.2	10.2	9.5	6.4
A ₁	8.4	9.9	7.9	19.6	13.2	-	-
B	10	10	9.5	4	10	10	10
Base plate hole ø/□	4.8 ø	4.8 ø	6.3 □	4.9 ø	4.8 ø	4 ø	4 ø
Base plate thickness	0.4-2	0.4-2	1.6	1.4-1.8	0.8-3	0.4-3	0.4-3
C	5.5	5.5	1.5	4	7	6.4	6.4
D ø	7	7	5.8	10	7.1	9	9
Print plate hole ø	4	4	4	4.9	3.5	4	4
Print plate thickness	1.6	1.6	1.6	1.4-1.8	0.8-2.5	1.6	1.6
Type no.	1	1	3	5	6	2	2

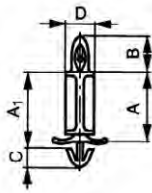

TYPE 1

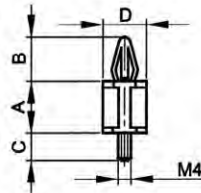

TYPE 2

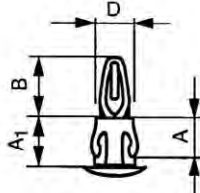

TYPE 3

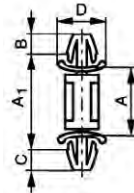

TYPE 5

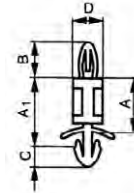

TYPE 6

56839 Spacer

W05B

Material Plastic Polyamide (nylon)
Class PA 6.6
Color White

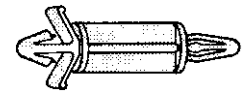

No.	☒	Art.number	No.	☒	Art.number	No.	☒	Art.number
7061 NATURAL	100	56839.706.101	7112 NATURAL	100	56839.711.201	7192 NATURAL	100	56839.719.201
7062 NATURAL	100	56839.706.201	7115 NATURAL	100	56839.711.501	7193 NATURAL	100	56839.719.301
7065 NATURAL	100	56839.706.501						

Drive rivet

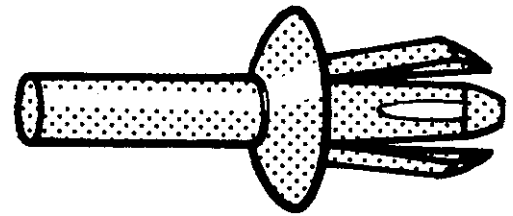
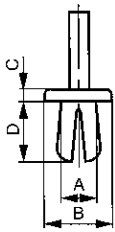

Technical Data

No.	0164	0756	0765	0780	1283	7005
A \varnothing	4.2	3.5	6.2	4.8	4.8	3.8
B \varnothing	6	6.3	11	8.7	7.1	7.5
C	1.5	1.8	2	2.5	1.2	1.3
D	5	6.6	12.3	7.4	11.1	8.2
Hole \varnothing	4.3-4.8	3.4-3.6	6.4-7	4.75	4.8-5.4	4.4-2
Material thickness	1-3.5	3.2-4.8	5.5-9.5	1.6-4.75	4-8.7	4-6.5
Type no.	1	2	1	1	3	3

- Larger diameter is recommended with use in thick sheet materials.
- It is recommended that the exact diameter selection is made on basis of tests.

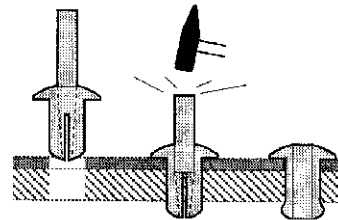
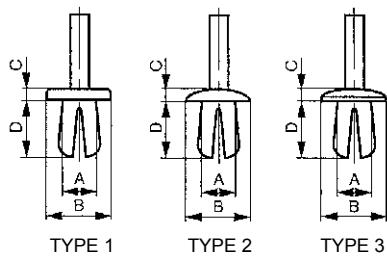

56819	Drive rivet	W05B
Material	Plastic Polyamide (nylon)	
Class	PA 6.6	
Color	Assorted	

Nr. colour	☒	Art.number	Nr. colour	☒	Art.number	Nr. colour	☒	Art.number
0756 NATURAL	100	56819.075.601	0780 NATURAL	100	56819.078.001	1283 BLACK	100	56819.128.302
0756 BLACK	100	56819.075.602	0780 BLACK	100	56819.078.002	7005 NATURAL	100	56819.700.501
0765 NATURAL	100	56819.076.501	1283 NATURAL	100	56819.128.301	7005 BLACK	100	56819.700.502
0765 BLACK	100	56819.076.502						

Screw rivet

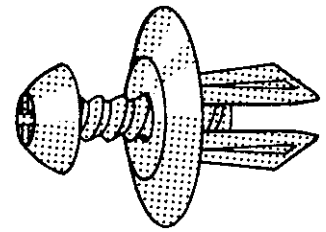
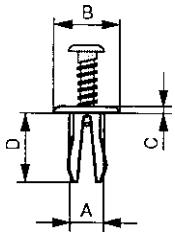

Technical Data

No.	2384	2710	3008
A \varnothing	6	5	8
B \varnothing	16	12	20
C	1.5	1.5	1.3
D	11	11	14
Hole \varnothing	6.5	5	8
Material thickness	4	3.75-6	3-10

- Larger diameter is recommended with use in thick sheet materials.
- It is recommended that the exact diameter selection is made on basis of tests.

Assembly data

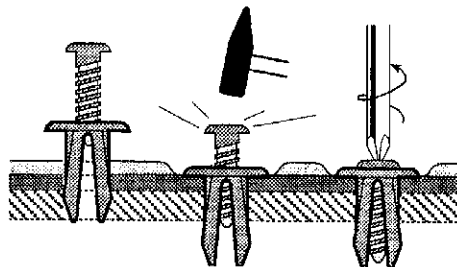

56818 Screw rivet		W05B
Material	Plastic Polyamide (nylon)	
Class	PA 6.6	
Color	Black	

No.	✉	Art.number	No.	✉	Art.number	No.	✉	Art.number
2384 BLACK	100	56818.238.401	2710 BLACK	100	56818.271.001	3008 BLACK	100	56818.300.801

Ratched rivet

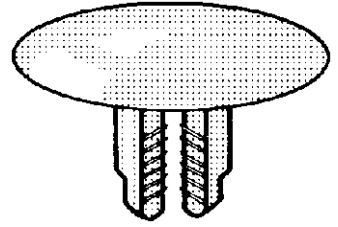
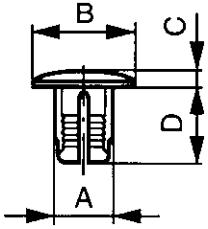

Technical Data

No.	7012	7013	7015
A ø	7	7	7
B ø	19.1	19.1	10.3
C	2.4	2.4	1.6
D	8.7	12.4	5.7
Hole	7.1	7.1	7.1
Material thickness	8.8-12.7	12.7-20.6	6-7.5

Assembly data

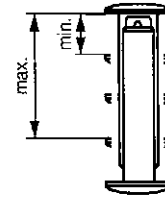
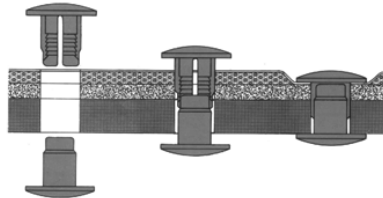

56830 Ratched rivet		W05B
Material	Plastic Polyamide (nylon)	
Class	PA 6.6	
Color	White	

No.	⊗	Art.number	No.	⊗	Art.number	No.	⊗	Art.number
7012 NATURAL	100	56830.701.201	7013 NATURAL	100	56830.701.301	7015 NATURAL	100	56830.701.501

- ATTENTION: packing per 100 pieces = 50 connections

Push rivet (Canoe clip)

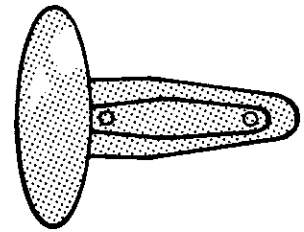
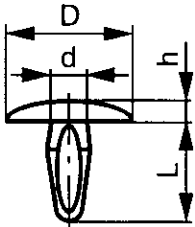

Technical Data

No.	0001	0130	0796	1840	1854
D ø	14	14	14	7.9	9.5
d ø	4.7	6	4.6	2.6	4.6
h	2.2	2.5	3	1.3	1.5
Hole ø	4.8	6	5	2.7	4.8
L	15	19	14.5	12.3	11.1
Material thickness	3-6	3-7	2	0.8-3.6	0.8-4

Assembly data

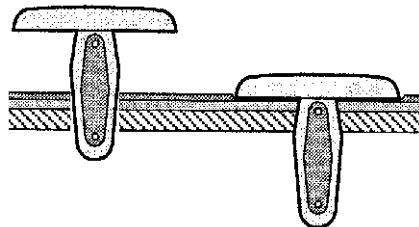

56824 Push rivet (Canoe clip)

W05B

Material Plastic Polyamide (nylon)
Class PA 6.6
Color Assorted

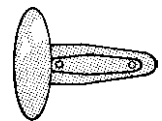

No. colour	☒	Art.number	No. colour	☒	Art.number	No. colour	☒	Art.number
0001 BLACK	100	56824.000.101	0796 WHITE	100	56824.079.602	1854 NATURAL	100	56824.185.401
0130 WHITE	100	56824.013.001	1840 BLACK	100	56824.184.001	1854 BLACK	100	56824.185.402
0796 BLACK	100	56824.079.601						

Grommet

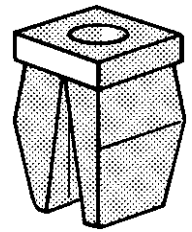
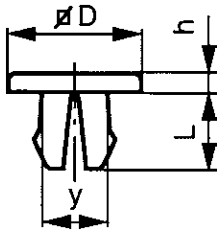

Technical Data

No.	0012	0013	0916	1378
D ø/□	13 ø	9.5 ø	10 □	5.6 □
For screw	ST4.2	ST4.2	ST4.2	ST2.9
h	1.5	1.2	3	1.3
Hole	7 □	7 □	6 ø	4.3 □
L	8.3	8.3	8	5.6
Material thickness	0.8-4	0.8-4	0.8-4.5	0.8-2
Type no.	1	1	2	2
Y	6.9	6.9	5.6	4.3

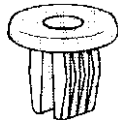
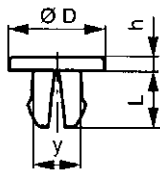

TYPE 1

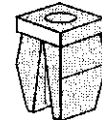
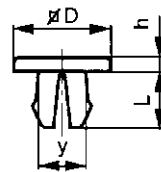

TYPE 2



56210	Grommet	W05B
Material	Plastic Polyamide (nylon)	
Class	PA 6.6	
Color	Natural	

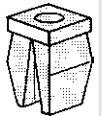

No.	☒	Art.number	No.	☒	Art.number	No.	☒	Art.number
0012	100	56210.012.001	0916	100	56210.091.601	1378	100	56210.137.801
0013	100	56210.013.001						

Glide

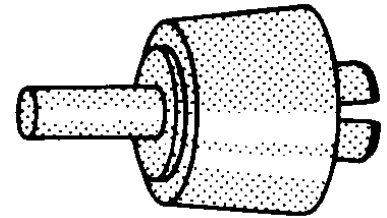
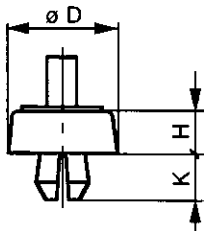

Technical Data

No.	0897	1024	1162	1806	2243
D ø	17	16	12	16	21
H	10.5+0.5	6.5+0.5	3.6	12	15
Hole ø steel	7+0.1	7+0.2	6+0.2	7.7+0.1	7.7+0.1
Hole ø wood	7+0.2	7+0.2	6+0.2	8+0.1	8+0.2
K	4	7	5.5	8	7
Material thickness	1-2.5	1.5-3	0.8-2	0.9-1.5	0.8-4

- Material no. 0897: polystyrol, other numbers polyamide PA 6.6

Assembly data

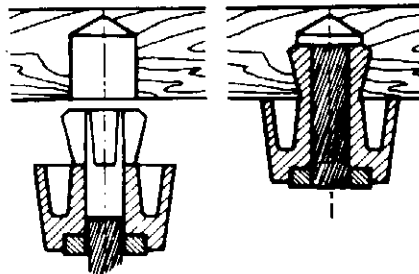

56843		Glide		W05B	
Material	Plastic Polyamide (nylon)				
Class	PA 6.6				
Color	Black				

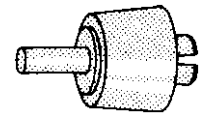

No.	☒	Art.number	No.	☒	Art.number	No.	☒	Art.number
0897 BLACK	50	56843.089.701	1162 BLACK	50	56843.116.201	2243 BLACK	50	56843.224.301
1024 BLACK	50	56843.102.401	1806 BLACK	50	56843.180.601			

Bumper self adhesive

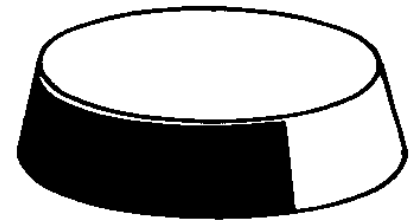
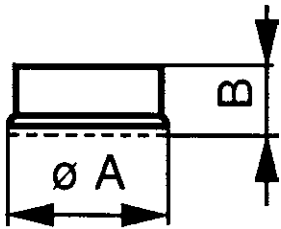

Technical Data

No.	A \varnothing	B	Type no.
7220	12.7 \varnothing	3.5	1
7224	12.7 \varnothing	1.5	1
7229	22.3 \varnothing	10.2	3
7231	20.6 \varnothing	7.6	2
7239	12.7 \varnothing	3.0	2

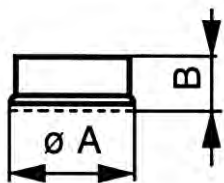

TYPE 1

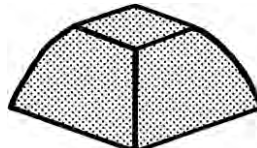
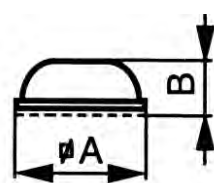

TYPE 2

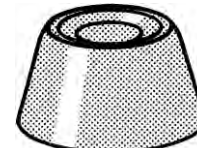
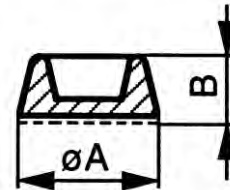

TYPE 3

56890	Bumper self adhesive	W05B
Material	Plastic Polyurethane	
Color	Black	



No.	☒	Art.number	No.	☒	Art.number	No.	☒	Art.number
7220 BLACK	100	56890.722.001	7229 BLACK	100	56890.722.901	7239 BLACK	100	56890.723.901
7224 BLACK	100	56890.722.401	7231 BLACK	100	56890.723.101			

Protective buffer

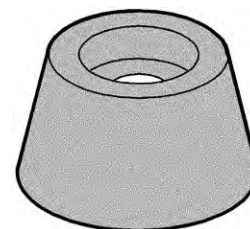
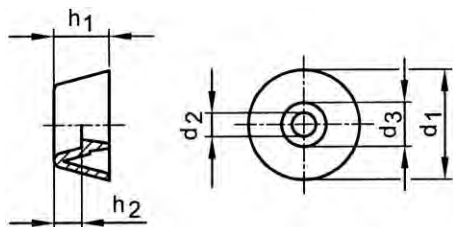

Technical Data

d ₁	d ₂	d ₃	h ₁	h ₂
15	3.2	6	7.5	4
20	4.3	8	10	5
25	4.3	10	12.5	6.5
30	5.3	12	15	7.5

- Specific features of protective buffers:
- Soft yet very strong flexible buffer.
- For mounting in iron work, sliding facades and such.
- Low building height and tight neat finish
- Simple mounting with single screw connection or drive rivet

56799 Protective buffer

W05E

Material Plastic Polyvinylchloride
Color Black



d ₁	☒	Art.number	d ₁	☒	Art.number	d ₁	☒	Art.number
15MM	25	56799.150.001	25MM	25	56799.250.001	30MM	25	56799.300.001
20MM	25	56799.200.001						

Rosette closed model PA

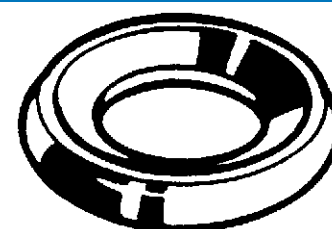
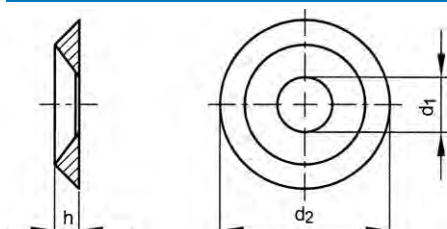

Technical Data

For nom.size	d ₁	d ₂	h	For nom.size	d ₁	d ₂	h
M3	3.2	10.2	2.8	M5	5.3	14	3.8
M4	4.3	12	3.2	M6	6.4	16	4.5

Article groups

Material	Class	Color	Code	Page
Plastic PA	PA 6.6	White	56680	12-143
Plastic PA	PA 6.6	Black	56690	12-144

56680 Rosette closed model PA

W02A

Material Plastic Polyamide (nylon)
Class PA 6.6
Color White



For nom. size	☒	Art.number	For nom. size	☒	Art.number	For nom. size	☒	Art.number
M3	100	56680.030.001	M5	50	56680.050.001	M6	25	56680.060.001
M4	50	56680.040.001						

56690	Rosette closed model PA	W02A
Material	Plastic Polyamide (nylon)	
Class	PA 6.6	
Color	Black	

For nom. size	☒	Art.number	For nom. size	☒	Art.number	For nom. size	☒	Art.number
M3	100	56690.030.001	M5	50	56690.050.001	M6	25	56690.060.001
M4	50	56690.040.001						

Retaining washer

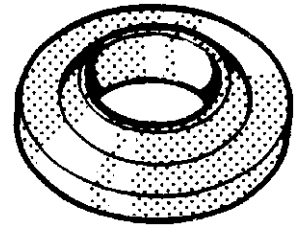
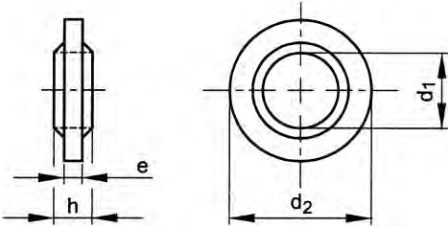

Technical Data

For nom.size	d ₁	d ₂	e	h	For nom.size	d ₁	d ₂	e	h
M3	3.1	7	0.6	12	M12	12.1	22	2.2	5
M4	4.2	9	1.2	2.8	M14	14.2	25.4	2.4	5.5
M5	5.2	10.6	1.4	3	M16	16.2	29.4	2.5	6.2
M6	6.1	12	1.6	3.8	M18	18.2	32	2.5	6.8
M8	8.1	16.2	1.8	4	M20	20.3	35.7	2.7	7
M10	10.2	19.6	2.1	5					

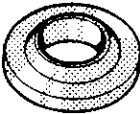
56770	Retaining washer	W02A
Material	Plastic Polyamide (nylon)	
Class	PA 6.6	
Color	White	

For nom. size	☒	Art.number	For nom. size	☒	Art.number	For nom. size	☒	Art.number
M3	100	56770.030.001	M8	50	56770.080.001	M14	25	56770.140.001
M4	100	56770.040.001	M10	50	56770.100.001	M16	25	56770.160.001
M5	100	56770.050.001	M12	50	56770.120.001	M20	10	56770.200.001
M6	100	56770.060.001						

Shoulder washer

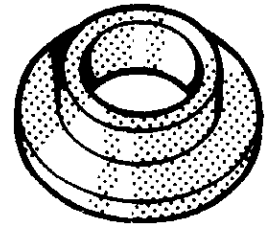
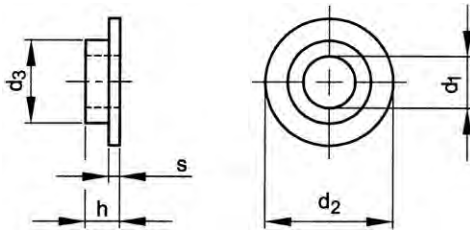

Technical Data

For nom.size	d ₁	d ₂	d ₃	h	s
M3	3.1	8.1	6.1	2	1.2
M4	4.3	12	6.5	2.6	1.5
M5	5	12	9	4.9	2
M6	6.5	15.8	9.6	4.4	1.6

56710 Shoulder washer

W02A

Material Plastic Polyamide (nylon)
Class PA 6.6
Color White

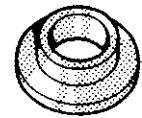

For nom. size	Art.number	For nom. size	Art.number	For nom. size	Art.number
M3	100 56710.030.001	M5	100 56710.050.001	M6	50 56710.060.001
M4	100 56710.040.001				

Insulating bush

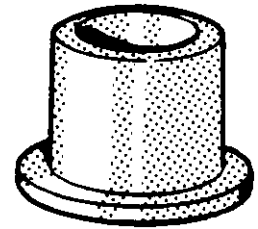
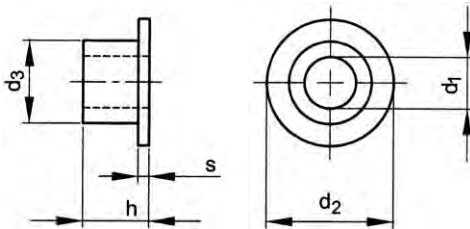

Technical Data

For nom.size	d ₁	d ₂	d ₃	h	s
M5	5	10.5	8.5	4.8	1.5
M6	6.1	12.2	8	6	2
M8	8.1	20	14.2	11.9	2.6
M10	10.1	19.8	14.9	11.8	2.6
M12	12.1	23.9	17.7	15.6	2.6
M14	14.1	25.9	19.8	17.8	2.7
M16	16.1	27.7	21.7	19.7	3.1
M20	20.1	31.9	26.7	23.9	3.1

Example of insulation against contact corrosion of a bolt joint

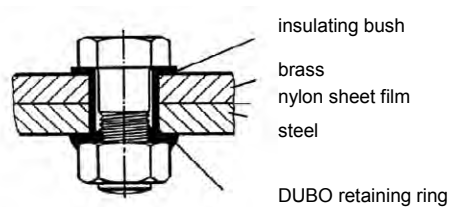

56760	Insulating bush	W02A
Material	Plastic Polyamide (nylon)	
Class	PA 6.6	
Color	White	

For nom. size	☒	Art.number	For nom. size	☒	Art.number	For nom. size	☒	Art.number
M5	100	56760.050.001	M10	50	56760.100.001	M16	10	56760.160.001
M6	100	56760.060.001	M12	50	56760.120.001	M20	10	56760.200.001
M8	50	56760.080.001	M14	25	56760.140.001			

Slide bearing

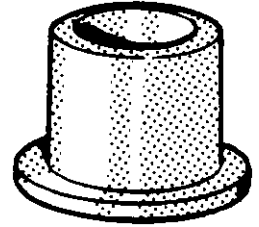
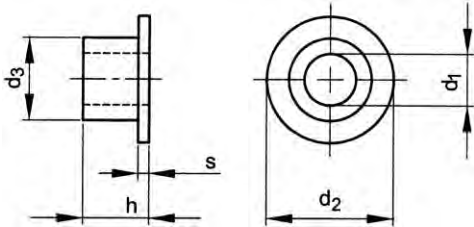

Technical Data

d_1	d_2	d_3	h	s	d_1	d_2	d_3	h	s
3	8	5	7	2	18	30	22	25	2.5
4	9	6	8	2	20	30	24	26	2
5	11	8	10	2	25	37	30	30	2.5
6	12	9	11	2	28	40	33	33	2.5
8	16	11	13	2	30	42	35	35	2.5
10	18	13	15	2	32	45	38	38	3
12	21	16	19	2	40	55	46	46	3
14	28	18	21	3	50	67	56	50	3.5
16	28	20	22	2.5	60	81	68	50	4

- Specific features of slide bearings:
- Manufactured out of self-lubricating nylon 6.6 and designed with buffercollar
- Insensitive to dirt, weatherinfluences and most chemicals
- Extremely fit for soundless hinges, low R.P.M. machines
- Also electric insulating between axle and bearinghouse
- Suitable for h6-H7 fitting
- After assembly bearing clearance approx 1% of the shaft diameter

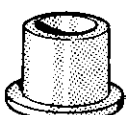
56806	Slide bearing	W03E
Material	Plastic Polyamide (nylon)	
Class	PA 6.6	
Color	Natural	

d_1	☒	Art.number	d_1	☒	Art.number	d_1	☒	Art.number
3MM	100	56806.030.001	12MM	100	56806.120.001	28MM	10	56806.280.001
4MM	100	56806.040.001	14MM	100	56806.140.001	30MM	10	56806.300.001
5MM	100	56806.050.001	16MM	100	56806.160.001	32MM	10	56806.320.001
6MM	100	56806.060.001	18MM	50	56806.180.001	40MM	5	56806.400.001
8MM	100	56806.080.001	20MM	50	56806.200.001	50MM	5	56806.500.001
10MM	100	56806.100.001	25MM	25	56806.250.001	60MM	3	56806.600.001

Insulating bush

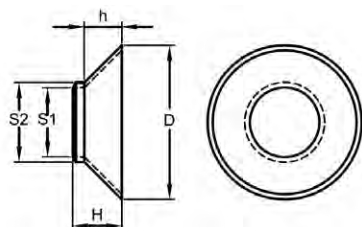

Technical Data

For nom.size	D	h	H	S ₁	S ₂
M3	8.2	1.7	3.7	3.1	4.9
M4	10.4	2.3	4.3	4.1	5.9
M5	12.4	2.8	4.8	5.1	6.9
M6	14.4	3.3	5.3	6.1	7.9
M8	18.6	4.4	6.4	8.1	9.9
M10	22.5	5.0	10.3	10.2	12.4
M12	26.8	6.5	8.5	12.1	13.9

56767 Insulating bush

W05E

Material Plastic Polyamide (nylon)
Class PA 6.6
Color Natural



For nom. size	☒	Art.number	For nom. size	☒	Art.number	For nom. size	☒	Art.number
M3	100	56767.030.002	M6	100	56767.060.002	M10	100	56767.100.002
M4	100	56767.040.002	M8	100	56767.080.002	M12	100	56767.120.002
M5	100	56767.050.002						

Spacer

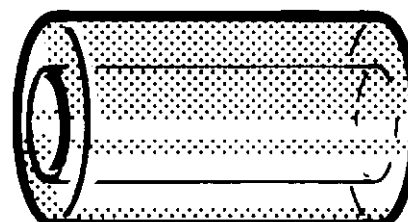
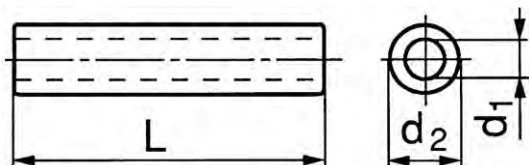

Technical Data

For nom.size	d ₁	For nom.size	d ₁
2.5	2.6	6	6.2
3	3.1	8	8.2
3.5	3.6	10	10.3
4	4.2	12	12.8
5	5.2		

56800 Spacer

W02A

Material Plastic Polyamide (nylon)
Class PA 6.6
Color White

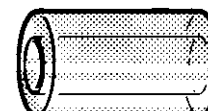

For nom. size x d ₂ x L	☒	Art.number	For nom. size x d ₂ x L	☒	Art.number	For nom. size x d ₂ x L	☒	Art.number
2,5X4X2MM	500	56800.024.002	2,5X5X25MM	500	56800.025.025	3X5X20MM	500	56800.029.020
2,5X5X2MM	500	56800.025.002	2,5X5X30MM	500	56800.025.030	3X5X25MM	500	56800.029.025
2,5X5X3MM	500	56800.025.003	3X5X2MM	500	56800.029.002	3X5X30MM	500	56800.029.030
2,5X5X5MM	500	56800.025.005	3X5X3MM	500	56800.029.003	3X8X2,5MM	500	56800.030.002
2,5X5X7,5MM	500	56800.025.007	3X5X5MM	500	56800.029.005	3X8X3MM	500	56800.030.003
2,5X5X10MM	500	56800.025.010	3X5X7,5MM	500	56800.029.007	3X8X5MM	500	56800.030.005
2,5X5X15MM	500	56800.025.015	3X5X10MM	500	56800.029.010	3X8X7,5MM	500	56800.030.007
2,5X5X20MM	500	56800.025.020	3X5X15MM	500	56800.029.015	3X8X10MM	500	56800.030.010

56800 Spacer								
For nom. size x d ₂ x L	☒	Art.number	For nom. size x d ₂ x L	☒	Art.number	For nom. size x d ₂ x L	☒	Art.number
3X8X15MM	500	56800.030.015	5X10X5MM	200	56800.050.005	8X12X30MM	200	56800.080.030
3X8X20MM	500	56800.030.020	5X10X7,5MM	200	56800.050.007			
3X8X25MM	500	56800.030.025	5X10X10MM	200	56800.050.010	8X15X15MM	200	56800.081.515
3X8X30MM	500	56800.030.030	5X10X15MM	200	56800.050.015			
			5X10X20MM	200	56800.050.020	8,2X18X5MM	100	56800.082.005
3,5X6X3MM	200	56800.035.003	5X10X25MM	200	56800.050.025			
3,5X6X5MM	200	56800.035.005	5X10X30MM	200	56800.050.030	10X15X3MM	200	56800.100.003
3,5X6X7,5MM	200	56800.035.007				10X15X5MM	200	56800.100.005
3,5X6X10MM	200	56800.035.010	6X10X2,5MM	200	56800.060.002	10X15X7,5MM	200	56800.100.007
3,5X6X15MM	200	56800.035.015	6X10X3MM	200	56800.060.003	10X15X10MM	200	56800.100.010
3,5X6X20MM	200	56800.035.020	6X10X5MM	200	56800.060.005	10X15X15MM	200	56800.100.015
3,5X6X25MM	200	56800.035.025	6X10X7,5MM	200	56800.060.007	10X15X20MM	200	56800.100.020
3,5X6X30MM	200	56800.035.030	6X10X10MM	200	56800.060.010	10X15X25MM	200	56800.100.025
			6X10X15MM	200	56800.060.015	10X15X30MM	200	56800.100.030
4X8X2,5MM	200	56800.040.002	6X10X20MM	200	56800.060.020			
4X8X3MM	200	56800.040.003	6X10X25MM	200	56800.060.025	10X22X20MM	200	56800.102.020
4X8X5MM	200	56800.040.005	6X10X30MM	200	56800.060.030			
4X8X7,5MM	200	56800.040.007				12X18X3MM	200	56800.120.003
4X8X10MM	200	56800.040.010	8X12X3MM	200	56800.080.003	12X18X5MM	200	56800.120.005
4X8X15MM	200	56800.040.015	8X12X5MM	200	56800.080.005	12X18X7,5MM	200	56800.120.007
4X8X20MM	200	56800.040.020	8X12X7,5MM	200	56800.080.007	12X18X10MM	200	56800.120.010
4X8X25MM	200	56800.040.025	8X12X10MM	200	56800.080.010	12X18X15MM	200	56800.120.015
4X8X30MM	200	56800.040.030	8X12X15MM	200	56800.080.015	12X18X20MM	200	56800.120.020
			8X12X20MM	200	56800.080.020	12X18X25MM	200	56800.120.025
5X10X3MM	200	56800.050.003	8X12X25MM	200	56800.080.025	12X18X30MM	200	56800.120.030

Insulating tube

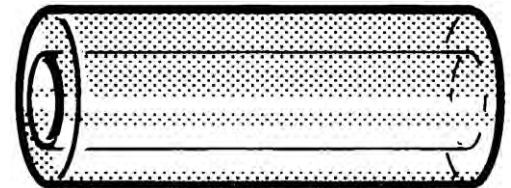
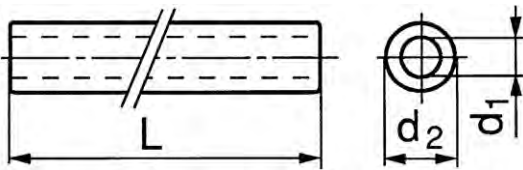

56772 Insulating tube 2 mtr W03G

Material Class Plastic Polyamide (nylon) PA 6.6

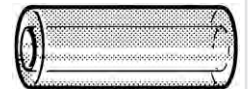

For nom. size	☒	Art.number	For nom. size	☒	Art.number	For nom. size	☒	Art.number
4X5MM	100	56772.040.005	8X5MM	100	56772.080.005	12X5MM	100	56772.120.005
5X5MM	100	56772.050.005	8X6MM	100	56772.080.006	12X10MM	100	56772.120.010
5X10MM	100	56772.050.010	8X10MM	50	56772.080.010			
			10X5MM	100	56772.100.005	16X5MM	100	56772.160.005
6X5MM	100	56772.060.005	10X8MM	100	56772.100.008	16X25MM	25	56772.160.025
						20X5MM	100	56772.200.005

Cover plug

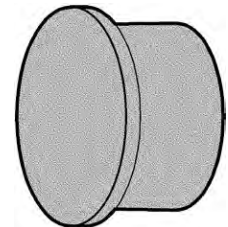
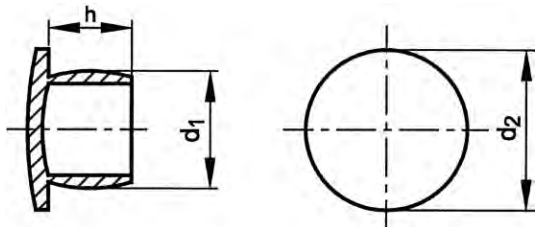

Technical Data

d ₁	d ₂	h	d ₁	d ₂	h
2.1	3.5	7	19.6	26	9
2.6	12	4	20.0	25.5	9
2.7	12	6	21.0	26	13
3.3	12	6	22.3	29	9
4.4	9	5.5	23.0	27.3	19.3
4.7	7	5	24.0	27	12.5
5.2	11	6	24.5	32	13
5.4	12	7.5	25.0	31.5	6
6.0	11	7	26.0	31.5	12
6.6	7.5	5	27.2	29.6	15
7.2	11	6.5	28.6	34.5	15
7.3	11	6	31.2	38	13
8.0	12	7	33.5	41	11.5
8.5	12	8	34.0	40	20
8.8	11.5	8	35.5	47	15
9.3	12.5	9	36.5	47	18
10.0	15	9	39.5	46	15
10.1	12	4	42.0	44.5	13
10.7	14.5	9	43.3	50	15
11.9	14.2	8	45.5	51	16
12.8	17.5	9	45.8	51	16
13.2	17.5	8	50.5	57	14
13.6	19	8.5	52.0	60	16
14.6	18.5	9.5	55.5	60	16
15.4	19	8.5	58.0	63	18
15.7	19	8.5	61.5	74	20
16.8	20	9	70.0	80	18
17.2	23	10	85.0	95	18
18.8	21.5	9	110.0	130	18

- Accurate cylindrical plug with a good sealing.
- For sealing of temporary drill holes or screwthread holes but also for lengthy protection.
- Great clampability, therefore utmost reliable also in difficult situations.

56780 Cover plug		W05E
Material	Plastic Polyethylene	
Color	Natural	

d ₁	☒	Art.number	d ₁	☒	Art.number	d ₁	☒	Art.number
2,1MM	100	56780.021.001	10,1MM	100	56780.101.001	24,5MM	50	56780.245.001
2,6MM	100	56780.026.001	10,7MM	100	56780.107.001	25,0MM	50	56780.250.001
2,7MM	100	56780.027.001	11,9MM	100	56780.119.001	26,0MM	50	56780.260.001
3,3MM	100	56780.033.001	12,8MM	100	56780.128.001	27,2MM	50	56780.272.001
4,4MM	100	56780.044.001	13,2MM	100	56780.132.001	28,6MM	50	56780.286.001
4,7MM	100	56780.047.001	13,6MM	100	56780.136.001	31,2MM	50	56780.312.001
5,2MM	100	56780.052.001	14,6MM	100	56780.146.001	33,5MM	25	56780.335.001
5,4MM	100	56780.054.001	15,4MM	100	56780.154.001	34,0MM	25	56780.340.001
6,0MM	100	56780.060.001	15,7MM	100	56780.157.001	35,5MM	100	56780.355.001
6,6MM	100	56780.066.001	16,8MM	100	56780.168.001	36,5MM	25	56780.365.001
7,0MM	100	56780.070.001	17,2MM	100	56780.172.001	39,5MM	25	56780.395.001
7,2MM	100	56780.072.001	18,8MM	100	56780.188.001	42,0MM	25	56780.420.001
7,3MM	100	56780.073.001	19,6MM	100	56780.196.001	43,3MM	25	56780.433.001
8,0MM	100	56780.080.001	20,0MM	50	56780.200.001	45,5MM	25	56780.455.001
8,5MM	100	56780.085.001	21,0MM	50	56780.210.001	45,8MM	25	56780.458.001
8,8MM	100	56780.088.001	22,3MM	50	56780.223.001	50,5MM	25	56780.505.001
9,3MM	100	56780.093.001	23,0MM	100	56780.230.001	52,0MM	25	56780.520.001
10,0MM	100	56780.100.001	24,0MM	50	56780.240.001	55,5MM	25	56780.555.001

56780		Cover plug		56780		Cover plug		
d_1	☒	Art.number	d_1	☒	Art.number	d_1	☒	Art.number
58,0MM	25	56780.580.001	70,0MM	25	56780.700.001	110,0MM	25	56780.960.001
61,5MM	25	56780.615.001	85,0MM	25	56780.850.001			

Protecting cap and -plug

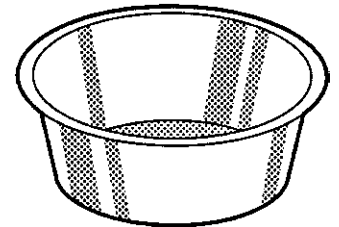
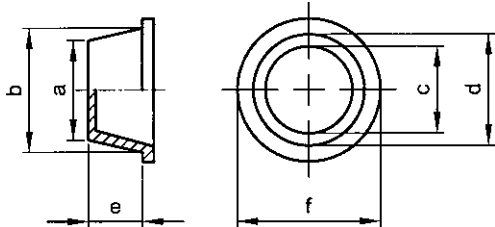

Technical Data

Type	a	b	c	d	e	f
M4CAP-M6PLUG	4.4	6.1	2.8	4.5	9.5	9.5
M6CAP-M8PLUG	6.2	7.7	5	5.9	9.5	11.1
M8CAP-M10PLUG	8.4	10	6.9	8.2	9.5	13.5
M10CAP-M12PLUG	10	11.3	8.5	10	9.5	15
M12CAP	12.1	13.9	10.6	12.3	11	17.5
M14CAP	14.2	16	12.7	14.4	12.1	19
M14PLUG	11.5	13	10	11.5	9.5	16.7
M16PLUG	13.6	15.4	12.1	13.7	11.2	19
M16CAP-M20PLUG	16.4	18.3	14.8	16.9	12.7	22.2
M18CAP	17.8	20	16.4	18.3	14.4	23.8
M18PLUG	14.7	17	13.2	15.4	12.7	20.6
M20CAP	21.3	23.2	19.2	21.5	15.9	27
M20PLUG	17.7	19.6	15.2	17.3	12.7	22.2
M22CAP	22	25	20.5	23	15.9	28.5
M22PLUG	18.5	20.9	17.1	19.3	14.3	24.6
M24PLUG	21.2	23.2	19.3	21.7	12.3	27.3
M24CAP-M27PLUG	23.4	26.4	21.4	24.4	17.5	29.3
M27CAP-M30PLUG	24.7	27.7	23.2	26.1	19	32
M30CAP-M33PLUG	30	32.6	27.5	30.9	15.5	36.7
M33CAP-M35PLUG	31.1	34.3	29.8	32.8	19	38.1
M35CAP-M36PLUG	33.3	37.2	32	35.6	22.6	41.5
M38CAP-M40PLUG	36.9	40.6	35	39	22.5	44
M39CAP-M45PLUG	39.4	42.7	38.2	41.1	19	47.6
M42CAP-M45PLUG	41.4	44.8	39.7	43	19	49.2
M45CAP-M48PLUG	44.5	47.3	42.9	46.2	19	50.8
M48PLUG	45.2	49.5	43.6	47.9	24.5	54
M48CAP-M52PLUG	48.6	51.2	46.7	48.9	18.7	55.5
M52CAP-M56PLUG	53.5	57	51.2	55.3	25.2	62.4
M56CAP-M60PLUG	54.5	61	52.2	59	25	65.1
M60CAP-M62PLUG	59.6	62.6	57	61	24.6	66.7
M75PLUG	70	75.8	68.1	74	25.4	79.4

- The tapered design of these products allows them to be used as either a cap or a plug, providing easy fitting and removal in most applications, they provides excellent protection against damage, dirt, moisture and corrosion, during storage and transportation.
- When used as a plug dimension b should be min. 5% larger than the opening, diameters over 30mm may require more interference.
- When used as a cap dimension c should be min. 5% less than the diameter to be capped, diameters over 30mm may require more interference.

56783		Protecting cap and -plug		W05B	
Material	Plastic Polyethylene				
Color	Red				

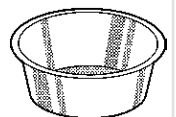

Type	☒	Art.number	Type	☒	Art.number	Type	☒	Art.number
M4CAP-M6PLUG	500	56783.040.060	M16PLUG	250	56783.160.002	M24PLUG	100	56783.240.002
M6CAP-M8PLUG	500	56783.060.080	M16CAP-M20PLUG	250	56783.160.200	M24CAP-M27PLUG	100	56783.240.270
M8CAP-M10PLUG	500	56783.080.100	M18CAP	250	56783.180.000	M27CAP-M30PLUG	100	56783.270.300
M10CAP-M12PLUG	500	56783.100.120	M18PLUG	250	56783.180.002	M30CAP-M33PLUG	100	56783.300.330
M12CAP	250	56783.120.000	M20CAP	100	56783.200.000	M33CAP-M35PLUG	50	56783.330.350
M14CAP	250	56783.140.000	M20PLUG	100	56783.200.002	M35CAP-M36PLUG	50	56783.350.360
M14PLUG	250	56783.140.002	M22PLUG	100	56783.220.002	M38CAP-M40PLUG	50	56783.380.400

56783 Protecting cap and -plug ←								
Type	☒	Art.number	Type	☒	Art.number	Type	☒	Art.number
M39CAP-M45PLUG	50	56783.390.450	M48PLUG	25	56783.480.002	M58CAP-M60PLUG	25	56783.580.600
M42CAP-M45PLUG	50	56783.420.450	M48CAP-M52PLUG	25	56783.480.520	M60CAP-M62PLUG	25	56783.600.620
M45CAP-M48PLUG	25	56783.450.480	M52CAP-M56PLUG	25	56783.520.560	M75PLUG	25	56783.750.002

Vertical acting toggle clamp



Article groups				
Material	Surface treatment		Code	Page
St	Zipl	horizontal base	15900	12-151
St	Zipl	angle base	15905	12-152

15900 Vertical acting toggle clamp 6800				F97A
Material	Steel			
Surface treatment	Zinc plated			

Type	A	B	C	D	E	F	F1 [kN]	F2 [kN]	H	H1	HW min.	HW max.	I	K	L	L1	L2	M	M1	N	P	α	α*	Clamping screw
0	4	31	11,0	4,5	14	5,5	0,5	0,7	18,0	81,0	-1,5	3,5	8	5,5	-	49	50	23	-	32	22	95°	-	M 4x 25
1	5	39	16,0	4,5	18	6,0	0,6	1,1	19,0	98,5	-4,0	2,0	10	5,5	-	61	59	24	-	35	27	95°	-	M 5x 30
2	6	52	20,0	5,5	25	11,0	0,8	1,2	23,0	130	-3,0	4,5	12	6,0	12,5	78	80	27	27	43	32	105°	60°	M 6x 35
3	8	79	20,0	7,5	36	19,0	1,2	2,5	33,0	186	2,0	11,0	18	7,5	-	112	112	32	-	46	35	105°	60°	M 8x 45
4	10	101	32,0	8,6	54	16,0	1,7	3,0	42,5	221	-6,0	22,5	20	13,0	-	141	130	45	-	64	53	105°	60°	M 8x 65
5	14	140	45,0	8,5	73	34,0	3,0	5,0	55,8	281	-3,0	27,5	25	9,5	29,0	195	185	49	45	70	65	115°	60°	M12x 80
6	14	165	50,5	13,0	89	26,0	3,4	5,5	81,0	332	-2,5	55,0	30	24,5	-	231	207	71	-	100	90	140°	60°	M12x110

* The opening angle can be changed by pressing in a stop pin.

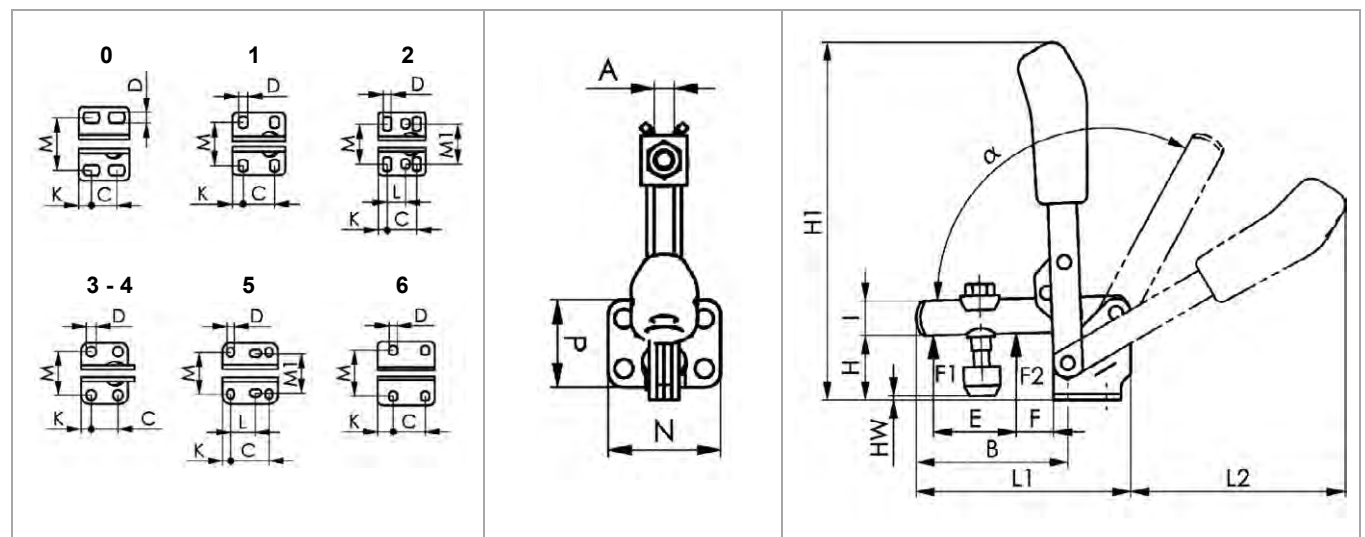

Type	☒	Art.number	Type	☒	Art.number	Type	☒	Art.number
NO.0	1	15900.000.100	NO.3	1	15900.000.103	NO.5	1	15900.000.105
NO.1	1	15900.000.101	NO.4	1	15900.000.104	NO.6	1	15900.000.106
NO.2	1	15900.000.102						

15900 Vertical acting toggle clamp 6800



- With open clamping arm and horizontal base.
- Supplied complete with tempered, galvanized clamping screw.

15905 Vertical acting toggle clamp 6803

F97A

Material Steel
Surface treatment Zinc plated



Type	A	B	C	D	E	F	F1 [kN]	F2 [kN]	H	H1	HW min.	HW max.	I	K	L1	L2	M	N	O	P	α	α^*	Clamping screw
1	5	34	14	4,5	19	8	0,8	1,1	47	132	-1,5	5,5	10	10	60	58	20,0	30	5	30	105°	-	M5x30
2	6	40	20	5,5	25	9	1,0	1,2	61	180	2,0	11,0	12	6	78	63	25,5	38	5	32	105°	60°	M6x35
3	8	65	24	6,5	43	11	1,4	2,5	71	243	6,0	18,0	18	7	112	111	28,5	43	6	38	105°	60°	M8x45
4	10	84	32	8,5	50	17	2,0	3,0	102	280	11,0	40,0	20	54	140	129	32,0	52	8	96	105°	60°	M8x65

* The opening angle can be changed by pressing in a stop pin.

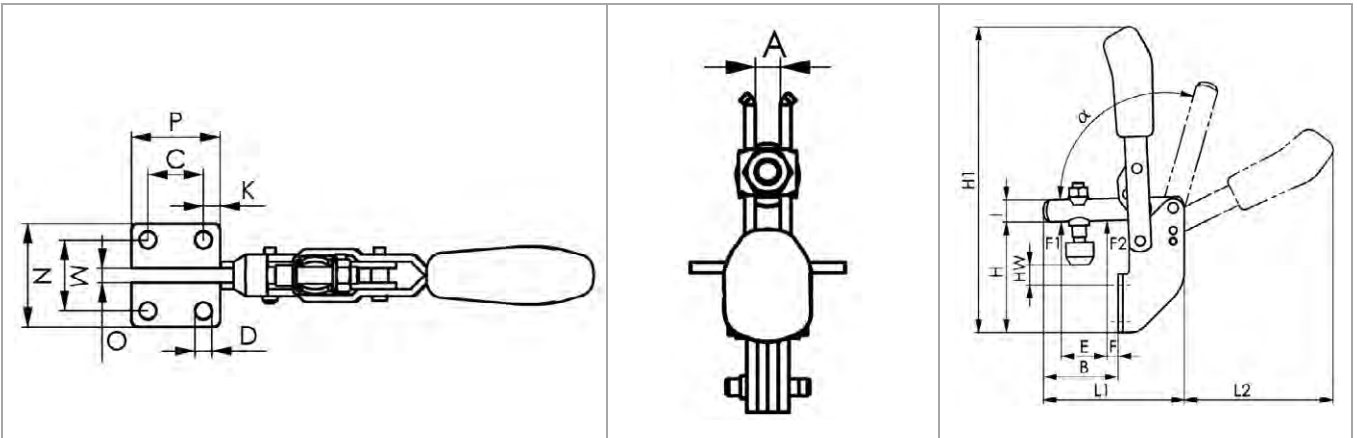

Type	☒	Art.number	Type	☒	Art.number	Type	☒	Art.number
NO.1	1	15905.000.101	NO.3	1	15905.000.103	NO.4	1	15905.000.104
NO.2	1	15905.000.102						

- With open clamping arm and angle base.
- Supplied complete with tempered, galvanized clamping screw.

Horizontal acting toggle clamp



Article groups

Material	Surface treatment		Code	Page
St	Zipl	horizontal base	15910	12-153
St	Zipl	horizontal base	15916	12-154
St	Zipl	angle base	15915	12-155

15910 Horizontal acting toggle clamp 6830

F97A

Material Steel
Surface treatment Zinc plated



Type	A	B	C	D	D1	E	F	F1 [kN]	F2 [kN]	H	H1	H2	HW min.	HW max.	I	K	L	L1	M	M1	N	P	α	Clamping screw
0	5	28	13,5	4,6	-	9,0	5	0,25	0,4	14,5	23,0	34	-5,0	1	7,5	6,3	-	79	16,0	-	25,0	25,5	90°	M4x25
1	5	42	14,0	5,2	-	18,5	8	0,8	1,1	19,0	30,0	49	-4,0	2	10,0	5,5	-	120	20,3	-	34,0	34,0	90°	M5x30
2	6	64	26,0	5,6	5,6	32,0	16	1,0	1,2	24,0	45,0	68	-1,5	5	13,0	6,0	12,7	162	24,5	28,5	42,0	38,0	90°	M6x35
3	8	73	25,7	6,5	5,1	36,0	15	1,8	2,5	32,0	48,5	86	-2,0	9,0	15,0	7,0	13	206	26,8	31,6	44,5	50,0	90°	M8x45
4	10	113	41,0	8,5	8,5	63,0	27	2,0	3,0	45,0	75,0	115	-4,0	24	20,0	8,0	20,5	281	36,0	43,0	58,0	57,0	90°	M8x65
5	10	123	41,5	8,5	-	78,0	16	3,0	5,0	46,0	73,0	128	-1,5	25	25,0	12,5	-	321	41,5	-	58,0	77,0	90°	M8x65

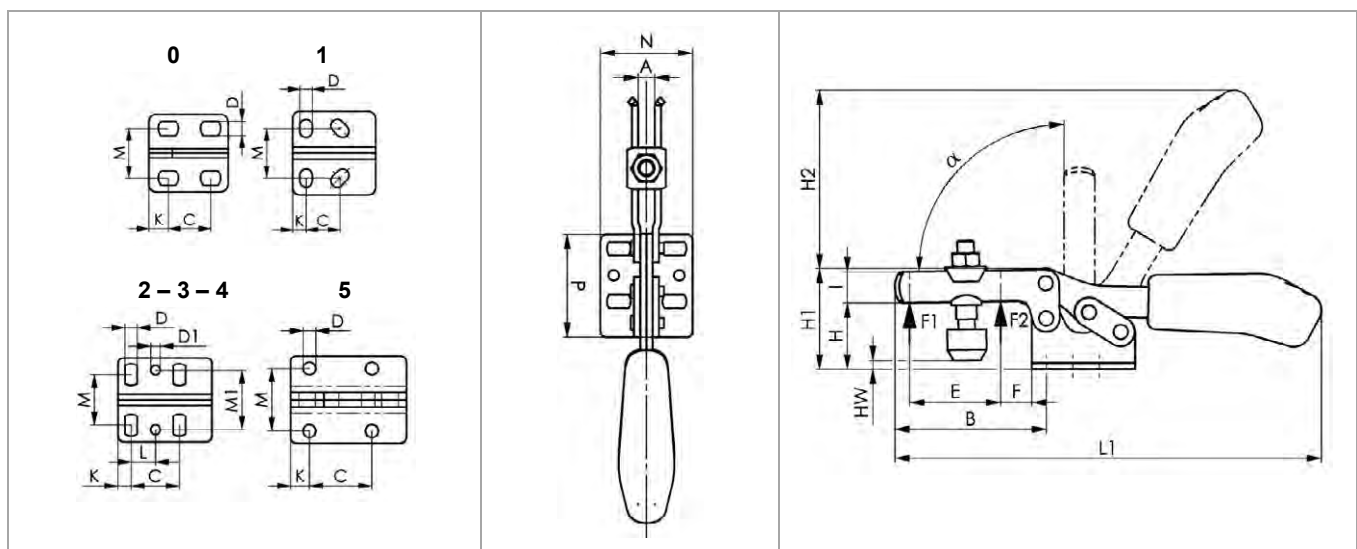

Type	☒	Art.number	Type	☒	Art.number	Type	☒	Art.number
NO.0	1	15910.000.100	NO.2	1	15910.000.102	NO.4	1	15910.000.104
NO.1	1	15910.000.101	NO.3	1	15910.000.103	NO.5	1	15910.000.105

- With open clamping arm and horizontal base.
- Supplied complete with tempered, galvanized clamping screw.

15916 Horizontal acting toggle clamp 6834
F97A

Material Steel
Surface treatment Zinc plated



Type	A	B	C	D	D1	E	F	F1 [kN]	F2 [kN]	H	H1	H2	HW min.	HW max.	I	K	L	L1	M	M1	N	P	α	Clamping screw
2	5	63	26,0	5,6	5,6	35	16,0	1,0	1,2	24	45,0	68	-4,0	4	13	6,0	12,7	161	24,5	28,5	42	38	90°	M 6x35
3	6	72	26,0	6,5	5,1	44	15,0	1,8	2,5	32	48,5	86	-3,5	9	15	7,0	13,0	205	27,0	32,0	45	50	90°	M 8x45
4	8	111	41,0	8,5	8,5	66	26,0	2,0	3,0	45	75,0	114	-6,0	22	20	8,0	20,5	280	36,0	43,0	58	57	90°	M 8x65
5	10	121	41,5	8,0	-	78	17,5	3,0	5,0	46	73,0	128	-13,0	12	25	12,5	-	320	41,5	-	58	77	90°	M12x80

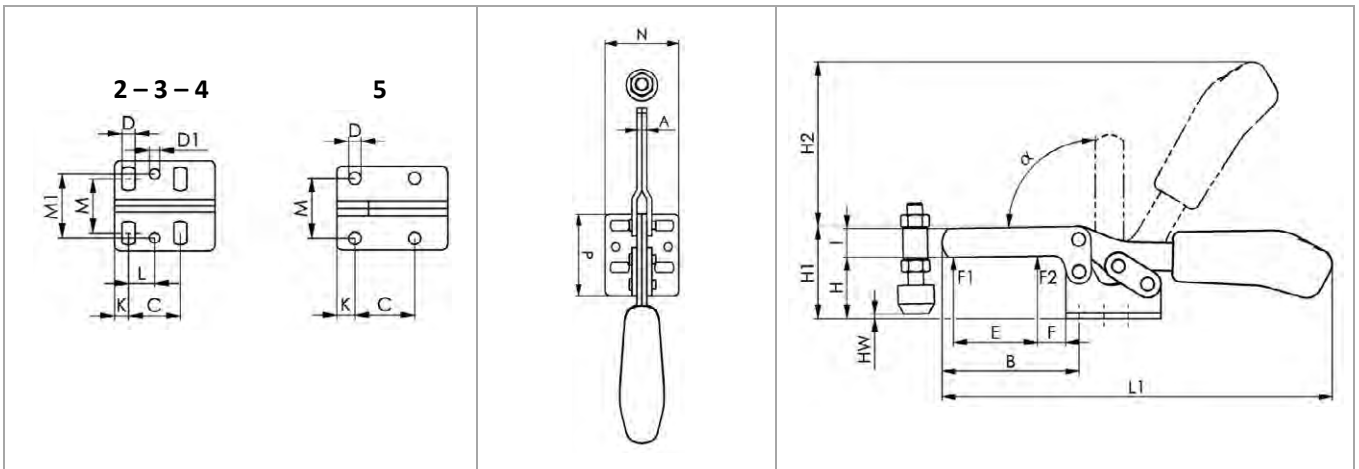

Type	☒	Art.number	Type	☒	Art.number	Type	☒	Art.number
NO.2	1	15916.000.102	NO.4	1	15916.000.104	NO.5	1	15916.000.105
NO.3	1	15916.000.103						

- With open clamping arm and horizontal base.
- Supplied complete with tempered, galvanized clamping screw no. 6885 and sleeve to weld on.

15915 Horizontal acting toggle clamp 6833
F97A

Material Steel
Surface treatment Zinc plated



Type	A	B	C	D	E	F	F1 [kN]	F2 [kN]	H	H1	H2	HW min.	HW max.	I	K	L1	M	N	P	α	Clamping screw
1	5	32	13,5	5,2	18,5	4,0	0,8	1,1	57	68	49	14	20	10	8	120	19,0	31	28	90°	M5x30
2	6	52	20,0	5,6	32,0	10,5	1,0	1,2	73	94	68	22	29	13	6	162	25,5	37	32	90°	M6x35
3	8	59	24,0	6,8	37,0	8,0	1,8	2,5	70	86	86	5	16	15	7	206	29,0	43	38	90°	M8x45
4	10	93	32,0	8,5	63,0	15,0	2,0	3,0	102	133	115	11	40	20	40	282	32,0	52	82	90°	M8x65

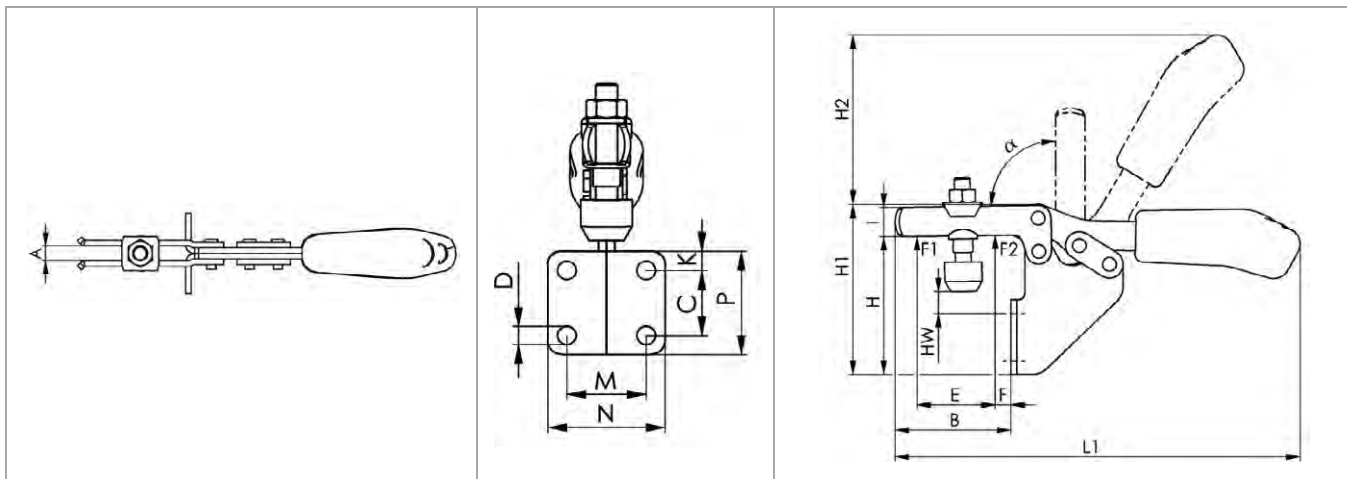

Type	☒	Art.number	Type	☒	Art.number	Type	☒	Art.number
NO.1	1	15915.000.101	NO.3	1	15915.000.103	NO.4	1	15915.000.104
NO.2	1	15915.000.102						

- With open clamping arm and angle base.
- Supplied complete with tempered, galvanized clamping screw.

Push-pull type toggle clamp



Article groups

Material	Surface treatment		Code	Page
St	Zipl	small angle base	15920	12-156
St	Zipl	short version	15925	12-157
St	Zipl	heavy duty type	15930	12-158

15920 Push-pull type toggle clamp 6841

F97A

Material Steel
Surface treatment Zinc plated



Type	A	B min.	B max.	D	E	F1 [kN]	F2 [kN]	H	H1	HUB	HW min.	HW max.	K	L1	L2	L3	M min.	M max.	M2	N	P	Clamping screw
0	6,5	17,0	33,0	4,5	13	0,8	0,8	12	47	16	12	20	6,5	66,0	10	52	-	16,0	M10x1,0	25	16	M 4x20
1	8,0	24,5	44,5	4,5	20	1,0	1,0	15	60	20	12	20	7,0	91,0	16	72	16	19,5	M12x1,5	30	20	M 4x20
2	10,0	32,5	57,5	5,6	25	2,0	2,0	20	95	26	17	25	12,5	114,0	19	105	-	36,0	M16x1,5	50	34	M 6x25
3	12,0	37,0	69,0	6,5	30	2,5	2,5	25	110	32	22	35	13,0	140,0	22	129	30	42,0	M20x1,5	60	30	M 8x35
5-M27	16,0	41,5	81,5	8,5	50	4,5	4,5	30	126	40	30	50	15,0	171,5	25	142	30	45,0	M27x2,0	65	35	M12x50

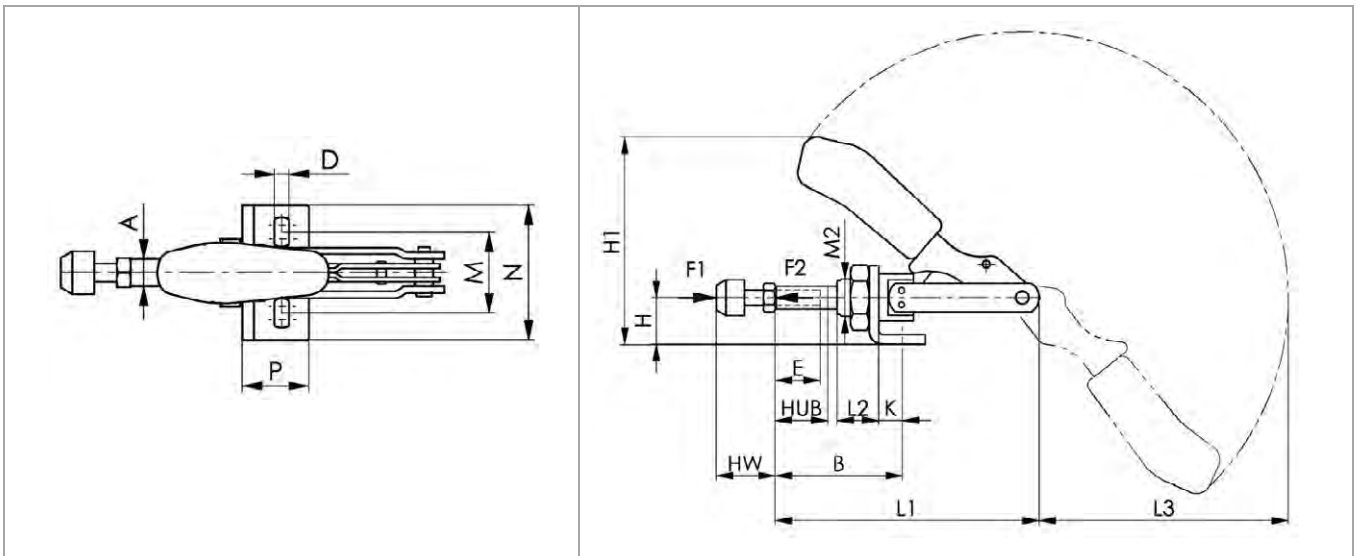

Type	☒	Art.number	Type	☒	Art.number	Type	☒	Art.number
NO.0	1	15920.000.100	NO.2	1	15920.000.102	NO.5	1	15920.000.105
NO.1	1	15920.000.101	NO.3	1	15920.000.103	NO.5-M27	1	15920.000.527

- With small angle base.
- For push- and pull-clamping.
- Supplied complete with tempered, galvanized clamping screw.

15925 Push-pull type toggle clamp 6844
F97A

Material Steel
Surface treatment Zinc plated



Type	A	B	E	F1 [kN]	F2 [kN]	H	H1	HUB	HW min.	HW max.	L1	L2	L3	M	M2	N	Clamping screw
2	10	35	15	1,0	1,0	24	76	21	18	27	70	13	82	M 6	M16x1,5	31	M 6x25
3	12	56	25	2,5	2,5	33	128	40	22	35	110	16	130	M 8	M20x1,5	33	M 8x35
5-M27	16	92	35	4,0	4,0	37	148	67	30	50	175	24	138	M12	M27x2,0	50	M12x50

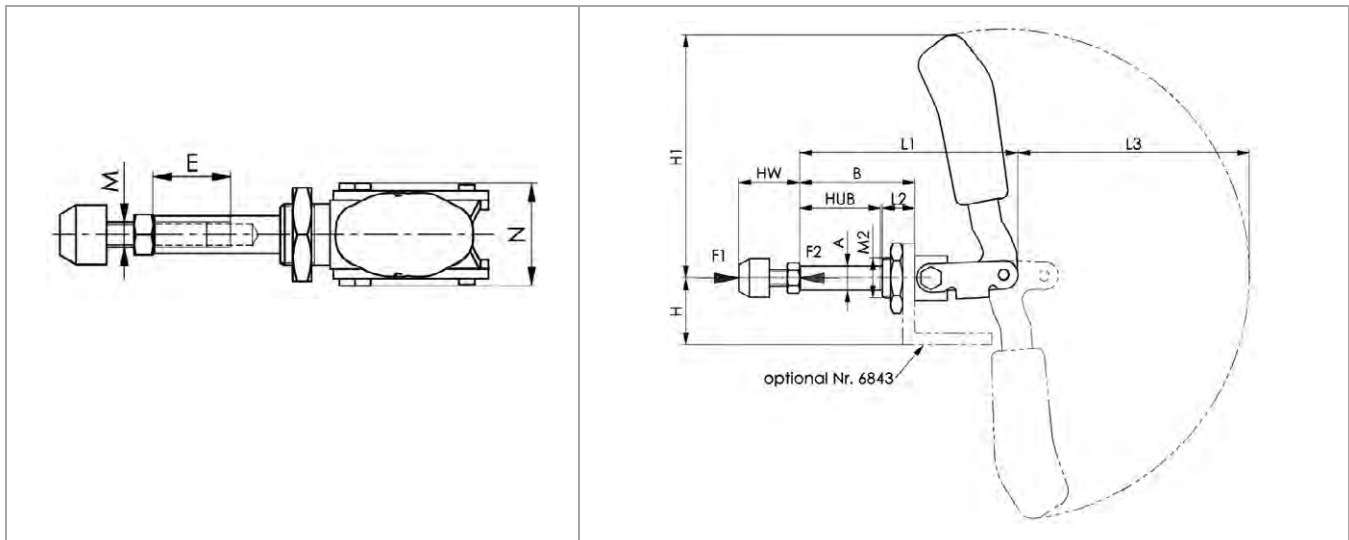

Type	☒	Art.number	Type	☒	Art.number	Type	☒	Art.number
NO.2	1	15925.000.102	NO.5	1	15925.000.105	NO.5-M27	1	15925.000.527
NO.3	1	15925.000.103						

- Short version.
- For push- and pull-clamping.
- Supplied complete with tempered, galvanized clamping screw.

15930 Push-pull type toggle clamp 6842
F97A

Material Steel
Surface treatment Zinc plated



Type	A	B min.	B max.	C	D	E	F1 [kN]	F2 [kN]	H	H1	HUB	HW min.	HW max.	K	L1	L2	M min.	M max.	N	P	Clamping screw
3	12	40	72	41	6,5	30	4	4	30	115	32	35	48	28	140	130	36	44	60	96	M 8x35
5	16	58	98	41	8,5	50	10	10	38	134	40	30	50	46	172	140	41	50	70	122	M12x50
7	22	59	105	70	11,0	50	25	25	55	180	50	30	50	45	218	192	57	65	93	158	M12x50

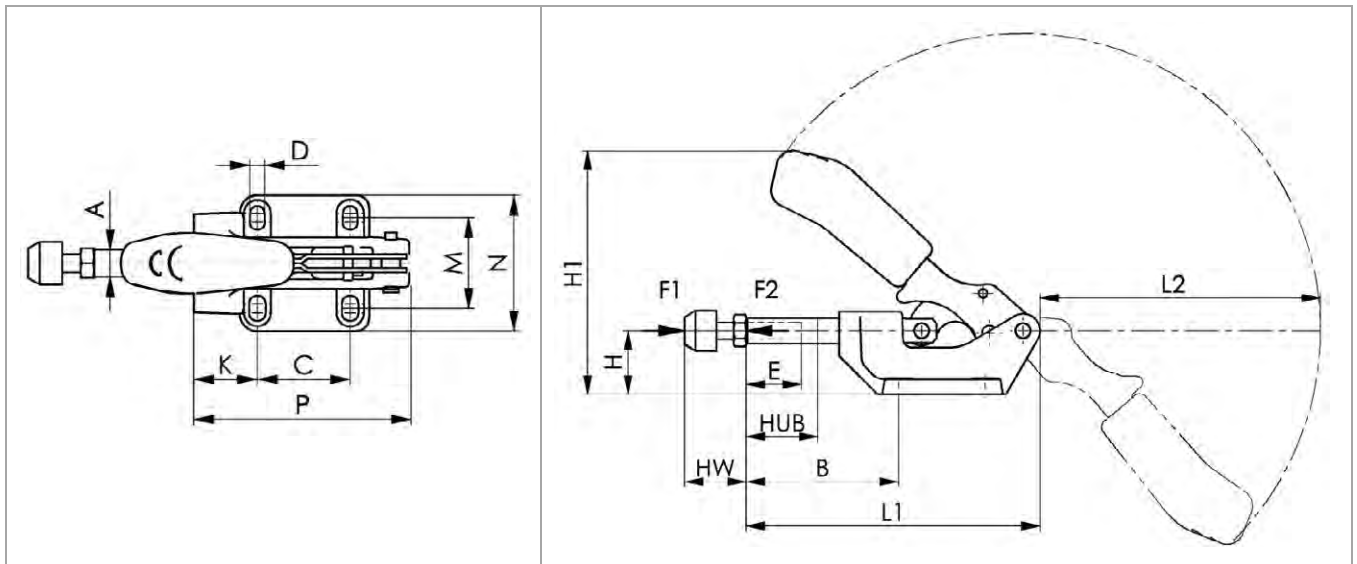

Type	☒	Art.number	Type	☒	Art.number	Type	☒	Art.number
NO.3	1	15930.000.103	NO.5	1	15930.000.105	NO.7	1	15930.000.107

- For push- and pull-clamping.
- Heavy duty type with rod-guide.
- Supplied complete with tempered, galvanized clamping screw.

Hook type toggle clamp



15935 Hook type toggle clamp 6847

F97A

Material Steel
Surface treatment Zinc plated



Type	B1	B2	C	D	E1	E2	F1 [kN]	G	H	H1	K	L	L1	M	N	R	S	Adjustm.distance [mm]
1	15-23	34-42	19	5,3	15-23	34,0-42,0	2	4,5	22,5	33	6	31	130	28	41	4,5	45	8
3	32-44	67-79	19	7,1	40-52	74,5-86,5	3	5,5	23,0	36	13	40	230	32-35	46	5,5	98	12
5	26-40	57-71	29	12,0	28-42	58,5-72,5	5	11,0	49,0	70	13	55	308	60	88	8,0	144	14

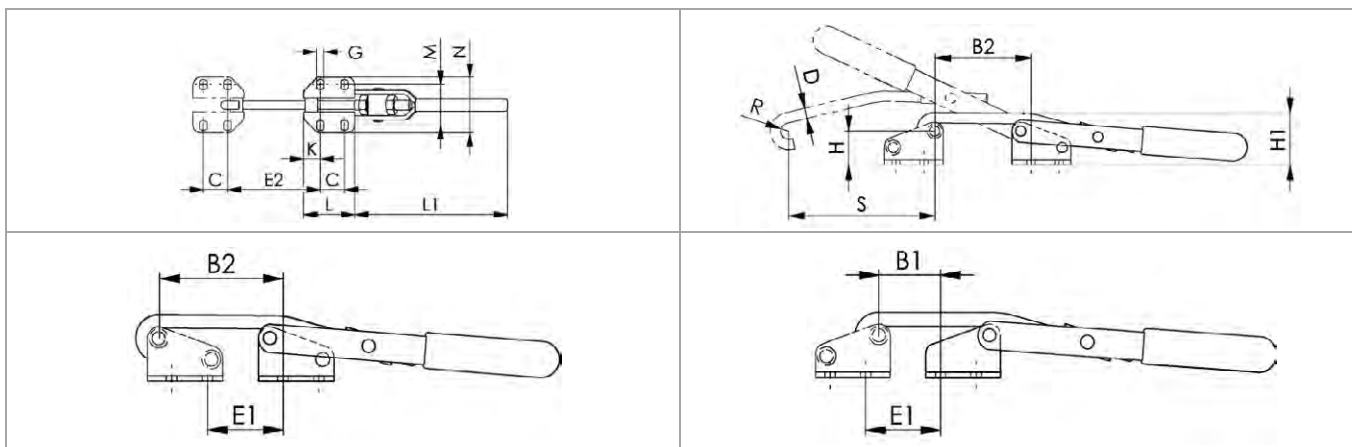

Type	Art.number	Type	Art.number	Type	Art.number
NO.1	1 15935.000.101	NO.3	1 15935.000.103	NO.5	1 15935.000.105

- For counter catch: see article group 15940.

Hook type toggle clamp horizontal



15945	Hook type toggle clamp horizontal 6848H	F97A
Material	Steel	
Surface treatment	Zinc plated	



Type	B min.	B max.	C	D	D1	E min.	E max.	F	F1 [kN]	G	H	H1	K	L1	L5	M	N	P	S
2	42	74	13	5,2	4	38	70	11	1,6	19	12	47	6,5	156	70	24	38	26	23
3	53	95	19	6,5	6	48	90	14	3,2	25	19	70	8,0	210	95	32	48	35	30
4	72	127	32	8,5	8	65	120	19	7,0	36	25	92	9,5	270	113	45	65	51	44

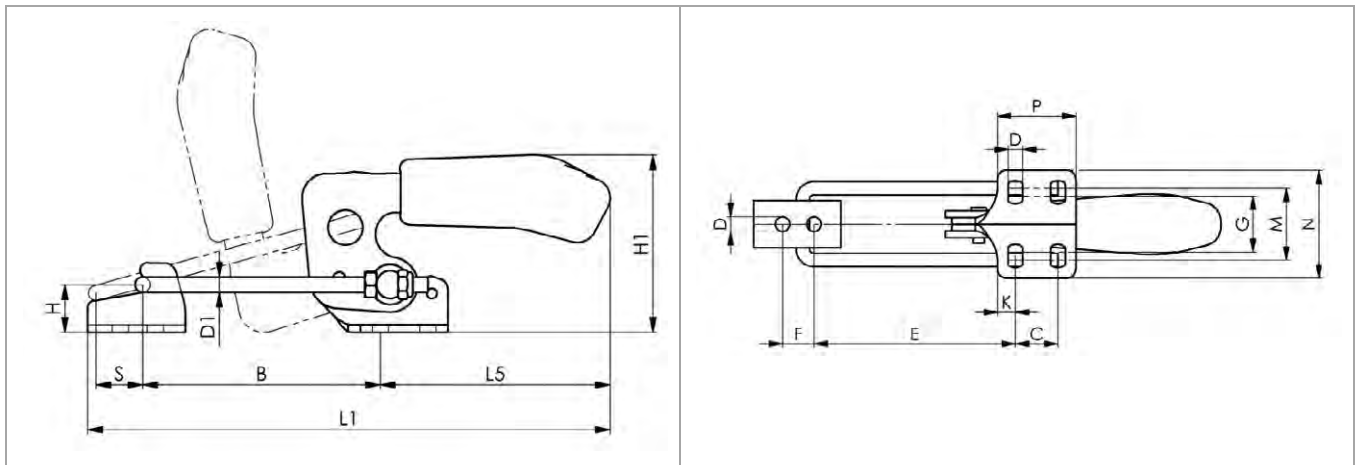

Type	☒	Art.number	Type	☒	Art.number	Type	☒	Art.number
NO.2	1	15945.000.102	NO.3	1	15945.000.103	NO.4	1	15945.000.104

- Supplied complete with counter catch

Hook type toggle clamp vertical



15950 Hook type toggle clamp vertical 6848V

F97A

Material Steel
Surface treatment Zinc plated



Type	B min.	B max.	C	D	D1	E min.	E max.	F1 [kN]	F	G	H	H1	K	L1	M	N	P	S
2	24	47	13	5,2	4	5	28	1,6	11	19	4,5	47	7,0	90	24	38	26	23
3	33	61	19	6,5	6	7	35	3,2	14	25	6,0	70	8,0	127	32	48	35	30
4	43	79	32	8,5	8	9	45	7,0	19	36	8,0	92	9,5	150	45	65	51	40

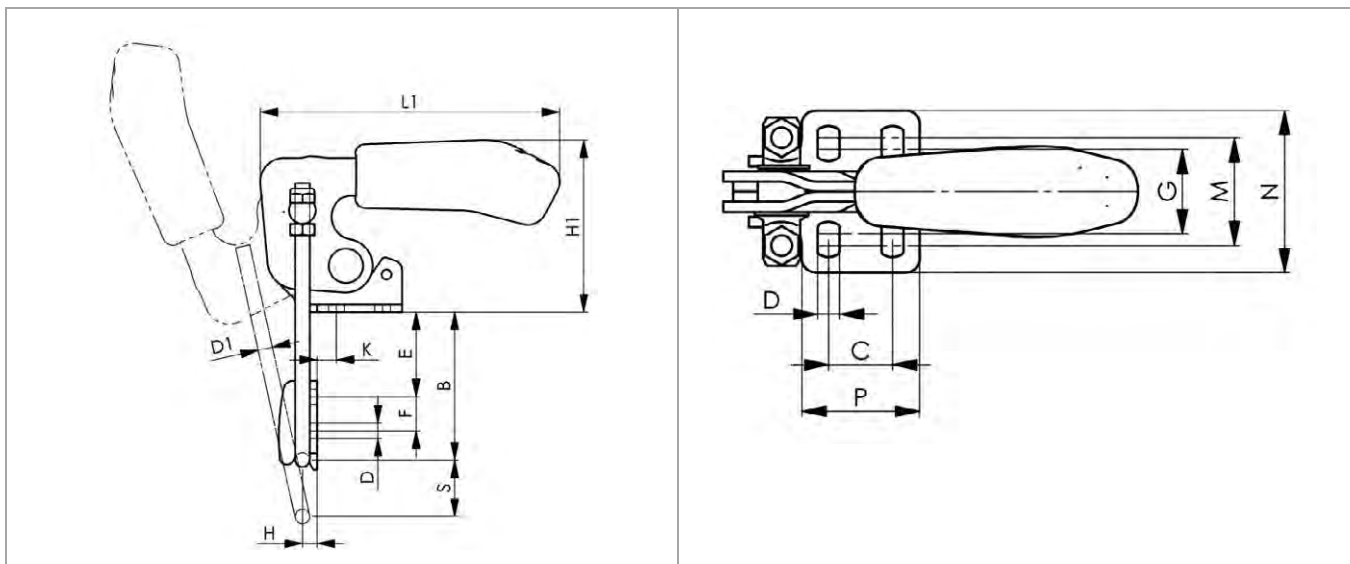

Type	☒	Art.number	Type	☒	Art.number	Type	☒	Art.number
NO.2	1	15950.000.102	NO.3	1	15950.000.103	NO.4	1	15950.000.104

- Supplied complete with counter catch

Counter catch for hook type toggle clamp



15940	Counter catch for hook type toggle clamp 6847	F97A
Material	Steel	
Surface treatment	Zinc plated	

Type	B	C	D	G	H	K	L	M	N	O
1	6	19	8	4,5	22,5	6	31	28	41	6,8
3	6	19	10	5,5	23,0	13	40	32-35	46	10,8
5	12	29	15	11,0	49,0	13	55	60	88	13,7



Type	☒	Art.number	Type	☒	Art.number	Type	☒	Art.number
NO.1	1	15940.000.101	NO.3	1	15940.000.103	NO.5	1	15940.000.105

- Suitable for hook type toggle clamp, see article group 15935.

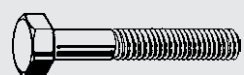

1 Bolts



2 Hexagon socket products



3 Nuts, rivet nuts & inserts



4 Threaded rods & studbolts



5 Hook & eye products



6 Screws

I Index



7 Washers & O-rings



8 Anchoring products

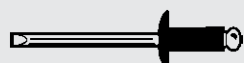

9 Rivets, pins & keys



10 Systems, furniture & security fasteners



11 Assortments & storage systems

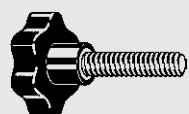

12 Engineering parts & machine parts

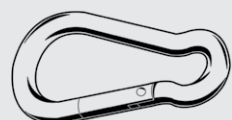





























13 Maritime products

T Fastening technology

Maritime products **13**

 Page 13-3 Trailer hook	 Page 13-4 D-shackle	 Page 13-8 Bow shackle	 Page 13-10 D-shackle twisted	 Page 13-11 D-shackle with pin
 Page 13-12 Multi purpose shackle key	 Page 13-13 Spring hook	 Page 13-16 Buoy hook	 Page 13-17 Spring snap	 Page 13-18 Spring hook asymmetric
 Page 13-20 Spring hook with nut	 Page 13-21 Spring hook	 Page 13-22 Spring hook special closure	 Page 13-23 Musketon	 Page 13-24 Spring hook with double locking equipment
 Page 13-25 Swivel snap shackle	 Page 13-27 Swivel snap shackle	 Page 13-28 Swivel	 Page 13-31 Waterski hook	 Page 13-32 Spring hook aluminium
 Page 13-33 Eight descender	 Page 13-34 Simplex spring hook	 Page 13-35 Rope shortener	 Page 13-36 Turnbuckle	 Page 13-38 Slip hook with ring
 Page 13-39 Turnbuckle sleeve	 Page 13-40 Turnbuckle	 Page 13-42 Turnbuckle	 Page 13-43 Swage stud	 Page 13-46 T-Terminal
 Page 13-47 Toggle	 Page 13-49 Toggle for turnbuckles	 Page 13-50 Stay adjuster	 Page 13-51 Pelican hook with thread	 Page 13-52 Pelican hook
 Page 13-53 Quick attach terminal	 Page 13-54 Wire rope	 Page 13-56 Wire rope cutter	 Page 13-56 Wire thimble	 Page 13-58 Wire rope clip
 Page 13-60 Ferrule	 Page 13-62 Hand swager and swaging die	 Page 13-63 Safety pin	 Page 13-66 SECURITY wire	 Page 13-67 Spring cotter pin
 Page 13-68 Ring pin	 Page 13-69 ESS Universal rail turnbuckle	 Page 13-70 ESS Terminal	 Page 13-74 ESS Terminal with head	 Page 13-75 ESS Dowel screw

Maritime products **13**

 Page 13-76 ESS Nut for turnbuckle	 Page 13-77 ESS Cross wire rope clip	 Page 13-78 ESS Solid ball	 Page 13-79 ESS Combination wall bracket	 Page 13-80 ESS Ground plate for wall bracket
 Page 13-81 Hinge	 Page 13-84 Hinge	 Page 13-87 Hinge	 Page 13-88 Hinge	 Page 13-91 Hinge
 Page 13-92 Hinge	 Page 13-93 Hinge	 Page 13-95 Hinge	 Page 13-96 Hinge	 Page 13-97 Hinge
 Page 13-98 Hinge, cast	 Page 13-101 Hinge with thread, cast	 Page 13-104 Covered hinge	 Page 13-105 Continuous hinge	 Page 13-106 Hasp
 Page 13-107 Swivel hasp	 Page 13-109 Latch	 Page 13-110 Lifting ring	 Page 13-112 Lifting ring	 Page 13-113 Gate hook
 Page 13-114 Coat hook	 Page 13-117 Coat hook	 Page 13-118 S-hook	 Page 13-120 Plain cup hook	 Page 13-121 Awning hook
 Page 13-122 Bracket	 Page 13-123 Short cord hook	 Page 13-124 Hook with thread	 Page 13-125 Transom mount ski tow	 Page 13-126 Door holder
 Page 13-128 Boat hook holder	 Page 13-129 Folding pad eye	 Page 13-130 Ring	 Page 13-133 Ring nail	 Page 13-134 Handle
 Page 13-135 Chain	 Page 13-136 Quick link for chains			

Trailer hook



Technical Data

Nr.	A	B	C	D	E	≈ Breaking load (N)
54100.028.001	28	17	18	69	147	20.000
54100.036.001	36	36	33	97	193	37.000
54101.019.001	19	33.5	100	20.5	-	15.000
54101.028.001	28	44.5	115	23	-	18.000

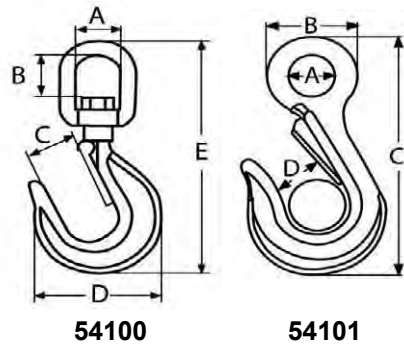

Article groups

Material	Code	Page
St.St. A4	54100	13-3
St.St. A4	54101	13-3

54100	Trailer hook with swivel	MH11
Material	Stainless steel A4	
		

A	☒	Art.number	A	☒	Art.number
28MM*	1	54100.028.001	36MM*	1	54100.036.001

54101	Trailer hook	MH11
Material	Stainless steel A4	
		

A	☒	Art.number	A	☒	Art.number
19MM*	5	54101.019.001	28MM*	5	54101.028.001

D-shackle



Technical Data

Nr.	A	B	L	ø	≈ Breaking load (N)
54102.050.001	25	-	20	5	7.500
54102.060.001	24	-	33	6	13.500
54102.080.001	26	-	31	8	25.000
54102.100.001	41	-	55	10	33.500
54102.120.001	50	-	66	12	40.000
54104.040.001	8	16	14	4	7.000
54104.050.001	19	20	14.5	5	10.000
54104.060.001	12	24	21	6	15.000
54104.080.001	16	32	28	8	30.000
54104.100.001	20	40	36	10	45.000
54104.120.001	24	48	44	12	70.000
54104.160.001	32	64	56	16	100.000
54104.190.001	35	76	65.5	19	160.000
54105.050.001	10	20	16.5	5	11.000
54105.060.001	12	24	21	6	16.000
54105.080.001	16	32	28	8	32.000
54105.100.001	20	40	34	10	49.000
54105.120.001	24	48	36	12	66.000
54106.050.001	10	20	16.5	5	10.000
54106.060.001	12	24	18	6	15.000
54106.080.001	16	32	28	8	22.000
54106.100.001	20	40	35	10	37.000
54106.120.001	24	48	45	12	54.000
54106.140.001	28	56	49	14	65.000
54106.160.001	32	64	52	16	88.000
54106.190.001	38	76	63.5	19	160.000
54106.220.001	44	88	76	22	190.000
54107.040.001	8	16	15	4	10.800
54107.050.001	10	20	17.5	5	15.500
54107.060.001	12	24	21	6	18.600
54107.080.001	16	32	29	8	43.800
54107.100.001	20	40	35	10	58.000
54107.120.001	24	48	43	12	81.000
54109.048.001	9.7	5	19	6.4	13.200
54109.064.001	12	6	22	8	20.000
54109.080.001	13.5	8	26	9.5	30.000
54109.096.001	17	10	32	11	40.000
54109.127.001	21	12	41	16	80.000
54109.160.001	27	16	51	19	120.000
54109.190.001	32	20	60	22	160.000
54109.220.001	36	22	71	25	200.000
54112.040.001	8.5	-	31.3	4	7.000
54112.050.001	10	-	40	5	10.000
54112.060.001	12	-	48	6	15.000
54112.080.001	16	-	64	8	32.000
54112.100.001	20	-	80	10	49.000
54112.120.001	24	-	96	12	70.000
54113.050.001	10	-	37.5	5	11.000
54113.060.001	12	-	43	6	16.000
54113.080.001	16	-	60	8	32.000
54113.100.001	20	-	75	10	49.000
54113.120.001	24	-	90	12	66.000
54115.050.001	12	2.6	18.5	5	4.000
54115.060.001	14	3	22	6	5.000
54115.080.001	18	3.7	28	8	9.000
54116.040.001	10	-	15	4	8.000
54116.050.001	12	-	17.5	5	11.000

Technical Data

Nr.	A	B	L	∅	≈ Breaking load (N)
54116.060.001	16	-	21	6	20.000
54117.040.001	12	-	24	4	8.000
54117.050.001	16	-	21	5	11.000
54117.060.001	17	-	26	6	20.000

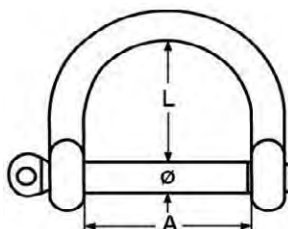

54102

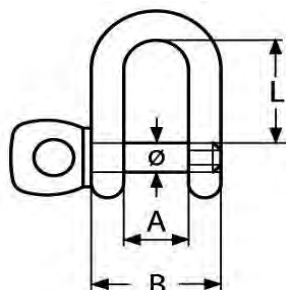

54104-5-7

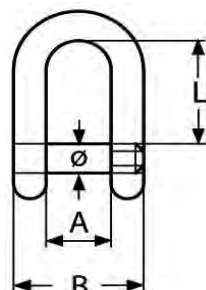

54106

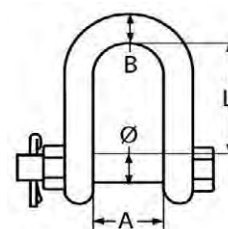

54109

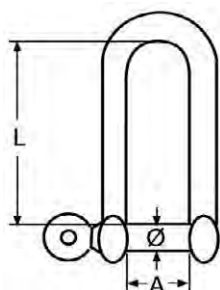

54112-3

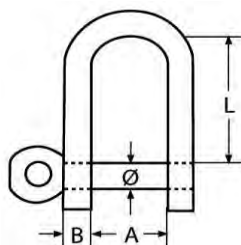

54115

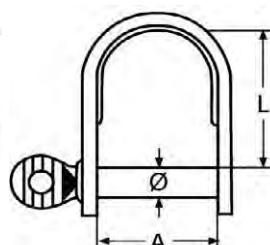

54116

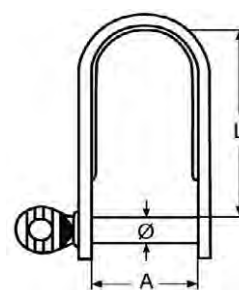

54117

Article groups

Material	Code	Page
St.St. A4	54102	13-5
St.St. A4	54104	13-6
St.St. A4	54105	13-6
St.St. A4	54106	13-6
St.St. A4	54107	13-6
St.St. A4	54109	13-6
St.St. A4	54112	13-6
St.St. A4	54113	13-7
St.St. A4	54115	13-7
St.St. A4	54116	13-7
St.St. A4	54117	13-7

54102 D-shackle wide

MH11

Material Stainless steel A4



∅	☒	Art.number	∅	☒	Art.number	∅	☒	Art.number
5MM*	10	54102.050.001	8MM*	10	54102.080.001	12MM*	5	54102.120.001
6MM*	10	54102.060.001	10MM*	5	54102.100.001			

54104 Straight D-shackle short MH11

Material Stainless steel A4

∅	☒	Art.number	∅	☒	Art.number	∅	☒	Art.number
4MM*	50	54104.040.001	8MM*	20	54104.080.001	16MM*	10	54104.160.001
5MM*	50	54104.050.001	10MM*	20	54104.100.001	19MM*	10	54104.190.001
6MM*	50	54104.060.001	12MM*	20	54104.120.001			

54105 Straight D-shackle with captive pin MH11

Material Stainless steel A4

∅	☒	Art.number	∅	☒	Art.number	∅	☒	Art.number
5MM*	10	54105.050.001	8MM*	10	54105.080.001	12MM*	5	54105.120.001
6MM*	10	54105.060.001	10MM*	5	54105.100.001			

54106 Straight D-shackle with hexagon socket MH11

Material Stainless steel A4

∅	☒	Art.number	∅	☒	Art.number	∅	☒	Art.number
5MM*	10	54106.050.001	10MM*	5	54106.100.001	16MM*	5	54106.160.001
6MM*	10	54106.060.001	12MM*	5	54106.120.001	19MM*	1	54106.190.001
8MM*	10	54106.080.001	14MM*	5	54106.140.001	22MM*	1	54106.220.001

54107 Straight D-shackle, forged MH11

Material Stainless steel A4

∅	☒	Art.number	∅	☒	Art.number	∅	☒	Art.number
4MM*	10	54107.040.001	6MM*	10	54107.060.001	10MM*	5	54107.100.001
5MM*	10	54107.050.001	8MM*	10	54107.080.001	12MM*	5	54107.120.001

54109 D-shackle with fastening bolt, forged MH11

Material Stainless steel A4

∅	☒	Art.number	∅	☒	Art.number	∅	☒	Art.number
4,8MM*	10	54109.048.001	9,5MM*	5	54109.096.001	19MM*	1	54109.190.001
6,4MM*	10	54109.064.001	12,7MM*	5	54109.127.001	22MM*	1	54109.220.001
8MM*	10	54109.080.001	16MM*	5	54109.160.001			

54112 Straight D-shackle long MH11

Material Stainless steel A4

∅	⊠	Art.number	∅	⊠	Art.number	∅	⊠	Art.number
4MM*	10	54112.040.001	6MM*	10	54112.060.001	10MM*	5	54112.100.001
5MM*	10	54112.050.001	8MM*	10	54112.080.001	12MM*	5	54112.120.001

54113 Straight D-shackle long with captive pin MH11

Material: Stainless steel A4

∅	⊠	Art.number	∅	⊠	Art.number	∅	⊠	Art.number
5MM*	10	54113.050.001	8MM*	10	54113.080.001	12MM*	5	54113.120.001
6MM*	10	54113.060.001	10MM*	5	54113.100.001			

54115 Flat shackle, semi-round MH11

Material: Stainless steel A4

∅	⊠	Art.number	∅	⊠	Art.number	∅	⊠	Art.number
5MM*	10	54115.050.001	6MM*	10	54115.060.001	8MM*	10	54115.080.001

54116 Flat shackle short MH11

Material: Stainless steel A4

∅	⊠	Art.number	∅	⊠	Art.number	∅	⊠	Art.number
4MM*	10	54116.040.001	5MM*	10	54116.050.001	6MM*	10	54116.060.001

54117 Flat shackle long MH11

Material: Stainless steel A4





∅	⊠	Art.number	∅	⊠	Art.number	∅	⊠	Art.number
4MM*	10	54117.040.001	5MM*	10	54117.050.001	8MM*	10	54117.060.001

Bow shackle



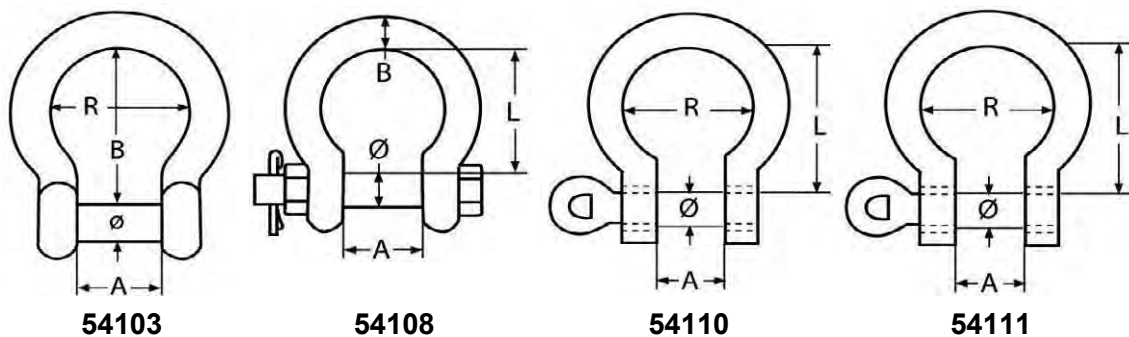

Technical Data



Nr.	A	B	L	R	ø	≈ Breaking load (N)
54103.050.001	11	25	-	17	5	12.000
54103.060.001	12	30	-	21	6	17.000
54103.080.001	16	44	-	28	8	25.000
54103.100.001	21	49	-	34	10	43.000
54103.120.001	25	57	-	42	12	62.000
54103.160.001	31	80	-	56	16	70.000
54103.190.001	36	96	-	66	19	140.000
54108.048.001	9.7	5	22	-	6.4	13.200
54108.064.001	12	6	29	-	8	20.000
54108.080.001	13.5	8	31	-	9.5	30.000
54108.096.001	17	10	36	-	11	40.000
54108.127.001	21	12	48	-	16	80.000
54108.160.001	27	16	60	-	19	120.000
54108.190.001	32	20	71	-	22	160.000
54108.220.001	36	22	84	-	25	200.000
54110.040.001	8	-	14	14	4	8.000
54110.050.001	10	-	17.5	17	7	12.000
54110.060.001	12	-	21	21	6	19.000
54110.080.001	16	-	28	28	8	28.000
54110.100.001	20	-	35	34	10	43.000
54110.120.001	24	-	42	42	12	65.000
54110.130.001	26	-	39	45	13	75.000
54110.160.001	32	-	56	56	16	120.000
54110.190.001	38	-	78.5	66	19	182.000
54110.220.001	44	-	77	78	22	210.000
54111.050.001	10	-	17.5	17	5	13.000
54111.060.001	12	-	21	21	6	18.000
54111.080.001	16	-	28	28	8	35.000
54111.100.001	20	-	35	34	10	54.000







Article groups

Material	Code	Page
St.St. A4	54103	13-9
St.St. A4	54108	13-9
St.St. A4	54110	13-9
St.St. A4	54111	13-9

54103 Anchor shackle with hexagon socket							MH11	
Material		Stainless steel A4						
								
∅	☒	Art.number	∅	☒	Art.number	∅	☒	Art.number
5MM*	10	54103.050.001	10MM*	5	54103.100.001	16MM*	5	54103.160.001
6MM*	10	54103.060.001	12MM*	5	54103.120.001	19MM*	1	54103.190.001
8MM*	10	54103.080.001						

54108 Bow shackle with fastening bolt, forged							MH11	
Material		Stainless steel A4						
								
∅	☒	Art.number	∅	☒	Art.number	∅	☒	Art.number
4,8MM*	10	54108.048.001	9,5MM*	5	54108.096.001	19MM*	1	54108.190.001
6,4MM*	10	54108.064.001	12,7MM*	5	54108.127.001	22MM*	1	54108.220.001
8MM*	10	54108.080.001	16MM*	5	54108.160.001			

54110 Bow shackle							MH11	
Material		Stainless steel A4						
								
∅	☒	Art.number	∅	☒	Art.number	∅	☒	Art.number
4MM*	20	54110.040.001	10MM*	10	54110.100.001	16MM*	5	54110.160.001
5MM*	20	54110.050.001	12MM*	5	54110.120.001	19MM*	1	54110.190.001
6MM	20	54110.060.001	13MM*	5	54110.130.001	22MM*	1	54110.220.001
8MM	10	54110.080.001						

54111 Bow shackle with captive pin							MH11	
Material		Stainless steel A4						
								
∅	☒	Art.number	∅	☒	Art.number	∅	☒	Art.number
5MM*	10	54111.050.001	8MM*	10	54111.080.001	10MM*	5	54111.100.001
6MM*	10	54111.060.001						

D-shackle twisted



Technical Data

Nr.	A	L	ø	≈ Breaking load (N)
54114.050.001	10	27	5	12.000
54114.060.001	12	30	6	17.500
54114.080.001	16	42	8	30.000
54114.100.001	20	55	10	58.000
54114.120.001	24	65	12	70.000
54118.040.001	11	24	4	8.000
54118.050.001	12	40	5	14.000

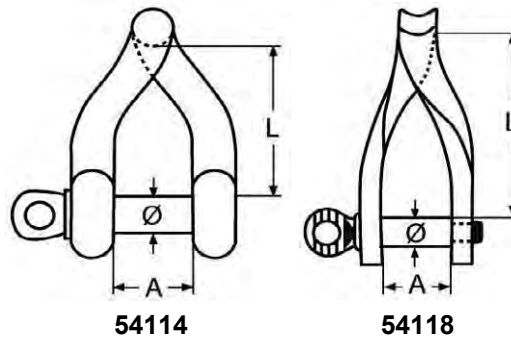

Article groups

Material	Code	Page
St.St. A4	54114	13-10
St.St. A4	54118	13-10

54114	D-shackle twisted	MH11
Material Stainless steel A4		

ø	☒	Art.number	ø	☒	Art.number	ø	☒	Art.number
5MM*	10	54114.050.001	8MM*	10	54114.080.001	12MM*	5	54114.120.001
6MM*	10	54114.060.001	10MM*	5	54114.100.001			

54118	Flat D-shackle twisted	MH11
Material Stainless steel A4		

ø	☒	Art.number	ø	☒	Art.number
4MM*	10	54118.040.001	5MM*	10	54118.050.001

D-shackle with pin



Technical Data

Nr.	A	B	C	L	∅	≈ Breaking load (N)
54119.050.001	13	-	-	40	5	9.540
54119.060.001	16	-	-	49	6	13.630
54119.080.001	22	-	-	62	8	22.720
54120.050.001	13	40	12.5	-	5	9.540
54120.060.001	16	49	15.0	-	6	13.630
54120.080.001	21.5	66	20.5	-	8	22.710

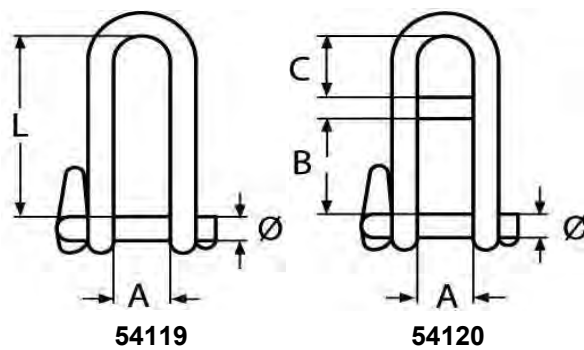

Article groups

Material	Code	Page
St.St. A4	54119	13-11
St.St. A4	54120	13-11

54119 D-shackle with pin MH11

Material: Stainless steel A4

∅	⊞	Art.number	∅	⊞	Art.number	∅	⊞	Art.number
5MM*	10	54119.050.001	6MM*	10	54119.060.001	8MM*	10	54119.080.001

54120 Key pin shackle with bar MH11

Material: Stainless steel A4

∅	⊞	Art.number	∅	⊞	Art.number	∅	⊞	Art.number
5MM*	10	54120.050.001	6MM*	10	54120.060.001	8MM*	10	54120.080.001

Multi purpose shackle key



Technical Data

Nr.	A	L
54121.032.100	2.0	100
54122.050.086	5.0	86

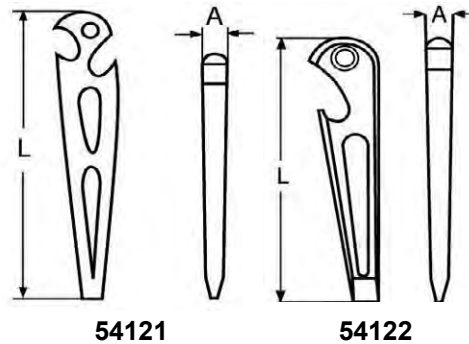



Article groups

Material	Code	Page
St.St. A2	54121	13-12
St.St. A4	54122	13-12

54121 Multi purpose shackle key MH11



Material Stainless steel A2

A	Art.number
2MM*	5 54121.032.100

54122 Multi purpose shackle key MH11

Material Stainless steel A4





A	Art.number
5MM*	10 54122.050.086

Spring hook

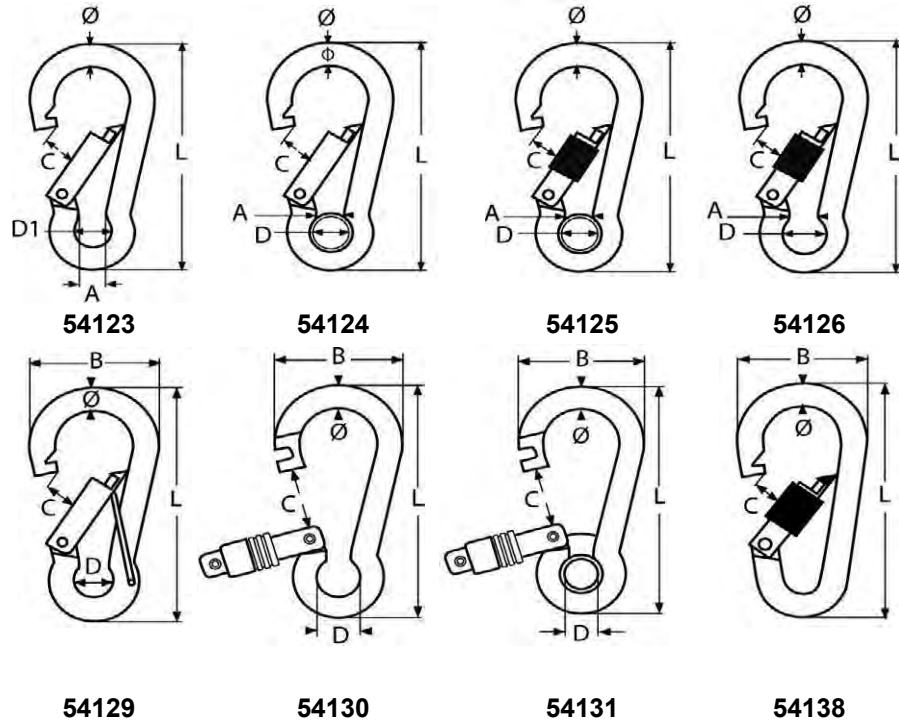

Technical Data								
Nr.	A	B	C	D	D ₁	L	ø	≈ Breaking load (N)
54123.050.050	6	-	8	-	10	50	5	5.700
54123.060.060	8	-	9	-	11	60	6	6.700
54123.070.070	8	-	9	-	13	70	7	7.500
54123.080.080	8	-	9	-	13	80	8	8.700
54123.100.100	10	-	12	-	16	100	10	11.500
54123.110.120	11	-	16	-	18	120	11	12.500
54124.040.040	5	-	7	5	-	40	4	2.000
54124.050.050	6	-	8	6.5	-	50	5	4.000
54124.060.060	8	-	9	7.2	-	60	6	6.000
54124.070.070	8	-	9	9	-	70	7	9.000
54124.080.080	8	-	9	10.2	-	80	8	11.500
54124.100.100	10	-	12	13	-	100	10	14.500
54124.110.120	11	-	16	15	-	120	11	15.500
54124.120.140	13	-	19	18	-	140	12	16.500
54125.040.040	6.5	-	7	5	-	40	4	4.000
54125.050.050	7.5	-	8	9	-	50	5	6.000
54125.060.060	7.5	-	9	10	-	60	6	9.000
54125.070.070	9	-	9	11	-	70	7	10.000
54125.080.080	8	-	8	13	-	80	8	12.000
54125.100.100	10	-	10	16	-	100	10	14.000
54125.110.120	11	-	15	18	-	120	11	15.000
54126.040.040	5	-	7	5	-	40	4	4.000
54126.050.050	6	-	8	9	-	50	5	6.000
54126.060.060	8	-	9	10	-	60	6	9.000
54126.070.070	8	-	9	11	-	70	7	10.000
54126.080.080	8	-	8	13	-	80	8	12.000
54126.100.100	10	-	10	16	-	100	10	14.000
54126.110.120	11	-	15	18	-	120	11	15.000
54129.060.060	-	30	7.5	8.5	-	60	6	2.720
54129.080.080	-	40	10	12	-	80	8	5.080
54129.100.100	-	50	12	15	-	100	10	7.280
54130.050.050	-	26	15	8	-	50	5	3.870
54130.060.060	-	30	16	8.5	-	60	6	4.170
54130.080.080	-	40	23	12	-	80	8	9.900
54130.100.100	-	50	27	15	-	100	10	13.000
54131.050.050	-	26	15	7.8	-	50	5	3.870
54131.060.060	-	30	16	7.8	-	60	6	4.170
54131.080.080	-	40	23	10.8	-	80	8	9.900
54131.100.100	-	50	27	14	-	100	10	13.000
54138.060.060	-	30	8.5	-	-	60	6	2.720
54138.080.080	-	40	10	-	-	80	8	5.080
54138.100.100	-	50	12	-	-	100	10	7.280
54138.110.120	-	60	17	-	-	120	11	8.160



Article groups

Material	Code	Page
St.St. A4	54123	13-14
St.St. A4	54124	13-14
St.St. A4	54125	13-15
St.St. A4	54126	13-15
St.St. A4	54129	13-15
St.St. A4	54130	13-15
St.St. A4	54131	13-15
St.St. A4	54138	13-15

54123 Spring hook MH11

Material Stainless steel A4





ø x L	☒	Art.number	ø x L	☒	Art.number	ø x L	☒	Art.number
5X50MM	20	54123.050.050	7X70MM*	20	54123.070.070	10X100MM*	10	54123.100.100
6X60MM	20	54123.060.060	8X80MM	20	54123.080.080	11X120MM*	10	54123.110.120













54124 Spring hook with eyelet MH11

Material Stainless steel A4





ø x L	☒	Art.number	ø x L	☒	Art.number	ø x L	☒	Art.number
4X40MM*	10	54124.040.040	7X70MM*	10	54124.070.070	11X120MM*	5	54124.110.120
5X50MM*	10	54124.050.050	8X80MM*	10	54124.080.080	12X140MM*	5	54124.120.140
6X60MM*	10	54124.060.060	10X100MM*	5	54124.100.100			

54125 Spring hook with lock nut & eyelet							MH11	
Material Stainless steel A4								
								
ø x L	✉	Art.number	ø x L	✉	Art.number	ø x L	✉	Art.number
4X40MM*	10	54125.040.040	7X70MM*	10	54125.070.070	10X100MM*	5	54125.100.100
5X50MM*	10	54125.050.050	8X80MM*	10	54125.080.080	11X120MM*	5	54125.110.120
6X60MM*	10	54125.060.060						
54126 Spring hook with lock nut							MH11	
Material Stainless steel A4								
								
ø x L	✉	Art.number	ø x L	✉	Art.number	ø x L	✉	Art.number
4X40MM*	10	54126.040.040	7X70MM*	10	54126.070.070	10X100MM*	5	54126.100.100
5X50MM*	10	54126.050.050	8X80MM*	10	54126.080.080	11X120MM*	5	54126.110.120
6X60MM*	10	54126.060.060						
54129 Spring lock hook with safety latch							MH11	
Material Stainless steel A4								
								
ø x L	✉	Art.number	ø x L	✉	Art.number	ø x L	✉	Art.number
6X60MM*	10	54129.060.060	8X80MM*	10	54129.080.080	10X100MM*	5	54129.100.100
54130 Spring hooks with self-lock nut							MH11	
Material Stainless steel A4								
								
ø x L	✉	Art.number	ø x L	✉	Art.number	ø x L	✉	Art.number
5X50MM*	10	54130.050.050	8X80MM*	10	54130.080.080	10X100MM*	5	54130.100.100
6X60MM*	10	54130.060.060						
54131 Spring hook with eyelet and self-lock nut							MH11	
Material Stainless steel A4								
								
ø x L	✉	Art.number	ø x L	✉	Art.number	ø x L	✉	Art.number
5X50MM*	10	54131.050.050	8X80MM*	10	54131.080.080	10X100MM*	5	54131.100.100
6X60MM*	10	54131.060.060						
54138 Spring hook with lock nut							MH11	
Material Stainless steel A4								
								
ø x L	✉	Art.number	ø x L	✉	Art.number	ø x L	✉	Art.number
6X60MM*	10	54138.060.060	10X100MM*	5	54138.100.100	11X120MM*	5	54138.110.120
8X80MM*	10	54138.080.080						

Buoy hook



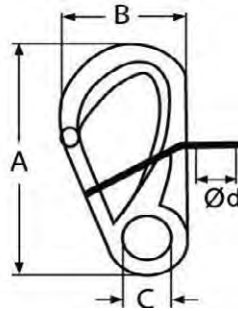

Technical Data

Nr.	A	B	C	ø d	≈ Breaking load (N)
54127.108.063	108	63	21	35	9.100



54127

54127	Buoy hook	MH11
Material	Stainless steel A4	 

A x B	⊠	Art.number
108X63MM*	5	54127.108.063

Spring snap



Technical Data

Nr.	B	D	E	L	∅	≈ Breaking load (N)
54128.060.001	35	7	10	61	6	6.000
54128.080.001	48	11	13	81	8	16.000
54128.100.001	58	13	15	102	10	25.000
54128.120.001	70	16	21	122	12	30.000
54128.160.001	97	25	27	165	16	33.000

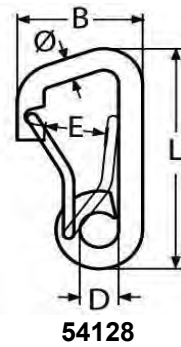

54128	Spring snap	MH11
Material	Stainless steel A4	
		

∅	⊠	Art.number	∅	⊠	Art.number	∅	⊠	Art.number
6MM*	10	54128.060.001	10MM*	5	54128.100.001	16MM*	5	54128.160.001
8MM*	10	54128.080.001	12MM*	5	54128.120.001			

Spring hook asymmetric



Technical Data

Nr.	B	C	D	E	L	∅	≈ Breaking load (N)
54132.060.060	35	9	8	-	60	6	4.560
54132.080.080	46	12.5	11	-	80	8	7.280
54132.100.100	60	16	14	-	100	10	10.920
54132.110.120	70	21.5	18	-	120	11	12.600
54133.110.120	70	24	-	-	120	11	16.000
54134.110.120	70	24	-	-	120	11	16.000
54135.100.115	60	19	-	-	115	10	27.200
54136.080.080	45	12	1.7	13	80	8	13.300
54136.100.100	55	14	2	16	100	10	25.100
54137.080.064	45	11.5	-	-	80	8	15.900
54137.100.080	55	14	-	-	100	10	16.800
54142.080.080	45	13	11	-	80	8	8.700
54142.100.100	58	18	14	-	100	10	13.500
54142.110.120	70	24	18	-	120	11	15.000

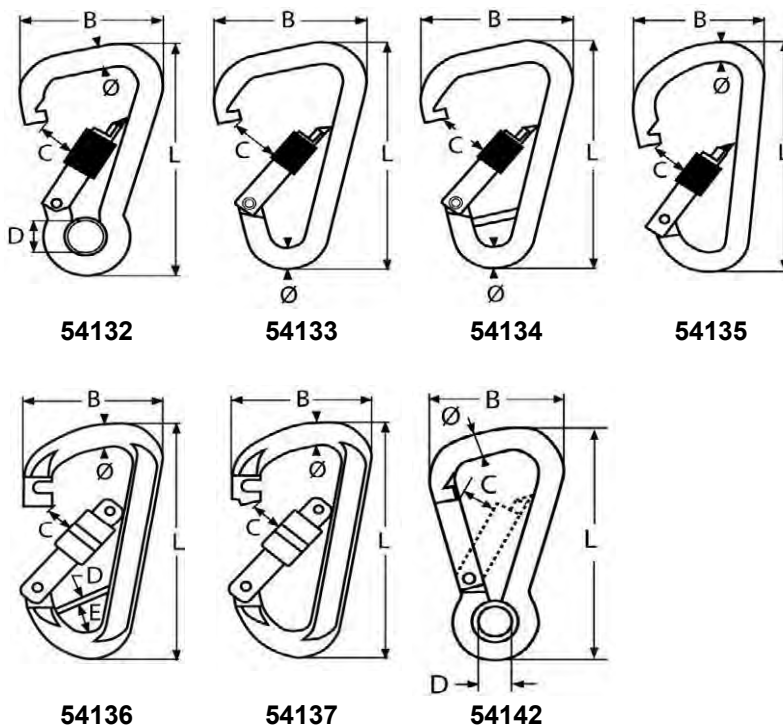

Article groups

Material	Code	Page
St.St. A4	54132	13-19
St.St. A4	54133	13-19
St.St. A4	54134	13-19
St.St. A4	54135	13-19
St.St. A4	54136	13-19
St.St. A4	54137	13-19
St.St. A4	54142	13-20

54132 Spring hook with eye and screw nut, asymmetric MH11



Material Stainless steel A4



\varnothing x L	☒	Art.number	\varnothing x L	☒	Art.number	\varnothing x L	☒	Art.number
6X60MM*	10	54132.060.060	10X100MM*	5	54132.100.100	11X120MM*	5	54132.110.120
8X80MM*	10	54132.080.080						

54133 Spring hook with screw nut, asymmetric MH11

Material Stainless steel A4

\varnothing x L	☒	Art.number
11X120MM*	5	54133.110.120

54134 Spring hook with lock nut and bar MH11



Material Stainless steel A4



\varnothing x L	☒	Art.number
11X120MM*	5	54134.110.120

54135 Spring hook with lock nut MH11



Material Stainless steel A4

\varnothing x L	☒	Art.number
10X115MM*	5	54135.100.115

54136 Spring hook with self-locking sleeve and bar MH11

Material Stainless steel A4

\varnothing x L	☒	Art.number	\varnothing x L	☒	Art.number
8X80MM*	10	54136.080.080	10X100MM*	5	54136.100.100

54137 Spring hook with nut MH11

Material Stainless steel A4



\varnothing x L	☒	Art.number	\varnothing x L	☒	Art.number
8X64MM*	10	54137.080.064	10X80MM*	5	54137.100.080

54142	Spring hook with eyelet, asymmetric	MH11
Material	Stainless steel A4	
		

ø x L		Art.number	ø x L		Art.number	ø x L		Art.number
8X80*	10	54142.080.080	10X100*	5	54142.100.100	11X120*	5	54142.110.120

Spring hook with nut



Technical Data

Nr.	B	C	L	ø	~ Breaking load (N)
54139.060.052	30	14	55	6	4.400
54139.080.070	35	18	70	8	9.050
54140.050.070	25	15	70	5	3.700
54140.060.080	30	16	80	6	4.400
54140.060.090	35	23	90	8	9.050
54140.100.110	40	27	110	10	13.950

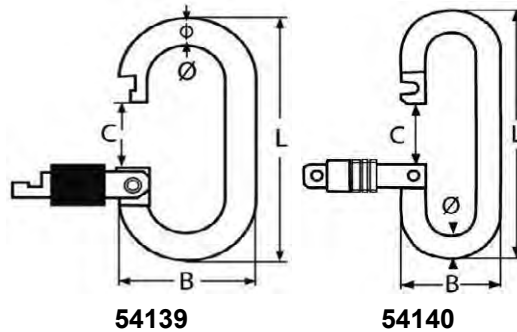



Article groups

Material	Code	Page
St.St. A4	54139	13-20
St.St. A4	54140	13-21

54139	Spring hook with lock nut	MH11
Material	Stainless steel A4	
		

ø x L		Art.number	ø x L		Art.number
6X52MM*	10	54139.060.052	8X70MM*	10	54139.080.070

54140 Spring hook opening with self-locking nut							MH11	
Material		Stainless steel A4						
								
$\varnothing \times L$	☒	Art.number	$\varnothing \times L$	☒	Art.number	$\varnothing \times L$	☒	Art.number
5X70MM*	10	54140.050.070	8X90MM*	10	54140.060.090	10X110MM*	5	54140.100.110
6X80MM*	10	54140.060.080						



Spring hook



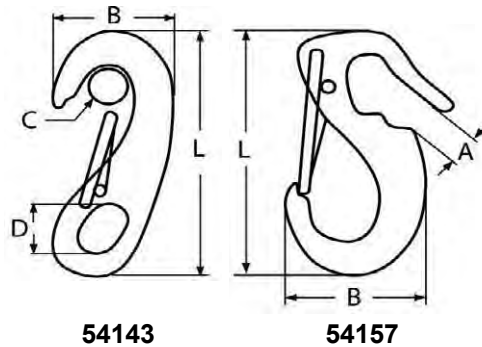

Technical Data						
Nr.	A	B	C	D	L	≈ Breaking load (N)
54143.050.001	-	24	10	10.5	50	2.000
54143.070.001	-	31	12	13	70	7.000
54143.100.001	-	46	22	21	100	18.000
54157.050.001	6.5	25	-	-	50	2.500
54157.065.001	10	35	-	-	65	5.500
54157.090.001	13	49	-	-	90	10.000



Article groups		
Material	Code	Page
St.St. A4	54143	13-21
St.St. A4	54157	13-22

54143 Spring hook							MH11	
Material		Stainless steel A4						
								
L	☒	Art.number	L	☒	Art.number	L	☒	Art.number
50MM*	10	54143.050.001	70MM*	10	54143.070.001	100MM*	5	54143.100.001

54157		Knock on piston hank				MH11		
Material		Stainless steel A4						
								
								
L	☒	Art.number	L	☒	Art.number	L	☒	Art.number
50MM*	10	54157.050.001	65MM*	10	54157.065.001	90MM*	5	54157.090.001

Spring hook with special closure



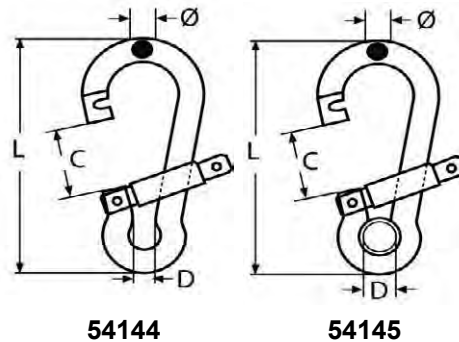

Technical Data

Nr.	C	D	L	ø	~ Breaking load (N)
54144.080.080	19	8	80	8	8.000
54144.100.100	22	11	100	10	12.000
54144.110.120	26	12	120	11	20.000
54145.080.080	19	10	80	8	8.000
54145.100.100	22	14	100	10	12.000
54145.110.120	26	17	120	11	20.000



Article groups

Material	Code	Page
St.St. A4	54144	13-22
St.St. A4	54145	13-23

54144		Spring hook with special closure				MH11		
Material		Stainless steel A4						
								
								
ø x L	☒	Art.number	ø x L	☒	Art.number	ø x L	☒	Art.number
8X80*	10	54144.080.080	10X100*	10	54144.100.100	11X120*	10	54144.110.120

54145	Snap hook with special closure & eyelet						MH11
Material	Stainless steel A4						
							

ø x L	✉	Art.number	ø x L	✉	Art.number	ø x L	✉	Art.number
8X80*	10	54145.080.080	10X100*	5	54145.100.100	11X120*	5	54145.110.120

Swivel eye



Technical Data

Nr.	A	B	C	D	D ₁	E	L	L ₂	S
54146.160.001	-	21	11	-	-	-	86	-	-
54146.190.001	-	21	12	-	-	-	99.5	-	-
54146.220.001	-	21	16	-	-	-	117.5	-	-
54147.090.001	10.5	-	-	9	7	7	62	-	3
54147.120.001	13.5	-	-	12	8	8	75	-	4
54147.160.001	15.5	-	-	16	9	9	87	-	4
54147.190.001	19	-	-	19	9	9	90	-	5
54148.130.001	-	-	-	13	-	-	65	16	-
54148.160.001	-	-	-	16	-	-	65	19	-
54149.011.115	-	-	10	11	-	-	115	-	-

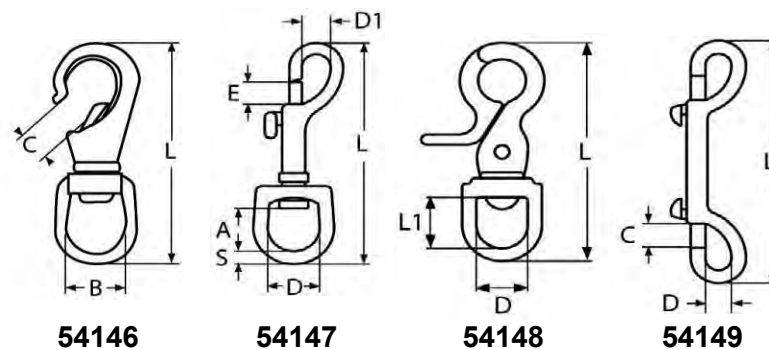





Article groups



Material	Code	Page
St.St. A4	54146	13-23
St.St. A4	54147	13-24
St.St. A4	54148	13-24
St.St. A4	54149	13-24

54146	Swivel eye with snap						MH11
Material	Stainless steel A4						
							

C	✉	Art.number	C	✉	Art.number	C	✉	Art.number
11MM*	5	54146.160.001	12MM*	5	54146.190.001	16MM*	5	54146.220.001

54147 Swivel eye bolt snap		MH11	
Material Stainless steel A4			
			
			
D	☒ Art.number	D	☒ Art.number
9MM*	10 54147.090.001	16MM*	5 54147.160.001
12MM	10 54147.120.001		
			☒ Art.number
		19MM*	5 54147.190.001

54148 Swivel eye Trigger snap with eye bail		MH11	
Material Stainless steel A4			
			
			
D	☒ Art.number	D	☒ Art.number
13MM*	5 54148.130.001	16MM*	5 54148.160.001

54149 Double snap hook		MH11	
Material Stainless steel A4			
			
			
D x L	☒ Art.number		
11X115MM*	5 54149.011.115		

Spring hook with double locking equipment



Technical Data					
Nr.	B	C	D	L	≈ Breaking load (N)
54150.100.110	62	19	20	110	14.000

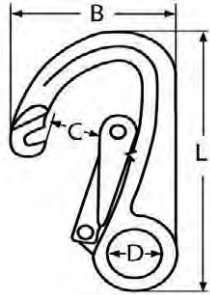

54150

54150	Spring hook with double locking equipment	MH11
Material	Stainless steel A4	
		

L		Art.number
110MM*	5	54150.100.110

Swivel snap shackle



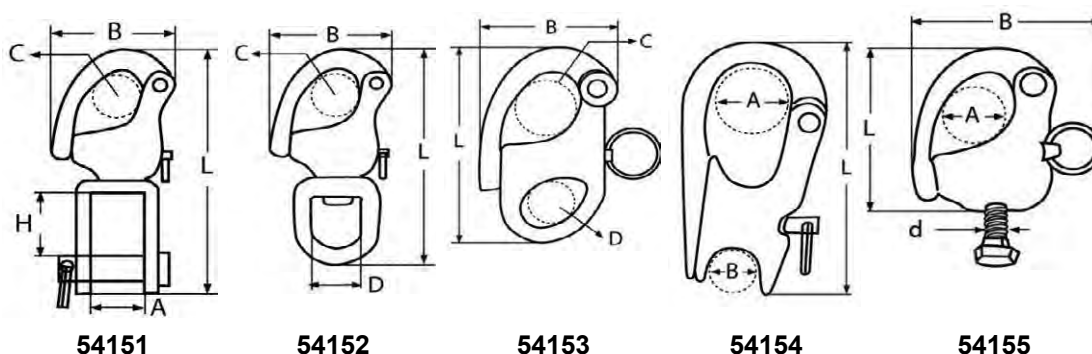

Technical Data

Nr.	A	B	C	d	D	H	L
54151.070.001	12	33	12	-	-	9	70
54151.087.001	13	42	16	-	-	15	87
54151.128.001	22	58	22	-	-	20	128
54152.070.001	-	33	12	-	12	-	70
54152.087.001	-	42	16	-	16	-	87
54152.128.001	-	58	22	-	22	-	128
54153.052.001	-	35	12	-	9	-	52
54153.066.001	-	45	16	-	12	-	66
54153.096.001	-	60	22	-	16	-	96
54154.012.052	10	12	-	-	-	-	52
54154.015.066	14	15	-	-	-	-	66
54154.025.096	18	25	-	-	-	-	96
54155.060.001	12	30	-	M6	-	-	42
54155.080.001	16	40	-	M8	-	-	53
54155.100.001	22	62	-	M10	-	-	75





Article groups



Material	Code	Page
St.St. A4	54151	13-26
St.St. A4	54152	13-26
St.St. A4	54153	13-26
St.St. A4	54154	13-26
St.St. A4	54155	13-26

54151	Swivel snap shackle	MH11
Material	Stainless steel A4	
		



L		Art.number	L		Art.number	L		Art.number
70MM*	5	54151.070.001	87MM*	5	54151.087.001	128MM*	5	54151.128.001

54152	Swivel snap shackle	MH11
Material	Stainless steel A4	
		



L		Art.number	L		Art.number	L		Art.number
70MM*	5	54152.070.001	87MM*	5	54152.087.001	128MM*	5	54152.128.001

54153	Fixed snap shackle	MH11
Material	Stainless steel A4	
		

L		Art.number	L		Art.number	L		Art.number
52MM*	5	54153.052.001	66MM*	5	54153.066.001	96MM*	5	54153.096.001

54154	Sheet snap shackle	MH11
Material	Stainless steel A4	
		

B x L		Art.number	B x L		Art.number	B x L		Art.number
12X52*	5	54154.012.052	15X66*	5	54154.015.066	25X96*	5	54154.025.096

54155	Snap shackle with screw	MH11
Material	Stainless steel A4	
		

L		Art.number	L		Art.number	L		Art.number
6MM*	5	54155.060.001	8MM*	5	54155.080.001	10MM*	5	54155.100.001

Swivel snap shackle



Technical Data

Nr.	A	B	L	≈ Breaking load (N)
54156.085.001	18	12	85	15.000
54156.105.001	24	14	105	25.000
54156.125.001	27	18	125	35.000

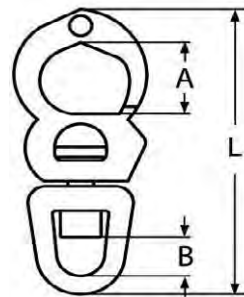

54156

54156	Swivel snap shackle	MH11
Material	Stainless steel A4	

L	☒	Art.number	L	☒	Art.number	L	☒	Art.number
85MM*	1	54156.085.001	105MM*	1	54156.105.001	125MM*	1	54156.125.001



Technical Data						
Nr.	A	B	C	H	L	ø
54158.050.001	13	13	-	-	60	5
54158.060.001	15	15	-	-	65	6
54158.080.001	20	22	-	-	90	8
54158.100.001	24	27	-	-	115	10
54158.130.001	32	35	-	-	154	13
54158.160.001	39	45	-	-	188	16
54158.190.001	41	50	-	-	231	19
54159.060.001	11	12	-	-	66	6
54159.080.001	16	16	-	-	94	8
54159.100.001	22	22	-	-	118	10
54159.130.001	28	28	-	-	152	13
54159.160.001	37	34	-	-	188	16
54159.190.001	45	38	-	-	229	19
54160.050.001	11	10	-	-	60	5
54160.060.001	11	12	-	-	66	6
54160.080.001	16	16	-	-	94	8
54160.100.001	22	20	-	-	118	10
54160.130.001	28	28	-	-	152	13
54160.160.001	37	34	-	-	188	16
54160.190.001	45	38	-	-	229	19
54161.050.001	-	10	11	-	60	5
54161.060.001	-	12	11	-	66	6
54161.080.001	-	16	16	-	94	8
54161.100.001	-	20	22	-	118	10
54161.130.001	-	26	28	-	152	13
54161.160.001	-	34	37	-	188	16
54161.190.001	-	38	45	-	229	19
54162.120.047	12	-	-	10	47	5
54162.140.055	14	-	-	11	55	6
54163.050.001	11	10	-	-	60	5
54163.060.001	12	12	-	-	66	6
54163.080.001	16	16	-	-	92	8
54163.100.001	22	20	-	-	118	10
54163.130.001	28	26	-	-	152	13
54163.160.001	34	32	-	-	188	16
54163.190.001	44	38	-	-	229	19

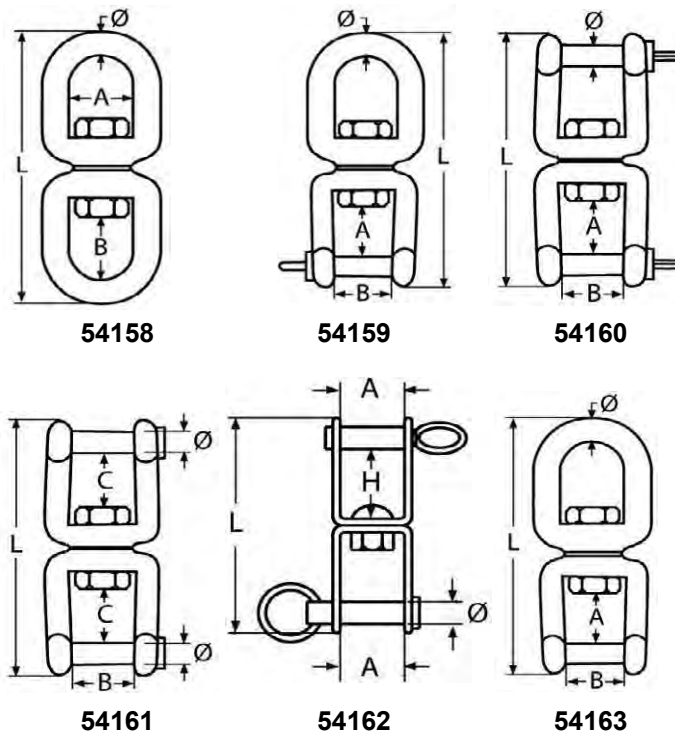

Article groups		
Material	Code	Page
St.St. A4	54158	13-29
St.St. A4	54159	13-29
St.St. A4	54160	13-30
St.St. A4	54161	13-30
St.St. A2	54162	13-30
St.St. A4	54163	13-30

54158 Eye and eye swivel MH11

Material Stainless steel A4

ø	⊠	Art.number	ø	⊠	Art.number	ø	⊠	Art.number
5MM*	10	54158.050.001	10MM*	5	54158.100.001	16MM*	1	54158.160.001
6MM*	10	54158.060.001	13MM*	1	54158.130.001	19MM*	1	54158.190.001
8MM*	10	54158.080.001						

54159 Eye and jaw swivel MH11

Material Stainless steel A4



ø	⊠	Art.number	ø	⊠	Art.number	ø	⊠	Art.number
6MM*	10	54159.060.001	10MM*	5	54159.100.001	16MM*	1	54159.160.001
8MM*	10	54159.080.001	13MM*	1	54159.130.001	19MM*	1	54159.190.001

54160 Jaw & jaw swivel **MH11**

Material Stainless steel A4



∅	☒	Art.number	∅	☒	Art.number	∅	☒	Art.number
5MM*	10	54160.050.001	10MM*	5	54160.100.001	16MM*	1	54160.160.001
6MM*	10	54160.060.001	13MM*	1	54160.130.001	19MM*	1	54160.190.001
8MM*	10	54160.080.001						

54161 Jaw & jaw swivel with hexagon socket **MH11**

Material Stainless steel A4



∅	☒	Art.number	∅	☒	Art.number	∅	☒	Art.number
5MM*	10	54161.050.001	10MM*	5	54161.100.001	16MM*	1	54161.160.001
6MM*	10	54161.060.001	13MM*	1	54161.130.001	19MM*	1	54161.190.001
8MM*	10	54161.080.001						

54162 Jaw and jaw flat swivel shackle **MH11**

Material Stainless steel A2



A x L	☒	Art.number	A x L	☒	Art.number
12X47*	10	54162.120.047	14X55*	10	54162.140.055

54163 Eye and jaw swivel with hexagon socket **MH11**

Material Stainless steel A4





∅	☒	Art.number	∅	☒	Art.number	∅	☒	Art.number
5MM*	10	54163.050.001	10MM*	5	54163.100.001	16MM*	1	54163.160.001
6MM*	10	54163.060.001	13MM*	1	54163.130.001	19MM*	1	54163.190.001
8MM*	10	54163.080.001						

Waterski hook

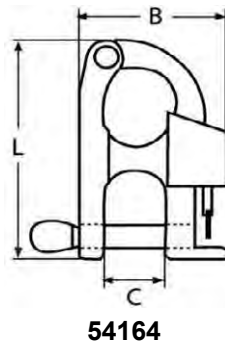

Technical Data				
Nr.	B	C	L	≈ Breaking load (N)
54164.060.001	37	16	60	8.000



54164	Waterski hook	MH11
Material	Stainless steel A4	
		

L	☒	Art.number
60MM*	5	54164.060.001

Spring hook aluminium



Technical Data

Nr.	A	A ₁	B	C	D	L	ø	≈ Breaking load (N)
54165.050.050	10	6	-	8	-	50	5	1.000
54165.060.060	11	8	-	9	-	60	6	1.600
54165.080.080	13	8	-	9	-	80	8	3.500
54167.110.116	-	-	64	22	-	116	11	22.000
54168.130.001	-	-	80	21	21	130	-	20.000
54169.120.120	-	-	80	25	-	120	12	24.000
54169.140.190	-	-	104	46	-	190	14	26.000

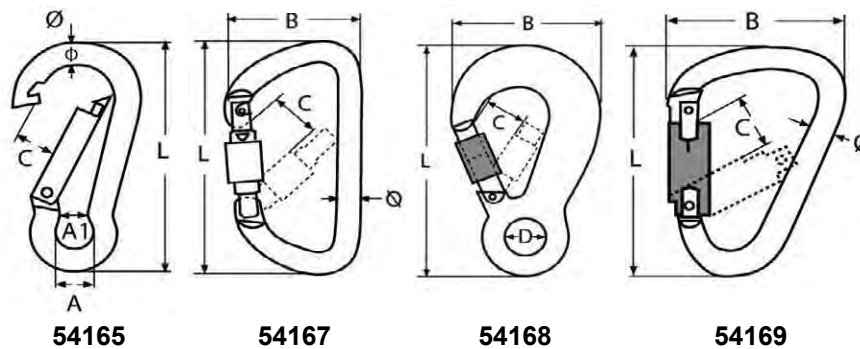

Article groups

Material	Code	Page
Al	54165	13-32
Al	54167	13-32
Al	54168	13-33
Al	54169	13-33

54165 Snap hook set, different colors MH11

Material Aluminium

ø x L	⊗	Art.number	ø x L	⊗	Art.number	ø x L	⊗	Art.number
5X50MM*	10	54165.050.050	6X60MM	10	54165.060.060	8X80MM*	10	54165.080.080

54167 Single point spring hook MH11

Material Aluminium

ø x L	⊗	Art.number
11X116MM*	5	54167.110.116

54168	Aluminium safety spring hook	MH11
Material	Aluminium	

L		Art.number
130MM*	5	54168.130.001

54169	1/4 Turn single point spring hook	MH11
Material	Aluminium	

ø x L		Art.number	ø x L		Art.number
12X120MM*	5	54169.120.120	14X190MM*	5	54169.140.190

Aluminium figure eight descender



Technical Data						
Nr.	A	B	C	E	L	≈ Breaking load (N)
54170.145.001	51	26	48	76	145	30.000

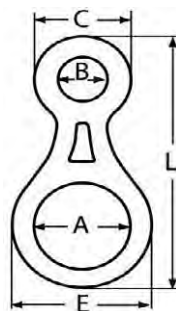

54170

54170	Aluminium figure eight descender	MH11
Material	Aluminium	

L		Art.number
145MM*	5	54170.145.001

Simplex spring hook



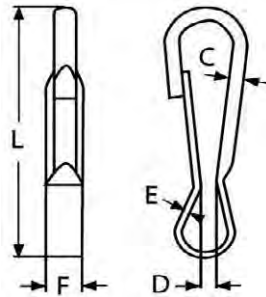

Technical Data

Nr.	C	D	E	F	L
54166.030.001	3.3	1.4	2.8	3.6	30
54166.040.001	4.5	1.9	4.1	5.0	40
54166.050.001	5.4	2.3	4.6	6.4	50
54166.060.001	6.2	2.8	5.6	7.1	60



54166

54166	Simplex spring hook	MH11
Material	Stainless steel A2	 

L	☒	Art.number	L	☒	Art.number	L	☒	Art.number
30MM	100	54166.030.001	50MM*	50	54166.050.001	60MM*	50	54166.060.001
40MM*	100	54166.040.001						

Rope shortener



Technical Data				
Nr.	B	D	L	WR-ø
54171.120.001	78	22	122	12
54171.160.001	78	22	122	16

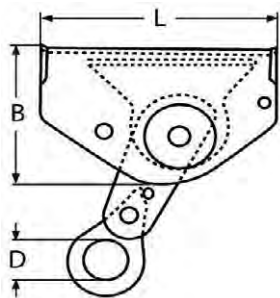

54171

54171	Rope shortener	MH11
Material	Stainless steel A2	
		

WR-ø	Art.number	WR-ø	Art.number
12MM*	1 54171.120.001	16MM*	1 54171.160.001

Turnbuckle



Technical Data

Nr.	A	D	L ₁	L ₂	Thread	WR-ø
54200.040.001	5.5	4	110	170	M4	-
54200.050.001	6.5	5	130	190	M5	-
54200.060.001	7.5	6	150	220	M6	-
54200.080.001	11	8	165	240	M8	-
54200.100.001	12	9	190	280	M10	-
54200.120.001	14	12	245	360	M12	-
54200.140.001	15	12	270	390	M14	-
54200.160.001	17	16	310	450	M16	-
54200.200.001	20	19	360	510	M20	-
54201.050.025	6	5	155	215	M5	2.5
54201.060.030	7.5	6	175	245	M6	3
54201.060.040	7.5	6	185	255	M6	4
54201.080.040	11	8	200	275	M8	4
54201.080.050	11	8	205	280	M8	5
54201.100.050	12	9	230	320	M10	5
54201.100.060	12	9	245	355	M10	6
54201.120.060	14	12	285	400	M12	6
54201.120.080	14	12	305	420	M12	8
54201.140.070	15	15	315	435	M14	7
54201.160.080	17	17	360	500	M16	8
54201.160.100	17	16	370	510	M16	10
54201.200.100	20	20	410	560	M20	10
54201.200.120	20	20	410	560	M20	12
54202.060.030	7	6	180	250	M6	3
54202.060.040	7	6	190	260	M6	4
54202.080.040	10	8	210	285	M8	4
54202.080.050	10	8	215	290	M8	5
54202.100.050	12	9	250	340	M10	5
54202.100.060	12	9	265	355	M10	6
54202.120.060	13	12	300	410	M12	6
54202.120.080	13	12	320	430	M12	8
54202.140.070	15	14	328	453	M14	7
54202.160.080	17	16	390	530	M16	8
54202.160.100	17	16	400	540	M16	10
54202.200.100	20	19	450	590	M20	10

• WR-ø = Wire diameter.

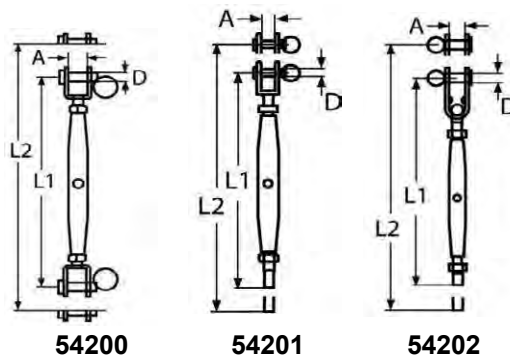

Article groups

Material	Code	Page
St.St. A4	54200	13-37
St.St. A4	54201	13-37
St.St. A4	54202	13-37

54200 Turnbuckle with two forks MH11
Material Stainless steel A4

Thread	☒	Art.number	Thread	☒	Art.number	Thread	☒	Art.number
M4*	10	54200.040.001	M8*	10	54200.080.001	M14*	1	54200.140.001
M5*	10	54200.050.001	M10	5	54200.100.001	M16*	1	54200.160.001
M6*	10	54200.060.001	M12*	5	54200.120.001	M20*	1	54200.200.001

54201 Turnbuckle with fork and terminal MH11
Material Stainless steel A4

Thread / WR-ø	☒	Art.number	Thread / WR-ø	☒	Art.number	Thread / WR-ø	☒	Art.number
M5/2,5MM*	10	54201.050.025	M10/5MM*	5	54201.100.050	M16/8MM*	1	54201.160.080
M6/3MM*	10	54201.060.030	M10/6MM*	5	54201.100.060	M16/10MM*	1	54201.160.100
M6/4MM*	10	54201.060.040	M12/6MM*	5	54201.120.060	M20/10MM*	1	54201.200.100
M8/4MM*	10	54201.080.040	M12/8MM*	5	54201.120.080	M20/12MM*	1	54201.200.120
M8/5MM*	10	54201.080.050	M14/7MM*	1	54201.140.070			

54202 Turnbuckle with toggle and terminal MH11
Material Stainless steel A4



Thread / WR-ø	☒	Art.number	Thread / WR-ø	☒	Art.number	Thread / WR-ø	☒	Art.number
M6/3MM*	5	54202.060.030	M10/5MM*	5	54202.100.050	M14/7MM*	1	54202.140.070
M6/4MM*	5	54202.060.040	M10/6MM*	5	54202.100.060	M16/8MM*	1	54202.160.080
M8/4MM*	5	54202.080.040	M12/6MM*	5	54202.120.060	M16/10MM*	1	54202.160.100
M8/5MM*	5	54202.080.050	M12/8MM*	5	54202.120.080	M20/10MM*	1	54202.200.100

Slip hook with ring



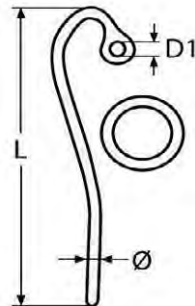

Technical Data

Nr.	D ₁	L	Rivet head ø	ø
54203.132.001	5.1	132	7.1	5
54203.142.001	6.2	142	9.6	6
54203.192.001	8.5	192	11.3	8
54203.235.001	13.0	235	14.4	12



54203

54203	Slip hook with ring	MH11
Material	Stainless steel A4	
		

L	☒	Art.number	L	☒	Art.number	L	☒	Art.number
132MM*	5	54203.132.001	192MM*	2	54203.192.001	235MM*	2	54203.235.001
142MM*	5	54203.142.001						

Turnbuckle sleeve



Technical Data

Nr.	d	L
54204.050.001	M5	80
54204.060.001	M6	95
54204.080.001	M8	105
54204.100.001	M10	125
54204.120.001	M12	150
54204.140.001	M14	165
54204.160.001	M16	190
54204.200.001	M20	200

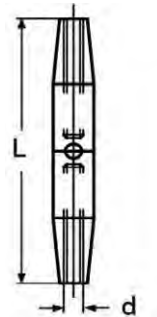

54204

54204 Turnbuckle sleeve

MH11

Material Stainless steel A4



d	☒	Art.number	d	☒	Art.number	d	☒	Art.number
M5*	10	54204.050.001	M10*	5	54204.100.001	M16*	1	54204.160.001
M6*	10	54204.060.001	M12*	5	54204.120.001	M20*	1	54204.200.001
M8*	10	54204.080.001	M14*	1	54204.140.001			

Turnbuckle



Technical Data

Nr.	A	D	L	L ₁	L ₂	Thread	WR-ø
54206.050.001	6.5	5	-	120	70	M5	-
54206.060.001	7.5	6	-	140	90	M6	-
54206.080.001	11	8	-	180	120	M8	-
54206.100.001	12	9	-	220	150	M10	-
54206.120.001	14	12	-	300	200	M12	-
54206.140.001	15	12	-	325	220	M14	-
54206.160.001	17	16	-	375	250	M16	-
54206.200.001	20	19	-	450	300	M20	-
54207.050.001	6.5	5	-	135	195	M5	-
54207.060.001	7.5	6	-	160	230	M6	-
54207.080.001	11	8	-	180	255	M8	-
54207.100.001	12	9	-	210	300	M10	-
54207.120.001	14	12	-	270	380	M12	-
54207.140.001	15	12	-	295	415	M14	-
54207.160.001	17	16	-	340	480	M16	-
54208.050.025	6.5	5	-	155	215	M5	2.5
54208.060.030	7.5	6	-	180	250	M6	3
54208.060.040	7.5	6	-	190	260	M6	4
54208.080.040	11	8	-	210	285	M8	4
54208.080.050	11	8	-	215	290	M8	5
54208.100.050	12	9	-	240	330	M10	5
54208.100.060	12	9	-	255	345	M10	6
54208.120.060	14	12	-	300	410	M12	6
54208.120.080	14	12	-	320	430	M12	8
54208.140.070	15	12	-	330	450	M14	7
54208.160.080	17	16	-	370	510	M16	8
54208.160.100	17	16	-	380	520	M16	10
54209.060.001	-	-	90	-	-	M6	-
54209.080.001	-	-	120	-	-	M8	-
54209.100.001	-	-	150	-	-	M10	-
54209.120.001	-	-	200	-	-	M12	-
54209.160.001	-	-	250	-	-	M16	-
54209.200.001	-	-	300	-	-	M20	-

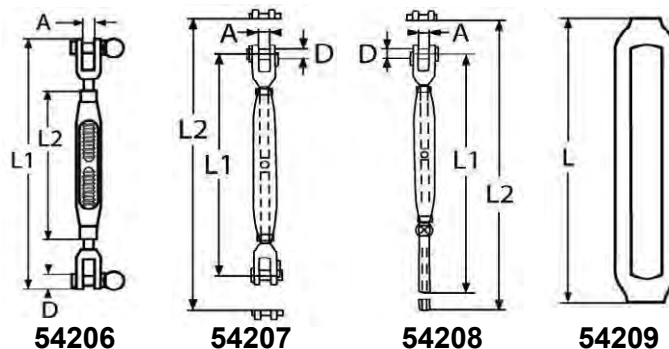

Article groups

Material	Code	Page
St.St. A4	54206	13-41
St.St. A4	54207	13-41
St.St. A4	54208	13-41
St.St. A4	54209	13-41

54206 Frame turnbuckle with two forks MH11
Material Stainless steel A4

Thread	☒	Art.number	Thread	☒	Art.number	Thread	☒	Art.number
M5*	10	54206.050.001	M10*	5	54206.100.001	M16*	1	54206.160.001
M6*	10	54206.060.001	M12*	5	54206.120.001	M20*	1	54206.200.001
M8*	10	54206.080.001	M14*	1	54206.140.001			

54207 Turnbuckle with two forks, milled forkhead MH11
Material Stainless steel A4

Thread	☒	Art.number	Thread	☒	Art.number	Thread	☒	Art.number
M5*	10	54207.050.001	M10*	5	54207.100.001	M14*	1	54207.140.001
M6*	10	54207.060.001	M12*	5	54207.120.001	M16*	1	54207.160.001
M8*	10	54207.080.001						

54208 Turnbuckle fork-terminal, milled forkhead MH11
Material Stainless steel A4

Thread / WR-ø	☒	Art.number	Thread / WR-ø	☒	Art.number	Thread / WR-ø	☒	Art.number
M5/2,5MM*	10	54208.050.025	M8/5MM*	10	54208.080.050	M12/8MM*	5	54208.120.080
M6/3MM*	10	54208.060.030	M10/5MM*	5	54208.100.050	M14/7MM*	1	54208.140.070
M6/4MM*	10	54208.060.040	M10/6MM*	5	54208.100.060	M16/8MM*	1	54208.160.080
M8/4MM*	10	54208.080.040	M12/6MM*	5	54208.120.060	M16/10MM*	1	54208.160.100

54209 Turnbuckle frame MH11
Material Stainless steel A4



Thread	☒	Art.number	Thread	☒	Art.number	Thread	☒	Art.number
M6*	10	54209.060.001	M10*	5	54209.100.001	M16*	1	54209.160.001
M8*	10	54209.080.001	M12*	5	54209.120.001	M20*	1	54209.200.001

Turnbuckle

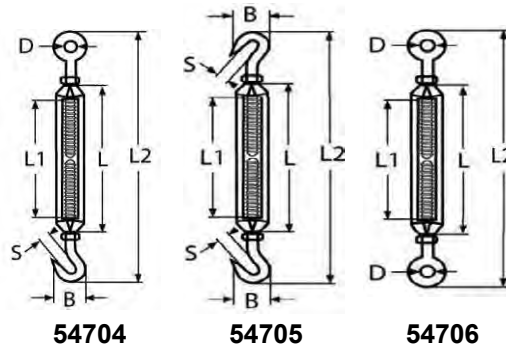

Technical Data

Nr.	B	D	L	L ₁	L ₂	S	Thread	≈ Breaking load (N)
54704.060.001	16	10	90	66	160	10	M6	3.200
54704.080.001	20	14	120	94	200	11	M8	5.600
54704.100.001	28	16	150	120	240	12	M10	8.800
54704.120.001	36	18	200	168	300	14	M12	12.000
54704.160.001	40	26	250	210	390	16	M16	24.000
54704.200.001	50	30	300	245	440	18	M20	36.000
54705.060.001	16	10	90	66	160	10	M6	3.200
54705.080.001	20	14	120	94	200	11	M8	5.600
54705.100.001	28	16	150	120	240	12	M10	8.800
54705.120.001	36	18	200	168	300	14	M12	12.000
54705.160.001	40	26	250	210	390	16	M16	24.000
54705.200.001	50	30	300	245	440	18	M20	36.000
54706.060.001	16	10	90	66	160	10	M6	3.200
54706.080.001	20	14	120	94	200	11	M8	5.600
54706.100.001	28	16	150	120	240	12	M10	8.800
54706.120.001	36	18	200	168	300	14	M12	12.000
54706.160.001	40	26	250	210	390	16	M16	24.000
54706.200.001	50	30	300	245	440	18	M20	36.000



Article groups

Material	Code	Page
St.St. A4	54704	13-42
St.St. A4	54705	13-43
St.St. A4	54706	13-43

54704 Turnbuckle hook-eye

MH11

Material Stainless steel A4



Thread	⊗	Art.number	Thread	⊗	Art.number	Thread	⊗	Art.number
M6*	1	54704.060.001	M10*	1	54704.100.001	M16*	1	54704.160.001
M8*	1	54704.080.001	M12*	1	54704.120.001	M20*	1	54704.200.001

54705	Turnbuckle hook-hook	MH11
Material	Stainless steel A4	

Thread	☒	Art.number	Thread	☒	Art.number	Thread	☒	Art.number
M6*	1	54705.060.001	M10*	1	54705.100.001	M16*	1	54705.160.001
M8*	1	54705.080.001	M12*	1	54705.120.001	M20*	1	54705.200.001

54706	Turnbuckle eye-eye	MH11
Material	Stainless steel A4	

Thread	☒	Art.number	Thread	☒	Art.number	Thread	☒	Art.number
M6*	1	54706.060.001	M10*	1	54706.100.001	M16*	1	54706.160.001
M8*	1	54706.080.001	M12*	1	54706.120.001	M20*	1	54706.200.001

Swage stud



Technical Data												
Nr.	A	D	D ₁	H	K	L	L ₁	L ₂	NV	Thread	WR-ø	
54210.050.025	-	-	-	-	-	-	40	86	4	M5	2.5	
54210.060.030	-	-	-	-	-	-	48	100	5	M6	3	
54210.060.040	-	-	-	-	-	-	48	110	6	M6	4	
54210.080.040	-	-	-	-	-	-	57	117	6	M8	4	
54210.080.050	-	-	-	-	-	-	57	124	7	M8	5	
54210.100.050	-	-	-	-	-	-	63	130	7	M10	5	
54210.100.060	-	-	-	-	-	-	63	145	10	M10	6	
54210.120.060	-	-	-	-	-	-	80	162	10	M12	6	
54210.120.080	-	-	-	-	-	-	80	180	14	M12	8	
54210.140.070	-	-	-	-	-	-	90	180	12	M14	7	
54210.160.080	-	-	-	-	-	-	100	200	14	M16	8	
54210.160.100	-	-	-	-	-	-	100	210	15	M16	10	
54210.200.100	-	-	-	-	-	-	119	230	15	M20	10	
54210.200.120	-	-	-	-	-	-	120	245	17	M20	12	
54210.220.140	-	-	-	-	-	-	140	308	22	M22	14	
54210.240.160	-	-	-	-	-	-	170	363	24	M24	16	
54211.050.025	-	-	-	-	-	-	40	86	4	M5	2.5	
54211.060.030	-	-	-	-	-	-	48	100	5	M6	3	
54211.060.040	-	-	-	-	-	-	48	110	6	M6	4	
54211.080.040	-	-	-	-	-	-	57	117	6	M8	4	
54211.080.050	-	-	-	-	-	-	57	124	7	M8	5	
54211.100.050	-	-	-	-	-	-	63	130	7	M10	5	
54211.100.060	-	-	-	-	-	-	63	145	10	M10	6	
54211.120.060	-	-	-	-	-	-	80	162	10	M12	6	
54211.120.080	-	-	-	-	-	-	80	180	14	M12	8	
54211.140.070	-	-	-	-	-	-	90	180	12	M14	7	
54211.160.080	-	-	-	-	-	-	100	200	14	M16	8	
54211.160.100	-	-	-	-	-	-	100	210	15	M16	10	
54211.200.100	-	-	-	-	-	-	119	230	15	M20	10	
54211.200.120	-	-	-	-	-	-	120	245	17	M20	12	
54212.030.001	-	6	-	8	5	97	48	38	-	-	3	
54212.040.001	-	8	-	10	6	115	54	45	-	-	4	
54212.050.001	-	10	-	10	7	128	61	52	-	-	5	

Technical Data

Nr.	A	D	D ₁	H	K	L	L ₁	L ₂	NV	Thread	WR-ø
54212.060.001	-	12	-	10	10	162	79	63	-	-	6
54213.030.001	-	6	-	8	5	97	48	38	-	-	3
54213.040.001	-	8	-	10	6	115	54	45	-	-	4
54213.050.001	-	10	-	10	7	128	61	52	-	-	5
54213.060.001	-	12	-	10	10	162	79	63	-	-	6
54214.050.001	40	4.4	-	-	-	85	-	-	-	M5	-
54214.060.001	45	5.2	-	-	-	100	-	-	-	M6	-
54214.080.001	52	7.0	-	-	-	112	-	-	-	M8	-
54214.100.001	62	8.8	-	-	-	127	-	-	-	M10	-
54214.120.001	75	10.7	-	-	-	140	-	-	-	M12	-
54214.140.001	82	12.5	-	-	-	150	-	-	-	M14	-
54214.160.001	95	14.2	-	-	-	170	-	-	-	M16	-
54214.200.001	105	18.1	-	-	-	185	-	-	-	M20	-
54215.050.001	40	4.4	-	-	-	85	-	-	-	M5	-
54215.060.001	45	5.2	-	-	-	100	-	-	-	M6	-
54215.080.001	52	7.0	-	-	-	112	-	-	-	M8	-
54215.100.001	62	8.8	-	-	-	127	-	-	-	M10	-
54215.120.001	75	10.7	-	-	-	140	-	-	-	M12	-
54215.140.001	82	12.5	-	-	-	150	-	-	-	M14	-
54215.160.001	95	14.2	-	-	-	170	-	-	-	M16	-
54215.200.001	105	18.1	-	-	-	185	-	-	-	M20	-
54216.025.001	-	5.4	5.5	-	-	48.5	-	-	-	-	2.5
54216.030.001	-	6.5	6.35	-	-	55	-	-	-	-	3
54216.040.001	-	8.5	7.5	-	-	65	-	-	-	-	4
54216.050.001	-	10.5	9.0	-	-	80	-	-	-	-	5
54216.060.001	-	12.5	12.5	-	-	94	-	-	-	-	6
54216.070.001	-	12.7	14	-	-	105	-	-	-	-	7
54216.080.001	-	14.5	16.0	-	-	124	-	-	-	-	8
54216.100.001	-	16.4	17.8	-	-	142	-	-	-	-	10
54216.120.001	-	19.3	19.5	-	-	160	-	-	-	-	12

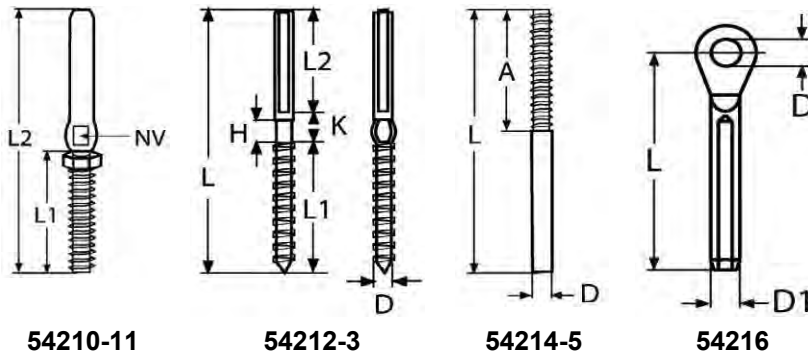

Article groups

Material	Code	Page
St.St. A4	54210	13-44
St.St. A4	54211	13-45
St.St. A4	54212	13-45
St.St. A4	54213	13-45
St.St. A4	54214	13-45
St.St. A4	54215	13-45
St.St. A4	54216	13-46

54210	Swage stud with nut, right thread	MH11
Material	Stainless steel A4	
		

Thread / WR-ø	☒	Art.number	Thread / WR-ø	☒	Art.number	Thread / WR-ø	☒	Art.number
M5/2,5MM*	10	54210.050.025	M8/5MM*	10	54210.080.050	M12/8MM*	5	54210.120.080
M6/3MM*	10	54210.060.030	M10/5MM*	5	54210.100.050	M14/7MM*	1	54210.140.070
M6/4MM*	10	54210.060.040	M10/6MM*	5	54210.100.060	M16/8MM*	1	54210.160.080
M8/4MM*	10	54210.080.040	M12/6MM*	5	54210.120.060	M16/10MM*	1	54210.160.100

54210 Swage stud with nut, right thread ←

Thread / WR-ø	☒	Art.number	Thread / WR-ø	☒	Art.number
M20/10MM*	1	54210.200.100	M22/14MM*	1	54210.220.140
M20/12MM*	1	54210.200.120	M24/16MM*	1	54210.240.160

54211 Swage stud with nut, left thread MH11

Material Stainless steel A4



Thread / WR-ø	☒	Art.number	Thread / WR-ø	☒	Art.number	Thread / WR-ø	☒	Art.number
M5/2,5MM*	10	54211.050.025	M10/5MM*	5	54211.100.050	M16/8MM*	1	54211.160.080
M6/3MM*	10	54211.060.030	M10/6MM*	5	54211.100.060	M16/10MM*	1	54211.160.100
M6/4MM*	10	54211.060.040	M12/6MM*	5	54211.120.060	M20/10MM*	1	54211.200.100
M8/4MM*	10	54211.080.040	M12/8MM*	5	54211.120.080	M20/12MM*	1	54211.200.120
M8/5MM*	10	54211.080.050	M14/7MM*	1	54211.140.070			

54212 Swage stud with wood thread, right MH11



Material Stainless steel A4



WR-ø	☒	Art.number	WR-ø	☒	Art.number	WR-ø	☒	Art.number
3MM*	10	54212.030.001	5MM*	5	54212.050.001	6MM*	5	54212.060.001
4MM*	10	54212.040.001						

54213 Swage stud with wood thread, left MH11

Material Stainless steel A4

WR-ø	☒	Art.number	WR-ø	☒	Art.number	WR-ø	☒	Art.number
3MM*	10	54213.030.001	5MM*	5	54213.050.001	6MM*	5	54213.060.001
4MM*	10	54213.040.001						

54214 Welding stud, right thread MH11

Material Stainless steel A4





Thread	☒	Art.number	Thread	☒	Art.number	Thread	☒	Art.number
M5*	10	54214.050.001	M10*	5	54214.100.001	M16*	1	54214.160.001
M6*	10	54214.060.001	M12*	5	54214.120.001	M20*	1	54214.200.001
M8*	10	54214.080.001	M14*	1	54214.140.001			

54215 Welding stud, left thread MH11

Material Stainless steel A4



Thread	☒	Art.number	Thread	☒	Art.number	Thread	☒	Art.number
M5*	10	54215.050.001	M10*	5	54215.100.001	M16*	1	54215.160.001
M6*	10	54215.060.001	M12*	5	54215.120.001	M20*	1	54215.200.001
M8*	10	54215.080.001	M14*	1	54215.140.001			

54216	Eye terminal	MH11
Material	Stainless steel A4	
		

WR-ø	☒	Art.number	WR-ø	☒	Art.number	WR-ø	☒	Art.number
2.5MM*	10	54216.025.001	5MM*	5	54216.050.001	8MM*	1	54216.080.001
3MM	10	54216.030.001	6MM*	5	54216.060.001	10MM*	1	54216.100.001
4MM*	10	54216.040.001	7MM*	5	54216.070.001	12MM*	1	54216.120.001

T-Terminal





Technical Data

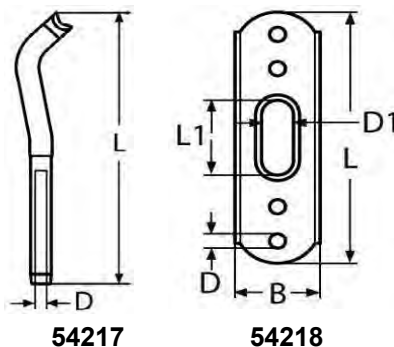

Nr.	B	D	D ₁	L	L ₁	WR-ø
54217.030.001	-	-	-	85	-	3
54217.040.001	-	-	-	100	-	4
54217.050.001	-	-	-	115	-	5
54217.060.001	-	-	-	140	-	6
54217.070.001	-	-	-	145	-	7
54217.080.001	-	-	-	185	-	8
54217.100.001	-	-	-	215	-	10
54218.040.001	27	5.0	9.9	88	27	4
54218.050.001	27	5.0	9.9	88	27	5
54218.060.001	39	6.3	15.6	122	35	6
54218.070.001	39	6.4	15.9	122	35	7
54218.080.001	39	6.5	18.8	151	41	8
54218.100.001	39	6.5	18.8	151	41	10



Article groups

Material	Code	Page
St.St. A4	54217	13-47
St.St. A4	54218	13-47

54217 T-Terminal		MH11						
Material	Stainless steel A4							
								
								
WR-ø	☒	Art.number	WR-ø	☒	Art.number	WR-ø	☒	Art.number
3MM*	1	54217.030.001	6MM*	1	54217.060.001	8MM*	1	54217.080.001
4MM*	1	54217.040.001	7MM*	1	54217.070.001	10MM*	1	54217.100.001
5MM*	1	54217.050.001						

54218 Back plate for T-terminal		MH11						
Material	Stainless steel A4							
								
								
WR-ø	☒	Art.number	WR-ø	☒	Art.number	WR-ø	☒	Art.number
4MM*	1	54218.040.001	6MM*	1	54218.060.001	8MM*	1	54218.080.001
5MM*	1	54218.050.001	7MM*	1	54218.070.001	10MM*	1	54218.100.001

Terminal



Technical Data						
Nr.	A	d	D	H	L ₁	L ₂
54219.030.001	7	-	6	15	-	-
54219.040.001	10	-	8	20	-	-
54219.050.001	12	-	9	25	-	-
54219.060.001	13	-	12	30	-	-
54219.080.001	17	-	16	40	-	-
54219.100.001	20	-	19	45	-	-
54220.025.001	6.5	-	5	-	-	-
54220.030.001	7.5	-	6	-	-	-
54220.040.001	11	-	8	-	-	-
54220.050.001	12	-	9	-	-	-
54220.060.001	14	-	12	-	-	-
54220.070.001	15	-	12	-	-	-
54220.080.001	17	-	16	-	-	-
54220.100.001	20	-	18	-	-	-
54220.120.001	23	-	19	-	-	-
54220.140.001	30	-	22	-	-	-
54220.160.001	30	-	25	-	-	-
54221.030.001	7.5	-	6	-	73	-
54221.040.001	11	-	8	-	86	-
54221.050.001	12	-	9	-	100	-
54221.060.001	14	-	12	-	128	-
54221.070.001	15	-	12	-	135	-
54221.080.001	17	-	16	-	155	-
54223.050.001	6	M5	5	13	62	42
54223.060.001	7	M6	6	15	77	48
54223.080.001	10	M8	8	20	94	56
54223.100.001	12	M10	9	25	115	67
54223.120.001	13	M12	12	30	136	81
54223.140.001	15	M14	14	35	140	89
54223.160.001	17	M16	16	40	163	103
54223.200.001	20	M20	19	45	198	115
54224.050.001	6	M5	5	13	62	42
54224.060.001	7	M6	6	15	77	48

Technical Data

Nr.	A	d	D	H	L ₁	L ₂
54224.080.001	10	M8	8	20	94	56
54224.100.001	12	M10	9	25	116	67
54224.120.001	13	M12	12	30	136	81
54224.140.001	15	M14	14	35	140	89
54224.160.001	17	M16	16	40	163	103
54224.200.001	20	M20	19	45	198	115

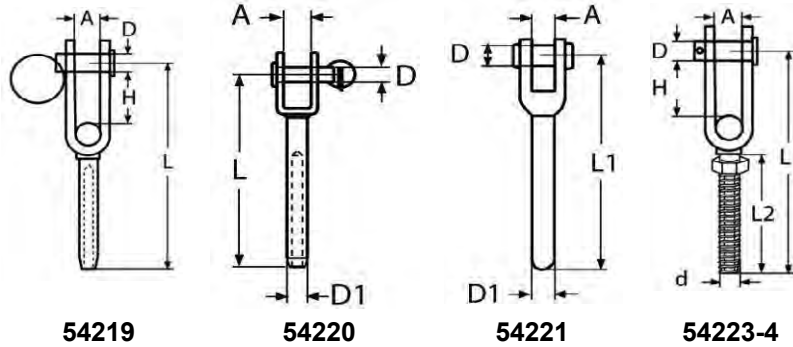

Article groups

Material	Code	Page
St.St. A4	54219	13-48
St.St. A4	54220	13-48
St.St. A4	54221	13-48
St.St. A4	54223	13-49
St.St. A2	54224	13-49

54219 Toggle terminal MH11

Material: Stainless steel A4

WR-ø	⊗	Art.number	WR-ø	⊗	Art.number	WR-ø	⊗	Art.number
3MM*	5	54219.030.001	5MM*	5	54219.050.001	8MM*	1	54219.080.001
4MM*	5	54219.040.001	6MM*	5	54219.060.001	10MM*	1	54219.100.001

54220 Fork terminal MH11



Material: Stainless steel A4

WR-ø	⊗	Art.number	WR-ø	⊗	Art.number	WR-ø	⊗	Art.number
2,5MM*	10	54220.025.001	6MM*	5	54220.060.001	12MM*	1	54220.120.001
3MM*	10	54220.030.001	7MM*	5	54220.070.001	14MM*	1	54220.140.001
4MM*	10	54220.040.001	8MM*	5	54220.080.001	16MM*	1	54220.160.001
5MM*	5	54220.050.001	10MM*	1	54220.100.001			



54221 Milled fork terminal MH11

Material: Stainless steel A4

WR-ø	⊗	Art.number	WR-ø	⊗	Art.number	WR-ø	⊗	Art.number
3MM*	10	54221.030.001	5MM*	5	54221.050.001	7MM*	5	54221.070.001
4MM*	10	54221.040.001	6MM*	5	54221.060.001	8MM*	5	54221.080.001

54223	Toggle with right thread	MH11
Material	Stainless steel A4	
		
		

d	☒	Art.number	d	☒	Art.number	d	☒	Art.number
M5*	10	54223.050.001	M10*	5	54223.100.001	M16*	1	54223.160.001
M6*	10	54223.060.001	M12*	5	54223.120.001	M20*	1	54223.200.001
M8*	5	54223.080.001	M14*	1	54223.140.001			

54224	Toggle with left thread	MH11
Material	Stainless steel A2	
		
		

d	☒	Art.number	d	☒	Art.number	d	☒	Art.number
M5*	10	54224.050.001	M10*	5	54224.100.001	M16*	1	54224.160.001
M6*	10	54224.060.001	M12*	5	54224.120.001	M20*	1	54224.200.001
M8*	5	54224.080.001	M14*	1	54224.140.001			

Toggle for turnbuckles



Technical Data					
Nr.	A	D ₁	D ₂	H	L
54222.050.001	6	5.5	5.2	7	22
54222.060.001	7	6.6	6.3	9	27
54222.080.001	10	8.5	8.3	10	31
54222.100.001	12	10.0	9.3	12	36
54222.120.001	13	13.0	12.4	17	50
54222.140.001	14	15.0	15.0	20	60
54222.160.001	15	16.5	17.0	29	80

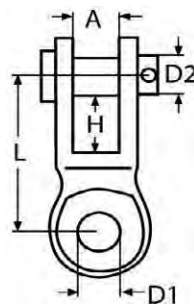

54222

54222	Toggle for turnbuckles	MH11
Material	Stainless steel A4	
		

A	☒	Art.number	A	☒	Art.number	A	☒	Art.number
6MM*	5	54222.050.001	12MM*	1	54222.100.001	14MM*	1	54222.140.001
7MM*	5	54222.060.001	13MM*	1	54222.120.001	15MM*	1	54222.160.001
10MM*	5	54222.080.001						

Stay adjuster



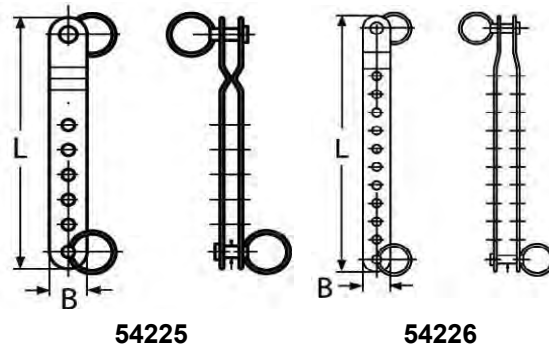

Technical Data

Nr.	B	Bolt	L
54225.104.001	15	5	104
54226.100.001	15	5	100
54226.155.001	15	5	155
54226.200.001	15	5	200



Article groups

Material	Code	Page
St.St. A2	54225	13-50
St.St. A2	54226	13-51

54225	Stay adjuster	MH11
Material	Stainless steel A2	
		

L	☒	Art.number
104MM*	5	54225.104.001

54226	Stay adjuster	MH11
Material	Stainless steel A2	
		

L	☒	Art.number	L	☒	Art.number	L	☒	Art.number
100MM*	5	54226.100.001	155MM*	5	54226.155.001	200MM*	5	54226.200.001

Pelican hook with thread



Technical Data				
Nr.	d	D	L	≈ Breaking load (N)
54227.060.001	M6	18.5	75	12.000
54227.080.001	M8	27.0	100	15.000
54227.100.001	M10	35.0	144	35.000
54227.120.001	M12	39.0	150	35.000

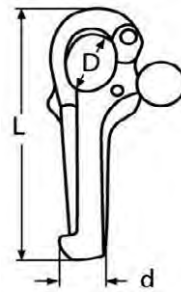

54227

54227	Pelican hook with thread	MH11
Material	Stainless steel A4	
		

d	☒	Art.number	d	☒	Art.number	d	☒	Art.number
6MM*	1	54227.060.001	10MM*	1	54227.100.001	12MM*	1	54227.120.001
8MM*	1	54227.080.001						

Pelican hook



Technical Data

Nr.	D	L
54228.100.001	18	100
54228.150.001	22	150

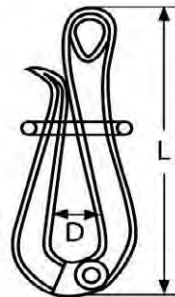

54228

54228	Pelican hook	MH11
Material	Stainless steel A4	
		

L	☒	Art.number	L	☒	Art.number
100MM*	5	54228.100.001	150MM*	5	54228.150.001

Quick attach terminal



Technical Data

Nr.	B	C	d	D	H	L	WR-ø
54229.040.001	8	6.5	-	-	-	67	4
54229.050.001	10	8	-	-	-	80	5
54229.060.001	12	9	-	-	-	95	6
54229.080.001	14	10	-	-	-	119	8
54230.040.001	-	8	-	8	8	72	4
54230.050.001	-	10	-	10	10	82	5
54230.060.001	-	12	-	12	12	94	6
54230.080.001	-	14	-	14	14	116	8
54231.040.001	-	57	M8	-	-	100	4
54231.050.001	-	63	M10	-	-	117	5
54231.060.001	-	80	M12	-	-	145	6
54231.080.001	-	100	M16	-	-	182	8

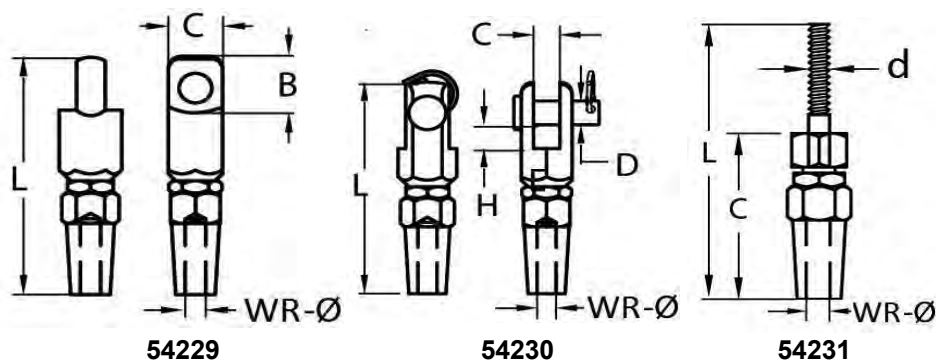

Article groups

Material	Code	Page
St.St. A4	54229	13-53
St.St. A4	54230	13-53
St.St. A4	54231	13-54

54229 Quick attach eye

MH11

Material: Stainless steel A4



WR-ø	Art.number	WR-ø	Art.number	WR-ø	Art.number
4MM*	1 54229.040.001	6MM*	1 54229.060.001	8MM*	1 54229.080.001
5MM*	1 54229.050.001				

54230 Quick attach jaw

MH11

Material: Stainless steel A4



WR-ø	Art.number	WR-ø	Art.number	WR-ø	Art.number
4MM*	1 54230.040.001	6MM*	1 54230.060.001	8MM*	1 54230.080.001
5MM*	1 54230.050.001				

54231	Fast and bolt terminal	MH11
Material	Stainless steel A4	
		

WR-ø	☒	Art.number	WR-ø	☒	Art.number	WR-ø	☒	Art.number
4MM*	1	54231.040.001	6MM*	1	54231.060.001	8MM*	1	54231.080.001
5MM*	1	54231.050.001						

Wire rope

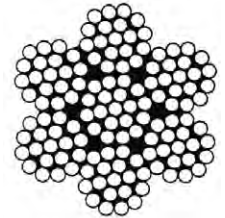

Technical Data

Nr.	Weight (kg/m)	WR-ø	≈ Breaking load min. (N)
54232.020.001	0.015	2	2.330
54232.030.001	0.035	3	4.690
54232.040.001	0.061	4	8.340
54232.050.001	0.096	5	13.000
54232.060.001	0.138	6	18.800
54232.070.001	0.187	7	25.500
54232.080.001	0.243	8	33.300
54232.100.001	0.381	10	52.100
54232.120.001	0.548	12	75.000
54232.140.001	0.764	14	102.000
54233.020.001	0.016	2	2.250
54233.030.001	0.035	3	5.070
54233.040.001	0.063	4	9.010
54233.050.001	0.098	5	14.100
54233.060.001	0.142	6	20.300
54233.070.001	0.193	7	27.600
54233.080.001	0.252	8	36.100
54233.100.001	0.303	10	56.300
54234.040.601	-	4/6	-
54234.040.701	-	4/7	-
54235.010.015	0.012	1/1.5	630
54235.012.020	0.014	1.25/2	880
54235.020.030	0.023	2/3	2.250
54235.030.040	0.044	3/4	5.070
54235.040.050	0.072	4/5	9.010
54235.050.070	0.117	5/7	14.100
54236.010.001	0.005	1	830
54236.020.001	0.02	2	3.300
54236.030.001	0.045	3	7.420
54236.040.001	0.08	4	13.200
54236.050.001	0.124	5	20.600
54236.060.001	0.178	6	29.700
54236.070.001	0.243	7	40.400
54236.080.001	0.317	8	52.800
54236.100.001	0.495	10	82.500
54236.120.001	0.713	12	119.000
54236.140.001	0.971	14	162.000
54236.160.001	1.27	16	211.000

Article groups

Material	Color	Code	Page
St.St. A4		54232	13-55
St.St. A4		54233	13-55
St.St. A4	White	54234	13-55

Article groups			
Material	Color	Code	Page
St.St. A4	Transparent	54235	13-55
St.St. A4		54236	13-55

54232 Wire rope, flexible 7x19		MH11
Material	Stainless steel A4	
		

WR-ø	☒	Art.number	WR-ø	☒	Art.number	WR-ø	☒	Art.number
2MM-250MTR*	1	54232.020.001	6MM-250MTR*	1	54232.060.001	10MM-250MTR*	1	54232.100.001
3MM-250MTR	1	54232.030.001	7MM-250MTR*	1	54232.070.001	12MM-250MTR*	1	54232.120.001
4MM-250MTR*	1	54232.040.001	8MM-250MTR*	1	54232.080.001	14MM-250MTR*	1	54232.140.001
5MM-250MTR*	1	54232.050.001						

54233 Wire rope, semi soft 7x7		MH11
Material	Stainless steel A4	
		

WR-ø	☒	Art.number	WR-ø	☒	Art.number	WR-ø	☒	Art.number
2MM-250MTR*	1	54233.020.001	5MM-250MTR*	1	54233.050.001	8MM-250MTR*	1	54233.080.001
3MM-250MTR*	1	54233.030.001	6MM-250MTR*	1	54233.060.001	10MM-250MTR*	1	54233.100.001
4MM-250MTR*	1	54233.040.001	7MM-250MTR*	1	54233.070.001			

54234 PVC white coated wire rope, semi soft, 7x7		MH11
Material	Stainless steel A4	
Color	White	

WR-ø	☒	Art.number	WR-ø	☒	Art.number
4/6-250MTR*	1	54234.040.601	4/7-250MTR*	1	54234.040.701

54235 PVC transparent coated wire rope, semi soft, 7x7		MH11
Material	Stainless steel A4	
Color	Transparent	

WR-ø	☒	Art.number	WR-ø	☒	Art.number	WR-ø	☒	Art.number
1/1,5 250MTR*	1	54235.010.015	2/3 250MTR*	1	54235.020.030	4/5 -250MTR*	1	54235.040.050
1,25/2 250MTR*	1	54235.012.020	3/4 250MTR*	1	54235.030.040	5/7 250MTR*	1	54235.050.070

54236 Wire rope 1x19		MH11
Material	Stainless steel A4	
		

WR-ø	☒	Art.number	WR-ø	☒	Art.number	WR-ø	☒	Art.number
1MM-250MTR*	1	54236.010.001	5MM-250MTR*	1	54236.050.001	10MM-250MTR*	1	54236.100.001
2MM-250MTR*	1	54236.020.001	6MM-250MTR*	1	54236.060.001	12MM-250MTR*	1	54236.120.001
3MM-250MTR*	1	54236.030.001	7MM-250MTR*	1	54236.070.001	14MM-250MTR*	1	54236.140.001
4MM-250MTR*	1	54236.040.001	8MM-250MTR*	1	54236.080.001	16MM-250MTR*	1	54236.160.001

Wire rope cutter



Technical Data

Nr.	L	ø wire max.
54258.050.001	195	5
54258.120.001	470	12
54258.160.001	800	16
54258.120.100	-	12
54258.160.100	-	16

54258 Wire rope cutter

MH11



Size	☒	Art.number	Size	☒	Art.number	Size	☒	Art.number
5MM*	1	54258.050.001	Spare blade 12MM*	1	54258.120.100	Spare blade 16MM*	1	54258.160.100
12MM*	1	54258.120.001	16MM*	1	54258.160.001			

Wire thimble



Technical Data

Nr.	B	C	D	E	K	L	L ₁	S	WR-ø
54237.060.001	23	-	-	-	-	37	11	-	6
54237.080.001	31	-	-	-	-	50	15	-	8
54237.100.001	39	-	-	-	-	53	21	-	10
54237.120.001	42	-	-	-	-	60	25	-	12
54237.140.001	51	-	-	-	-	74	30	-	14
54238.040.001	11	18	-	-	-	-	-	1.0	4
54238.050.001	14	20	-	-	-	-	-	1.2	5
54238.060.001	15	23	-	-	-	-	-	1.2	6
54238.080.001	18	29	-	-	-	-	-	1.5	8
54238.100.001	24	37	-	-	-	-	-	1.5	10
54239.020.001	5	15	21	15	6.4	-	-	-	2
54239.030.003	6	20	26	18	8.4	-	-	-	3
54239.040.001	7	25	32	21	11	-	-	-	4
54239.050.001	9	31	42	28	12	-	-	-	5
54239.060.001	10	32	43	28	12	-	-	-	6
54239.080.001	11	41	58	43	13	-	-	-	8
54239.100.001	13	50	72	51	14	-	-	-	10
54239.120.001	16	60	86	62	16	-	-	-	12
54239.160.001	20	75	110	82	21	-	-	-	16
54239.190.001	24	90	124	94	31	-	-	-	19
54239.220.001	28	100	130	100	38	-	-	-	22
54239.250.001	32	116	148	115	48	-	-	-	25
54240.040.001	13	19	-	-	-	-	-	2	4
54240.060.001	16	22	-	-	-	-	-	2	6
54240.080.001	23	38	-	-	-	-	-	2	8

Technical Data

Nr.	B	C	D	E	K	L	L ₁	S	WR-ø
54240.100.001	24	40	-	-	-	-	-	3	10
54240.120.001	24	41	-	-	-	-	-	3	12
54240.140.001	26	44	-	-	-	-	-	3	14
54240.160.001	34	54	-	-	-	-	-	5	16
54240.180.001	34	56	-	-	-	-	-	6	18
54240.200.001	35	57	-	-	-	-	-	6	20

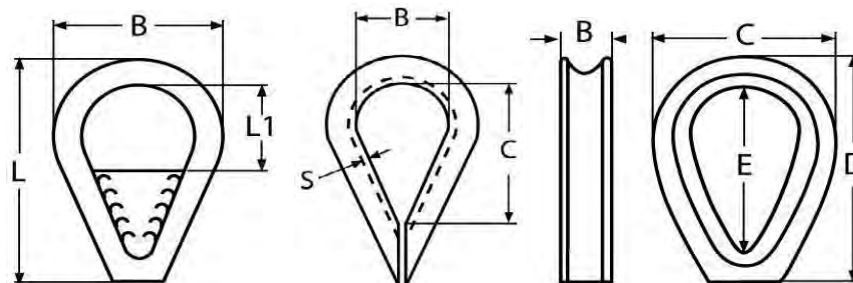

54237

54238-40

54239

Article groups

Material	Code	Page
St.St. A4	54237	13-57
St.St. A4	54238	13-57
St.St. A4	54239	13-57
Plastic	54240	13-58

54237 Thimble with bar

MH11

Material Stainless steel A4



WR-ø	Art.number	WR-ø	Art.number	WR-ø	Art.number
6MM*	10 54237.060.001	10MM*	10 54237.100.001	14MM*	5 54237.140.001
8MM*	10 54237.080.001	12MM*	5 54237.120.001		

54238 Wire thimble

MH11

Material Stainless steel A4



WR-ø	Art.number	WR-ø	Art.number	WR-ø	Art.number
4MM	50 54238.040.001	6MM	20 54238.060.001	10MM*	20 54238.100.001
5MM	50 54238.050.001	8MM*	20 54238.080.001		

54239 Thimble heavy and closed

MH11

Material Stainless steel A4



WR-ø	Art.number	WR-ø	Art.number	WR-ø	Art.number
2MM*	10 54239.020.001	6MM*	10 54239.060.001	16MM*	1 54239.160.001
3MM	10 54239.030.003	8MM*	5 54239.080.001	19MM*	1 54239.190.001
4MM*	10 54239.040.001	10MM*	5 54239.100.001	22MM*	1 54239.220.001
5MM*	10 54239.050.001	12MM*	5 54239.120.001	25MM*	1 54239.250.001

54240	Nylon thimble	MH11
Material	Plastic	

WR-ø	☒	Art.number	WR-ø	☒	Art.number	WR-ø	☒	Art.number
4MM*	20	54240.040.001	10MM*	10	54240.100.001	16MM*	5	54240.160.001
6MM*	20	54240.060.001	12MM*	10	54240.120.001	18MM*	5	54240.180.001
8MM*	20	54240.080.001	14MM*	10	54240.140.001	20MM*	5	54240.200.001

Wire rope clip



Technical Data

Nr.	A	B	C	d	H	L	Socket	WR-ø
54241.030.001	-	-	-	M3	-	-	-	3
54241.050.001	-	-	-	M5	-	-	-	5
54241.060.001	-	-	-	M6	-	-	-	6
54241.080.001	-	-	-	M6	-	-	-	8
54241.100.001	-	-	-	M8	-	-	-	10
54241.120.001	-	-	-	M10	-	-	-	13
54241.160.001	-	-	-	M10	-	-	-	16
54242.020.001	-	-	-	-	11	28	T20	2
54242.030.001	-	-	-	-	12	28	T25	3
54242.040.001	-	-	-	-	14	34	T30	4
54242.050.001	-	-	-	-	15	34	T30	5
54242.060.001	-	-	-	-	15	35	T30	6
54243.020.001	11.5	33	-	M4	-	-	-	2
54243.030.001	14.5	38	-	M4	-	-	-	3
54243.040.001	16.5	43	-	M5	-	-	-	4
54243.050.001	20.0	51	-	M5	-	-	-	5
54243.060.001	24.5	63	-	M6	-	-	-	6
54243.080.001	31.5	78	-	M8	-	-	-	8
54243.100.001	38.0	96	-	M10	-	-	-	10
54244.020.001	4	11.5	15	M4	-	-	-	2
54244.030.001	6	14.5	18	M4	-	-	-	3
54244.040.001	8	16.5	20	M5	-	-	-	4
54244.050.001	10	20.0	24	M5	-	-	-	5
54244.060.001	12	24.5	29	M6	-	-	-	6
54244.080.001	16	31.5	35	M8	-	-	-	8
54244.100.001	20	38.0	48	M10	-	-	-	10

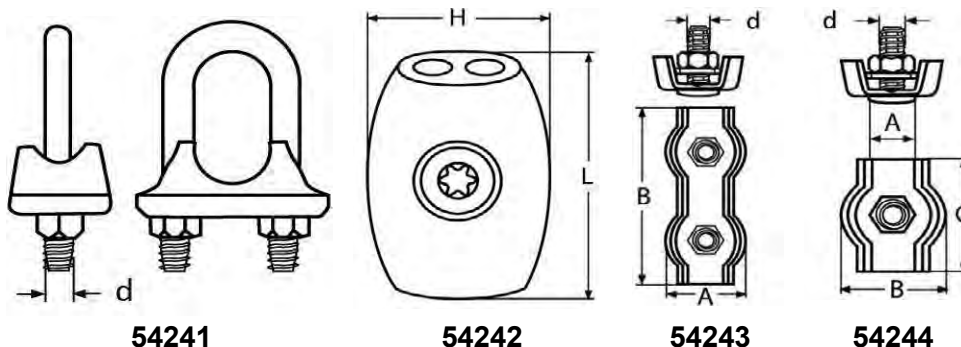

Article groups

Material	Code	Page
St.St. A4	54241	13-59

Article groups

Material	Code	Page
St.St. A4	54242	13-59
St.St. A4	54243	13-59
St.St. A4	54244	13-59

54241 Wire rope clip MH11

Material Stainless steel A4



WR-ø	⊗	Art.number	WR-ø	⊗	Art.number	WR-ø	⊗	Art.number
3MM	20	54241.030.001	8MM*	10	54241.080.001	12MM*	10	54241.120.001
5MM	20	54241.050.001	10MM*	10	54241.100.001	16MM*	5	54241.160.001
6MM	20	54241.060.001						

54242 Egg shaped wire clamp MH11

Material Stainless steel A4



WR-ø	⊗	Art.number	WR-ø	⊗	Art.number	WR-ø	⊗	Art.number
2MM*	10	54242.020.001	4MM*	10	54242.040.001	6MM*	5	54242.060.001
3MM	10	54242.030.001	5MM*	5	54242.050.001			

54243 Duplex wire rope clip MH11

Material Stainless steel A4



WR-ø	⊗	Art.number	WR-ø	⊗	Art.number	WR-ø	⊗	Art.number
2MM*	20	54243.020.001	5MM*	10	54243.050.001	8MM*	5	54243.080.001
3MM*	20	54243.030.001	6MM*	10	54243.060.001	10MM*	5	54243.100.001
4MM*	20	54243.040.001						

54244 Simplex wire rope clip MH11

Material Stainless steel A4



WR-ø	⊗	Art.number	WR-ø	⊗	Art.number	WR-ø	⊗	Art.number
2MM*	20	54244.020.001	5MM*	10	54244.050.001	8MM*	10	54244.080.001
3MM*	20	54244.030.001	6MM*	10	54244.060.001	10MM*	10	54244.100.001
4MM*	20	54244.040.001						

Ferrules



Technical Data

Nr.	A	B	Clamping size	L	S	WR-ø
54245.010.001	1.7	3.4	1.5	6	0.75	1
54245.015.001	2.4	4.8	2.0	7	0.85	1.5
54245.020.001	2.7	5.4	2.5	9	1.0	2
54245.030.001	3.8	7.6	3.5	13	1.5	3
54245.040.001	4.9	9.8	4.5	16	1.9	4
54245.050.001	6.6	13.2	6.0	21	2.5	5
54245.060.001	7.2	14.4	6.5	23	2.7	6
54245.070.001	8.8	17.6	8.0	28	3.3	7
54245.080.001	9.9	19.8	9.0	32	3.7	8
54245.100.001	12.1	24.2	11.0	39	4.5	10
54245.120.001	14.2	28.4	13.0	46	5.4	12
54245.160.001	19.6	39.2	18.0	63	7.6	16
54246.010.001	1.2	2.4	1.0	5	0.65	1
54246.020.001	2.5	4.5	2.0	9	1.0	2
54246.030.001	3.5	7.5	3.0	11	1.0	3
54246.040.001	4.5	9.2	4.0	14	1.5	4
54246.050.001	5.6	11.5	5.0	18	2.0	5
54246.060.001	6.8	13.5	6.0	21	2.5	6
54246.070.001	8.0	16.5	7.0	25	2.5	7
54246.080.001	9.0	18	8.0	28	3.0	8
54246.100.001	11.5	22.5	10.0	35	3.2	10
54246.120.001	14.2	28.5	12.0	42	4.0	12
54247.010.001	1.7	3.4	1.5	6	0.75	1
54247.015.001	2.4	4.8	2.0	7	0.85	1.5
54247.020.001	2.7	5.4	2.5	9	1.0	2
54247.030.001	3.8	7.6	3.5	13	1.5	3
54247.040.001	4.9	9.8	4.5	16	1.9	4
54247.050.001	6.6	13.2	6.0	21	2.5	5
54247.060.001	7.2	14.4	6.5	23	2.7	6
54247.070.001	8.8	17.6	8.0	28	3.3	7
54247.080.001	9.9	19.8	9.0	32	3.7	8
54247.100.001	12.1	24.2	11.0	39	4.5	10
54247.120.001	14.2	28.4	13.0	46	5.4	12

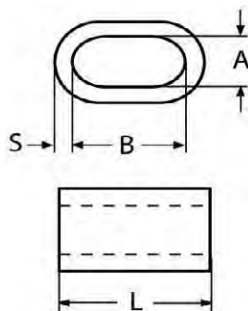

54245-6-7

Article groups

Material	Code	Page
Cu	54245	13-61
St.St. A4	54246	13-61
Al	54247	13-61

54245 Copper ferrule MH11
Material Copper

WR-ø	☒	Art.number	WR-ø	☒	Art.number	WR-ø	☒	Art.number
1MM*	100	54245.010.001	4MM*	100	54245.040.001	8MM*	5	54245.080.001
1,5MM*	100	54245.015.001	5MM*	50	54245.050.001	10MM*	1	54245.100.001
2MM*	100	54245.020.001	6MM*	50	54245.060.001	12MM*	1	54245.120.001
3MM*	100	54245.030.001	7MM*	5	54245.070.001	16MM*	10	54245.160.001

54246 Stainless steel ferrule MH11
Material Stainless steel A4

WR-ø	☒	Art.number	WR-ø	☒	Art.number	WR-ø	☒	Art.number
1MM*	10	54246.010.001	5MM*	10	54246.050.001	8MM*	5	54246.080.001
2MM*	10	54246.020.001	6MM*	10	54246.060.001	10MM*	1	54246.100.001
3MM*	10	54246.030.001	7MM*	5	54246.070.001	12MM*	1	54246.120.001
4MM*	10	54246.040.001						

54247 Aluminium ferrule MH11
Material Aluminium

WR-ø	☒	Art.number	WR-ø	☒	Art.number	WR-ø	☒	Art.number
1MM	100	54247.010.001	4MM*	100	54247.040.001	8MM*	10	54247.080.001
1,5MM	100	54247.015.001	5MM*	50	54247.050.001	10MM*	10	54247.100.001
2MM	100	54247.020.001	6MM*	50	54247.060.001	12MM*	5	54247.120.001
3MM*	100	54247.030.001	7MM*	10	54247.070.001			

Hand swager and swaging die



Technical Data

Nr.	Clamping size
54259.010.045	1.0-4.5
54259.010.001	1.0
54259.015.001	1.5
54259.020.001	2.0
54259.025.001	2.5
54259.030.001	3.0
54259.035.001	3.5
54259.040.001	4.0
54259.045.001	4.5

54259 Hand swager and swaging die

MH11



Size	☒	Art.number	Size	☒	Art.number	Size	☒	Art.number
1,0 dies*	1	54259.010.001	2,0 dies*	1	54259.020.001	3,5 dies*	1	54259.035.001
1,0-4,5 pliers without dies*	1	54259.010.045	2,5 dies*	1	54259.025.001	4,0 dies*	1	54259.040.001
1,5 dies*	1	54259.015.001	3,0 dies*	1	54259.030.001	4,5 dies*	1	54259.045.001

Safety pin



Technical Data										
Nr.	A	B	C	D	E	F	L	L ₁	N	ø
54248.040.014	-	-	-	4	-	-	14	-	11	-
54248.040.020	-	-	-	4	-	-	20	-	16	-
54248.050.015	-	-	-	5	-	-	15	-	11	-
54248.050.018	-	-	-	5	-	-	18	-	14	-
54248.050.021	-	-	-	5	-	-	21	-	17	-
54248.060.015	-	-	-	6	-	-	15	-	11	-
54248.060.020	-	-	-	6	-	-	20	-	16	-
54248.060.024	-	-	-	6	-	-	24	-	20	-
54248.060.025	-	-	-	6	-	-	25	-	21	-
54248.060.029	-	-	-	6	-	-	29	-	25	-
54248.060.034	-	-	-	6	-	-	34	-	30	-
54248.060.036	-	-	-	6	-	-	36	-	32	-
54248.060.044	-	-	-	6	-	-	44	-	40	-
54248.060.045	-	-	-	6	-	-	45	-	41	-
54248.060.054	-	-	-	6	-	-	54	-	50	-
54248.060.064	-	-	-	6	-	-	64	-	60	-
54248.080.021	-	-	-	8	-	-	21	-	17	-
54248.080.024	-	-	-	8	-	-	24	-	20	-
54248.080.027	-	-	-	8	-	-	27	-	23	-
54248.080.032	-	-	-	8	-	-	32	-	28	-
54248.080.034	-	-	-	8	-	-	34	-	30	-
54248.080.044	-	-	-	8	-	-	44	-	40	-
54248.080.054	-	-	-	8	-	-	54	-	50	-
54248.080.064	-	-	-	8	-	-	64	-	60	-
54248.080.074	-	-	-	8	-	-	74	-	70	-
54248.080.084	-	-	-	8	-	-	84	-	80	-
54248.095.026	-	-	-	9.5	-	-	26	-	22	-
54248.095.030	-	-	-	9.5	-	-	30	-	26	-
54248.100.034	-	-	-	10	-	-	34	-	30	-
54248.100.044	-	-	-	10	-	-	44	-	40	-
54248.100.054	-	-	-	10	-	-	54	-	50	-
54248.100.064	-	-	-	10	-	-	64	-	60	-
54248.100.074	-	-	-	10	-	-	74	-	70	-
54248.100.084	-	-	-	10	-	-	84	-	80	-
54248.100.094	-	-	-	10	-	-	94	-	90	-
54248.100.104	-	-	-	10	-	-	104	-	100	-
54248.110.029	-	-	-	11	-	-	29	-	25	-
54248.120.030	-	-	-	12	-	-	30	-	26	-
54248.120.045	-	-	-	12	-	-	45	-	40	-
54248.120.055	-	-	-	12	-	-	55	-	50	-
54248.120.065	-	-	-	12	-	-	65	-	60	-
54248.120.075	-	-	-	12	-	-	75	-	70	-
54248.120.085	-	-	-	12	-	-	85	-	80	-
54248.120.095	-	-	-	12	-	-	95	-	90	-
54248.120.105	-	-	-	12	-	-	105	-	100	-
54248.120.115	-	-	-	12	-	-	115	-	110	-
54248.120.125	-	-	-	12	-	-	125	-	120	-
54248.140.041	-	-	-	14	-	-	41	-	36	-
54249.044.001	49.6	7.5	4.4	-	2.4	39.0	-	-	-	-
54249.060.001	56.2	8.0	6.0	-	3.2	44.8	-	-	-	-
54249.074.001	56.5	8.4	7.4	-	3.1	44.9	-	-	-	-
54249.106.001	56.5	10.7	10.6	-	3.2	43.4	-	-	-	-
54250.060.020	-	-	-	6	-	-	20	12	-	-
54250.060.025	-	-	-	6	-	-	26	18	-	-
54250.060.031	-	-	-	6	-	-	31	23	-	-
54250.060.056	-	-	-	6	-	-	56	48	-	-
54250.060.065	-	-	-	6	-	-	65	57	-	-

Technical Data

Nr.	A	B	C	D	E	F	L	L ₁	N	ø
54250.080.028	-	-	-	8	-	-	28	20	-	-
54250.080.034	-	-	-	8	-	-	34	25	-	-
54250.080.038	-	-	-	8	-	-	38	30	-	-
54250.080.043	-	-	-	8	-	-	43	35	-	-
54250.100.035	-	-	-	10	-	-	35	25	-	-
54250.100.045	-	-	-	10	-	-	45	35	-	-
54250.100.055	-	-	-	10	-	-	55	45	-	-
54251.050.028	-	-	-	-	-	-	28	-	13	5
54251.060.035	-	-	-	-	-	-	35	-	22	6
54251.080.033	-	-	-	-	-	-	33	-	22	8
54251.080.046	-	-	-	-	-	-	46	-	36	8

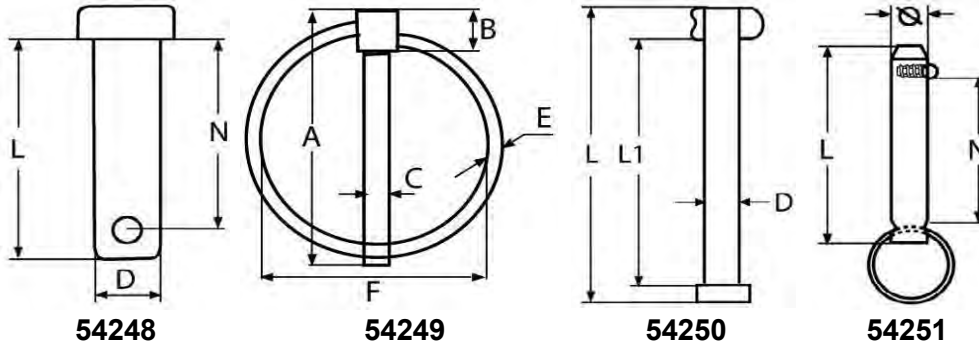

Article groups

Material	Code	Page
St.St. A4	54248	13-64
St.St. A4	54249	13-65
St.St. A2	54250	13-65
St.St. A2	54251	13-65

54248 Safety pin

MH11

Material Stainless steel A4



D x L	☒	Art.number	D x L	☒	Art.number	D x L	☒	Art.number
4X14*	20	54248.040.014	8X21*	20	54248.080.021	10X84*	1	54248.100.084
4X20*	20	54248.040.020	8X24*	20	54248.080.024	10X94*	1	54248.100.094
			8X27*	20	54248.080.027	10X104*	1	54248.100.104
5X15*	20	54248.050.015	8X32*	20	54248.080.032			
5X18*	20	54248.050.018	8X34*	2	54248.080.034	11X29*	10	54248.110.029
5X21*	20	54248.050.021	8X44*	2	54248.080.044			
			8X54*	2	54248.080.054	12X30*	10	54248.120.030
6X15*	20	54248.060.015	8X64*	2	54248.080.064	12X45*	1	54248.120.045
6X20*	20	54248.060.020	8X74*	2	54248.080.074	12X55*	1	54248.120.055
6X24*	5	54248.060.024	8X84*	2	54248.080.084	12X65*	1	54248.120.065
6X25*	20	54248.060.025				12X75*	1	54248.120.075
6X29*	20	54248.060.029	9,5X26*	10	54248.095.026	12X85*	1	54248.120.085
6X34*	5	54248.060.034	9,5X30*	1	54248.095.030	12X95*	1	54248.120.095
6X36*	20	54248.060.036				12X105*	1	54248.120.105
6X44*	5	54248.060.044	10X34*	1	54248.100.034	12X115*	1	54248.120.115
6X45*	20	54248.060.045	10X44*	1	54248.100.044	12X125*	1	54248.120.125
6X54*	5	54248.060.054	10X54*	1	54248.100.054			
6X64*	5	54248.060.064	10X64*	1	54248.100.064	14X41*	10	54248.140.041
			10X74*	1	54248.100.074			

54249 Ring catch		MH11	
Material	Stainless steel A4		
			

C	☒	Art.number	C	☒	Art.number	C	☒	Art.number
4,4MM	10	54249.044.001	7,4MM*	5	54249.074.001	10,6MM*	5	54249.106.001
6,0MM*	10	54249.060.001						

54250 Safety clevis pin		MH11	
Material	Stainless steel A2		
			

D x L	☒	Art.number	D x L	☒	Art.number	D x L	☒	Art.number
6X20*	5	54250.060.020	8X28*	2	54250.080.028	10X35*	1	54250.100.035
6X26*	5	54250.060.025	8X34*	2	54250.080.034	10X45*	1	54250.100.045
6X31*	5	54250.060.031	8X38*	2	54250.080.038	10X55*	1	54250.100.055
6X56*	5	54250.060.056	8X43*	2	54250.080.043			
6X65*	5	54250.060.065						

54251 Fast pin		MH11	
Material	Stainless steel A2		
			

ø x L	☒	Art.number	ø x L	☒	Art.number	ø x L	☒	Art.number
5X28*	10	54251.050.028	8X33*	10	54251.080.033	8X46*	10	54251.080.046
6X35*	10	54251.060.035						

Security wire



Technical Data

Nr.	B	D	D ₁	L
54252.145.001	-	8	5.4	145
54253.060.025	13	6	-	25

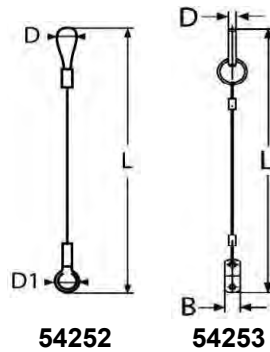

Article groups

Material	Code	Page
St.St. A2	54252	13-66
St.St. A2	54253	13-66

54252 Security wire MH11



Material: Stainless steel A2

L	Art.number
145MM*	10 54252.145.001

54253 Bolt with security wire MH11

Material: Stainless steel A2

D x L	Art.number
6X25MM*	10 54253.060.025

Spring cotter pin



Technical Data

Nr.	Drill ϕ	L	ϕ
54254.020.001	2.5	48	2.0
54254.025.001	3.0	48	2.5
54254.030.001	3.5	70	3.0
54254.040.001	4.5	76	4.0
54254.050.001	6.0	100	5.0
54254.060.001	7.0	125	6.0
54255.025.001	1.5	54	2.25
54255.032.001	3.2	61	2.8
54255.040.001	4.0	78	3.6
54255.050.001	5.0	97	4.5
54255.063.001	6.3	115	5.6
54255.070.001	7.0	146	6.3
54255.080.001	8.0	172	7.0

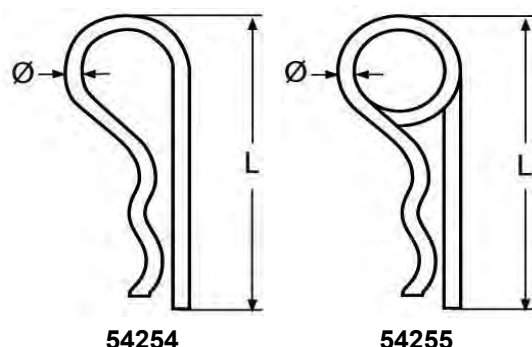

54254

54255

Article groups

Material	Code	Page
St.St. A4	54254	13-67
St.St. A4	54255	13-67

54254 Spring cotter pin, single

MH11

Material Stainless steel A4



ϕ	☒	Art.number	ϕ	☒	Art.number	ϕ	☒	Art.number
2MM	50	54254.020.001	3MM	50	54254.030.001	5MM*	20	54254.050.001
2,5MM*	50	54254.025.001	4MM	20	54254.040.001	6MM	10	54254.060.001

54255 Spring cotter pin, double

MH11

Material Stainless steel A4



ϕ	☒	Art.number	ϕ	☒	Art.number	ϕ	☒	Art.number
2,5MM*	10	54255.025.001	5,0MM*	5	54255.050.001	7,0MM*	1	54255.070.001
3,2MM*	10	54255.032.001	6,3MM*	5	54255.063.001	8,0MM*	1	54255.080.001
4,0MM*	10	54255.040.001						

Cotter pin



Technical Data

Nr.	D	ø
54256.010.010	10	1.0
54256.012.015	15	1.2
54256.015.020	20	1.5
54256.018.025	25	1.8
54257.100.001	10	1.5
54257.160.001	16	1.5

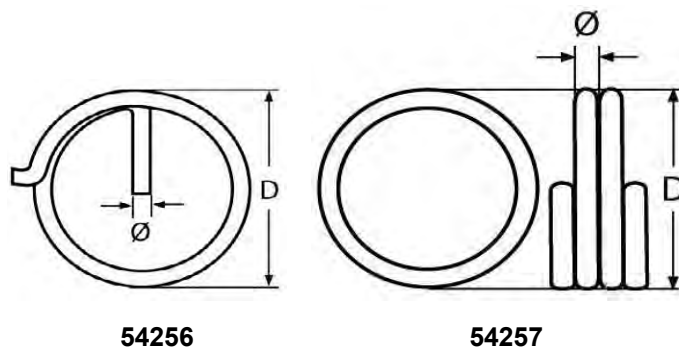

Article groups

Material	Code	Page
St.St. A4	54256	13-68
St.St. A2	54257	13-68

54256 Cotter pin MH11



Material: Stainless steel A4



ø x D	⊠	Art.number	ø x D	⊠	Art.number	ø x D	⊠	Art.number
1,0X10*	50	54256.010.010	1,5X20*	20	54256.015.020	1,8X25*	20	54256.018.025
1,2X15*	50	54256.012.015						

54257 Circle cotter pin MH11

Material: Stainless steel A2

D	⊠	Art.number	D	⊠	Art.number
10MM*	50	54257.100.001	16MM*	50	54257.160.001

ESS Universal rail turnbuckle with quick attach terminal



Technical Data

Nr.	A	L ₁	L ₂	Type	WR-ø
54300.000.005	38	143	200	square	4
54300.000.010	38	143	200	round	4

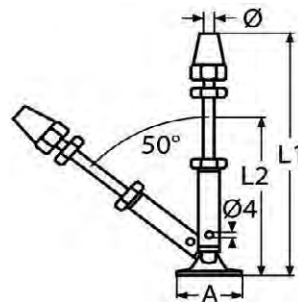

54300

54300 ESS Universal rail turnbuckle with quick attach terminal

MH11

Material Stainless steel A4



Type	☒	Art.number	Type	☒	Art.number
SQUARE*	1	54300.000.005	ROUND*	1	54300.000.010

Technical Data

Nr.	A	A ₁	A ₂	B	d	D	D ₁	D ₂	H	WR-ø	ø
54301.050.030	50	18	27	-	M5	6.3	-	-	-	-	3
54301.060.040	60	25	30	-	M6	7.5	-	-	-	-	4
54301.080.050	70	31	31	-	M8	9.0	-	-	-	-	5
54301.100.060	85	37	40	-	M10	12.5	-	-	-	-	6
54302.050.030	50	18	27	-	M5	6.3	-	-	-	-	3
54302.060.040	60	25	30	-	M6	7.5	-	-	-	-	4
54302.080.050	70	31	31	-	M8	9.0	-	-	-	-	5
54302.100.060	85	37	40	-	M10	12.5	-	-	-	-	6
54303.050.030	55	20	28	-	M5	6.3	-	-	-	-	3
54303.060.040	65	22	36	-	M6	7.5	-	-	-	-	4
54303.060.050	70	22	41	-	M8	9.0	-	-	-	-	5
54303.080.060	85	25	53	-	M10	12.5	-	-	-	-	6
54304.050.030	55	20	28	-	M5	6.3	-	-	-	-	3
54304.060.040	65	22	36	-	M6	7.5	-	-	-	-	4
54304.060.050	70	22	41	-	M6	9.0	-	-	-	-	5
54304.080.060	85	25	53	-	M8	12.5	-	-	-	-	6
54305.050.001	40	20	-	8	M5	5	-	-	10	-	-
54305.060.001	47	25	-	8	M6	6	-	-	10	-	-
54305.080.001	52	25	-	10	M8	8	-	-	12	-	-
54305.100.001	72	45	-	12	M10	10	-	-	14	-	-
54306.050.001	40	20	-	8	M5	5	-	-	10	-	-
54306.060.001	47	25	-	8	M6	6	-	-	10	-	-
54306.080.001	52	25	-	10	M8	8	-	-	12	-	-
54306.100.001	72	45	-	12	M10	10	-	-	14	-	-
54307.050.001	45	23	-	-	M5	5.5	-	-	3	-	-
54307.060.001	47	28	-	-	M6	6.5	-	-	4	-	-
54307.080.001	55	40	-	-	M8	8.5	-	-	5	-	-
54307.100.001	65	47	-	-	M10	10.5	-	-	6	-	-
54308.050.001	45	23	-	-	M5	5.5	-	-	3	-	-
54308.060.001	47	28	-	-	M6	6.5	-	-	4	-	-
54308.080.001	55	40	-	-	M8	8.5	-	-	5	-	-
54308.100.001	65	47	-	-	M10	10.5	-	-	6	-	-
54309.050.001	55	27	-	8	M5	7.5	5	-	10	-	-
54309.060.001	60	30	-	9	M6	8	6	-	10	-	-
54309.080.001	65	31	-	10	M8	12	8	-	12	-	-
54309.100.001	75	40	-	12	M10	14	10	-	12	-	-
54310.050.001	55	27	-	8	M5	7.5	5	-	10	-	-
54310.060.001	60	30	-	9	M6	8	6	-	10	-	-
54310.080.001	65	31	-	10	M8	12	8	-	12	-	-
54310.100.001	75	40	-	12	M10	14	10	-	12	-	-
54311.050.001	55	-	-	-	M5	-	-	-	-	-	-
54311.060.001	65	-	-	-	M6	-	-	-	-	-	-
54311.080.001	70	-	-	-	M8	-	-	-	-	-	-
54311.100.001	85	-	-	-	M10	-	-	-	-	-	-
54312.000.005	80	45	30	-	M6 L	12	-	-	-	3+4	-
54312.100.005	80	45	30	-	M6 R	12	-	-	-	3+4	-
54313.050.001	65	30	30	-	M5	-	-	-	-	-	-
54313.060.001	65	30	30	-	M6	-	-	-	-	-	-
54313.080.001	65	30	30	-	M8	-	-	-	-	-	-
54313.100.001	85	40	40	-	M10	-	-	-	-	-	-
54313.120.001	105	50	50	-	M12	-	-	-	-	-	-
54314.030.001	40	18	-	-	-	6.3	-	6.5	5	-	3
54314.040.001	52	24	-	-	-	7.5	-	8.5	6	-	4
54314.050.001	62	30	-	-	-	9.0	-	9.5	7	-	5
54314.060.001	75	36	-	-	-	12.5	-	13	8	-	6
54315.030.001	55	-	-	8	-	6.3	5	-	10	-	3
54315.040.001	65	-	-	8	-	7.5	6	-	10	-	4

Technical Data

Nr.	A	A ₁	A ₂	B	d	D	D ₁	D ₂	H	WR-ø	ø
54315.050.001	70	-	-	10	-	8.9	6	-	12	-	5
54315.060.001	85	-	-	12	-	12.4	10	-	14	-	6

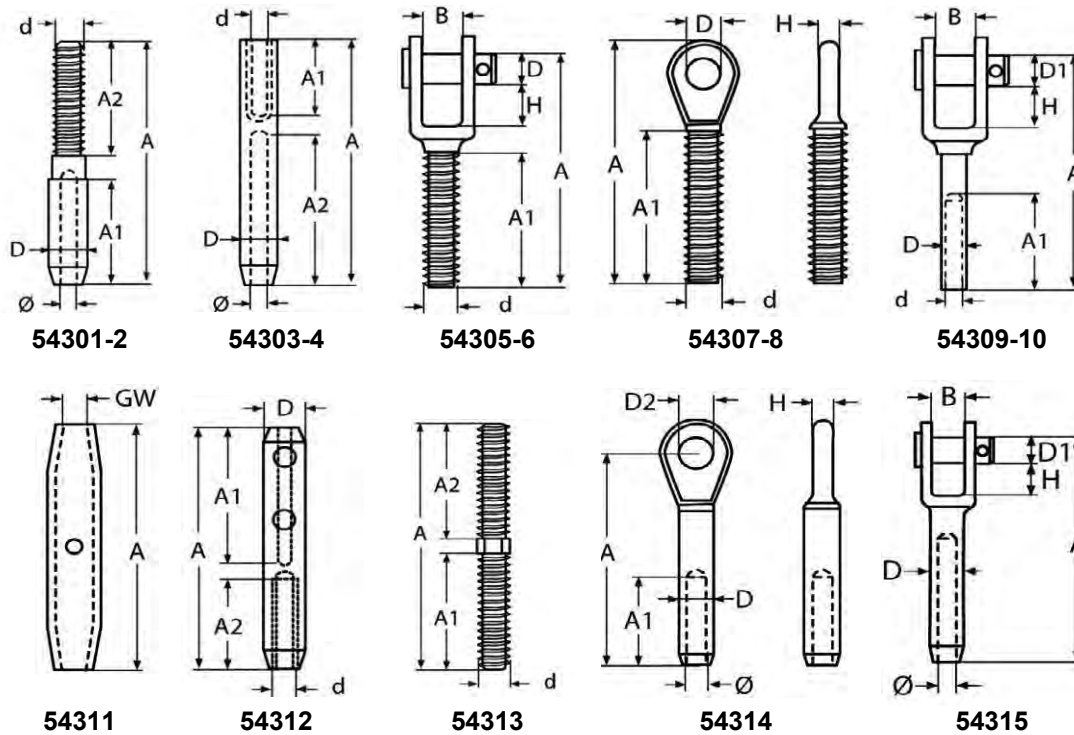

Article groups



Material	Code	Page
St.St. A4	54301	13-71
St.St. A4	54302	13-72
St.St. A4	54303	13-72
St.St. A4	54304	13-72
St.St. A4	54305	13-72
St.St. A4	54306	13-72
St.St. A4	54307	13-72
St.St. A4	54308	13-73
St.St. A4	54309	13-73
St.St. A4	54310	13-73
St.St. A4	54311	13-73
St.St. A4	54312	13-73
St.St. A4	54313	13-73
St.St. A4	54314	13-74
St.St. A4	54315	13-74

54301	ESS Swage stud right thread	MH11
Material	Stainless steel A4	
		

d / WR-ø	☒	Art.number	d / WR-ø	☒	Art.number	d / WR-ø	☒	Art.number
M5/3MM*	10	54301.050.030	M8/5MM*	5	54301.080.050	M10/6MM*	5	54301.100.060
M6/4MM*	10	54301.060.040						

54302 ESS Swage stud left thread MH11

Material Stainless steel A4

d / WR-ø	☒	Art.number	d / WR-ø	☒	Art.number	d / WR-ø	☒	Art.number
M5/3MM*	10	54302.050.030	M8/5MM*	5	54302.080.050	M10/6MM*	5	54302.100.060
M6/4MM*	10	54302.060.040						

54303 ESS Swage stud with internal right thread MH11

Material Stainless steel A4



d / WR-ø	☒	Art.number	d / WR-ø	☒	Art.number	d / WR-ø	☒	Art.number
M5/3MM RI*	10	54303.050.030	M6/5MM RI*	5	54303.060.050	M8/6MM RI*	5	54303.080.060
M6/4MM RI*	10	54303.060.040						

54304 ESS Swage stud with internal left thread MH11



Material Stainless steel A4



d / WR-ø	☒	Art.number	d / WR-ø	☒	Art.number	d / WR-ø	☒	Art.number
M5/3MM LE*	10	54304.050.030	M6/5MM LE*	5	54304.060.050	M8/6MM LE*	5	54304.080.060
M6/4MM LE*	10	54304.060.040						

54305 ESS Threaded jaw right thread MH11

Material Stainless steel A4

d	☒	Art.number	d	☒	Art.number	d	☒	Art.number
M5*	10	54305.050.001	M8*	5	54305.080.001	M10*	5	54305.100.001
M6*	10	54305.060.001						

54306 ESS Threaded jaw left thread MH11



Material Stainless steel A4



d	☒	Art.number	d	☒	Art.number	d	☒	Art.number
M5*	10	54306.050.001	M8*	5	54306.080.001	M10*	5	54306.100.001
M6*	1	54306.060.001						

54307 ESS Threaded eye right thread MH11

Material Stainless steel A4

d	☒	Art.number	d	☒	Art.number	d	☒	Art.number
M5*	10	54307.050.001	M8*	5	54307.080.001	M10*	5	54307.100.001
M6*	10	54307.060.001						

54308 ESS Threaded eye left thread MH11

Material Stainless steel A4



d	☒	Art.number	d	☒	Art.number	d	☒	Art.number
M5*	10	54308.050.001	M8*	5	54308.080.001	M10*	5	54308.100.001
M6*	10	54308.060.001						

54309 ESS Jaw with internal right thread MH11

Material Stainless steel A4



d	☒	Art.number	d	☒	Art.number	d	☒	Art.number
M5*	10	54309.050.001	M8*	5	54309.080.001	M10*	5	54309.100.001
M6*	10	54309.060.001						

54310 ESS Jaw with internal left thread MH11

Material Stainless steel A4



d	☒	Art.number	d	☒	Art.number	d	☒	Art.number
M5*	10	54310.050.001	M8*	5	54310.080.001	M10*	5	54310.100.001
M6*	10	54310.060.001						

54311 ESS Body of turnbuckle MH11

Material Stainless steel A4



d	☒	Art.number	d	☒	Art.number	d	☒	Art.number
M5*	10	54311.050.001	M8*	5	54311.080.001	M10*	5	54311.100.001
M6*	10	54311.060.001						

54312 ESS Screw terminal for self-assembly MH11

Material Stainless steel A4





d / WR-ø	☒	Art.number	d / WR-ø	☒	Art.number
M6/3+4MM LE*	5	54312.000.005	M6/3+4MM RI*	5	54312.100.005



54313 ESS Stud bolt right and left thread MH11

Material Stainless steel A4



d	☒	Art.number	d	☒	Art.number	d	☒	Art.number
M5*	10	54313.050.001	M8*	5	54313.080.001	M12*	5	54313.120.001
M6*	10	54313.060.001	M10*	5	54313.100.001			

54314		ESS Eye terminal				MH11		
Material		Stainless steel A4						
								
								
WR-ø	✉	Art.number	WR-ø	✉	Art.number	WR-ø	✉	Art.number
3MM*	10	54314.030.001	5MM*	5	54314.050.001	6MM*	5	54314.060.001
4MM*	10	54314.040.001						

54315		ESS Fork terminal				MH11		
Material		Stainless steel A4						
								
								
WR-ø	✉	Art.number	WR-ø	✉	Art.number	WR-ø	✉	Art.number
3MM*	10	54315.030.001	5MM*	5	54315.050.001	6MM*	5	54315.060.001
4MM*	10	54315.040.001						

ESS Terminal with head



Technical Data									
Nr.	A	A ₁	A ₂	d	D	D ₁	D ₂	ø	
54316.030.001	34	27	2	-	8	6.3	-	3	
54316.040.001	43	35	2	-	9.5	7.5	-	4	
54316.050.001	50	40	3	-	13	9	-	5	
54316.060.001	64	50	3	-	16.5	12.5	-	6	
54317.030.001	25	18	2	-	9	5.5	3.3	3	
54317.040.001	30	24	2	-	11	6.5	4.3	4	
54317.050.001	35	28	2.5	-	13	7.5	5.3	5	
54317.060.001	40	32	3	-	16	9	6.3	6	
54318.050.001	25	18	4	M5	12	7.5	-	-	
54318.060.001	30	24	4	M6	12	8	-	-	
54318.080.001	35	28	5	M8	16	12	-	-	
54318.100.001	40	32	6	M10	20	14	-	-	

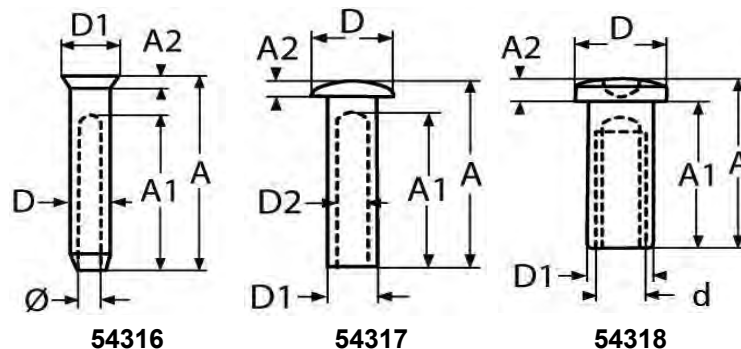

Article groups		
Material	Code	Page
St.St. A4	54316	13-75
St.St. A4	54317	13-75
St.St. A4	54318	13-75

54316	ESS Cone terminal	MH11
Material	Stainless steel A4	

WR-ø	☒	Art.number	WR-ø	☒	Art.number	WR-ø	☒	Art.number
3MM*	10	54316.030.001	5MM*	5	54316.050.001	6MM*	5	54316.060.001
4MM*	10	54316.040.001						

54317	ESS Dome head terminal	MH11
Material	Stainless steel A4	

WR-ø	☒	Art.number	WR-ø	☒	Art.number	WR-ø	☒	Art.number
3MM*	10	54317.030.001	5MM*	5	54317.050.001	6MM*	5	54317.060.001
4MM*	10	54317.040.001						

54318	ESS Dome case nut with internal thread and hexagon socket right thread	MH11
Material	Stainless steel A4	

d	☒	Art.number	d	☒	Art.number	d	☒	Art.number
M5*	10	54318.050.001	M8*	5	54318.080.001	M10*	5	54318.100.001
M6*	10	54318.060.001						

ESS Dowel screw

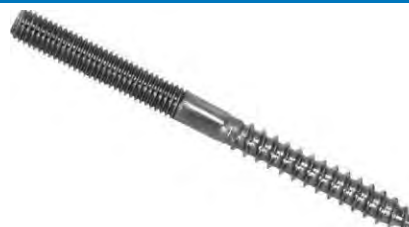

Technical Data

Nr.	d	L	L ₁	L ₂
54319.050.001	M5	80	43	32
54319.060.001	M6	90	50	35
54319.080.001	M8	130	65	55
54319.100.001	M10	150	75	55
54320.050.001	M5	80	43	32
54320.060.001	M6	90	50	35
54320.080.001	M8	130	65	55
54320.100.001	M10	150	75	55

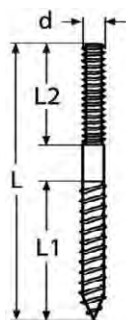

54319-20

Article groups

Material	Code	Page
St.St. A4	54319	13-76
St.St. A4	54320	13-76

54319 ESS Dowel screw with right thread MH11

Material: Stainless steel A4



d	☒	Art.number	d	☒	Art.number	d	☒	Art.number
M5*	5	54319.050.001	M8*	5	54319.080.001	M10*	5	54319.100.001
M6*	5	54319.060.001						

54320 ESS Dowel screw with left thread MH11

Material: Stainless steel A4





d	☒	Art.number	d	☒	Art.number	d	☒	Art.number
M5*	5	54320.050.001	M8*	5	54320.080.001	M10*	5	54320.100.001
M6*	5	54320.060.001						

ESS Nut for turnbuckle



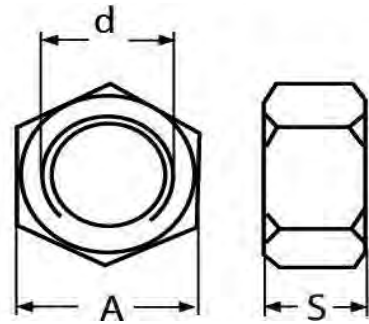

Technical Data

Nr.	A	d	S	Type
54321.050.001	7.9	M5	3.8	R5
54321.050.002	7.9	M5	3.8	L5
54321.060.001	9.8	M6	4.8	R6
54321.060.002	9.8	M6	4.8	L6
54321.080.001	10.0	M8	5.0	R8
54321.080.002	10.0	M8	5.0	L8
54321.100.001	12.7	M10	6.2	R10
54321.100.002	12.7	M10	6.2	L10
54321.120.001	17.0	M12	8.0	R12
54321.120.002	17.0	M12	8.0	L12
54321.140.001	22.0	M14	11.0	R14
54321.140.002	22.0	M14	11.0	L14
54321.160.001	24.0	M16	13.0	R16
54321.160.002	24.0	M16	13.0	L16
54321.200.001	26.5	M20	14.5	R20
54321.200.002	26.5	M20	14.5	L20



54321

54321	ESS Nut for turnbuckle	MH11
Material	Stainless steel A4	
		

Type	☒	Art.number	Type	☒	Art.number	Type	☒	Art.number
M5 LE*	10	54321.050.001	M10 LE*	10	54321.100.001	M16 LE*	5	54321.160.001
M5 RI*	10	54321.050.002	M10 RI*	10	54321.100.002	M16 RI*	5	54321.160.002
M6 LE*	10	54321.060.001	M12 LE*	10	54321.120.001	M20 LE*	5	54321.200.001
M6 RI*	10	54321.060.002	M12 RI*	10	54321.120.002	M20 RI*	5	54321.200.002
M8 LE*	10	54321.080.001	M14 LE*	5	54321.140.001			
M8 RI*	10	54321.080.002	M14 RI*	5	54321.140.002			

ESS Cross wire rope clip



Technical Data						
Nr.	A	A ₁	A ₂	d	D	WR-ø
54322.030.001	19	11	14	M12	20	3
54322.040.001	21	13	16	M12	20	4
54322.050.001	23	13	18	M12	20	5
54322.060.001	25	15	20	M12	20	6

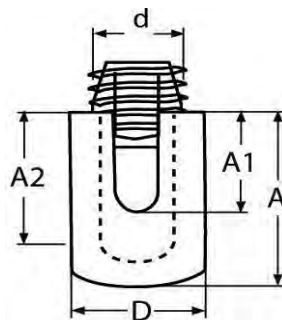

54322

54322	ESS Cross wire rope clip	MH11
Material	Stainless steel A4	
		

WR-ø	☒	Art.number	WR-ø	☒	Art.number	WR-ø	☒	Art.number
3MM*	10	54322.030.001	5MM*	5	54322.050.001	6MM*	5	54322.060.001
4MM*	10	54322.040.001						

ESS Solid ball



Technical Data			
Nr.	A	d	D
54323.015.001	6	M6	15
54323.020.001	17	M6	20
54323.025.001	17	M6	25
54323.030.001	18	M6	30
54323.040.001	24	M8	40
54323.050.001	24	M8	50
54324.015.001	6	M6	15
54324.020.001	17	M6	20
54324.025.001	17	M6	25
54324.030.001	18	M6	30
54324.040.001	24	M8	40
54324.050.001	24	M8	50

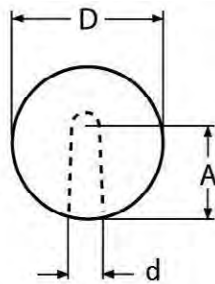

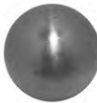

54323-24

Article groups		
Material	Code	Page
St.St. A2	54323	13-78
St.St. A2	54324	13-79

54323	ESS Solid ball with internal thread blank	MH11
Material	Stainless steel A2	
		

D	☒	Art.number	D	☒	Art.number	D	☒	Art.number
15MM Blank*	10	54323.015.001	25MM Blank*	10	54323.025.001	40MM Blank*	5	54323.040.001
20MM Blank*	10	54323.020.001	30MM Blank*	10	54323.030.001	50MM Blank*	5	54323.050.001

54324	ESS Solid ball with internal thread polished	MH11
Material	Stainless steel A2	
		

D	☒	Art.number	D	☒	Art.number	D	☒	Art.number
15MM POLISHED*	10	54324.015.001	25MM POLISHED*	10	54324.025.001	40MM POLISHED*	5	54324.040.001
20MM POLISHED*	10	54324.020.001	30MM POLISHED*	10	54324.030.001	50MM POLISHED*	5	54324.050.001

ESS Combination wall bracket



Technical Data	
Nr.	Type
54325.000.005	A
54325.100.005	B

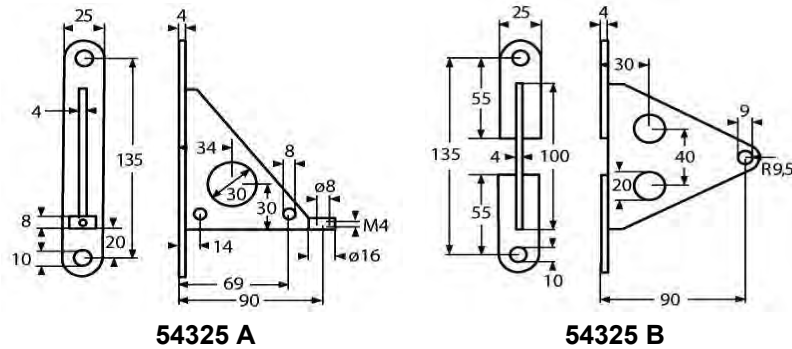

54325	ESS Combination wall bracket	MH11
Material	Stainless steel A4	
		

Type	☒	Art.number
TYPE A 135X90	1	54325.000.005
TYPE B 135X90	1	54325.100.005



ESS Ground plate for wall bracket



Technical Data

Nr.	D	D ₁	S
54326.058.001	58	14	6

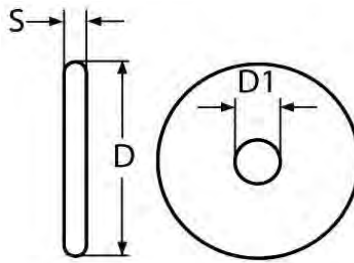

54326

54326	ESS Ground plate for wall bracket	MH11
Material	Stainless steel A2	
		

D	Art.number
58MM*	10 54326.058.001

Hinge



Technical Data

Nr.	B	D	L	L ₁	S	S ₁	Type
54500.076.001	38	-	76	-	4	-	-
54500.100.001	38	-	100	-	4	-	-
54502.100.025	25	-	100	-	4	-	-
54503.160.027	27	-	160	-	4	-	-
54514.180.040	40	5	180	-	2	9	A
54514.180.041	40	5	180	-	2	9	B
54515.160.028	28	4.5	160	80	3	8	-
54517.105.028	28	4.5	105	53	3	8	-
54531.145.038	38	5.5	145	72.5	2	9	-
54532.100.028	28	5.5	100	50	2	9	-
54533.075.038	38	5.5	75	37.5	2	9	-
54533.097.038	38	5.5	97	48.5	2	9	-
54539.102.027	27	3.8	102	51	2	-	-

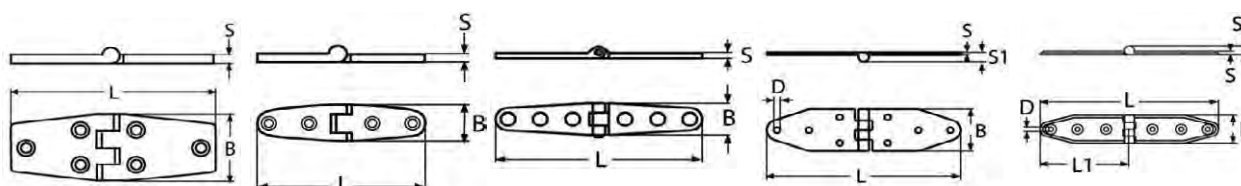

54500

54502

54503

54514

54515

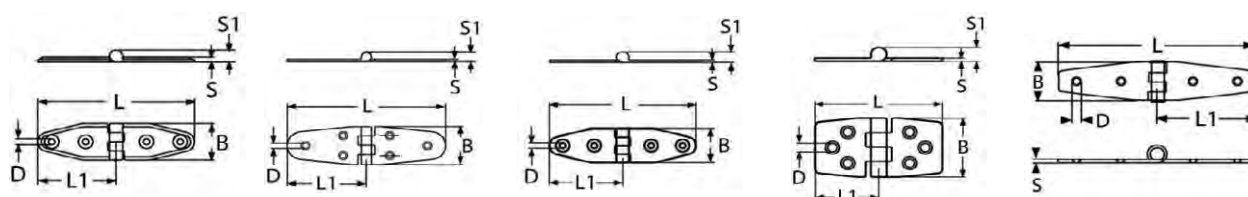

54517

54531

54532

54533

54539

Article groups

Material	Code	Page
St.St. A4	54500	13-82
St.St. A4	54502	13-82
St.St. A4	54503	13-82
St.St. A2	54514	13-82
St.St. A2	54515	13-82
St.St. A2	54517	13-82
St.St. A2	54531	13-83
St.St. A2	54532	13-83
St.St. A2	54533	13-83
St.St. A2	54539	13-83

54500	Hinge	MH11
Material	Stainless steel A4	
		 



L	☒	Art.number	L	☒	Art.number
76MM	5	54500.076.001	100MM*	5	54500.100.001

54502	Hinge	MH11
Material	Stainless steel A4	
		 

L x B	☒	Art.number
100X25*	5	54502.100.025

54503	Hinge	MH11
Material	Stainless steel A4	
		 



L x B	☒	Art.number
160X27*	5	54503.160.027

54514	Hinge type A+B	MH11
Material	Stainless steel A2	
		 



L x B	☒	Art.number	L x B	☒	Art.number
TYPE A 180X40*	5	54514.180.040	TYPE B 180X40*	5	54514.180.041

54515	Hinge	MH11
Material	Stainless steel A2	
		 



L x B	☒	Art.number
160X28*	5	54515.160.028

54517	Hinge	MH11
Material	Stainless steel A2	
		 



L x B	☒	Art.number
105X28*	5	54517.105.028

54531	Hinge	MH11
Material	Stainless steel A2	
		

L x B		Art.number
145X38*	5	54531.145.038

54532	Hinge	MH11
Material	Stainless steel A2	
		

L x B		Art.number
100X28*	5	54532.100.028

54533	Hinge	MH11
Material	Stainless steel A2	
		

L x B		Art.number	L x B		Art.number
75X38*	5	54533.075.038	97X38*	5	54533.097.038

54539	Hinge	MH11
Material	Stainless steel A2	
		

L x B		Art.number
102X27*	5	54539.102.027

Hinge



Technical Data

Nr.	B	D	L	L ₁	S	S ₁	Type
54501.056.038	38	-	56	-	4	-	-
54501.076.038	38	-	76	-	4	-	-
54513.129.040	40	5	129	38	2	9	A
54513.129.041	40	5	129	38	2	9	B
54516.133.028	28	4.5	133	80	3	8	-
54527.058.038	38	5.5	58	40	2	9	-
54527.068.038	38	5.5	68	49	2	9	-
54528.087.038	38	5.5	87	38	2	9	-
54528.097.038	38	5.5	97	40	2	9	-
54530.110.038	38	5.5	110	38	2	9	-
54537.100.054	54	-	100	60	4	-	-
54537.100.075	75	-	152	100	4	-	-
54537.197.098	98	-	197	140	4	-	-
54540.135.027	27	3.8	135	50	2	-	-
54544.180.038	38	-	180	60	2	-	-
54545.070.038	38	-	70	35	2	-	-

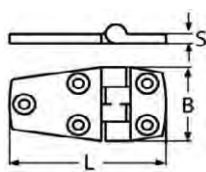

54501

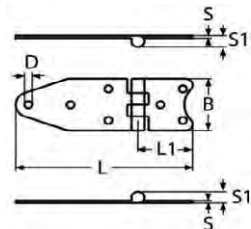

54513

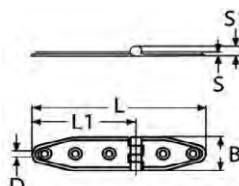

54516

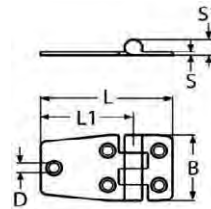

54527

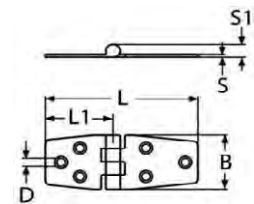

54528

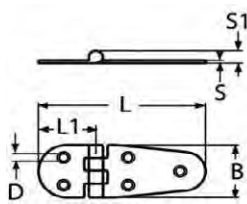

54530

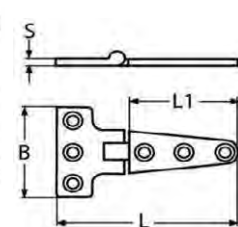

54537

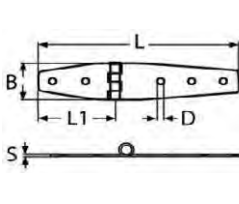

54540

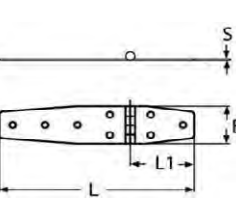

54544

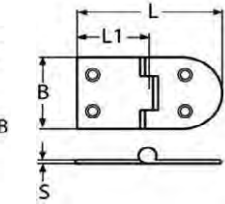

54545

Article groups



Material	Code	Page
St.St. A4	54501	13-85
St.St. A2	54513	13-85
St.St. A2	54516	13-85
St.St. A2	54527	13-85
St.St. A2	54528	13-85
St.St. A2	54530	13-85
St.St. A4	54537	13-86
St.St. A2	54540	13-86
St.St. A2	54544	13-86

Article groups

Material	Code	Page
St.St. A2	54545	13-86

54501	Hinge	MH11
Material	Stainless steel A4	
		

L x B	☒	Art.number	L x B	☒	Art.number
56X38*	5	54501.056.038	76X38	1	54501.076.038

54513	Hinge type A+B	MH11
Material	Stainless steel A2	
		

L x B	☒	Art.number	L x B	☒	Art.number
TYPE A 129X40*	5	54513.129.040	TYPE B 129X40*	5	54513.129.041

54516	Hinge	MH11
Material	Stainless steel A2	
		

L x B	☒	Art.number
133X28*	5	54516.133.028

54527	Hinge	MH11
Material	Stainless steel A2	
		

L x B	☒	Art.number	L x B	☒	Art.number
58X38*	5	54527.058.038	68X38	5	54527.068.038

54528	Hinge	MH11
Material	Stainless steel A2	
		



L x B	☒	Art.number	L x B	☒	Art.number
87X38*	5	54528.087.038	97X38*	5	54528.097.038

54530	Hinge	MH11
Material	Stainless steel A2	
		



L x B	☒	Art.number
110X38*	5	54530.110.038

54537	T-strap hinge	MH11
Material	Stainless steel A4	 

L x B	⊗	Art.number	L x B	⊗	Art.number	L x B	⊗	Art.number
100X54*	1	54537.100.054	152X75*	1	54537.100.075	197X98*	1	54537.197.098

54540	Hinge	MH11
Material	Stainless steel A2	 

L x B	⊗	Art.number
135X27*	5	54540.135.027

54544	Hinge	MH11
Material	Stainless steel A2	 

L x B	⊗	Art.number
180X38*	5	54544.180.038

54545	Hinge	MH11
Material	Stainless steel A2	 

L x B	⊗	Art.number
70X38*	5	54545.070.038

Hinge



Technical Data

Nr.	B	H	L	L ₁	S
54504.056.038	38	9.5	56	-	4
54504.070.038	38	9.5	76	-	4
54523.152.001	76	-	152	22	3
54526.100.001	87	-	100	33	3
54547.653.821	38	21	65	45	2
54547.653.835	38	35	76	45	2
54548.035.038	38	20	35	15	2

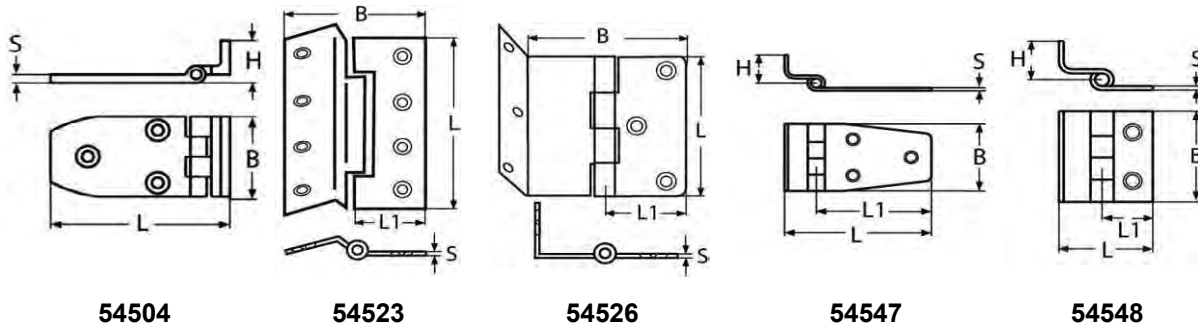

Article groups

Material	Code	Page
St.St. A4	54504	13-87
St.St. A2	54523	13-87
St.St. A4	54526	13-88
St.St. A2	54547	13-88
St.St. A2	54548	13-88

54504 Hinge MH11

Material Stainless steel A4



L x B	Art.number	L x B	Art.number
56X38*	5 54504.056.038	70X38*	5 54504.070.038

54523 Hinge MH11

Material Stainless steel A2



L	Art.number
152MM*	1 54523.152.001

54526	Hinge	MH11
Material	Stainless steel A4	 

L	<input type="checkbox"/>	Art.number
100MM*	1	54526.100.001

54547	Hinge	MH11
Material	Stainless steel A2	 

L x B x H	<input type="checkbox"/>	Art.number	L x B x H	<input type="checkbox"/>	Art.number
65X38X21*	5	54547.653.821	65X38X35*	5	54547.653.835

54548	Hinge	MH11
Material	Stainless steel A2	 

L x B	<input type="checkbox"/>	Art.number
35X38*	5	54548.035.038

Hinge



Technical Data						
Nr.	B	D	L	L ₁	S	S ₁
54505.038.038	38	-	38	-	4	-
54505.050.050	50	-	50	-	4	-
54506.090.038	38	-	90	-	3	-
54508.075.075	75	10	75	-	2	-
54509.100.075	75	11	100	-	2.5	-
54518.038.038	38	5.5	38	19	2	9
54518.068.038	38	5.5	68	34	2	9
54520.049.001	37	-	49	24.5	2	-
54521.050.001	50	-	50	25	2	-
54524.075.001	70	-	75	35	3	-
54525.100.001	71	-	152	35.5	3.5	-
54529.075.038	38	5.5	75	37.5	2	9
54534.050.035	35	3.3	50	-	1.7	8
54534.062.040	40	3.3	62	-	1.7	8
54534.075.048	48	5.5	75	-	1.7	8
54534.100.054	54	6.6	100	-	1.7	8

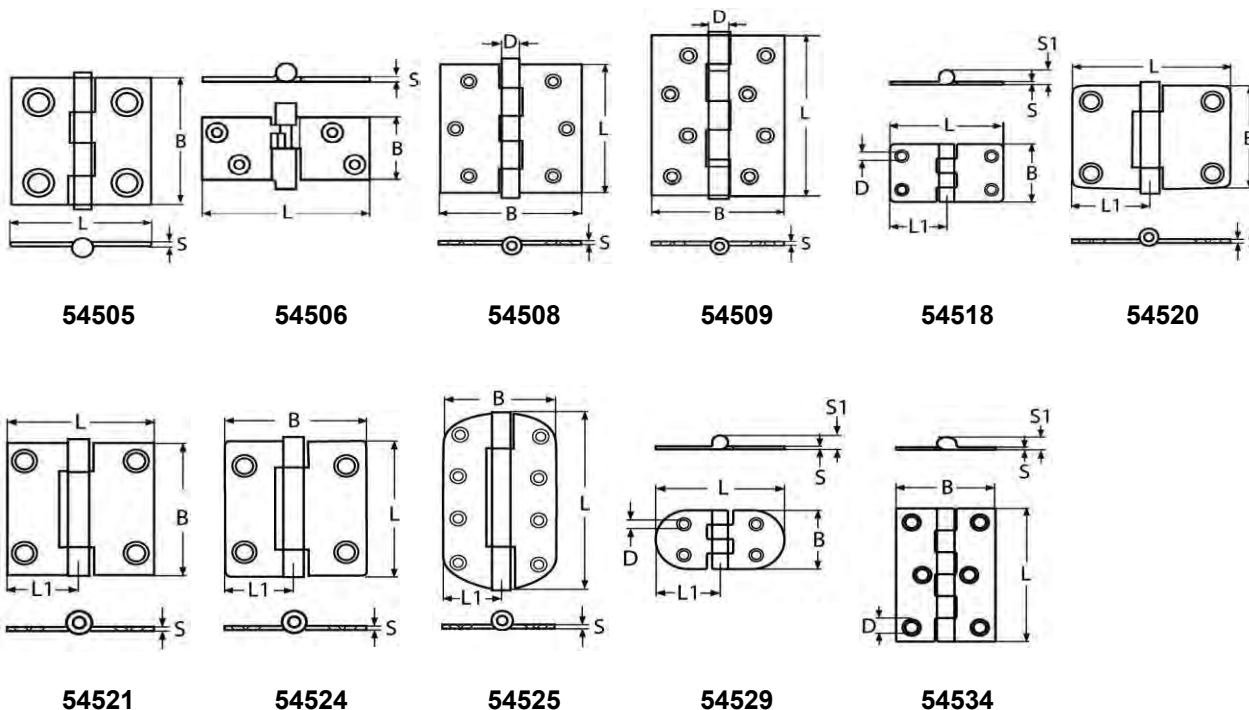



Article groups

Material	Code	Page
St.St. A4	54505	13-89
St.St. A4	54506	13-89
St.St. A2	54508	13-90
St.St. A2	54509	13-90
St.St. A2	54518	13-90
St.St. A2	54520	13-90
St.St. A2	54521	13-90
St.St. A4	54524	13-90
St.St. A4	54525	13-91
St.St. A2	54529	13-91
St.St. A2	54534	13-91

54505 Hinge MH11

Material Stainless steel A4



L x B	Art.number	L x B	Art.number
38X38	5 54505.038.038	50X50	5 54505.050.050

54506 Take-apart motor box hinge MH11



Material Stainless steel A4



L x B	Art.number
90X38*	5 54506.090.038

54508	Hinge heavy duty	MH11
Material	Stainless steel A2	
		

L x B	<input type="checkbox"/>	Art.number
75X75	5	54508.075.075

54509	Hinge heavy duty, long	MH11
Material	Stainless steel A2	
		

L x B	<input type="checkbox"/>	Art.number
100X75*	5	54509.100.075

54518	Hinge	MH11
Material	Stainless steel A2	
		

L x B	<input type="checkbox"/>	Art.number	L x B	<input type="checkbox"/>	Art.number
38X38*	5	54518.038.038	68X38*	5	54518.068.038

54520	Hinge	MH11
Material	Stainless steel A2	
		

L	<input type="checkbox"/>	Art.number
49MM*	5	54520.049.001

54521	Hinge	MH11
Material	Stainless steel A2	
		



L	<input type="checkbox"/>	Art.number
50MM*	5	54521.050.001

54524	Hinge	MH11
Material	Stainless steel A4	
		

L	<input type="checkbox"/>	Art.number
75MM*	2	54524.075.001

54525	Hinge	MH11
Material	Stainless steel A4	
		 

L	<input type="checkbox"/>	Art.number
152MM*	2	54525.100.001

54529	Hinge	MH11
Material	Stainless steel A2	
		 

L x B	<input type="checkbox"/>	Art.number
75X38*	5	54529.075.038

54534	Hinge	MH11
Material	Stainless steel A2	
		 

L x B	<input type="checkbox"/>	Art.number	L x B	<input type="checkbox"/>	Art.number	L x B	<input type="checkbox"/>	Art.number
50X35	5	54534.050.035	75X48*	5	54534.075.048	100X54*	5	54534.100.054
62X40*	5	54534.062.040						

Hinge



Technical Data			
Nr.	B	L	S
54507.074.065	65	74	6

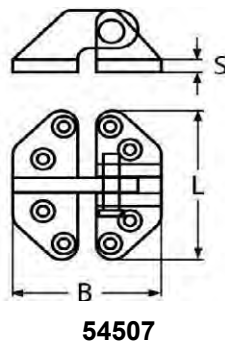

54507	Hinge	MH11
Material	Stainless steel A4	
		

L x B	<input type="checkbox"/>	Art.number
74X65*	2	54507.074.065



Hinge

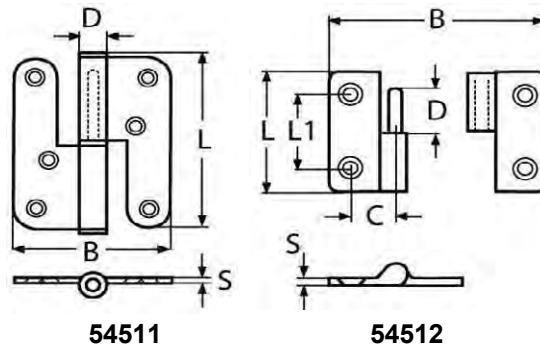

Technical Data							
Nr.	B	C	D	L	L ₁	S	Type
54511.100.080	80	-	14	100	-	3	L
54511.100.081	80	-	14	100	-	3	R
54512.037.037	37	12.5	13.5	37	23	2.6	R
54512.137.137	37	12.5	13.5	37	23	2.6	L



Article groups		
Material	Code	Page
St.St. A2	54511	13-92
St.St. A4	54512	13-93

54511	Two-part door hinge right or left	MH11
Material	Stainless steel A2	
		

L x B	<input type="checkbox"/>	Art.number	L x B	<input type="checkbox"/>	Art.number
100X80 Left*	2	54511.100.080	100X80 Right*	1	54511.100.081

54512	Two-part hinge right or left	MH11
Material	Stainless steel A4	
		

L x B	✉	Art.number	L x B	✉	Art.number
37X37 Left*	5	54512.037.037	37X37 Right*	5	54512.137.137

Hinge



Technical Data

Nr.	B	D	L	L ₁	S	S ₁
54519.071.001	40	-	71	35.5	2	-
54522.050.001	50	-	50	25	2	-
54538.066.030	30	-	66	33	2	-
54573.070.042	42	6	70	35	2.2	7.5
54574.052.042	42	6	52	26	2.2	7.5

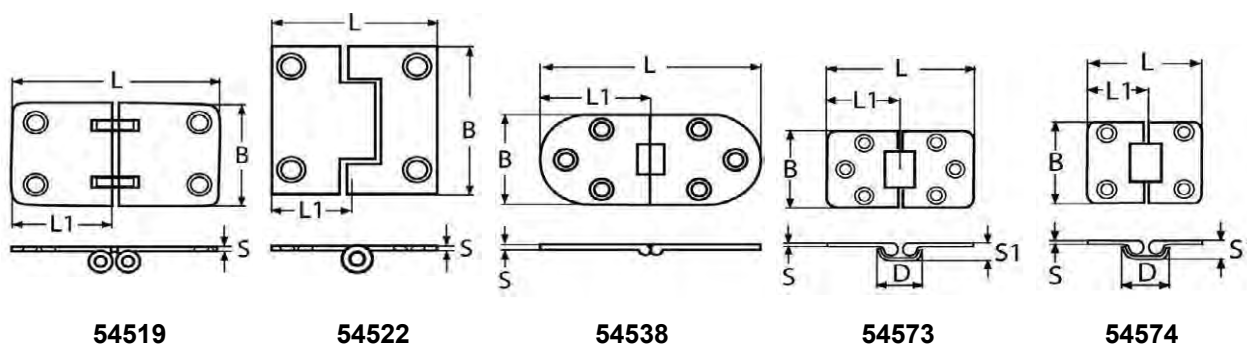

Article groups

Material	Code	Page
St.St. A2	54519	13-93
St.St. A2	54522	13-94
St.St. A4	54538	13-94
St.St. A4	54573	13-94
St.St. A4	54574	13-94

54519	Hinge	MH11
Material	Stainless steel A2	
		



L	✉	Art.number
71MM*	5	54519.071.001

54522	Hinge	MH11
Material	Stainless steel A2	 

L	⊗	Art.number
50MM*	5	54522.050.001

54538	Hinge	MH11
Material	Stainless steel A4	 

L x B	⊗	Art.number
66X30*	5	54538.066.030

54573	Hinge	MH11
Material	Stainless steel A4	 

L x B	⊗	Art.number
70x42*	5	54573.070.042

54574	Hinge	MH11
Material	Stainless steel A4	 

L x B	⊗	Art.number
52X42*	5	54574.052.042

Hinge



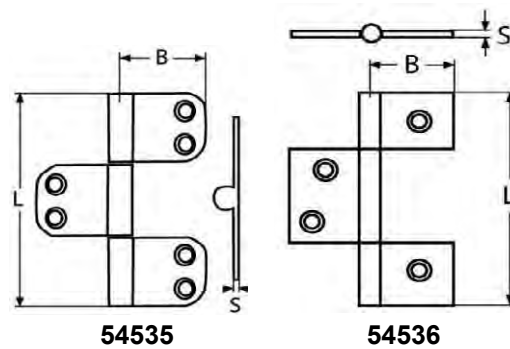

Technical Data

Nr.	B	L	S
54535.098.037	37	98	1.5
54536.085.001	30	85	1.5



Article groups

Material	Code	Page
St.St. A4	54535	13-95
St.St. A2	54536	13-95

54535	Hinge	MH11
Material	Stainless steel A4	
		

L x B	Art.number
98X37*	1 54535.098.037

54536	Weld-on hinge	MH11
Material	Stainless steel A2	
		

L	Art.number
85MM*	5 54536.085.001

Hinge



Technical Data

Nr.	B	L	L ₁	S
54541.075.056	78	56	28	2
54542.067.048	48	67	36.5	2
54543.051.035	35	51	25.5	2

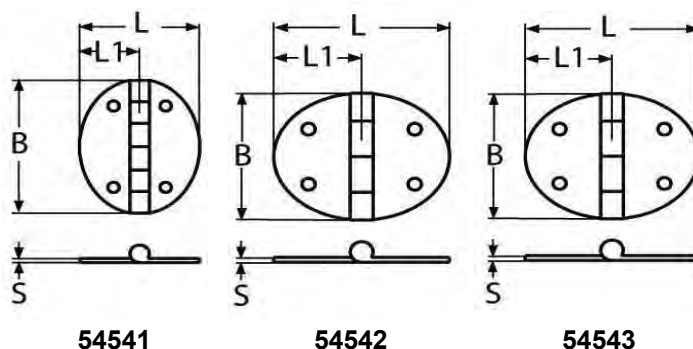

Article groups

Material	Code	Page
St.St. A2	54541	13-96
St.St. A2	54542	13-96
St.St. A2	54543	13-96

54541	Hinge	MH11
Material	Stainless steel A2	

B x L	✉	Art.number	
78X56*	5	54541.075.056	

54542	Hinge	MH11
Material	Stainless steel A2	

L x B	✉	Art.number	
67X48*	5	54542.067.048	

54543	Hinge	MH11
Material	Stainless steel A2	

L x B	Art.number
51X35*	5 54543.051.035

Hinge



Technical Data					
Nr.	B	H	L	L ₁	S
54546.127.047	47	41	127	98	2.5

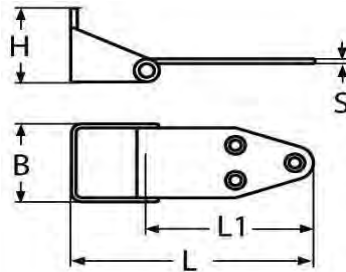

54546

54546	Hinge	MH11
Material	Stainless steel A2	 

L x B	Art.number
127X47*	2 54546.127.047

Hinge, cast



Technical Data

Nr.	B	L	L ₁	S
54549.076.040	40	76	30	4
54551.134.065	65	134	21	4
54553.146.065	65	146	51	4
54555.190.065	65	190	95	4
54557.086.065	65	83	32	4
54559.072.065	65	72	21	4
54561.103.065	65	103	21	4
54563.052.061	61	52	19	4
54565.080.065	65	80	33	4
54567.070.040	40	70	30	3.5
54569.126.040	40	126	40	3.5
54571.127.065	65	127	32	4

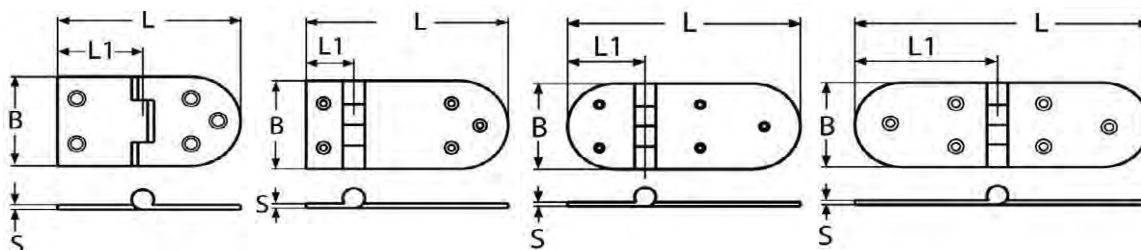

54549

54551

54553-69

54555

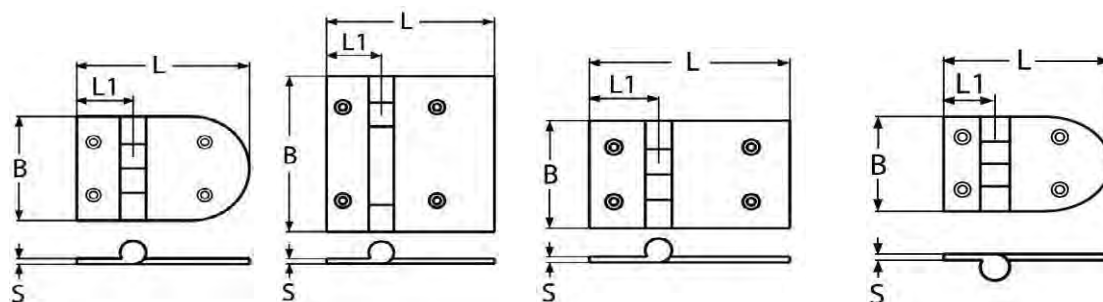

54557-59-61-71

54563

54565

54567

Article groups

Material	Code	Page
St.St. A4	54549	13-99
St.St. A4	54551	13-99
St.St. A4	54553	13-99
St.St. A4	54555	13-99
St.St. A4	54557	13-99
St.St. A4	54559	13-99
St.St. A4	54561	13-100
St.St. A4	54563	13-100
St.St. A4	54565	13-100
St.St. A4	54567	13-100
St.St. A4	54569	13-100
St.St. A4	54571	13-100

54549	Hinge, cast	MH11
Material	Stainless steel A4	 

L x B	<input type="checkbox"/>	Art.number
76X40*	2	54549.076.040

54551	Hinge, cast	MH11
Material	Stainless steel A4	 

L x B	<input type="checkbox"/>	Art.number
134X65*	2	54551.134.065

54553	Hinge, cast	MH11
Material	Stainless steel A4	 

L x B	<input type="checkbox"/>	Art.number
146X65*	2	54553.146.065

54555	Hinge, cast	MH11
Material	Stainless steel A4	 

L x B	<input type="checkbox"/>	Art.number
190X65*	2	54555.190.065

54557	Hinge, cast	MH11
Material	Stainless steel A4	 

L x B	<input type="checkbox"/>	Art.number
83X65*	2	54557.086.065

54559	Hinge, cast	MH11
Material	Stainless steel A4	 

L x B	<input type="checkbox"/>	Art.number
72X65*	2	54559.072.065

54561	Hinge, cast	MH11
Material	Stainless steel A4	
		

L x B **Art.number**

103X65* 2 [54561.103.065](#)

54563	Hinge, cast	MH11
Material	Stainless steel A4	
		



L x B **Art.number**

52X61* 2 [54563.052.061](#)

54565	Hinge, cast	MH11
Material	Stainless steel A4	
		

L x B **Art.number**

80X65* 2 [54565.080.065](#)

54567	Hinge, cast	MH11
Material	Stainless steel A4	
		

L x B **Art.number**

70X40* 2 [54567.070.040](#)

54569	Hinge, cast	MH11
Material	Stainless steel A4	
		

L x B **Art.number**

126X40* 2 [54569.126.040](#)

54571	Hinge, cast	MH11
Material	Stainless steel A4	
		

L x B **Art.number**

127X65* 2 [54571.127.065](#)

Hinge with thread, cast



Technical Data

Nr.	B	L	L ₁	S
54550.076.040	40	76	30	4
54552.134.065	65	134	21	4
54554.146.065	65	146	51	4
54556.190.065	65	190	95	4
54558.083.065	65	83	32	4
54560.072.065	72	65	21	4
54562.103.065	65	103	21	4
54564.052.061	61	52	19	4
54566.070.040	65	80	33	4
54568.070.040	40	70	30	3.5
54570.126.040	40	126	40	3.5
54572.127.065	65	127	32	4

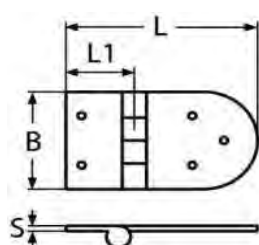

54550-72

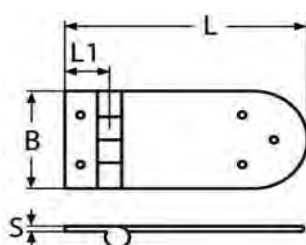

54552

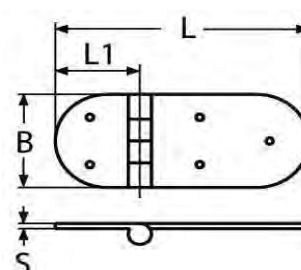

54554-70

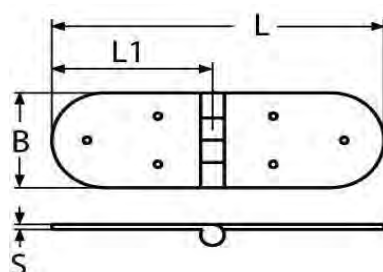

54556

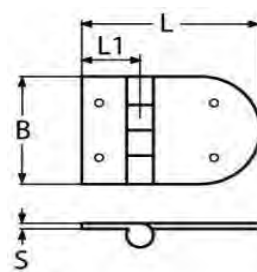

54558-60-62-68

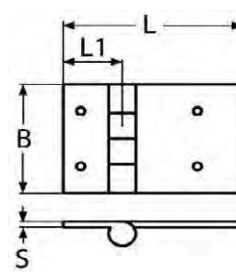



54564-66

Article groups



Material	Code	Page
St.St. A4	54550	13-102
St.St. A4	54552	13-102
St.St. A4	54554	13-102
St.St. A4	54556	13-102
St.St. A4	54558	13-102
St.St. A4	54560	13-102
St.St. A4	54562	13-103
St.St. A4	54564	13-103
St.St. A4	54566	13-103
St.St. A4	54568	13-103
St.St. A4	54570	13-103
St.St. A4	54572	13-103

54550	Hinge with thread, cast	MH11
Material	Stainless steel A4	
		

L x B  **Art.number**
 76X40* 2 [54550.076.040](#)

54552	Hinge with thread, cast	MH11
Material	Stainless steel A4	
		

L x B  **Art.number**
 134X65* 2 [54552.134.065](#)

54554	Hinge with thread, cast	MH11
Material	Stainless steel A4	
		

L x B  **Art.number**
 146X65* 2 [54554.146.065](#)

54556	Hinge with thread, cast	MH11
Material	Stainless steel A4	
		

L x B  **Art.number**
 190X65* 2 [54556.190.065](#)

54558	Hinge with thread, cast	MH11
Material	Stainless steel A4	
		

L x B  **Art.number**
 83X65* 2 [54558.083.065](#)

54560	Hinge with thread, cast	MH11
Material	Stainless steel A4	
		

L x B  **Art.number**
 72X65* 2 [54560.072.065](#)

54562	Hinge with thread, cast	MH11
Material	Stainless steel A4	
		

L x B  **Art.number**
 103X65* 2 [54562.103.065](#)

54564	Hinge with thread, cast	MH11
Material	Stainless steel A4	
		



L x B  **Art.number**
 52X61* 2 [54564.052.061](#)

54566	Hinge with thread, cast	MH11
Material	Stainless steel A4	
		



L x B  **Art.number**
 80X65* 2 [54566.070.040](#)

54568	Hinge with thread, cast	MH11
Material	Stainless steel A4	
		

L x B  **Art.number**
 70X40* 2 [54568.070.040](#)

54570	Hinge with thread, cast	MH11
Material	Stainless steel A4	
		

L x B  **Art.number**
 126X40* 2 [54570.126.040](#)

54572	Hinge with thread, cast	MH11
Material	Stainless steel A4	
		

L x B  **Art.number**
 127X65* 2 [54572.127.065](#)

Covered hinge

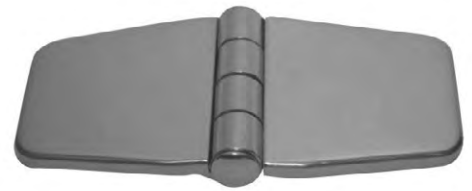

Technical Data

Nr.	B	D	L	L ₁	S	S ₁
54576.074.040	40	5.5	74	37	2	9
54577.075.074	75	7.5	74	37	2	9
54578.057.037	37	6	57	18	2	9
54579.036.036	36	6	36	18	2	9

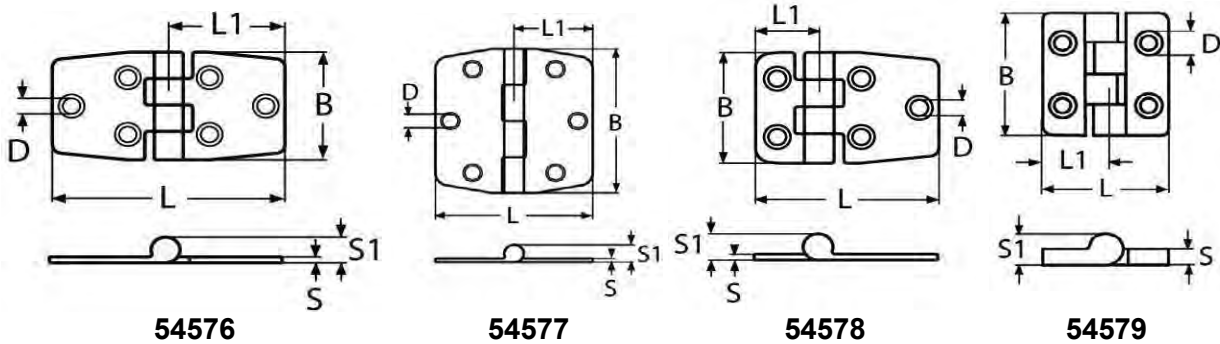



Article groups

Material	Code	Page
St.St. A4	54576	13-104
St.St. A4	54577	13-104
St.St. A4	54578	13-105
St.St. A4	54579	13-105

54576 Covered hinge MH11

Material Stainless steel A4

L x B	Art.number
74X40*	5 54576.074.040

54577 Covered hinge MH11

Material Stainless steel A4



B x L	Art.number
75X74*	5 54577.075.074

54578 Covered hinge MH11



Material: Stainless steel A4



L x B	Art.number
57X37*	5 54578.057.037

54579 Covered hinge MH11

Material: Stainless steel A4





L x B	Art.number
36X36*	5 54579.036.036

Continuous hinge

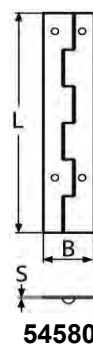

Technical Data			
Nr.	B	L	S
54580.007.016	16	3500	0.7
54580.007.018	18	3500	0.7
54580.007.020	20	3500	0.7
54580.007.025	25	3500	0.7
54580.007.032	32	3500	0.7
54580.007.040	40	3500	0.7
54580.015.032	32	2000	1.5
54580.015.040	40	2000	1.5



54580 Continuous hinge MH11

Material: Stainless steel A2





S x B	Art.number	S x B	Art.number	S x B	Art.number
0,7X16MM*	1 54580.007.016	0,7X25MM*	1 54580.007.025	1,5X32MM*	1 54580.015.032
0,7X18MM*	1 54580.007.018	0,7X32MM*	1 54580.007.032	1,5X40MM	1 54580.015.040
0,7X20MM*	1 54580.007.020	0,7X40MM*	1 54580.007.040		

Hasp

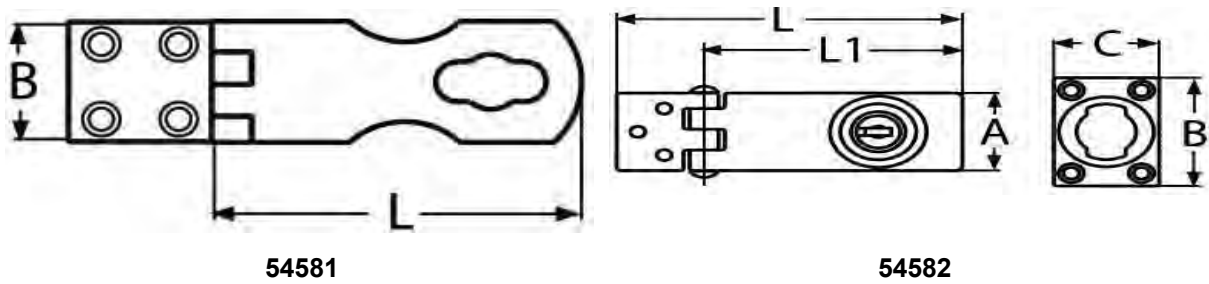

Technical Data

Nr.	A	B	C	L	L ₁
54581.071.024	-	24	-	67	-
54582.030.001	30	42	30	98	78





Article groups

Material	Code	Page
St.St. A2	54581	13-106
St.St. A2	54582	13-106

54581 Hasp **MH11**

Material Stainless steel A2

L x B	Art.number
67X24	5 54581.071.024

54582 Hasp **MH11**

Material Stainless steel A2





A	Art.number
30MM*	1 54582.030.001

Swivel hasp

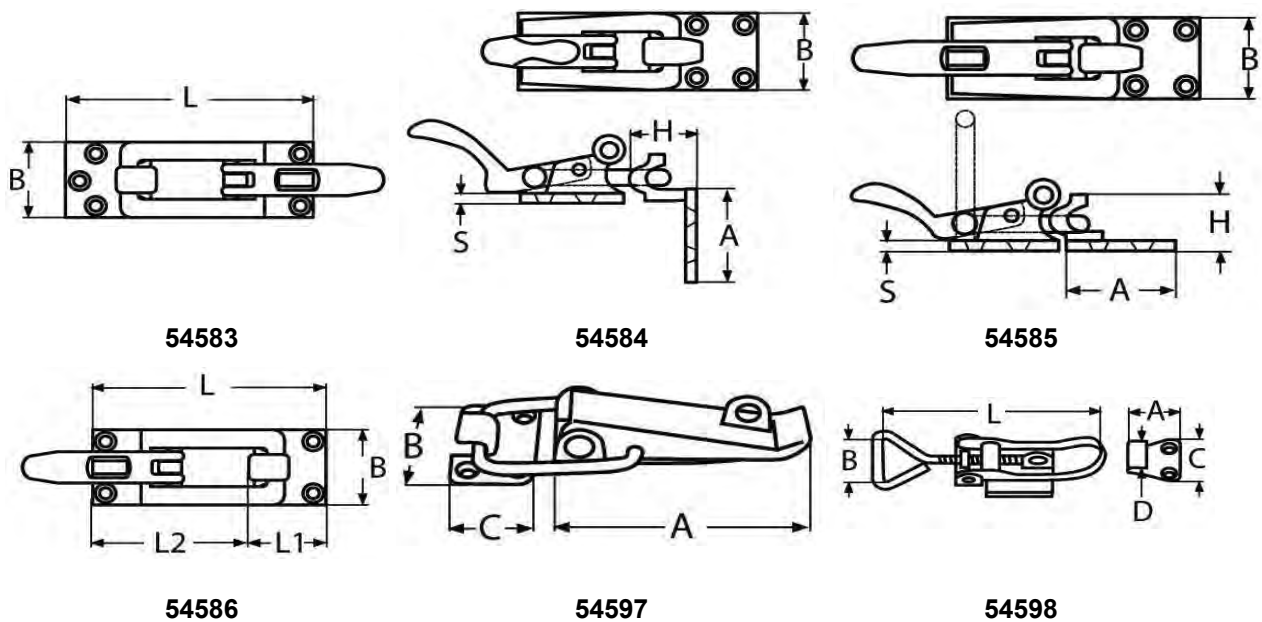

Technical Data

Nr.	A	B	C	d	D	H	L	L ₁	L ₂	S
54583.080.028	-	28	-	-	-	-	80	-	-	-
54584.037.037	37	37	-	-	-	20	-	-	-	4
54585.037.037	37	37	-	-	-	20	-	-	-	4
54586.080.028	-	28	-	-	-	-	75	25	50	-
54597.070.001	72	35	24	-	-	-	-	-	-	-
54598.065.075	20	18	26	M4	41	-	65-75	-	-	-
54598.085.095	20	18	26	M5	15	-	85-95	-	-	-
54598.115.125	29	25	30	M6	18	-	115-125	-	-	-
54598.165.185	30	35	30	M8	18	-	165-185	-	-	-



Article groups

Material	Code	Page
St.St. A4	54583	13-107
St.St. A4	54584	13-108
St.St. A4	54585	13-108
St.St. A4	54586	13-108
St.St. A2	54597	13-108
St.St. A2	54598	13-108

54583 Swivel hasp with lock

MH11

Material Stainless steel A4



L x B Art.number
80X28* 1 [54583.080.028](#)

54584	Swivel hasp	MH11
Material	Stainless steel A4	
		

A x B	<input type="checkbox"/>	Art.number
37X37MM*	1	54584.037.037

54585	Swivel hasp	MH11
Material	Stainless steel A4	
		



A x B	<input type="checkbox"/>	Art.number
37X37MM*	1	54585.037.037

54586	Swivel hasp	MH11
Material	Stainless steel A4	
		

L x B	<input type="checkbox"/>	Art.number
75X28*	1	54586.080.028

54597	Tensor latch, lockable	MH11
Material	Stainless steel A2	
		

A	<input type="checkbox"/>	Art.number
72MM*	1	54597.070.001

54598	Snag	MH11
Material	Stainless steel A2	
		

L	<input type="checkbox"/>	Art.number	L	<input type="checkbox"/>	Art.number	L	<input type="checkbox"/>	Art.number
65-75MM*	1	54598.065.075	115-125MM	1	54598.115.125	165-185MM*	1	54598.165.185
85-95MM*	1	54598.085.095						

Latch



Technical Data

Nr.	A	B	C	D	E	Thickness
54594.072.001	72	27	-	30	-	-
54595.091.001	91	56	9	16	54	-
54596.015.045	45	30	15	9.5	-	2.3
54596.036.076	76	38	36	9.5	-	4

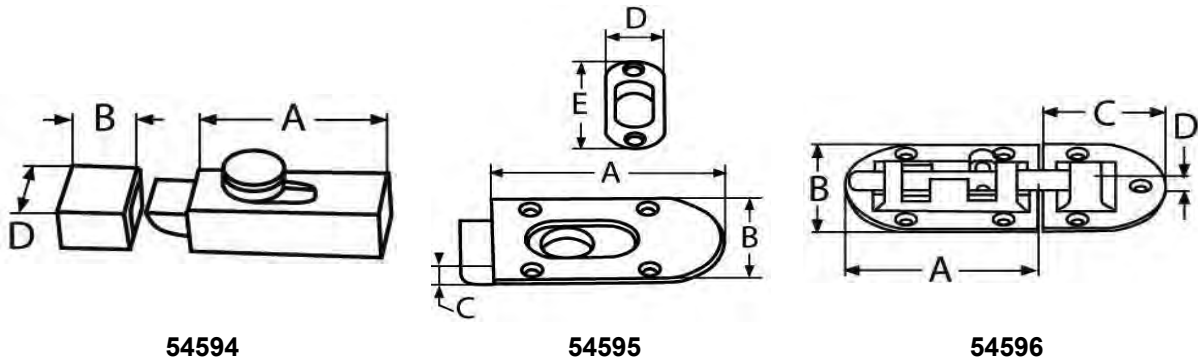

Article groups

Material	Code	Page
St.St. A4	54594	13-109
St.St. A4	54595	13-109
St.St. A4	54596	13-110

54594 Spring loaded door latch MH11

Material: Stainless steel A4

A	Art.number
72MM*	1 54594.072.001

54595 Spring loaded slide latch MH11

Material: Stainless steel A4

A	Art.number
91MM*	1 54595.091.001

54596	Locking hinge	MH11
Material	Stainless steel A4	
		 

C x A	<input type="checkbox"/>	Art.number	C x A	<input type="checkbox"/>	Art.number
15X45*	1	54596.015.045	36X76*	1	54596.036.076

Lifting ring



Technical Data

Nr.	A	B	C	D	H	L	L ₁	L ₂	Thickness	Type
54587.063.063	73	-	-	63	-	63	-	-	-	Square
54587.063.163	73	-	-	63	-	60	-	-	-	Round
54588.060.001	60	41	50	33	-	-	-	-	-	-
54589.050.001	-	-	-	50	19	-	-	-	6	-
54590.050.050	-	50	-	-	-	50	-	-	6	-
54591.061.001	61	50	33	-	-	-	-	-	-	-
54603.050.001	50	55	-	-	-	32	30	65	-	-

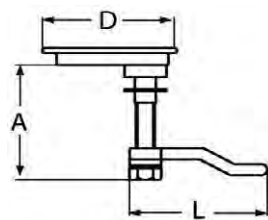

54587

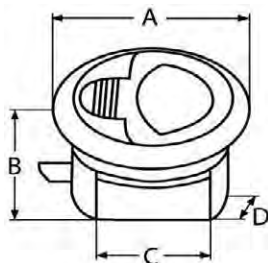

54588

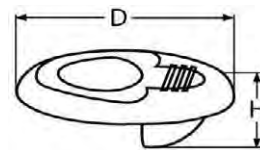

54589

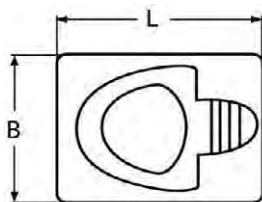

54590

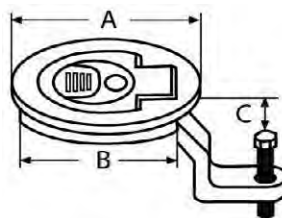

54591

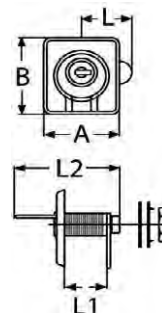

54603

Article groups



Material	Code	Page
St.St. A4	54587	13-111
St.St. A4	54588	13-111
St.St. A4	54589	13-111
St.St. A4	54590	13-111
St.St. A4	54591	13-111
St.St. A4	54603	13-111

54587	Lifting ring with lock	MH11
Material	Stainless steel A4	
		

D x A	Art.number	D x A	Art.number
63X63 Square* 1	54587.063.063	63 Round* 1	54587.063.163

54588	Weatherproof slam latch	MH11
Material	Stainless steel A4	
		

A	Art.number
60MM* 1	54588.060.001

54589	Lifting ring	MH11
Material	Stainless steel A4	
		

D	Art.number
50MM* 1	54589.050.001

54590	Lifting ring	MH11
Material	Stainless steel A4	
		

L x B	Art.number
50X50* 1	54590.050.050

54591	Lifting ring with lock	MH11
Material	Stainless steel A4	
		

A	Art.number	A	Art.number
Spare key* 1	54591.001.770	61MM* 1	54591.061.001

54603	Lifting ring with lock	MH11
Material	Stainless steel A4	
		

A	Art.number
50MM* 1	54603.050.001

Lifting ring



Technical Data

Nr.	B	L	S	S ₁
54600.047.038	38	47	-	-
54601.063.044	44	63	-	-
54602.075.056	56	75	-	-
54604.090.001	25	90	3	33

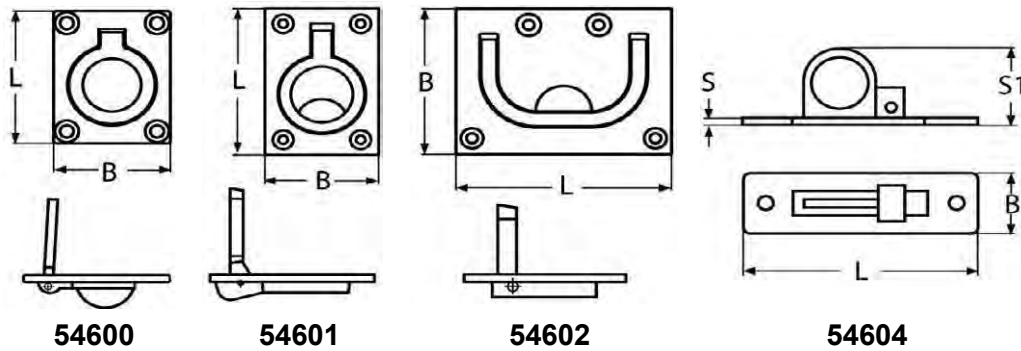

Article groups

Material	Code	Page
St.St. A4	54600	13-112
St.St. A4	54601	13-112
St.St. A4	54602	13-113
St.St. A2	54604	13-113

54600 Lifting ring MH11



Material Stainless steel A4



L x B	Art.number
47X38*	1 54600.047.038

54601 Lifting ring MH11

Material Stainless steel A4

L x B	Art.number
63X44*	1 54601.063.044

54602	Lifting ring	MH11
Material	Stainless steel A4	
		

L x B	<input type="checkbox"/>	Art.number
75X56*	1	54602.075.056

54604	Lifting ring	MH11
Material	Stainless steel A2	
		

L	<input type="checkbox"/>	Art.number
90MM*	1	54604.090.001

Gate hook



Technical Data					
Nr.	B	D	L	Length (mm)	Thickness
54592.050.001	33	4.4	50	-	-
54592.070.001	33	4.4	70	-	-
54592.090.001	33	4.4	90	-	-
54593.100.001	37.5	-	100	-	-
54599.080.001	-	-	-	80	3.9
54599.120.001	-	-	-	120	4.4

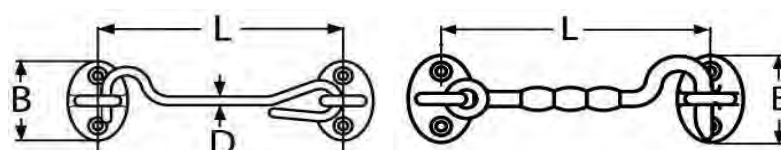

54592

54593

Article groups		
Material	Code	Page
St.St. A4	54592	13-114
St.St. A4	54593	13-114
St.St. A2	54599	13-114

54592	Gate hook	MH11
Material	Stainless steel A4	
		 

L	☒	Art.number	L	☒	Art.number	L	☒	Art.number
50MM*	5	54592.050.001	70MM*	5	54592.070.001	90MM*	5	54592.090.001

54593	Gate hook	MH11
Material	Stainless steel A4	
		 

L	☒	Art.number
100MM*	1	54593.100.001

54599	Gate hook with eye	MH11
Material	Stainless steel A2	
		 

Length	☒	Art.number	Length	☒	Art.number
80MM*	5	54599.080.001	120MM*	5	54599.120.001

Coat hook



Technical Data									
Nr.	A	B	C	D	H	H ₁	L	L ₁	S
54605.032.500	-	17	-	-	32.5	14	32.5	20	-
54605.043.001	-	22	-	-	47.5	21	43	30	-
54606.035.001	-	23	16	-	44	-	35	21.5	-
54606.043.001	-	25	18	-	56	-	43	30	-
54607.047.001	-	-	18.5	28	37	-	47	-	3
54607.065.001	-	-	22.5	35	44	-	65	-	4
54608.040.030	-	30	-	-	-	-	40	-	-
54609.030.025	-	30	-	-	-	-	40	-	-
54610.035.033	-	33	-	-	-	-	35	-	-
54611.100.001	10	60	-	-	-	-	35	-	-
54612.120.001	12	36	-	-	-	-	48	-	-
54613.060.001	6	30	-	-	-	-	-	-	-
54614.055.038	-	43	20	-	-	-	55	-	-
54615.050.001	50	50	28	10	-	-	-	-	-

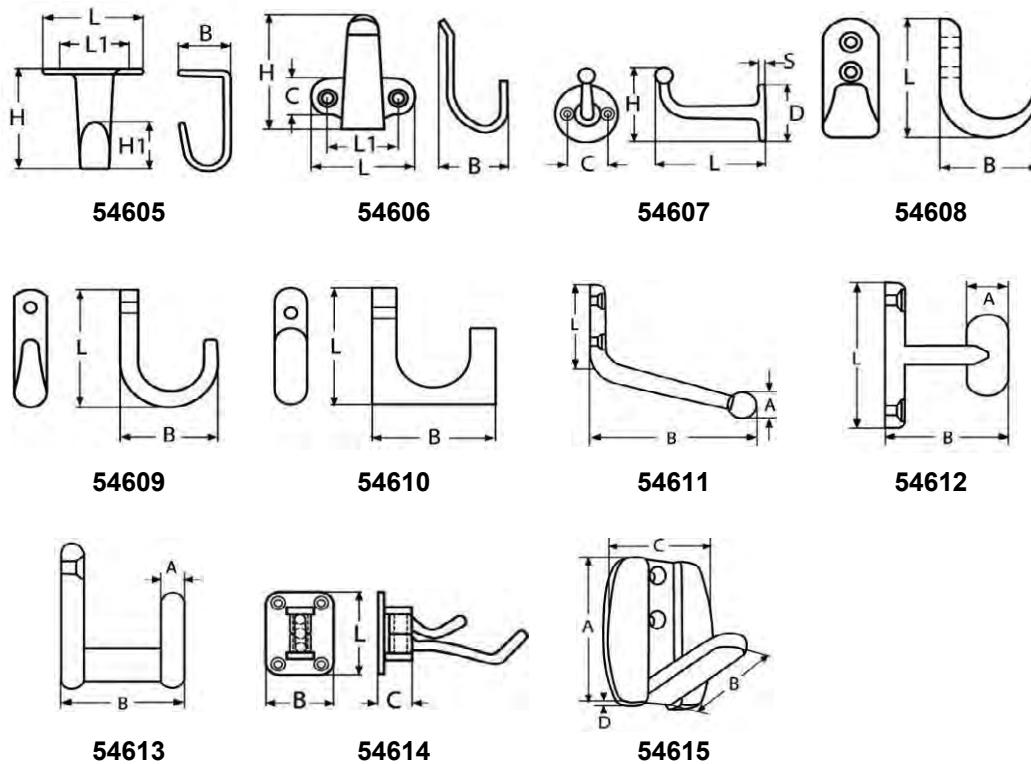

Article groups		
Material	Code	Page
St.St. A2	54605	13-115
St.St. A2	54606	13-115
St.St. A2	54607	13-116
St.St. A2	54608	13-116
St.St. A2	54609	13-116
St.St. A2	54610	13-116
St.St. A2	54611	13-116
St.St. A2	54612	13-116
St.St. A2	54613	13-117
St.St. A2	54614	13-117
St.St. A4	54615	13-117

54605	Hook end, polished	MH11
Material	Stainless steel A2	

L	☒	Art.number	L	☒	Art.number
32,5MM*	10	54605.032.500	43MM*	10	54605.043.001

54606	Hook end, polished	MH11
Material	Stainless steel A2	



L	☒	Art.number	L	☒	Art.number
35MM*	10	54606.035.001	43MM*	10	54606.043.001

54607	Hook end, polished	MH11
Material	Stainless steel A2	
		



L	<input type="checkbox"/>	Art.number	L	<input type="checkbox"/>	Art.number
47MM*	10	54607.047.001	65MM*	10	54607.065.001

54608	Coat hook polished	MH11
Material	Stainless steel A2	
		

L x B	<input type="checkbox"/>	Art.number
40X30*	10	54608.040.030

54609	Coat hook polished	MH11
Material	Stainless steel A2	
		



L x B	<input type="checkbox"/>	Art.number
30X25*	10	54609.030.025

54610	Coat hook polished	MH11
Material	Stainless steel A2	
		

L x B	<input type="checkbox"/>	Art.number
35X33*	10	54610.035.033

54611	Coat hook	MH11
Material	Stainless steel A2	
		

A	<input type="checkbox"/>	Art.number
10MM*	10	54611.100.001

54612	Coat hook	MH11
Material	Stainless steel A2	
		

A	<input type="checkbox"/>	Art.number
12MM*	10	54612.120.001

54613	Coat hook	MH11
Material	Stainless steel A2	
		

A		Art.number
6MM*	10	54613.060.001

54614	Movable hook	MH11
Material	Stainless steel A2	
		

L x B		Art.number
55X38*	5	54614.055.038

54615	Coat hook foldable	MH11
Material	Stainless steel A4	
		

A		Art.number
50MM*	5	54615.050.001

Coat hook



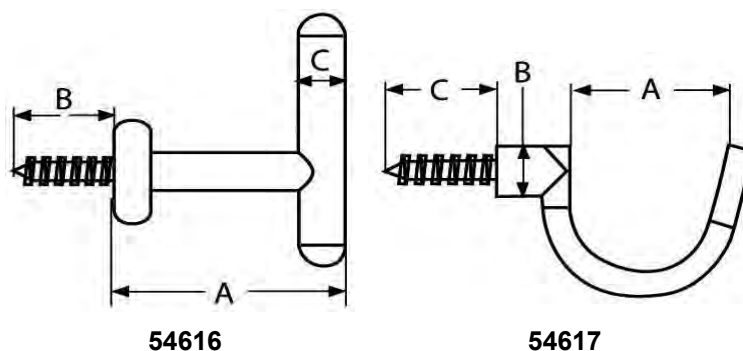

Technical Data

Nr.	A	B	C
54616.040.001	40	17	8
54617.026.001	26	9	18





Article groups

Material	Code	Page
St.St. A2	54616	13-118
St.St. A2	54617	13-118

54616	Coat hook	MH11
Material	Stainless steel A2	
		

A	<input type="checkbox"/>	Art.number
40MM*	10	54616.040.001

54617	Coat hook	MH11
Material	Stainless steel A2	
		

A	<input type="checkbox"/>	Art.number
26MM*	10	54617.026.001

S-hook



Technical Data

Nr.	B	C	D	L	S	S ₁	S ₂	W	W ₁	W ₂	ø
54618.030.001	-	-	-	30	-	5	10	-	9	16	3
54618.040.001	-	-	-	36	-	6	12	-	12	19	4
54618.050.001	-	-	-	43	-	6	12	-	14	21	5
54618.060.001	-	-	-	50	-	7	15	-	15	25	6
54618.080.001	-	-	-	67	-	9	20	-	20	33	8
54619.030.001	-	-	-	24	4	-	-	9	-	-	3
54619.040.001	-	-	-	32	6	-	-	12	-	-	4
54619.050.001	-	-	-	40	8	-	-	15	-	-	5
54619.060.001	-	-	-	48	9	-	-	17	-	-	6
54619.080.001	-	-	-	64	12	-	-	24	-	-	8
54619.100.001	-	-	-	80	13	-	-	30	-	-	10
54620.095.001	17	19.5	6.9	90	-	-	-	-	-	-	9.5
54620.110.001	17	22	7	100	-	-	-	-	-	-	11
54620.130.001	17	22	8	112	-	-	-	-	-	-	13
54621.050.001	9	9	2	52	-	-	-	-	-	-	5
54621.060.001	10	10	5	64	-	-	-	-	-	-	6
54621.080.001	16	17	5	75	-	-	-	-	-	-	8
54621.100.001	20	20	8	95	-	-	-	-	-	-	10

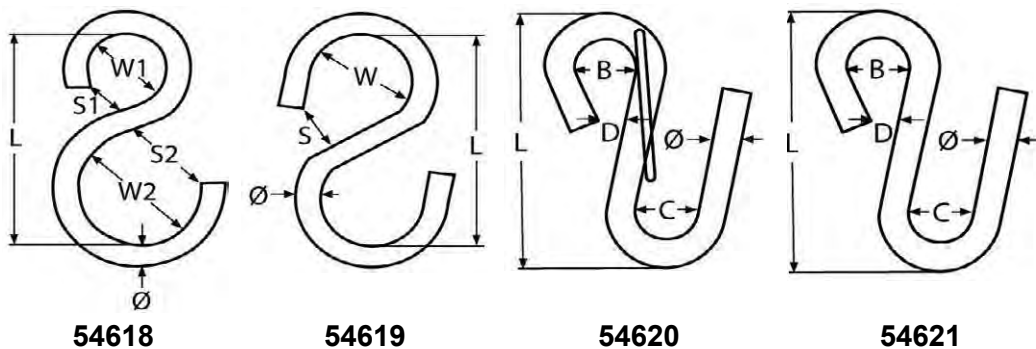

Article groups		
Material	Code	Page
St.St. A2	54618	13-119
St.St. A2	54619	13-119
St.St. A4	54620	13-119
St.St. A4	54621	13-119

54618 S-hook asymmetric MH11

Material Stainless steel A2

∅	⊞	Art.number	∅	⊞	Art.number	∅	⊞	Art.number
3MM*	20	54618.030.001	5MM	20	54618.050.001	8MM*	10	54618.080.001
4MM*	20	54618.040.001	6MM*	10	54618.060.001			

54619 S-hook symmetric MH11

Material Stainless steel A2



∅	⊞	Art.number	∅	⊞	Art.number	∅	⊞	Art.number
3MM*	20	54619.030.001	5MM*	20	54619.050.001	8MM*	10	54619.080.001
4MM	20	54619.040.001	6MM*	10	54619.060.001	10MM*	5	54619.100.001

54620 S-hook with gate MH11

Material Stainless steel A4

∅	⊞	Art.number	∅	⊞	Art.number	∅	⊞	Art.number
9,5MM*	5	54620.095.001	11,0MM*	5	54620.110.001	13,0MM*	5	54620.130.001

54621 S-hook MH11

Material Stainless steel A4





∅	⊞	Art.number	∅	⊞	Art.number	∅	⊞	Art.number
5MM*	10	54621.050.001	8MM*	10	54621.080.001	10MM*	5	54621.100.001
6MM*	10	54621.060.001						

Plain cup hook

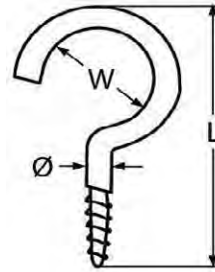

Technical Data

Nr.	L	W	ø
54622.029.040	40	12	2.9
54622.033.050	50	16	3.3
54622.033.060	60	16	3.3
54622.044.050	50	16	4.4
54622.048.065	65	22	4.8
54622.052.080	80	26	5.2
54622.058.100	100	26	5.8



54622

54622 Plain cup hook MH11

Material Stainless steel A4



ø x L	⊠	Art.number	ø x L	⊠	Art.number	ø x L	⊠	Art.number
2,9X40*	100	54622.029.040	4,4X50*	50	54622.044.050	5,2X80*	20	54622.052.080
3,3X50*	100	54622.033.050	4,8X65*	50	54622.048.065	5,8X100*	20	54622.058.100
3,3X60*	100	54622.033.060						

Awning hook



Technical Data

Nr.	A	B	D	D ₁	H	L	L ₁
54623.100.001	30	35	10	4.5	-	20	22
54624.080.001	8	34	-	-	24	36	-
54624.110.001	11	34	-	-	34	42	-

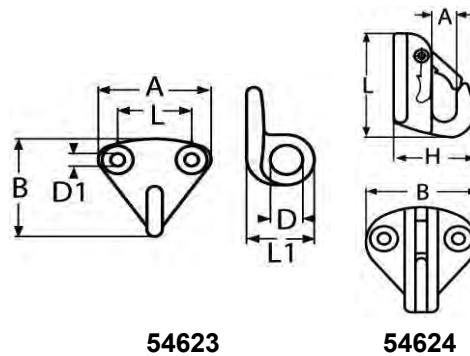

54623

54624

Article groups

Material	Code	Page
St.St. A4	54623	13-121
St.St. A4	54624	13-121

54623 Awning hook MH11

Material Stainless steel A4

D	Art.number
10MM*	10 54623.100.001

54624 Fender hook MH11

Material Stainless steel A4





A	Art.number	A	Art.number
8MM*	5 54624.080.001	11MM*	5 54624.110.001

Bracket

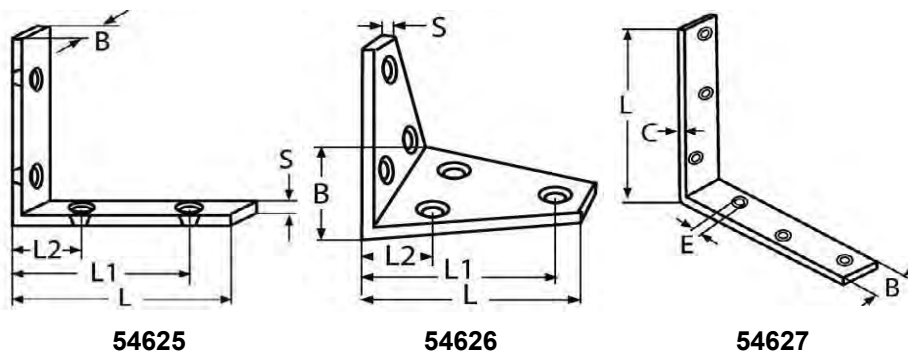

Technical Data

Nr.	B	C	E	L	L ₁	L ₂	S
54625.031.012	12	-	-	31	25	12	3
54625.046.013	13	-	-	46	38	18	3
54625.061.015	15	-	-	61	51	21	3
54626.041.025	25	-	-	41	35	18	3
54626.056.035	35	-	-	56	47.5	18.5	3
54626.080.050	50	-	-	80	71	24	4
54627.150.001	30	5	5	150	-	-	-
54627.200.001	30	5	5	200	-	-	-
54627.250.001	30	5	5	250	-	-	-
54627.300.001	30	5	5	300	-	-	-



Article groups

Material	Code	Page
St.St. A2	54625	13-122
St.St. A2	54626	13-122
St.St. A2	54627	13-123

54625 Bracket end-polished MH11



Material: Stainless steel A2

L x B	⊗	Art.number	L x B	⊗	Art.number	L x B	⊗	Art.number
31X12*	10	54625.031.012	46X13*	10	54625.046.013	61X15*	10	54625.061.015

54626 Bracket end-polished MH11

Material: Stainless steel A2

L x B	⊗	Art.number	L x B	⊗	Art.number	L x B	⊗	Art.number
41X25*	10	54626.041.025	56X35*	10	54626.056.035	80X50*	10	54626.080.050



54627	Bracket	MH11
Material	Stainless steel A2	
		

L	☒	Art.number	L	☒	Art.number	L	☒	Art.number
150MM*	2	54627.150.001	250MM*	2	54627.250.001	300MM*	2	54627.300.001
200MM*	2	54627.200.001						

Short cord hook



Technical Data	
Nr.	∅
54628.060.001	6
54628.080.001	8
54628.100.001	10

54628	Short cord hook	MH11
Material	Stainless steel A2	
		

∅	☒	Art.number	∅	☒	Art.number	∅	☒	Art.number
6MM*	20	54628.060.001	8MM*	20	54628.080.001	10MM*	20	54628.100.001

Hook with thread



Technical Data

Nr.	A	B	d	D	L
54629.079.001	36	16	5/16	41	89

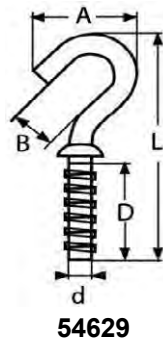

54629	Hook with thread	MH11
Material	Stainless steel A4	
		

GW		Art.number
5/16**	10	54629.079.001

Transom mount ski tow



Technical Data

Nr.	B	C	d	D	L	L ₁	ø
54630.100.060	-	-	M10	60	100	50	9
54630.125.090	-	-	M12	90	125	65	12
54631.092.062	62	50	M8	-	92	-	-

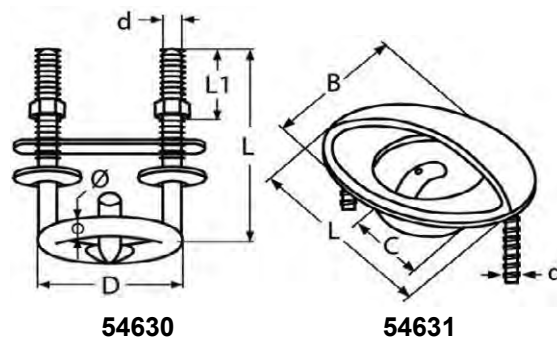

Article groups

Material	Code	Page
St.St. A4	54630	13-125
St.St. A4	54631	13-125

54630	Transom mount ski tow	MH11
Material	Stainless steel A4	
		

L x D	☒	Art.number	L x D	☒	Art.number
100X60*	1	54630.100.060	125X90*	1	54630.125.090

54631	Transom mount ski tow	MH11
Material	Stainless steel A4	
		

L x B	☒	Art.number
92X62*	1	54631.092.062

Door holder



Technical Data

Nr.	A	B	B ₁	C	H	L	L ₁	S
54632.029.001	-	22	25	-	-	29	34	-
54632.041.001	-	70	31	-	-	41	40.5	-
54632.042.001	-	40	31	-	-	42	41	-
54633.090.050	9	29	50	-	12	-	-	2
54634.034.034	34	34	-	-	-	-	-	-
54635.034.034	34	34	-	-	-	-	-	-
54636.051.115	-	51	-	25	-	90-115	-	-
54637.051.025	-	51	-	25	-	90-115	-	-
54638.080.001	-	-	-	-	-	40	60	-

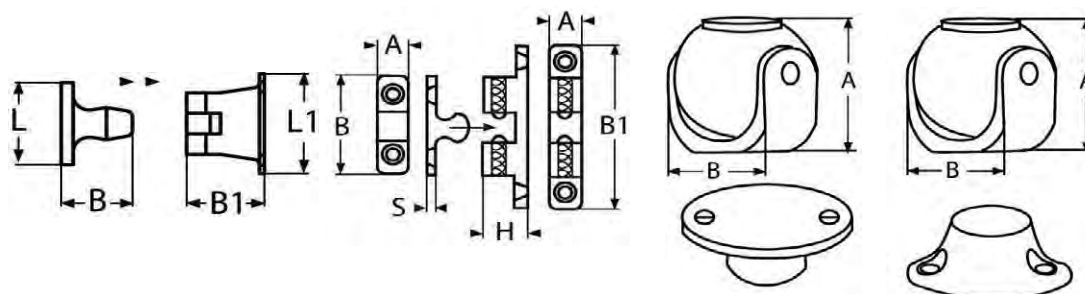

54632

54633

54634

54635

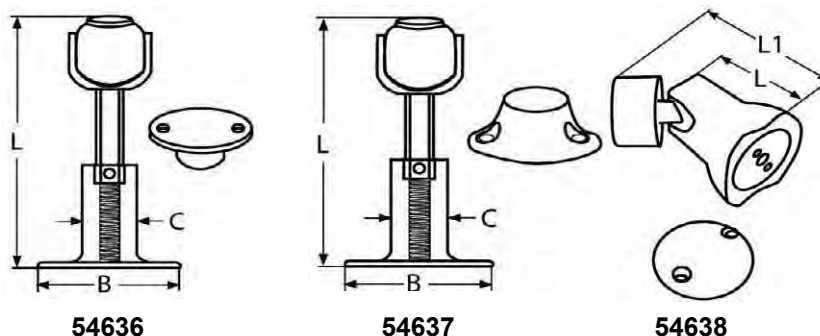

54636

54637

54638

Article groups

Material	Code	Page
St.St. A2	54632	13-127
St.St. A4	54633	13-127
St.St. A4	54634	13-127
St.St. A4	54635	13-127
St.St. A4	54636	13-127
St.St. A4	54637	13-127
St.St. A4	54638	13-128

54632	Door holder	MH11
Material	Stainless steel A2	
		 

L	☒	Art.number	L	☒	Art.number	L	☒	Art.number
29MM*	5	54632.029.001	41MM*	5	54632.041.001	42MM*	5	54632.042.001

54633	Ball catch	MH11
Material	Stainless steel A4	
		 

A x B ₁	☒	Art.number
9X50	5	54633.090.050

54634	Magnet door holder	MH11
Material	Stainless steel A4	
		 

A x B	☒	Art.number
34X34*	5	54634.034.034

54635	Magnet door holder with mounting plate	MH11
Material	Stainless steel A4	
		 

A x B	☒	Art.number
34X34*	1	54635.034.034

54636	Adjustable door holder	MH11
Material	Stainless steel A4	
		 

B x A	☒	Art.number
51X115*	2	54636.051.115

54637	Adjustable magnet door holder with mounting plate	MH11
Material	Stainless steel A4	
		 

B x A	☒	Art.number
51X25*	1	54637.051.025

54638	Magnetic barrel bolt swiveling, brass chrome plated	MH11
Material	Stainless steel A4	

Size	<input type="checkbox"/>	Art.number
80MM*	1	54638.080.001

Boat hook holder



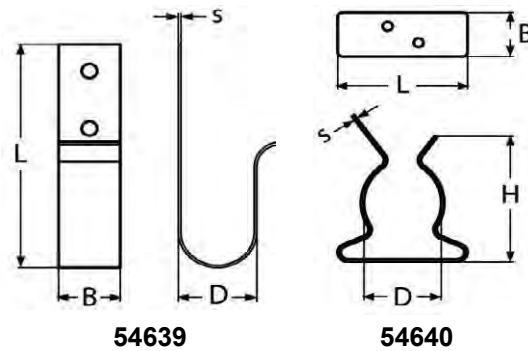

Technical Data

Nr.	B	D	H	L	S
54639.100.001	25	32	-	100	1
54640.036.001	19	20	38	35	1.3
54640.050.001	19	28	54	50	1.3



Article groups

Material	Code	Page
St.St. A2	54639	13-128
St.St. A2	54640	13-128

54639	Boat hook holder	MH11
Material	Stainless steel A2	
		

L	<input type="checkbox"/>	Art.number
100MM*	10	54639.100.001

54640	Boat hook holder	MH11
Material	Stainless steel A2	
		

L	<input type="checkbox"/>	Art.number	L	<input type="checkbox"/>	Art.number
35MM*	10	54640.036.001	50MM*	10	54640.050.001

Folding pad eye



Technical Data

Nr.	A	B	D	H	L	S	ø
54641.060.001	55	50	7	-	58	-	6
54641.080.001	55	50	7	-	58	-	8
54642.100.080	-	-	-	80	100	1.5	-

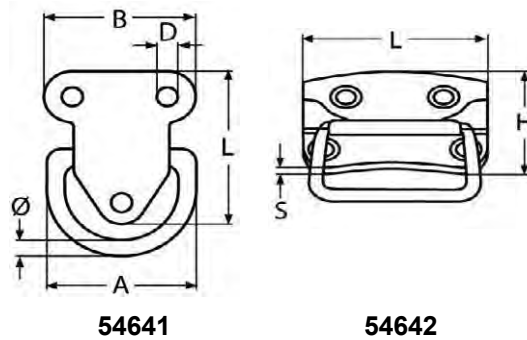

Article groups

Material	Code	Page
St.St. A2	54641	13-129
St.St. A2	54642	13-129

54641	Folding pad eye	MH11
Material	Stainless steel A2	
		

ø	⊠	Art.number	ø	⊠	Art.number
6MM*	5	54641.060.001	8MM*	5	54641.080.001

54642	Box handle	MH11
Material	Stainless steel A2	
		

L x H	⊠	Art.number
100X80*	1	54642.100.080

Ring



Technical Data

Nr.	A	Angle	B	C	D	H	L	ø
54643.060.040	-	60	-	-	-	-	40	6
54643.060.045	-	60	-	-	-	-	45	6
54643.060.050	-	60	-	-	-	-	50	6
54643.080.045	-	60	-	-	-	-	45	8
54643.080.050	-	60	-	-	-	-	50	8
54644.030.015	-	-	-	-	-	15	-	3
54644.030.020	-	-	-	-	-	20	-	3
54644.030.030	-	-	-	-	-	30	-	3
54644.040.025	-	-	-	-	-	25	-	4
54644.040.030	-	-	-	-	-	30	-	4
54644.040.035	-	-	-	-	-	35	-	4
54644.050.030	-	-	-	-	-	30	-	5
54644.050.040	-	-	-	-	-	40	-	5
54644.060.035	-	-	-	-	-	35	-	6
54644.060.040	-	-	-	-	-	40	-	6
54644.060.045	-	-	-	-	-	45	-	6
54644.080.040	-	-	-	-	-	40	-	8
54644.080.050	-	-	-	-	-	50	-	8
54644.100.050	-	-	-	-	-	50	-	10
54644.100.080	-	-	-	-	-	60	-	10
54644.120.070	-	-	-	-	-	70	-	12
54645.030.015	-	-	-	-	-	15	15	3
54645.030.020	-	-	-	-	-	18	20	3
54645.040.020	-	-	-	-	-	18	20	4
54645.040.025	-	-	-	-	-	23	25	4
54645.050.025	-	-	-	-	-	23	25	5
54645.050.030	-	-	-	-	-	26	30	5
54645.060.030	-	-	-	-	-	27	30	6
54645.060.040	-	-	-	-	-	36	40	6
54645.060.050	-	-	-	-	-	47	50	6
54645.080.050	-	-	-	-	-	47	50	8
54646.060.040	-	-	-	-	-	40	-	6
54646.080.050	-	-	-	-	-	50	-	8
54646.100.060	-	-	-	-	-	60	-	10
54646.120.080	-	-	-	-	-	80	-	12
54647.060.050	28	-	50	10	-	-	-	6
54647.080.050	28	-	50	10	-	-	-	8
54648.050.001	5	-	53	-	-	52	-	5
54648.060.001	5	-	54	-	-	53	-	6
54648.080.001	5	-	56	-	-	62	-	8
54649.060.001	43	-	30	-	-	-	-	6
54649.080.001	51	-	35	-	-	-	-	8
54650.060.001	42	-	30	-	-	-	-	6
54650.080.001	51	-	35	-	-	-	-	8
54651.200.001	-	-	-	-	20	-	-	1.4
54651.300.001	-	-	-	-	30	-	-	2.0
54652.130.001	-	-	63	-	-	-	120	13
54652.160.001	-	-	76	-	-	-	146	16
54652.190.001	-	-	89	-	-	-	165	19
54652.250.001	-	-	89	-	-	-	178	25

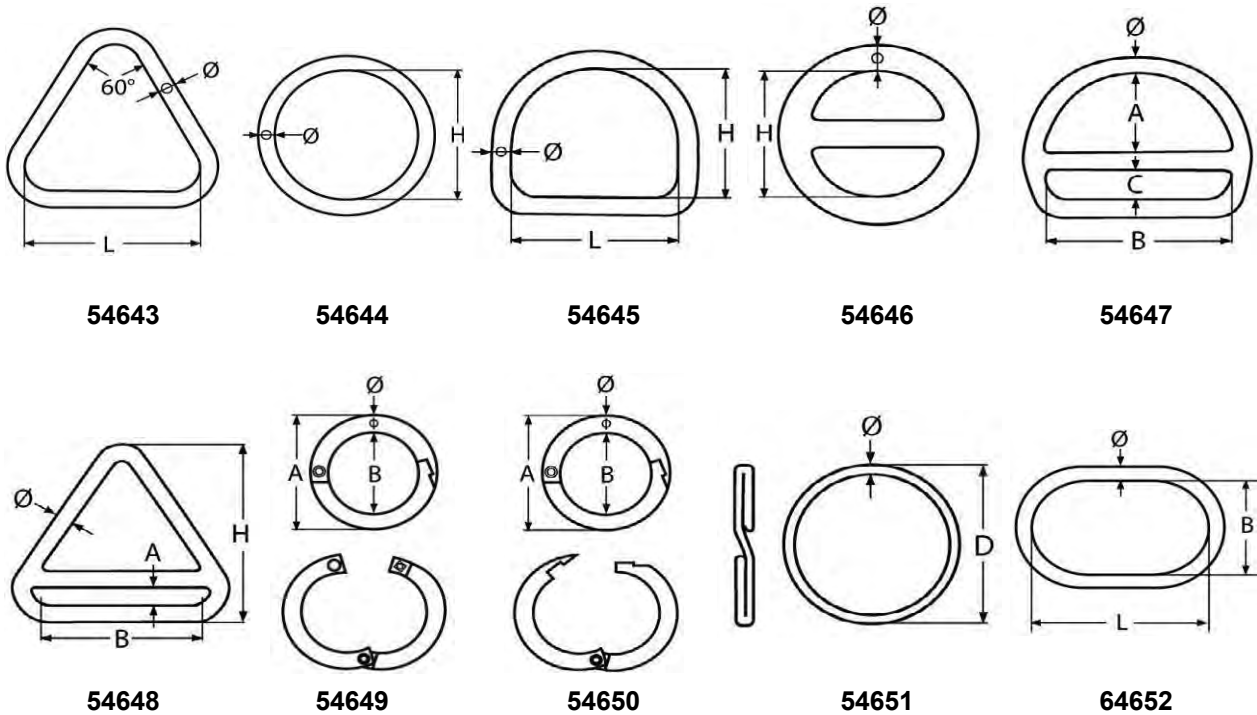

Article groups

Material	Code	Page
St.St. A2	54643	13-131
St.St. A4	54644	13-131
St.St. A2	54645	13-132
St.St. A4	54646	13-132
St.St. A4	54647	13-132
St.St. A4	54648	13-132
St.St. A4	54649	13-132
St.St. A2	54650	13-132
St.St. A2	54651	13-133
St.St. A4	54652	13-133

54643 Triangle ring, welded and polished MH11



Material Stainless steel A2



ø x L	⊠	Art.number	ø x L	⊠	Art.number	ø x L	⊠	Art.number
6X40*	10	54643.060.040	6X50*	5	54643.060.050	8X45*	5	54643.080.045
6X45*	10	54643.060.045				8X50*	5	54643.080.050



54644 Ring, welded and polished MH11



Material Stainless steel A4



ø x H	⊠	Art.number	ø x H	⊠	Art.number	ø x H	⊠	Art.number
3-15*	50	54644.030.015	5-30*	20	54644.050.030	8-50*	10	54644.080.050
3-20*	50	54644.030.020	5-40*	20	54644.050.040	10-50*	10	54644.100.050
3-30*	50	54644.030.030	6-35*	20	54644.060.035	10-60*	10	54644.100.080
4-25*	50	54644.040.025	6-40*	20	54644.060.040	12-70*	5	54644.120.070
4-30*	50	54644.040.030	6-45*	20	54644.060.045			
4-35*	50	54644.040.035	8-40*	10	54644.080.040			



54645		D-ring, welded & polished		MH11	
Material		Stainless steel A2			
					
ø x H	☒	Art.number	ø x H	☒	Art.number
3-15*	1	54645.030.015	5-25*	1	54645.050.025
3-20*	1	54645.030.020	5-30*	1	54645.050.030
4-20*	1	54645.040.020	6-30*	1	54645.060.030
4-25*	1	54645.040.025	6-40*	1	54645.060.040
			6-50*	1	54645.060.050
			8-50*	1	54645.080.050



54646		D-ring with bar		MH11	
Material		Stainless steel A4			
					
ø x H	☒	Art.number	ø x H	☒	Art.number
6-40*	10	54646.060.040	10-60*	5	54646.100.060
8-50*	10	54646.080.050	12-80*	5	54646.120.080





54647		Double layer D-ring		MH11	
Material		Stainless steel A4			
					
ø x B	☒	Art.number	ø x B	☒	Art.number
6-50*	10	54647.060.050	8-50*	10	54647.080.050

54648		Triangle with cross bar		MH11	
Material		Stainless steel A4			
					
ø	☒	Art.number	ø	☒	Art.number
5MM*	10	54648.050.001	6MM*	10	54648.060.001
			8MM*	10	54648.080.001

54649		Two-part ring		MH11	
Material		Stainless steel A4			
					
ø	☒	Art.number	ø	☒	Art.number
6MM*	10	54649.060.001	8MM*	10	54649.080.001

54650		Two-part ring with snap fastener		MH11	
Material		Stainless steel A2			
					
ø	☒	Art.number	ø	☒	Art.number
6MM*	10	54650.060.001	8MM*	10	54650.080.001

54651	Key ring				MH11
Material	Stainless steel A1/A2				
					
D		Art.number	D		Art.number
20MM	100	54651.200.001	30MM	100	54651.300.001

54652	Oval ring heavy duty				MH11
Material	Stainless steel A4				
					
ø		Art.number	ø		Art.number
13MM*	5	54652.130.001	19MM*	5	54652.190.001
16MM*	5	54652.160.001	25MM*	1	54652.250.001





Ring nail

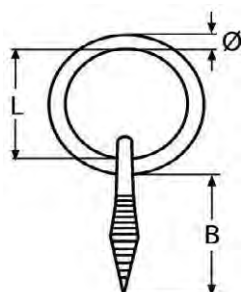

Technical Data			
Nr.	B	L	ø
54653.030.001	35	25	3
54653.040.001	35	30	4
54653.050.001	38	35	5
54653.060.001	40	40	6
54653.080.001	40	45	8



54653

54653	Ring nail				MH11
Material	Stainless steel A4				
					
ø		Art.number	ø		Art.number
3MM*	10	54653.030.001	5MM*	10	54653.050.001
4MM*	10	54653.040.001	6MM*	10	54653.060.001
			8MM*	5	54653.080.001

Handle



Technical Data

Nr.	B	D	H	L	L ₁	L ₂	S	W	W ₁
54654.065.001	13	7	16	65	48	57	-	-	-
54654.080.001	14	8	20	80	64	72	-	-	-
54654.100.001	18	10	25	100	75	88	-	-	-
54655.118.001	12	-	27	118	100	105	-	36	26
54655.152.001	18	-	32	152	130	135	-	43	35
54656.106.001	17	6.5	27.5	150	-	-	3.6	-	-

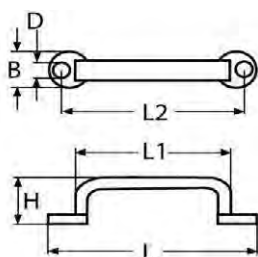

54654

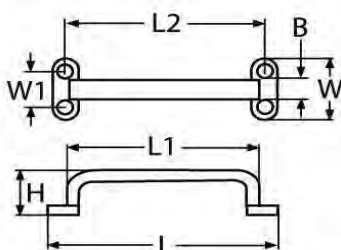

54655

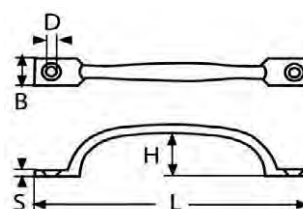

54656

Article groups

Material	Code	Page
St.St. A2	54654	13-134
St.St. A2	54655	13-134
St.St. A4	54656	13-135

54654 Handle end-polished MH11

Material: Stainless steel A2



L	Art.number	L	Art.number	L	Art.number
65MM*	5 54654.065.001	80MM*	5 54654.080.001	100MM*	5 54654.100.001

54655 Handle end-polished MH11

Material: Stainless steel A2



L	Art.number	L	Art.number
118MM*	1 54655.118.001	152MM*	1 54655.152.001

54656	Handle	MH11
Material	Stainless steel A4	
		 

L		Art.number
106MM*	5	54656.106.001

Chain



Technical Data

Nr.	B ₂	Length (mtr)	P	ø	≈ Breaking load (N)
54701.020.001	8	100 m	12	2	1.250
54701.030.001	11	100 m	16	3	2.800
54701.040.001	14	50 m	16	4	8.000
54701.050.001	17	50 m	18.5	5	12.500
54701.060.001	20	50 m	18.5	6	16.000
54701.080.001	26	50 m	24	8	32.000
54701.100.001	34	50 m	28	10	50.000
54702.015.001	6.3	100 m	12	1.5	900
54702.020.001	8.4	100 m	22	2	1.250
54702.030.001	12	100 m	26	3	2.800
54702.040.001	16	50 m	32	4	6.300
54702.050.001	20	50 m	35	5	10.000
54702.060.001	24	50 m	42	6	12.500
54702.080.001	32	50 m	52	8	25.000
54702.100.001	40	50 m	65	10	40.000

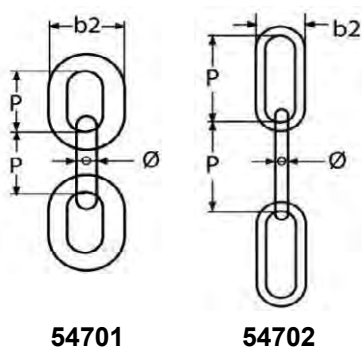

Article groups

Material	Code	Page
St.St. A4	54701	13-136
St.St. A4	54702	13-136

54701	Chain DIN 766, short link	MH11
Material	Stainless steel A4	
		

∅	☒	Art.number	∅	☒	Art.number	∅	☒	Art.number
2MM-100MTR	1	54701.020.001	5MM-50MTR*	1	54701.050.001	8MM-50MTR*	1	54701.080.001
3MM-100MTR*	1	54701.030.001	6MM-50MTR*	1	54701.060.001	10MM-50MTR*	1	54701.100.001
4MM-50MTR	1	54701.040.001						

54702	Chain DIN 763, long link	MH11
Material	Stainless steel A4	
		

∅	☒	Art.number	∅	☒	Art.number	∅	☒	Art.number
1.5MM-100MTR*	1	54702.015.001	4MM-50MTR*	1	54702.040.001	8MM-50MTR*	1	54702.080.001
2MM-100MTR*	1	54702.020.001	5MM-50MTR*	1	54702.050.001	10MM-50MTR*	1	54702.100.001
3MM-100MTR	1	54702.030.001	6MM-50MTR	1	54702.060.001			

Quick link for chains





Technical Data

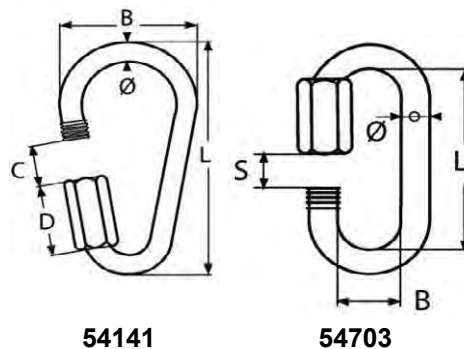

Nr.	B	C	D	L	S	∅
54141.040.061	32	11	19	61	-	4
54141.050.070	37	13	22	70	-	5
54141.060.082	42	14	25	82	-	6
54141.080.100	53	17	31	100	-	8
54141.100.118	63	20	36	118	-	10
54141.120.144	76	23	43	144	-	12
54703.040.001	12	-	-	32	5.5	4
54703.050.001	13	-	-	39	6.5	5
54703.060.001	14	-	-	45	7.5	6
54703.080.001	18	-	-	58	9.5	8
54703.100.001	22	-	-	69	12	10



Article groups

Material	Code	Page
St.St. A4	54141	13-137
St.St. A4	54703	13-137

54141 Pear shape quick link for chain								MH11
Material		Stainless steel A4						
								
ø x L	✉	Art.number	ø x L	✉	Art.number	ø x L	✉	Art.number
4X61*	10	54141.040.061	6X82*	10	54141.060.082	10X118*	5	54141.100.118
5X70*	10	54141.050.070	8X100*	10	54141.080.100	12X144*	5	54141.120.144

54703 Quick link for chains								MH11
Material		Stainless steel A4						
								
ø	✉	Art.number	ø	✉	Art.number	ø	✉	Art.number
4MM*	20	54703.040.001	6MM*	20	54703.060.001	10MM	10	54703.100.001
5MM*	20	54703.050.001	8MM*	10	54703.080.001			

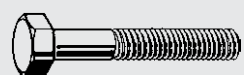

1 Bolts



2 Hexagon socket products



3 Nuts, rivet nuts & inserts



4 Threaded rods & studbolts



5 Hook & eye products



6 Screws

I Index



7 Washers & O-rings

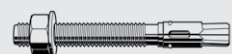

8 Anchoring products

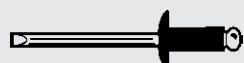

9 Rivets, pins & keys



10 Systems, furniture & security fasteners



11 Assortments & storage systems

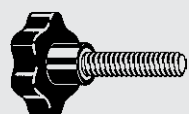

12 Engineering parts & machine parts

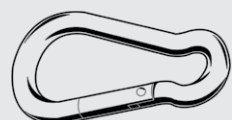

13 Maritime products

T Fastening technology

Fastening Technology

Table of contents

1	Introduction	3
2	Mechanical properties of fasteners	3
2.1	Mechanical properties of carbon and alloy steel bolts, screws and studs	3
	2.1.1 Field of application	3
	2.1.2 Designation system of property classes	4
	2.1.3 Marking of bolts, socket head cap screws and studs	4
	2.1.4 Mechanical properties of bolts, screws and studs	5
	2.1.5 Decarburization	6
	2.1.6 Minimum breaking torques	7
	2.1.7 Influence of elevated temperatures on mechanical properties	7
	2.1.8 Mechanical properties of externally threaded fasteners, low or medium (alloy) carbon steel	8
	2.1.9 Mechanical properties of externally threaded Stainless Steel Fasteners in Accordance with ASTM F593	8
2.2	Mechanical properties of carbon and low alloy steel nuts	8
	2.2.1 Field of application	9
	2.2.2 Designation system of property classes	9
	2.2.3 Marking of steel nuts	10
	2.2.4 Mechanical properties of steel nuts	10
	2.2.5 Mechanical properties of internally threaded steel fasteners, according to SAE J995	12
	2.2.6 Mechanical properties of internally threaded stainless steel fasteners, according to ASTM F594	12
2.3	Corrosion-resistant stainless steel fasteners	12
	2.3.1 Field of application	12
	2.3.2 Designation system of property classes	13
	2.3.3 Marking of austenitic stainless steel fasteners	14
	2.3.4 Mechanical and other physical properties of austenitic stainless steel fasteners	14
3	Thread	16
3.1	Metric (ISO) screw thread, coarse series – M	16
	3.1.1 Limit dimensions for metric screw thread, coarse series, fit 6H/6g	16
3.2	Metric (ISO) screw thread, fine series – MF	17
	3.2.1 Limit dimensions for metric screw thread, fine series, fit 6H/6g	17
3.3	Unified (ISO) screw thread – UNC	18
	3.3.1 Limit dimensions for unified screw thread: coarse UNC, tolerance classes 2A and 2B	18
3.4	Unified (ISO) screw thread – UNF	19
	3.4.1 Limit dimensions for unified screw thread: fine UNF, tolerance classes 2A and 2B	19
3.5	Unified (ISO) screw thread - 8UN	20
	3.5.1 Limit dimensions for unified screw thread 8UN, tolerance classes 2A and 2B	20
3.6	Unified number threads – UNC and UNF	21
	3.6.1 Limit dimensions for UNC and UNF-number thread, tolerance classes 2A and 2B	21
3.7	Screw threads, fine versus coarse thread	22
	3.7.1 Explanation	22
3.8	Metric screw threads with tolerance class Sk6 for studs	23
	3.8.1 Limit dimensions for metric screw thread with tolerance class Sk6	23
3.9	Tapping screw thread – ST	24
	3.9.1 Limit dimensions for tapping screw thread	24
	3.9.2 Thread ends for tapping screw thread	24
3.10	Metric-fine tapered external screw thread – DIN 158-1	25
	3.10.1 Limit dimensions for tapered external screw thread, short type	25
3.11	Whitworth tapered external pipe thread R – DIN 3858	26
	3.11.1 Nominal sizes for tapered external thread with tolerance 2, short type a	26
3.12	Parallel pipe thread G – ISO 228-1	27
	3.12.1 Limit dimensions for parallel pipe thread - G	27
4	Basic standards	28
4.1	Drilling sizes for tapping screws and bolts	28
	4.1.1 Application guidelines	28
	4.1.2 Application possibilities	28
	4.1.3 Guidelines for core hole diameters d_b^1	29

4.2	Core holes for thread forming screws in metals (Taptite 2000®)	31
4.2.1	Recommendations for drilled and punched holes in materials in the hardness range up to 150 HB, 500 N/mm ²	31
4.3	Core holes for thread forming screws in plastics (Remform®)	32
4.3.1	Recommendations for the geometry of holes and bosses for Remform® screws	32
4.4	Length of protrusion of bolt ends (l_p)	33
4.5	Drill sizes before tapping screw threads	33
4.5.1	General notes	33
4.5.2	Drill sizes Metric (ISO) screw thread - coarse - M	33
4.5.3	Drill sizes Metric (ISO) screw thread - fine - MF	34
4.5.4	Drill sizes Whitworth parallel pipe thread – G	34
4.6	Width across flats according to ISO	34
5	Surface coatings for fasteners	35
5.1	Introduction	35
5.1.1	Overview of coating systems	35
5.1.2	Coating thickness limits	36
5.1.3	Hydrogen embrittlement	36
5.1.4	European directives RoHS and ELV	37
5.2	Electroplating	37
5.3	Hot dip galvanizing	39
5.4	Zinc flake coatings	40
6	Inspection documents for fasteners	41
6.1	Test reports and certificates EN 10204	41
6.2	PPAP documents	42
6.3	CE-certification	43
7	Directions for the design and assembly of fastenings	44
7.1	Tightening torque tables for steel bolted joints	44
7.1.1	Assembly preload / tightening torques - coarse pitch	44
7.1.2	Assembly preload / tightening torques - fine pitch	46
7.2	Tightening torque tables for stainless steel bolted joints	47
7.2.1	Assembly preload / tightening torques	47
7.3	Coefficients of friction μ_G and μ_K	48
7.4	Tightening torque tables for steel inch threaded bolts	49
7.4.1	Assembly preload / tightening torques – UNC (coarse thread)	50
7.4.2	Assembly preload / tightening torques – UNF (fine thread)	51
7.5	Galling (seizing) of stainless steel	52
7.6	Screw-in depths for blind holes	52
7.7	Ratio of shear strength to tensile strength	52
7.8	Clamping length table for preloaded bolts HV according to EN 14399-4	53
7.9	Locking	54
7.9.1	Loss of preload	54
7.9.2	Classification of locking systems	54
7.9.3	Some practical suggestions for an optimum bolted joint	55
8	Tables	56
8.1	SI units	56
8.2	Conversion of tensile strength, Vickers, Brinell and Rockwell hardnesses	57
8.3	Contact and chemical corrosion tables	58
8.3.1	Contact corrosion table	58
8.3.2	Chemical corrosion table	59

1 Introduction

Designing and producing safe fastenings demands for professional knowledge, experience and information. Important aspects such as dimensional tolerances, mechanical and chemical properties must be considered. Also the directives for the calculation, assembly and securing of fastenings are of extreme importance. All this information is scattered over a wide range of standards, technical directives and publications in various languages.

Fabory has collected the most important technical information that is frequently consulted by product developers, designers, purchasers and contractors. A large part of this is based on international (ISO) and European (EN) standards. It is necessary to observe that although most national standards such as DIN have become obsolete and replaced by corresponding ISO or EN standards, the market situation often still requires fasteners to DIN. Where appropriate we have included information on those DIN standards as well.

The information based upon standards, is updated till September 2015. It is important to be aware that fastener manufacturers may apply a transition period from the former to the latest edition of a standard.

Of course much more technical information is available at Fabory. Please contact our technical specialists if specific information is not found in this technical section, or if more detail is required.

Also keep in mind that Fabory has the technical competence to give professional advice and help on many fastening subjects and applications. At Fabory, a team of fastener experts is devoted to help customers with safe and innovative fastening solutions.

Although all technical specifications and data have been compiled with the greatest care, the companies belonging to or affiliated to the Fabory Group accept no liability whatsoever in connection with this information and the way it is used.

2 Mechanical properties of fasteners

2.1 Mechanical properties of carbon and alloy steel bolts, screws and studs

2.1.1 Field of application

The property classes and their associated mechanical properties, as defined in ISO 898-1:2013 apply to bolts, screws and studs with metric (ISO) thread, with nominal diameters up to and including 39 mm, made of carbon steel or alloy steel and when tested at an ambient temperature range of 10°C to 35°C. Fasteners might not retain the specified mechanical and physical properties at elevated and/or lower temperatures.

They do not apply to set screws and similar threaded fasteners not under tensile stresses (ref. ISO 898-5) or to specific requirements such as weldability, corrosion resistance (stainless steel ref. ISO 3506-1), ability to withstand temperatures above 150°C or below -50°C. (ref. DIN 267-13). The class designation system may be used for other sizes (e.g. $d > 39$ mm), provided that all of the mechanical properties in the table are met. Certain fasteners might not fulfil the tensile or torsional requirement of ISO 898-1 because of the geometry of their heads (e.g. low heads, countersunk heads) or because of a reduced shank.

2.1.2 Designation system of property classes

The property class symbols, indicating the most important mechanical properties, consist of two numbers separated by a dot, for example 10.9.

The first number indicates 1/100 of the nominal tensile strength in N/mm² (see R_m in the table). So property class 10.9 has a tensile strength of $10 \times 100 = 1000$ N/mm².

The second number indicates 10 times the ratio between lower yield stress R_{el} (or proof stress $R_{p0.2}$ or non-proportional elongation R_{pf}) and the nominal tensile strength R_m (yield strength ratio).

So at property class 10.9 the second figure 9 is derived from the formula: $10 \times \frac{900}{1000}$

The nominal yield stress of this example (10.9) can easily be calculated by multiplying 10 times the product of the two property class numbers: $10 \times 10 \times 9 = 900$ N/mm².

2.1.3 Marking of bolts, socket head cap screws and studs

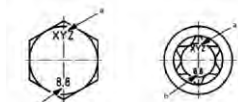

a : manufacturer's identification mark
b : property class symbol

Fig. 1

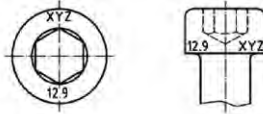

Fig. 2

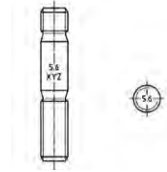

Fig. 3

- Marking is obligatory for hexagon and hexalobular bolts and screws with nominal diameter $d \geq M5$, of all property classes, preferably on top of the head (fig.1).
- Marking is obligatory for hexagon and hexalobular socket head cap screws with nominal diameter $d \geq M5$, of all property classes, preferably on top of the head (fig.2).
- When carbon steels with additives (e.g. B, Mn, Cr or Mo) are used for class 12.9, the symbol 12.9 shall be underlined: 12.9
- Studs with nominal diameter $d \geq M5$ and property classes ≥ 5.6 , shall be marked on the shaft or on the nut end (required if thread with interference fit) (fig.3). Alternative identification with symbols (fig.4) is permissible.
- Left-hand thread shall be marked for nominal diameters $d \geq M5$ with the symbol shown in figure 5, either on the top of the head or on the point. Alternative marking, as shown in figure 6, may be used for hexagon bolts and screws.
- The manufacturer's designation is mandatory on all products that are marked with property classes.
- If marking is required for other types of bolts and screws, the same marking system shall be used.
- Marking is not usual for screws with flat countersunk head, oval countersunk head, cheese head, pan head or similar that have internal driving features.
- The property class marking of fasteners with reduced loadability is preceded by "0".
Example: hexagon socket countersunk screws with property class "10.9" shall be marked "010.9".

Property class	5.6	8.8	9.8	10.9	12.9
Alternative Marking symbol	-	O	+	□	Δ

Fig. 4

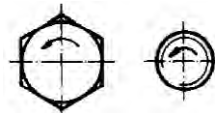

Fig. 5

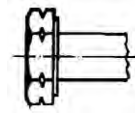

Fig. 6

2.1.4 Mechanical properties of bolts, screws and studs

Mechanical and physical properties in the below table are based on ISO 898-1:2013.

Mechanical or physical property		4.6	4.8	5.6	5.8	6.8	8.8		9.8	10.9	12.9
							d ≤ 16mm ^a	d > 16mm ^b	d ≤ 16mm		12.9
Tensile Strength, R _m , MPa	Nom. ^c	400		500		600	800		900	1000	1200
	Min.	400	420	500	520	600	800	830	900	1040	1220
Lower yield strength, R _{el} ^d , MPa	Nom. ^c	240	-	300	-						
	Min.	240	-	300	-						
Stress at 0,2% non-proportional elongation, R _{p0,2} , MPa	Nom. ^c	-					640		720	900	1080
	Min.	-					640	660	720	940	1100
Stress at 0,0048d non-proportional elongation, for full-size fasteners, R _{p1} , MPa	Nom. ^c	-	320	-	400	480	-				
	Min.	-	340 ^e	-	420 ^e	480 ^e	-				
Stress under proof load, S _p , MPa	Nom.	225	310	280	380	440	580	600	650	830	970
Percentage elongation after fracture for machined test pieces, A, %	Min.	22	-	20	-	-	12	12	10	9	8
Percentage reduction of area after fracture for Machined test pieces, Z, %	Min.	-					52		48	48	44
Elongation after fracture for full-size fasteners, A _f , %	Min.	-	0,24	-	0,22	0,20	-				
Head soundness		No fracture									
Vickers-hardness, HV (F ≥ 98N)	Min.	120	130	155	160	190	250	255	290	320	385
	Max.	220 ^g				250	320	335	360	380	435
Surface hardness, HV _{0,3}	Max.	-					h			h _i	h _j
Height of non-decarburized thread zone, E, mm	Min.	-					½ H ₁			2/3 H ₁	¾ H ₁
Depth of complete decarburization in the thread, G, mm	Max.	-					0,015				
Reduction of hardness after retempering, HV	Max.	-					20				
Breaking torque, M _B , Nm	Min.	-					According to ISO 898-7				
Impact strength, K _V ^{kl} , J	Min.	-				27	27	27	27	27	^m
Surface integrity in acc.with		ISO 6157-1 ^l									ISO 6157-3

Remarks:

- ^a Values do not apply for structural bolting
- ^b For structural bolting d ≥ M12
- ^c Nominal values are specified only for the purpose of the designations system for property classes
- ^d If the lower yield strength cannot be determined, a measurement of the stress at 0,2% non-proportional elongation is permissible
- ^e Values under investigation
- ^g Max hardness at the end of a fastener shall be max. 250 HV
- ^h Surface hardness shall not be more than 30HV_{0,3} above the measured core HV_{0,3} hardness
- ⁱ Max. 390 HV
- ^j Max. 435 HV
- ^k Test temperature -20°C
- ^l Applies to d ≥ 16mm
- ^m Value under investigation

2.1.5 Decarburization

The mechanical properties of heat treated steel are determined to a high degree by its carbon content. No air must be allowed to enter the furnaces during the hardening process of steel bolts in property classes 8.8, 10.9 and 12.9, otherwise the carbon that is present in on the surface of the steel would be oxidized by hot air.

This is the reason that the continuous furnaces for the hardening process are equipped with fire curtains, and protective gas is supplied to the furnaces to keep the oxygen level in control.

A loss of carbon content (decarburization), caused by heat treatment processes, beyond the limits specified in the table of par. 2.1.4, can reduce the strength of the thread and could cause failure.

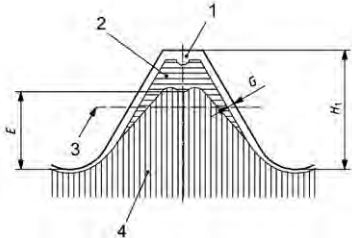

Zones of decarburization in the thread:

- 1 Completely decarburized
- 2 Partially decarburized
- 3 Pitch line
- 4 Base metal
- E Height of the non-decarburized thread zone
- G Depth of complete decarburization in the thread
- H₁ Height of external thread in maximum material condition

2.1.6 Minimum breaking torques

Often smaller screw diameters cannot be tensile tested. ISO 898-7:1995 defines the minimum breaking torques below which a bolt or screw may not rupture if clamped according to the test procedure. These values are not applicable for hexagon socket set screws.

The details below are based on ISO 898-7 (1992) & DIN 267-25 (1984, has been withdrawn)

Basic diameter	Pitch P	Property class						
		4.6	4.8	5.6	5.8	8.8	10.9	12.9
		Minimum breaking torque, in Nm according:						
		DIN 267-25				ISO 898-7*		
M1	0,25	0,020	0,020	0,024	0,024	0,033	0,040	0,045
M1,2	0,25	0,045	0,046	0,054	0,055	0,075	0,092	0,10
M1,4	0,3	0,070	0,073	0,084	0,087	0,12	0,14	0,16
M1,6	0,35	0,098	0,10	0,12	0,12	0,16	0,20	0,22
M2	0,4	0,22	0,23	0,26	0,27	0,37	0,45	0,50
M2,5	0,45	0,49	0,51	0,59	0,60	0,82	1,0	1,1
M3	0,5	0,92	0,96	1,1	1,1	1,5	1,9	2,1
M3,5	0,6	1,4	1,5	1,7	1,8	2,4	3,0	3,3
M4	0,7	2,1	2,2	2,5	2,6	3,6	4,4	4,9
M5	0,8	4,5	4,7	5,5	5,6	7,6	9,3	10
M6	1	7,6	7,9	9,1	9,4	13	16	17
M7	1	14	14	16	17	23	28	31
M8	1,25	19	20	23	24	33	40	44
M8 x 1	1	23	23	27	28	38	46	52
M10	1,5	39	41	47	49	66	81	90
M10 x 1	1	50	52	60	62	84	103	114
M10 x 1,25	1,25	44	46	53	54	74	90	100

*The values only apply to the property classes 8.8 - 10.9 and 12.9. Because of a greater spread in the test results at the property classes < 8.8 they are no longer included in the ISO 898-7.

The minimum breaking torque values given in the table shall apply to bolts and screws assigned to thread tolerance classes 6g, 6f or 6e.

2.1.7 Influence of elevated temperatures on mechanical properties

Up to a service temperature of 150°C, no detrimental effects due to a change of mechanical properties of fasteners with property classes to ISO 898-1 are known. However at temperatures over 150°C and up to a maximum temperature of 300°C, the functional performance should be ensured carefully.

With increasing temperature, a progressive reduction of lower yield strength or stress at non-proportional elongation and a reduction of tensile strength can be experienced.

The continuous operating of fasteners at elevated temperatures can result in stress relaxation, which accompanies a loss of clamp force.

DIN 267-13 defines fastener materials with specific mechanical properties for use at temperatures ranging from -200°C to +700°C.

2.1.8 Mechanical properties of externally threaded fasteners, low or medium (alloy) carbon steel

Specification	Material	Size range (in.)	Min. proof strength (psi)	Min. tensile strength (psi)	Core hardness Rockwell		Min. yield strength (psi)	Grade Identification Marketing	Compatible nuts
					Min.	Max.			
SAE J429-Grade 2	Low or medium carbon steel	¼ - ¾	55 000	74 000	B80	B100	57 000		ASTM A563 Grade A Hex
		¾ - 1½	33 000	60 000	B70	B100	36 000		
SAE J429-Grade 5	Medium carbon steel: quenched & tempered	¼ - 1	85 000	120 000	C25	C34	92 000		SAE J995 Grade 5 Hex
		1¼ - 1½	74 000	105 000	C19	C30	81 000		
SAE J429-Grade 8	Medium carbon alloy steel: quenched & tempered	¼ - 1½	120 000	150 000	C33	C39	130 000		SAE J995 Grade 8 Hex
ASTM A574 socket head cap screw	Medium carbon alloy steel: quenched & tempered	#0 - ½	140 000	180 000	C39	C45	153 000		
		½ - 4	135 000	170 000	C37	C45			
ASTM A574 socket button & flat countersunk head cap screw	Medium carbon alloy steel: quenched & tempered	#0 - ½		145 000	C39	C44			
		Over ½		135 000	C37	C44			

2.1.9 Mechanical properties of externally threaded Stainless Steel Fasteners in Accordance with ASTM F593

Stainless alloy group	Condition	Nominal Dia. (in.)	Tensile strength (psi)	Core hardness Rockwell		Min. yield strength (psi)	Grade Identification Marketing	Compatible nuts ASTM F594
				Min.	Max.			
1 (304, 304L)	CW	¼ - ⅝	100 000 - 150 000	B95	C32	65 000		F594C
		¾ - 1½	85 000 - 140 000	B80	C32	45 000		F594D
2 (316, 316L)	CW	¼ - ⅝	100 000 - 150 000	B95	C32	65 000		F594G
		¾ - 1½	85 000 - 140 000	B80	C32	45 000		F594H

CW = Annealed and cold worked
(large sizes may be hot worked and annealed)

2.2 Mechanical properties of carbon and low alloy steel nuts

2.2.1 Field of application

The property classes and their associated mechanical properties, are defined in ISO 898-2:2012 and apply to nuts *with* metric (ISO) thread, with nominal diameters up to and including 39 mm, made of carbon steel or low alloy steel and when tested at an ambient temperature range of 10 °C to 35 °C.

ISO 898-2 does not apply to nuts with specific requirements such as weldability, corrosion resistance (stainless steel ref. ISO 3506-2), ability to withstand temperatures above 300°C or below -50°C. (ref. DIN 267-13). The class designation system may be used for other sizes (e.g. $d > 39$ mm), provided that all of the mechanical properties in the table are met.

ISO 898-2 is applicable to 3 styles of nuts:

- Style 2: high nut with minimum height $m_{\min} \approx 0,9D$ or $m_{\min} > 0,9D$
- Style 1: regular nut with minimum height $m_{\min} \geq 0,8D$
- Style 0 : low nut with minimum height $0,45D \leq m_{\min} < 0,8D$

Important remark on nuts with property classes to DIN:

Nuts according to obsolete DIN standards, such as DIN 934 (with nominal heights of approximately 0,8d), cannot be loaded reliably up to the yield point of the corresponding bolt. The mechanical properties of these nuts are described in the withdrawn standard DIN 267-4. To distinguish nuts with mechanical properties according to the obsolete DIN 267-4 from ISO 898-2, their property class marking shall be between two vertical lines, e.g. |8| (ref. Par. 2.2.3).

For new designs it is highly recommended to apply nuts with property classes according to ISO standards instead of the obsolete DIN standards! Most software used for the selection of the fastener size and property class, also for the assembly conditions (torque/tension), is based upon the ISO properties, not on the (in many cases lower) DIN properties.

2.2.2 Designation system of property classes

Regular nuts (style 1) and high nuts (style 2) are marked with their property class symbol, which is the number to the left of the appropriate maximum property class of bolts, screws and studs with which they can be mated. The property class symbol of thin nuts (style 0) consists of two numbers. The first number is "0", indicating the reduced loadability of the nut compared to the loadability of regular and high nuts. The second number corresponds to 1/100 of the nominal stress under proof load on a hardened test mandrel (in N/mm²).

Property class of nut	Maximum property class of mating bolt, screw and stud	Regular nut (Style 1)	High nut (Style 2)	Thin nut (Style 0)
		Thread range		
04	(*)	-	-	M5 - M39 M8x1 - M39x3
05	(*)	-	-	M5 - M39 M8x1 - M39x3
5	5.8	M5 - M39 M8x1 - M39x3	-	
6	6.8	M5 - M39 M8x1 - M39x3	-	
8	8.8	M5 - M39 M8x1 - M39x3	M5 - M39 M8x1 - M39x3	
9	9.8	-	M5 - M39	
10	10.9	M5 - M39 M8x1 - M16x1,5	M5 - M39 M8x1 - M39x3	
12	12.9/12.9	M5 - M16	M5 - M39 M8x1 - M16x1,5	
Example of Nut style 1: ISO 4032 Example of Nut style 2: ISO 4033				

(*) Thin nuts used as jam nuts should be assembled together with a regular or a high nut. In those assemblies the thin nut is first tightened against the assembled parts and then the regular or high nut is tightened against the thin nut.

2.2.3 Marking of steel nuts

Hexagon nuts \geq M5 of all property classes shall be marked on the side or on a bearing surface with the property class designation and where technically possible the manufacturer's mark (see figure 1). Left-hand threads for nuts \geq M5 must be marked on the bearing surface with a counter-clockwise arrow or with a groove halfway up the nut (see figure 2).

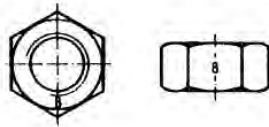

Fig.1

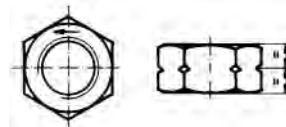

Fig.2

Important remark on nuts with property classes to DIN:

Hexagon nuts \geq M5, with mechanical properties according to the obsolete DIN 267-4, shall be marked with the symbol of the property class, a vertical bar on either side of the symbol and the manufacturer's designation on the bearing surface or flat (see figure 3).

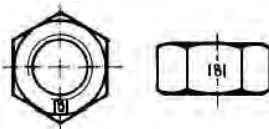

Fig.3

2.2.4 Mechanical properties of steel nuts

The details below are based on ISO 898-2:2012 and are applicable to nuts with thread to the standard tolerance class 6H. A decrease of thread stripping strength may occur for nuts with a fundamental deviation greater than zero.

Depending on the nut style, the ability to withstand the proof load overrules the hardness requirements. Therefore only the proof loads are published in this technical information.

Proof load values for nuts with coarse thread:

Thread D	Pitch P	Proof load, N Property class							
		04	05	5	6	8	9	10	12
M5	0,8	5 400	7 100	8 250	9 500	12 140	13 000	14 800	16 300
M6	1	7 640	10 000	11 700	13 500	17 200	18 400	20 900	23 100
M7	1	11 000	14 500	16 800	19 400	24 700	26 400	30 100	33 200
M8	1,25	13 900	18 300	21 600	24 900	31 800	34 400	38 100	42 500
M10	1,5	22 000	29 000	34 200	39 400	50 500	54 500	60 300	67 300
M12	1,75	32 000	42 200	51 400	59 000	74 200	80 100	88 500	100 300
M14	2	43 700	57 500	70 200	80 500	101 200	109 300	120 800	136 900
M16	2	59 700	78 500	95 800	109 900	138 200	149 200	164 900	186 800
M18	2,5	73 000	96 000	121 000	138 200	176 600	176 600	203 500	230 400
M20	2,5	93 100	122 500	154 400	176 400	225 400	225 400	259 700	294 000
M22	2,5	115 100	151 500	190 900	218 200	278 800	278 800	321 200	363 600
M24	3	134 100	176 500	222 400	254 200	324 800	324 800	374 200	423 600
M27	3	174 400	229 500	289 200	330 500	422 300	422 300	486 500	550 800
M30	3,5	213 200	280 500	353 400	403 900	516 100	516 100	594 700	673 200
M33	3,5	263 700	347 000	437 200	499 700	638 500	638 500	735 600	832 800
M36	4	310 500	408 500	514 700	588 200	751 600	751 600	866 000	980 400
M39	4	370 900	488 000	614 900	702 700	897 900	897 900	1 035 000	1 171 000

Proof load values for nuts with fine pitch thread:

Thread D x P	Proof load, N Property class						
	04	05	5	6	8	10	12
M8 x 1	14 900	19 600	27 000	30 200	37 400	43 100	47 000
M10 x 1,25	23 300	30 600	44 200	47 100	58 400	67 300	73 400
M10 x 1	24 500	32 200	44 500	49 700	61 600	71 000	77 400
M12 x 1,5	33 500	44 000	60 800	68 700	84 100	97 800	105 700
M12 x 1,25	35 000	46 000	63 500	71 800	88 000	102 200	110 500
M14 x 1,5	47 500	62 500	86 300	97 500	119 400	138 800	150 000
M16 x 1,5	63 500	83 500	115 200	130 300	159 500	185 400	200 400
M18 x 2	77 500	102 000	146 900	177 500	210 100	220 300	-
M18 x 1,5	81 700	107 500	154 800	187 000	221 500	232 200	-
M20 x 2	98 000	129 000	185 800	224 500	265 700	278 600	-
M20 x 1,5	103 400	136 000	195 800	236 600	280 200	293 800	-
M22 x 2	120 800	159 000	229 000	276 700	327 500	343 400	-
M22 x 1,5	126 500	166 500	239 800	289 700	343 000	359 600	-
M24 x 2	145 900	192 000	276 500	334 100	395 500	414 700	-
M27x 2	188 500	248 000	351 100	431 500	510 900	535 700	-
M30 x 2	236 000	310 500	447 100	540 300	639 600	670 700	-
M33 x 2	289 200	380 500	547 900	662 100	783 800	821 900	-
M36 x 3	328 700	432 500	622 800	804 400	942 800	934 200	-
M39 x 3	391 400	515 000	741 600	957 900	1 123 000	1 112 000	-

Important remark on nuts with property classes according to DIN:

The proof load stress of hexagon nuts, with mechanical properties according to the withdrawn DIN 267-4, are significantly different (in most cases lower) than those acc. ISO 898-2:

Thread D	Pitch P	Nuts with mechanical properties to the withdrawn DIN 267-4 Proof load, N Property class				
		[5]	[6]	[8]	[10]	[12]
M5	0,8	7100	8500	11 400	14 200	17 000
M6	1	10 000	12 000	16 000	20 000	24 000
M7	1	14 500	17 300	23 000	29 000	34 700
M8	1,25	18 300	22 000	29 000	36 500	43 000
M10	1,5	29 000	35 000	46 000	58 000	69 500
M12	1,75	42 100	50 500	67 000	84 000	100 000
M14	2	57 500	69 000	92 000	115 000	138 000
M16	2	78 500	94 000	136 000	157 000	188 000
M18	2,5	96 000	115 000	154 000	192 000	230 000
M20	2,5	122 000	147 000	196 000	245 000	294 000
M22	2,5	151 000	182 000	242 000	303 000	364 000
M24	3	176 000	212 000	282 000	353 000	423 000
M27	3	230 000	276 000	367 000	459 000	550 000
M30	3,5	280 000	336 000	448 000	561 000	673 000
M33	3,5	347 000	416 000	555 000	694 000	833 000
M36	4	408 000	490 000	653 000	817 000	980 000
M39	4	488 000	585 000	780 000	976 000	1 170 000

For new designs it is highly recommended to apply nuts with property classes according to ISO standards instead of the obsolete DIN standards!

2.2.5 Mechanical properties of internally threaded steel fasteners, according to SAE J995

Grade	Material	Nominal size (in.)	Proof load Stress (psi)	Rockwell hardness		Grade identification marking
				Min.	Max.	
2	Carbon steel	¼ - 1½	90 000*		C32	
			80 000**			
5	Carbon steel	¼ - 4	120 000*		C32	
			109 000**			
		1 - 1½	105 000*		C32	
			940 00**			
8	Medium carbon alloy steel: quenched & tempered	¼ - 5/8	150 000	C24	C32	
		5/8 - 1		C26	C34	
		1 - 1½		C26	C36	

* UNC and 8UN
**UNF, 12UN & finer

2.2.6 Mechanical properties of internally threaded stainless steel fasteners, according to ASTM F594

Stainless alloy group	Condition	Nominal Diameter. (in.)	Proof stress (psi)	Rockwell hardness	
				Min.	Max.
1 (304, 304L)	CW	¼ - 5/8	100 000	B95	C35
		¾ - 1½	85 000	B80	C35
2 (316, 316L)	CW	¼ - 5/8	100 000	B95	C35
		¾ - 1½	85 000	B80	C35

CW = Annealed and cold worked
(large sizes may be hot worked and annealed)

2.3 Corrosion-resistant stainless steel fasteners

2.3.1 Field of application

Mechanical properties of stainless steel fasteners are defined in ISO 3506:2009 parts 1 to 4:

Part 1: Bolts, screws and studs

Part 2: Nuts

Part 3: Set screws and similar fasteners not under tensile stress

Part 4: Tapping screws

The term "STAINLESS" steel is used to refer to a wide range of materials, all of which have at least 12% chromium (Cr) and normally also other alloying elements, with nickel (Ni) and molybdenum (Mo) being the most important. In these steels chromic oxide will be formed at the surface, which protects it from corrosion. At elevated temperatures chrome will tend to form carbides instead of oxide.

For fasteners, the extensive range of stainless steels has been subdivided according to ISO 3506 into 3 material groups based on their metallurgical structure:

Austenitic (A)

Martensitic (C)

Ferritic (F)

The martensitic and ferritic groups are of hardly any importance for commercial fasteners. The austenitic material group - also referred to as chromium-nickel steel - is the most used for fasteners and is further subdivided into 5 steel grades, each with a different resistance to corrosion and a specific field of application.

A1:

A free-cutting steel grade, having superior machinability due to a higher percentage of phosphorus and sulphur. As a consequence however, general corrosion resistance is reduced. This “free cutting” stainless steel is seldom used for mass produced fasteners.

A2:

The most frequently used stainless steel grade (for mass production of fasteners) - also called 18/8 (18% Cr, 8% Ni) - with outstanding corrosion resistance under normal atmospheric conditions, in wet environments and when exposed to oxidizing and organic acids, and many alkaline solutions.

However A2 is not suitable for use in non-oxidizing acids and agents with chloride content, i.e. in swimming pools and sea water.

A3:

This is a stabilized stainless steel with A2 properties. Due to elements Ti, Nb or Ta which reduce the binding of carbon to chromium, this steel grade is particularly suitable for use at elevated temperatures. It is relatively rarely used for mass produced fasteners.

A4:

Steels of grade A4 are “acid proof steels”, which are Mo alloyed and give a considerably better corrosion resistance in aggressive conditions such as those found in sea climates (chlorides), industrial atmospheres (sulphur dioxide), where oxidizing acids are present and if pitting may occur. However in aggressive conditions such as offshore, high chloride environment or similar applications, steels with a higher content of Cr, Ni and in particular Mo are required.

A5:

This is a stabilized stainless steel with A4 properties. Due to elements Ti, Nb or Ta which reduce the binding of carbon to chromium, this steel grade is particularly suitable for use at elevated temperatures. It is relatively rarely used for mass produced fasteners.

2.3.2 Designation system of property classes

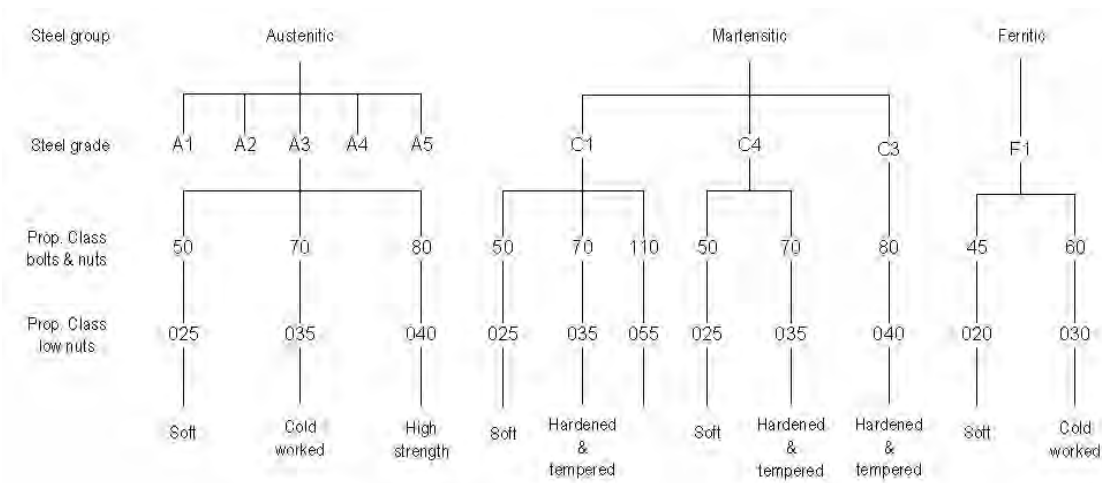

The designation of the property class represents 1/10 of the tensile strength (bolt or screw) or 1/10 of the stress under proof load for nuts. If the first digit is “0”, this indicates the nut has a reduced loadability compared to a normal nut.

2.3.3 Marking of austenitic stainless steel fasteners

Stainless steel hexagon bolts and nuts and socket cap screws of size M5 and above and all packaging shall be marked with the manufacturer's identification mark and the steel grade, followed by the two (or three) digits of the property class or as an alternative for turned nuts by grooving, see examples below. If the property class is not indicated, property class 50 or 025 applies. Low carbon austenitic stainless steel with carbon content not exceeding 0,03% may additionally be marked with an "L".

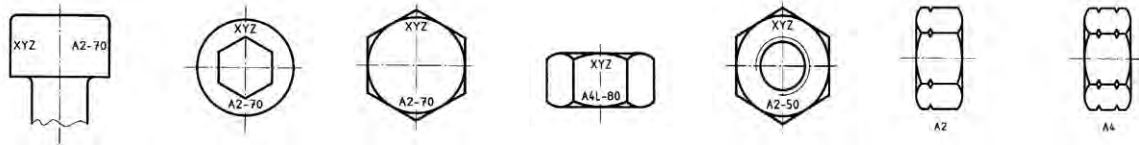

Marking of studs and other fasteners shall be agreed on by user and manufacturer.

2.3.4 Mechanical and other physical properties of austenitic stainless steel fasteners

Mechanical properties of austenitic stainless steel bolts, screws, studs and nuts:

Stainless steel		Property class	Bolts and screws			Nuts type 1
Steel group	Steel grade		Tensile strength $R_m^{(1)}$ min. N/mm ²	0.2% yield strength $R_{p0.2}^{(1)}$ min. N/mm ²	Elongation at fracture A ⁽²⁾ min. mm	Proof load value Sp min. N/mm ²
Austenitic	A1, A2, A3, A4, A5	50	500	210	0,6d	500
		70	700	450	0,4d	700
		80	800	600	0,3d	800

¹⁾ Values are calculated on the nominal stress area (ref. Thread sizes tables)

²⁾ Determined according to ISO 3506-1 on the actual screw length and not on a prepared test piece.

Minimum breaking torque in Nm for austenitic stainless steel grade bolts and screws M1,6 to M16 (coarse thread):

Nominal thread size	Property class 50	Property class 70	Property class 80
M1,6	0,15	0,2	0,24
M2	0,3	0,4	0,48
M2,5	0,6	0,9	0,96
M3	1,1	1,6	1,76
M4	2,7	3,8	4,32
M5	5,5	7,8	8,8
M6	9,3	13	15
M8	23	32	37
M10	46	65	74
M12	80	110	130
M16	210	290	330

0.2% yield strength ($R_{p0.2}$) of austenitic stainless steel at elevated temperatures:

Steel grade	+100°C	+200°C	+300°C	+400°C
A2, A3, A4, A5	85 ¹⁾	80 ¹⁾	75 ¹⁾	70 ¹⁾

¹⁾These values are given as a % of the values at room temperature. The values only apply to fasteners assigned to property classes 70 and 80.

Application at low temperatures:

Steel grade	Lower limits of operational temperature at continuous operation	
A2, A3	-200°C	
A4, A5	bolts and screws ¹⁾	-60°C
	studs	-200°C

¹⁾In connection with the alloying element Mo, the stability of the austenite is reduced and the transition temperature is shifted to higher values, if a high degree of deformation during the production of the fastener is applied.

Magnetic properties:

Austenitic stainless steel fasteners generally are non-magnetic. However after cold working, some magnetic properties may be evident. In this respect A4 is better than A2 with A1 being the most unfavourable. Some applications like those for electrotechnical equipment, and in marine and nuclear industry, require a magnetic permeability as close as possible to 1.0. Ex stock fasteners are not suitable for these purposes and special non-magnetisable steel types must be mutually agreed on.

3 Thread

3.1 Metric (ISO) screw thread, coarse series – M

Basic profile and limiting profiles

The bold lines indicate the maximum material profiles. The maximum material profile of the internal thread is the basic profile.

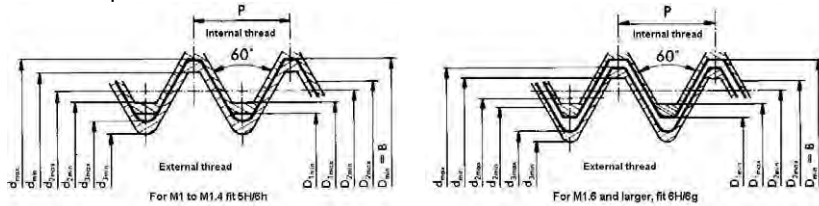

External thread **Internal thread**
 B = basic major diameter d = major diameter D = major diameter
 P = pitch d₃ = minor diameter D₁ = minor diameter
 d₂ = pitch diameter D₂ = pitch diameter

3.1.1 Limit dimensions for metric screw thread, coarse series, fit 6H/6g

The table below is based on ISO 965-1 (2013). Dimensions in mm.

Basic ²⁾ diameter	Pitch	External thread tolerance 6g ¹⁾ (bolts and screws)						Internal thread tolerance 6H ¹⁾ (nuts)				Section at minor diameter $\frac{\pi}{4} d_s^2$ A ₃₃ mm ²	Stress area $\frac{\pi}{4} \left(\frac{d_2 + d_3}{2} \right)^2$ A _s mm ²
		Major diameter		Pitch diameter		Minor diameter		Pitch diameter		Minor diameter			
B = D _{min.}	P	d _{max.}	d _{min.}	d _{2max.}	d _{2min.}	d _{3max.}	d _{3min.}	D _{2min.}	D _{2max.}	D _{1min.}	D _{1max.}	A ₃₃ mm ²	A _s mm ²
1 ¹⁾	0,25	1,000	0,933	0,838	0,785	0,693	0,630	0,838	0,894	0,729	0,785	0,337	0,460
1,1 ¹⁾	0,25	1,100	1,033	0,938	0,885	0,793	0,730	0,938	0,994	0,829	0,885	0,494	0,588
1,2 ¹⁾	0,25	1,200	1,133	1,038	0,985	0,893	0,830	1,038	1,094	0,929	0,985	0,626	0,732
1,4 ¹⁾	0,3	1,400	1,325	1,205	1,149	1,032	0,964	1,205	1,265	1,075	1,142	0,837	0,983
1,6	0,35	1,581	1,496	1,354	1,291	1,152	1,075	1,373	1,458	1,221	1,321	1,075	1,27
1,8	0,35	1,781	1,696	1,554	1,491	1,352	1,275	1,573	1,658	1,421	1,521	1,474	1,70
2	0,4	1,981	1,886	1,721	1,654	1,490	1,407	1,740	1,830	1,567	1,679	1,788	2,07
2,2	0,45	2,180	2,080	1,888	1,817	1,628	1,540	1,908	2,003	1,713	1,838	2,133	2,48
2,5	0,45	2,480	2,380	2,188	2,117	1,928	1,840	2,208	2,303	2,013	2,138	2,980	3,39
3	0,5	2,980	2,874	2,655	2,580	2,367	2,273	2,675	2,775	2,459	2,599	4,475	5,03
3,5	0,6	3,479	3,354	3,089	3,004	2,743	2,635	3,110	3,222	2,850	3,010	6,000	6,78
4	0,7	3,978	3,838	3,523	3,433	3,119	3,002	3,545	3,663	3,242	3,422	7,749	8,78
4,5	0,75	4,478	4,338	3,991	3,901	3,558	3,439	4,013	4,131	3,688	3,878	10,07	11,3
5	0,8	4,976	4,826	4,456	4,361	3,995	3,869	4,480	4,605	4,134	4,334	12,69	14,2
6	1	5,974	5,794	5,324	5,212	4,747	4,596	5,350	5,500	4,917	5,153	17,89	20,1
7	1	6,974	6,794	6,324	6,212	5,747	5,596	6,350	6,500	5,917	6,153	26,18	28,9
8	1,25	7,972	7,760	7,160	7,042	6,438	6,272	7,188	7,348	6,647	6,912	32,84	36,6
9	1,25	8,972	8,760	8,160	8,042	7,438	7,272	8,188	8,348	7,647	7,912	43,78	48,1
10	1,5	9,968	9,732	8,994	8,862	8,128	7,938	9,026	9,206	8,376	8,676	52,3	58,0
11	1,5	10,968	10,732	9,994	9,862	9,128	8,938	10,026	10,206	9,376	9,676	65,9	72,3
12	1,75	11,966	11,701	10,829	10,679	9,819	9,602	10,863	11,063	10,106	10,441	76,2	84,3
14	2	13,962	13,682	12,663	12,503	11,508	11,271	12,701	12,913	11,835	12,210	104,7	115
16	2	15,962	15,682	14,663	14,503	13,508	13,271	14,701	14,913	13,835	14,210	144,1	157
18	2,5	17,958	17,623	16,334	16,164	14,891	14,625	16,376	16,600	15,294	15,744	175,1	193
20	2,5	19,958	19,623	18,334	18,164	16,891	16,625	18,376	18,600	17,294	17,744	225,2	245
22	2,5	21,958	21,623	20,334	20,164	18,891	18,625	20,376	20,600	19,294	19,744	281,5	303
24	3	23,952	23,577	22,003	21,803	20,271	19,955	22,051	22,316	20,752	21,252	324,3	353
27	3	26,952	26,577	25,003	24,803	23,271	22,955	25,051	25,316	23,752	24,252	427,1	459
30	3,5	29,947	29,522	27,674	27,462	25,653	25,306	27,727	28,007	26,211	26,711	519,0	561
33	3,5	32,947	32,522	30,674	30,462	28,653	28,306	30,727	31,007	29,211	29,711	647,2	694
36	4	35,940	35,465	33,342	33,118	31,033	30,655	33,402	33,702	31,670	32,270	759,3	817
39	4	38,940	38,465	36,342	36,118	34,033	33,655	36,402	36,702	34,670	35,270	913	976
42	4,5	41,937	41,437	39,014	38,778	36,416	36,007	39,077	39,392	37,129	37,799	1045	1121
45	4,5	44,937	44,437	42,014	41,778	39,416	39,007	42,077	42,392	40,129	40,799	1224	1306
48	5	47,929	47,399	44,681	44,431	41,795	41,352	44,752	45,087	42,587	43,297	1377	1473
52	5	51,929	51,399	48,681	48,431	45,795	45,352	48,752	49,087	46,587	47,297	1652	1758
56	5,5	55,925	55,365	52,353	52,088	49,177	48,700	52,428	52,783	50,046	50,796	1905	2030
60	5,5	59,925	59,365	56,353	56,088	53,177	52,700	56,428	56,783	54,046	54,796	2227	2362
64	6	63,920	63,320	60,023	59,743	56,559	56,048	60,103	60,478	57,505	58,305	2520	2676
68	6	67,920	67,320	64,023	63,743	60,559	60,048	64,103	64,478	61,505	62,305	2888	3055

¹⁾ The values for basic diameters 1 to 1.4 mm correspond to the fit 5H/6h.

²⁾ Metric screw thread is designated by the basic diameter, preceded by the profile letter M and followed by the tolerance grade, e.g. 6, and the tolerance position, e.g. g. Example: M10-6g. If no tolerance class is indicated, the above mentioned fits are valid. For basic diameters above 68mm. See metric screw thread, fine series.

3.2 Metric (ISO) screw thread, fine series – MF

Basic profile and limiting profiles

The bold lines indicate the maximum material profiles. The maximum material profile of the internal thread is the basic profile.

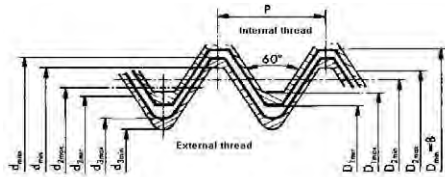

B = basic major diameter
P = pitch

External thread
d = major diameter
d₃ = minor diameter
d₂ = pitch diameter

Internal thread
D = major diameter
D₁ = minor diameter
D₂ = pitch diameter

3.2.1 Limit dimensions for metric screw thread, fine series, fit 6H/6g

The table below is based on ISO 965-1 (2013). Dimensions in mm.

Basic ²⁾ diameter	Pitch	External thread tolerance 6g ¹⁾ (bolts and screws)						Internal thread tolerance 6H ¹⁾ (nuts)				Section at minor diameter $\frac{\pi}{4} d_3^2$ A _s , mm ²	Stress area $\frac{\pi}{4} \left(\frac{d_2 + d_3}{2} \right)^2$ A _s , mm ²
		Major diameter		Pitch diameter		Minor diameter		Pitch diameter		Minor diameter			
B = D _{min.}	P	d _{max.}	d _{min.}	d _{2max.}	d _{2min.}	d _{3max.}	d _{3min.}	D _{2min.}	D _{2max.}	D _{1min.}	D _{1max.}	A _s , mm ²	A _s , mm ²
6	0,75	5,978	5,838	5,491	5,391	5,058	4,929	5,513	5,645	5,188	5,378	20,27	22,0
8	1	7,974	7,794	7,324	7,212	6,747	6,596	7,350	7,500	6,917	7,153	36,03	39,2
10	1	9,974	9,794	9,324	9,212	8,747	8,596	9,350	9,500	8,917	9,153	60,45	64,5
10	1,25	9,972	9,760	9,160	9,042	8,438	8,272	9,188	9,348	8,647	8,912	56,29	61,2
12	1	11,974	11,794	11,324	11,206	10,747	10,590	11,350	11,510	10,917	11,153	91,15	96,1
12	1,25	11,972	11,760	11,160	11,028	10,438	10,258	11,188	11,368	10,647	10,912	86,03	92,1
12	1,5	11,968	11,732	10,994	10,854	10,128	9,930	11,026	11,216	10,376	10,676	81,07	88,1
14	1,5	13,968	13,732	12,994	12,854	12,128	11,930	13,026	13,216	12,376	12,676	116,1	125
16	1,5	15,968	15,732	14,994	14,854	14,128	13,930	15,026	15,216	14,376	14,676	157,5	167
18	1,5	17,968	17,732	16,994	16,854	16,128	15,930	17,026	17,216	16,376	16,676	205,1	216
18	2	17,962	17,682	16,663	16,503	15,508	15,271	16,701	16,913	15,835	16,210	189,8	204
20	1,5	19,968	19,732	18,994	18,854	18,128	17,930	19,026	19,216	18,376	18,676	259,0	272
20	2	19,962	19,682	18,663	18,503	17,508	17,271	18,701	18,913	17,835	18,210	241,8	258
22	1,5	21,968	21,732	20,994	20,854	20,128	19,930	21,026	21,216	20,376	20,676	319,2	333
22	2	21,962	21,682	20,663	20,503	19,508	19,271	20,701	20,913	19,835	20,210	300,1	318
24	1,5	23,968	23,732	22,994	22,844	22,128	21,920	23,026	23,226	22,376	22,676	385,7	401
24	2	23,962	23,682	22,663	22,493	21,508	21,261	22,701	22,925	21,835	22,210	364,6	384
27	1,5	26,968	26,732	25,994	25,844	25,128	24,920	26,026	26,226	25,376	25,676	497,2	514
27	2	26,962	26,682	25,663	25,493	24,508	24,261	25,701	25,925	24,835	25,210	473,2	496
30	1,5	29,968	29,732	28,994	28,844	28,128	27,920	29,026	29,226	28,376	28,676	622,8	642
30	2	29,962	29,682	28,663	28,493	27,508	27,261	28,701	28,925	27,835	28,210	596,0	621
33	1,5	32,968	32,732	31,994	31,844	31,128	30,920	32,026	32,226	31,376	31,676	762,6	784
33	2	32,962	32,682	31,663	31,493	30,508	30,261	31,701	31,925	30,835	31,210	732,8	761
36	1,5	35,968	35,732	34,994	34,844	34,128	33,920	35,026	35,226	34,376	34,676	916,5	940
36	3	35,952	35,682	34,003	33,803	32,271	31,955	34,051	34,316	32,752	33,252	820,4	865
39	1,5	38,968	38,732	37,994	37,844	37,128	36,920	38,026	38,226	37,376	37,676	1085	1110
39	3	38,952	38,577	37,003	36,803	35,271	34,955	37,051	37,316	35,752	36,252	979,7	1028
42	1,5	41,968	41,732	40,994	40,844	40,128	39,920	41,026	41,226	40,376	40,676	1267	1294
42	3	41,952	41,577	40,003	39,803	38,271	37,955	40,051	40,316	38,752	39,252	1153	1206
45	1,5	44,968	44,732	43,994	43,844	43,128	42,920	44,026	44,226	43,376	43,676	1463	1492
45	3	44,952	44,577	43,003	42,803	41,276	40,955	43,051	43,316	41,752	42,252	1341	1398
48	1,5	47,968	47,732	46,994	46,834	46,128	45,910	47,026	47,238	46,376	46,676	1674	1705
48	3	47,952	47,577	46,003	45,791	44,271	43,943	46,051	46,331	44,752	45,252	1543	1604
52	1,5	51,968	51,732	50,994	50,834	50,128	49,910	51,026	51,238	50,376	50,676	1976	2010
52	3	51,952	51,577	50,003	49,791	48,271	47,943	50,051	50,331	48,752	49,252	1834	1900
56	2	55,962	55,682	54,663	54,483	53,508	53,251	54,701	54,937	53,835	54,210	2252	2301
56	4	55,940	55,465	53,342	53,106	51,033	50,643	53,402	53,717	51,670	52,270	2050	2144
60	4	59,940	59,465	57,342	57,106	55,033	54,643	57,402	57,717	55,670	56,270	2384	2485
64	4	63,940	63,465	61,342	61,106	59,033	58,643	61,402	61,717	59,670	60,270	2743	2851
68	4	67,940	67,465	65,342	65,106	63,033	62,643	65,402	65,717	63,670	64,270	3127	3242
72	6	71,920	71,320	68,023	67,743	64,559	64,048	68,103	68,478	65,505	66,305	3287	3463
76	6	75,920	75,320	72,023	71,743	68,559	68,048	72,103	72,478	69,505	70,305	3700	3889
80	6	79,920	79,320	76,023	75,743	72,559	72,048	76,103	76,478	73,505	74,305	4144	4344
90	6	89,920	89,320	86,023	85,743	82,559	82,048	86,103	86,478	83,505	84,305	5364	5590
100	6	99,920	99,320	96,023	95,723	92,559	92,028	96,103	96,503	93,505	94,305	6740	7000
110	6	109,920	109,320	106,023	105,723	102,559	102,028	106,103	106,503	103,505	104,305	8273	8560

¹⁾ For coated threads the maximum values of d, d₂ and d₃ are equal to the values of the basic profile. (d_{2max.} = D_{2min.} and d_{3max.} = D_{3min.})

²⁾ Metric screw thread, fine series, are designated by the basic diameter, preceded by the profile letter M and followed by the pitch separated by an x and then by the tolerance grade, e.g. 6, and the tolerance position, e.g. H. Example: M10x1,25-6H. If no tolerance class is mentioned, the fit 6H/6g applies.

3.3 Unified (ISO) screw thread – UNC

Basic profile and limiting profiles

The bold lines indicate the maximum material profiles. The maximum material profile of the internal thread is the basic profile.

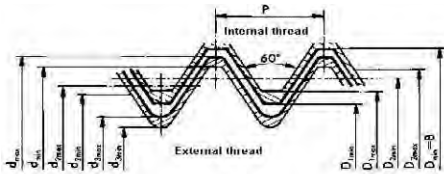

External thread
 d = major diameter
 d_3 = minor diameter
 d_2 = pitch diameter
Internal thread
 D = major diameter
 D_1 = minor diameter
 D_2 = pitch diameter

3.3.1 Limit dimensions for unified screw thread: coarse UNC, tolerance classes 2A and 2B

The table below is based on ISO 5864 (1993). Dimensions in mm.

Basic diameter	No. of threads	External thread tolerance 2A (bolts and screws)						Internal thread tolerance 2B (nuts)				Section at minor diameter	Stress area	
		Major diameter		Pitch diameter		Minor diameter		Major diameter	Pitch diameter	Minor diameter		$\frac{\pi}{4} d_3^2$	$\frac{\pi}{4} \left(\frac{d_2 + d_3}{2} \right)^2$	
B inch	N	$d_{max.}$	$d_{min.}$	$d_{2max.}$	$d_{2min.}$	$d_{3max.}$	$d_{3min.}$	$D_{min.}$	$D_{2min.}$	$D_{2max.}$	$D_{1min.}$	$D_{1max.}$	A_{d3} mm ²	A_s mm ²
1/4	20	6,322	6,117	5,496	5,403	4,765	4,580	6,350	5,525	5,646	4,979	5,257	17,4	20,5
5/16	18	7,907	7,687	6,990	6,889	6,174	5,972	7,938	7,021	7,155	6,401	6,731	29,3	33,8
3/8	16	9,491	9,254	8,460	8,349	7,543	7,318	9,525	8,494	8,638	7,798	8,153	43,7	50
7/16	14	11,076	10,816	9,898	9,779	8,851	8,603	11,113	9,934	10,088	9,144	9,550	60,2	68,6
1/2	13	12,661	12,386	11,391	11,265	10,264	9,998	12,700	11,430	11,595	10,592	11,023	81,1	91,5
5/8	12	14,246	13,958	12,872	12,741	11,650	11,367	14,288	12,914	13,086	11,989	12,446	105	117,4
3/4	11	15,834	15,528	14,335	14,197	13,002	12,698	15,875	14,377	14,559	13,386	13,868	130	146
7/8	10	19,004	18,677	17,353	17,204	15,887	15,555	19,050	17,399	17,594	16,307	16,840	195	215
1	9	22,176	21,824	20,342	20,183	18,714	18,352	22,225	20,392	20,599	19,177	19,761	270	298
1.1/8	8	25,349	24,969	23,286	23,114	21,452	21,052	25,400	23,338	23,561	21,971	22,606	355	391
1 1/8	7	28,519	28,103	26,162	25,980	24,066	23,623	28,575	26,218	26,456	24,638	25,349	447	492
1 1/4	7	31,694	31,278	29,337	29,150	27,241	26,792	31,750	29,393	29,636	27,813	28,524	574	625
1 3/8	6	34,864	34,402	32,113	31,911	29,669	29,162	34,925	32,175	32,438	30,353	31,115	680	745
1 1/2	6	38,039	37,577	35,288	35,083	32,844	32,335	38,100	35,350	35,615	33,528	34,290	835	906
1 3/4	5	44,381	43,861	41,081	40,856	38,148	37,557	44,450	41,151	41,445	38,964	39,827	1123	1226
2	4 1/2	50,726	50,168	47,061	46,820	43,802	43,155	50,800	47,135	47,449	44,679	45,593	1484	1613
2 1/4	4 1/2	57,076	56,518	53,411	53,165	50,152	49,500	57,150	53,485	53,804	51,029	51,943	1948	2097
2 1/2	4	63,421	62,817	59,296	59,033	55,631	54,910	63,500	59,376	59,717	56,617	57,581	2400	2581
2 3/4	4	69,768	69,165	65,643	65,378	61,978	61,255	69,850	65,726	66,073	62,967	63,931	2981	3181
3	4	76,118	75,515	71,993	71,722	68,328	67,600	76,200	72,076	72,428	69,317	70,281	3626	3852

Unified screw thread is designated by the nominal diameter followed by the number of threads per inch (n), the thread series UNC and the tolerance class. E.g.: 3/8 – 16 UNC – 2A. If no tolerance class is specified, the fit 2A/2B applies.

For coated external threads, the maximum values of d , d_2 and d_3 are equal to the values of the basic profile: ($d_{2max.} = D_{2min.}$ and $d_{3max.} = D_{1min.}$)

3.4 Unified (ISO) screw thread – UNF

Basic profile and limiting profiles

The bold lines indicate the maximum material profiles. The maximum material profile of the internal thread is the basic profile.

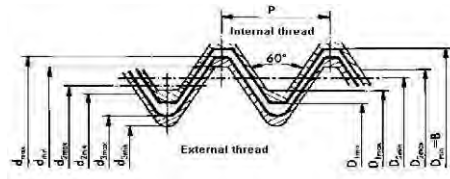

B = basic major diameter

P = pitch

N = number of threads per inch

External thread

d = major diameter

d₃ = minor diameter

d₂ = pitch diameter

Internal thread

D = major diameter

D₁ = minor diameter

D₂ = pitch diameter

3.4.1 Limit dimensions for unified screw thread: fine UNF, tolerance classes 2A and 2B

The table below is based on ISO 5864 (1993). Dimensions in mm.

Basic diameter	No. of threads	External thread tolerance 2A (bolts and screws)						Internal thread tolerance 2B (nuts)					Section at minor diameter	Stress area
		Major diameter		Pitch diameter		Minor diameter		Major diameter	Pitch diameter	Minor diameter		$\frac{\pi}{4} d_3^2$	$\frac{\pi}{4} \left(\frac{d_2 + d_3}{2} \right)^2$	
B inch	N	d _{max.}	d _{min.}	d _{2max.}	d _{2min.}	d _{3max.}	d _{3min.}	D _{min.}	D _{2min.}	D _{2max.}	D _{1min.}	D _{1max.}	A _{d3} mm ²	A _s mm ²
1/4	28	6,324	6,160	5,735	5,652	5,212	5,063	6,350	5,761	5,869	5,360	5,588	21,0	23,5
5/16	24	7,909	7,727	7,221	7,128	6,611	6,442	7,938	7,250	7,371	6,782	7,035	33,8	37,4
3/8	24	9,497	9,315	8,808	8,713	8,199	8,027	9,525	8,837	8,961	8,382	8,636	52,2	56,6
7/16	20	11,079	10,874	10,253	10,148	9,522	9,325	11,113	10,287	10,424	9,729	10,033	70,3	76,6
1/2	20	12,666	12,462	11,841	11,733	11,109	10,910	12,700	11,875	12,016	11,329	11,607	95,9	103
5/8	18	14,251	14,031	13,335	13,221	12,519	12,304	14,288	13,371	13,520	12,751	13,081	122	131
3/4	18	15,839	15,619	14,922	14,804	14,107	13,887	15,875	14,959	15,110	14,351	14,681	155	165
7/8	16	19,011	18,774	17,980	17,854	17,063	16,823	19,050	18,019	18,183	17,323	17,678	226	241
1 1/8	14	22,184	21,923	21,005	20,869	19,959	19,693	22,225	21,047	21,224	20,270	20,675	310	328
1.1N.	12	25,354	25,065	23,980	23,831	22,758	22,457	25,400	24,026	24,218	23,114	23,571	403	428
1.1N.	14	25,357	25,095	24,178	24,036	23,123	22,800	24,220	24,407	23,444	23,825	-	420	439
1 1/4	12	28,529	28,240	27,155	27,003	25,933	25,629	28,575	27,201	27,398	26,289	26,746	524	552
1 1/2	12	31,704	31,415	30,330	30,173	29,108	28,799	31,750	30,376	30,579	29,464	29,921	661	692
1 3/8	12	34,879	34,588	33,502	33,343	32,280	31,969	34,925	33,551	33,759	32,639	33,096	813	848
1 1/2	12	38,051	37,763	36,677	36,516	35,455	35,141	38,100	36,726	36,936	35,814	36,271	981	1020

Unified screw thread is designated by the basic diameter followed by the number of threads per inch (n), the thread series UNF and the tolerance class. E.g.: 3/8 – 24 UNF – 2A. If no tolerance class is specified, the fit 2A/2B applies.

For coated external threads, the maximum values of d, d₂ and d₃ are equal to the values of the basic profile: (d_{2max.} = D_{2min.} and d_{3max.} = D_{1min.})

3.5 Unified (ISO) screw thread - 8UN

Basic profile and limiting profiles

The bold lines indicate the maximum material profiles. The maximum material profile of the internal thread is the basic profile.

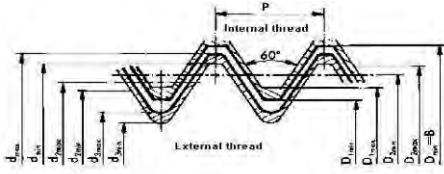

B = basic major diameter	External thread d = major diameter d ₃ = minor diameter d ₂ = pitch diameter	Internal thread D = major diameter D ₁ = minor diameter D ₂ = pitch diameter
P = pitch		
N = number of threads per inch		

3.5.1 Limit dimensions for unified screw thread 8UN, tolerance classes 2A and 2B

The table below is based on ISO 5864 (1993). Dimensions in mm.

Basic diameter	No. of threads	External thread tolerance 2A (bolts and screws)					Internal thread tolerance 2B (nuts)					Section at minor diameter	Stress area
		Major diameter		Pitch diameter		Minor diameter	Major diameter	Pitch diameter		Minor diameter	$\frac{\pi}{4} d_s^2$	$\frac{\pi}{4} \left(\frac{d_2 + d_3}{2} \right)^2$	
B inch	N	d _{max.}	d _{min.}	d _{2max.}	d _{2min.}	nominal	D _{min.}	D _{2min.}	D _{2max.}	D _{1min.}	D _{1max.}	A _{s3} mm ²	A _s mm ²
1/8	8	28,521	28,141	26,459	26,284	24,653	28,575	26,513	26,741	25,146	25,781	470	510
1/4	8	31,697	31,316	29,634	29,456	27,800	31,750	29,688	29,921	28,321	28,956	599	645
3/8	8	34,869	34,488	32,807	32,624	30,973	34,925	32,863	33,099	31,496	32,131	745	795
1/2	8	38,044	37,663	35,982	35,796	34,148	38,100	36,038	36,279	34,671	35,306	906	963
5/8	8	41,219	40,838	39,157	38,969	37,323	41,275	39,213	39,459	37,846	38,481	1084	1148
3/4	8	44,392	44,011	42,329	42,139	40,495	44,450	42,388	42,636	41,021	41,656	1277	1342
7/8	8	47,567	47,186	45,504	45,309	43,670	47,625	45,563	45,817	44,196	44,831	1484	1555
2.IN.	8	50,742	50,361	48,679	48,481	46,845	50,800	48,738	48,994	47,371	47,371	1710	1787

Unified screw thread is designated by the basic diameter followed by the number of threads per inch (n), the thread series UN and the tolerance class. E.g.: 1.3/8 – 8UN – 2A. If no tolerance class is specified, the fit 2A/2B applies.

For coated external threads, the maximum values of d, d2 and d3 are equal to the values of the basic profile: (d_{2max.} = D_{2min.} and d_{3max.} = D_{1min.})

3.6 Unified number threads – UNC and UNF

Basic profile and limiting profiles

The bold lines indicate the maximum material profiles. The maximum material profile of the internal thread is the basic profile.

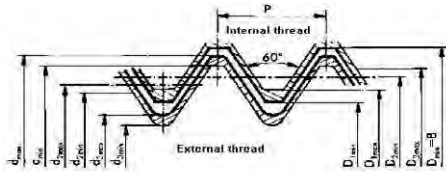

B = basic major diameter

P = pitch

N = number of threads per inch

External thread

d = major diameter

d₃ = minor diameter

d₂ = pitch diameter

Internal thread

D = major diameter

D₁ = minor diameter

D₂ = pitch diameter

3.6.1 Limit dimensions for UNC and UNF-number thread, tolerance classes 2A and 2B

The table below is based on ISO 5864 (1993). Dimensions in mm.

Designation	Basic diameter	No. of threads	External thread tolerance 2A (bolts and screws)					Internal thread tolerance 2B (nuts)				
			Major diameter		Pitch diameter		Minor diameter	Pitch diameter		Minor diameter		
			d_{max.}	d_{min.}	d_{2max.}	d_{2min.}	d_{3max.}	D_{2min.}	D_{2max.}	D_{1min.}	D_{1max.}	
2-56 UNC	2,184	56	2,169	2,066	1,874	1,822	1,612	1,890	1,960	1,695	1,871	
3-48 UNC	2,514	48	2,496	2,383	2,153	2,096	1,846	2,172	2,247	1,941	2,146	
4-40 UNC	2,844	40	2,824	2,695	2,413	2,350	2,044	2,434	2,517	2,157	2,385	
5-40 UNC	3,175	40	3,154	3,026	2,743	2,678	2,374	2,764	2,847	2,487	2,697	
6-32 UNC	3,505	32	3,484	3,333	2,969	2,899	2,512	2,990	3,083	2,642	2,895	
8-32 UNC	4,165	32	4,142	3,991	3,627	3,554	3,169	3,650	3,746	3,302	3,530	
10-24 UNC	4,826	24	4,800	4,618	4,112	4,029	3,502	4,138	4,246	3,683	3,962	
12-24 UNC	5,486	24	5,461	5,279	4,772	4,687	4,163	4,799	4,909	4,344	4,597	
4-48 UNF	2,844	48	2,827	2,713	2,484	2,424	2,176	2,502	2,580	2,271	2,458	
5-44 UNF	3,175	44	3,157	3,036	2,781	2,718	2,448	2,800	2,880	2,551	2,740	
6-40 UNF	3,505	40	3,484	3,356	3,073	3,008	2,705	3,094	3,180	2,820	3,022	
8-36 UNF	4,165	36	4,145	4,006	3,688	3,617	3,279	3,709	3,799	3,404	3,606	
10-32 UNF	4,826	32	4,803	4,651	4,287	4,212	3,830	4,311	4,409	3,963	4,165	
12-28 UNF	5,486	28	5,461	5,296	4,871	4,791	4,348	4,898	5,003	4,496	4,724	

3.7 Screw threads, fine versus coarse thread

3.7.1 Explanation

The general trend for commercial fasteners has shown a gradual and noticeable shift in popularity towards coarse threads. And rightly so, as there are increasingly less reasons to justify the use of fine threads. Although fine threads are used in special cases (such as for adjusters, or for certain engine screws), these cases occur so infrequently that fasteners with fine thread are becoming more and more a special product with all the attendant economic disadvantages (higher price, poor availability, double stocking). The fine screw thread was mainly created for, and is still popular in, the automotive industry - and other related industries.

The most important arguments of the proponents of fine thread are:

- higher static tensile strength because of the thread's larger stress area
- because of the smaller helix angle, it offers more resistance to loosening when subjected to vibration
- improved adjustment accuracy

In practice however, most constructions are not loaded statically but dynamically, so fatigue strength is the criterion. Coarse thread exhibits better fatigue resistance because stress concentration at the root decreases as thread pitch increases. The argument of better resistance to loosening has been outdated by the development of mechanical and chemical locking systems, which offer a more effective solution for loss of preload especially when the fastener is exposed to dynamic transverse forces.

Further advantages of coarse thread are:

- less sensitive to damage, and generally easier and quicker assembly
- thicker coatings possible as a consequence of the larger thread allowances
- less danger of thread being stripped

The most important pros and cons are summarised in the following evaluation table:

functional properties	screw thread coarse ¹⁾	screw thread fine
Static strength	+	++
Dynamic strength	+	-
Resistance to loosening	-	+
Insensitive to damage	+	-
Coating thickness	+	-
Insensitive to being stripped	+	-
Ease of assembly	+	-
Low cost/availability	+	-

¹⁾ Coarse thread is recommended for standardized fasteners in general constructions.

3.8 Metric screw threads with tolerance class Sk6 for studs

Basic profile and limiting profiles

The bold line indicates the minimum material profile.

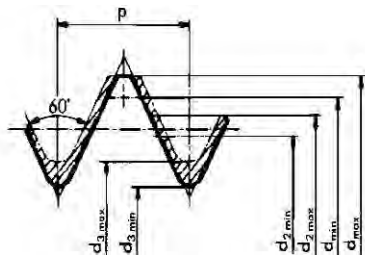

P = Pitch
d = major diameter = basic size
 d_2 = pitch diameter
 d_3 = minor diameter

The tolerance class Sk6 is used for general applications e.g. the inserted end of studs as per DIN 939 (joints without a seal function) and in combination with internal thread, with the tolerance class fine (4H respectively, 4H5H) as per DIN 13 Part 14. In fact, these tolerance classes for the pitch diameter have to do with a transition fit, because in many cases no actual interference fit will be achieved.

Note:

A true interference fit for metric threads has been developed (MFS), which is achieved by including the oversize in the major diameter. Refer to DIN 8141 Part 1 for the tolerances and to DIN 8141 Part 2 for the associated sizes of the threads. However, these norms only apply to applications in aluminium cast alloys for the sizes M5 through M16. Further developments are dependent on the experience gained.

3.8.1 Limit dimensions for metric screw thread with tolerance class Sk6

The table below is based on DIN 13-51 (2013). Dimensions in mm.

Basic diameter	Pitch	external thread (studs)					
		Major diameter		Pitch diameter		Minor diameter	
d	P	$d_{max.}$	$d_{min.}$	$d_{2max.}$	$d_{2min.}$	$d_{3max.}$	$d_{3min.}$
6	1	6	5,776	5,406	5,335	4,773	4,663
(7) ¹⁾	1	7	6,776	6,406	6,335	5,773	5,633
8	1,25	8	7,750	7,244	7,173	6,466	6,343
(9) ¹⁾	1,25	9	8,750	8,244	8,173	7,466	7,343
10	1,5	10	9,720	9,082	9,011	8,160	8,017
(11) ¹⁾	1,5	11	10,720	10,082	10,011	9,160	9,017
12	1,75	12	11,600	10,943	10,843	9,853	9,691
14	2	14	13,525	12,781	12,681	11,546	11,369
16	2	16	15,525	14,781	14,681	13,546	13,369
18	2,5	18	17,470	16,456	16,356	14,933	14,731
20	2,5	20	19,470	18,456	18,356	16,933	16,731
22	2,5	22	21,470	20,456	20,356	18,933	18,731
24	3	24	23,400	22,131	22,031	20,319	20,078

¹⁾ Preferably not to be used

Designation of this screw thread e.g. M12 Sk6

3.9 Tapping screw thread – ST

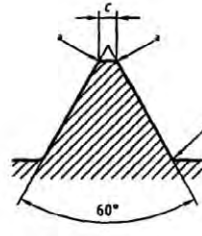
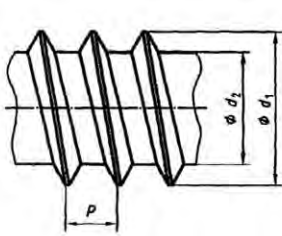

Edges slightly radiused at (a)

3.9.1 Limit dimensions for tapping screw thread

The table below is based on ISO 1478 (1999). Dimensions in mm.

Basic diameter	No.	Pitch	Major diameter		Minor diameter		flat end diameter		crest flattening $c_{max.}$	point taper length y_{max}		
			$d_{1max.}$	$d_{1min.}$	$d_{2max.}$	$d_{2min.}$	$d_{3max.}$	$d_{3min.}$		Type C	Type F	Type R
ST 2,2	2	0,8	2,24	2,1	1,63	1,52	1,47	1,37	0,1	2	1,6	--
ST 2,6	3	0,9	2,57	2,43	1,9	1,8	1,73	1,6	0,1	2,3	1,8	--
ST 2,9	4	1,1	2,9	2,76	2,18	2,08	2,01	1,88	0,1	2,6	2,1	--
ST 3,3	5	1,3	3,3	3,12	2,39	2,29	2,21	2,08	0,1	3	2,5	--
ST 3,5	6	1,3	3,53	3,35	2,64	2,51	2,41	2,26	0,1	3,2	2,5	2,7
ST 3,9	7	1,4	3,91	3,73	2,92	2,77	2,67	2,51	0,1	3,5	2,7	3
ST 4,2	8	1,4	4,22	4,04	3,10	2,95	2,84	2,69	0,1	3,7	2,8	3,2
ST 4,8	10	1,6	4,8	4,62	3,58	3,43	3,3	3,12	0,15	4,3	3,2	3,6
ST 5,5	12	1,8	5,46	5,28	4,17	3,99	3,86	3,68	0,15	5	3,6	4,3
ST 6,3	14	1,8	6,25	6,03	4,88	4,7	4,55	4,34	0,15	6	3,6	5
ST 8	16	2,1	8	7,78	6,2	5,99	5,84	5,64	0,15	7,5	4,2	6,3

3.9.2 Thread ends for tapping screw thread

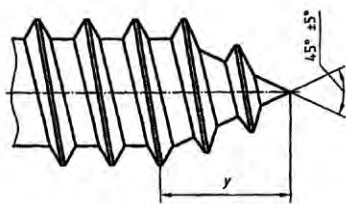

Type C (Cone)

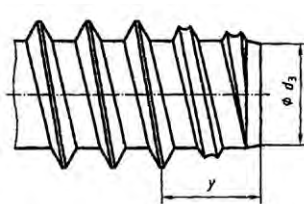

Type F (Flat)

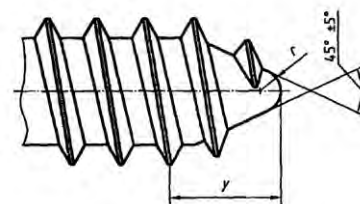

Type R (Rounded)

3.10 Metric-fine tapered external screw thread – DIN 158-1



Metric-fine tapered external screw thread is intended to be used for liquid-/gas- tight joints such as pipe plugs as per DIN 906, lubricating nipples, etc. Up to and including M26 no sealing medium is required for oils, other liquids and gases; for sizes above M26 a sealing medium is recommended on the thread. The tapered external thread is normally combined with parallel internal thread as per DIN 158. The metric-fine tapered external thread is designated by the basic diameter, preceded by the profile letter M and followed by the pitch, separated by an “x”. E.g.: M 20x1.5.

3.10.1 Limit dimensions for tapered external screw thread, short type

The table below is based on DIN 158-1 (1997). Dimensions in mm.

Basic diameter x P	Major diameter		Pitch diameter		Minor diameter		Gauge length b	Useful Thread length l ₁
	d _{max.}	d _{min.}	d _{2max.}	d _{2min.}	d _{1max.}	d _{1min.}		
M 8x1	8,093	8,033	7,443	7,383	6,866	6,806	3	4
M 10x1	10,093	10,033	9,443	9,383	8,866	8,806	3	4
M 12x1,5	12,235	12,141	11,261	11,167	10,395	10,301	5,5	7,5
M 14x1,5	14,235	14,141	13,261	13,167	12,395	12,301	5,5	7,5
M 16x1,5	16,235	16,141	15,261	15,167	14,395	14,301	5,5	7,5
M 18x1,5	18,235	18,141	17,261	17,167	16,395	16,301	5,5	7,5
M 20x1,5	20,235	20,141	19,261	19,167	18,395	18,301	5,5	7,5
M 22x1,5	22,235	22,141	21,261	21,167	20,395	20,301	5,5	7,5
M 24x1,5	24,235	24,141	23,261	23,167	22,395	22,301	5,5	7,5
M 30x1,5	30,235	30,141	29,261	29,167	28,395	28,301	5,5	7,5
M 36x1,5	36,282	36,141	35,308	35,182	34,442	34,316	6,9	9
M 42x1,5	42,282	42,156	41,308	41,182	40,442	40,316	6,9	9

3.11 Whitworth tapered external pipe thread R – DIN 3858

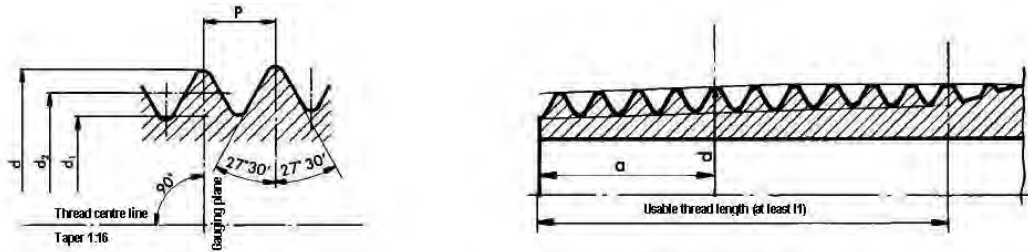

3.11.1 Nominal sizes for tapered external thread with tolerance 2, short type a

The table below is based on DIN 3858 (2005). Dimensions in mm.

Designation	Number of threads N	Pitch P	external thread				
			Major diameter d	Pitch diameter d ₂	Minor diameter d ₁	Gauge length a	Useful thread length l ₁
R $\frac{1}{8}$	28	0,907	9,728	9,147	8,566	3	5,5
R $\frac{1}{4}$	19	1,337	13,157	12,301	11,445	4,5	8,2
R $\frac{3}{8}$	19	1,337	16,662	15,806	14,950	4,5	8,2
R $\frac{1}{2}$	14	1,814	20,955	19,793	18,631	5	10,0
R $\frac{3}{4}$	14	1,814	26,441	25,279	24,117	6	11,0
R1	11	2,309	33,249	31,770	30,291	7	13,4
R1 $\frac{1}{4}$	11	2,309	41,910	40,431	38,952	7,5	13,9
R1 $\frac{1}{2}$	11	2,309	47,803	46,324	44,845	7,5	13,9

The Whitworth tapered external pipe thread is designated by the profile letter R, followed by the basic diameter in inches, e.g.: R1/8.

3.12 Parallel pipe thread G – ISO 228-1

The bold line is the basic profile.

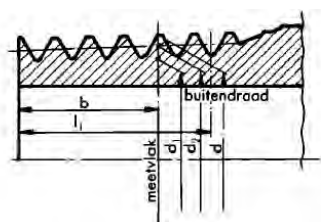

P = pitch
N = number of threads per inch

External thread	Internal thread
d = major diameter	D = major diameter
d_1 = minor diameter	D_1 = minor diameter
d_2 = pitch diameter	D_2 = pitch diameter

Whitworth parallel pipe thread - G is intended to be used for mechanical pressure-tight joints for fittings, valves, cocks, etc. where the seal is not made on the thread. This screw thread is designated by the profile letter G, followed by the basic diameter in inches and, for external thread, followed by the capital A or B of the tolerance class. E.g.: for external thread G $\frac{1}{2}$ A and for internal thread G $\frac{1}{2}$.

3.12.1 Limit dimensions for parallel pipe thread - G

The table below is based on ISO 228-1 (2000). Dimensions in mm.

external thread, tolerance class A							internal thread						
Designation	Number of threads	Major diameter		Pitch diameter		Minor diameter	Designation	Number of threads	Major diameter	Pitch diameter		Minor diameter	
		$d_{max.}$	$d_{min.}$	$d_{2max.}$	$d_{2min.}$	$d_{1nom.}$				N	D_{Basic}	$D_{2max.}$	$D_{2min.}$
G $\frac{1}{8}$ A	28	9,728	9,514	9,147	9,040	8,566	G $\frac{1}{8}$	28	9,728	9,254	9,147	8,848	8,566
G $\frac{1}{4}$ A	19	13,157	12,907	12,301	12,176	11,445	G $\frac{1}{4}$	19	13,157	12,426	12,301	11,890	11,445
G $\frac{3}{8}$ A	19	16,662	16,412	15,806	15,681	14,950	G $\frac{3}{8}$	19	16,662	15,931	15,806	15,395	14,950
G $\frac{1}{2}$ A	14	20,955	20,671	19,793	19,651	18,631	G $\frac{1}{2}$	14	20,995	19,935	19,793	19,172	18,631
G $\frac{5}{8}$ A	14	22,911	22,627	21,749	21,607	20,587	G $\frac{5}{8}$	14	22,911	21,891	21,749	21,128	20,587
G $\frac{3}{4}$ A	14	26,441	26,157	25,279	25,137	24,117	G $\frac{3}{4}$	14	26,441	25,421	25,279	24,658	24,117
G $\frac{7}{8}$ A	14	30,201	29,917	29,039	28,897	27,877	G $\frac{7}{8}$	14	30,201	29,181	29,039	29,418	27,877
G1A	11	33,249	32,889	31,770	31,590	30,291	G1	11	33,249	31,950	31,770	30,931	30,291
G1 $\frac{1}{4}$ A	11	37,897	37,537	36,418	36,238	34,939	G1 $\frac{1}{4}$	11	37,897	36,598	36,418	35,579	34,939
G1 $\frac{1}{2}$ A	11	41,910	41,550	40,431	40,251	38,952	G1 $\frac{1}{2}$	11	41,910	40,611	40,431	39,592	38,952
G1 $\frac{3}{4}$ A	11	47,803	47,443	46,324	46,144	44,845	G1 $\frac{3}{4}$	11	47,803	46,504	46,324	45,485	44,845

4 Basic standards

4.1 Drilling sizes for tapping screws and bolts

4.1.1 Application guidelines

The essential characteristic of tapping screw thread is its ability to form a chipless internal thread in a core hole made in the materials to be joined. These core hole data, which are theoretically calculated and based on actual tests, apply to fasteners with tapping screw thread as per ISO 1478 and only for application in metals with the tensile strengths indicated in the tables. They do not apply for use in plastics for which several modified tapping screw threads have been developed. They also do not apply for use in stainless steel. It is not possible to provide general recommendations and a determination must be made on a case by case basis of the conditions under which such joints are possible. This also applies to stainless steel tapping screws. Surface coatings can have such an influence on coefficients of friction when driving in screws that the core hole size must be amended.

In sheet thickness up to 2 mm, the holes are usually punched, not drilled. Due to the cold work hardening of the hole wall, the holes must be made 0,1 to 0,3 mm larger, depending on material and sheet thickness. Ensure that the screw is inserted in the punch direction and not from the other side.

- Tapping screws with point type C and type R (see previous chapter) are most commonly used, especially through multiple sheets where the pilot point enables the holes to be aligned.
- Tapping screws with tap type F (see previous chapter) are preferred for use where protruding sharp points may cause problems e.g. injuries.

4.1.2 Application possibilities

Sheet thicknesses not thinner than the pitch of the screw thread.

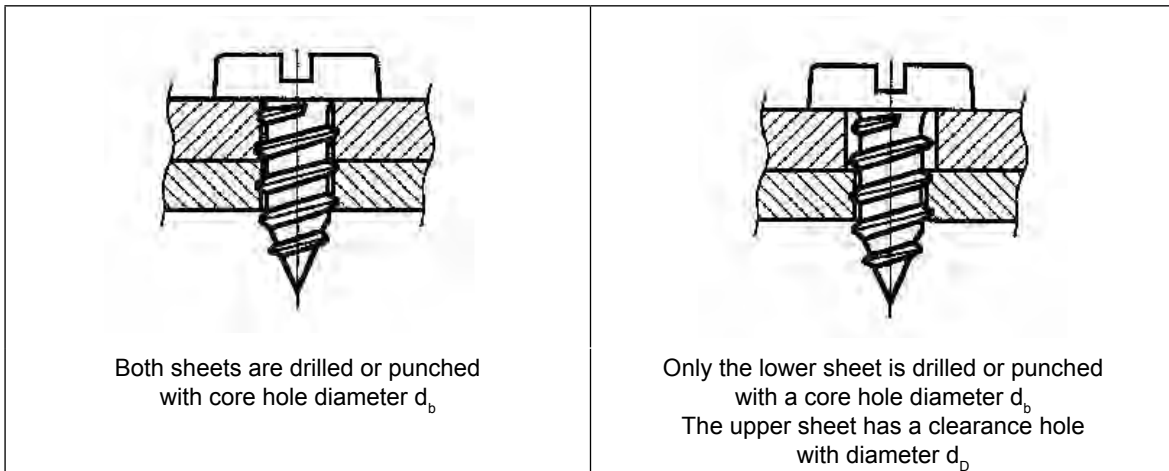

Thinner sheet thicknesses

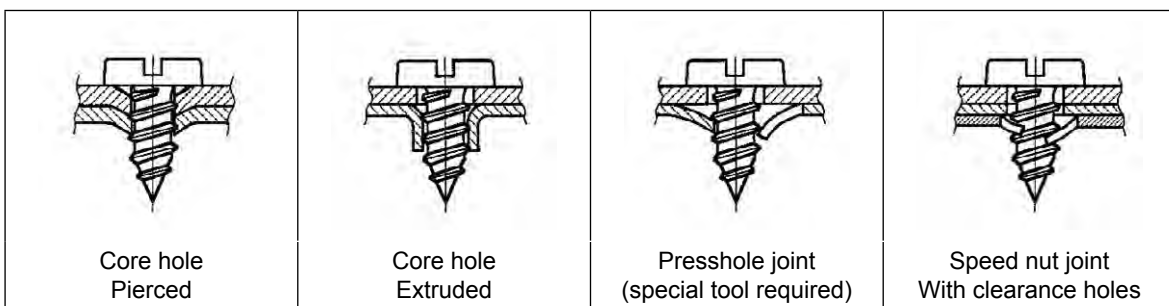

4.1.3 Guidelines for core hole diameters d_b^1

The tables below are based on DIN 7975 (1989). Dimensions in mm.

Core hole diameters for tapping screw thread ST2,2										Core hole diameters for tapping screw thread ST2,9									
sheet thickness ²	tensile strength material R_m in N/mm ²									sheet thickness ²	tensile strength material R_m in N/mm ²								
	100	150	200	250	300	350	400	450	500		100	150	200	250	300	350	400	450	500
0,8	1,7	1,7	1,7	1,7	1,7	1,7	1,7	1,7	1,7	1,1	2,2	2,2	2,2	2,2	2,2	2,2	2,2	2,2	2,3
0,9	1,7	1,7	1,7	1,7	1,7	1,7	1,7	1,7	1,7	1,2	2,2	2,2	2,2	2,2	2,2	2,2	2,2	2,2	2,3
1,0	1,7	1,7	1,7	1,7	1,7	1,7	1,7	1,7	1,8	1,3	2,2	2,2	2,2	2,2	2,2	2,2	2,2	2,3	2,3
1,1	1,7	1,7	1,7	1,7	1,7	1,7	1,7	1,8	1,8	1,4	2,2	2,2	2,2	2,2	2,2	2,2	2,3	2,3	2,4
1,2	1,7	1,7	1,7	1,7	1,7	1,7	1,8	1,8	1,8	1,5	2,2	2,2	2,2	2,2	2,2	2,3	2,3	2,4	2,4
1,3	1,7	1,7	1,7	1,7	1,7	1,8	1,8	1,8	1,8	1,6	2,2	2,2	2,2	2,2	2,3	2,3	2,4	2,4	2,4
1,4	1,7	1,7	1,7	1,7	1,7	1,8	1,8	1,8	1,9	1,7	2,2	2,2	2,2	2,2	2,3	2,4	2,4	2,4	2,4
1,5	1,7	1,7	1,7	1,7	1,8	1,8	1,8	1,9	1,9	1,8	2,2	2,2	2,2	2,3	2,3	2,4	2,4	2,4	2,5
1,6	1,7	1,7	1,7	1,8	1,8	1,8	1,9	1,9	1,9	1,9	2,2	2,2	2,2	2,3	2,4	2,4	2,4	2,5	2,5
1,7	1,7	1,7	1,7	1,8	1,8	1,9	1,9	1,9	1,9	2,0	2,2	2,2	2,3	2,3	2,4	2,4	2,5	2,5	2,5
1,8	1,7	1,7	1,8	1,8	1,8	1,9	1,9	1,9	1,9	2,2	2,2	2,2	2,3	2,4	2,4	2,5	2,5	2,5	2,5

Core hole diameters for tapping screw thread ST3,5										Core hole diameters for tapping screw thread ST3,9									
sheet thickness ²	tensile strength material R_m in N/mm ²									sheet thickness ²	tensile strength material R_m in N/mm ²								
	100	150	200	250	300	350	400	450	500		100	150	200	250	300	350	400	450	500
1,3	2,6	2,6	2,6	2,6	2,6	2,6	2,7	2,7	2,8	1,3	2,9	2,9	2,9	2,9	2,9	3,0	3,0	3,1	3,1
1,4	2,7	2,7	2,7	2,7	2,7	2,7	2,7	2,8	2,8	1,4	2,9	2,9	2,9	2,9	2,9	3,0	3,1	3,1	3,1
1,5	2,7	2,7	2,7	2,7	2,7	2,7	2,8	2,8	2,9	1,5	3,0	3,0	3,0	3,0	3,0	3,1	3,1	3,1	3,2
1,6	2,7	2,7	2,7	2,7	2,7	2,7	2,8	2,9	2,9	1,6	3,0	3,0	3,0	3,0	3,1	3,1	3,1	3,2	3,2
1,7	2,7	2,7	2,7	2,7	2,7	2,8	2,8	2,9	2,9	1,7	3,0	3,0	3,0	3,0	3,1	3,1	3,2	3,2	3,3
1,8	2,7	2,7	2,7	2,7	2,8	2,8	2,9	2,9	2,9	1,8	3,0	3,0	3,0	3,0	3,1	3,2	3,2	3,3	3,3
1,9	2,7	2,7	2,7	2,7	2,8	2,9	2,9	2,9	3,0	1,9	3,0	3,0	3,0	3,1	3,2	3,2	3,3	3,3	3,3
2,0	2,7	2,7	2,7	2,8	2,9	2,9	2,9	3,0	3,0	2,0	3,0	3,0	3,0	3,1	3,2	3,2	3,3	3,3	3,3
2,2	2,7	2,7	2,8	2,8	2,9	3,0	3,0	3,0	3,0	2,2	3,0	3,0	3,1	3,2	3,2	3,3	3,3	3,3	3,4
2,5	2,7	2,7	2,9	2,9	3,0	3,0	3,0	3,1	3,1	2,5	3,0	3,0	3,2	3,3	3,3	3,3	3,4	3,4	3,4
2,8	2,7	2,8	2,9	3,0	3,0	3,0	3,1	3,1	3,1	2,8	3,0	3,2	3,3	3,3	3,4	3,4	3,4	3,4	3,4
										3,0	3,0	3,2	3,3	3,3	3,4	3,4	3,4	3,4	3,5

Core hole diameters for tapping screw thread ST4,2										Core hole diameters for tapping screw thread ST4,8									
sheet thickness ²	tensile strength material R_m in N/mm ²									sheet thickness ²	tensile strength material R_m in N/mm ²								
	100	150	200	250	300	350	400	450	500		100	150	200	250	300	350	400	450	500
1,4	3,1	3,1	3,1	3,1	3,1	3,1	3,2	3,3	3,4	1,6	3,6	3,6	3,6	3,6	3,6	3,7	3,8	3,9	3,9
1,5	3,2	3,2	3,2	3,2	3,2	3,2	3,2	3,3	3,4	1,7	3,6	3,6	3,6	3,6	3,7	3,8	3,9	3,9	4,0
1,6	3,2	3,2	3,2	3,2	3,2	3,2	3,3	3,4	3,4	1,8	3,6	3,6	3,6	3,6	3,8	3,8	3,9	4,0	4,0
1,7	3,2	3,2	3,2	3,2	3,2	3,3	3,3	3,4	3,4	1,9	3,6	3,6	3,6	3,7	3,8	3,9	3,9	4,0	4,0
1,8	3,2	3,2	3,2	3,2	3,3	3,3	3,4	3,4	3,5	2,0	3,6	3,6	3,6	3,8	3,9	3,9	4,0	4,0	4,1
1,9	3,2	3,2	3,2	3,2	3,3	3,4	3,4	3,4	3,5	2,2	3,6	3,6	3,7	3,9	3,9	4,0	4,0	4,1	4,1
2,0	3,2	3,2	3,2	3,3	3,4	3,4	3,5	3,5	3,5	2,5	3,6	3,7	3,9	4,0	4,0	4,1	4,1	4,1	4,2
2,2	3,2	3,2	3,2	3,3	3,4	3,5	3,5	3,5	3,6	2,8	3,6	3,8	4,0	4,0	4,1	4,1	4,2	4,2	4,2
2,5	3,2	3,2	3,4	3,4	3,5	3,5	3,6	3,6	3,6	3,0	3,7	3,9	4,0	4,1	4,1	4,2	4,2	4,2	4,2
2,8	3,2	3,3	3,4	3,5	3,6	3,6	3,6	3,6	3,6	3,5	3,8	4,0	4,1	4,2	4,2	4,2	4,2	4,2	4,3
3,0	3,2	3,4	3,5	3,5	3,6	3,6	3,6	3,6	3,7	4,0	4,0	4,1	4,2	4,2	4,2	4,2	4,3	4,3	4,3
3,5	3,3	3,5	3,6	3,6	3,6	3,7	3,7	3,7	3,7										

Core hole diameters for tapping screw thread ST5,5										Core hole diameters for tapping screw thread ST6,3									
sheet thickness ²	tensile strength material R _m in N/mm ²									sheet thickness ²	tensile strength material R _m in N/mm ²								
	100	150	200	250	300	350	400	450	500		100	150	200	250	300	350	400	450	500
1,8	4,2	4,2	4,2	4,2	4,3	4,4	4,5	4,6	4,6	1,8	4,9	4,9	4,9	4,9	5,0	5,2	5,3	5,3	5,4
1,9	4,2	4,2	4,2	4,2	4,4	4,5	4,6	4,6	4,7	1,9	4,9	4,9	4,9	5,0	5,1	5,2	5,3	5,4	5,4
2,0	4,2	4,2	4,2	4,3	4,4	4,5	4,6	4,6	4,7	2,0	4,9	4,9	4,9	5,1	5,2	5,3	5,4	5,4	5,5
2,2	4,2	4,2	4,3	4,4	4,5	4,6	4,7	4,7	4,8	2,2	4,9	4,9	5,0	5,2	5,3	5,4	5,5	5,5	5,6
2,5	4,2	4,2	4,4	4,6	4,7	4,7	4,8	4,8	4,8	2,5	4,9	5,0	5,2	5,4	5,4	5,5	5,6	5,6	5,6
2,8	4,2	4,4	4,6	4,7	4,7	4,8	4,8	4,8	4,9	2,8	4,9	5,2	5,3	5,5	5,5	5,6	5,6	5,7	5,7
3,0	4,2	4,5	4,6	4,7	4,8	4,8	4,8	4,9	4,9	3,0	4,9	5,3	5,4	5,5	5,6	5,6	5,7	5,7	5,7
3,5	4,4	4,6	4,7	4,8	4,8	4,9	4,9	4,9	4,9	3,5	5,2	5,4	5,5	5,6	5,7	5,7	5,7	5,7	5,8
4,0	4,6	4,7	4,8	4,9	4,9	4,9	4,9	4,9	5,0	4,0	5,3	5,5	5,6	5,7	5,7	5,7	5,8	5,8	5,8
4,5	4,7	4,8	4,9	4,9	4,9	4,9	5,0	5,0	5,0	4,5	5,5	5,6	5,7	5,7	5,8	5,8	5,8	5,8	5,8
										5,0	5,5	5,7	5,7	5,8	5,8	5,8	5,8	5,8	5,8

Core hole diameters for tapping screw thread ST8									
sheet thickness ²	tensile strength material R _m in N/mm ²								
	100	150	200	250	300	350	400	450	500
2,1	6,3	6,3	6,3	6,3	6,5	6,6	6,7	6,8	6,9
2,2	6,3	6,3	6,3	6,5	6,6	6,8	6,8	6,9	7,0
2,5	6,3	6,3	6,5	6,7	6,8	6,9	7,0	7,0	7,1
2,8	6,3	6,4	6,7	6,8	6,9	7,0	7,1	7,1	7,2
3,0	6,3	6,5	6,8	6,9	7,0	7,1	7,1	7,2	7,2
3,5	6,4	6,8	7,0	7,1	7,1	7,2	7,2	7,3	7,3
4,0	6,7	6,9	7,1	7,2	7,2	7,3	7,3	7,3	7,3
4,5	6,8	7,1	7,2	7,2	7,3	7,3	7,3	7,3	7,4
5,0	7,0	7,1	7,2	7,3	7,3	7,3	7,4	7,4	7,4
5,5	7,1	7,2	7,3	7,3	7,3	7,4	7,4	7,4	7,4
6,0	7,1	7,2	7,3	7,3	7,4	7,4	7,4	7,4	7,4
6,5	7,2	7,3	7,3	7,4	7,4	7,4	7,4	7,4	7,4

¹ These core hole diameter values apply for a simple tapping screw joint with a clearance hole in the upper sheet and a drilled hole in the lower sheet and for uncoated tapping screws.

² The minimum sheet thickness has been chosen in such a way that the drive-in torque will not exceed 50 % of the minimum breaking torque according to ISO 2702. This upper limit is about 0,8 of the nominal diameter of the screw e.g. ST4,2 can be used in sheet that is no more than 0,8 x 4,2 = 3,5 mm thick.

Guidelines for the diameter of clearance holes:

The minimum diameter of clearance holes can be calculated using the formula:

$$d_D = d_1 + 1/3(d_1 - d_b) \text{ mm}$$

where: d_D = diameter clearance hole
 d_1 = nominal diameter of tapping screw thread
 d_b = core hole diameter

Example:

The minimum diameter of the clearance hole for a tapping screw with an ST6,3 screw thread in material that is 4 mm thick and that has a tensile strength of 350 N/mm² will be $d_D = 6,3 + 1/3(6,3 - 5,7) = 6,5$ mm.

4.2 Core holes for thread forming screws in metals (Taptite 2000®)

4.2.1 Recommendations for drilled and punched holes in materials in the hardness range up to 150 HB, 500 N/mm²

The core hole diameters (the preferred zone is marked with a color) in below table are determined experimentally by manufacturers and users, dependent on the various types of material, material thicknesses or drive-in depths. These values are **for guidance only**.

Manufacturing processes (e.g. punching) that cause cold work hardening of the pilot hole wall, require a somewhat larger diameter. This may also apply to cast holes (harder casting scale).

Recommended tolerance class for the core holes: H11.

Especially for mass production purposes, it is recommended to perform tests in order to achieve an optimum result with respect to the combination of mechanical properties of the screw, the drive-in depth and the mechanical properties of the material in which the screws are to be mounted. It is recommended to start testing with the smallest advised diameter.

d	M2.5	M3	M3.5	M4	M5	M6	M8	d
Material thickness or drive depth	Hole diameter D _h [mm]						Material thickness or drive depth	
0,8								0,8
0,9								0,9
1	2,20							1
1,2		2,65	3,15	3,60				1,2
1,5	2,20							1,5
1,6								1,6
1,7	to							1,7
1,8	2,25				4,45			1,8
2					to	5,25		2
2,2		2,65	3,15		4,50	to		2,2
2,5	2,25	to	to	3,60		5,30		2,5
3	to	2,70	3,20	to		5,40	7,10	3
3,2	2,30			3,70		to	to	3,2
3,5						5,40	7,20	3,5
4	2,25				4,50			4
5	to				to	5,40	7,20	5
5,5	2,30	2,70	3,20		4,55	5,40	to	5,5
6		to	to			to	7,30	6
6,5		2,75	3,25			5,45		6,5
7				3,65				7
7,5				to	4,55		7,30	7,5
8				3,70	to		to	8
10					4,65	5,45	7,35	10
12						to		12
>12-16						5,65	7,35	>12-16
>16-20							to	>16-20
							7,45	

Guideline for dimensioning the insertion depth.

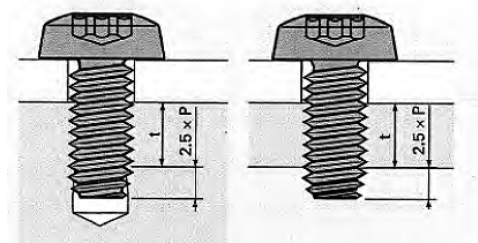

Guide values for insertion depths

Steel = 1,5 x d
 Aluminium = 2 x d
 Zinc = 2 x d
 Magnesium = 2,5 x d

Important note:

The load-bearing thread length is reduced by the length of the tip

For castings, e.g. tapered, cast blind and through holes specific information is available on request.

4.3 Core holes for thread forming screws in plastics (Remform®)

4.3.1 Recommendations for the geometry of holes and bosses for Remform® screws

In principle, the geometry of the boss must conform to below picture.

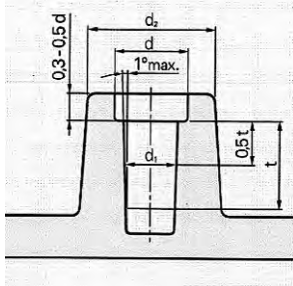

d nominal screw diameter
d₁ bore diameter
d₂ tube external diameter
t insertion depth

These core hole diameters are determined experimentally using various types of plastics. These values are for guidance only and, especially in mass production, it is recommended that one's own tests be carried out in order to achieve an optimum result with respect to the different mechanical properties (e.g. temperature, load, time, speed).

Screw size Ød	soft																	hard		
	Tube geometry	PP	PE-LD/HD	PS	PA6/PA6.6	PBT	PET	ASA/SAN	ABS	POM	ABS/PC	PA6-GF3-	PMMA	PC*	PPE*	PC-GF30*	PBT-GF30*	PET-GF30*		
Ø2,0	d1	1,45	1,45	1,45	1,45	1,5	1,5	1,5	1,5	1,5	1,6	1,6	1,6	1,6	1,7	1,7	1,7	1,7		
	d2	4,4	4,4	4,4	4,4	4,2	4,2	4,2	4,2	4,2	4,0	4,0	4,0	4,4	4,4	4,4	3,8	3,8		
	t	5,0	5,0	5,0	5,0	5,0	5,0	4,5	4,5	4,5	4,5	4,5	4,5	4,0	4,0	4,0	4,0	4,0		
Ø2,2	d1	1,6	1,6	1,6	1,6	1,7	1,7	1,7	1,7	1,7	1,8	1,8	1,8	1,8	1,9	1,9	1,9	1,9		
	d2	4,9	4,9	4,9	4,9	4,7	4,7	4,7	4,7	4,7	4,4	4,4	4,4	4,9	4,9	4,9	4,2	4,2		
	t	5,5	5,5	5,5	5,5	5,5	5,5	5,0	5,0	5,0	5,0	5,0	5,0	4,5	4,5	4,5	4,5	4,5		
Ø2,5	d1	1,8	1,8	1,8	1,8	1,9	1,9	1,9	1,9	1,9	2,0	2,0	2,0	2,0	2,1	2,1	2,1	2,1		
	d2	5,5	5,5	5,5	5,5	5,3	5,3	5,3	5,3	5,3	5,0	5,0	5,5	5,5	5,8	5,8	4,8	4,8		
	t	6,0	6,0	6,0	6,0	6,0	6,0	5,5	5,5	5,5	5,5	5,5	5,5	5,0	5,0	5,0	5,0	5,0		
Ø3,0	d1	2,25	2,25	2,25	2,25	2,3	2,3	2,3	2,3	2,3	2,4	2,4	2,4	2,4	2,6	2,6	2,6	2,6		
	d2	6,6	6,6	6,6	6,6	6,3	6,3	6,3	6,3	6,3	6,0	6,0	6,0	6,6	6,6	6,6	5,7	5,7		
	t	7,0	7,0	7,0	7,0	7,0	7,0	6,5	6,5	6,5	6,5	6,5	6,5	6,0	6,0	6,0	6,0	6,0		
Ø3,5	d1	2,6	2,6	2,6	2,6	2,7	2,7	2,7	2,7	2,7	2,8	2,8	2,8	2,8	3,0	3,0	3,0	3,0		
	d2	7,8	7,8	7,8	7,8	7,4	7,4	7,4	7,4	7,4	7,0	7,0	7,0	7,8	7,8	7,8	6,7	6,7		
	t	8,0	8,0	8,0	8,0	8,0	8,0	7,5	7,5	7,5	7,5	7,5	7,5	7,0	7,0	7,0	7,0	7,0		
Ø4,0	d1	2,9	2,9	2,9	2,9	3,0	3,0	3,0	3,0	3,0	3,2	3,2	3,2	3,2	3,4	3,4	3,4	3,4		
	d2	9,0	9,0	9,0	9,0	8,5	8,5	8,5	8,5	8,5	8,0	8,0	8,0	9,0	9,0	9,0	7,5	7,5		
	t	9,0	9,0	9,0	9,0	9,0	9,0	8,5	8,5	8,5	8,5	8,5	8,5	8,0	8,0	8,0	8,0	8,0		
Ø5,0	d1	3,7	3,7	3,7	3,7	3,8	3,8	3,8	3,8	3,8	4,0	4,0	4,0	4,0	4,2	4,2	4,2	4,2		
	d2	11,0	11,0	11,0	11,0	10,5	10,5	10,5	10,5	10,5	10,0	10,0	10,0	11,0	11,0	11,0	9,5	9,5		
	t	11,0	11,0	11,0	11,0	11,0	11,0	10,5	10,5	10,5	10,5	10,5	10,5	10,0	10,0	10,0	10,0	10,0		
Ø6,0	d1	4,3	4,3	4,3	4,3	4,5	4,5	4,5	4,5	4,5	4,8	4,8	4,8	4,8	5,1	5,1	5,1	5,1		
	d2	13,5	13,5	13,5	13,5	12,5	12,5	12,5	12,5	12,5	12,0	12,0	12,0	13,5	13,5	13,5	11,5	11,5		
	t	13,5	13,5	13,5	13,5	13,5	13,5	13,0	13,0	13,0	13,0	13,0	13,0	12,0	12,0	12,0	12,0	12,0		
Ø8,0	d1	5,7	5,7	5,7	5,7	6,0	6,0	6,0	6,0	6,0	6,4	6,4	6,4	6,4	6,8	6,8	6,8	6,8		
	d2	17,5	17,5	17,5	17,5	16,5	16,5	16,5	16,5	16,5	16,0	16,0	16,0	17,5	17,5	17,5	15,5	15,5		
	t	18,0	18,0	18,0	18,0	18,0	18,0	17,0	17,0	17,0	17,0	17,0	17,0	16,0	16,0	16,0	16,0	16,0		

Dimensions in mm. tolerance acc. DIN 16901

*Plastics sensitive for stress cracking

4.4 Length of protrusion of bolt ends (l_p)

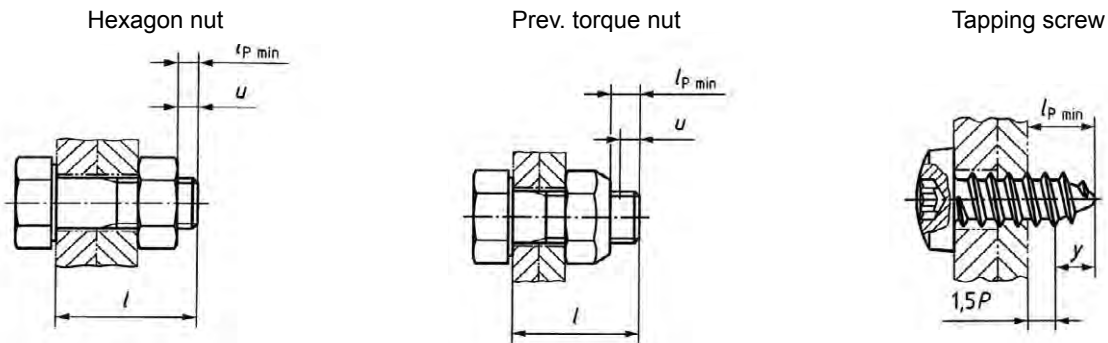

Length of protrusion of the bolt end (l_p) is based on DIN 78 (2013)

For hexagon nuts: $l_{p \min} = 2P + (ISO 4753(2011): u \geq 2P)$

For prevailing torque nuts: $l_{p \min} = 3P + (ISO 4753(2011): u \geq 2P)$

The nominal length of bolts, L , is calculated from the clamping length plus the total nut height and the minimum bolt end, $l_{p \min}$. The calculated values must be rounded off to the next (longer) standardized length. Length of protrusion for hexagon slotted nuts, see DIN 34803

y according DIN-EN-ISO 1478 (1999)

y	Type	ST2,2	ST2,9	ST3,5	ST3,9	ST4,2	ST4,8	ST5,5	ST6,3
	C	2,0	2,3	3,2	3,5	3,7	4,3	5,0	6,0
F	1,6	1,8	2,5	2,7	2,8	3,2	3,6	3,6	
R	--	--	2,7	3,0	3,2	3,6	4,3	5,0	

4.5 Drill sizes before tapping screw threads

4.5.1 General notes

These drill sizes are guide values for core hole diameters for tapping screw thread.

The tolerance limits of the screw thread must not be exceeded. Depending on material, tools and manufacturing method it may be necessary to deviate from these guide values and to determine the actual drill size experimentally. For metric and unified screw threads (ISO-profile), in principle the following formula applies: drill size = nominal screw thread size - pitch, if necessary rounded off.

4.5.2 Drill sizes Metric (ISO) screw thread - coarse - M

Based on ISO 2306 (1972). Dimensions in mm.

screw thread size	drill size
M1	0,75
M1,1	0,85
M1,2	0,95
M1,4	1,1
M1,6	1,25
M1,8	1,45
M2	1,6

screw thread size	drill size
M2,2	1,75
M2,5	2,05
M3	2,5
M3,5	2,9
M4	3,3
M4,5	3,7
M5	4,2

screw thread size	drill size
M6	5
M7	6
M8	6,8
M9	7,8
M10	8,5
M11	9,5
M12	10,2

screw thread size	drill size
M14	12
M16	14
M18	15,5
M20	17,5
M22	19,5
M24	21
M27	24

screw thread size	drill size
M30	26,5
M33	29,5
M36	32
M39	35
M42	37,5
M45	40,5
M48	43

screw thread size	drill size
M52	47
M56	50,5
M60	54,5
M64	58
M68	62

4.5.3 Drill sizes Metric (ISO) screw thread - fine - MF

Based on ISO 2306 (1972). Dimensions in mm.

thread size x pitch	drill size
M3 x 0,35	2,65
M3,5 x 0,35	3,15
M4 x 0,5	3,5
M4,5 x 0,5	4

thread size x pitch	drill size
M5 x 0,5	4,5
M6 x 0,75	5,2
M8 x 1	7
M10 x 1	9

thread size x pitch	drill size
M10 x 1,25	8,8
M12 x 1	11
M12 x 1,25	10,8
M12 x 1,5	10,5

thread size x pitch	drill size
M14 x 1,5	12,5
M16 x 1,5	14,5
M18 x 1,5	16,5
M18 x 2	16

thread size x pitch	drill size
M20 x 1,5	18,5
M20 x 2	18
M22 x 1,5	20,5
M22 x 2	20

thread size x pitch	drill size
M24 x 1,5	22,5
M24 x 2	22
M27 x 1,5	25,5
M27 x 2	25

4.5.4 Drill sizes Whitworth parallel pipe thread – G

Based on ISO 2306 (1972). Dimensions in mm.

screw thread size x threads/inch	drill size
G $\frac{1}{8}$ x 28	8,8
G $\frac{1}{4}$ x 19	11,8
G $\frac{3}{8}$ x 19	15,25
G $\frac{1}{2}$ x 14	19

screw thread size x threads/inch	drill size
G $\frac{5}{8}$ x 14	21
G $\frac{3}{4}$ x 14	24,5
G $\frac{7}{8}$ x 14	28,25
G1 x 11	30,75

screw thread size x threads/inch	drill size
G1 $\frac{1}{8}$ x 11	35,3
G1 $\frac{1}{4}$ x 11	39,5
G1 $\frac{1}{2}$ x 11	45
G1 $\frac{3}{4}$ x 11	51

4.6 Width across flats according to ISO

The width across flats of some ISO-standardized hexagon nuts and bolts have changed compared to the obsolete DIN-standards. This only concerns fasteners with thread diameter M10, M12, M14 and M22.

Comparison of DIN and ISO widths across flats in the table below is based on ISO 272 (1982).

Dimensions in mm.

Basic diameter	M10	M12	M14	M22
Width across flats according to DIN	17	19	22	32
Width across flats according to ISO 272	16	18	21	34

5 Surface coatings for fasteners

5.1 Introduction

According to DIN 50900-1, corrosion of a metal is a reaction of this material with its environment that results in a measurable change of the metal and which can lead to a lower performance of the metal part or a complete system.

Several types of corrosion exist.

Some types of corrosion appear without the effect of a mechanical load on the product: surface corrosion, pitting, crevice corrosion, galvanic corrosion, chemical corrosion.

Others are initiated due to a combination with mechanical load: stress corrosion cracking, erosion.

The corrosion resistance of a coating is often expressed in a number of hours until white (zinc corrosion) or red (base metal corrosion) corrosion in a salt spray test acc. ISO 9227. Salt spray testing is a method to check whether the comparative quality of a corrosion protection is maintained. There is however seldom a direct relation between resistance to the action of salt spray and resistance to corrosion in other media, because several factors influencing the progress of corrosion vary greatly with the conditions encountered. Therefore the performance of different coating types during such corrosion test should not be taken as a direct guide to the corrosion resistance in service.

Several measures can be taken to prevent or delay corrosion of fasteners, such as proper design of the fastening, proper choice of materials, application of a suitable coating system.

In the table section of this manual, one can find a Contact corrosion table and a Chemical corrosion table which can be a first help to determine an acceptable material type in a corrosive environment.

This chapter only handles surface coatings which are suitable for fasteners.

5.1.1 Overview of coating systems

Coatings can be divided into metallic and non-metallic systems.

Metallic (inorganic) coatings:

- Electrolytical applied coatings (acc. ISO 4042) such as zinc, zinc-iron, nickel, ...
- Chemical (electroless) plating: chemical nickel plating
- Hot dip galvanized (ISO 10684): thick coating of zinc, applied by dipping in melted zinc
- Diffusion coatings: metal powder applied at elevated temperature (sherardizing, chromating)
- Mechanical plating (ISO 12683): zinc powder mechanically applied
- Dispersion coatings(ISO 10683): zincflakes applied in a dispersive solution

Non-metallic coatings:

- Oil: generally applied on plain fasteners to reduce risk of corrosion during storage
- Black oxidized: not a real coating, conversion of the steel surface to iron oxide by immersion in a hot alkaline liquid
- Phosphating (ISO 3892): chemically applied zinc- of manganesephosphate coating, normally combined with oil to give some corrosion protection
- Chromate passivation (EN12329): supplementary coating on e.g. zinc to further improve its corrosion resistance
- Thin lacquer coatings: several coatings such as PTFE, Teflon, KTL

Most often applied on fasteners are “active” coatings. Such coatings (e.g. zinc) provide “cathodical” protection, which means that the coating will sacrifice in favour of the metal to be protected. The advantage of active coatings is that even with small damages they will delay severe base metal corrosion.

“Passive” coatings are those that seal the material from the environment, e.g. Teflon. Such coatings have the disadvantage that corrosion will proceed rapidly once the coating is damaged.

Sometimes a combination of coatings is applied, often called “duplex coating”.

5.1.2 Coating thickness limits

The degree of protection against corrosion is generally proportional to the thickness of the applied coating. For threaded fasteners the maximum layer thickness that can be applied depends on the allowance between the maximum size of the external thread and the minimum size of the internal thread. To prevent the nut/bolt thread seizing during assembly, the maximum nominal layer thickness should not exceed ¼ of this allowance.

The table below (acc ISO 4042) provides the allowance and maximum layer thickness for each pitch. Most coatings have a thickness that may vary depending on the location on the fastener. For electroplated coatings, ISO 4042 has defined the relationship between length/diameter ratio and the maximum coating thickness.

External thread						
Pitch P	Nominal thread diameter d ¹	Fundamental allowance	Tolerance position g			
			Nominal maximum layer thickness			
			2 All nominal lengths	3 Nominal length L		
				L≤5d	5d<L≤10d	10d<L≤15d
mm	µm	µm	µm	µm	µm	
0,2		-17	3	3	3	3
0,25	1; 1,2	-18	3	3	3	3
0,3	1,4	-18	3	3	3	3
0,35	1,6 (1,8)	-19	3	3	3	3
0,4	2	-19	3	3	3	3
0,45	2,5 (2,2)	-20	5	5	3	3
0,5	3	-20	5	5	3	3
0,6	3,5	-21	5	5	3	3
0,7	4	-22	5	5	3	3
0,75	4,5	-22	5	5	3	3
0,8	5	-24	5	5	3	3
1	6 (7)	-26	5	5	3	3
1,25	8	-28	5	5	5	3
1,5	10	-32	8	8	5	5
1,75	12	-34	8	8	5	5
2	16 (14)	-38	8	8	5	5
2,5	20 (18; 22)	-42	10	10	8	8
3	24 (27)	-48	12	12	8	8
3,5	30 (33)	-53	12	12	10	8
4	36 (30)	-60	15	15	12	10
4,5	42 (45)	-63	15	15	12	10
5	48 (52)	-71	15	15	12	10
5,5	56 (60)	-75	15	15	15	12
6	64	-80	20	20	15	12

¹ This information concerning coarse screw threads is only provided for reasons of convenience. The pitch is normative.
² Maximum nominal layer thicknesses for local measurement.
³ Maximum nominal layer thicknesses if a measurement based on the average layer thickness of a batch is agreed in accordance with the method shown in ISO 4042, annex B.

5.1.3 Hydrogen embrittlement

When atomic hydrogen enters steel, it can cause catastrophic brittle cracking at applied stresses well below the yield strength. This phenomenon is often referred to as hydrogen induced delayed brittle failure or hydrogen embrittlement. Typical is that failure due to hydrogen embrittlement occurs a few hours or days after assembly.

Hydrogen can be introduced during several treatments such as cleaning, pickling, electroplating...but also in the service environment as a result of cathodic protection reactions or corrosion reactions.

Hydrogen embrittlement is most likely to occur in products:

- With tensile strength ≥ 1000 N/mm²
- With a hardness ≥ 320 HV
- That are case hardened.

In order to reduce the risk of failure by hydrogen embrittlement, susceptible parts shall be baked within 4 hours after electroplating and before passivation to a part temperature of 200°C to 230°C. Nevertheless a guarantee cannot be given that parts are free of brittleness after such baking treatment.

Especially for very high tensile screws, such as class 12.9, it is strongly desencouraged to apply coatings that carry a risk for H-embrittlement (e.g. electroplating).

Standard coatings that are generally with low risk for H-embrittlement: zinc flake coatings, hot dip galvanized.

5.1.4 European directives RoHS and ELV

RoHS or RoHS II: Restriction on the use of Hazardous Substances (European Directive 2011/65/EU).

ELV: End of Live Vehicles (European Directive 2000/53/EC).

Both directives restrict the use of lead (Pb), mercury (Hg), cadmium (Cd) and hexavalent chromium (Cr⁶⁺).

RoHS II restricts also on Polybrominated Biphenyls (PBB), Polybrominated Diphenyl Ethers (PBDF). RoHS is applicable to electric and electronic equipment, while ELV affects passenger cars.

Particularly the restriction on Cr⁶⁺ is of importance for fastener coatings, as popular passivation layers such as yellow and black passivation, but also the zincflake coating Dacromet, contain an unacceptable high level of this substance. It is expected that in the near future Cr⁶⁺ coatings will be banned in Europe.

As for standard stock parts, Fabory has a broad assortment of Cr⁶⁺-free coated fasteners mainly

- Electrozinc plated, white passivated (Cr³⁺)
- Zinc flake coating flZn/nc/L/600h

On demand also many other Cr⁶⁺-free coatings are available.



Care is to be taken for the use of lead (Pb) in some types of steel and brass, depending if the exemptions granted in the RoHS legislation will be continued after their expiration mid 2016.

5.2 Electroplating

An electroplated coating is a metallic layer that is deposited onto the surface of metal parts by immersing them in a solution containing an electrolyte and through which an electric current is passed.

The requirements for electroplated coatings on fasteners are defined in ISO 4042:1999. This edition of the ISO standard does not take into account the restrictions by various EU legislations. A new edition of ISO 4042 is being prepared, which will define also electroplated coatings that are free of hazardous substances as defined in e.g. RoHS.

A coding system can be used to define the coating metal, its thickness and the passivation layer.

The code consists of two capitals and a number in between.

- Code letter for the coating metal
- Code number for the minimum layer thickness
- Code letter for the type of passivation on top of the coating metal.

Code letter for the coating metal:

code letter	coating metal	chemical symbol
A	Zinc	Zn
B	Cadmium	Cd
C	Copper	Cu
D	Brass	CuZn
E	Nickel	Ni
F	Nickel-Chromium ¹	NiCr
G	Copper-Nickel	CuNi
H	Copper-Nickel-Chromium ¹	CuNiCr
J	Tin	Sn
K	Copper-Tin	CuSn
L	Silver	Ag
N	Copper-Silver	CuAg
P	Zinc-nickel	ZnNi
Q	Zinc-cobalt	ZnCo
R	Zinc-iron	ZnFe

¹Thickness of chrome layer ≈ 0.3µm.

Code number for the coating thickness:

code number	minimum layer thickness (coating structure) in μm	
	1 coating metal	2 coating metals
0 ²	-	-
1	3	-
2	5	2+3
3	8	3+5
4	12	4+8
5	15	5+10
6	20	8+12
7 ³	25	10+15
8 ³	30	12+18

²Code number 0 applies to screw threads below M1.6 where no specific layer thickness can be specified.

³Does not apply to threaded components.

Code letter for the chromate passivation layer:

code letter	finish	colour of the chromate passivation
A	dull	no colour
B		bluish to bluish iridescent ¹
C		yellowish to yellowish-brown, iridescent
D		olive green to olive brown
E	semi-bright	no colour
F		bluish to bluish iridescent ¹
G		yellowish to yellowish-brown, iridescent
H		olive green to olive brown
J	bright	no colour
K		bluish to bluish iridescent ¹
L		yellowish to yellowish-brown, iridescent
M		olive green to olive brown
N	high bright	no colour
P	optional	like method B, C or D
R	dull	brownish black to black
S	semi-bright	
T	bright	

¹Applies to Zn coating only

Example of coding: A3L

“A” means zinc-plated

“3” indicates the layer thickness of at least 8 μm

“L” refers to yellow chromating with a degree of gloss equal to “bright”

Example of designation: hexagon bolt ISO 4014 – M16 x 60 – 8.8 – A3L.

As a result of RoHS/ELV legislation and the high requirements of automotive industry for the corrosion resistance of Cr⁶⁺-free coatings, other passivation coatings and seals have been developed that are not yet standardized. More information can be requested at Fabory.

5.3 Hot dip galvanizing

Hot dip galvanized is defined as a protective zinc layer deposited onto the surface of steel parts, by immersing them in liquid zinc. Threaded parts generally need a spinning process immediately after the dip process. ISO 10684 (formerly DIN 267-10) specifies the material, process, dimensional and performance requirements for hot dip galvanized coatings applied to coarse thread steel fasteners from M8 up to M64.

Due to its high corrosion resistance in outdoor environment, hot dip galvanizing is the most applied coating system for fasteners in steel construction and building industry.

Internal thread is normally cut after the hot dip galvanizing process and is thus normally not coated. After assembly the internal thread is protected against corrosion by the hot dip galvanized external thread of the mating bolt.

The hot dip galvanizing of fasteners property class 10.9 involves specific procedures in order to prevent hydrogen embrittlement and microcracks in bolts \geq M27.

Coating thickness: minimum 40 μm .

Due to the thickness of the coating, being more than the normal allowance between 6g and 6H thread tolerance class, special measures must be taken:

1. "Oversize thread" system:
Standard bolts with thread tolerance class 6g are hot dip galvanized and become "oversize" thread. These bolts have to be combined with nuts that have been tapped "oversize" (about 0.3 mm larger) after galvanizing. Therefore, they are not the usual thread fit. These bolts and nuts must be used as a set. This combination is usually employed and is recommended.
2. ISO-thread system:
For the second method, in accordance with ISO 10684, the thread size after hot dip galvanizing complies with ISO 965-1 class 6h/6H. Before hot dip galvanizing the external thread must therefore be thinner than the normal tolerance class 6g (undersized thread). This means that the bolts after hot dip galvanizing have to meet the tolerance position 6h. These "ISO metric" hot dip galvanized bolts must be mated with nuts that have been normally tapped after galvanizing and so must meet the go-gauge with tolerance position 6H. This method creates the usual thread fit and can therefore be used with nuts or in tapped holes that have the standard ISO metric thread.

Important remarks:

Care must be taken not to mix bolts and nuts of the "oversize thread" system with "ISO-thread" system, as failure of the fastening is inevitable!

Attention is drawn to the fact that the proof loads of oversize tapped nuts and the proof loads of undersized threaded bolts and screws can be reduced as compared to the values specified in ISO 898-2 and ISO 898-1 respectively.

5.4 Zinc flake coatings

A zinc flake coating (acc. ISO 10683) is a non-electrolytically applied coating which is produced by applying to the surface of a fastener a zinc flake dispersion, possibly with the addition of aluminum flakes. A suitable medium generates a bonding amongst the flakes and also between flakes and steel through heat curing. The thus formed inorganic surface coating is electrically conducting and ensures cathodic protection.

Compared to most electro zinc coatings, these zinc flake treatments offer a much higher corrosion resistance, without risk for hydrogen embrittlement.

ISO 10683 defines zinc flake coatings both with or without Cr^{6+} . The standard assortment of Fabory is the chromium-free type of zinc flake coating. This is indicated in the ISO-standard as flZn/nc (fl = flake, Zn = Zinc, nc = no chrome).

The corrosion resistance of zinc flake coatings overperform conventional electro zinc plating by a multiple, with a comparable coating thickness. For its standard assortment, Fabory has chosen for a corrosion resistance of 480 hours for smaller thread diameters and 600 hours for the bigger sizes (>M8). The latter is specified in the ISO-standard as flZn/nc/600h.

Often neglected when specifying a coating, is the coefficient of friction. In most applications threaded fasteners must be tightened until a minimum clamping force is reached, without overloading nor the clamped parts, nor the fasteners themselves. Often this tightening process is controlled by a specified torque. Fabory has decided to choose for a lubricated zinc flake coating, with a coefficient of friction that is close to that of plain and normal zinc plated fasteners: $\mu_{\text{tot}} = 0,12 - 0,18$. The application of a lubricant is indicated with "L".

The zinc flake coatings selected for the standard Fabory assortment are specified compliant to ISO 10683 as "flZn/nc/L/480h" for fasteners up to M8 and as "flZn/nc/L/600h" for bigger sizes.

6 Inspection documents for fasteners

6.1 Test reports and certificates EN 10204

Originally inspection documents (certificate types) were specified in standard DIN 50049. The definitions of material testing and certificate types in DIN 50049 were the basis for European standard EN 10204, which was first published in 1991.

Both DIN 50049 and EN 10204 defined the certificate types 2.1, 2.2, 2.3, 3.1A, 3.1B, 3.1C and 3.2.

EN 10204 was last revised in 2004 with a simplified range of inspection documents (certificate types).

These now only include types 2.1, 2.2, 3.1 and 3.2.

Type 2.3 has been deleted.

Type 3.1 replaces 3.1B

Type 3.2 replaces 3.1A, 3.1C and 3.2 of the previous edition.

The table below shows the full range of current (C= edition 2004) and withdrawn (W=edition 1995) EN 10204 certificate types, with some interpretation of what they cover.

Certificate type	Title	Status	Summary of EN10204 requirements	Notes
2.1	Declaration of compliance with the order	C	Statement of compliance with the order by the manufacturer.	No test results shown.
2.2	Test report	C	Statement of compliance with the order by the manufacturer based on non-specific inspections (tests) by the manufacturer.	Sample test results from another lot number, manufactured by the same process route, can be used.
2.3	Specific test report	W	With mention of test results from specific inspection and testing	Test results of the supplied lot number are needed on the certificate. Certificate issued and signed by manufacturer's representative, who does not need to be independent of the manufacturing department.
3.1	Inspection certificate	C	Statement of compliance with the order by the manufacturer with results of specific inspection	Replaces 3.1B. Common certificate type issued for the supplied lot number. Cert. issued and signed by manufacturer's representative, who must be independent of the manufacturing department. E.g. Inspection department manager/supervisor.
3.1A	Inspection certificate 3.1A	W	With mention of test results from specific inspection and testing	Test results for supplied lot number. Cert. issued by independent inspector required by releasing authority (eg TUV for German pressure vessels). Replaced by 3.2 in 2004
3.1B	Inspection certificate 3.1B	W	With mention of test results from specific inspection and testing	Test results for supplied lot number. Cert. issued and signed by manufacturer's representative. Replaced by 3.1 in 2004
3.1C	Inspection certificate 3.1C	W	With mention of test results from specific inspection and testing	Test results for supplied lot number. Cert. issued by independent inspector appointed by customer (eg Lloyds, accredited laboratory). Replaced by 3.2 in 2004
3.2	Inspection certificate	C	Statement of compliance with order with indication of results of specific inspection	Test results for supplied lot number. Cert. issued by both manufacturer's representative and an independent inspector appointed either by the customer (cf withdrawn 3.1C) or an inspector designated by official regulations (cf withdrawn 3.1A). ie 3.2 now covers scope of both 3.1A and 3.1C of previous edition.

The laboratory of Fabory is accredited according ISO/IEC 17025 as an independent testing laboratory for mechanical testing of fasteners, including chemical analyses. Inspection certificates issued by the laboratory are according EN 10204 (1995) type 3.1.C.



6.2 PPAP documents

PPAP is an acronym for “Production Part Approval Process” and is usually pronounced “pee-pap”. The primary purpose of PPAP quality related documentation is to verify a manufacturer’s ability to produce and to consistently provide an automotive part that fully complies with purchase order requirements.

The PPAP system is unique to the automotive industry, however some other industries also are making use of it. The large amount of documentation is necessary to reduce the likelihood of an automotive part failure, which can reduce vehicle safety, vehicle reliability and customer satisfaction as well as interrupt new vehicle production.

Several PPAP Submission Levels are defined in the PPAP manual, published by the Automotive Industry Action Group (AIAG).

Five PPAP Submission Levels exist:

Level 1: Part Submission Warrant (PSW) only.

Level 2: PSW with product samples and limited supporting data.

Level 3: PSW with product samples and complete supporting data.

Level 4: PSW and other requirements as defined by the customer.

Level 5: PSW with product samples and complete supporting data available for review at the manufacturing location.

Generally a “Level 3” is required, for which the manufacturer must address an extensive list of topics:

- Design records
- Engineering changes
- Engineering approvals
- Design Failure Mode and Effects Analyses (DFMEA)
- Process flow diagrams
- Process Failure Mode and Effects Analysis (PFMEA)
- Control plan
- Measurement system analysis studies
- Dimensional results
- Material performance test results
- Initial process studies
- Qualified laboratory documentation
- Appearance Approval Report (if applicable)
- Sample product
- Records of compliance with customer-specific requirements
- Part Submission Warrant (PSW)

For (ISO, DIN, ...) standardized parts and in agreement with the customer, often the number of topics can be reduced significantly. Although generally PPAP documents must be set up by the manufacturer – by specific order - a customer can agree with Fabory to create a reduced PPAP by its accredited laboratory.

PPAP submissions generally are valid until a design or process change is made to a part by the manufacturer.

6.3 CE-certification

A large number of industrial products must be produced by a CE-certified manufacturer or given a CE mark. In the course of time, the number of products that require CE marking will be extended further.

The CE mark indicates that the product satisfies the European fundamental health and safety requirements required to bring the product to the market. These minimum requirements are listed in the European Guidelines. The Guidelines do not contain the detailed technical specifications of the products. These technical specifications have been included in – mostly European - standards for many products.

Fasteners for which CE-marking is required:

Due to Machinery directive (2006/42/EC):

DIN 580 resp. DIN 582: Lifting eye bolts and -nuts if used as lifting equipment.

Due to Construction Products Directive (89/106/EEC):

EN 14399: High-strength structural bolting assemblies for preloading.

EN 15048: Non-preloaded structural bolting assemblies.



For fasteners according to this Directive a Declaration of Performance (DoP) and a certificate according EN 10204 type 3.1 are available.

7 Directions for the design and assembly of fastenings

In order to ensure that threaded fastenings fulfil their function and do not work loose or fail, careful selection of the fasteners and the assembly method must be made for each individual application. Below information is based on the guideline VDI 2230:2003 "Systematic calculation of high duty bolted joints". Depending on the real assembly situation, it may be necessary to further investigate on the design and assembly directions.

Attention: For constructions that are covered by EN 1090, structural bolting (preloaded or non-preloaded) is to be assembled according to the methods described in the national editions of the European standards EN 1090 or EN 1993. Depending on the country, supplementary requirements may be applicable.

7.1 Tightening torque tables for steel bolted joints

7.1.1 Assembly preload / tightening torques - coarse pitch

The table on the next page applies to shank bolts with metric thread according to ISO 262, head dimensions of hexagon bolts as per ISO 4014 – 4018 respectively hexagon (hexalobular) socket screws as per ISO 4762, and in clearance holes "medium" according EN 20273.

Recommendations for tightening torques for other products different from the above mentioned standards and conditions (e.g. similar looking DIN specified products) **can not** be taken from this table and are available on request.

Nom. diameter	Property class	Assembly preload in N for $\mu_0 =$							Tightening torques M_A in Nm for $\mu_k = \mu_0 =$						
		0,08	0,10	0,12	0,14	0,16	0,20	0,24	0,08	0,10	0,12	0,14	0,16	0,20	0,24
M4	8.8	4 600	4 500	4 400	4 300	4 200	3 900	3 700	2,3	2,6	3,0	3,3	3,6	4,1	4,5
	10.9	6 800	6 700	6 500	6 300	6 100	5 700	5 400	3,3	3,9	4,6	4,8	5,3	6,0	6,6
	12.9	8 000	7 800	7 600	7 400	7 100	6 700	6 300	3,9	4,5	5,1	5,6	6,2	7,0	7,8
M5	8.8	7 600	7 400	7 200	7 000	6 800	6 400	6 000	4,4	5,2	5,9	6,5	7,1	8,1	9,0
	10.9	11 100	10 800	10 600	10 300	10 000	9 400	8 800	6,5	7,6	8,6	9,5	10,4	11,9	13,2
	12.9	13 000	12 700	12 400	12 000	11 700	11 000	10 300	7,6	8,9	10,0	11,2	12,2	14,0	15,5
M6	8.8	10 700	10 400	10 200	9 900	9 600	9 000	8 400	7,7	9,0	10,1	11,3	12,3	14,1	15,6
	10.9	15 700	15 300	14 900	14 500	14 100	13 200	12 400	11,3	13,2	14,9	16,5	18,0	20,7	22,9
	12.9	18 400	17 900	17 500	17 000	16 500	15 500	14 500	13,2	15,4	17,4	19,3	21,3	24,2	26,8
M7	8.8	15 500	15 100	14 800	14 400	14 000	13 100	12 300	12,6	14,8	16,8	18,7	20,5	23,6	26,2
	10.9	22 700	22 500	21 700	21 100	20 500	19 300	18 100	18,5	21,7	24,7	27,5	30,1	34,7	38,5
	12.9	26 600	26 000	25 400	24 700	24 000	22 600	21 200	21,6	25,4	28,9	32,2	35,2	40,6	45,1
M8	8.8	19 500	19 100	18 600	18 100	17 600	16 500	15 500	18,5	21,6	24,6	27,3	29,8	34,3	38,0
	10.9	28 700	28 000	27 300	26 600	25 800	24 300	22 700	27,2	31,8	36,1	40,1	43,8	50,3	55,8
	12.9	33 600	32 800	32 000	31 100	30 200	28 400	26 600	31,8	37,2	42,2	46,9	51,2	58,9	65,3
M10	8.8	31 000	30 300	29 600	28 800	27 900	26 300	24 700	36	43	48	54	59	68	75
	10.9	45 600	44 500	43 400	42 200	41 000	38 600	36 200	53	63	71	79	87	100	110
	12.9	53 300	52 100	50 800	49 400	48 000	45 200	42 400	62	73	83	93	101	116	129
M12	8.8	45 200	44 100	43 000	41 900	40 700	38 300	35 900	63	73	84	93	102	117	130
	10.9	66 300	64 800	63 200	61 500	59 800	56 300	52 800	92	108	123	137	149	172	191
	12.9	77 600	75 900	74 000	72 000	70 000	65 800	61 800	108	126	144	160	175	201	223
M14	8.8	62 000	60 600	59 100	57 500	55 900	52 600	49 300	100	117	133	148	162	187	207
	10.9	91 000	88 900	86 700	84 400	82 100	77 200	72 500	146	172	195	218	238	274	304
	12.9	106 500	104 100	101 500	98 800	96 000	90 400	84 800	171	201	229	255	279	321	356
M16	8.8	84 700	82 900	80 900	78 800	76 600	72 200	67 800	153	180	206	230	252	291	325
	10.9	124 400	121 700	118 800	115 700	112 600	106 100	99 600	224	264	302	338	370	428	477
	12.9	145 500	142 400	139 000	135 400	131 700	124 100	116 600	262	309	354	395	433	501	558
M18	8.8	107 000	104 000	102 000	99 000	96 000	91 000	85 000	220	259	295	329	360	415	462
	10.9	152 000	149 000	145 000	141 000	137 000	129 000	121 000	314	369	421	469	513	592	657
	12.9	178 000	174 000	170 000	165 000	160 000	151 000	142 000	367	432	492	549	601	692	769
M20	8.8	136 000	134 000	130 000	127 000	123 000	116 000	109 000	308	363	415	464	509	588	655
	10.9	194 000	190 000	186 000	181 000	176 000	166 000	156 000	438	517	592	661	725	838	933
	12.9	227 000	223 000	217 000	212 000	206 000	194 000	182 000	513	605	692	773	848	980	1092
M22	8.8	170 000	166 000	162 000	158 000	154 000	145 000	137 000	417	495	567	634	697	808	901
	10.9	242 000	237 000	231 000	225 000	219 000	207 000	194 000	595	704	807	904	993	1 151	1 284
	12.9	283 000	277 000	271 000	264 000	257 000	242 000	228 000	696	824	945	1 057	1 162	1 347	1 502
M24	8.8	196 000	192 000	188 000	183 000	178 000	168 000	157 000	529	625	714	798	875	1 011	1 126
	10.9	280 000	274 000	267 000	260 000	253 000	239 000	224 000	754	890	1 017	1 136	1 246	1 440	1 604
	12.9	327 000	320 000	313 000	305 000	296 000	279 000	262 000	882	1 041	1 190	1 329	1 458	1 685	1 877
M27	8.8	257 000	252 000	246 000	240 000	234 000	220 000	207 000	772	915	1 050	1 176	1 292	1 498	1 672
	10.9	367 000	359 000	351 000	342 000	333 000	314 000	295 000	1 100	1 304	1 496	1 674	1 840	2 134	2 381
	12.9	429 000	420 000	410 000	400 000	389 000	367 000	345 000	1 287	1 526	1 750	1 959	2 153	2 497	2 787
M30	8.8	313 000	307 000	300 000	292 000	284 000	268 000	252 000	1 053	1 246	1 428	1 597	1 754	2 031	2 265
	10.9	446 000	437 000	427 000	416 000	405 000	382 000	359 000	1 500	1 775	2 033	2 274	2 498	2 893	3 226
	12.9	522 000	511 000	499 000	487 000	474 000	447 000	420 000	1 755	2 077	2 380	2 662	2 923	3 386	3 775
M33	8.8	389 000	381 000	373 000	363 000	354 000	334 000	314 000	1 415	1 679	1 928	2 161	2 377	2 759	3 081
	10.9	554 000	543 000	531 000	517 000	504 000	475 000	447 000	2 015	2 392	2 747	3 078	3 385	3 930	4 388
	12.9	649 000	635 000	621 000	605 000	589 000	556 000	523 000	2 358	2 799	3 214	3 601	3 961	4 598	5 135
M36	8.8	458 000	448 000	438 000	427 000	415 000	392 000	368 000	1 825	2 164	2 482	2 778	3 054	3 541	3 951
	10.9	652 000	638 000	623 000	608 000	591 000	558 000	524 000	2 600	3 082	3 535	3 957	4 349	5 043	5 627
	12.9	763 000	747 000	729 000	711 000	692 000	653 000	614 000	3 042	3 607	4 136	4 631	5 089	5 902	6 585
M39	8.8	548 000	537 000	525 000	512 000	498 000	470 000	443 000	2 348	2 791	3 208	3 597	3 958	4 598	5 137
	10.9	781 000	765 000	748 000	729 000	710 000	670 000	630 000	3 345	3 975	4 569	5 123	5 637	6 549	7 317
	12.9	914 000	895 000	875 000	853 000	831 000	784 000	738 000	3 914	4 652	5 346	5 994	6 596	7 664	8 562

7.1.2 Assembly preload / tightening torques - fine pitch

The table below applies to shank bolts with fine metric thread according to ISO 262, head dimensions of hexagon bolts as per ISO 4014 – 4018 respectively hexagon (hexalobular) socket screws as per ISO 4762, and in clearance holes “medium” according to EN 20273. Recommendations for tightening torques for other products different from the above mentioned standards and conditions (e.g. similar looking DIN specified products) **can not** be taken from this table and are available on request.

Nom. diameter	Property class	Assembly preload F_M in N for $\mu_o =$							Tightening torques M_A in Nm for $\mu_k = \mu_o =$						
		0,08	0,10	0,12	0,14	0,16	0,20	0,24	0,08	0,10	0,12	0,14	0,16	0,20	0,24
M8x1	8.8	21 200	20 700	20 200	19 700	19 200	18 100	17 000	19,3	22,8	26,1	29,2	32,0	37,0	41,2
	10.9	31 100	30 400	29 700	28 900	28 100	26 500	24 900	28,4	33,5	38,3	42,8	47,0	54,3	60,5
	12.9	36 400	35 600	34 700	33 900	32 900	31 000	29 100	33,2	39,2	44,9	50,1	55,0	63,6	70,8
M9x1	8.8	27 700	27 200	26 500	25 900	25 200	23 700	22 300	28,0	33,2	38,1	42,6	46,9	54,4	60,7
	10.9	40 700	39 900	39 000	38 000	37 000	34 900	32 800	41,1	48,8	55,9	62,6	68,8	79,8	89,1
	12.9	47 700	46 700	45 600	44 400	43 300	40 800	38 400	48,1	57,0	65,4	73,3	80,6	93,4	104,3
M10x1	8.8	35 200	34 500	33 700	32 900	32 000	30 200	28 400	39	46	53	60	66	76	85
	10.9	51 700	50 600	49 500	48 300	47 000	44 400	41 700	57	68	78	88	97	112	125
	12.9	60 400	59 200	57 900	56 500	55 000	51 900	48 800	67	80	91	103	113	131	147
M10x1,25	8.8	33 100	32 400	31 600	30 800	29 900	28 200	26 500	38	44	51	57	62	72	80
	10.9	48 600	47 500	46 400	45 200	44 000	41 400	38 900	55	65	75	83	92	106	118
	12.9	56 800	55 600	54 300	52 900	51 400	48 500	45 500	65	76	87	98	107	124	138
M12x1,25	8.8	50 100	49 100	48 000	46 800	45 600	43 000	40 400	66	79	90	101	111	129	145
	10.9	73 600	72 100	70 500	68 700	66 900	63 200	59 400	97	116	133	149	164	190	212
	12.9	86 200	84 400	82 500	80 400	78 300	73 900	69 500	114	135	155	174	192	222	249
M12x1,5	8.8	47 600	46 600	45 500	44 300	43 100	40 600	38 200	64	76	87	97	107	123	137
	10.9	70 000	68 500	66 800	65 100	63 300	59 700	56 000	95	112	128	143	157	181	202
	12.9	81 900	80 100	78 200	76 200	74 100	69 800	65 600	111	131	150	167	183	212	236
M14x1,5	8.8	67 800	66 400	64 800	63 200	61 500	58 100	54 600	104	124	142	159	175	203	227
	10.9	99 500	97 500	95 200	92 900	90 400	85 300	80 200	153	182	209	234	257	299	333
	12.9	116 500	114 100	111 400	108 700	105 800	99 800	93 900	179	213	244	274	301	349	390
M16x1,5	8.8	91 400	89 600	87 600	85 500	83 200	78 600	74 000	159	189	218	244	269	314	351
	10.9	134 200	131 600	128 700	125 500	122 300	115 500	108 700	233	278	320	359	396	461	515
	12.9	157 100	154 000	150 600	146 900	143 100	135 100	127 200	273	325	374	420	463	539	603
M18x1,5	8.8	122 000	120 000	117 000	115 000	112 000	105 000	99 000	237	283	327	368	406	473	530
	10.9	174 000	171 000	167 000	163 000	159 000	150 000	141 000	337	403	465	523	578	674	755
	12.9	204 000	200 000	196 000	191 000	186 000	176 000	166 000	394	472	544	613	676	789	884
M18x2	8.8	114 000	112 000	109 000	107 000	104 000	98 000	92 000	229	271	311	348	383	444	495
	10.9	163 000	160 000	156 000	152 000	148 000	139 000	131 000	326	386	443	496	545	632	706
	12.9	191 000	187 000	182 000	178 000	173 000	163 000	153 000	381	452	519	581	638	740	826
M20x1,5	8.8	154 000	151 000	148 000	144 000	141 000	133 000	125 000	327	392	454	511	565	660	741
	10.9	219 000	215 000	211 000	206 000	200 000	190 000	179 000	466	558	646	728	804	940	1055
	12.9	257 000	252 000	246 000	241 000	234 000	222 000	209 000	545	653	756	852	941	1100	1234
M22x1,5	8.8	189 000	186 000	182 000	178 000	173 000	164 000	154 000	440	529	613	692	765	896	1006
	10.9	269 000	264 000	259 000	253 000	247 000	233 000	220 000	627	754	873	985	1090	1276	1433
	12.9	315 000	309 000	303 000	296 000	289 000	273 000	257 000	734	882	1022	1153	1275	1493	1677
M24x1,5	8.8	228 000	224 000	219 000	214 000	209 000	198 000	187 000	570	686	796	899	995	1166	1311
	10.9	325 000	319 000	312 000	305 000	298 000	282 000	266 000	811	977	1133	1280	1417	1661	1867
	12.9	380 000	373 000	366 000	357 000	347 000	330 000	311 000	949	1143	1326	1498	1658	1943	2185
M24x2	8.8	217 000	213 000	209 000	204 000	198 000	187 000	177 000	557	666	769	865	955	1114	1248
	10.9	310 000	304 000	297 000	290 000	282 000	267 000	251 000	793	949	1095	1232	1360	1586	1777
	12.9	362 000	355 000	348 000	339 000	331 000	312 000	294 000	928	1110	1282	1442	1591	1856	2080
M27x1,5	8.8	293 000	288 000	282 000	276 000	269 000	255 000	240 000	822	992	1153	1304	1445	1697	1910
	10.9	418 000	410 000	402 000	393 000	383 000	363 000	342 000	1171	1413	1643	1858	2059	2417	2720
	12.9	489 000	480 000	470 000	460 000	448 000	425 000	401 000	1370	1654	1922	2174	2409	2828	3183
M27x2	8.8	281 000	276 000	270 000	264 000	257 000	243 000	229 000	806	967	1119	1262	1394	1630	1829
	10.9	400 000	393 000	384 000	375 000	366 000	346 000	326 000	1149	1378	1594	1797	1986	2322	2605
	12.9	468 000	460 000	450 000	439 000	428 000	405 000	382 000	1344	1612	1866	2103	2324	2717	3049
M30x2	8.8	353 000	347 000	339 000	331 000	323 000	306 000	288 000	1116	1343	1556	1756	1943	2276	2557
	10.9	503 000	494 000	483 000	472 000	460 000	436 000	411 000	1590	1912	2216	2502	2767	3241	3641
	12.9	588 000	578 000	565 000	552 000	539 000	510 000	481 000	1861	2238	2594	2927	3238	3793	4261
M33x2	8.8	433 000	425 000	416 000	407 000	397 000	376 000	354 000	1489	1794	2082	2352	2605	3054	3435
	10.9	617 000	606 000	593 000	580 000	565 000	535 000	505 000	2120	2555	2965	3350	3710	4350	4892
	12.9	722 000	709 000	694 000	678 000	662 000	626 000	591 000	2481	2989	3470	3921	4341	5090	5725
M36x2	8.8	521 000	512 000	502 000	490 000	478 000	453 000	427 000	1943	2345	2725	3082	3415	4010	4513
	10.9	742 000	729 000	714 000	698 000	681 000	645 000	609 000	2767	3340	3882	4390	4864	5711	6428
	12.9	869 000	853 000	836 000	817 000	797 000	755 000	712 000	3238	3908	4542	5137	5692	6683	7522
M39x2	8.8	618 000	607 000	595 000	581 000	567 000	537 000	507 000	2483	3002	3493	3953	4383	5151	5801
	10.9	880 000	864 000	847 000	828 000	808 000	765 000	722 000	3537	4267	4974	5631	6243	7336	8263
	12.9	1030 000	1011 000	991 000	969 000	945 000	896 000	845 000	4139	5003	5821	6589	7306	8585	9669

7.2 Tightening torque tables for stainless steel bolted joints

7.2.1 Assembly preload / tightening torques

The values below apply to austenitic stainless steel hexagon bolts ISO 4014 – 4018 respectively hexagon (hexalobular) socket screws as per ISO 4762. The torques are theoretically calculated values depending on the chosen friction coefficient and based on a preload, utilizing 90% of the minimum yield strength during assembly. Recommendations for tightening torques for other products different from the above mentioned standards and conditions (e.g. similar looking DIN specified products) **can not** be taken from this table and are available on request.

Friction coefficient		Assembly preload F_M in kN for $\mu_G =$								Tightening torque M_A in Nm for $\mu_K = \mu_G =$							
Basic diameter	class	0,10	0,12	0,14	0,16	0,18	0,20	0,30	0,40	0,10	0,12	0,14	0,16	0,18	0,20	0,30	0,40
M4	50	1,46	1,41	1,37	1,32	1,28	1,24	1,04	0,88	0,83	0,94	1,04	1,12	1,20	1,28	1,55	1,72
	70	3,12	3,03	2,93	2,84	2,74	2,65	2,22	1,88	1,79	2,01	2,22	2,41	2,58	2,73	3,32	3,68
	80	4,16	4,04	3,91	3,78	3,65	3,53	2,96	2,51	2,38	2,68	2,96	3,21	3,44	3,64	4,42	4,91
M5	50	2,38	2,32	2,25	2,17	2,10	2,03	1,71	1,45	1,65	1,86	2,06	2,24	2,41	2,55	3,12	3,47
	70	5,11	4,96	4,81	4,66	4,51	4,36	3,67	3,11	3,54	4,00	4,42	4,80	5,15	5,47	6,68	7,43
	80	6,81	6,62	6,41	6,21	6,01	5,81	4,89	4,15	4,72	5,33	5,89	6,40	6,87	7,30	8,91	9,90
M6	50	3,36	3,26	3,16	3,06	2,96	2,86	2,40	2,04	2,86	3,23	3,57	3,88	4,16	4,42	5,38	5,98
	70	7,20	6,99	6,77	6,56	6,34	6,13	5,15	4,37	6,14	6,92	7,65	8,31	8,91	9,46	11,53	12,81
	80	9,60	9,32	9,03	8,74	8,45	8,17	6,87	5,83	8,18	9,23	10,20	11,08	11,88	12,62	15,37	17,08
M8	50	6,2	6,0	5,8	5,6	5,5	5,3	4,4	3,8	7,0	7,9	8,7	9,5	10,2	10,8	13,3	14,8
	70	13,2	12,8	12,5	12,1	11,7	11,3	9,5	8,1	14,9	16,9	18,7	20,3	21,8	23,2	28,4	31,6
	80	17,6	17,1	16,6	16,1	15,6	15,1	12,7	10,8	19,9	22,5	24,9	27,1	29,1	30,9	37,9	42,2
M10	50	9,8	9,5	9,3	9,0	8,7	8,4	7,1	6,0	13,7	15,6	17,2	18,8	20,2	21,5	26,4	29,4
	70	21,0	20,5	19,9	19,2	18,6	18,0	15,2	12,9	29,4	33,3	37,0	40,3	43,3	46,1	56,5	63,0
	80	28,1	27,3	26,5	25,7	24,8	24,0	20,3	17,2	39,2	44,5	49,3	53,7	57,7	61,4	75,4	84,0
M12	50	14,3	13,9	13,5	13,1	12,7	12,3	10,4	8,8	23,7	26,9	29,8	32,5	35,0	37,2	45,8	51,1
	70	30,7	29,8	29,0	28,1	27,2	26,3	22,2	18,9	50,8	57,7	63,9	69,7	75,0	79,8	98,1	109,4
	80	40,9	39,8	38,6	37,4	36,2	35,1	29,6	25,2	67,8	76,9	85,3	93,0	100,0	106,4	130,8	145,9
M14	50	19,6	19,0	18,5	17,9	17,4	16,8	14,2	12,1	38,2	43,4	48,2	52,6	56,6	60,3	74,2	82,9
	70	41,9	40,8	39,6	38,4	37,2	36,0	30,4	25,9	81,9	93,0	103,3	112,7	121,3	129,2	159,0	177,6
	80	55,9	54,4	52,8	51,2	49,6	48,0	40,6	34,5	109,3	124,1	137,7	150,3	161,8	172,3	212,0	236,7
M16	50	27,0	26,3	25,6	24,8	24,1	23,3	19,8	16,8	58,3	66,4	74,0	80,9	87,3	93,1	115,3	129,2
	70	57,8	56,4	54,8	53,2	51,6	49,9	42,4	36,1	124,8	142,3	158,5	173,4	187,1	199,6	247,1	276,8
	80	77,1	75,1	73,1	70,9	68,8	66,6	56,5	48,1	166,4	189,8	211,4	231,2	249,5	266,1	329,5	369,1
M18	50	32,9	32,0	31,1	30,2	29,3	28,3	24,0	20,4	81,7	92,8	103,1	112,6	121,2	129,1	159,2	177,9
	70	70,6	68,7	66,7	64,7	62,7	60,7	51,4	43,7	175,0	198,9	220,9	241,2	259,8	276,7	341,1	381,2
	80	94,1	91,6	89,0	86,3	83,6	80,9	68,5	58,3	233,3	265,2	294,6	321,6	346,4	369,0	454,8	508,3
M20	50	42,1	41,1	39,9	38,8	37,6	36,4	30,9	26,3	114,0	130,0	144,8	158,5	171,0	182,4	226,0	253,2
	70	90,3	88,0	85,5	83,0	80,5	78,0	66,2	56,4	244,4	278,6	310,4	339,6	366,4	390,9	484,3	542,6
	80	120,4	117,3	114,1	110,7	107,4	104,0	88,2	75,2	325,8	371,5	413,8	452,8	488,6	521,2	645,7	723,5
M22	50	52,4	51,1	49,8	48,3	46,9	45,5	38,6	33,0	153,0	174,9	195,2	214,0	231,2	247,0	307,2	344,9
	70	112,4	109,6	106,6	103,6	100,5	97,4	82,8	70,6	327,8	374,8	418,4	458,6	495,5	529,3	658,3	739,1
	80	149,8	146,1	142,2	138,1	134,0	129,9	110,4	94,1	437,1	499,7	557,8	611,4	660,7	705,7	877,8	985,5
M24	50	61	59	58	56	54	52	45	38	197	224	250	273	295	314	389	436
	70	130	127	123	120	116	112	95	81	421	480	535	585	632	674	835	935
	80	173	169	164	160	155	150	127	108	562	640	713	781	842	898	1113	1247
M27	50	80	78	76	73	71	69	59	50	289	331	369	405	438	468	583	655
	70	170	166	162	157	153	148	126	107	619	708	791	868	938	1003	1249	1403
M30	50	97	95	92	89	87	84	71	61	394	450	502	550	594	635	789	886
	70	208	203	197	191	186	180	153	130	843	964	1076	1179	1273	1360	1691	1898
M33	50	121	118	115	111	108	105	89	76	531	609	681	747	808	864	1079	1213
M36	50	142	138	134	131	127	123	105	89	684	782	874	959	1036	1108	1380	1551
M39	50	170	166	161	157	152	148	126	108	883	1013	1133	1245	1347	1441	1802	2028

7.3 Coefficients of friction μ_G and μ_K

Table below gives guidance for the choice of friction coefficients μ_G and μ_K (μ_G = coefficient of friction of screw thread / μ_K = coefficient of friction of bolt head or nut bearing surface). Depending on the detailed specification of the applied materials and lubricants, the friction coefficient can vary significantly.

Typical examples		Friction coefficient μ_G and μ_K
Material / surface	Lubricant	
Metallicly bright Black oxide Phosphated Galvanic coatings such as: Zn, Zn/Fe, Zn/Ni Zincflake coatings	Solid lubricants, such as: MoS ₂ , graphite, PTFE, PA, PE, PI in lubricating varnishes as top coating or in pastes; Liquefied wax Wax dispersions	0,04 to 0,10
Metallicly bright Black oxide Phosphated Galvanic coatings such as: Zn, Zn/Fe, Zn/Ni Zincflake coatings Al and Mg alloys	Solid lubricants, such as: MoS ₂ , graphite, PTFE, PA, PE, PI in lubricating varnishes as top coating or in pastes; Liquefied wax Wax dispersions, greases; Oils; delivery state	0,08 to 0,16
Hot- galvanized	MoS ₂ , graphite; Wax dispersions	
Organic coatings	With integrated solid lubricant or wax dispersion	
Austenitic steel	Solid lubricants or waxes; pastes	
Austenitic steel	Wax dispersion, pastes	0,14 to 0,24
Metallicly bright Phosphated	Delivery state (light oiled)	
Galvanic coatings such as: Zn, Zn/Fe, Zn/Ni Zincflake coatings adhesive	none	
Austenitic steel	oil	0,20 to 0,35
Galvanic coatings such as: Zn, Zn/Fe; Hot- galvanized	none	
Galvanic coatings such as: Zn/Fe, Zn/Ni; Austenitic steel Al and Mg alloys	none	≥ 0,30

Note: If the coefficients of frictions are not experimentally determined, application of the smallest friction values from this table will reduce the risk of overtightening. **(Fabory Technology dept. is able to do frictional test on special request and for critical applications.)**

7.4 Tightening torque tables for steel inch threaded bolts

As for metric threaded fasteners, also the determination of the assembly torque for inch threaded bolts is based on a number of factors, of which the coefficient of friction is very important. The American approach, according to SAE J1701, is quite different from the European.

Below tables are based upon the empirical torque/tension formula $T = K \times d \times W$

Where T = Torque
 K = Coefficient of Friction factor
 d = Nominal thread diameter (inches)
 W = Tension (clamp load or preload) induced in fastener (lbs)

The value of "K" can range from over 0,30 for a rusted assembly to 0,10 or less for a clean assembly well lubricated with a teflon or MoS₂ based lubricant. The above formula proves the high importance of the value of the K-factor as a 0,10 to 0,30 range causes an extremely wide variation of the torque.

For assemblies of medium critical level the following K-values are often used:

Mating parts	K-factor
Dry, clean with thin film of oil	0,15 – 0,20
Additional lubricating coatings of oil, wax, or dissimilar plating or hard washer	0,10 – 0,15
Thread and head bearing surfaces Covered with high-performance Lubricants or with anti-seize Components	can be as low as 0,05
Combinations of certain materials such as Austenite stainless steel screws/bolts and parts not lubricated or coated	can be as high as 0,35

Especially for critical joints, the only way to determine the correct torque is through testing under actual joint and assembly conditions, using a calibrated torque wrench and a load indicating tester such as a Skidmore-Wilhelm device or a more sophisticated strain gauge based transducer.

7.4.1 Assembly preload / tightening torques – UNC (coarse thread)

Below table provides the tightening torque for UNC Hex Bolts according to ASME B18.2.1., for general applications. These assembly torques are offered as a general guide only as torque is a very indirect indication of tension and there are many factors such as friction, lubrication, surface texture, corrosion, etc. that affect the outcome.

Nom. diameter		Threads/in	Grade	Clamp load W (*)		Tightening torque for K =					
Fractions	Decimals			lbs	N	0.10		0.15		0.20	
						lbs.ft	Nm	lbs.ft	Nm	lbs.ft	Nm
¼	0,250	20	Grade 2	1 313	5 839	3	4	4	6	5	7
			Grade 5	2 029	9 023	4	6	6	9	8	11
			Grade 8	2 864	12 739	6	8	9	12	12	16
⅕	0,3125	18	Grade 2	2 163	9 620	6	8	8	11	11	15
			Grade 5	3 342	14 868	9	12	13	18	17	24
			Grade 8	4 719	20 990	12	17	18	25	25	33
⅙	0,375	16	Grade 2	3 196	14 219	10	14	15	20	20	27
			Grade 5	4 940	21 974	15	21	23	31	31	42
			Grade 8	6 974	31 022	22	30	33	44	44	59
⅚	0,4375	14	Grade 2	4 385	19 505	16	22	24	33	32	43
			Grade 5	6 777	30 144	25	33	37	50	49	67
			Grade 8	9 567	42 556	35	47	52	71	70	95
½	0,500	13	Grade 2	5 853	26 037	24	33	37	50	49	66
			Grade 5	9 046	40 239	38	51	57	77	75	102
			Grade 8	12 771	56 808	53	72	80	108	106	144
⅝	0,5625	12	Grade 2	7 503	33 377	35	48	53	72	70	95
			Grade 5	11 596	51 582	54	74	82	111	109	147
			Grade 8	16 371	72 821	77	104	115	156	153	208
⅗	0,625	11	Grade 2	9 323	41 468	49	66	73	99	97	132
			Grade 5	14 408	64 087	75	102	113	153	150	203
			Grade 8	20 340	90 476	106	144	159	215	212	287
¾	0,750	10	Grade 2	13 796	61 369	86	117	129	175	172	234
			Grade 5	21 322	94 844	133	181	200	271	267	361
			Grade 8	30 101	133 897	188	255	282	383	376	510
⅘	0,875	9	Grade 2	11 427	50 830	83	113	125	169	167	226
			Grade 5	19 045	84 717	139	188	208	282	278	377
			Grade 8	41 553	184 836	303	411	454	616	606	822
1	1,000	8	Grade 2	14 992	66 688	125	169	187	254	250	339
			Grade 5	38 616	171 771	322	436	483	654	644	873
			Grade 8	54 517	242 501	454	616	681	924	909	1 232
1⅕	1,125	7	Grade 2	18 892	84 034	177	240	266	360	354	480
			Grade 5	42 363	188 440	397	538	596	808	794	1 077
			Grade 8	68 697	305 578	644	873	966	1 310	1 288	1 746
1¼	1,250	7	Grade 2	23 985	106 691	250	339	375	508	500	677
			Grade 5	53 785	239 247	560	760	840	1 139	1 120	1 519
			Grade 8	87 219	387 968	909	1 232	1 363	1 848	1 817	2 464
1⅝	1,375	6	Grade 2	28 584	127 146	328	444	491	666	655	888
			Grade 5	64 097	285 116	734	996	1 102	1 494	1 469	1 991
			Grade 8	103 941	462 350	1 191	1 615	1 786	2 422	2 382	3 229
1½	1,500	6	Grade 2	34 781	154 714	435	589	652	884	870	1 179
			Grade 5	77 994	346 934	975	1 322	1 462	1 983	1 950	2 644
			Grade 8	126 477	562 595	1 581	2 143	2 371	3 215	3 162	4 287

Conversion of torque values: 1 lbs in = 0,11298 Nm 1 lbs ft = 1,35581 Nm ;
 1 Nm = 8,85074 lbs in 1 Nm = 0,73756 lbs ft

(*) Clamp load (pre-load) W in this table has been calculated by assuming that usable bolt strength is 75% of bolt proof-load times the proof stress area of the thread. Depending on the application, the clamp-load may be chosen lower (e.g. because clamped materials are soft) or higher (e.g. if the assembly conditions are very accurate, the K-factor was tested for this application and if the clamp-load should be as high as possible to reduce the risk of failure by fatigue)

7.4.2 Assembly preload / tightening torques – UNF (fine thread)

Below table provides the tightening torque for UNF Hex Bolts according to ASME B18.2.1., for general applications. These assembly torques are offered as a general guide only as torque is a very indirect indication of tension and there are many factors such as friction, lubrication, surface texture, corrosion, etc. that affect the outcome.

Nom. diameter		Threads/in	Grade	Clamp load W (*)		Tightening torque for K =					
Fractions	Decimals			lbs	N	0.10		0.15		0.20	
						lbs.ft	Nm	lbs.ft	Nm	lbs.ft	Nm
¼	0,250	28	Grade 2	1 502	6 679	3	4	5	6	6	8
			Grade 5	2 321	10 322	5	7	7	10	10	13
			Grade 8	3 276	14 572	7	9	10	14	14	19
⅕	0,3125	24	Grade 2	2 397	10 661	6	8	9	13	12	17
			Grade 5	3 704	16 476	10	13	14	20	19	26
			Grade 8	5 229	23 260	14	18	20	28	27	37
⅜	0,375	24	Grade 2	3 622	16 110	11	15	17	23	23	31
			Grade 5	5 597	24 898	17	24	26	36	35	47
			Grade 8	7 902	35 150	25	33	37	50	49	67
⅞	0,4375	20	Grade 2	4 896	21 780	18	24	27	36	36	48
			Grade 5	7 567	33 660	28	37	41	56	55	75
			Grade 8	10 683	47 520	39	53	58	79	78	106
½	0,500	20	Grade 2	6 600	29 358	27	37	41	56	55	75
			Grade 5	10 200	45 372	42	58	64	86	85	115
			Grade 8	14 400	64 054	60	81	90	122	120	163
⅝	0,5625	18	Grade 2	8 374	37 248	39	53	59	80	79	106
			Grade 5	12 941	57 565	61	82	91	123	121	164
			Grade 8	18 270	81 269	86	116	128	174	171	232
¾	0,625	18	Grade 2	10 560	46 973	55	75	82	112	110	149
			Grade 5	16 320	72 595	85	115	127	173	170	230
			Grade 8	23 040	102 487	120	163	180	244	240	325
⅞	0,750	16	Grade 2	15 386	68 441	96	130	144	196	192	261
			Grade 5	23 779	105 773	149	201	223	302	297	403
			Grade 8	33 570	149 326	210	284	315	427	420	569
1	0,875	14	Grade 2	12 610	56 092	92	125	138	187	184	249
			Grade 5	21 017	93 487	153	208	230	312	306	416
			Grade 8	45 855	203 972	334	453	502	680	669	907
1 ¼	1,000	12	Grade 2	16 409	72 992	137	185	205	278	273	371
			Grade 5	42 266	188 009	352	478	528	716	704	955
			Grade 8	59 670	265 424	497	674	746	1 011	994	1 348
1 ½	1,125	12	Grade 2	21 179	94 207	199	269	298	404	397	538
			Grade 5	47 491	211 251	445	604	668	905	890	1 207
			Grade 8	77 013	342 569	722	979	1 083	1 468	1 444	1 958
1 ¾	1,250	12	Grade 2	26 554	118 119	277	375	415	563	553	750
			Grade 5	59 546	264 872	620	841	930	1 261	1 240	1 682
			Grade 8	96 561	429 523	1 006	1 364	1 509	2 046	2 012	2 727
1 ⅝	1,375	12	Grade 2	32 539	144 739	373	505	559	758	746	1 011
			Grade 5	72 966	324 567	836	1 134	1 254	1 700	1 672	2 267
			Grade 8	118 323	526 324	1 356	1 838	2 034	2 757	2 711	3 676
1 ⅞	1,500	12	Grade 2	39 130	174 057	489	663	734	995	978	1 326
			Grade 5	87 746	390 310	1 097	1 487	1 645	2 231	2 194	2 974
			Grade 8	142 290	632 934	1 779	2 411	2 668	3 617	3 557	4 823

Conversion of torque values: 1 lbs in = 0,11298 Nm 1 lbs ft = 1,35581 Nm ;
 1 Nm = 8,85074 lbs in 1 Nm = 0,73756 lbs ft

(*) Clamp load (pre-load) W in this table has been calculated by assuming that usable bolt strength is 75% of bolt proof-load times the proof stress area of the thread. Depending on the application, the clamp-load may be chosen lower (e.g. because clamped materials are soft) or higher (e.g. if the assembly conditions are very accurate, the K-factor was tested for this application and if the clamp-load should be as high as possible to reduce the risk of failure by fatigue)

7.5 Galling (seizing) of stainless steel

The high ductility of austenitic stainless steel means that it is in general more susceptible to galling than normal steels. To avoid galling, the product must be clean, free of burs, foreign matter, chips, sand, etc. and one-sided clamping due to damage to the screw thread or crooked assembly must be avoided. Rigid joints perform better than elastic ones.

It is advisable to torque as uniformly as possible at low speed and not to use impact wrenches. It is noted that to induce a certain preload, it is not only the coefficients of friction that are important, but also the accuracy of the method used to tighten the bolts. The combination of two different grades of stainless steel (e.g. A2 and A4) is not advantageous as far as galling is concerned. In special circumstances and for special requirements a suitable (anti galling) lubricant / paste or pre-applied dry coating should be used. e.g.: lubricant/paste; chloride-paraffin, molykote lacquer, high pressure oil, corrosion-resistant grease or dry coating; Metalform and Combiflon, etc.

7.6 Screw-in depths for blind holes

The figure below shows the recommended minimum screw-in depths for blind holes in combination with various property classes, related to the shear strength of the material in which the bolt is attached.

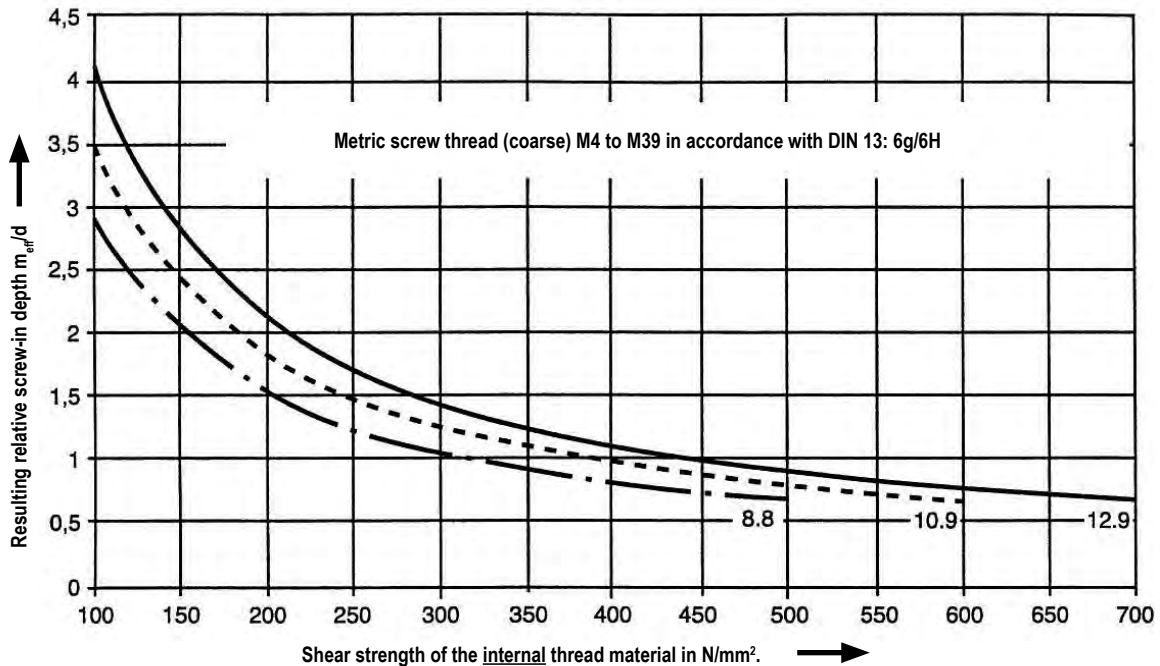

m_{eff} = effective screw-in depth.
 d = nominal diameter

7.7 Ratio of shear strength to tensile strength

The table below is based on VDI 2230 (2003)

Property class	4.6	5.6	8.8	10.9	12.9
t_b / R_m	0,70	0,70	0,65	0,62	0,60

7.8 Clamping length table for preloaded bolts HV according to EN 14399-4

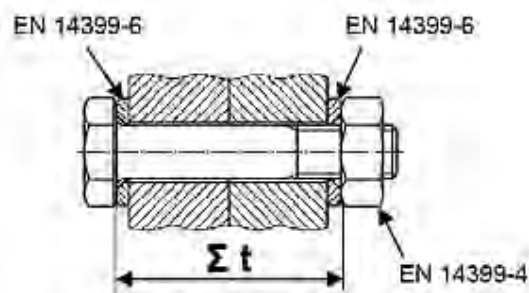

Table below is based on EN 14399-4:2015.

(EN 14399-4 and EN 14399-6 series replace the obsolete standard for HV fasteners DIN 6914, 6915, 6916.)

d	M12		M16		M20		M22		M24		M27		M30		M36	
L	Σ t _{min.} and Σ t _{max.}															
nom.	min.	max.	min.	max.	min.	max.	min.	max.	min.	max.	min.	max.	min.	max.	min.	max.
35	16	21														
40	21	26	17	22												
45	26	31	22	27	18	23										
50	31	36	27	32	23	28	22	27								
55	36	41	32	37	28	33	27	32								
60	41	46	37	42	33	38	32	37	29	34						
65	46	51	42	47	38	43	37	42	34	39						
70	51	56	47	52	43	48	42	47	39	44	36	41				
75	56	61	52	57	48	53	47	52	44	49	41	46	39	44		
80	61	66	57	62	53	58	52	57	49	54	46	51	44	49		
85	66	71	62	67	58	63	57	62	54	59	51	56	49	54	43	48
90	71	76	67	72	63	68	62	67	59	64	56	61	54	59	48	53
95	76	81	72	77	68	73	67	72	64	69	61	66	59	64	53	58
100			77	82	73	78	72	77	69	74	66	71	64	69	58	63
105			82	87	78	83	77	82	74	79	71	76	69	74	63	68
110			87	92	83	88	82	87	79	84	76	81	74	79	68	73
115			92	97	88	93	87	92	84	89	81	86	79	84	73	78
120			97	102	93	98	92	97	89	94	86	91	84	89	78	83
125			102	107	98	103	97	102	94	99	91	96	89	94	83	88
130			107	112	103	108	102	107	99	104	96	101	94	99	88	93
135					108	113	107	112	104	109	101	106	99	104	93	98
140					113	118	112	117	109	114	106	111	104	109	98	103
145					118	123	117	122	114	119	111	116	109	114	103	108
150					123	128	122	127	119	124	116	121	114	119	108	113
155					128	133	127	132	124	129	121	126	119	124	113	118
160							132	137	129	134	126	131	124	129	118	123
165							137	142	134	139	131	136	129	134	123	128
170									139	144	136	141	134	139	128	133
175									144	149	141	146	139	144	133	138
180									149	154	146	151	144	149	138	143
185									154	159	151	156	149	154	143	148
190									159	164	156	161	154	159	148	153
195									164	169	161	166	159	164	153	158
200											166	171	164	169	158	163

7.9 Locking

Correctly designed bolted joints, if correctly assembled, will not come loose. However, it is not always possible to design a joint so that it can optimally resist all causes of loosening.

Additional articles such as spring washers or serrated washers can compensate loss of preload or prevent loosening.

7.9.1 Loss of preload

Loss of preload occurs through:

- Loosening due to change of length resulting from relaxation (embedment) and creep.
- Spontaneous loosening as a result of relative movement between the contact faces of the joint from dynamic load or load components acting transversely to the axis of the bolt. The joint then appears to become free of friction due to the elimination of the self-locking effect.

7.9.2 Classification of locking systems

Because of the various causes of loss of preload, a distinction is made in:

Securing against embedding & creep: add elements to compensate for embedment and creep.

Securing against loss: add elements to ensure that the joint does not fall apart if the preload is lost.

Securing against rotating loose: add elements to prevent spontaneous loosening by blocking the internal loosening moment.

The overview below gives, in addition to the classification of the three main groups mentioned above, a sub classification dependent on the function of the locking system.

The mentioned examples are no guarantee for optimum effect, because many other parameters will have influence on the joint behaviour.

Cause of loss of preload	Classification of locking systems with respect to:		Examples	Reference ²⁾
	Objective	Function		
Loosening due to embedment / creep	Securing against embedding	Elastic elements clamped in the joint	Spring lock washers Disc springs Conical spring washers	DIN 127/128/137 DIN 2093 DIN 6796 / 6908
Loosening due to internal loosening moment and transverse displacement	Securing against loss	Locking elements	Castle nuts Locking plates Locking wire Products with a split pin hole	DIN 935 DIN 93/432/463 --- DIN 962
		Clamping elements	Locking nuts with plastic washer ¹⁾ All metal nuts with prevailing torque features Bolts with plastic patch ¹⁾ Self tapping screws	DIN 982/985/6926 DIN 980 --- Driloc Plastic DIN 7500
	Securing against rotating loose	Blocking elements	Toothed flange bolts Toothed flange nuts Locking washers Locking rings	E.g. Ripp. E.g. Ripp. --- E.g. Nord-Lock.
		Locking agent	Micro-encapsulated bolts ¹⁾ Anaerobic locking agent ¹⁾	E.g. Dri-loc 2015. E.g. Loctite.
¹⁾ Temperature dependent ²⁾ contains obsolete standards				

For more specific information on this subject a brochure is available on request.

In order to determine the effectiveness of a certain locking system, use is often made of a generally accepted test, the "Junker machine". This machine subjects the products to dynamic transverse forces and graphically records the loss of preload, depending on the number of alternating loads. Fabory has the ability to perform these tests.

7.9.3 Some practical suggestions for an optimum bolted joint

- Applying a high preload will limit critical displacements on the contact faces significantly. (Take into account the surface pressure of the clamped material).
- Controlled tightening.
- The greatest possible clamping length/diameter ratio, preferably $L_k / d > 5$.
- Prevent displacement of construction elements by using e.g. dowels and clamping bushes, etc.
- Increase the friction between contact faces by applying friction coatings or by roughening the surface by blasting.
- Make the contact faces smooth and parallel.
- When there is only static axial load and the assembly is correct, there is no need for locking mechanisms.
- The improper use of embedment and retention systems is more likely to make the reliability of the joint worse than better. Do not use them for dynamic transverse loads.

Note:

Locking systems must be used under both the bolt head and the nut. A locking washer assembled on a flat washer is useless.

8 Tables

8.1 SI units

In the following table a selection is given of those measuring units that are commonly used in fastening engineering.

Name	Symbol	Unit of	Replaces	Mutual conversion (rounded off)	
newton	N	force	kgf, kp	1N ≈ 0,1 kgf ≈ kp	1 kgf ≈ 1 kp ≈ 10N
joule	J	energy, work, heat	kcal, cal, kgf.m or kgm Btu (British thermal unit)	1J ≈ 1Nm ≈ 0,1 kgf.m 1J = 0,739 cal	1 kgf.m ≈ 10J ≈ 10Nm 1 cal = 4,187J
bar	bar	pressure of liquids and gases	at, kgf/cm ² of kg/cm ²	1 bar ≈ 1 at ≈ 1kgf/cm ² ≈ kg/cm ²	1 at = 1 bar
kelvin	K	temperature	partly the °C	Tk-273,15+T °C	T °C=Tk-273,15
metre	m	length	-		
second	s	time	-		
kilogram	kg	mass (quantity)	unit of weight	1 kg (mass) = 10 N (weight) on earth	
volt	V	electrical voltage	-		
ampère	A	electrical current	-		
watt	W	power (not only electrical)	pk, hp and kcal/h	1 kW = 1.359 pk 1 kW = 1.341 hp 1 kW = 959,845 kcal/h	1 pk = 0.7355 kW 1 hp = 0.7457 kW 1 kcal/h=0.001163 kW
Pascal	N/m ²	pressure, stress	m ⁻¹ ·kg·s ⁻²	1 Pa 1MPa	1 N/m ² 1 N/mm ²
Newton metre	Nm	torque	Kgf.m	1 Nm = 0,1 kgf.m	1kgf.m = 10 Nm

8.2 Conversion of tensile strength, Vickers, Brinell and Rockwell hardnesses

The table below is for information only and based on the standard ISO 18265:2013 for which the following considerations should be taken into account:

- The tensile strength according to ISO 6892-1, Vickers hardness according to ISO 6507-1, Brinell hardness according to ISO 6506-1, the Rockwell hardness according to ISO 6508-1 and applies for unalloyed and low alloyed steels. Considerable deviations can usually be expected with high alloy and/ or cold-worked steels.
- ISO 18265 provides several conversion tables, which are applicable to more specific types of steel and their heat treatment condition (e.g. quenched and tempered), or other metals, and which are to be consulted if a more accurate conversion is required.
- In principle, every conversion of hardness results in a certain degree of inaccuracy and may only be used when a measuring method cannot be carried out. Conversion cannot lead to rejection, unless a certain measurement method has been agreed at the time of ordering.
- A conversion between tensile strength and hardness will result in an even greater deviation and therefore can only be used as an indicative value. This can never replace the tensile strength determined by tensile testing.

Tensile strength N/mm ²	Vickers Hardness HV10	Brinell Hardness HB	Rockwell Hardness							
			HRB	HRF	HRC	HRA	HRD	HR15N	HR30N	HR45N
255	80	76,0								
285	90	85,5	48,0	82,6						
320	100	95,0	56,2	87,0						
350	110	105	62,3	90,5						
385	120	114	66,7	93,6						
415	130	124	71,2	96,4						
450	140	133	75,0	99,0						
480	150	143	78,7	101,4						
510	160	152	81,7	103,6						
545	170	162	85,0	105,5						
575	180	171	87,1	107,2						
610	190	181	89,5	108,7						
640	200	190	91,5	110,1						
675	210	199	93,5	111,3						
705	220	209	95,0	112,4						
740	230	219	96,7	113,4						
770	240	228	98,1	114,3	20,3	60,7	40,3	69,6	41,7	19,9
800	250	238	99,5	115,1	22,2	61,6	41,7	70,6	43,4	22,2
835	260	247	(101)		24,0	62,4	43,1	71,6	45,0	24,3
865	270	257	(102)		25,6	63,1	44,3	72,6	46,4	26,2
900	280	266	(104)		27,1	63,8	45,3	73,4	47,8	27,9
930	290	276	(105)		28,5	64,5	46,5	74,2	49,0	29,5
965	300	285			29,8	65,2	47,5	74,9	50,2	31,1
995	310	295			31,0	65,8	48,4	75,6	51,3	32,5
1030	320	304			32,2	66,4	49,4	76,2	52,3	33,9
1060	330	314			33,3	67,0	50,2	76,8	53,6	35,2
1095	340	323			34,4	67,6	51,1	77,4	54,4	36,5
1125	350	333			35,5	68,1	51,9	78,0	55,4	37,8
1155	360	342			36,6	68,7	52,8	78,6	56,4	39,1
1190	370	352			37,7	69,2	53,6	79,2	57,4	40,4
1220	380	361			38,8	69,8	54,4	79,8	58,4	41,7
1255	390	371			39,8	70,3	55,3	80,3	59,3	42,9
1290	400	380			40,8	70,8	56,0	80,8	60,2	44,1
1320	410	390			41,8	71,4	56,8	81,4	61,1	45,3
1350	420	399			42,7	71,8	57,5	81,8	61,9	46,4
1385	430	409			43,6	72,3	58,2	82,3	62,7	47,4
1420	440	418			44,5	72,8	58,8	82,8	63,5	48,4
1455	450	428			45,3	73,3	59,4	83,2	64,3	49,4
1485	460	437			46,1	73,6	60,1	83,6	64,9	50,4
1520	470	447			46,9	74,1	60,7	83,9	65,7	51,3
1555	480	(456)			47,7	74,5	61,3	84,3	66,4	52,2

8.3 Contact and chemical corrosion tables

8.3.1 Contact corrosion table

S = severe corrosion of the metal, shown in the row														
G = no or limited corrosion of the metal, shown in the row														
M = moderate corrosion (in an extremely damp atmosphere) of the metal, shown in the row.														
Metal	Surface *	Magnesium alloys	Zinc	Hot dip galvanized steel	Aluminium alloys	Cadmium layers	Mild steel	Low alloyed steel	Cast steel	Chromium steel	Lead	Tin	Copper	Stainless steel
Magnesium alloy	small		S	S	S	S	S	S	S	S	S	S	S	S
	large		M	M	M	M	S	S	S	S	S	S	S	S
Zinc	small	M		G	S	S	S	S	S	S	S	S	S	S
	large	G		G	G	G	G	G	G	G	G	G	G	G
Hot dip galvanized steel	small	M	G		M	M	S	S	S	S	S	S	S	S
	large	G	G		G	G	G	G	G	G	G	G	G	G
Aluminium alloy	small	M	G	G		G	S		S		S		S	S
	large	G	G	M		G	G	G	M	M	S	S	S	S
Cadmium layers	small	G	G	G	G		S	S	S	S	S	S	S	S
	large	M	G	M	G		G	G	G	G	G	G	G	G
Mild steel	small	G	G	G	G	G		M	S	S	S	S	S	S
	large	G	G	G	G	G		G	G	G	G	G	G	G
Low alloyed steel	small	G	G	G	G	G	G		G	S	S	S	S	S
	large	G	G	G	G	G	G		G	G	G	G	G	G
Cast steel	small	G	G	G	G	G	G	M		S	S	S	S	S
	large	G	G	G	G	G	G	G		G	G	G		
Chromium steel	small	G	G	G	G	G	G	G			M	M	S	S
	large	G	G	G	G	G	G	G			G	G		G
Lead	small	G	G	G	G	G	G	G	G	G		G	G	
	large	G	G	G	G	G	G	G	M	G		G		G
Tin	small	G	G	G	G	G	G	G		G		G		
	large	G	G	G	G	G	G	G	G	M		G		
Copper	small	G	G	G	G	G	G	G		M	M	S		
	large	G	G	G	G	G	G	G	G		G	M		G
Stainless steel	small	G	G	G	G	G		G	G		G	G		
	large	G	G	M	G	G	G	G	G	M	M	M	G	

* Relative relationship of this metal surface area with respect to the areas of the metals shown in the columns shown at the side.

8.3.2 Chemical corrosion table

CHEMICAL AGENT	Hot dip galvanized steel	Stainless steel		Brass	Aluminium Sopral	Plastic PA 6.6
		A2	A4			
Acetates		0-1	0	1-2	0	2-3
Acetone		0	0	0	0	0
Acetylene		0	0	3	0	
Alcohols	3	0	0	0	0-1	0
Alum		2	1	2	0	2
Ammonia gas		0	0	3	0	1
Ammonia	3	0	0	3	1	1
Benzene/Toluene/Xylene	0	0	0	0	0	0
Chlorine gas		1	1	1	3	3
Chlorine solution (in water)		1	1			
Hydrochloric acid		2-3	2-3	3	3	3
Chlorides						
– Sodium/ potassium chloride	0	1	1	2	2-3	0
– Ammonium- / zinc chloride		2	1	2	3	2
– Iron chloride		3	3	3	3	3
Citric acid		1	0	2	1	1
Phosphoric acid		2-3	0-1	3	2-3	2-3
Phosphates	0	1	0	2	2-3	1-2
Glycol		0	0	1	1	1
Glycerine	0	0	0	0-1	0	1
Resins	2-3	1	1	2-3	0-1	0
Hydrocarbons						
– Butane, Petrol, Tar	0	0	0	0-1	0	0
Chlorinated hydrocarbons						
– Trichloroethylene	0	0	0	0-1	0	0-1
– Tetrachloride	0	0	0	0-1	0	0-1
Carbonic acid		0	0	2	0	0
Sodium carbonate (soda)		0	0	1-2	0	0
Lacquers	0	0	0	1	0	1
Formic acid		1	0	2	3	3
Oil fuel/ vegetable	1	0	0	0	0	0
Palmitine / Stearin acid		1	0	2	0	0
Nitric acid		1	0-1	3	2	3
– Sodium/ Ammonia nitrate		0	0	2-3	0	2
Water						
– drinking water		0	0	2	0	0
– acid water	1-2			3	2	1
– salt water	0	1	1	2	1	0
Sulphur dioxide dry		0	0	0-1	1	1
Sulphur dioxide wet		1	0	3	2	2
Sulphuric acid	3	3	2-3	3	3	3
– Sodium/ Ammonia sulphate	1	0	0	1	0-1	0
– Nickel / Copper sulphate		0-1	0	2-3	2-3	2-3
Hydrogen Sulphide		0-1	0	2	0	1

0 = good resistance

1 = reasonable resistance

2 = poor resistance

3 = no resistance

The satisfaction of successfully completing your projects, that's what it's all about! Delivering flawless work requires know-how and the right, top quality materials. Because only the very best is good enough for experienced professionals. You expect quality because you deliver quality!

MaxxFast is a high quality no-nonsense brand in the hardware market. MaxxFast offers a wide range of fasteners, tools and industrial supplies. No matter what product you choose, quality is guaranteed. And it comes at a competitive price! MaxxFast gives you everything you need for the trouble-free completion of your project, so you can start with confidence on your next challenge.

Even though quality always comes first, a good price is just as important to achieve success. MaxxFast works closely with solid partners and aims for a streamlined production process with large-scale production to keep costs down. The bottom line is that this means a competitive retail price. That's good business for you and for your customers. Success guaranteed!

- Top quality
- A wide range of products
- Quality at a competitive price

**JOB DONE,
ON TO THE
NEXT**



Revolutionary woodscrews



High performance self drilling screws



A great range of quality anchors



Proven quality chemical anchors



Leading hose clamps



New cable ties



Screw bits the right fit



Holesaws the sharp edge



Quality assortments

www.maxxfast.com

MAXXFAST
PROFESSIONAL HARDWARE